

PLASMA MODEL

Aseltech plasma model container systems are designed for both steam and plasma sterilization (destroying the microorganisms by free radicals). The suitable accessories like paper filter for steam or polypropylene filter for plasma must be chosen by the user according to the need. The plasma model containers are equipped with carrying handles which have 90° mobility and its ergonomic design provides easy and secure carrying facilities. The gaskets inside the lid and filter retainer ensure perfect tightness while locking mechanism of this system provides excellent grip with its flexible structure.

Aseltech plasma model sterilization container systems are manufactured with different length, width and height and can be supplied with perforated bottom and lids. All models and sizes have specific baskets and accessories which can be viewed in following parts.

Box Types >

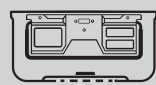

Box (Perforated)



Standard Heights



110 mm

135 mm

150 mm

200 mm

Dimensions



1/1 Full Size

3/4 Quarter Size

1/2 Half Size

Page 90 -91

Page 90 -91

Page 90 -91

Special Models



ENDO MODEL

MINI MODEL

DENTAL MODEL

1/2 DENTAL MODEL

Page 94 - 95

Page 92 - 93

PLASMA MODEL

1/1 Full Size

3/4 Quarter Size

1/2 Half Size

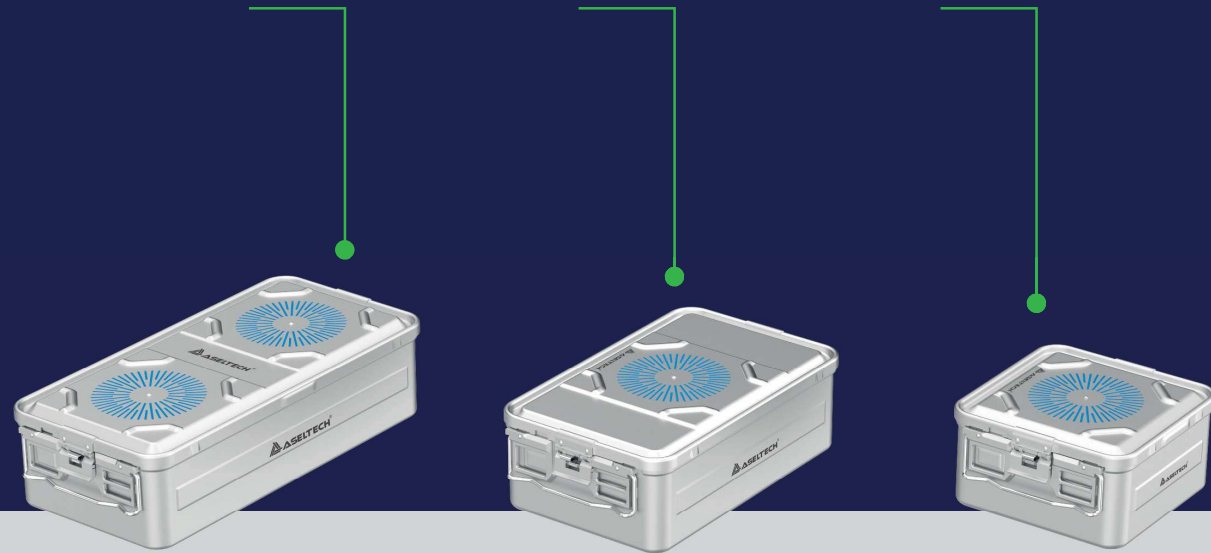

Box Types >

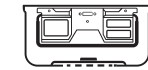

Box (Perforated)

Perforated Lid

1/1 FULL SIZE >



Code	Outside Dimension	Inside Dimension	Weight
CN-6100Z	600 x 272 x 96 mm	543 x 258 x 90 mm	2200 g
CN-6101Z	600 x 272 x 116 mm	543 x 258 x 99 mm	2360 g
CN-6102Z	600 x 272 x 138 mm	543 x 258 x 121 mm	2520 g

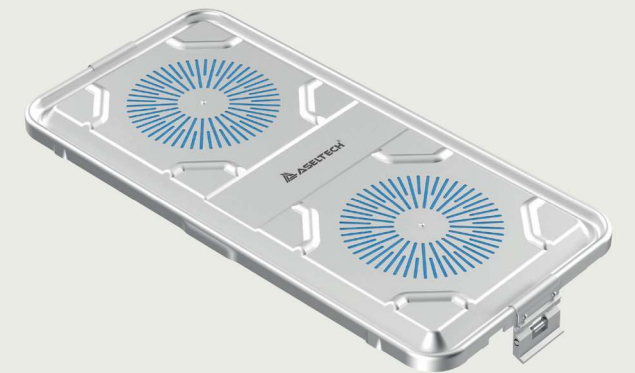

Color	Code
Grey	CN-6120Z
Dimension	Weight
585 x 285 mm	1370 g

3/4 QUARTER >



Code	Outside Dimension	Inside Dimension	Weight
CN-6300Z	475 x 272 x 96 mm	422 x 258 x 78 mm	1795 g
CN-6301Z	475 x 272 x 116 mm	422 x 258 x 99 mm	1885 g
CN-6302Z	475 x 272 x 138 mm	422 x 258 x 121 mm	2020 g
CN-6303Z	475 x 272 x 185 mm	422 x 258 x 168 mm	2475 g



Color	Code
Grey	CN-6340Z
Dimension	Weight
460 x 285 mm	1020 g

1/2 HALF SIZE >



Code	Outside Dimension	Inside Dimension	Weight
CN-6600Z	310 x 272 x 96 mm	253 x 258 x 78 mm	1400 g
CN-6601Z	310 x 272 x 116 mm	253 x 258 x 99 mm	1460 g
CN-6602Z	310 x 272 x 138 mm	253 x 258 x 121 mm	1570 g

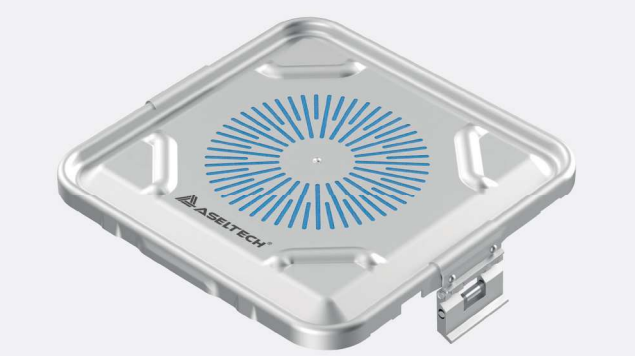

Color	Code
Grey	CN-6630Z
Dimension	Weight
295 x 280 mm	765 g

PLASMA MODEL

Mini Model Dental Model 1/2 Dental Model

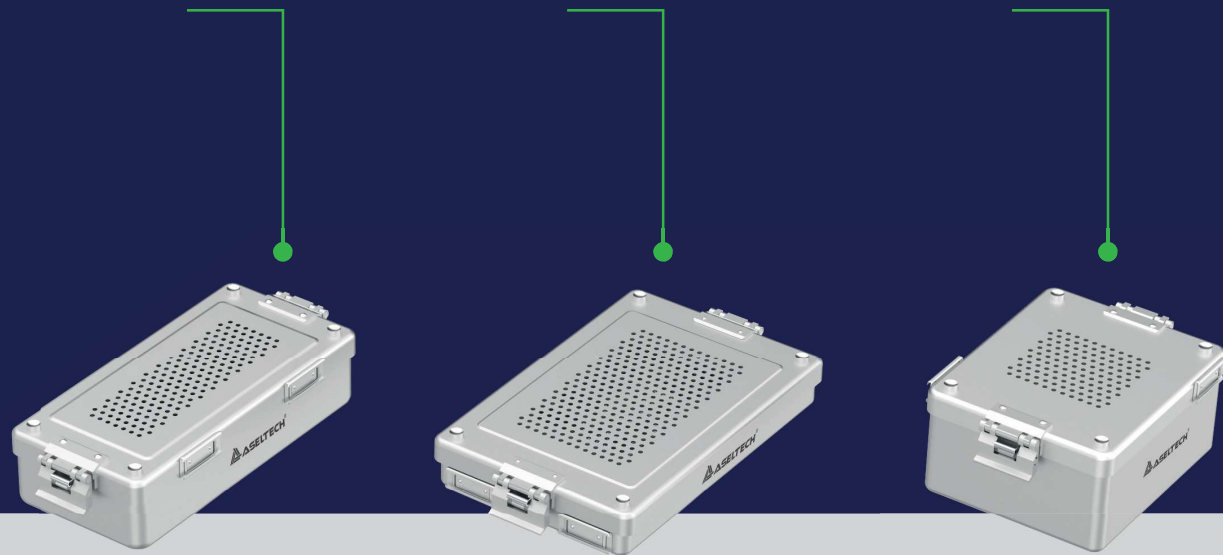

Box Types >



Box (Perforated)

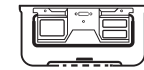

Box (Perforated)

Perforated Lid

DENTAL MODEL >

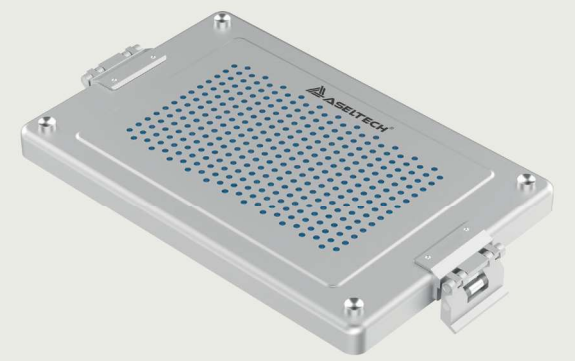

Code	Outside Dimension	Weight
CN-61860Z	323 x 186 x 43 mm	493 g
CN-61861Z	323 x 186 x 58 mm	535 g
CN-61862Z	323 x 186 x 122 mm	745 g

Color	Code
Grey	CN-61880Z
Dimension	Weight
325 x 192 mm	638 g

1/2 DENTAL MODEL >

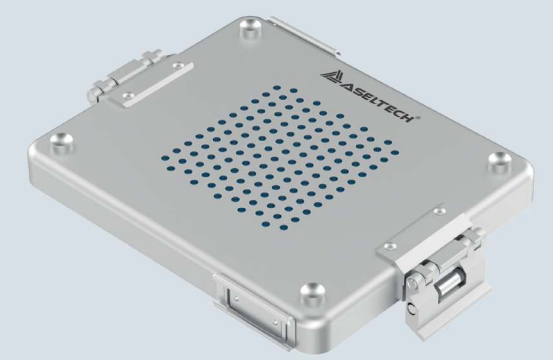

Code	Outside Dimension	Weight
CN-61560Z	227 x 162 x 57 mm	386 g
CN-61561Z	227 x 162 x 88 mm	463 g
CN-61562Z	227 x 162 x 122 mm	525 g

Color	Code
Grey	CN-61570Z
Dimension	Weight
220 x 170 mm	488 g

MINI MODEL >



Code	Outside Dimension	Weight
CN-61960Z	315 x 132 x 32 mm	338 g
CN-61961Z	315 x 132 x 63 mm	432 g
CN-61962Z	315 x 132 x 92 mm	523 g

Color	Code
Grey	CN-61970Z
Dimension	Weight
320 x 142 mm	513 g

PLASMA MODEL

Endo Model



Box Types >



Box (Perforated)

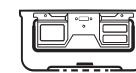
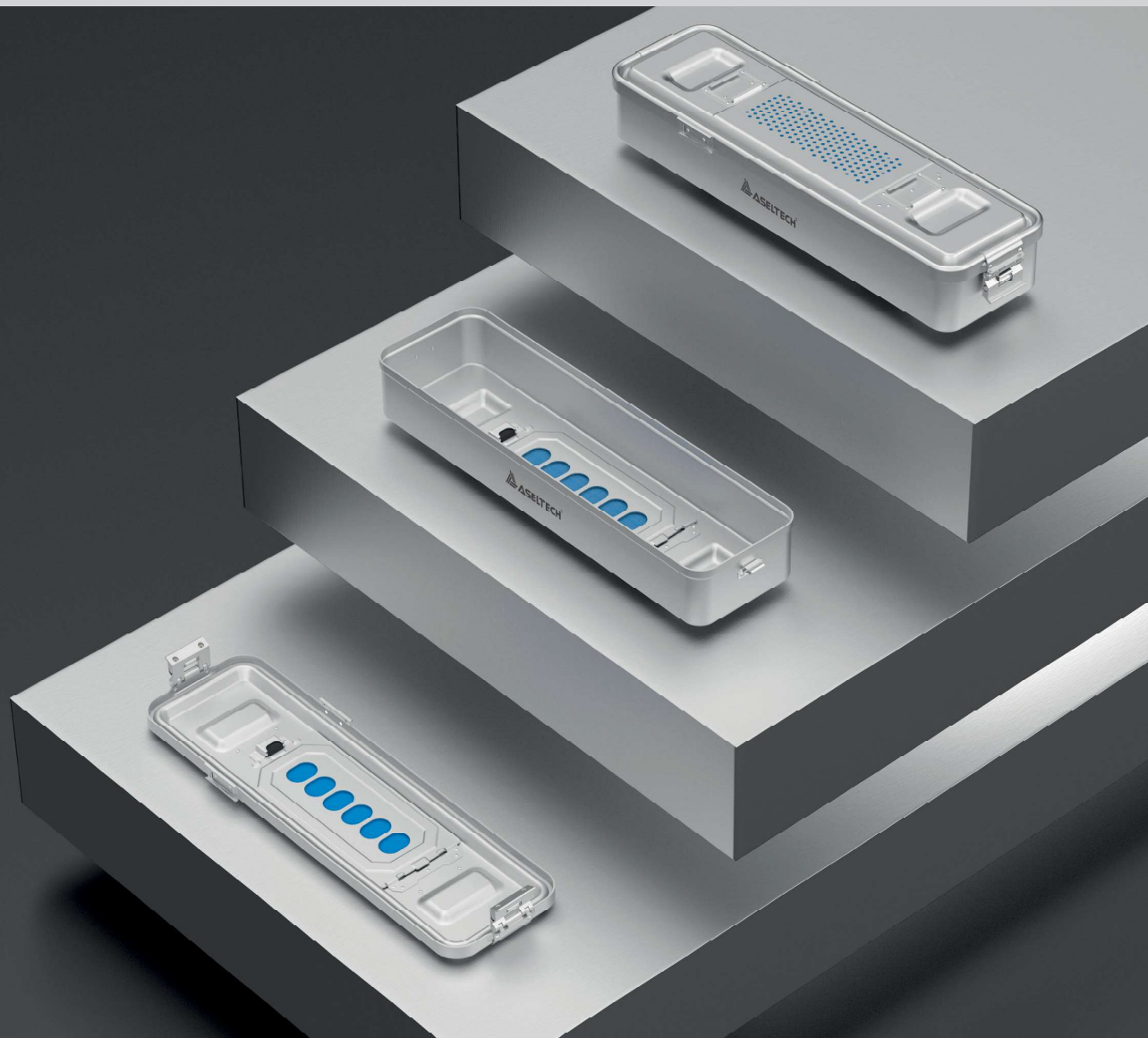

Box (Perforated)

Perforated Lid



Code	Outside Dimension	Weight
CN-61100Z	528 x 145 x 66 mm	676 g
CN-61101Z	528 x 145 x 88 mm	786 g

Color	Code
Grey	CN-61000Z
Dimension	Weight
532 x 160 mm	795 g

DENTAL, MINI & SPECIAL MODELS

As an addition to all standard sizes, Aseltech also provides smaller containers like Mini, Large Dental, Dental, 1/2 Dental, Flat, Endo, Implant, Scopy and Mini Implant Model for preparation of many surgeries like dental or micro surgeries.

Box Types

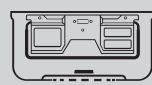

Box (Perforated)

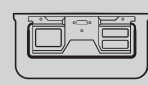

Box (Non Perforated)



MODELS



> **LARGE DENTAL MODEL**
Page 98 -99



> **DENTAL MODEL**
Page 100 -101



> **1/2 DENTAL MODEL**
Page 102 -103



> **ENDO MODEL**
Page 104 -105



> **MINI MODEL**
Page 106 -107



> **FLAT MODEL**
Page 108 -109



> **IMPLANT MODEL**
Page 110

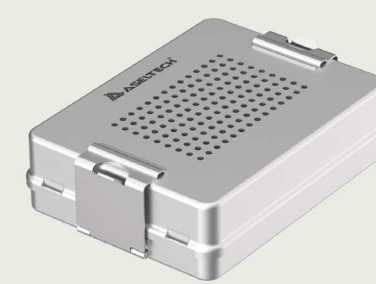

> **MINI IMPLANT MODEL**
Page 111



> **SCOPY MODEL**
Page 112 -113

LARGE DENTAL



Box Types

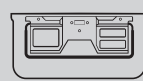

Box (Non Perforated)

8
Different Colours

Standard Heights



115 mm



130 mm



150 mm

Box (Non Perforated)

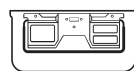

Code	Outside Dimension	Inside Dimension	Weight
CN-61665	380 x 244 x 100 mm	330 x 234 x 94 mm	1350 g
CN-61666	380 x 244 x 116 mm	330 x 234 x 112 mm	1465 g
CN-61667	380 x 244 x 138 mm	330 x 234 x 130 mm	1600 g

Perforated Lids

Dimension	Weight
365 x 255 mm	835 g



Color	Code
Grey	CN-61680
Yellow	CN-61681
Green	CN-61682
Blue	CN-61683
Red	CN-61684
Black	CN-61685
Purple	CN-61686
Bronze	CN-61687

Bio Barrier Lids

Dimension	Weight
365 x 255 mm	1020 g



Color	Code
Grey	CN-71680
Yellow	CN-71681
Green	CN-71682
Blue	CN-71683
Red	CN-71684
Black	CN-71685
Purple	CN-71686
Bronze	CN-71687

DENTAL MODEL

Standard Heights

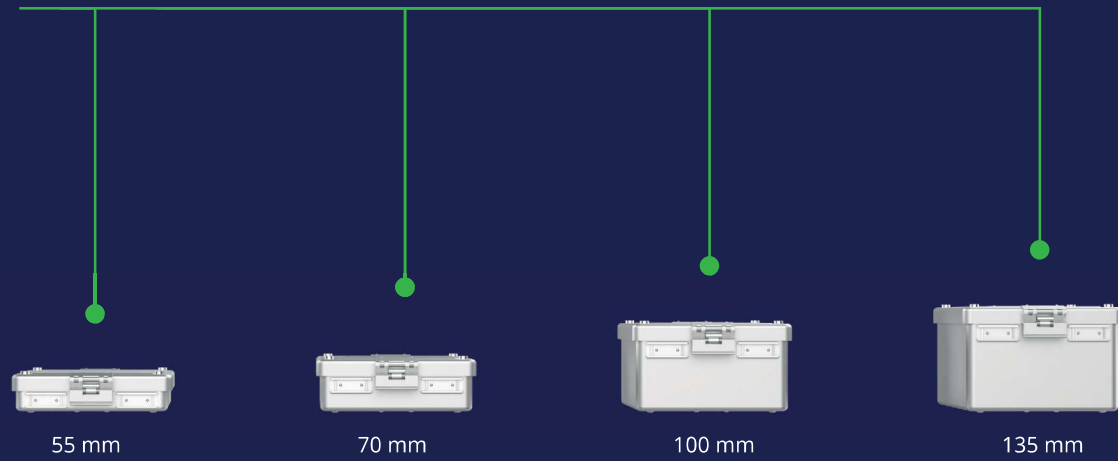

Box Types >



8
Different Colours

Box (Non Perforated)

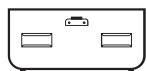

Code	Outside Dimension	Inside Dimension	Weight
CN-61865	320 x 186 x 43 mm	281 x 184 x 38 mm	360 g
CN-61866	320 x 186 x 59 mm	281 x 184 x 54 mm	425 g
CN-61868	320 x 186 x 102 mm	281 x 184 x 98 mm	560 g
CN-61867	320 x 186 x 122 mm	281 x 184 x 118 mm	634 g

Box (Perforated)

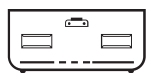

Code	Outside Dimension	Inside Dimension	Weight
CN-61860	320 x 186 x 43 mm	281 x 184 x 28 mm	500 g
CN-61861	320 x 186 x 58 mm	281 x 184 x 46 mm	550 g
CN-61863	320 x 186 x 102 mm	281 x 184 x 93 mm	695 g
CN-61862	320 x 186 x 122 mm	281 x 184 x 110 mm	755 g

Box (With Barrier)

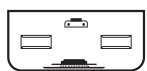

Code	Outside Dimension	Inside Dimension	Weight
CN-71861	320 x 186 x 69 mm	281 x 184 x 35 mm	765 g
CN-71863	320 x 186 x 112 mm	281 x 184 x 79 mm	910 g
CN-71862	320 x 186 x 132 mm	281 x 184 x 99 mm	984 g

Perforated Lids

Dimension	Weight
325 x 192 mm	638 g



Color	Code
Grey	CN-61880
Yellow	CN-61881
Green	CN-61882
Blue	CN-61883
Red	CN-61884
Black	CN-61885
Purple	CN-61886
Bronze	CN-61887

Removal Lids

Dimension	Weight
325 x 192 mm	500 g



Color	Code
Grey	CN-61870
Yellow	CN-61871
Green	CN-61872
Blue	CN-61873
Red	CN-61874
Black	CN-61875
Purple	CN-61876
Bronze	CN-61877

Barrier Lids

Dimension	Weight
325 x 192 mm	862 g



Color	Code
Grey	CN-71880
Yellow	CN-71881
Green	CN-71882
Blue	CN-71883
Red	CN-71884
Black	CN-71885
Purple	CN-71886
Bronze	CN-71887

1/2 DENTAL MODEL

Standard Height Dimensions



Box Types >



Box (Non Perforated)

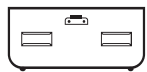

Code	Outside Dimension	Inside Dimension	Weight
CN-61565	227 x 162 x 57 mm	190 x 158 x 48 mm	245 g
CN-61566	227 x 162 x 88 mm	190 x 158 x 88 mm	335 g
CN-61567	227 x 162 x 122 mm	190 x 158 x 118 mm	410 g

Box Perforated

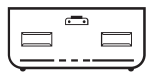

Code	Outside Dimension	Inside Dimension	Weight
CN-61560	227 x 162 x 57 mm	190 x 158 x 40 mm	385 g
CN-61561	227 x 162 x 88 mm	190 x 158 x 80 mm	440 g
CN-61562	227 x 162 x 122 mm	190 x 158 x 110 mm	545 g

Perforated Lids

Dimension	Weight
232 x 174 mm	495 g



Color	Code
Grey	CN-61570
Yellow	CN-61571
Green	CN-61572
Blue	CN-61573
Red	CN-61574
Black	CN-61575
Purple	CN-61576
Bronze	CN-61577

Removal Lids

Dimension	Weight
232 x 174 mm	360 g



Color	Code
Grey	CN-61580
Yellow	CN-61581
Green	CN-61582
Blue	CN-61583
Red	CN-61584
Black	CN-61585
Purple	CN-61586
Bronze	CN-61587

ENDO MODEL



Box Types >



Box (Perforated)



Box (Non Perforated)



8
Different Colours

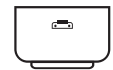

Box (Non Perforated)

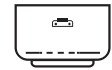

Box (Perforated)



Code	Outside Dimension	Weight
CN-61105	528 x 145 x 66 mm	675 g
CN-61106	528 x 145 x 88 mm	805 g

Code	Outside Dimension	Weight
CN-61100	528 x 145 x 66 mm	690 g
CN-61101	528 x 145 x 88 mm	885 g



Perforated Lids

Dimension	Weight
532 x 160 mm	775 g



Color	Code
Grey	CN-61000
Yellow	CN-61001
Green	CN-61002
Blue	CN-61003
Red	CN-61004
Black	CN-61005
Purple	CN-61006
Bronze	CN-61007

MINI MODEL

Standard Heights

2 dimension Bio Barrier Options

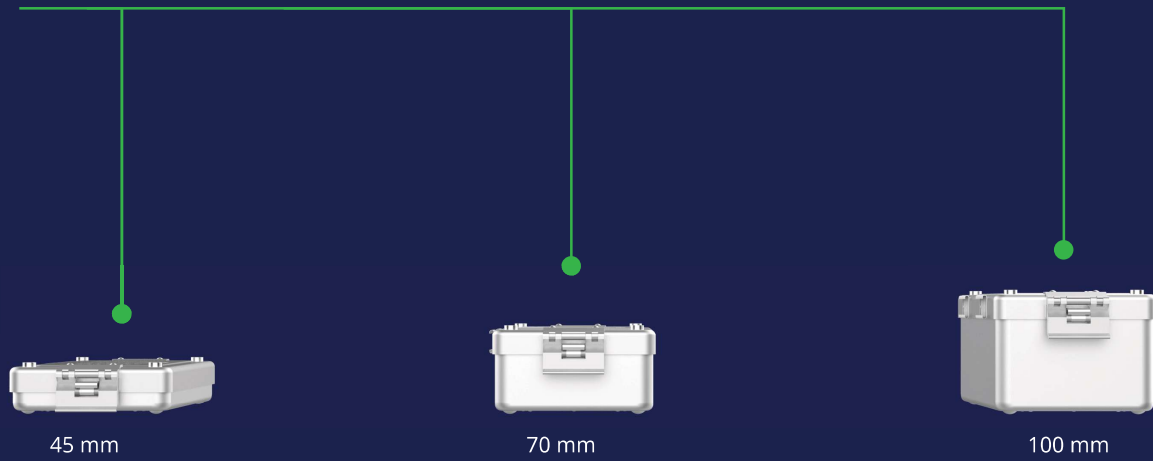

Box Types >



Box (Non Perforated)

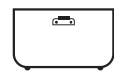

Code	Outside Dimension	Inside Dimension	Weight
CN-61965	315 x 132 x 32 mm	273 x 128 x 30 mm	232 g
CN-61966	315 x 132 x 63 mm	273 x 128 x 58 mm	315 g
CN-61967	315 x 132 x 92 mm	273 x 128 x 90 mm	419 g

Box Perforated



Code	Outside Dimension	Inside Dimension	Weight
CN-61960	315 x 132 x 32 mm	273 x 128 x 18 mm	350 g
CN-61961	315 x 132 x 63 mm	273 x 128 x 48 mm	440 g
CN-61962	315 x 132 x 92 mm	273 x 128 x 78 mm	523 g

Box (With Barrier)



Code	Outside Dimension	Inside Dimension	Weight
CN-71961	315 x 132 x 73 mm	273 x 128 x 39 mm	665 g
CN-71962	315 x 132 x 102 mm	273 x 128 x 71 mm	769 g

Perforated Lids

Dimension	Weight
315 x 140 mm	510 g



Color	Code
Grey	CN-61970
Yellow	CN-61971
Green	CN-61972
Blue	CN-61973
Red	CN-61974
Black	CN-61975
Purple	CN-61976
Bronze	CN-61977

Removal Lids

Dimension	Weight
315 x 140 mm	380 g



Color	Code
Grey	CN-61980
Yellow	CN-61981
Green	CN-61982
Blue	CN-61983
Red	CN-61984
Black	CN-61985
Purple	CN-61986
Bronze	CN-61987

Barrier Lids

Dimension	Weight
315 x 142 mm	680 g



Color	Code
Grey	CN-71970
Yellow	CN-71971
Green	CN-71972
Blue	CN-71973
Red	CN-71974
Black	CN-71975
Purple	CN-71976
Bronze	CN-71977

FLAT MODEL

Standard Heights 2 dimension Bio Barrier Options

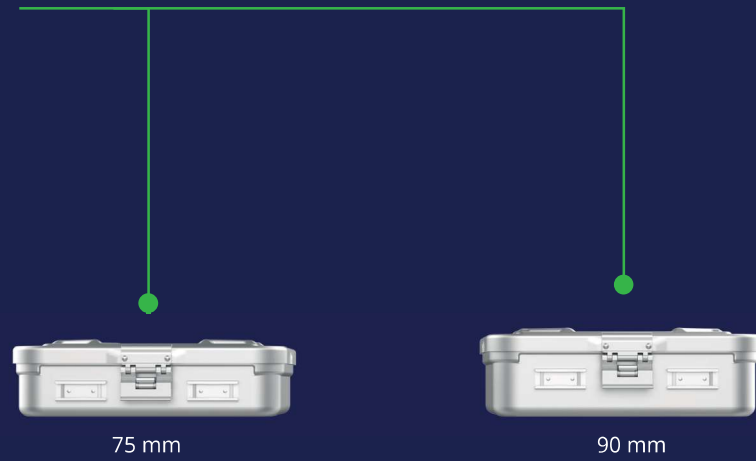

Box Types >



Box (Non Perforated)

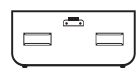

Code	Outside Dimension	Inside Dimension	Weight
CN-61775	295 x 270 x 60 mm	258 x 260 x 56 mm	650 g
CN-61776	295 x 270 x 72 mm	258 x 260 x 66 mm	720 g

Box Perforated

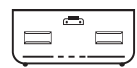

Code	Outside Dimension	Inside Dimension	Weight
CN-61770	295 x 270 x 60 mm	258 x 260 x 40 mm	740 g
CN-61771	295 x 270 x 72 mm	258 x 260 x 52 mm	825 g

Box (With Barrier)

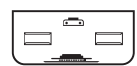

Code	Outside Dimension	Inside Dimension	Weight
CN-71770	295 x 270 x 72 mm	258 x 260 x 37 mm	964 g
CN-71771	295 x 270 x 84 mm	258 x 260 x 47 mm	987 g

Perforated Lids

Dimension	Weight
295 x 280 mm	730 g



Color	Code
Grey	CN-61780
Yellow	CN-61781
Green	CN-61782
Blue	CN-61783
Red	CN-61784
Black	CN-61785
Purple	CN-61786
Bronze	CN-61787

Removal Lids

Dimension	Weight
295 x 280 mm	610 g



Color	Code
Grey	CN-61790
Yellow	CN-61791
Green	CN-61792
Blue	CN-61793
Red	CN-61794
Black	CN-61795
Purple	CN-61796
Bronze	CN-61797

Bio Barrier Lids

Dimension	Weight
295 x 280 mm	955 g



Color	Code
Grey	CN-71780
Yellow	CN-71781
Green	CN-71782
Blue	CN-71783
Red	CN-71784
Black	CN-71785
Purple	CN-71786
Bronze	CN-71787

Safety Lids

Dimension	Weight
317 x 285 mm	610 g



Color	Code
Grey	CN-61418
Yellow	CN-61419
Green	CN-61420
Blue	CN-61421
Red	CN-61422
Black	CN-61423
Purple	CN-61424
Bronze	CN-61425

For Bio Barrier Safety Lids

Dimension	Weight
317 x 285 mm	700 g



Color	Code
Grey	CN-71418
Yellow	CN-71419
Green	CN-71420
Blue	CN-71421
Red	CN-71422
Black	CN-71423
Purple	CN-71424
Bronze	CN-71425

IMPLANT MODEL

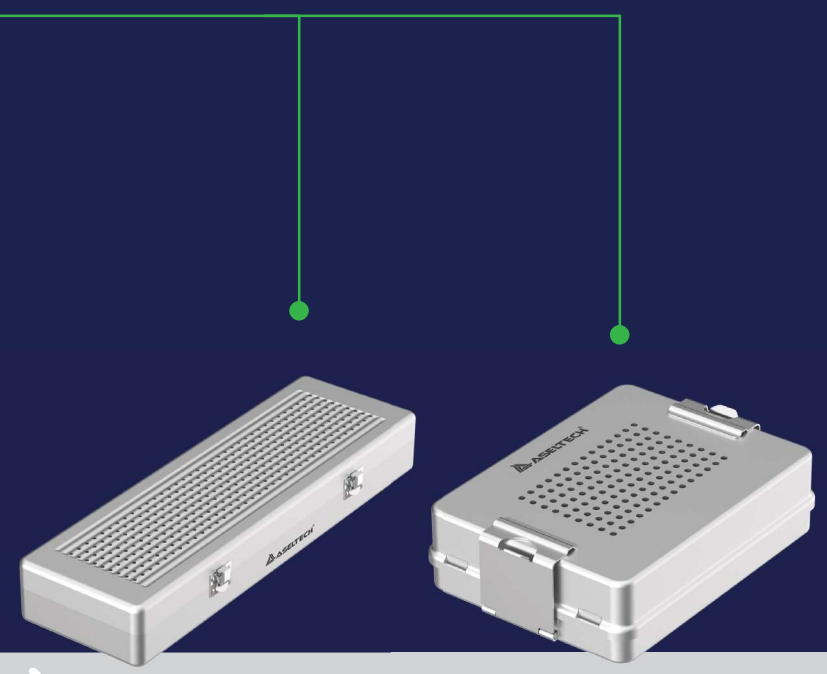

Box & Lids Types >



All container measurements cover the outer size of the lids.

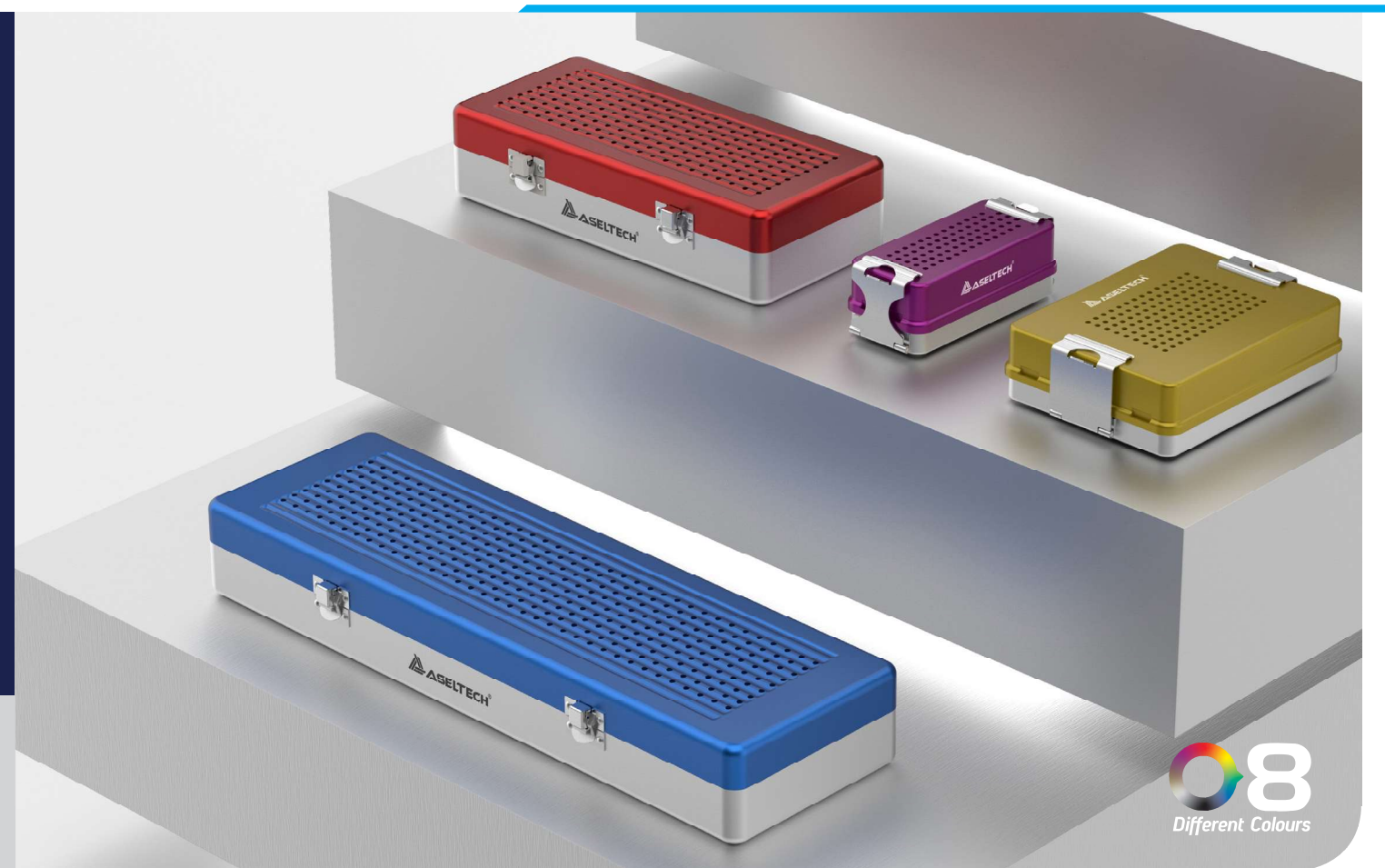

Implant Models

Dimension 300 x 150 x 75 mm



Dimension 500 x 170 x 75 mm

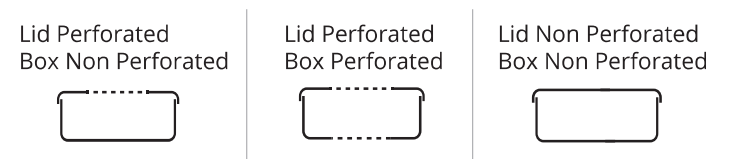
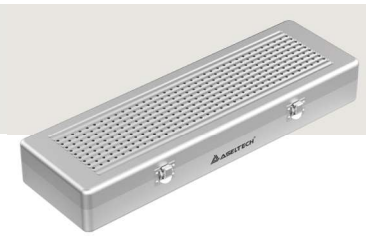

Color	Code	Code	Code
Black	CN-5010	CN-5022	CN-5034
Red	CN-5011	CN-5023	CN-5035
Blue	CN-5012	CN-5024	CN-5036
Green	CN-5013	CN-5025	CN-5037
Yellow	CN-5014	CN-5026	CN-5038
Grey	CN-5015	CN-5027	CN-5039
Purple	CN-5048	CN-5052	CN-5056
Bronze	CN-5049	CN-5053	CN-5057

Color	Code	Code	Code
Black	CN-5016	CN-5028	CN-5040
Red	CN-5017	CN-5029	CN-5041
Blue	CN-5018	CN-5030	CN-5042
Green	CN-5019	CN-5031	CN-5043
Yellow	CN-5020	CN-5032	CN-5044
Grey	CN-5021	CN-5033	CN-5045
Purple	CN-5050	CN-5054	CN-5058
Bronze	CN-5051	CN-5055	CN-5059

Mini Implant Models

Dimension 160 x 72 x 57 mm



Dimension 200 x 147 x 57 mm

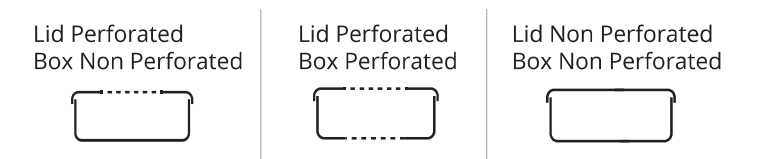

Color	Code	Code	Code
Black	CN-5200	CN-5212	CN-5224
Red	CN-5201	CN-5213	CN-5225
Blue	CN-5202	CN-5214	CN-5226
Green	CN-5203	CN-5215	CN-5227
Yellow	CN-5204	CN-5216	CN-5228
Grey	CN-5205	CN-5217	CN-5229
Purple	CN-5236	CN-5240	CN-5244
Bronze	CN-5237	CN-5241	CN-5245

Color	Code	Code	Code
Black	CN-5206	CN-5218	CN-5230
Red	CN-5207	CN-5219	CN-5231
Blue	CN-5208	CN-5220	CN-5232
Green	CN-5209	CN-5221	CN-5233
Yellow	CN-5210	CN-5222	CN-5234
Grey	CN-5211	CN-5223	CN-5235
Purple	CN-5238	CN-5242	CN-5246
Bronze	CN-5239	CN-5243	CN-5247

SCOPY MODEL

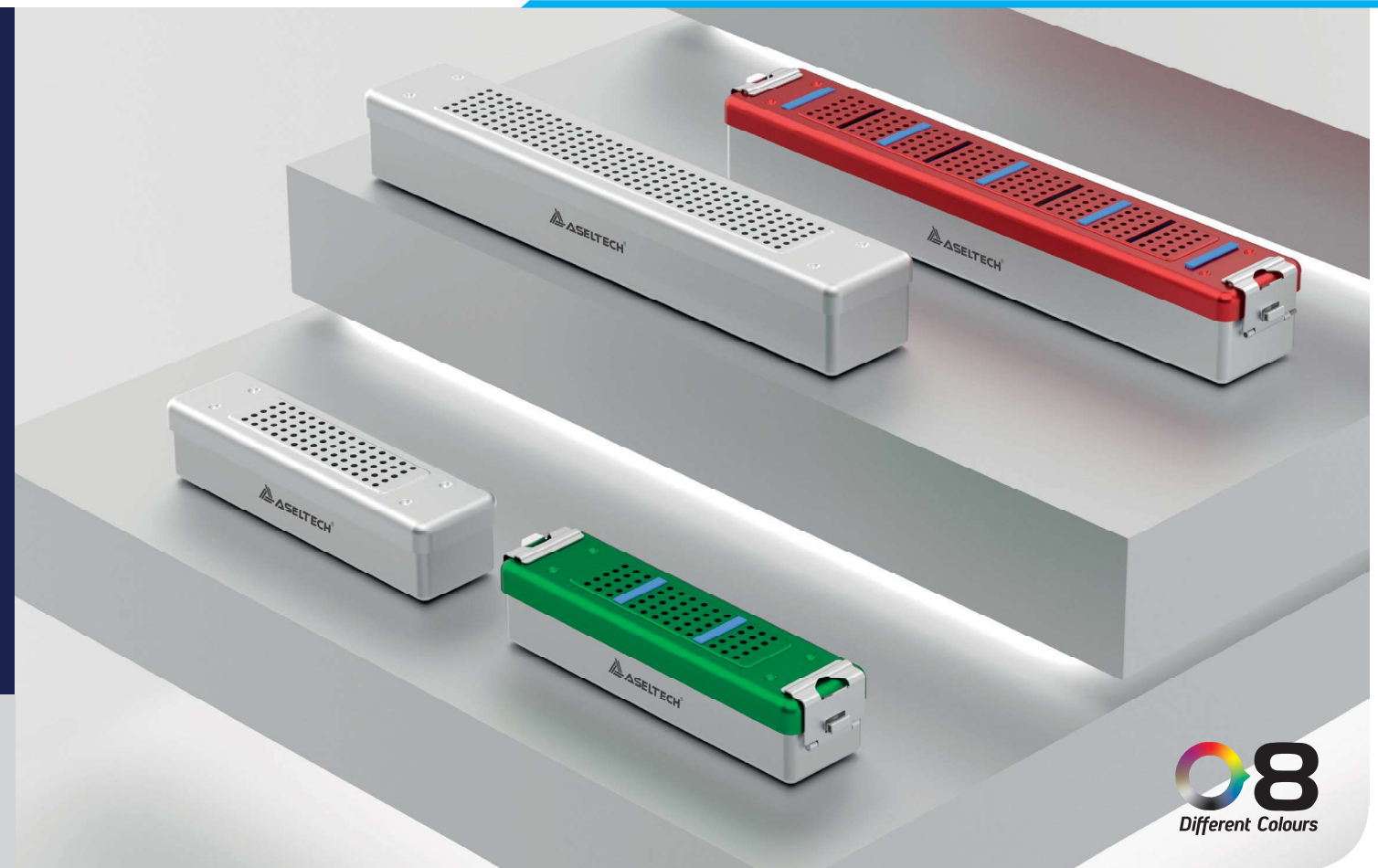
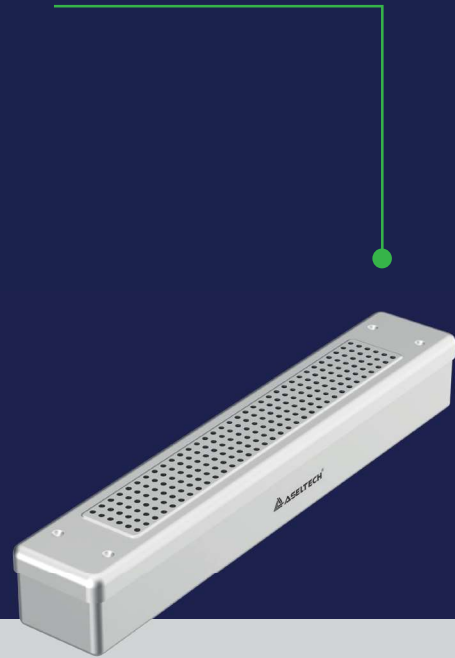

Box & Lids Types >



Lid Perforated
Box Non Perforated



Lid Perforated
Box Perforated

All container measurements cover the outer size of the lids.



Scopy Models

Dimension 260 x 70 x 60 mm



Lid Perforated
Box Non Perforated

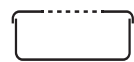

Lid Perforated
Box Perforated



Color	Code	Code
Black	CN-5060	CN-5072
Red	CN-5061	CN-5073
Blue	CN-5062	CN-5074
Green	CN-5063	CN-5075
Yellow	CN-5064	CN-5076
Grey	CN-5065	CN-5077
Purple	CN-5084	CN-5088
Bronze	CN-5085	CN-5089



Dimension 455 x 80 x 70 mm



Color	Code	Code
Black	CN-5066	CN-5078
Red	CN-5067	CN-5079
Blue	CN-5068	CN-5080
Green	CN-5069	CN-5081
Yellow	CN-5070	CN-5082
Grey	CN-5071	CN-5083
Purple	CN-5086	CN-5090
Bronze	CN-5087	CN-5091



Scopy Models

with silicone holders

Dimension 275 x 70 x 65 mm



Lid Perforated
Box Non Perforated

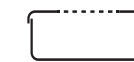

Lid Perforated
Box Perforated

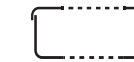

Color	Code	Code
Black	CN-5100	CN-5115
Red	CN-5101	CN-5116
Blue	CN-5102	CN-5117
Green	CN-5103	CN-5118
Yellow	CN-5104	CN-5119
Grey	CN-5105	CN-5120
Purple	CN-5127	CN-5131
Bronze	CN-5128	CN-5132



Dimension 470 x 82 x 74 mm



Color	Code	Code
Black	CN-5106	CN-5121
Red	CN-5107	CN-5122
Blue	CN-5108	CN-5123
Green	CN-5109	CN-5124
Yellow	CN-5110	CN-5125
Grey	CN-5111	CN-5126
Purple	CN-5129	CN-5133
Bronze	CN-5130	CN-5134



BASKETS

The baskets are the main supplementary components of container systems and they are necessary for a full set container. ASELTECH has focused on 3 main model in basket production. Two of these models are wire basket and perforated sheet basket. The third model is a combination of these two models with perforated metal plates on sides and with wire mesh on bottom. ASELTECH has the model and sizes of baskets in its standard production appealing to all container model and sizes. Also, it ensures basket production in demanded sizes besides standard production.

The standard diameter of the wire used in basket production is 1 mm and mesh distance is 4 mm. But this distance can also be arranged according to the special demands. Besides, ASELTECH manufactures fine mesh baskets for small instruments, laundry baskets and endoscopic baskets. These baskets can also be produced in demanded sizes and mesh distances.

Please contact our company for any special production basket.

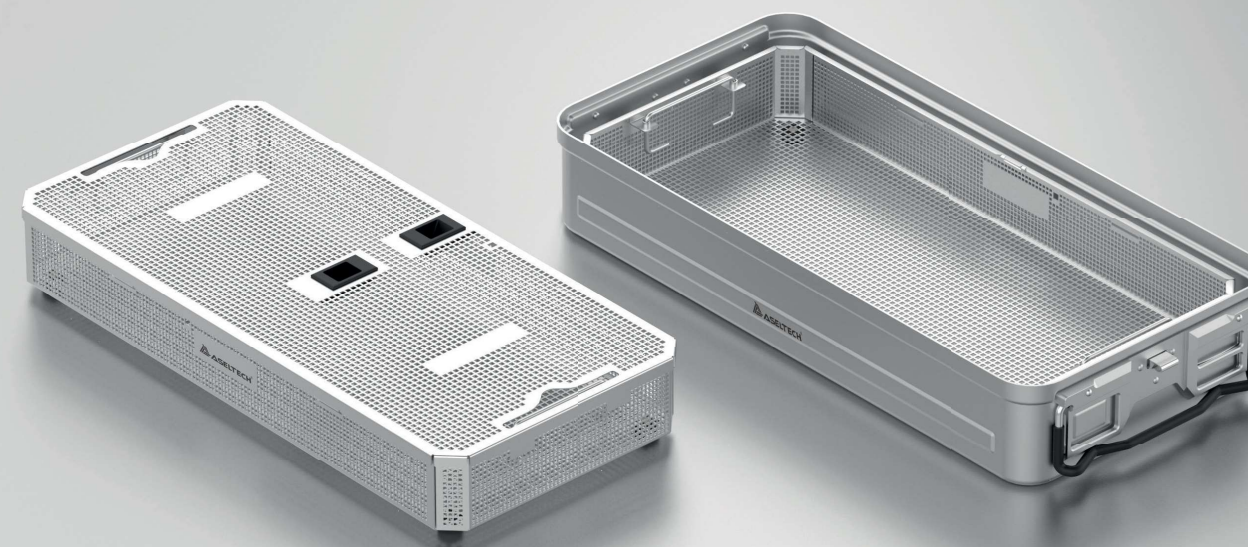
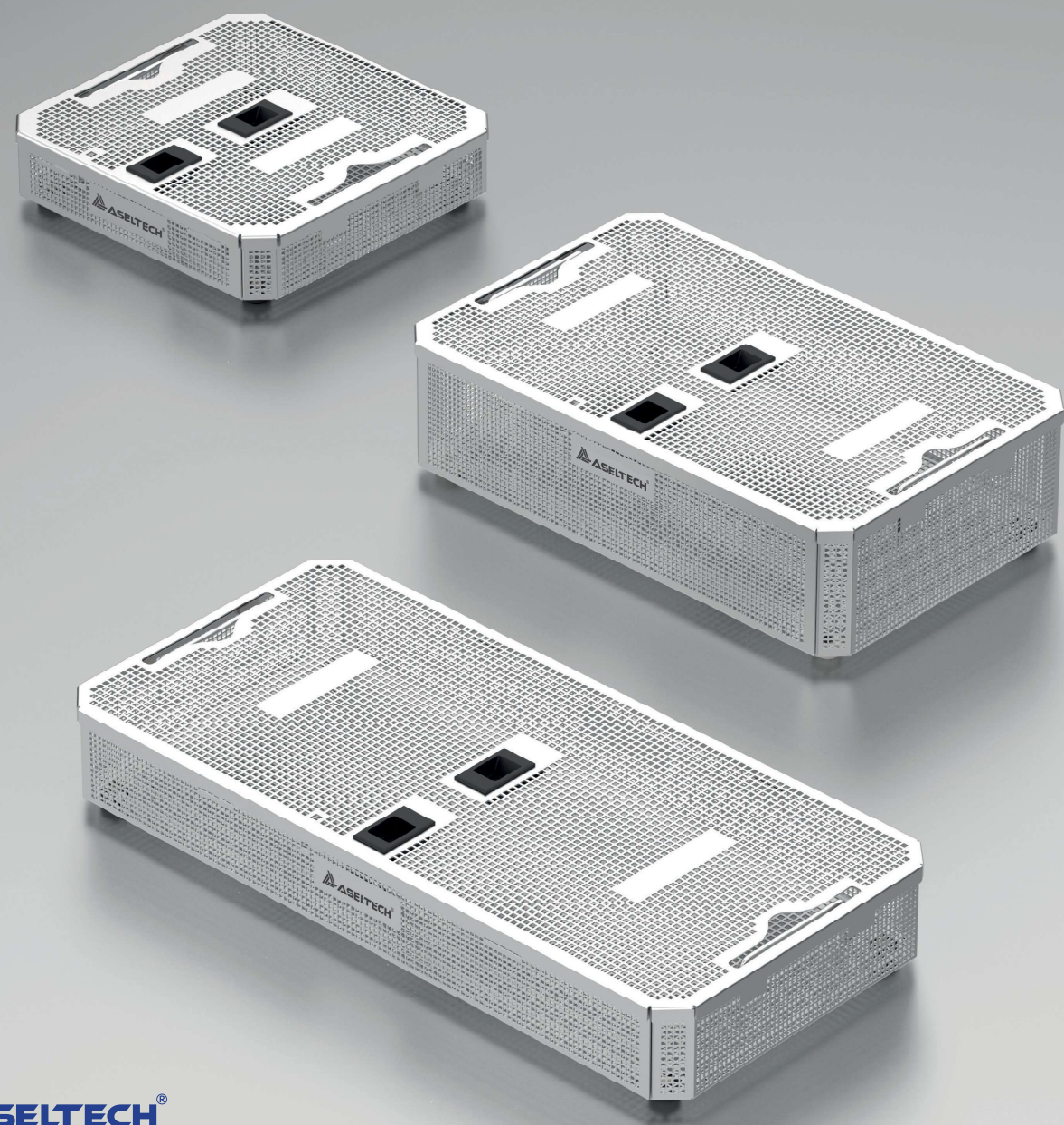

➤ For 1/1 Models

Box
Stand Height: 10 mm



Code	Outside Dimension
CN-3740	540 x 253 x 40 mm
CN-3741	540 x 253 x 60 mm
CN-3742	540 x 253 x 80 mm
CN-3743	540 x 253 x 110 mm

Code	Outside Dimension
CN-3744	485 x 253 x 40 mm
CN-3745	485 x 253 x 60 mm
CN-3746	485 x 253 x 80 mm
CN-3747	485 x 253 x 110 mm

➤ For 1/1 Models

Lid



Code	Dimension
CN-3760	542 x 256 x 4 mm

Code	Dimension
CN-3761	487 x 256 x 4 mm



> For 3/4 Models



Box
Stand Height: 10 mm

Code	Outside Dimension
CN-3748	405 x 253 x 40 mm
CN-3749	405 x 253 x 60 mm
CN-3750	405 x 253 x 80 mm
CN-3751	405 x 253 x 110 mm

> For 1/2 Models

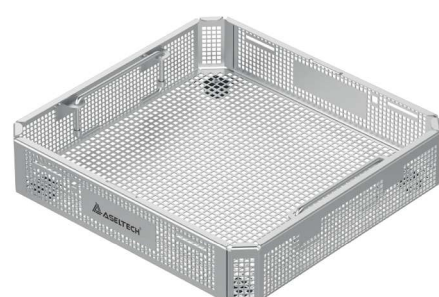

Box
Stand Height: 10 mm

Code	Outside Dimension
CN-3752	244 x 253 x 40 mm
CN-3753	244 x 253 x 60 mm
CN-3754	244 x 253 x 80 mm
CN-3755	244 x 253 x 110 mm

> For Extra Long Models

Box
Stand Height: 10 mm

Code	Outside Dimension
CN-3711	665 x 253 x 40 mm
CN-3712	665 x 253 x 60 mm
CN-3713	665 x 253 x 80 mm
CN-3714	665 x 253 x 110 mm

> For Extra Long Models

Lid

Code	Outside Dimension
CN-3710	667 x 256 x 4 mm

> For 3/4 Models



Lid

Code	Outside Dimension
CN-3762	407 x 256 x 4 mm

> For 1/2 Models

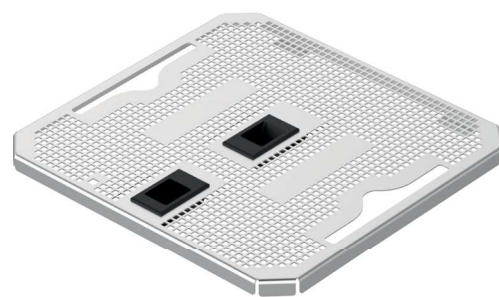

Lid

Code	Outside Dimension
CN-3763	247 x 256 x 4 mm

> For Extra Large Models

Box
Stand Height: 10 mm

Code	Outside Dimension
CN-3705	533 x 340 x 40 mm
CN-3706	533 x 340 x 60 mm
CN-3707	533 x 340 x 80 mm
CN-3708	533 x 340 x 110 mm

> For Extra Large Models

Lid

Code	Outside Dimension
CN-3709	539 x 346 x 4 mm