

GEBURTSHILFE

OBSTETRICS

ACCOUCHEMENTS

OBSTRETRICIA

OSTETRICIA

Geburtszangen
Obstetrical (Midwifery) Forceps
Forceps
Fórceps obstétricos
Forcipi

GEBURTSHILFE

OBSTETRICS

ACCOUCHEMENTS

OBSTRETRICIA

OSTETRICIA



cm WRIGLEY
28,0 72-1001-28



cm SIMPSON
23,0 72-1002-23
30,0 72-1002-30



cm SIMPSON-BRAUN
33,0 72-1005-33
36,0 72-1005-36



cm De LEE
30,0 72-1007-30



cm De LEE
36,0 72-1008-36
39,0 72-1008-39



cm KIELLAND
41,0 72-1100-41



cm ELLIOT
32,0 72-1105-32
38,0 72-1105-38



cm NAEGELE
36,0 72-1109-36
40,0 72-1109-40



cm LUIKART
40,0 72-1205-40



cm KIELLAND-LUIKART
40,0 72-1207-40



cm SIMPSON-LUIKART
36,0 72-1305-36



cm McLEAN-TUCKER-LUIKART
40,0 72-1309-40

Geburtszangen
Obstetrical (Midwifery) Forceps
Forceps
Fórceps obstétricos
Forcipi

GEBURTSHILFE

OBSTETRICS

ACCOUCHEMENTS

OBSTRETRICIA

OSTETRICIA



cm McLEAN-TUCKER
39,0 72-1401-39

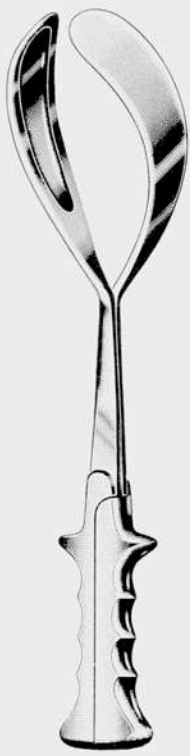

cm McLEAN-LUIKART
39,0 72-1403-39



cm McLEAN
36,0 72-1405-36



cm BARTON
36,0 72-1407-36

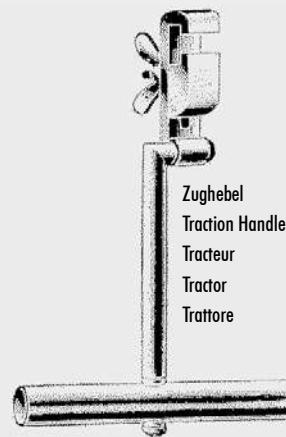

Zughebel
Traction Handle
Tracteur
Tractor
Trattore

cm BARTON
17,0 72-1408-17

Geburtszangen
Obstetrical (Midwifery) Forceps
Forceps
Fórceps obstétricos
Forcipi

GEBURTSHILFE

OBSTETRICS

ACCOUchemENTS

OBSTRETRICIA

OSTETRICIA



cm BOERMA
29,0 72-1501-29



cm PASOT
34,0 72-1503-29

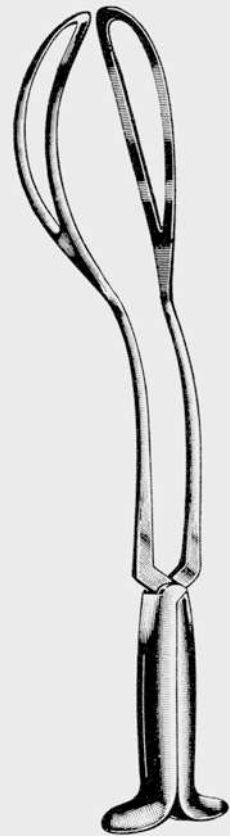

cm PIPER
44,0 72-1505-44



cm THIERRY
39,0 72-1506-39
Paar - pair - la paire -
pareja - coppia

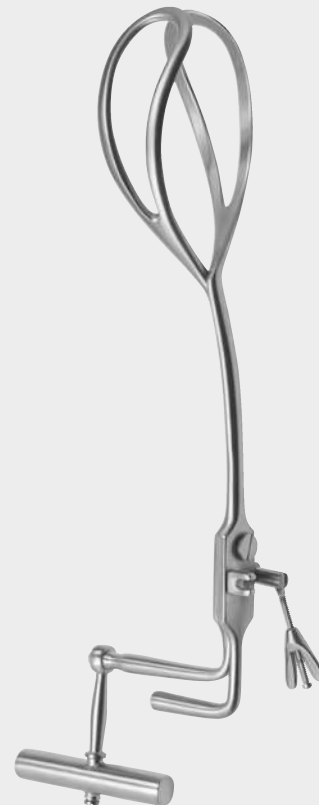

cm PIPER
40,0 72-1507-40



cm Mod. BAMBERG
36,0 72-1509-36

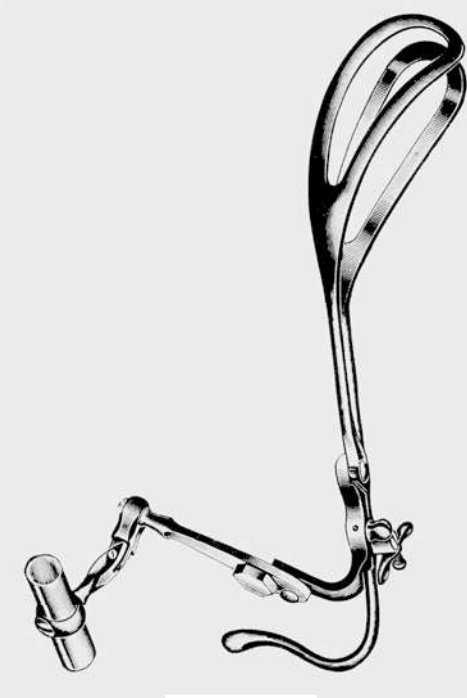

cm DEWEY
37,0 72-1600-37



cm TARNIER
40,0 72-1602-40

Geburtszangen
Obstetrical (Midwifery) Forceps
Forceps
Fórceps obstétricos
Forcipi

GEBURTSHILFE

OBSTETRICS

ACCOUCHEMENTS

OBSTRETRICIA

OSTETRICIA

Zughebel
Traction Handles
Tracteurs
Tractores
Trattori



cm HAIG FERGUSSON
36,0 72-1604-36



cm NEVILLE BARNES
40,0 72-1609-40



LUIKART
72-1700-00

cm LUIKART-BILL
21,0 72-1701-21



cm DEMELIN SUZOR
32,0 72-1710-33

GEBURTSHILFE

OBSTETRICS

ACCOUCHEMENTS

OBSTRETRICIA

OSTETRICIA



cm SMELLIE
33,0 72-1801-33

Geburtshaken
Obstetrical Hook
Crochet obstétrique
Gancho obstétrico
Uncino ostetrico



cm GAUSS
27,0 72-1803-27

Kopfschwanzzange
Scalp Flap Forceps
Pince péricrânienne
Pinza para pericráneo
Pinza per pericranio

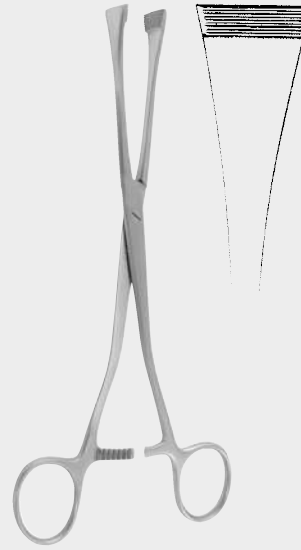

cm GREEN-ARMYTAGE
21,0 72-1804-21 72-1805-21

Klemmzange
Uterine Hemostatic Forceps
Pince clamp utérine
Pinza clamp uterina
Pinza clamp uterina



cm COLLIN
9,0 72-1807-09

Nabelschnurklemmen
Umbilical Cord Clamps
Clamps pour le cordon ombilical
Clamps umbilicales
Pinze ombelicali

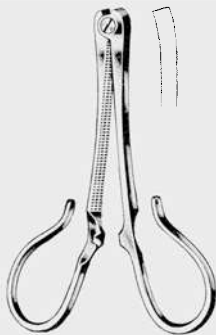

cm KANE
8,5 72-1809-09



cm
9,5 72-1810-09



cm BAR
14,0 72-1813-14



cm MARTIN
34,0 72-1901-34



cm COLLIER
30,0 72-1903-30



cm COLLIN
35,0 72-1905-35

Für Innenmessung
For internal measuring
Pour mesurer à l'intérieur
Para medir en el interior
Per misurare all'interno



cm DE LEE
20,0 72-1910-20

Beckenzirkel
Pelvimeters
Compas pelvimètres
Pelvímetros
Pelvimetri

GEBURTSHILFE

OBSTETRICS

ACCOUCHEMENTS

OBSTRETRICIA

OSTETRICIA

Plazenta- und Abortus-Zangen
 Placenta and Ovum Forceps
 Pincès à faux germes
 Pinzas para aborto y placenta
 Pinze per aborto e placenta

GEBURTSHILFE

OBSTETRICS

ACCOUCHEMENTS

OBSTRETRICIA

OSTETRICIA

Abortus-Kürette, -Löffel
 Abortion Curette, Abortion Scoop
 Curette, Cuillères à faux germes
 Cureta, Cucharas para aborto
 Curetta, Cucchiari per aborto

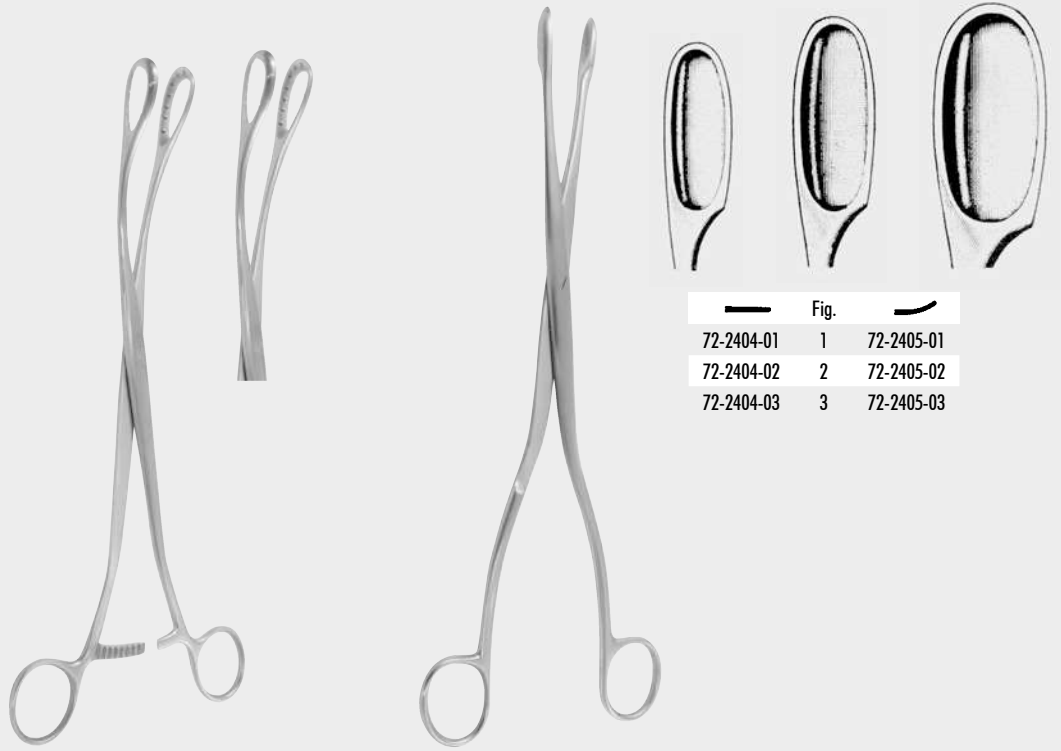

	Fig.	
72-2404-01	1	72-2405-01
72-2404-02	2	72-2405-02
72-2404-03	3	72-2405-03

cm SAENGER
 27,0 72-2402-27 72-2403-27

cm WINTER
 28,0 72-2404-01 - 72-2405-03



cm
 28,0 72-2406-28

cm PESTALOZZA
 30,0 72-2502-30

cm CUZZI
 30,0 72-2504-14 - 72-2504-21

72-2504-14
 14,5 mm

72-2504-18
 18,0 mm

72-2504-21
 21,0 mm

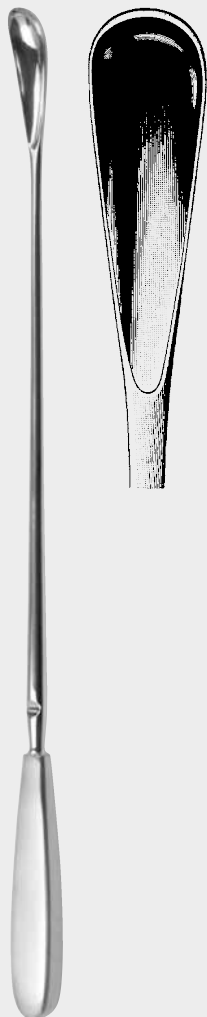

cm WALLICH
42,0 72-2506-42

Abortus-Löffel - Abortion Scoop - Cuillère à faux germes -
Cuchara para aborto - Cucchio per aborto



cm SELLHEIM
28,0 72-2509-28

Geburtslöffel - Elevating
Spoon - Levier pour
abaissement de la tête -
Separador para salida de la
cabeza - Cucchio obstetrico



cm SELLHEIM
26,0 72-2511-26



cm BOER
29,0 72-3001-29



Kranioklast
Cranioclast
Cranioclaste
Craneóclasto
Cranioclasto

cm BRAUN
42,0 72-3002-42

GEBURTSHILFE

OBSTETRICS

ACCOUCHEMENTS

OBSTRETRICIA

OSTETRICIA

Kranioklast
 Cranioclast
 Cranioclaste
 Craneóclasto
 Cranioclasto

GEBURTSHILFE

OBSTETRICS

ACCOUCHEMENTS

OBSTRETRICIA

OSTETRICIA

Perforatorium, Dekapitationshaken
 Perforator, Decapitation Hook
 Perce-crâne, Crochet à décapitation
 Perfora-cráneo, Gancho de decapitación
 Spezzacranio, Uncino per decapitazione



cm TARNIER
 46,0 72-3004-46



cm SMELLIE
 25,0 72-3006-25



cm BRAUN
 30,0 72-3009-30

DERMATOLOGIE, HYGIENE

DERMATOLOGY, HYGIENE

DERMATALOGIE, HYGIÈNE

DERMATALOGÍA, HIGIENE

DERMATOLOGIA, IGIENE



Hauthäkchen, Komedonenquetscher
 Skin Hooklet, Comedo Extractors
 Crochet à peau, Tire-comédons
 Ganchito de piel, Saca-comedones
 Uncinetto per la pelle, Tiracomedoni



cm KILNER
15,0 74-1003-15



cm GILLESBERGER
14,0 74-1007-14



cm SCHAMBERG
10,0 74-1101-10



cm UNNA
14,0 74-1103-14



cm UNNA
14,0 74-1105-14



cm WALTON
14,0 74-1108-14



cm SAALFELD
10,0 74-1201-10



cm SAALFELD
14,0 74-1202-14

DERMATOLOGIE
HYGIENE

DERMATOLOGY
HYGIENE

DERMATOLOGIE
HYGIÈNE

DERMATOLOGÍA
HIGIENE

DERMATOLOGIA
HYGIENE

Lupusküretten
 Lupus Curettes
 Curettes pour les lupus
 Curetas para lupus
 Curette per lupus



cm VIDAL
14,0 74-1204-14



cm DERMO
13,5 74-1205-13



Fig.	WOLFF
1	74-1206-01
2	74-1206-02
3	74-1206-03
4	74-1206-04
5	74-1206-05
6	74-1206-06



mm	FOX
2	74-1208-02
3	74-1208-03
4	74-1208-04
5	74-1208-05
6	74-1208-06



2 mm



3 mm



4 mm



5 mm



6 mm



Fig.	PIFFARD
1	74-1300-01
2	74-1300-02
3	74-1300-03



Fig. 1



Fig. 2



Fig. 3



○ 2 mm

○ 3 mm

○ 4 mm

○ 5 mm

○ 6 mm

○ 7 mm

○ 8 mm

○ 9 mm

Hauttrephinen
Cutaneous Trephines
Trépan cutané
Trépano cutáneo
Trefine cutanee

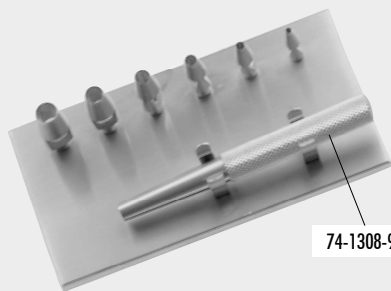

74-1308-99

KEYES compl.
74-1308-00

bestehend aus Halteplatte, 1 Handgriff und 6 Trephinen 2 bis 7 mm
consisting of basis plate, 1 handle and 6 trephines 2 to 7 mm
composé de support, 1 manche et 6 trépan 2 à 7 mm
compuesto de soporte, 1 mango y 6 trefinas 2 a 7 mm
composto da supporto, 1 manico e 6 trefine 2 a 7 mm



mm	KEYES
2	74-1400-02
3	74-1400-03
4	74-1400-04
5	74-1400-05
6	74-1400-06
7	74-1400-07
8	74-1400-08
9	74-1400-09

DERMATOLOGIE
HYGIENE

DERMATOLOGY
HYGIENE

DERMATOLOGIE
HYGIÈNE

DERMATOLOGÍA
HIGIENE

DERMATOLOGIA
IGIENE

Maniküre, Pedicure
Manicure, Pedicure
Manicure, Pédicure
Manicura, Pedicura
Manicure, Pedicure



74-3001-10

Schwesterngarnitur
Hospital Nurse Set
Trousse à manucure pour infirmières
Juego de manicura para enfermeras
Astuccio per manicure per infermiere

cm	—	—
9,0	74-3004-09	74-3005-09
10,0	74-3004-10	74-3005-10



cm 14,0 74-3301-14

cm	—	—
9,0	74-3006-09	74-3007-09
10,0		74-3007-10

ZEPF®
INSTRUMENTS



Maniküre, Pedicure
 Manicure, Pedicure
 Manicure, Pédicure
 Manicura, Pedicura
 Manicure, Pedicure



cm
 14,0 74-3306-14



cm
 13,0 74-3311-13



cm
 14,0 74-3312-14

DERMATOLOGIE
 HYGIENE

DERMATOLOGY
 HYGIENE

DERMATOLOGIE
 HYGIÈNE

DERMATOLOGÍA
 HIGIENE

DERMATOLOGIA
 HIGIENE



cm TURNBULL
 11,5 74-3401-11
 13,5 74-3401-13



cm
 15,0 74-3409-15

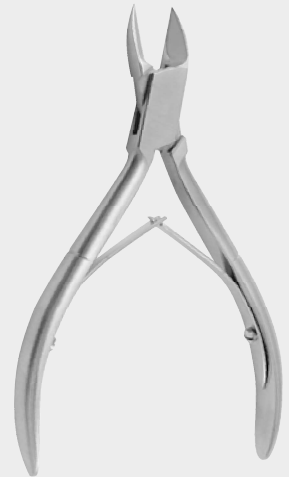

cm
 13,0 74-3600-13



cm
 11,0 74-3602-11



cm
 13,0 74-3604-13



cm
 11,0 74-3605-11





cm
10,5 74-3703-10

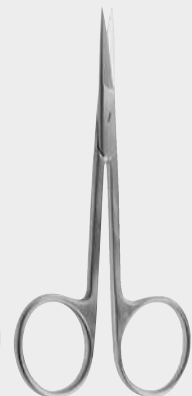

cm
10,0 74-3708-10



cm
10,0 74-3709-10



cm
10,0 74-3806-10
12,0 74-3806-12



74-3906-00

Ersatzklingen, 10 Stück
Spare Blades, 10 ea.
Lames de rechange, 10 pièces
Hojas de repuesto, 10 c/u
Lame di ricambio, 10 pezzi

cm CREDO
14,5 74-3905-14

Maniküre, Pedicure
Manicure, Pedicure
Manicure, Pédicure
Manicura, Pedicura
Manicure, Pedicure



74-3908-00

400 x autoklavierbar
autoclavable 400 times
stérilisable en autoclave 400 fois
esterilizable en autoclave 400 veces
sterilizzabile in autoclave 400 volte

DERMATOLOGIE
HYGIENE

DERMATOLOGY
HYGIENE

DERMATOLOGIE
HYGIÈNE

DERMATOLOGÍA
HIGIENE

DERMATOLOGIA
IGIENE



74-3909-10
74-3909-20

ohne Bürsten
without brushes
sans brosses
sin cepillos
senza spazzole

Handwaschbürste, Bürstspender
Brush Dispenser, Nail Brush
Distributeur de brosses, Brosse à ongles
Distribuidor de cepillos, Cepillo para uñas
Distributore di spazzole, Spazzola per unghie

74-3909-10 kleines Modell, für 10 Handwaschbürsten
Small Size, for 10 nail brushes
Petit modèle, pour 10 brosses à ongles
Modelo pequeño, para 10 cepillos para uñas
Piccolo modello, per 10 spazzole per unghie

74-3909-20 großes Modell, für 20 Handwaschbürsten
Large Size, for 20 nail brushes
Grand modèle, pour 20 brosses à ongles
Modelo grande, para 20 cepillos para uñas
Modello grande, per 20 spazzole per unghie

DERMATOLOGIE
HYGIENE

DERMATOLOGY
HYGIENE

DERMATALOGIE
HYGIÈNE

DERMATALOGÍA
HIGIENE

DERMATOLOGIA
IGIENE

AUFBEWAHRUNG, STERILISATION

STORAGE, STERILIZATION

CONSERVATION, STÉRILISATION

CONSERVACIÓN, ESTERILIZACIÓN

CONSERVAZIONE, STERILIZZAZIONE

Nadel-Etuvis
Needle Cases
Boîtes à aiguilles
Estuches para agujas
Astucci per aghi



SAUERBRUCH
88-1100-21
210 x 125 x 17 mm

18/10
Edelstahl rostfrei
Stainless Steel
Acier inoxydable
Acero inoxidable
Acciaio inossidabile



88-1102-65
65 x 15 mm



88-1103-65

AUFBEWAHRUNG, STERILISATION

STORAGE, STERILIZATION

CONSERVATION, STÉRILISATION

CONSERVACIÓN, ESTERILIZACIÓN

CONSERVAZIONE, STERILIZZAZIONE

Instrumentenkästen
Instrument Cases
Boîtes à instruments
Cajas para instrumentos
Scatole per strumenti



88-1104-00
150 x 95 x 13 mm

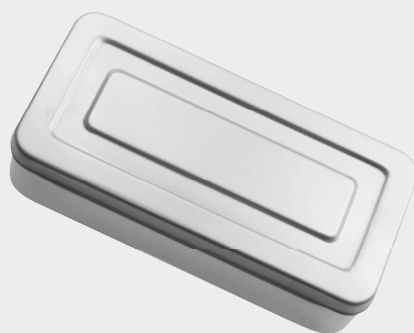

mm x mm x mm	
180 x 80 x 40	88-1200-18
200 x 100 x 60	88-1200-20
220 x 120 x 60	88-1200-22
250 x 120 x 60	88-1200-25
300 x 125 x 60	88-1200-30
320 x 150 x 60	88-1200-32
400 x 160 x 75	88-1200-40
500 x 200 x 120	88-1200-50

Ganz aus rostfreiem Stahl
Entirely from Stainless Steel
Complètement en acier inoxydable
Enteramente de acero inoxidable
Completamente in acciaio inossidabile



mm x mm x mm	
220 x 100 x 50	88-1204-22
220 x 140 x 60	88-1204-23
270 x 170 x 60	88-1204-27

Aus Glas mit rostfreiem Stahldeckel
From Glass with Stainless Steel Lid
En verre avec couvercle en acier inoxydable
De vidrio con tapa inoxidable
In cristallo con coperchi in acciaio inossidabile



mm x mm	
100 x 100	88-1205-10
120 x 120	88-1205-12
150 x 150	88-1205-15

Aus Glas mit rostfreiem Stahldeckel
 From Glass with Stainless Steel Lid
 En verre avec couvercle en acier inoxydable
 De vidrio con tapa inoxidable
 In vetro con coperchi in acciaio inossidabile



mm		ml
40	88-1300-04	15
60	88-1300-06	50
80	88-1300-08	175
100	88-1300-10	250
120	88-1300-12	350
150	88-1300-15	900



88-1302-25
25 ml



88-1302-50
50 ml



mm x mm	l	
165 x 60	0,75	88-1303-16
175 x 70	1,00	88-1303-17
220 x 80	2,00	88-1303-22
225 x 90	2,50	88-1303-23
240 x 110	3,00	88-1303-24
255 x 115	4,00	88-1303-25
275 x 115	4,50	88-1303-27
290 x 125	6,00	88-1303-29
310 x 120	6,00	88-1303-31
345 x 125	8,50	88-1303-34
380 x 130	11,00	88-1303-38
415 x 140	14,00	88-1303-41

18/10

Edelstahl rostfrei
 Stainless Steel
 Acier inoxydable
 Acero inoxidable
 Acciaio inossidabile



l	
1,0	88-1304-10
1,5	88-1304-15
2,0	88-1304-20



cm	
20,0	88-1309-20
*25,0	88-1309-25
27,0	88-1309-27
*	standard



l		h = cm
0,25	88-1400-02	7
0,50	88-1400-05	11
1,00	88-1400-10	14
1,50	88-1400-15	16
2,00	88-1400-20	18

 AUFBEWAHRUNG,
 STERILISATION

 STORAGE,
 STERILIZATION

 CONSERVATION,
 STÉRILISATION

 CONSERVACIÓN,
 ESTERILIZACIÓN

 CONSERVAZIONE,
 STERILIZZAZIONE

Verschiedene Behälter
Different Containers
Boîtes diverses
Contenedores varios
Vassoi diversi



88-1401-10
100 x 20 mm



mm x mm	
30 x 90	88-1402-01
50 x 100	88-1402-02
50 x 130	88-1402-03
50 x 175	88-1402-04
75 x 100	88-1402-05
75 x 130	88-1402-06
75 x 175	88-1402-07
100 x 175	88-1402-08
100 x 200	88-1402-09



cm	
25	88-1403-25
32	88-1403-32
39	88-1403-39

AUFBEWAHRUNG, STERILISATION

STORAGE, STERILIZATION

CONSERVATION, STÉRILISATION

CONSERVACIÓN, ESTERILIZACIÓN

CONSERVAZIONE, STERILIZZAZIONE



mm x mm x mm	
200 x 150 x 25	88-1404-20
260 x 160 x 30	88-1404-26
300 x 220 x 30	88-1404-30
350 x 220 x 40	88-1404-35
540 x 360 x 25	88-1404-54
680 x 450 x 25	88-1404-68



mm x mm x mm	
220 x 170 x 50	88-1406-22
280 x 200 x 50	88-1406-28
320 x 240 x 50	88-1406-32
370 x 270 x 50	88-1406-37
420 x 320 x 50	88-1406-42

Instrumentenschalen, Abfallbehälter
Instrument Trays, Kick Bucket
Plateaux à instruments,
Bac avec chariot
Bandejas para instrumentos,
Cubo móvil
Bacinelle per strumenti,
Bastardella con supporto



Alkohol-Spender
Alcohol Dispenser
Distributeur d'alcool
Distribuidor de alcohol
Distributore d'alcool

ml	ALCOSPEND
250	88-1407-25



ø x h mm	
410 x 165	88-1408-00

ZEPF[®]
α
INSTRUMENTS

88-1401-10

88.4

SCHIMMELBUSCH

Mit seitlichen verschließbaren Öffnungen
 With lateral openings that may be closed
 Avec des ventouses latérales
 Con aberturas circunferenciales
 Con perforazioni circonfenziali

18/10
 Edelstahl rostfrei
 Stainless Steel
 Acier inoxydable
 Acero inoxidable
 Acciaio inossidabile

KONRICH

Mit Filtern in Deckeln und Böden
 With Filters in Lids and Bottoms
 Avec des filtres en couvercles et fonds
 Con filtros en tapas y fondos
 Con filtri in corpi e coperchi

Sterilisiertrommeln
 Sterilization Drums
 Tambours à stérilisation
 Tambores de esterilización
 Cestelli per sterilizzazione

SCHIMMELBUSCH	ø x h mm	KONRICH
88-1502-08	125 x 80	88-1802-08
88-1502-10	125 x 100	88-1802-10
88-1502-12	125 x 125	88-1802-12
88-1505-08	150 x 80	
88-1505-10	150 x 100	88-1805-10
88-1505-13	150 x 130	88-1805-13
88-1505-15	150 x 150	88-1805-15
88-1505-19	150 x 190	88-1805-19
88-1509-14	190 x 145	88-1809-14
88-1509-16	190 x 165	88-1809-16
88-1509-19	190 x 190	88-1809-19
88-1509-24	190 x 240	88-1809-24
88-1604-14	240 x 145	
88-1604-16	240 x 165	88-1904-16
88-1604-19	240 x 190	88-1904-19
88-1604-24	240 x 240	88-1904-24
88-1604-29	240 x 290	88-1904-29
88-1604-34	240 x 340	
88-1604-39	240 x 390	
88-1609-14	290 x 145	88-1909-14
88-1609-16	290 x 165	88-1909-16
88-1609-19	290 x 190	88-1909-19
88-1609-24	290 x 240	88-1909-24
88-1609-29	290 x 290	88-1909-29
88-1609-34	290 x 340	
88-1609-39	290 x 390	
88-1704-14	340 x 145	88-2004-14
88-1704-16	340 x 165	88-2004-16
88-1704-19	340 x 190	88-2004-19
88-1704-24	340 x 240	88-2004-24
88-1704-29	340 x 290	88-2004-29
88-1704-34	340 x 340	
88-1704-39	340 x 390	
88-1709-14	390 x 145	88-2009-14
88-1709-16	390 x 165	
88-1709-19	390 x 190	88-2009-19
88-1709-24	390 x 240	88-2009-24
88-1709-29	390 x 290	88-2009-29
88-1709-34	390 x 340	88-2009-34
88-1709-39	390 x 390	88-2009-39
88-1709-49	390 x 490	
88-1709-59	390 x 590	

**AUFBEWAHRUNG,
 STERILISATION**
**STORAGE,
 STERILIZATION**
**CONSERVATION,
 STÉRILISATION**
**CONSERVACIÓN,
 ESTERILIZACIÓN**
**CONSERVAZIONE,
 STERILIZZAZIONE**

Mit Filtern in Deckel und Boden
 With Filters in Lid and Bottom
 Avec des filtres en fonds et couvercles
 Con filtros en fondos y tapas
 Con filtri in corpi e coperchi

18/10
 Edelstahl rostfrei
 Stainless Steel
 Acier inoxydable
 Acero inoxidable
 Acciaio inossidabile

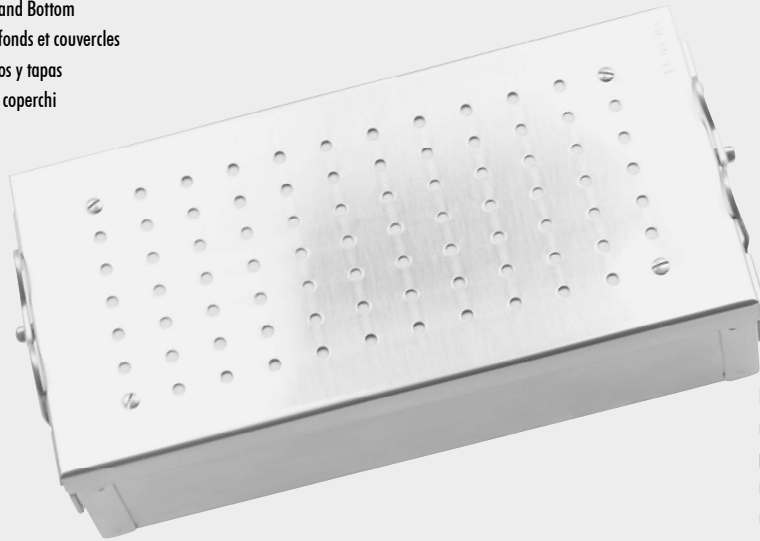

Sterilisierbehälter
 Sterilization Boxes
 Boîtes de stérilisation
 Cajas de esterilización
 Cestelli per sterilizzazione

kein Medizinprodukt
 no medical device
 pas dispositiue medicale
 no es un producto sanitario
 non è un prodotto medicinale

kein Medizinprodukt
 no medical device
 pas dispositiue medicale
 no es un producto sanitario
 non è un prodotto medicinale

AUFBEWAHRUNG, STERILISATION

STORAGE, STERILIZATION

CONSERVATION, STÉRILISATION

CONSERVACIÓN, ESTERILIZACIÓN

CONSERVAZIONE, STERILIZZAZIONE

	cm x cm x cm
88-2100-01	15 x 15 x 15
88-2100-02	16 x 15 x 12
88-2100-03	17 x 12 x 4
88-2100-04	18 x 16 x 4
88-2100-05	19 x 14 x 4
88-2100-06	20 x 10 x 5
88-2100-07	20 x 14 x 6
88-2100-08	20 x 16 x 6
88-2100-09	20 x 16 x 12
88-2100-10	22 x 11 x 5
88-2100-11	22 x 14 x 5
88-2100-12	22 x 14 x 12
88-2100-13	23 x 13 x 7
88-2100-14	24 x 11 x 5
88-2100-15	24 x 13 x 5
88-2100-16	24 x 20 x 11
88-2100-17	25 x 12 x 5
88-2100-18	25 x 23 x 5
88-2100-19	26 x 15 x 7
88-2100-20	28 x 11 x 5
88-2100-21	28 x 11 x 9
88-2100-22	28 x 13 x 5
88-2100-23	28 x 13 x 9
88-2100-24	28 x 13 x 11
88-2100-25	28 x 15 x 5
88-2100-26	29 x 19 x 12
88-2100-27	29 x 28 x 8
88-2100-28	29 x 28 x 15
88-2100-29	29 x 29 x 10
88-2100-30	30 x 13 x 4
88-2100-31	30 x 15 x 15
88-2100-32	30 x 16 x 6
88-2100-33	30 x 16 x 12
88-2100-34	30 x 20 x 7
88-2100-35	30 x 25 x 15
88-2100-36	32 x 11 x 4
88-2100-37	32 x 13 x 6
88-2100-38	32 x 20 x 8
88-2100-39	32 x 25 x 8
88-2100-40	32 x 27 x 5
88-2100-41	35 x 10 x 5
88-2100-42	35 x 11 x 5
88-2100-43	35 x 12 x 4
88-2100-44	35 x 12 x 8
88-2100-45	35 x 15 x 9

	cm x cm x cm
88-2100-46	35 x 15 x 14
88-2100-47	35 x 18 x 8
88-2100-48	35 x 18 x 12
88-2100-49	35 x 25 x 15
88-2100-50	36 x 14 x 5
88-2100-51	36 x 14 x 8
88-2100-52	36 x 14 x 11
88-2100-53	37 x 19 x 8
88-2100-54	38 x 13 x 8
88-2100-55	38 x 25 x 15
88-2100-56	40 x 12 x 9
88-2100-57	40 x 14 x 4
88-2100-58	40 x 14 x 9
88-2100-59	40 x 20 x 8
88-2100-60	42 x 13 x 4
88-2100-61	42 x 13 x 8
88-2100-62	42 x 13 x 10
88-2100-63	42 x 16 x 6
88-2800-64	42 x 16 x 12
88-2100-65	42 x 17 x 7
88-2100-66	42 x 20 x 12
88-2100-67	43 x 13 x 4
88-2100-68	43 x 14 x 12
88-2100-69	43 x 20 x 6
88-2100-70	43 x 20 x 8
88-2100-71	43 x 20 x 12
88-2100-72	43 x 20 x 20
88-2100-73	45 x 14 x 4
88-2100-74	45 x 15 x 7
88-2100-75	45 x 18 x 5
88-2100-76	45 x 19 x 8
88-2100-77	49 x 13 x 5
88-2100-78	49 x 17 x 5
88-2100-79	49 x 17 x 8
88-2100-80	49 x 17 x 10
88-2100-81	49 x 28 x 11
88-2100-82	50 x 19 x 5
88-2100-83	50 x 20 x 6
88-2100-84	54 x 34 x 15
88-2100-85	57 x 28 x 15
88-2100-86	60 x 15 x 10
88-2100-87	60 x 20 x 10
88-2100-88	75 x 17 x 9
88-2100-89	75 x 25 x 15
88-2100-90	90 x 10 x 5

18/10
 Edelstahl rostfrei
 Stainless Steel
 Acier inoxydable
 Acero inoxidable
 Acciaio inossidabile



kein Medizinprodukt
 no medical device
 pas dispositif medicale
 no es un producto sanitario
 non è un prodotto medicinale

Instrumentenbehälter
 Instrument Cases
 Boîtes à instruments
 Cajas para instrumentos
 Scarole per strumenti

kein Medizinprodukt
 no medical device
 pas dispositif medicale
 no es un producto sanitario
 non è un prodotto medicinale

	cm x cm x cm
88-2101-01	15 x 15 x 15
88-2101-02	16 x 15 x 12
88-2101-03	17 x 12 x 4
88-2101-04	18 x 16 x 4
88-2101-05	19 x 14 x 4
88-2101-06	20 x 10 x 5
88-2101-07	20 x 14 x 6
88-2101-08	20 x 16 x 6
88-2101-09	20 x 16 x 12
88-2101-10	22 x 11 x 5
88-2101-11	22 x 14 x 5
88-2101-12	22 x 14 x 12
88-2101-13	23 x 13 x 7
88-2101-14	24 x 11 x 5
88-2101-15	24 x 13 x 5
88-2101-16	24 x 20 x 11
88-2101-17	25 x 12 x 5
88-2101-18	25 x 23 x 5
88-2101-19	26 x 15 x 7
88-2101-20	28 x 11 x 5
88-2101-21	28 x 11 x 9
88-2101-22	28 x 13 x 5
88-2101-23	28 x 13 x 9
88-2101-24	28 x 13 x 11
88-2101-25	28 x 15 x 5
88-2101-26	29 x 19 x 12
88-2101-27	29 x 28 x 8
88-2101-28	29 x 28 x 15
88-2101-29	29 x 29 x 10
88-2101-30	30 x 13 x 4
88-2101-31	30 x 15 x 15
88-2101-32	30 x 16 x 6
88-2101-33	30 x 16 x 12
88-2101-34	30 x 20 x 7
88-2101-35	30 x 25 x 15
88-2101-36	32 x 11 x 4
88-2101-37	32 x 13 x 6
88-2101-38	32 x 20 x 8
88-2101-39	32 x 25 x 8
88-2101-40	32 x 27 x 5
88-2101-41	35 x 10 x 5
88-2101-42	35 x 11 x 5
88-2101-43	35 x 12 x 4
88-2101-44	35 x 12 x 8
88-2101-45	35 x 15 x 9

	cm x cm x cm
88-2101-46	35 x 15 x 14
88-2101-47	35 x 18 x 8
88-2101-48	35 x 18 x 12
88-2101-49	35 x 25 x 15
88-2101-50	36 x 14 x 5
88-2101-51	36 x 14 x 8
88-2101-52	36 x 14 x 11
88-2101-53	37 x 19 x 8
88-2101-54	38 x 13 x 8
88-2101-55	38 x 25 x 15
88-2101-56	40 x 12 x 9
88-2101-57	40 x 14 x 4
88-2101-58	40 x 14 x 9
88-2101-59	40 x 20 x 8
88-2101-60	42 x 13 x 4
88-2101-61	42 x 13 x 8
88-2101-62	42 x 13 x 10
88-2101-63	42 x 16 x 6
88-2101-64	42 x 16 x 12
88-2101-65	42 x 17 x 7
88-2101-66	42 x 20 x 12
88-2101-67	43 x 13 x 4
88-2101-68	43 x 14 x 12
88-2101-69	43 x 20 x 6
88-2101-70	43 x 20 x 8
88-2101-71	43 x 20 x 12
88-2101-72	43 x 20 x 20
88-2101-73	45 x 14 x 4
88-2101-74	45 x 15 x 7
88-2101-75	45 x 18 x 5
88-2101-76	45 x 19 x 8
88-2101-77	49 x 13 x 5
88-2101-78	49 x 17 x 5
88-2101-79	49 x 17 x 8
88-2101-80	49 x 17 x 10
88-2101-81	49 x 28 x 11
88-2101-82	50 x 19 x 5
88-2100-83	50 x 20 x 6
88-2101-84	54 x 34 x 15
88-2101-85	57 x 28 x 15
88-2101-86	60 x 15 x 10
88-2101-87	60 x 20 x 10
88-2101-88	75 x 17 x 9
88-2101-89	75 x 25 x 15
88-2101-90	90 x 10 x 5

**AUFBEWAHRUNG,
 STERILISATION**

**STORAGE,
 STERILIZATION**

**CONSERVATION,
 STÉRILISATION**

**CONSERVACIÓN,
 ESTERILIZACIÓN**

**CONSERVAZIONE,
 STERILIZZAZIONE**

Sterilisier-Siebschalen
Sterilization Trays
Plateaux à stérilisation
Bandejas de esterilización
Cestelli per sterilizzazione

18/10
Edelstahl rostfrei
Stainless Steel
Acier inoxydable
Acero inoxidable
Acciaio inossidabile

**AUFBEWAHRUNG,
STERILISATION**

**STORAGE,
STERILIZATION**

**CONSERVATION,
STÉRILISATION**

**CONSERVACIÓN,
ESTERILIZACIÓN**

**CONSERVAZIONE,
STERILIZZAZIONE**

Siebkörbe mit Mini-Perforation
Stainless Steel Trays with Mini Perforation
Plateaux inox avec mini-perforation
Bandejas de acero inoxidable con mini-perforación
Cesti in lamiera con mini-perforazioni



cm x cm x cm		
21 x 14,5 x 5,0	88-2214-50	88-2214-99
24 x 24,0 x 4,1	88-2224-41	
24 x 24,0 x 4,5	88-2224-45	
24 x 24,0 x 5,0	88-2224-50	88-2224-99
24 x 24,0 x 7,0	88-2224-70	
24 x 24,0 x 9,0	88-2224-90	
24 x 30,0 x 5,0	88-2324-50	88-2324-99
28 x 11,0 x 4,0	88-2328-40	
28 x 11,0 x 7,0	88-2328-70	88-2328-99
40 x 24,0 x 4,1	88-2340-41	
40 x 24,0 x 4,5	88-2340-45	
40 x 24,0 x 5,0	88-2340-50	88-2340-99
40 x 24,0 x 7,0	88-2340-70	
40 x 24,0 x 9,0	88-2340-90	
48 x 24,0 x 4,1	88-2348-41	
48 x 24,0 x 4,5	88-2348-45	
48 x 24,0 x 5,0	88-2348-50	88-2348-99
48 x 24,0 x 7,0	88-2348-70	
48 x 24,0 x 9,0	88-2348-90	
54 x 24 x 4,1	88-2354-41	
54 x 24 x 4,5	88-2354-45	
54 x 24 x 5,0	88-2354-50	88-2354-99
54 x 24 x 7,0	88-2354-70	
54 x 24 x 9,0	88-2354-90	



Siebkörbe
Trays
Plateaux
Bandejas
Cesti



Deckel
Lids
Couvercles
Tapas
Coperchi

Aus Drahtgeflecht
Wire Mesh
En fil inox
De alambre
In rete metallica

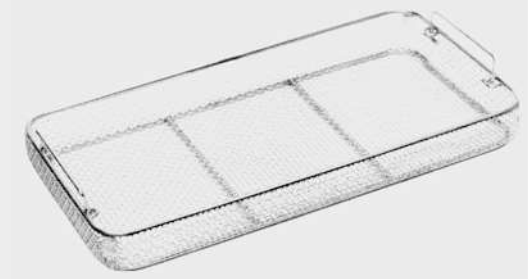

cm x cm x cm		
26,7 x 12,5 x 50	88-2398-27	mini
24,0 x 25 x 3	88-2399-24	
48,0 x 25 x 3	88-2399-48	
24,0 x 25 x 5	88-2400-24	
48,0 x 25 x 5	88-2400-48	
55,0 x 25 x 5	88-2400-55	
24,0 x 25 x 7	88-2401-24	
48,0 x 25 x 7	88-2401-48	
51,0 x 25 x 7	88-2401-51	
24,0 x 25 x 10	88-2402-24	
48,0 x 25 x 10	88-2402-48	
51,0 x 25 x 10	88-2402-51	
27,4 x 17,2 x 43	88-2403-28	Dental
40,5 x 25 x 3	88-2403-30	
40,5 x 25 x 5	88-2403-50	
40,5 x 25 x 7	88-2403-70	
40,5 x 25 x 10	88-2404-00	



88-2508-01



88-2508-02

Fixierstifte für Siebschalen
 Fixing Bolts for Sterilization Trays
 Chevilles pour plateaux
 Pernos de fijación para bandejas
 Perni di fissaggio per cestelli

Trennwände für Siebschalen
 Dividers for Sterilization Trays
 Cloisons pour plateaux
 Paredes divisorias para bandejas
 Divisori per cesti in rete



mm		mm	
50 x 35	88-2512-05	50 x 20	88-2513-05
120 x 35	88-2512-12	130 x 20	88-2513-13
200 x 35	88-2512-20	225 x 20	88-2513-22
450 x 35	88-2512-45	460 x 20	88-2513-46

AUFBEWAHRUNG,
STERILISATION

STORAGE,
STERILIZATION

CONSERVATION,
STÉRILISATION

CONSERVACIÓN,
ESTERILIZACIÓN

CONSERVAZIONE,
STERILIZZAZIONE



cm	
11,0	88-2520-11
17,0	88-2520-17
23,0	88-2520-23
47,0	88-2520-47

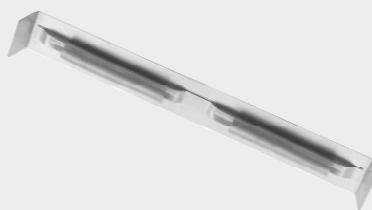

88-2525-00



88-2526-00



88-2530-00



cm	
23,0	88-2532-23
47,0	88-2532-47



cm	
23,0	88-2534-23
47,0	88-2534-47

Sterilisations-Zubehör
Accessories for Sterilization
Accessoires pour la stérilisation
Accesorios para la esterilización
Accessori per la sterilizzazione

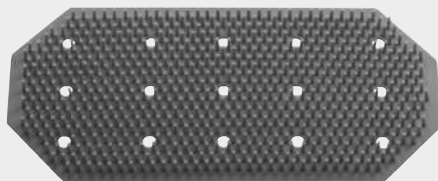

Noppenmatten aus Silikon, blau
Silicon studded mats blue
Tapis porte-instruments en silicone bleu
Tapices porta instrumentos de silicona azul
Tapetti porta-strumenti in silicone azzuro

mm	
260 x 180	88-2550-20
255 x 235	88-2550-21
275 x 125	88-2550-24
270 x 240	88-2550-25
300 x 300	88-2550-26
400 x 30	88-2550-40
520 x 230	88-2550-54

AUFBEWAHRUNG,
STERILISATION

STORAGE,
STERILIZATION

CONSERVATION,
STÉRILISATION

CONSERVACIÓN,
ESTERILIZACIÓN

CONSERVAZIONE,
STERILIZZAZIONE



Sterilisier-Tuch grün
Sterilization Drape green
Drap de stérilisation vert
Paño de esterilización verde
Panno di sterilizzazione verde

cm	
40 x 60	88-2600-04
100 x 100	88-2600-10
100 x 130	88-2600-13
100 x 160	88-2600-16



MED-I-TAPE zur Farbkodierung chirurgischer Instrumente, 6,5 mm breit - Rollenlänge 7,60 m
MED-I-TAPE for Color Coding of surgical instruments, width 6,5 mm - length of coil 7,60 m
MED-I-TAPE pour la codification d'instruments chirurgicaux par des couleurs, 6,5 mm de large - bobine de 7,60 m
MED-I-TAPE para codificación de instrumentos quirúrgicos con colores, ancho 6,5 mm - rollo de 7,60 m
MED-I-TAPE per la codificazione di strumenti chirurgici con colori, largo 6,5 mm - bobina di 7,60 m

88-2607-00	weiß · white · blanc · blanco · bianco
88-2607-01	blau · blue · bleu · azul · azzuro
88-2607-02	grün · green · vert · verde · verde
88-2607-03	rot · red · rouge · rojo · rosso
88-2607-04	gelb · yellow · jaune · amarillo · giallo
88-2607-06	orange · orange · orange · naranja · arancia
88-2607-07	braun · brown · brun · marrón · marrone
88-2607-08	schwarz · black · noir · negro · nero



System:
Filter in Deckel
und Boden.
Deckel ohne
Scharniere

System:
Filters in
Lid and Bottom.
Lid without
hinge

Système:
Filtres dans le
fond et dans
le couvercle.
Couvercle sans
charnière

Sistema:
Filtros en
fondo y tapa.
Tapa sin bisagra

Sistema:
Filtri in corpo
e coperchio.
Coperchio senza
cerniere



cm x cm x cm

30 x 30 x 10,0 88-3004-10

30 x 30 x 13,5 88-3004-13

30 x 30 x 15,0 88-3004-15

30 x 30 x 20,0 88-3004-20

30 x 30 x 26,0 88-3004-26



cm x cm x cm

60 x 30 x 10,0 88-3007-10

60 x 30 x 13,5 88-3007-13

60 x 30 x 15,0 88-3007-15

60 x 30 x 20,0 88-3007-20

60 x 30 x 26,0 88-3007-26

Steril-Container
Sterilization Containers
Containers à stérilisation
Containers para esterilización
Container per sterilizzazione

18/10
Edelstahl rostfrei
Stainless Steel
Acier inoxydable
Acero inoxidable
Acciaio inossidabile

AUFBEWAHRUNG,
STERILISATION

STORAGE,
STERILIZATION

CONSERVATION,
STÉRILISATION

CONSERVACIÓN,
ESTERILIZACIÓN

CONSERVAZIONE,
STERILIZZAZIONE



System:
Filter in Deckel
und Boden.
Deckel ohne
Scharniere

System:
Filters in
Lid and Bottom.
Lid without
hinge

Système:
Filtres dans le
fond et dans
le couvercle.
Couvercle sans
charnière

Sistema:
Filtros en
fondo y tapa.
Tapa sin bisagra

Sistema:
Filtri in corpo
e coperchio.
Coperchio senza
cerniere



cm x cm x cm

30 x 30 x 10,0 88-3003-10

30 x 30 x 13,5 88-3003-13

30 x 30 x 15,0 88-3003-15

30 x 30 x 20,0 88-3003-20

30 x 30 x 26,0 88-3003-26



cm x cm x cm

60 x 30 x 10,0 88-3006-10

60 x 30 x 13,5 88-3006-13

60 x 30 x 15,0 88-3006-15

60 x 30 x 20,0 88-3006-20

60 x 30 x 26,0 88-3006-26

Aluminium eloxiert
Aluminum Anodized
Aluminium anodisé
Aluminio anodizado
Alluminio anodizzato

ZEPF[®]
α
INSTRUMENTS

88-3006-26

88.11

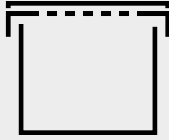

System:
Filter geschützt
in Deckel,
Boden ungelocht
Deckel ohne Scharnier

System:
Filter protected in
the lid. Bottom
non-perforated.
Lid without hinge

Système:
Filtre protégé
dans le
couvercle,
fond non-perforé.
Couvercle sans
charnière

Sistema:
Filtro protegido
en la tapa, fondo
sin perforar.
Tapa sin bisagra

Sistema:
Filtro protetto nel
coperchio, corpo
senza forazioni.
Coperchio senza cerniere

Steril-Container
Sterilization Containers
Containers à stérilisation
Containers para esterilización
Container per sterilizzazione

18/10
Edelstahl rostfrei
Stainless Steel
Acier inoxydable
Acero inoxidable
Acciaio inossidabile

AUFBEWAHRUNG, STERILISATION

STORAGE, STERILIZATION

CONSERVATION, STÉRILISATION

CONSERVACIÓN, ESTERILIZACIÓN

CONSERVAZIONE, STERILIZZAZIONE



cm x cm x cm

30 x 30 x 10,0 88-3005-10

30 x 30 x 13,5 88-3005-13

30 x 30 x 15,0 88-3005-15

30 x 30 x 20,0 88-3005-20

30 x 30 x 26,0 88-3005-26



cm x cm x cm

60 x 30 x 10,0 88-3008-10

60 x 30 x 13,5 88-3008-13

60 x 30 x 15,0 88-3008-15

60 x 30 x 20,0 88-3008-20

60 x 30 x 26,0 88-3008-26

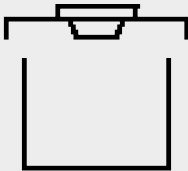

System:
Ventil(e) im
Deckel, Boden
ungelocht.
Deckel ohne
Scharniere

System:
Valve(s) in the
lid, bottom non-
perforated.
Lid without hinges

Système:
Soupape(s) dans
le couvercle, fond
non-perforé.
Couvercle sans
charnière

Sistema:
Valva(s) en la
tapa, fondo sin
perforar.
Tapa sin bisagra

Sistema:
Valvola(e) nel
coperchio, corpo
senza forazioni.
Coperchio senza
cerniere



cm x cm x cm

30 x 30 x 10,0 88-3103-10

30 x 30 x 13,5 88-3103-13

30 x 30 x 15,0 88-3103-15

30 x 30 x 20,0 88-3103-20

30 x 30 x 26,0 88-3103-26



cm x cm x cm

60 x 30 x 10,0 88-3106-10

60 x 30 x 13,5 88-3106-13

60 x 30 x 15,0 88-3106-15

60 x 30 x 20,0 88-3106-20

60 x 30 x 26,0 88-3106-26

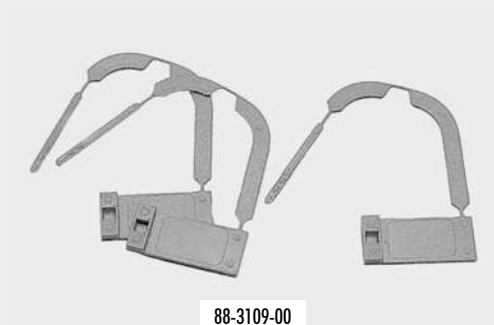

88-3109-00

Sicherungsplomben, 1000 Stück
 Safety Seals, 1000 ea.
 Scellés de sécurité, les 1000
 Precintos de seguridad, 1000 c/u
 Sigilli di sicurezza, 1000 pezzi

Container-Zubehör
 Container Accessories
 Accessoires pour containers
 Accesorios para containers
 Accessori per container

AUFBEWAHRUNG,
 STERILISATION

STORAGE,
 STERILIZATION

CONSERVATION,
 STÉRILISATION

CONSERVACIÓN,
 ESTERILIZACIÓN

CONSERVAZIONE,
 STERILIZZAZIONE

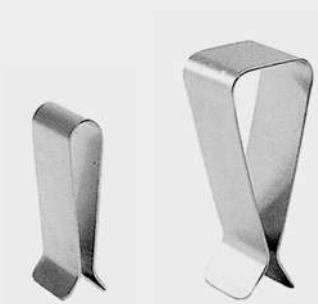

88-3201-01

88-3201-02

Spannklammern für Sterilisiertücher
 Cloth Fixing Clamps
 Pincés fixe-toile
 Grapas para fijar paños
 Pinze fissateli

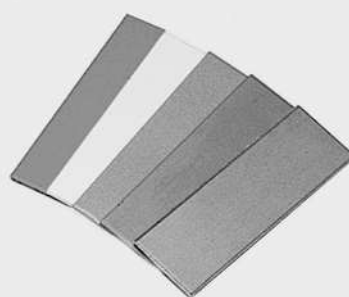

88-3202-01

Aluminium-Schilder ohne Text
 Aluminum Plates, neutral
 Plaquettes en aluminium, neutres
 Placas en aluminio, neutras
 Targhette d'alluminio neutre



88-3202-02

Aluminium-Schilder, graviert
 Aluminum Plates, engraved
 Plaquettes en aluminium, gravées
 Placas en aluminio grabadas
 Targhette in alluminio incise



88-3202-99

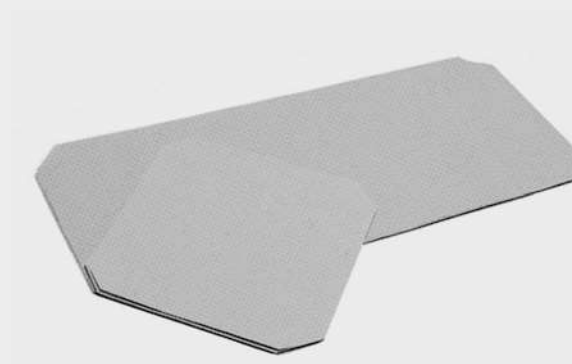

cm x cm		
30 x 30	88-3209-30	88-3300-30
60 x 30	88-3209-60	88-3300-60

Textilfilter für Container
 Textile Filters for Containers
 Filtres en tissu pour containers
 Filtros de tejido para containers
 Filtri in tessuto per container

Papierfilter für Container 1000 St.
 Paper Filters for Containers 1000 ea.
 Filtres en papier pour containers les 1000
 Filtros de papel para Containers 1000 c/u
 Filtri in carta per container 1000 pezzi

Steril-Container aus Aluminium
mit Papierfiltern,
naturfarbig eloxiert

Sterilization Containers from
Aluminium with paper filters,
anodized natural colour

Containers pour la stérilisation en
Aluminium avec des filtres en papier,
anodisés couleur nature

Containers para la esterilización de
Aluminio con filtros de papel,
anodizados color natural

Container per la sterilizzazione in
Alluminio con filtri in carta,
ossidati colore naturale

Deckel gelocht
Lid perforated
Couvercle perforé
Tapa perforada
Coperchio forato

1/1

88-3801-11
88-3801-12
88-3801-13
88-3801-14
88-3801-15

cm x cm x cm
58 x 28 x 10,0
58 x 28 x 13,5
58 x 28 x 15,0
58 x 28 x 20,0
58 x 28 x 26,0



Deckel und Boden gelocht
Lid and bottom perforated
Couvercle et fond perforés
Tapa y fondo perforados
Coperchio e corpo forati

1/1

88-3802-11
88-3802-12
88-3802-13
88-3802-14
88-3802-15

3/4

88-3803-11
88-3803-12
88-3803-13

cm x cm x cm
46,5 x 28 x 10,0
46,5 x 28 x 13,5
46,5 x 28 x 15,0



3/4

88-3804-11
88-3804-12
88-3804-13

1/2

88-3805-11
88-3805-12
88-3805-13
88-3805-14
88-3805-15

cm x cm x cm
28,5 x 28 x 10,0
28,5 x 28 x 13,5
28,5 x 28 x 15,0
28,5 x 28 x 20,0
28,5 x 28 x 26,0



1/2

88-3806-11
88-3806-12
88-3806-13
88-3806-14
88-3806-15

Deckel gelocht – mit Schutzdeckel
 Lid perforated – with safety lid
 Couvercle perforé – avec couvercle de sécurité
 Tapa perforada – con tapa de seguridad
 Coperchio forato – con coperchio protettivo



88-3811-11
 88-3811-12
 88-3811-13
 88-3811-14
 88-3811-15

cm x cm x cm
 58 x 28 x 10,0
 58 x 28 x 13,5
 58 x 28 x 15,0
 58 x 28 x 20,0
 58 x 28 x 26,0

Deckel und Boden gelocht – mit Schutzdeckel
 Lid and bottom perforated – with safety lid
 Couvercle et fond perforés – avec couvercle de sécurité
 Tapa y fondo perforados – con tapa de seguridad
 Coperchio e corpo forati – con coperchio protettivo



88-3812-11
 88-3812-12
 88-3812-13
 88-3812-14
 88-3812-15

Alle Container-Deckel und
 -Schutzdeckel auch
 lieferbar in den Farben:

All container lids and
 Safety lids also available in
 the colours:

Tous les couvercles et
 couvercles de sécurité
 Aussi livrables en les coloris:

Todas las tapas y tapas
 de seguridad se suministran
 También en los colores:

Tutti i coperchi e coperchi
 protettivi anche fornibili
 nei colori:

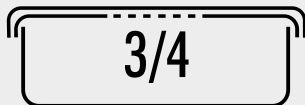

88-3813-11
 88-3813-12
 88-3813-13

cm x cm x cm
 46,5 x 28 x 10,0
 46,5 x 28 x 13,5
 46,5 x 28 x 15,0



88-3814-11
 88-3814-12
 88-3814-13

Bestell-Nummern siehe Seiten 88.16 - 88.17
 For ordering numbers see pp. 88.16 - 88.17
 Pour les nos. de cat., voir pages 88.16 - 88.17
 Por núms. de cat., véanse páginas 88.16 - 88.17
 Per numeri di cat., vedere pagine 88.16 - 88.17



88-3815-11
 88-3815-12
 88-3815-13
 88-3815-14
 88-3815-15

cm x cm x cm
 28,5 x 28 x 10,0
 28,5 x 28 x 13,5
 28,5 x 28 x 15,0
 28,5 x 28 x 20,0
 28,5 x 28 x 26,0



88-3816-11
 88-3816-12
 88-3816-13
 88-3816-14
 88-3816-15

Ersatzteile für diese Container siehe S. 88.24 · For spare parts for these containers, see p. 88.24 · Parties de rechange pour ces containers, voir p. 88.24
 Piezas de recambio para estos containers, véase p. 88.24 · Pezzi di ricambio per questi container, vedere p. 88.24

Steril-Container aus Aluminium
mit Papierfiltern,
eloxiert

Sterilization Containers from
Aluminium with paper filters,
anodized

Containers pour la stérilisation en
Aluminium avec des filtres en papier,
anodisés

Containers para la esterilización de
Aluminio con filtros de papel,
anodizados

Container per la sterilizzazione in
Alluminio con filtri in carta,
ossidati

**AUFBEWAHRUNG,
STERILISATION**

**STORAGE,
STERILIZATION**

**CONSERVATION,
STÉRILISATION**

**CONSERVACIÓN,
ESTERILIZACIÓN**

**CONSERVAZIONE,
STERILIZZAZIONE**

Deckel gelocht
Lid perforated
Couvercle perforé
Tapa perforada
Coperchio forato



Deckel und Boden gelocht
Lid and bottom perforated
Couvercle et fond perforés
Tapa y fondo perforados
Coperchio e corpo forati



Deckel gelocht – mit Schutzdeckel
Lid perforated – with safety lid
Couvercle perforé – avec couvercle de sécurité
Tapa perforada – con tapa de seguridad
Coperchio forato - con coperchio protettivo



Deckel und Boden gelocht – mit Schutzdeckel
Lid and bottom perforated – with safety lid
Couvercle et fond perforés – avec couvercle de sécurité
Tapa y fondo perforados – con tapa de seguridad
Coperchio e corpo forati – con coperchio protettivo



1/1

Container 60 x 28 cm

	x 10,0 cm	x 13,5 cm	x 15,0 cm	x 20,0 cm	x 26,0 cm
	88-3801-11	88-3801-12	88-3801-13	88-3801-14	88-3801-15
	88-3801-21	88-3801-22	88-3801-23	88-3801-24	88-3801-25
	88-3801-31	88-3801-32	88-3801-33	88-3801-34	88-3801-35
	88-3801-41	88-3801-42	88-3801-43	88-3801-44	88-3801-45
	88-3801-51	88-3801-52	88-3801-53	88-3801-54	88-3801-55
	88-3801-61	88-3801-62	88-3801-63	88-3801-64	88-3801-65

Container 60 x 28 cm

	x 10,0 cm	x 13,5 cm	x 15,0 cm	x 20,0 cm	x 26,0 cm
	88-3802-11	88-3802-12	88-3802-13	88-3802-14	88-3802-15
	88-3802-21	88-3802-22	88-3802-23	88-3802-24	88-3802-25
	88-3802-31	88-3802-32	88-3802-33	88-3802-34	88-3802-35
	88-3802-41	88-3802-42	88-3802-43	88-3802-44	88-3802-45
	88-3802-51	88-3802-52	88-3802-53	88-3802-54	88-3802-55
	88-3802-61	88-3802-62	88-3802-63	88-3802-64	88-3802-65

Container 60 x 28 cm

	x 10,0 cm	x 13,5 cm	x 15,0 cm	x 20,0 cm	x 26,0 cm
	88-3811-11	88-3811-12	88-3811-13	88-3811-14	88-3811-15
	88-3811-21	88-3811-22	88-3811-23	88-3811-24	88-3811-25
	88-3811-31	88-3811-32	88-3811-33	88-3811-34	88-3811-35
	88-3811-41	88-3811-42	88-3811-43	88-3811-44	88-3811-45
	88-3811-51	88-3811-52	88-3811-53	88-3811-54	88-3811-55
	88-3811-61	88-3811-62	88-3811-63	88-3811-64	88-3811-65

Container 60 x 28 cm

	x 10,0 cm	x 13,5 cm	x 15,0 cm	x 20,0 cm	x 26,0 cm
	88-3812-11	88-3812-12	88-3812-13	88-3812-14	88-3812-15
	88-3812-21	88-3812-22	88-3812-23	88-3812-24	88-3812-25
	88-3812-31	88-3812-32	88-3812-33	88-3812-34	88-3812-35
	88-3812-41	88-3812-42	88-3812-43	88-3812-44	88-3812-45
	88-3812-51	88-3812-52	88-3812-53	88-3812-54	88-3812-55
	88-3812-61	88-3812-62	88-3812-63	88-3812-64	88-3812-65

3/4

1/2

Container 46,5 x 28 cm			
	x 10,0 cm	x 13,5 cm	x 15,0 cm
	88-3803-11	88-3803-12	88-3803-13
	88-3803-21	88-3803-22	88-3803-23
	88-3803-31	88-3803-32	88-3803-33
	88-3803-41	88-3803-42	88-3803-43
	88-3803-51	88-3803-52	88-3803-53
	88-3803-61	88-3803-62	88-3803-63

Container 28 x 28 cm					
	x 10,0 cm	x 13,5 cm	x 15,0 cm	x 20,0 cm	x 26,0 cm
	88-3805-11	88-3805-12	88-3805-13	88-3805-14	88-3805-15
	88-3805-21	88-3805-22	88-3805-23	88-3805-24	88-3805-25
	88-3805-31	88-3805-32	88-3805-33	88-3805-34	88-3805-35
	88-3805-41	88-3805-42	88-3805-43	88-3805-44	88-3805-45
	88-3805-51	88-3805-52	88-3805-53	88-3805-54	88-3805-55
	88-3805-61	88-3805-62	88-3805-63	88-3805-64	88-3805-65

Container 46,5 x 28 cm			
	x 10,0 cm	x 13,5 cm	x 15,0 cm
	88-3804-11	88-3804-12	88-3804-13
	88-3804-21	88-3804-22	88-3804-23
	88-3804-31	88-3804-32	88-3804-33
	88-3804-41	88-3804-42	88-3804-43
	88-3804-51	88-3804-52	88-3804-53
	88-3804-61	88-3804-62	88-3804-63

Container 28 x 28 cm					
	x 10,0 cm	x 13,5 cm	x 15,0 cm	x 20,0 cm	x 26,0 cm
	88-3806-11	88-3806-12	88-3806-13	88-3806-14	88-3806-15
	88-3806-21	88-3806-22	88-3806-23	88-3806-24	88-3806-25
	88-3806-31	88-3806-32	88-3806-33	88-3806-34	88-3806-35
	88-3806-41	88-3806-42	88-3806-43	88-3806-44	88-3806-45
	88-3806-51	88-3806-52	88-3806-53	88-3806-54	88-3806-55
	88-3806-61	88-3806-62	88-3806-63	88-3806-64	88-3806-65

Container 46,5 x 28 cm			
	x 10,0 cm	x 13,5 cm	x 15,0 cm
	88-3813-11	88-3813-12	88-3813-13
	88-3813-21	88-3813-22	88-3813-23
	88-3813-31	88-3813-32	88-3813-33
	88-3813-41	88-3813-42	88-3813-43
	88-3813-51	88-3813-52	88-3813-53
	88-3813-61	88-3813-62	88-3813-63

Container 28 x 28 cm					
	x 10,0 cm	x 13,5 cm	x 15,0 cm	x 20,0 cm	x 26,0 cm
	88-3815-11	88-3815-12	88-3815-13	88-3815-14	88-3815-15
	88-3815-21	88-3815-22	88-3815-23	88-3815-24	88-3815-25
	88-3815-31	88-3815-32	88-3815-33	88-3815-34	88-3815-35
	88-3815-41	88-3815-42	88-3815-43	88-3815-44	88-3815-45
	88-3815-51	88-3815-52	88-3815-53	88-3815-54	88-3815-55
	88-3815-61	88-3815-62	88-3815-63	88-3815-64	88-3815-65

Container 46,5 x 28 cm			
	x 10,0 cm	x 13,5 cm	x 15,0 cm
	88-3814-11	88-3814-12	88-3814-13
	88-3814-21	88-3814-22	88-3814-23
	88-3814-31	88-3814-32	88-3814-33
	88-3814-41	88-3814-42	88-3814-43
	88-3814-51	88-3814-52	88-3814-53
	88-3814-61	88-3814-62	88-3814-63

Container 28 x 28 cm					
	x 10,0 cm	x 13,5 cm	x 15,0 cm	x 20,0 cm	x 26,0 cm
	88-3816-11	88-3816-12	88-3816-13	88-3816-14	88-3816-15
	88-3816-21	88-3816-22	88-3816-23	88-3816-24	88-3816-25
	88-3816-31	88-3816-32	88-3816-33	88-3816-34	88-3816-35
	88-3816-41	88-3816-42	88-3816-43	88-3816-44	88-3816-45
	88-3816-51	88-3816-52	88-3816-53	88-3816-54	88-3816-55
	88-3816-61	88-3816-62	88-3816-63	88-3816-64	88-3816-65

Steril-Container aus Aluminium
mit Papierfiltern,
eloxiert

Sterilization Containers from
Aluminium with paper filters,
anodized

Containers pour la stérilisation en
Aluminium avec des filtres en papier,
anodisés

Containers para la esterilización de
Aluminio con filtros de papel,
anodizados

Container per la sterilizzazione in
Alluminio con filtri in carta,
ossidati

**AUFBEWAHRUNG,
STERILISATION**

**STORAGE,
STERILIZATION**

**CONSERVATION,
STÉRILISATION**

**CONSERVACIÓN,
ESTERILIZACIÓN**

**CONSERVAZIONE,
STERILIZZAZIONE**

Ersatzteile für diese Container siehe S. 88.24 · For spare parts for these containers, see p. 88.24 · Parties de rechange pour ces containers, voir p. 88.24

Piezas de recambio para estos containers, véase p. 88.24 · Pezzi di ricambio per questi container, vedere p. 88.24

Container-Einzelemente
 Container System Elements
 Eléments du système container
 Elementos sueltos del sistema de contenedores
 Elementi del sistema di contenitori

Schutzdeckel
 Safety Lid
 Couvercle de sécurité
 Tapa de seguridad
 Coperchio protettivo

	1/1	3/4	1/2
	58 x 28 cm	46,5 x 30 cm	30 x 30 cm
	88-3865-11	88-3875-11	88-3885-11
	88-3865-21	88-3875-21	88-3885-21
	88-3865-31	88-3875-31	88-3885-31
	88-3865-41	88-3875-41	88-3885-41
	88-3865-51	88-3875-51	88-3885-51
	88-3865-61	88-3875-61	88-3885-61

Deckel perforiert mit Filter
 Lid perforated with filter
 Couvercle perforé avec filtre
 Tapa perforada con filtro
 Coperchio forato con filtro

	1/1	3/4	1/2
	58 x 28 cm	46,5 x 30 cm	30 x 30 cm
	88-3861-11	88-3871-11	88-3881-11
	88-3861-21	88-3871-21	88-3881-21
	88-3861-31	88-3871-31	88-3881-31
	88-3861-41	88-3871-41	88-3881-41
	88-3861-51	88-3871-51	88-3881-51
	88-3861-61	88-3871-61	88-3881-61

AUFBEWAHRUNG,
 STERILISATION

STORAGE,
 STERILIZATION

CONSERVATION,
 STÉRILISATION

CONSERVACIÓN,
 ESTERILIZACIÓN

CONSERVAZIONE,
 STERILIZZAZIONE

Boden ungelocht
 Bottom non perforated
 Fond non perforé
 Fondo sin perforar
 Corpo senza foratura

	1/1	3/4	1/2
h = cm	58 x 28 cm	46,5 x 30 cm	30 x 30 cm
10,0	88-3851-11	88-3853-11	88-3855-11
13,5	88-3851-12	88-3853-12	88-3855-12
15,0	88-3851-13	88-3853-13	88-3855-13
20,0	88-3851-14		88-3855-14
26,0	88-3851-15		88-3855-15

Boden gelocht mit Filter
 Bottom perforated with filter
 Fond perforé avec filtre
 Fondo perforado con filtro
 Corpo forato con filtro

	1/1	3/4	1/2
h = cm	58 x 28 cm	46,5 x 30 cm	30 x 30 cm
10,0	88-3852-11	88-3854-11	88-3856-11
13,5	88-3852-12	88-3854-12	88-3856-12
15,0	88-3852-13	88-3854-13	88-3856-13
20,0	88-3852-14		88-3856-14
26,0	88-3852-15		88-3856-15

flach
 flat
 plats
 llanos
 piatti

Mini

88-3887-11	88-3891-11
88-3887-21	88-3891-21
88-3887-31	88-3891-31
88-3887-41	88-3891-41
88-3887-51	88-3891-51
88-3887-61	88-3891-61



Deckel gelocht
Lid perforated
Couvercle perforé
Tapa perforada
Coperchio forato

Deckel und Boden gelocht
Lid and bottom perforated
Couvercle et fond perforés
Tapa y fondo perforados
Coperchio e corpo forati

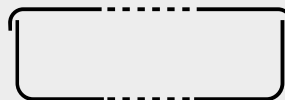
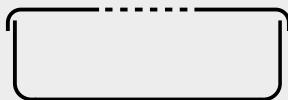

Container
flach - flat - plats -
llanos - piatti

28,5 x 28,0 cm

	x 5,5 cm	8,8 cm
■	88-3907-11	88-3907-12
■	88-3907-21	88-3907-22
■	88-3907-31	88-3907-32
■	88-3907-41	88-3907-42
■	88-3907-51	88-3907-52
■	88-3907-61	88-3907-62

	x 5,5 cm	8,8 cm
■	88-3908-11	88-3908-12
■	88-3908-21	88-3908-22
■	88-3908-31	88-3908-32
■	88-3908-41	88-3908-42
■	88-3908-51	88-3908-52
■	88-3908-61	88-3908-62

Flach-Container, Mini-Container
Flat Containers, Mini Containers
Containers plats et mini
Contenedores planos y mini
Contentitori piatti e mini



Deckel gelocht
Lid perforated
Couvercle perforé
Tapa perforada
Coperchio forato

Deckel und Boden gelocht
Lid and bottom perforated
Couvercle et fond perforés
Tapa y fondo perforados
Coperchio e corpo forati

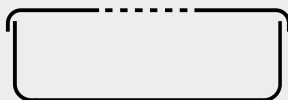

Mini Container

30,0 x 13,5 cm

	x 4,0 cm	7,0 cm	10,0 cm
■	88-3909-11	88-3909-12	88-3909-13
■	88-3909-21	88-3909-22	88-3909-23
■	88-3909-31	88-3909-32	88-3909-33
■	88-3909-41	88-3909-42	88-3909-43
■	88-3909-51	88-3909-52	88-3909-53
■	88-3909-61	88-3909-62	88-3909-63

	x 4,0 cm	7,0 cm	10,0 cm
■	88-3910-11	88-3910-12	88-3910-13
■	88-3910-21	88-3910-22	88-3910-23
■	88-3910-31	88-3910-32	88-3910-33
■	88-3910-41	88-3910-42	88-3910-43
■	88-3910-51	88-3910-52	88-3910-53
■	88-3910-61	88-3910-62	88-3910-63

Tragbarer Ständer für Mini-Container, komplett
Portable Rack for Mini Containers, complete
Porte-mini containers portable, complet
Estantería portátil para mini containers, completo
Supporto portabile per mini container, completo

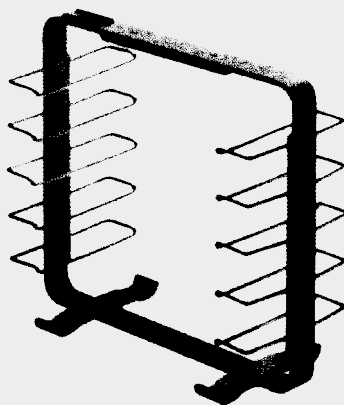

88-3940-00

Ersatzteile für diese Container siehe S. 88.24 · For spare parts for these containers, see p. 88.24 · Parties de rechange pour ces containers, voir p. 88.24
Piezas de recambio para estos containers, véase p. 88.24 · Pezzi di ricambio per questi container, vedere p. 88.24

Zubehör für Container
Accessories for Containers
Accessoires pour containers
Accesorios para containers
Accessori per container

AUFBEWAHRUNG,
STERILISATION

STORAGE,
STERILIZATION

CONSERVATION,
STÉRILISATION

CONSERVACIÓN,
ESTERILIZACIÓN

CONSERVAZIONE,
STERILIZZAZIONE

Spannrahmen für Sterilisiertücher
Cloth Fixing Frames
Cadres fixe-toile
Cuadros para fijar paños
Telai fissateli

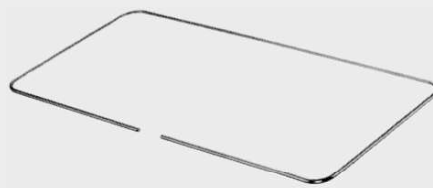

88-3942-00
545 x 255 mm

Spannrahmen für Sterilisiertücher
Cloth Fixing Frames
Cadres fixe-toile
Cuadros para fijar paños
Telai fissateli

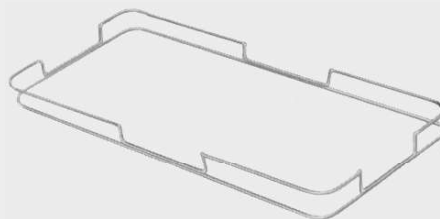

88-3944-00
545 x 255 x 30 mm

Siebboden für Container rostfrei
Wire Mesh Base for Containers Stainless Steel
Châssis de containers en treillis de fil inox
Base para containers de red de hilo inoxidable
Base per container in rete di filo inossidabile

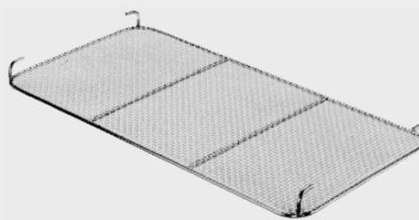

88-3946-00
545 x 255 x 30 mm

Container Trennwände aus Drahtgeflecht
Container Dividers from Stainless Steel Wire Mesh
Cloison séparative pour les containers en treillis de fil inox
Tabique para containers de red de hilo inoxidable
Divisori per container in rete di filo inossidabile

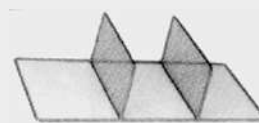

88-3948-00
510 x 250 x 130 mm
88-3949-00
510 x 250 x 180 mm

Container Trennwände aus Drahtgeflecht
Container Dividers from Stainless Steel Wire Mesh
Cloison séparative pour les containers en treillis de fil inox
Tabique para containers de red de hilo inoxidable
Divisori per container in rete di filo inossidabile



88-3950-00
510 x 250 x 130 mm
88-3951-00
510 x 250 x 180 mm

3/4

1/2

88-3942-03
405 x 255 mm



88-3942-05
255 x 255 mm

88-3944-03
405 x 255 x 30 mm

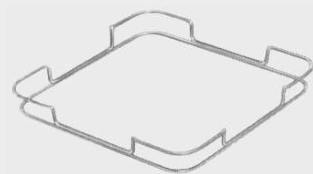

88-3944-05
255 x 255 x 30 mm

88-3946-03
405 x 255 x 30 mm

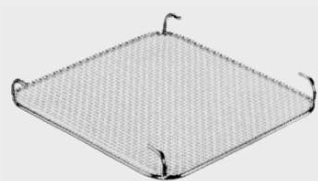

88-3946-05
255 x 255 x 30 mm

88-3948-03
405 x 250 x 130 mm
88-3949-03
405 x 250 x 180 mm

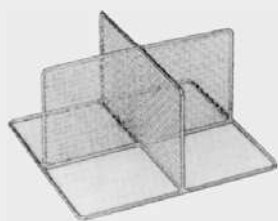

88-3952-05
255 x 250 x 130 mm
88-3953-05
255 x 250 x 180 mm

88-3950-03
405 x 250 x 130 mm
88-3951-03
405 x 250 x 180 mm

Zubehör für Container
Accessories for Containers
Accessoires pour containers
Accesorios para containers
Accessori per container

AUFBEWAHRUNG,
STERILISATION

STORAGE,
STERILIZATION

CONSERVATION,
STÉRILISATION

CONSERVACIÓN,
ESTERILIZACIÓN

CONSERVAZIONE,
STERILIZZAZIONE

Bohrdrahtspender
Wire Drill Dispensers
Distributeurs de broches KIRSCHNER
Distribuidores de taladros filiformes
Distributori di fili KIRSCHNER

AUFBEWAHRUNG,
STERILISATION

STORAGE,
STERILIZATION

CONSERVATION,
STÉRILISATION

CONSERVACIÓN,
ESTERILIZACIÓN

CONSERVAZIONE,
STERILIZZAZIONE

Rahmen zur Sterilisation und sterilen Lagerung von Bohrdrahtspendern
Racks for sterilization and sterile storage of Bone Drill Dispensers
Supports pour la stérilisation et la conservation stérile des distributeurs de broches
Soportes para la esterilización y el almacenaje estéril de los distribuidores de taladros
Telai per la sterilizzazione e la conservazione sterile dei distributori di fili KIRSCHNER

L = 17,5 cm
Für Bohrdrähte bis 16 cm
For wire drills up to 16 cm
Pour broches jusqu'à 16 cm
Para taladros filiformes hasta 16 cm
Per fili KIRSCHNER fino a 16 cm



88-4002-08 - 88-4002-30

ø mm	
0,8	88-4002-08
1,0	88-4002-10
1,2	88-4002-12
1,4	88-4002-14
1,5	88-4002-15
1,6	88-4002-16
1,8	88-4002-18
2,0	88-4002-20
2,2	88-4002-22
2,5	88-4002-25
3,0	88-4002-30

L = 32,0 cm
Für Bohrdrähte bis 31 cm
For wire drills up to 31 cm
Pour broches jusqu'à 31 cm
Para taladros filiformes hasta 31 cm
Per fili KIRSCHNER fino a 31 cm



88-4004-08 - 88-4004-30

ø mm	
0,8	88-4004-08
1,0	88-4004-10
1,2	88-4004-12
1,4	88-4004-14
1,5	88-4004-15
1,6	88-4004-16
1,8	88-4004-18
2,0	88-4004-20
2,2	88-4004-22
2,5	88-4004-25
3,0	88-4004-30



cm
23 x 6 88-4012-00

Köcher für HF-Elektroden Kunststoff autoklavierbar
Quiver for RF electrodes polypropylene autoclavable
Carquois pour les électrodes à HF en polypropylène stérilisable à l'autoclave
Carcaj para electrodos de AF de materia plástica esterilizable al autoclave
Faretra per elettrodi di AF in plastica sterilizzabile all'autoclave

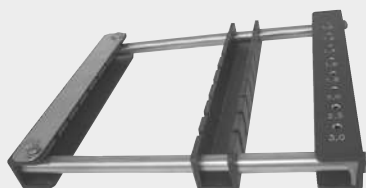

88-4005-98

für · for · pour · para · per
88-4002-08 - 88-4002-30

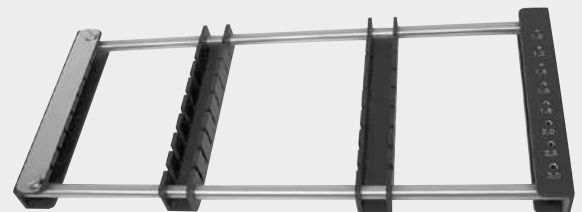

88-4005-99

für · for · pour · para · per
88-4004-08 - 88-4004-30

Instrumenten-Halter, klappbar
 Instrument Holder, Folding
 Cadre porte-instruments pliant
 Soporte para instrumentos plegable
 Supporto per strumenti pieghevole

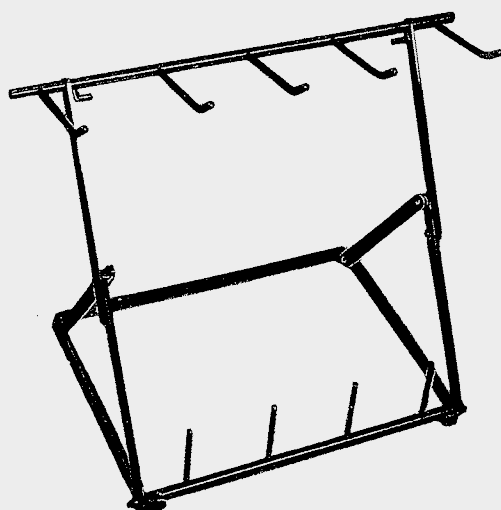

LORTAT-JACOB
 88-4016-00

AUFBEWAHRUNG,
 STERILISATION

STORAGE,
 STERILIZATION

CONSERVATION,
 STÉRILISATION

CONSERVACIÓN,
 ESTERILIZACIÓN

CONSERVAZIONE,
 STERILIZZAZIONE



88-5708-40

neodisher IP

Pflegespray für chirurgische Instrumente
 For the lubrication of surgical instruments
 Pour la lubrification d'instruments chirurgicaux
 Para la lubricación de instrumentos quirúrgicos
 Per la lubrificazione di strumenti chirurgici



Pflege- und Reinigungsmittel für chirurgische Instrumente
 Cleansing and lubricating agents for instruments
 Détersifs pour le nettoyage et l'entretien des instruments
 Detersivos para la limpieza y el mantenimiento de los instrumentos
 Detersivi per la pulizia e la lubrificazione degli strumenti

Lit.		
1	88-5720-00	neodisher IR
5	88-5725-00	neodisher IS

Grundreiniger für Instrumente aus rostfreiem Stahl
 Cleansing Agent for basic cleansing of instruments from stainless steel
 Détersif pour le nettoyage à fond des instruments en acier inoxydable
 Detersivo para la limpieza a fondo de los instrumentos de acero inoxidable
 Detersivo per la pulizia a fondo degli strumenti in acciaio inossidabile



Auswechselbare Filter
Exchangeable Filters
Filtres interchangeable
Filtros intercambiables
Filtri intercambiabili



Einmalgebrauch Papier (Packung = 100)
Single Use Paper (Package = 100 ea.)
Usage unique papier (les 100)
Monouso papel (100 c/u)
Carta monouso (100 pezzi)

88-5770-01
ø 185 mm

Textilgewebe (1 Strück)
Textile tissue (1 ea.)
Tissu en textile (la pièce)
tejido de textil (1 c/u)
Tessuto tessile (il pezzo)

88-5770-04
ø 185 mm

Ersatzteile und Zubehör für Container
Spare parts and Accessories for Containers
Parties de rechange et accessoires pour les containers
Repuestos y accesorios para containers
Accessori e ricambi per container



88-5770-03
23,6 x 11,8 mm

88-5770-06
22,0 x 11,8 mm



88-5780-00

Filterspender
Filtre Dispenser
Présentoir de filtres
Distribuidor de filtros
Distributore di filtri

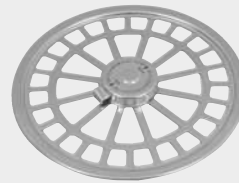

88-5785-00

Filterhalter für 1/1-, 3/4-, 1/2- und Flachcontainer
Filtre Holder for 1/1, 3/4, 1/2 and Flat Containers
Fixe-filtres pour les containers 1/1, 3/4, 1/2 et plats
Sujetafiltros para los containers 1/1, 3/4, 1/2 y planos
Fermafiltri per container 1/1, 3/4, 1/2 e piatti

AUFBEWAHRUNG,
STERILISATION

STORAGE,
STERILIZATION

CONSERVATION,
STÉRILISATION

CONSERVACIÓN,
ESTERILIZACIÓN

CONSERVAZIONE,
STERILIZZAZIONE

Papier-Etiketten für Container mit Indikator-Punkt
Paper Labels for containers with indicator dot
Étiquettes d'identification en papier avec indicateur chimique
Etiquetas de identificación de papel con indicador químico
Targhette in carta con indicatore chimico



88-5788-00

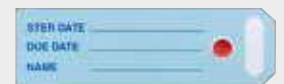

88-5789-00



88-5790-01



88-5790-02



88-5790-03

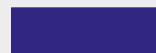

88-5790-04



88-5790-05



88-5790-06

88-5790-01 - 88-5790-06

Identifikations-Schilder für Steril-Container eloxiert in verschiedenen Farben, unbeschriftet
Identification Plates for sterilization containers anodized in different colours, neutral
Plaquettes d'identification en aluminium anodisées en différents coloris, neutres
Placas de identificación para containers de aluminio anodizadas en varios colores, neutras
Targhette d'alluminio anodizzate in vari colori, neutre

88-5790-99

Beschriftung der Schilder 88-5790-01 – 88-5790-06 mit Texten nach Angabe, Beschriftungsfeldgröße 45 x 13 mm
Inscription of identification plates 88-5790-01 to 88-5790-06 as ordered, field size 45 x 13 mm
Gravure des plaquettes d'identification nos. 88-5790-01 à 88-5790-06 selon indication, champ de gravure 45 x 13 mm
Incidión de las placas núms. 88-5790-01 a 88-5790-06 según indicación, tamaño del campo grabado 45 x 13 mm
Incidione delle targhette d'identificazione con un testo ordinato, dimensione del campo inciso 45 x 13 mm

HF-CHIRURGIE

RF-SURGERY

CHIRURGIE HF

CIRUGÍA AF

CHIRURGIA AF

Ohne Anschlussbuchse · without receptacle · sans borne de connexion · sin enchufe · senza connettore

Monopolare Koagulationspinzetten
 Monopolar Coagulation Forceps
 Pincés à coagulation monopolaire
 Pinzas de coagulación monopolar
 Pinze da coagulazione monopolare

HF-CHIRURGIE

RF SURGERY



cm	
18,0	92-0402-18
21,0	92-0402-20
25,0	92-0402-25



cm	
18,0	92-0410-18
21,0	92-0410-20
25,0	92-0410-25



cm	
16,0	92-0415-16
18,0	92-0415-18
20,0	92-0415-20

CHIRURGIE HF

CIRURGÍA AF

CHIRURGIA AF

Mit Anschlussbuchse · with receptacle · avec borne de connexion · con enchufe · con connettore

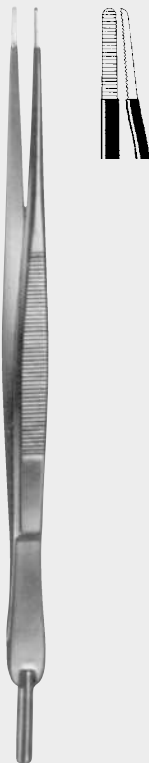

cm	
14,5	92-0420-14
18,0	92-0420-18
20,0	92-0420-20
25,0	92-0420-25
30,0	92-0420-30



cm	
14,5	92-0430-14
18,0	92-0430-18
20,0	92-0430-20
25,0	92-0430-25
30,0	92-0430-30



cm	
14,0	92-0435-14
16,0	92-0435-16
20,0	92-0435-20

ZEPF[®]

 INSTRUMENTS

92-0435-20

92.2



gerade
straight
droites
rectas
diritte

X	7 cm	11 cm	15 cm	16 cm	18 cm	20 cm	22 cm	24 cm
0,25 mm	92-1002-07	92-1002-11						
0,30 mm			92-1003-15	92-1003-16	92-1003-18	92-1003-20	92-1003-22	92-1003-24
0,45 mm	92-1004-07							
0,60 mm		92-1006-11						
1,00 mm		92-1010-11	92-1010-15	92-1010-16	92-1010-18	92-1010-20	92-1010-22	92-1010-24
2,00 mm			92-1020-15	92-1020-16	92-1020-18	92-1020-20	92-1020-22	92-1020-24

Bipolare Koagulationspinzetten
Bipolar Coagulation Forceps
Pinces à coagulation bipolaire
Pinzas de coagulación bipolar
Pinze da coagulazione bipolare

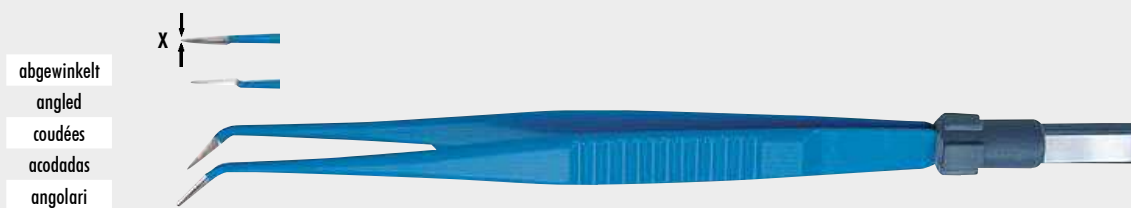

abgewinkelt
angled
coudées
acodadas
angolari

X	7 cm	11 cm	15 cm	16 cm	18 cm	20 cm	22 cm	24 cm
0,25 mm	92-1102-07	92-1102-11						
0,30 mm			92-1103-15	92-1103-16	92-1103-18	92-1103-20	92-1103-22	92-1103-24
0,45 mm	92-1104-07							
0,60 mm		92-1106-11						
1,00 mm		92-1110-11	92-1110-15	92-1110-16	92-1110-18	92-1110-20	92-1110-22	92-1110-24
2,00 mm			92-1120-15	92-1120-16	92-1120-18	92-1120-20	92-1120-22	92-1120-24

HF-CHIRURGIE

RF SURGERY

CHIRURGIE HF

CIRURGÍA AF

CHIRURGIA AF

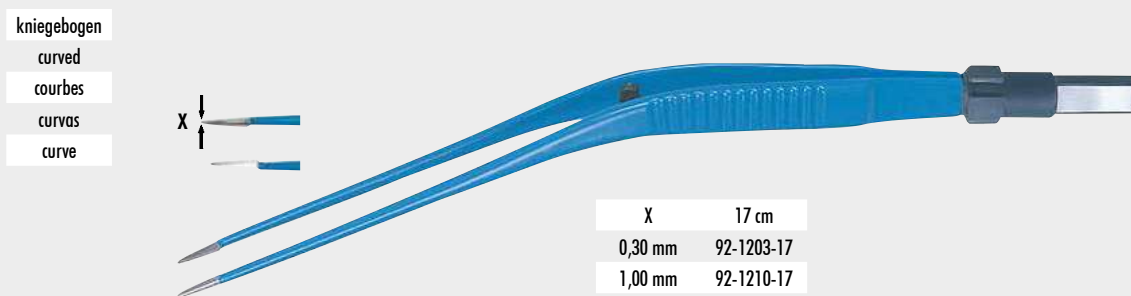

kniegebogen
curved
courbes
curvas
curve

X	17 cm
0,30 mm	92-1203-17
1,00 mm	92-1210-17
2,00 mm	92-1220-17

Bipolare Koagulationspinzetten
Bipolar Coagulation Forceps
Pinces à coagulation bipolaire
Pinzas de coagulación bipolar
Pinze da coagulazione bipolare

bajonettförmig gerade
bayonet shape straight
forme baïonnette droites
forma bayoneta rectas
forma baionetta diritte



X	16 cm	18 cm	20 cm	22 cm	24 cm
0,30 mm	92-1303-16	92-1303-18	92-1303-20	92-1303-22	92-1303-24
1,00 mm	92-1310-16	92-1310-18	92-1310-20	92-1310-22	92-1310-24
2,00 mm	92-1320-16	92-1320-18	92-1320-20	92-1320-22	92-1320-24

HF-CHIRURGIE

RF SURGERY

CHIRURGIE HF

CIRURGÍA AF

CHIRURGIA AF

bajonettförmig aufwärts gewinkelt
bayonet shape angled up
forme baïonnette coudées vers le haut
forma bayoneta acodadas hacia arriba
forma baionetta angolari in alto



X	18 cm	20 cm	22 cm	24 cm
0,30 mm	92-1403-18	92-1403-20	92-1403-22	92-1403-24
1,00 mm	92-1410-18	92-1410-20	92-1410-22	92-1410-24
2,00 mm	92-1420-18	92-1420-20	92-1420-22	92-1420-24

bajonettförmig abwärts gewinkelt
bayonet shape angled down
forme baïonnette coudées vers le bas
forma bayoneta acodadas hacia abajo
forma baionetta angolari in basso

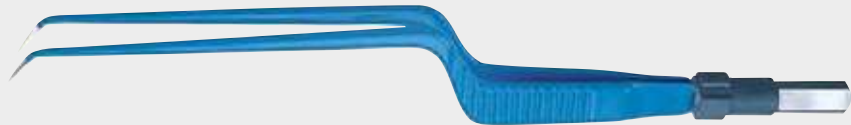

X	18 cm	20 cm	22 cm	24 cm
0,30 mm	92-1503-18	92-1503-20	92-1503-22	92-1503-24
1,00 mm	92-1510-18	92-1510-20	92-1510-22	92-1510-24
2,00 mm	92-1520-18	92-1520-20	92-1520-22	92-1520-24

Stecker - Plugs - fiches - clavijas - spine

Bipolare Anschlusskabel
 Bipolar Connection Cords
 Cordons à coagulation bipolaire
 Cables para coagulación bipolar
 Cavi da coagulazione bipolare

Geräteseitig
 Generator Side
 Côté générateur
 Lado generador
 Lato generatore

Instrumenteseitig
 Instrument Side
 Côté instrument
 Lado instrumento
 Lato strumento

Erbe



3 m	5 m
92-1581-30	92-1581-50

HF-CHIRURGIE

Aesculap GK 55, GK 60,
 Berchtold,
 Martin



3 m	5 m
92-1582-30	92-1582-50

RF SURGERY

CHIRURGIE HF

CIRURGÍA AF

CHIRURGIA AF

HF-CHIRURGIE

RF SURGERY

CHIRURGIE HF

CIRURGÍA AF

CHIRURGIA AF

HF-CHIRURGIE

RF SURGERY

CHIRURGIE HF

CIRURGÍA AF

CHIRURGIA AF

HF-CHIRURGIE

RF SURGERY

CHIRURGIE HF

CIRURGÍA AF

CHIRURGIA AF

ALFABETISCHES INHALTSVERZEICHNIS

ALPHABETICAL INDEX

INDEX ALPHABÉTIQUE

ÍNDICE ALFABÉTICO

INDICE ALFABETICO



Alphabetisches Inhaltsverzeichnis

A	
Abnehmer für Skalpellklingen	06.05
Abortus Kürette	72.06
Abortus Löffel	72.06, 72.07
ABRAHAM Tonsillen Messer	50.04
ABRAMS Pleura Biopsie Nadel	22.04
Abstütz Platten	36.22, 36.23
Abwurfweimer fahrbar	88.04
Adenotome	46.28
ADLERKREUTZ Pinzetten	10.05
ADSON (FRASIER) Arterienklemme	12.13
ADSON Baby (CONE) Wundsperrer	18.34
ADSON Baby Arterienklemme	12.13
ADSON Bohrerführungs- und Duraschutz Zange	40.04
ADSON Dura Haken	40.06
ADSON Elevatorien	32.49
ADSON Hemilaminektomie Spreizer	18.32, 18.33, 18.35
ADSON Hohlmeißel Zangen	32.04
ADSON Hypophysen Pinzetten	40.09
ADSON Nadelhalter	24.06
ADSON Pinzetten	10.03, 10.04
ADSON Saugrohre	40.15
ADSON Wundsperrer	18.31, 18.32
AEBLI Hornhaut Schere	08.08
Aesthesiometer	02.11
ALAN PARKS Kaltlicht Adapter	68.03
ALAN PARKS Rektal Spekulum	68.03
ALBARRAN Nadel	26.03
ALBEE Fräser	33.09
ALDERDYCE Dissektor	32.56
ALEXANDER Meißel	32.34
ALEXANDER Raspatorien	32.47
ALEXANDER Uterus Biopsie Zange	70.25
Alkohol Spender	88.04
ALLEN Kinder Darm Klemme	64.05
ALLIS ADAIR Fasszange	64.02
ALLIS Baby Fasszange	64.02
ALLIS Darm Fasszangen	64.02
ALLISON Lungen Spatel	56.12
ALLPORT Wundsperrer	18.27
ALM Wundsperrer	18.26
ALVIS Fremdkörper Kürette	42.06
Amniotom	70.21
Amputations Messer	06.10
Amputations Retraktoren	33.02
Amputations Sägen	33.02
Anal Spektula	68.05
Anastomosen Klemmen	12.29, 56.15, 56.16, 64.10
ANDERSON ADSON Wundsperrer	18.30
ANDREW Zungen Drücker	48.03
Aneurysmen Nadel	26.02
ANKENEY Rippen Sperrer	56.09
ANKENEY Sternum Sperrer	56.09
Anlege und Abnahme Zange für Gehirnklemmen	40.04
Anlegezange für Bulldog Klemmen	12.02
Anoskope	68.05
Anschluss Kabel bipolar	92.06
Antrum Küretten	46.26
Antrum Raspeln	46.20, 46.22
Aorta Haken	56.13
Arachnoidea Messer	42.02
ARCHER Splitterzange	10.13
Arkansas Abziehstein	06.13
ARLT Draht Schlingen	42.09
Army Gaze Schere	08.20
ARRUGA Extraktions Haken	42.07
ARRUGA Kapsel Pinzetten	43.04
ARRUGA Nadelhalter	24.09, 24.10
ARRUGA Wund Löffel isoliert	42.09
Arterien Haken	40.05
Arterienklemmen grazil	12.08
ASCH Septum Richtzange	46.25
Aspirations Küretten	70.36
Atrauma Pinzetten	11.03, 11.04, 11.06
Atrauma Titan Pinzetten	11.04
Atrium Haken	56.11
AUFRANC Cobra Knochenhebel	32.54
AUFRICHT Nasen Haken	46.25
AUFRICHT Nasen Raspeln	46.20, 46.21
AUFRICHT Nasenrücken Haken	46.24
Augen Kanülen	43.08
Augen Magnet	43.09
Augen Nadelhalter	24.09 - 24.12

Augen Pinzetten	42.12 - 42.18
Augen Trephinen	43.08, 43.09
Aurikel Klemmen	56.16
Auszieher für flexible Markraumnägel	34.10
Autopsie Besteck	32.39
Autopsie Hammer	32.44
AXENFELD Chalazion Löffel	42.08
AYER Chalazion Pinzette	43.06
AYRE Konus Messer	70.29

B	
BABCOCK Darmfuss Zängchen	64.03
BABINSKY Hammer	02.10
Baby Arterienklemme	12.13, 12.15
BACKHAUS KOCHER Tuchklemme	14.02
BACKHAUS Tuchklemmen	14.02
BACON Hohlmeißel Zange	32.05
BADGLEY Laminektomie Sperrer	56.06
BAGGISH Biopsie Zange	70.28
BAILEY GIBBON Rippen Kontraktor	56.12
BAILEY Rippen Kontraktoren	56.12
BAINBRIDGE Arterienklemmen	12.22
BAKES Gallenstein Sonden	62.03
BALFOUR Baby Bauchdeckenhalter	18.46
BALFOUR Bauchdeckenhalter	18.45, 18.46
BALFOUR US Bauchdeckenhalter	18.47
BALLENGER Schwingmesser	46.14
BALLENGER Septum Elevatorium	46.17
Band Spanner	32.22
Bandmaß	02.12
Bandscheiben Sperrer	18.62, 18.64
Bandscheiben Stanzten	40.21, 40.22
Bandscheibenbruch Küretten	32.29
BANE Hohlmeißel Zangen	32.04
BANGERTER Muskel Klemmen	43.07
BANGERTER Zyklodialyse Spatel	42.09
BARANY Lärntrommel	44.05
BARBARA Nadeln	44.17
BARBARA Picks	44.17, 44.18
BARKAN Goniotomie Messer	42.06
BARNHILL Ring Messer	46.27
BARON (SCHUKNECHT) Saugrohr	44.06
BARR Rektal Spekulum	68.03
BARRAQUER Cilien Pinzette	43.10
BARRAQUER Colibri Iris Pinzette	42.15
BARRAQUER Colibri Iris Schere	09.02
BARRAQUER Colibri Sperr Elevatoren	42.02
BARRAQUER Fixier Pinzette	43.03
BARRAQUER KATZIN Iris Pinzette	42.15
BARRAQUER Keratoplastik Messer	42.06
BARRAQUER Nadelhalter	24.10
BARRAYA Pinzette	10.09
BARRETT Haken Zange	70.18
BARRON Haemorrhoidal Ligatur	68.09
BARRON Skalpellgriff	06.02
BARTELHEIMER Knochenbiopsie Kanüle	22.04
BARTH Ohr Löffel	32.32
BARTON Geburts Zange	72.03
BARTON Zughebel für Geburtszange	72.03
Batteriegriffe für Laryngoskope	04.06
Bauchdecken Haken	18.18, 18.19, 18.22, 18.59
Bauchdecken Halter	18.43 - 18.60
Bauchspatel	18.05, 18.22
Bauchstich Trokar	22.02
BAUMGARTNER Nadelhalter	24.03
BEACHAM Amniotom	70.21
Becken Rekonstruktions Platte	36.14
Becken Zirkel	72.05
BECKER Cystotom	42.07
BECKMANN EATON Wundsperrer	18.33
BECKMANN FISCH Wundsperrer	18.29
BECKMANN Nasen Spekulum	46.03
BECKMANN Ring Messer	46.27
BECKMANN Wundsperrer	18.33
BEEBEE Scheren	08.19
BEER Cilien Pinzette	43.10
BEESON Gips Spreizer	30.04
BELLUCCI Schere mikro Ohr	44.11
BENGOLEA Arterienklemmen	12.12
BENNETT Knochenhebel	32.52
BENSAUDE Anoskope	68.05
BENSON Pylorus Spreizer	64.04
BERENS Lanzten Messer	42.04
BERENS Muskel Klemme	43.07

BERENS Vorlagerungs Pinzette	43.07
BERGER Biopsie Zange	70.28
BERGMANN Hämmer	32.41
BERGMANN Wundhaken	18.26
BERKE Muskel Pinzetten	43.02
BERLINER Hammer	02.11
BERNHARD (STAUDE) Tuchklemme	14.04
BERTILLO Messzirkel	02.11
BERTRAM Tuchklemme	14.03
BEST Darm Klemmen	64.09
BETHUNE Rippen Schere	56.02
BEUSE Schere	08.09
BEYER Hohlmeißel Zangen	32.05, 32.07
BEYER Stanze	46.12
Biegebolzen für Bohrdrähte	34.13
Biegehebel für Marknägel	34.10
Biegeschablonen für Knochenplatten	33.22
Biegevorrichtung für Knochenplatten	33.22
Biegezange für Knochenplatten	33.21
BIER Lumbal Punktions Kanüle	22.04
BILL Zughebel für Geburts Zangen Standard Griff	72.04
BILLEAU Ohr Schlingen	44.08
BILLROTH Haken Zange	70.19
BINKHORST Pinzette	42.18
Biopsie Stanze	70.26
Biopsie Zangen	68.07, 70.24 - 70.28
Bipol Kabel	92.06
Bipol Pinzetten	92.04 - 92.05
BIRCHER GANSKE Knochen Haltezangen	32.19
BIRCHER Meniskotome	32.58
BIRKETT Art.Klemme	12.14
BISHOP HARMAN Iris Pinzetten	42.17
BLAKE Gallenstein Zangen	62.02
BLAKE Kürette	70.31
BLASCOVICS Vorlagerungs Pinzette	43.02
Blasen Spatel	66.03
Blasen Sperrer	66.03, 66.04
Blasenhalss Sperrer	66.04
Blattwechsel Pinzette	18.39
Bleihände	32.22
Blinddarm Klemme	64.04
BLOHMKE Tonsillen Fasszange	50.05
BLOUNT Einschläger für Knochen Klammern	34.12
BLOUNT Einsetzer Knochen Klammern	34.12
BLOUNT Extraktor für Knochen Klammern	34.12
BLOUNT Knie Haken	32.56
BLOUNT Knochenhebel	32.56
BLUMENTHAL Hohlmeißel Zangen	32.03
Blutdruckmesser	02.02 - 02.04
Blutstillungs Meißel	44.19
BODENHAMMER Rektal Spektula	68.02
BOEHLER Extensionbügel	33.12
BOEHLER Hohlmeißel Zangen	32.08
BOEHLER Knochen splitter Zange	32.14
BOERMA Geburts Zange	72.04
BOETTCHER Tonsillen Klemme	12.15
BOETTCHER Tonsillenschere	08.10
Bohrapparate	33.04 - 33.08
Bohrbüchsen	33.25, 33.26, 34.02, 34.04
Bohrdraht Spender	88.22
Bohrdraht Stuetzen	33.05
Bohrdrähte	33.10
Bohrer	33.04 - 33.09, 33.22
Bohrer durchbohrt	33.22
Bohrer Fingernagel	33.03
Bohrerführung für Hüftschrauben	34.08
Bohrerführungs- und Duraschutz Zange	40.05
Bohrlehre für Plattenspanner	34.02
Bohrwinde	33.05
BONACCOLTO Strabismus Pinzette	42.16
Bonn Iris Häkchen	42.07
Bonn Iris Pinzetten	42.17
Bonn Spül Kanüle	43.08
BONNEY Pinzetten	10.05 - 10.06
BORCHARDT Fräser	33.09
BOSE Tracheal Häkchen	54.03
BOSE Tracheal Sperrer	54.02
BOUCHERON Ohrtrichter	44.02
Bougies Harnröhre	66.06
BOWLES Stethoskop	02.09
BOWMAN Disziations Messer	42.05
BOWMAN Disziations Nadeln	42.06
BOWMAN Sperr Elevator	42.02
BOWMAN Tränenkanal Sonden	42.12

BOYNTON Nadelhalter	24.09	CASPAR Sperrer	18.39	COLLYER Becken Zirkel	72.05
BOZEMANN (WERTHEIM) Nadelhalter	24.06	CASPAR Sperrer für cervicale Wirbelsäule	18.39	Columella Klemme	46.26
BOZEMANN DOUGLAS Schwamm Zange	16.06	CASPAR Spiralbohrer	18.41	COLVER Tonsillen Fasszangen	50.04
BOZEMANN FRITSCH Katheter	70.35	CASPAR Treppe Osteosynthese Platte	36.24	Conchotom	46.10
BOZEMANN Schwamm Zangen	16.05	CASPAR Wirbelkörper Distraktor	18.41	CONE Schädel Stanze	40.07
BRAITHWAITE Dermatome	06.12	CASPAR Zange Laminektomie	40.19, 40.20	CONE Ventrikel Nadeln	40.16
BRAND Sehnen Durchzug Zangen	32.23	CASTANEDA Rippen Sperrer	56.06	CONE Wundsperrer	18.34
BRAUN Dekapitations Haken	72.08	CASTROVIEJO Fixier Pinzette	43.03	CONNIN AMSLER Markier Instrum.	42.11
BRAUN Haken Zange	70.18	CASTROVIEJO Hornhaut Schere	09.03	Container, Sterilisier-	88.11 - 88.19
BRAUN Hakenzange	70.20	CASTROVIEJO Kapsel Pinzette	43.04	CONTOUR Skalp Sperrer	18.30
BRAUN Kraniooklast	72.07	CASTROVIEJO Klängenbrecher 8 mm	06.07	CONVERSE Nasenflügel Haken	46.25
BRAUN Scheiden Halter	70.11	CASTROVIEJO Lanzen Messer	42.04	CONVERSE Nasenplastik Messer	46.14
BRAUN Scheiden Spekulum	70.11	CASTROVIEJO Markier Instrument	42.11	COOLEY Atrauma Pinzetten	11.03
BRAUN SIMPSON Geburts Zange	72.02	CASTROVIEJO Markier Instrumente	42.11	COOLEY Gefäß Dilatatoren	56.17
BREISKY Spektula	70.13	CASTROVIEJO Nadelhalter	24.11, 24.12	COOLEY Haken Atrium	56.11
BRIDGE Klemmen	12.20	CASTROVIEJO Naht Pinzette	43.05	COOLEY Saugrohr	04.03
BRISTOW Raspatorium	32.46	CASTROVIEJO SCHACHAR Markier Instrument	42.11	COOPER Nadel	26.02
BROCK Nadelhalter	24.12	CASTROVIEJO Sperr Elevator	42.03	CORDES Zangen Aufsatz	52.03
BRODIE Sonde biegsam	20.02	CASTROVIEJO Tränenkanal Dilatatoren	42.12	CORWIN Tonsillen Kompressorium	50.06
Broncho-Oesophagoskopie Zangen	52.04	CASTROVIEJO Trepphine	43.08	CORYLLOS (Thorax) Wundhaken	18.20
Bronchus Klemmen	56.13, 56.14	CASTROVIEJO Zydodialyse Spatel	42.09, 42.10	CORYLLOS Rippen Schere	56.02
BROPHY Pinzetten	10.08	CAWOOD MINNESOTA Wangen Halter	48.04	COS Drahtbiege Zängchen Ohr	44.12
BROWN Nadelhalter	24.03	Cerebellum Retraktor	18.30	COTTLE Applikations Instrument	46.23
BROWN Pinzette	10.04	Cerebellum Sperrer	18.61	COTTLE Columella Klemme	46.26
BRUENINGS BRUNN Kieferhöhlen Haken	46.29	Chalazion Löffel	42.08	COTTLE Haken	46.24, 46.25
BRUENINGS Nasen Zangen scharf	46.08	Chalazion Pinzette	43.06	COTTLE Hammer	32.40
BRUENINGS Ohrspektula	44.03	CHAMPEAU Kanülen	22.06	COTTLE Haut Fasspinzette	46.26
BRUENINGS Septatom	46.15	CHANCE Arterienklemmen	12.09	COTTLE KAZANIAN Knochensplitter Zange	32.13
BRUENINGS Verlängerungs Rohre	52.03	CHANDLER Iris Pinzetten	42.13	COTTLE Meißel Nasenplastik	46.18
BRUENINGS Zungen Spatel	48.02	CHAPUT Arterienklemme	12.11	COTTLE Nasen Rospel	46.21
BRUNETTI Wirbelsäulen Meißel	32.38	CHARNLEY Horizontal Spreizer	18.35	COTTLE Nasen Spekulum	46.04
BRUNNER Darm Klemmen	64.09	CHARNLEY Pinzette	10.11	COTTLE Nasenflügel Haken	46.25
BRUNNER Führungshohlsonde	26.04	CHARNLEY Wundspreizer	18.64	COTTLE Nasenflügel Schützer	46.25
BRUNNER Ligatur Nadel	26.03	CHARRIERE Amputations Sägen	33.03	COTTLE Nasenplastik Messer	46.14
BRUNNER Rippen Schere	56.03	CHEATLE Sterilisierzange	28.02	COTTLE Nasenschere	08.09
BRUNNER Wundhaken	18.20	CHELSEA EATON Anal Spekulum	68.05	COTTLE NEIVERT Haken	46.24
BRUNS scharfe Löffel	32.26 - 32.28	CHERON Tupfer Zange	16.05	COTTLE Periost Elevatorium	46.17
BRUNS Verband Schere	08.21	CHEVALIER DE BOER Rippen Sperrer	56.11	COTTLE Quetscher	46.23
Bruststich Trakare	22.03	CHEVALIER JACKSON Zangen	52.04	COTTLE Septum Elevatorien	46.16
Bruststütze für Laryngoskope	52.06	CHEVRET Bauchspatel	18.05	COVENTRY Klammern	36.25
BÜCHS Wangen- und Weichteilehaken	18.23	CHILDE Wundrand Fasspinzette	26.07	COXETER Katheter Prostata	66.07
BUCHWALD Zungen Spatel	48.02	Chirurgie Handmotor	33.07	CRAFOORD (STELZNER) Schere	08.16
BUCK GRAMCKO Hohlmeißel	32.34	Cholezystektomie Klemmen	12.24	CRAFOORD Bronchusklemmen	12.18
BUCK Hammer	02.11	Cilien Pinzetten	43.10	CRAIG Septum und Yomer Zange	46.07
BUCK Hebel Fremdkörper	44.10	CINELLI Nasenplastik Meißel	46.19	Creto Hornhaut Habel	74.04
BUCK Ligatur Scheren	08.18	Circumcisions Geräte	66.05	CRILE Arterienklemmen	12.05
BUCK Ohr Kürretten	44.07	Circumcisions Instrumente	66.05	CRILE MURRAY Nadelhalter	24.03
BUCK Ohr Messer	44.08	CITELLI Stanzten	46.11	CRILE Nadelhalter	24.07
BUJELAU Trokar Brustraum	22.03	CLAR Stirnlampe	02.05 - 22.06	CRILE Nerv Häkchen	40.05
BUIE Saug Kanüle	68.06	CLARK Sperr Elevatoren	42.02	CRILE RANKIN Arterienklemmen	12.06
Bulbus Ring	42.18	CLAYMAN Pinzette	42.18	CRILE WOOD Nadelhalter	24.03
Bulldog Klemme Atrauma	12.02	CLEVELAND Hohlmeißel Zangen	32.02	CRILE Wundhaken	18.03
BUMM Uterus Kürretten	70.32	CLEVELAND Knochensplitter Zangen	32.13	CRITCHETT Sperr Elevator	42.02
BUNGE Exenterations Löffel	42.08	Clip Anlegezangen	40.02, 40.03	CRUTCHFIELD Schädel Halter	40.04
BUNNELL Bohraparat	33.06	CLOWARD HOEN Sperrer	18.43	CRUTCHFIELD Vorbohrer	40.04
BUNNELL Sehnenstripper	32.59	CLOWARD Wirbelkörper Spreizer	40.16	CULLEN Anastomosen Klemme	12.28
BUNNELL Sonde biegsam	32.59	CLOWARD Wundsperrer	18.36, 18.37	CULLEN Hysterektomie Klemme	12.28
BUNT Sterilisier Klammer	28.02	COAKLEY Antrum Kürretten	46.26	CULLER Iris Spatel	42.09
BURCH Fixier Gabel	42.06	COBB Elevator spinal	32.52	CUSCO Scheiden Spektula	70.03 - 70.05
BURFORD FINOCHIETTO Rippen Sperrer	56.05	COBB Spinal Elevator	32.52	CUSHING Arterien Haken	40.05
BURKE Biopsie Stanze	70.26	COBB Spinal Löffel scharf	32.30	CUSHING Arterienklemme	12.07
Bürstenspender	74.05	COBB Spinal Meißel	32.37	CUSHING Dura Haken	40.05
BUSCH Nabelschnur Schere	08.14	COBBET Dermatome	06.12	CUSHING Flachbohrer	33.05
		Cobra Knochenhebel	32.54	CUSHING Hirn Spatel	40.15
C		CODIVILLA Schlüsselbein Zangen	32.21	CUSHING KOCHER Wundhaken	18.14
CAIRNS Arterienklemmen	12.06	COLCLOUGH Bandscheiben Stanzten	40.22	CUSHING LANDOLT Spekulum Hypophysektomie	40.23
CAMPBELL Harnröhren Bougies	66.07	Colibri Iris Pinzette	42.15	CUSHING Nerv Haken	40.05
CANFIELD Tonsillen Messer	50.04	Colibri Iris Schere	09.02	CUSHING Pinzetten	10.05
CANNY RYALL Wundhaken	18.22	Colibri Sperr Elevatoren	42.02	CUSHING Raspatorien „Little Jaker“	32.46
CAPLAN Septum Schere	46.11	COLLIN Arterienklemmen	12.11	CUSHING Wundhaken	18.09
CARMALT Splitterpinzette	10.12	COLLIN Bauchdeckenhalter	18.57	CUSHING Zangen Laminektomie	40.17
CAROLL Sehnen Fasszange	32.24	COLLIN DUVAL Pinzette	10.06	CUZZI Abortus Löffel	72.06
CARPENTER Tonsillen Messer	50.03	COLLIN Dynamometer	02.05	Cystikus Haken	68.06
CARREL Gefäß Klemme	12.03	COLLIN Hammer	32.40	Cystotome	42.07
CARTON Schleimhaut (gyn.) Absauger	70.30	COLLIN HARTMANN Wundhaken	18.04	CZERNY Haken Zange	70.20
CASPAR Bohrerführung	18.41	COLLIN Nabelschnur Klemme	72.05	CZERNY Rektal Spekulum	68.02
CASPAR Distraktions Schraube	18.41	COLLIN Pinzette	10.06	CZERNY Wundhaken	18.04
CASPAR Distraktor	18.41	COLLIN Rippen Schere	56.02		
CASPAR Gegensperrer	18.38, 18.42	COLLIN Scheiden Spektula	70.03		
CASPAR Häkchen für Exploration u. Koagulation	40.26	COLLIN Skalpellgriff	06.03		
CASPAR Laminektomie Sperrer	18.40	COLLIN Tupferzange	16.04	D	
CASPAR Mikro Skalpellgriff	06.08	COLLIN Uterus Fasszange	70.21	DALE Hohlmeißel Zangen	32.12
CASPAR Rongeur	40.19, 40.20	COLLIN Uterus Kürretten	70.35	DANDY Mosquito Arterien Klemmen	12.09
CASPAR Schraubendreher	18.41	COLLIN Uterus Sonde	70.22	DANDY Nerven Haken	40.05
CASPAR Spekulum	18.42	COLLIN Wundhaken	18.02	DANDY neurochirurgische Schere	08.15
		COLLIN Zungen Zangen	48.04	DANIELS Tonsillotome	50.08
		COLLINGWOOD Hernia Klemme	66.05	DANIS Draht Spannzange	33.13

Alphabetisches Inhaltsverzeichnis

Alphabetisches Inhaltsverzeichnis

DARLING Wundsperrer	18.34	DOYEN Hohlsonde	20.02	Excenter Verband Schere	08.21
Darm Fasszangen	64.02, 64.03	DOYEN JANSEN (MOLT) Mundsperrer	48.04	Excisions Klemme	64.09
Darm Klemmen	64.04 - 64.12	DOYEN Kugel Fräser	33.09	Exenterations Löffel	42.08
Darm Scheren	08.16	DOYEN Myom Heber	70.29	Extensionbügel	33.12
Darmfass Pinzette	10.10	DOYEN Nadelhalter	24.03	Extraktions Meissel	42.06
Darmnadeln	26.06	DOYEN Raspatorien	32.47	Extraktions Haken	42.07
DARTIGUES Uterus Fasszange	70.21	DOYEN Rippen Raspatorien	32.47	Extraktions Haken für Marknägel	33.19
DASTOOR Strabismus Pinzette	42.16	DOYEN Scheiden Spekula	70.10	Extraktions Zangen für Bohrdrähte	33.14
DAUBENSPECK scharfe Löffel	32.27	DOYEN Schere	08.13		
DAVIDSON (Scapula) Wundhaken	18.21	DOYEN STILLE Wundhaken	18.22	F	
DAVIS BOYLE Mundsperrer	48.07	DOYEN Tuchklemmen	14.04	Faden Führer für Hypophysektomie	40.26
DAVIS Dura Dissektor	40.08	DOYEN Uterus Polypen Zange	70.20	Faden Führungs Zange	66.02
DAVIS Fremdkörper Nadel	42.06	DOYEN Zungen Halter	48.02	Faden Pinzette	43.05
DAVIS MEYER Mundsperrer	48.09	DRAFFIN Bipod für Mundsperrer	48.11	Faden Pinzette	26.04
DAVIS Pinzette für Spritzen und Kanülen	28.02	Draht Bearbeitungszangen	33.14 - 33.18	Fadengabel	26.04
DAY Ohr Häkchen	44.09	Draht Sägen	40.06	Fadenpinzette	26.07
DE BAKY DIETRICH Pinzetten	11.04	Draht Schere	08.19	FAHLBUSCH Löffel	40.25
DE BAKY Gefäß Dilatatoren	56.17	Draht Schlingen	42.09	FALCONER Hohlmeißel Zange	32.07
DE BAKY Nadelhalter	24.04	Draht Spannzange	33.13	FARABEUF COLLIN Raspatorien	32.45
DE BAKY Saugrohr	04.02	Draht Umföhrungsinstrumente	33.13	FARABEUF Knochen Haltezange	32.15
DE LEE Becken Zirkel für Innen Messung	72.05	Drahtbiege Zängchen Ohr	44.12	FARABEUF LAMBOTTE Knochen Haltezangen	32.15
De LEE Geburts Zange	72.02	Drahtspanner	33.13	FARABEUF Raspatorium	32.45
De LEE HILLIS Stethoskop	02.09	Dreieck Zielplatten	34.05, 34.06	FARABEUF Wundhaken	18.02
De MARTEL Umföhrungsinstrument	40.06	Druckklemmen	12.09	Farb Kodier Band	88.10
DEAN Iris Messer	42.05	DUBOIS Schere	08.13	FARR Wundspreizer	18.26
DEAN Tonsillenschere	08.09	DUBOST Rippen Sperrer	56.10	FARREL Watteträger	20.06
DEAVER Schere	08.03	DUEHRSEN Pinzette	10.10	FARRIOR Ohrspekula	44.02
DEAVER Wundhaken	18.06, 18.07	DUNHILL Arterienklemmen	12.06	Fasszange bei Biopsie	68.07
DEBAKEY Atrauma Pinzetten	11.03, 11.04, 11.06	DUPLAY Haken Zange	70.18	Fasszange für Glans und Vorhaut	66.05
		DUPLAY Kornzange	16.06	Fasszangen Darm, Gewebe, Organ	64.02 - 64.04
DEBAKEY Bulldog Klemme Atrauma	12.02	DUPLAY Nasen Spekula	46.02	FAURE Peritoneum Klemme	12.27
DEBAKEY Femur Wundspreizer	18.56	DUPUY DUTEMPS Tränensack Sperrer	42.03	FAURE Uterus Biopsie Zange	70.24
DEBAKEY Gefäß Schere	08.11	DUPUY WEISS Tonsillen Nadeln	50.03	FAVALORO Gefäß Schere	08.12
DEBAKEY Rippen Sperrer	56.07	Dura Dissektoren	40.07, 40.08	FAVALORO MORSE Rippen Sperrer	56.09
DEBAKEY Wundspreizer für Femur	18.56	Dura Elevatorien	40.09	FEATHERSTONE Mundsperrer	48.05
DEJERINE Hammer	02.10	Dura Häkchen	18.07	Federhäkchen	18.08, 18.25
Dekapitations Haken	72.06	Dura Haken	40.05	FEHLAND Darm Klemme	64.09
DeMARTEL WOLFSON Anastomosen Klemmen	64.10	Dura Messer	40.08	FEILCHENFELD Splitterpinzetten	10.12
DeMARTEL WOLFSON Schließ Zange	64.10	Dura Schere	08.15	Feilen	32.59
DEMEL Draht Spannzange	33.13	Dura Separator	40.08	FEIN Watteträger	20.06
DEMEL Draht Umföhrungsnadeln	33.13	DURANTE Pinzetten	10.07	Femur Platte anatomisch	36.21
DENHART Mundsperrer	48.05	DURHAM Wundhaken	18.22	FERGUSSON ACKLAND Mundsperrer	48.05
DENIS BROWNE Pinzette	10.09	DUVAL Fasszängchen	64.03	FERGUSSON Angiotrieb	12.09
DENNIS BROWNE Bauchdeckenhalter	18.49	DUVAL Pinzette	10.06	FERGUSSON Gallen Stein Löffel	62.04
DERF Nadelhalter	24.02	Dynamische Hüft Platten	36.08	FERGUSSON Knochen Haltezange	32.15
Dermatome	06.11 - 06.12	Dynamische Hüft Schrauben	36.09	FERGUSSON Schere	08.06
DERRA Anastomosen Klemmen	56.16	Dynamometer	02.05	FERGUSSON Schere	40.21
D'ERRICO Bohrer	33.05			FERRIS SMITH KERRISON Bandscheiben Stanzen	10.05
DESCHAMPS Nadeln	26.02	E		FERRIS SMITH Pinzetten	40.18
DESJARDINS Gallenstein Löffel	62.04	EATON BECKMANN Wundsperrer	18.34	FERRIS SMITH Zange Laminektomie	12.07
DESJARDINS Gallenstein Sonden	62.03	ECHLIN Hohlmeißel Zangen	32.10	FICKLING Arterienklemmen	64.09
DESJARDINS Gallenstein Zangen	62.02	EDNA Tuchklemmen	14.03	FINCH Klemme	64.09
DESMARRES Lidhalter	18.08	Ein- und Ausschläger für flexible Markraumnägel	34.10	Finger Extensions Hülsen	33.12
DESMARRES Choleazion Pinzette	43.06	Ein- und Ausschläger für Marknägel	33.18	Finger Repositions Zange	32.21
DESMARRES Wundhaken	18.08	Ein- und Ausschlaginstrument	34.04	Finger Säge	33.03
DEUTSCHMANN Star Messer	42.04	Einföhrer für flexible Makraumnägel	34.10	Finger Schutz	48.12
DeWILBISS Schädelzange	40.07	Einmal Skalpelle steril	06.06	Fingernagel Bohrer	33.03
DEWEY Geburts Zange	72.04	Einschläger für DHS Schrauben	34.07	Fingerring Säge	33.03
Diagnostikbesteck	02.08	Einschläger für Klammern	34.12	Fino Scheren	08.05
Diamant Drahtschneider	33.16	Einschläger für Schenkelhalsnägel	34.11	FINOCHIETTO Baby Rippen Sperrer	56.04
DICK Atrauma Anastomosen Klemme	12.28	Einschlaginstrument für Winkelplatten	34.05	FINOCHIETTO BURFORD Rippen Sperrer	56.05
DIEFFENBACH Gefäß Klemme	12.03	EISELSBERG MATHIEU Nadelhalter	24.08	FINOCHIETTO Infant Rippen Sperrer	56.05
DIETER Stanzen Hammerkopf	44.13	Elektroden monopolar	92.02	FINOCHIETTO Nadelhalter	24.06
DIETRICH Nadelhalter	24.09	Elevatorien	32.46, 32.49	FINOCHIETTO Rippen Sperrer	56.04, 56.05
DIETRICH Pinzetten	11.04	Elevatorien, Ohr	44.19	FINSEN Wundsperrer	18.26
DIETRICH Schere	08.11	ELLIOT Geburts Zangen	72.02	FINSTERER Saugrohr	04.03
Dilatations Katheter	66.07	ELLIOT Trepshinen	43.09	FISCH Dissektoren	44.18
Dilatatoren Uterus	70.14 - 70.17	ELLIS Fremdkörper Hohlmeißel	42.06	FISCHER ARLT Iris Pinzette	42.15
DINGMAN Mundsperrer	48.10	ELSCHNIG Fixier Pinzette	43.03	FISCHER Iris Pinzette	42.15
DINGMAN Knochen Haltezangen	32.19	ELSCHNIG Hornhaut Messer	42.05	FISCHER Tonsillen Messer und Dissektor	50.04
Direkt Messlehre für DHS	34.07	ELSCHNIG Kapsel Pinzette	43.04	FISH Ohrsonde	20.02
Dissektor	20.02, 32.56	ELSCHNIG Zykodialyse Spatel	42.09	Fistel Haken	70.29
Distractions Klammer	32.22	EMMET Fistel Haken	70.29	Fistelschere	08.13
Distractions Schraube	18.41	EMMET Tupfer Zange	16.06	Fistelsonde (Krypthaken)	68.06
Diszisions Messer	42.05	Endo Spekula für Laser Chirurgie	70.13	Fixier Gabel	42.06
Diszisions Nadeln	42.06	Enukleation Löffel	42.09	Fixier Kralle	42.07
DITTEL Harrnröhren Bougies	66.06	Enukleations Schere	08.09	Fixier Pinzetten	43.03
DIX Fremdkörper Flachmeißel	42.06	Epiphysen Klammern	36.25	FLETCHER (JAVERTS) Schwammzugen	16.04
DIX Nadel und Meißel	42.10	Episiotomie Scheren	08.14	FLEURANT Trokar	22.02
Doppel Löffel scharf	32.31 - 32.32	Eppendorfer Biopsie Zange	70.28	FLIERINGA Bulbus Ringe	42.18
DOUGLAS Cilien Pinzette	43.10	ESMARCH Gips Messer	30.04	FLUHRER Kugelsonde Zinn	20.02
DOUGLAS Trokarkanüle	22.02	ESMARCH Verband Schere	08.20	FOERSTER Iris Pinzetten	42.14
DOYEN Baby Darm Klemmen	64.05	Etui Stahl	88.02	FOERSTER Schwamm Zangen	16.03
DOYEN Bauchdecken Haken	18.18, 18.59	EYES Tonsillen Schnürer	50.06	FOMON Meissel	46.18
DOYEN Darm Klemmen	64.05	EWALD (HUDSON) Pinzette	10.03, 10.04	FOMON Nasen Raspel doppelt	46.21
DOYEN Fixationsbügel	18.59			FOMON Nasen Raspeln	46.22
DOYEN Hämmer	32.41				

FOMON Nasenflügel Haken	46.24
FORD BOWLES Stethoskop	02.09
FORD Stethoskop	02.09
FOREGGER Laryngoskope	04.06
FOX Lupus Küretten	74.02
FRAENKEL Kehlkopf Polypen Zange	52.02
FRAENKEL Zangen Aufsatz	52.03
FRANCESCHETTI Trephinen	43.08
FRANCIS Fremdkörper Nadel	42.06
FRANKLIN SILVERMANN Nadeln	22.05
Fräser	33.04 - 33.10
Fräser für DHS Schrauben	34.08
FRASIER Arterienklemmen	12.13
FRAZIER Dura Elevatorium	40.09
FRAZIER Häkchen	18.07
FRAZIER Punktions Kanülen	40.16
FRAZIER Saug Kanülen	40.15
FRAZIER Saugrohre isoliert	40.16
FRAZIER Wundspreizer	18.44
FREER Hohlmeißel	46.20
FREER Mukosa Messer	46.14
FREER Saug Elevatorium	46.29
FREER Schleimhaut Häkchen	46.24
FREER Septum Elevatorium	46.16
FREER Septum Meißel	46.17
FREER Septum Messer	46.14
Fremdkörper Hebel	44.10
Fremdkörper Kürette	42.06
Fremdkörper Meißel	42.06
Fremdkörper Nadeln	42.06
Fremdkörper Zangen	66.04
FRENZEL Zungen Spatel	48.02
FREUND Alkohol Spender	88.04
FRIEDMAN Hohlmeißel Zangen	32.02
FRIEDMAN Sperrer Perineorrhaphie	70.13
FRITSCH Wundhaken	18.17
FRYKHOLM Hohlmeißel Zangen	32.10
FUCHS Kapsel Pinzette	43.04
FUCHSIG Arterienklemme	12.14
Führungs Stab für Markraum Bohrer	34.09
Führungshohlsonden	26.03, 26.04
Führungsnadeln	04.04
Führungsspieße für Marknägel	33.19

G

Gabel Haken	18.24
GABRIEL Rektal Spekulum	68.05
Galea Haken	40.04
GALLAHER Antrum Raspeln	46.22
Gallenkanal Klemmen	12.20 - 12.23
Gallenstein Löffel	62.02, 62.04
Gallenstein Sonden	62.02, 62.03
Gallenstein Zangen	62.02
GARRETT Gefäß Dilatatore	56.18
GAST Zungenspatel	48.09
Gaumen Nadeln	50.03
Gaumenbogen Haken	50.02
GAUSS Kopfschwarten Zange	72.05
Geburts Haken	72.05
Geburts Löffel	72.07
Geburts Zangen	72.02 - 72.04
Gefäß Dilatatore	56.17, 56.18
Gefäß Dissektoren	56.18
Gefäß Kanüle	22.04
Gefäß Klemme Atrauma	12.02
Gefäß Klemmen	12.02, 12.03
Gefäß Messer	40.29
Gefäß Scheren	08.10 - 08.12, 08.15, 09.04
Gefäß Stripper	20.04, 20.05
Gefäß-, Coronar-Schere	08.10
Gegensperrer	18.38, 18.42
GEISSENDÖRFER Klemmen	12.16
GELLHORN Uterus Biopsie Zange	70.25
GELPI Perineal Sperrer	18.56
Gemini Klemmen	12.17
GERALD Pinzetten	10.08
GERSTER Distractions Klammer	32.22
GERZOG Hammer	32.40
Gewebe Fasszangen	12.11, 64.02, 64.03
Gewebe Schutzhülse	33.24
Gewebe Schutzhülsen	33.26
Gewinde Bohrer 3,5 - 4,5 - 7,0 mm	33.23
Gewindeschneider	33.08

Gewindeschneider für DHS Schrauben	34.07
GIERTZ STILLE Rippen Schere	56.03
GIFFORD JANSEN Wundsperrer	18.27
GIGLI Draht Säge	40.06
GIGLI Griff für Drahtsäge	40.06
GIL VERNET Wundhaken	18.09
GILL ARRUGA Kapsel Pinzette	43.0343.04
GILL Hornhaut Messer	42.05
GILL Iris Pinzetten	42.14
GILLIES (FRENCH) Osteotom	32.34
GILLIES Häkchen	46.25
GILLIES Nadelhalter mit Schere	24.09
GILLIES Pinzetten	10.07
Gips Messer	30.04
Gips Sägen	30.02, 30.03
Gips Sägen elektrisch	30.03
Gips Scheren	08.21, 30.02
Gips Spreizer	30.04
Gipsabreiß Zangen	30.04
GIRARD Naht Pinzette	43.05
Glas Dosen mit Deckel	88.03
Glas Schalen mit Deckel	88.02
GLASER Laminektomie Spreizer	18.64
GLASER Spreizer Laminektomie	18.64
GLOVER Gefäß Klemme Atrauma	12.02
GLUCK Rippen Schere	56.02
GOELET Wundhaken	18.04
GOLDMAN FOX Zahnfleisch Schere	08.18
GOLDSMITH Nasen Spekula	46.02
GOLIGHER Schere	08.16
Goniotomie Messer	42.06
GOOD Tonsillenschere	08.10
GOODELL Uterus Dilatorator	70.17
GORNEY Schere	08.04
GOSSET Bauchdeckenhalter	18.44
GOURDET Uterus Löffel	70.31
GRADLE Cilien Pinzette	43.10
GRAEFFE Cystotome	42.07
GRAEFFE Fixier Pinzetten	43.03
GRAEFFE Häkchen	18.07
GRAEFFE Iris Pinzette	42.12
GRAEFFE Pinzette	10.05
GRAEFFE Schiel Haken	42.07
GRAEFFE Skarifikateur	42.04
GRAEFFE Star Löffel	42.08
GRAEFFE Star Messer	42.04
GRAHAM Nerv Haken	40.05
GRAVE Scheiden Spekula	70.02, 70.06
GRAY Gallenkanal Klemmen	12.24
GREEN ARMYTAGE Klemm Zange	72.05
GREEN Fixier Pinzetten	43.03
GREEN Hornhaut Dissektor	42.06
GREEN Muskel Haken	42.07
GREEN Wundhaken	18.16
GREVEN Drahtbiege Zängchen Ohr	44.12
Griff für Drahtsäge	40.06
Griffe für Kehlkopfspiegel	52.07
Grip-Zange	33.14
GROSS MAIER Kornzangen	16.02
GROSS MAIER Schwammzangen	16.02
GROSS Ohrlöffel und Haken	44.08
GRUBER Ohrtrichter	44.02
GRJENWALD Nasen Pinzette	46.05
GUILLEN Spül Kanüle	46.29
GULEKE Hohlmeißel Zange	32.05
GUNNAR HEY Rollen Klemme	12.32
GUTHRIE Doppelhäkchen	18.07
GUYON Harnröhren Bougies	66.06
GUYON Katheter Spanner	66.05
GUYON Nierenstielklemmen	12.24
GUYTON LUNDGAARD Sklerotom	42.06

H

HABERER (TUFFIER) Spatel	18.05
HABERER Spatel	18.05
HACKSTOCK Flachzange mit Rille	33.15
Haemorrhoidal Ligatoren	68.09, 68.10
Haemorrhoidal Saugligatur	68.10
Haemorrhoiden Zangen	68.08
HAGLUND STILLE Gips Spreizer	30.04
HAIGHT Rippen Sperrer	56.06
HAJEK BALLENGER Septum Elevatorium	46.17
HAJEK CLAUD Kieferhöhlen Stanze	46.12
HAJEK Hammer	32.41
HAJEK Hohlmeißel	46.20

HAJEK KOFLER Stanzen	46.11
HAKANSSON Hohlmeißel Zange	32.04
Häkchen scharf zur Kontrolle	33.25
Häkchen, Ohr	44.18
Haken Nägel für Markraum Nagelung	36.02
Haken Zangen	70.17 - 70.20
HALLE Dura Messer	40.08
HALLE scharfe Löffel	32.29
HALLE Septum Elevatorium	46.16
HALSEY Nadelhalter	24.02
HALSTED Mosquito Klemmen	12.04
Halswirbel Platte	36.24
Halteklammern für Plättchen	33.25
Haltezange für kleine Platten	33.21
Hamburg Knopf Kanüle	43.08
Hämmer	32.40 - 32.44
Hammer rückschlagfrei	32.40
Hammerkopf Stanzen	44.13
Handbohrapparat mit Jacobs-Futter	33.06
Handbohrfutter längsdurchbohrt	33.06
Handgriff mit Jacobs-Futter	33.06
Handmotor chirurgisch	33.07
Handstück mit Dentalkupplung	33.08
Handstück mit Schnellkupplung	33.08
Handwasch Bürste sterilisierbar	74.05
HANK Uterus Dilatatore	70.16
HARDY Dissektoren	40.24
HARDY Enudeatoren	40.24
HARDY FAHLBUSCH Dissektoren	40.24
HARDY Küretten	40.24
HARKNS Aurikel Klemmen	56.16
HARMS Trabekulotomie-Sonden	42.12
Harnröhren Bougies	66.06 - 66.08
HARRINGTON Bronchus Klemmen	56.13
HARRINGTON Wundhaken	18.07
HARTMANN Arterienklemme	12.03 - 12.30
HARTMANN HALLE Nasen Spekula	46.02
HARTMANN HALLE Spekulum	46.02
HARTMANN HARTMANN Arterienklemme	12.03
HARTMANN Hohlmeißel Zange	32.06
HARTMANN Nasen Zange scharf	46.10
HARTMANN Nasenpolypen Zangen	46.06
HARTMANN Ohr Katheter	44.07
HARTMANN Ohr Zängchen	44.10, 44.11
HARTMANN Ohrtrichter	44.02
HARTMANN Stimmgabeln	44.04
HARTMANN Tonsillen Zangen	50.08
HARTMANN WULLSTEIN Ohrzängchen	44.11
HARTMANN Zungen Drücker	48.02
HARVEY Schere Draht	08.19
HATFIELD Spinal Löffel scharf	32.30
HAUGH Ohrzängchen	44.12
Haut Fasspinzette	46.25
Haut Häkchen	74.02
Haut Scheren	74.04
Haut Stanzbesteck	74.03
Haut Trephinen	74.03
HAWKIN AMBLER Uterus Dilatorator	70.16
HEANEY (HEGAR) Nadelhalter	24.05
HEANEY Hysterektomie Klemmen	12.30
HEANEY Uterus Biopsie Kürette	70.24
HEANEY Wundhaken	18.19
HEATH Ligatur Schere	08.18
HEBRA Chalazion Löffel	42.08
HEGAR Nadelhalter	24.04, 24.05
HEGAR Uterus Dilatatore	70.14
HEGENBARTH Wundklammer Pinzette	26.07
HEIFETZ Hirn Spatel	40.15
HEIFETZ Pinzette	11.05
HEIMING Nierenstein Zangen	62.06
HEISS Arterienklemmen	12.13
HEISTER Mundsperrer	48.05
HELFERICH BIER Amputations Säge	33.02
Hemilaminektomie Spreizer	18.32
HENKE Tonsillen Elevatorium	50.02
HENLY Wundsperrer	18.31
HENNER (LEMPERT) Wundsperrer	18.29
HENNIG Gips Spreizer	30.04
HENROTIN Haken Zange	70.20
Heparin Nadel	22.04
HERBERHOLD Zungenspatel	48.10
Hernia Klemme	66.05
HERRICK Nierenstielklemme	12.25
HERTZLER Rippen Sperrer	56.11
HERZ Sehnen Fasszangen	32.25
HESS Iris Pinzetten	42.14
HESS Kapsel Pinzetten	43.04

Alphabetisches Inhaltsverzeichnis

Alphabetisches Inhaltsverzeichnis

HEY GROVES Knochen Haltezange	32.17	IRWIN MOORE Septum Zange	46.08	Kapsel Fasszangen	66.02
HEYMANN KNIGHT Nasenzange	46.06	ISRAEL Wundhaken	18.16	Kapsel Pinzetten	43.03
HEYMANN Nasen Zangen scharf	46.08	ITARD Ohr Katheter	44.07	Kapsel Stanze	42.11
HEYMANN Nasenschere	08.09	ITERSON Tracheal Häkchen	54.02	Katheter Einführer	04.04
HEYWOOD SMITH Haemorrhoiden Zange	68.08	IVES FANSLER Anoskop	68.05	Katheter Einführzange	04.04
HF Chirurgie	92.02 - 92.06			Katheter Metall Frauen	66.07
HF Elektroden	92.02			Katheter Metall Männer	66.06
HF Elektroden Köcher	88.22			Katheter Prostata	66.07
HIBBS Meißel	32.38			Katheter Spanner	04.04, 66.05
HIBBS Osteotome	32.38	J		KATZIN Hornhaut Schere	09.03
HIBBS Valven	18.63	JACKSON	54.03	Kauter	42.09
HIBBS Wundhaken	40.06	JACKSON BURROWS Knieweichteile Sperrer	18.31	Kehldeckel Halter	52.02
Hirn Spatel	40.15	JACKSON Gewebe Fasszange	64.03	Kehlkopf Aufsätze auswechselbar für Zangen	52.03
Hirnmesser	06.13	JACKSON Kropf Wundsperrer	18.27	Kehlkopf Polypen Zangen	52.02
HIRSCHMANN Anoskop	68.05	JACKSON Scheiden Spekulum	70.10	Kehlkopf Spiegel	52.07
HIRSCHMANN Iris Haken	42.07	JACKSON Tampon Pinzette	52.02	Kehlkopf Zangen Aufsätze	52.03
HIRSCHMANN Zyklodialyse Spatel	42.10	JACKSON Tracheal Häkchen	54.02	KELLY Arterienklemmen	12.05, 12.15
HOEN CLOWARD Sperrer	18.43	JACKSON Tracheal Kanülen	54.03	KELLY GRAY Uterus Biopsie Küretten	70.23
HOEN Dura Elevatorien	40.09	JACOBS Haken Zangen	70.19	KELLY Praktoskop	68.05
HOEN Raspatorium	32.52	JACOBSON Gefäß Messer	40.29	KELLY RANKIN Arterienklemmen	12.05
HOESEL Nadelhalter	24.08	JACOBSON Knopf Sonde	40.27	KELLY Schere	08.13
HOESEL Wundhaken	18.17	JACOBSON micro Klemme	12.14	KELLY Uterus Polypen Zange	70.20
HOFER Gaumenbogen Haken	50.02	JACOBSON scharfe Löffel	32.32	KELLY Wundhaken	18.05, 18.18
HOFF Tuchklemmen	14.03	JAEGER Lanzen Messer	42.04	Keratoplastik Messer	42.06
Hohlmeißel Zangen	32.02 - 32.12	JAEGER Lid Platte	42.03	KERBOUL Humerus Epicondylar Platte	36.22
Hohlsschraube	36.11	JAMESON Messschieber	42.11	KERBOUL Proximal Humerus Platte	36.22
Hohlsonden	20.02, 26.04	JAMESON Muskel Klemme	43.07	KERBOUL Radius Platte	36.22
HOHMANN Knochenheber	32.53, 32.55	JAMESON Schere	08.07	KERBOUL Tibia Platte	36.22
HOKE Meißel	32.37	JAMESON Schiel Haken	42.07	KERN Knochen Haltezangen	32.16
HOLTH Kapsel Stanze	42.11	JAMESON Strabismus Pinzetten	42.16	KERPPEL scharfe Löffel	32.27
HOLZBACH Bauchdeckenhalter	18.58	JAMISON Nadelhalter	24.05	KERRISON Stanzten	46.11
HOPKINS Gips Messer	30.04	JANSEN Doppel Löffel scharf	32.31	KEVORKIAN (YOUNGE) Uterus Biopsie Zange	70.26
HORGAN Mittelblatt	18.46	JANSEN GIFFORD Wundsperrer	18.27	KEVORKIAN Eppendorfer Biopsie Zange	70.28
Hornhaut Dissektor	42.06	JANSEN Hohlmeißel Zangen	32.05, 32.06	KEVORKIAN Pacific Biopsie Zange	70.27
Hornhaut Hobel	74.04	JANSEN Nasen Pinzette	46.05	KEVORKIAN Uterus Biopsie Küretten	70.23
Hornhaut Messer	42.05	JANSEN Ohr Pinzetten	44.09	KEY Elevatorien	32.50
Hornhaut Schaber	42.06	JANSEN Raspatorium	32.46	KEYES Haut Stanzbesteck	74.03
Hornhaut Scheren	08.05, 09.02,	JANSEN STRUYCKEN Septum Zange	46.12	KEYES Haut Trephinen	74.03
	9.03	JANSEN Wundsperrer	18.27	Kieferhöhlen Haken	46.29
	43.08, 43.09	JARCHO Haken Zange	70.18	Kieferhöhlen Kanülen	46.13
Hornhaut Trephinen	43.08, 43.09	JATHO Nasenrachsen Zange scharf	46.26	Kieferhöhlen Trokare	22.02
HOUSE Küretten	44.18	JAVERTS Schwammzangen	16.04	KIELLAND Geburts Zange	72.02
HOWARTH Elevator	32.50	JEANS Pinzetten	10.06	KIELLAND LUIKART Geburts Zangen	72.03
HRYNYSCHAK Prostata Sperrer	66.03	JENNINGS Wundsperrer	48.06	KILLIAN CLAUD Hohlmeißel	46.20
HUBER Universal Griff	52.03	JEWETT Ein- und Ausschläger	34.11	KILLIAN Septum Elevatorien	46.17
HUDSON Bohrwinde komplett	33.05	JEWETT Harnröhren Bougies	66.08	KILLIAN Septum Schere	46.11
HUDSON Pinzette	10.03	JEWETT Schenkelhals Nägel	36.08	KILLIAN Septum Spekula	46.04
Hüft Bohrbüchse	34.04	JOBSON HORNE Watteträger	20.06	KILLIAN Spül Kanüle	46.13
Hüft Platten dynamisch	36.08	JOHNS HOPKINS Gefäß Klemme	12.03	KILNER DOUGHTY Wundsperrer	48.08
Hüft Schrauben dynamisch	36.09	JOHNSON Nadelhalter	24.06	KILNER Haut Häkchen	74.02
HUMBY Dermatam	06.12	JOLL Schildrüsens Sperrer	54.04	KILNER Nadelhalter	24.03
Humerus Platte epicondylar	36.22	JONES Arterienklemmen	12.09	KILNER Nasenflügel Haken	46.24
Humerus Platte proximal	36.22	JONES Tuchklemme	14.02	KILNER Schere	08.06
HUNT Pinzette	11.06	JOSEPH (LEWIS) Nasen Raspel	46.21	Kinderhüftplatte	36.19
HUNTER Splitterpinzette	10.12	JOSEPH Knochen Feile	46.20	KIRBY ARTHUR Iris Pinzette	42.15
HUPP Trachealhaken	54.03	JOSEPH Masing Periost Elevatorium	46.17	KIRK Hammer	32.40
HURD Gaumen Nadeln	50.03	JOSEPH Nasen Sägen	46.23	KIRSCHNER Bauchdecken Halter	18.48, 18.49
HURD Tonsillen Dissektoren	50.02	JOSEPH Nasenplastik Messer	46.13	KIRSCHNER Bohraparat	33.05
HUSTINX Perineal Sperrer	18.56	JOSEPH Periost Elevatorium	46.16	KIRSCHNER Drähte	33.10
Hypophysektomie Instrumente	40.23 - 40.28	JOSEPH Schere	08.06	KIRSCHNER Extensionbügel	33.12
Hypophysektomie Spekula	40.23	JOSEPH Schleimhauthäkchen	18.07	KIRSCHNER Führungshohlsonde	26.04
Hypophyssen Pinzetten	40.18	JOSEPH Septum Elevatorium	46.16	Klammerblock	40.03
Hypophyssen Zangen	40.18	JOSEPH Skalpells	46.14	KLAPP Sehnscheiden Haken	18.12
Hysterektomie Klemmen	12.27, 12.30	JUDD ALLIS Fasszangen	64.02	Kleeblatt Platte	36.22
		JUDD MASSON Blasen- und Wundsperrer	66.03	KLEINERT KUTZ Knochen splitter Zange	32.14
		JUERS Drahtbiege Zängchen Ohr	44.12	KLEINERT KUTZ Sehnen Fasszange	32.25
		JULIAN Nadelhalter	24.05	Kleinfragemmt Knochenplatten	36.17
		JURASZ Kehlkopf Polypen Zange	52.02	KLEINSASSER Operations Laryngoskope	52.05
				KLEINSCHMIDT Blinddarm Klemme	64.04
				Klemmzange	12.23
				Klingenbrecher	06.07
				Kling-Ex Skalpellklingen-Abnehmer	06.05
I.U.D Faßinstrument flexibel	70.21	K		Klinikum Berlin Schlauch Klemme	12.30
I.U.D. Extraktions Haken	70.21	Kabel bipolar	92.06	KLINKENBERGH LOTH Thoraxschere	08.16
INGE Wirbelkörper Spreizer	40.16	KABIERSKE Pulver Bläser	44.05	KNAPP Häkchen	42.07
Instrumenten Behälter Stahl ungel. Knopfdeckel	88.07	KADER Spatel	18.20	KNAPP Iris Messer	42.05
Instrumenten Kästen Stahl	88.02	KALLMORGEN Scheiden Halter	70.09	KNAPP LUER Trachom Pinzette	43.07
Instrumenten Reinigungs- und Pflegemittel	88.23	KALLMORGEN Scheiden Spekula	70.09	KNAPP Star Löffel	42.08
Instrumenten Schale Stahl	88.04	KALT ARRUGA Nadelhalter	24.10	KNAUS Gefäß Messer	40.29
Intima Spatel	56.18	KALT Kapsel Pinzette	43.04	Knief Haken	32.56, 32.57
Intra Uterin Kanülen	70.30	KALT Nadelhalter	24.10	Knieweichteile Sperrer	18.31
Intranasal Hammer	32.44	Kaltlicht Nasen Spekula	46.04	KNIGHT Nasen Zange scharf	46.08
Inzisions Schere	08.10	Kanalbürste für Hohlsschrauben	33.23	KNIGHTON Laminektomie Sperrer	18.35
IOWA Haken Zange	70.19	Kanalreiniger für Hohlsschrauben	33.23	Knochen Bohrer	33.04 - 33.09,
Iridetomie Schere	09.03	KANE Nabelschnur Klemme	72.05		33.22
Iris Häkchen	18.07	KANTROWITZ Klemme	12.20		32.16
Iris Haken	42.07	Kanüle Vene	22.04		46.20
Iris Pinzetten	42.12 - 42.15,	Kanülen, Tonsillen	50.08		
	42.17				
	08.07, 09.02				
Iris Scheren	42.09				
Iris Spatel	88.03				
Irrigatoren					

Knochen Feilen	32.59	Krypthaken	68.06	LERICHE Bauchdecken Haken	18.19
Knochen Fräser	33.04 - 33.09	KUEMMEL Bauchdecken Haken	18.19	LESTER Fixier Pinzette	43.03
Knochen Halteklammern	32.22	KUENTSCHER Femur Aufreiber	33.18	LEVINSON Fremdkörper Nadel	42.06
Knochen Haltezangen	32.15 - 32.18	KUENTSCHER Vorbohrer	33.18	LEWIN Knochen Haltezange	32.19
Knochen Haltezangen selbstzentrierend	32.18	KUENTSCHER Vorschläger	33.19	LEWIS Nasen Raspel	46.21
Knochen Hämmer	32.40 - 32.44	Kugel Fräser	33.09	LEXER Meißel	32.36
Knochen Klammern	36.25	Kugelsonden	20.02	LEXER Osteotome	32.37
Knochen Raspeln	32.59	KUHNT Hornhaut Schaber	42.06	LEXER Schere	08.04
Knochenbiopsie Kanüle	22.04	KÜNTSCHER Marknägels	36.04 - 36.06	LEXER Spongiosa Meißel	32.37
Knochendraht	33.13	Kupplungsschrauben für DHS Schrauben	34.08	LEYLA Retraktor System	40.10 - 40.14
Knochenhebel	32.51 - 32.56	Küretten Absaugung	70.36	LICHTENBERG Nadelhalter	24.08
Knochenlöffel scharf	32.26 - 32.32	Küretten Ohr	44.18	LICHTWITZ Kieferhöhlen Kanülen	46.13
Knochenmeißel	32.33 - 32.39	Küretten Uterus	70.31 - 70.36	Lid Platte	42.03
Knochenmühle	32.60			Lidhalter	18.08
Knochennägels	33.11,			Ligatur Gummi Ringe Latex	68.10
	36.02 - 36.07			Ligatur Nadel	26.03
Knochenplatte 1/2 Rohr	36.14			Ligatur Scheren	08.17 - 08.18
Knochenplatte 1/3 Rohr	36.16			Linkshänder Nadelhalter	24.02 - 24.04
Knochenplatte 1/4 Rohr	36.16			Linsenimplantations Pinzetten	42.18
Knochenplatte breit	36.14			Linkshänder Scheren	08.02, 08.03,
Knochenplatte für Finger	36.16				08.05, 08.07,
Knochenplatte schmal	36.14				08.20
Knochenplatte T	36.22			Lippen Halter	48.03
Knochenplatten	36.14 - 36.24			Lippen und Wangen Halter	48.04
Knochenplatten Femurosteotomie	36.18, 36.19			LISTER (Sinus) Tupfer Zangen	16.04
Knochenplatten Kleinfragment	36.17			LISTER BURCH Sperr Elevator	42.03
Knochenplatten mini	36.16, 36.17			LISTER Verband Schere	08.20
Knochenplatten Minifragment	36.17			LISTON Amputations Messer	06.10
Knochenplatten Schenkelhals	36.15			LISTON Knochen splitter Zangen	32.13
Knochenschrauben durchbohrt	36.11			LITTAUER Cilien Pinzette	43.10
Knochenschrauben Kortikalis	36.11 - 36.13			LITTAUER Ligatur Schere	08.18
Knochenschrauben Malleolar	36.13			LITTAUER Nasen Polypen Zangen	46.06
Knochenschrauben mini	36.11			LITTAUER Ohr Zangchen	44.10
Knochenschrauben Spongiosa	36.11 - 36.13			Little Joker CUSHING Raspatorien	32.47
Knochen splitter Zangen	32.13, 32.14			LITTLE Wundhaken	18.12
KNOLLE Häkchen	42.07			LITTLER Schere	08.04
Knopf Häkchen	44.09			LITTLEWOOD Gefäß Zangchen	64.04
Knopf Sonden	20.02			LLOYD DAVIS Biopsie Zange	68.07
Knorpel Fasszangen	32.20			LLOYD DAVIS Rektoskop	68.04
Knorpel Quetscher	46.23			LLOYD DAVIS Rektum Anastomosen Klemme	64.08
Knorpelmesser	06.13			LLOYD DAVIS Schere	08.16
Koagulations Pinzetten bipolar	92.04 - 92.05			LLOYD DAVIS Sigmoidoskop	68.04
Koagulations Pinzetten monopolar	92.03			LLOYD Einschläger für Schenkelhalsnägels	34.11
KOCHER Arterienklemme grazil	12.08			LLOYD Vorschläger und Nagelzieher	33.19
KOCHER Blasen Spatel	66.03			LOCKHART MUMMERY Sonden	20.04
KOCHER Darm Klemmen	64.05, 64.06			LOCKLIN Schere	08.07
KOCHER Kropf Sonde	54.04			LOCKWOOD ALLIS Darm Fasszangen	64.03
KOCHER Kropf Sperrer	18.28			Löffel Platte	36.22
KOCHER LANGENBECK Wundhaken	18.15			Löffel scharf	32.26 - 32.32
KOCHER Nippon Arterienklemmen	12.07			LOGAN Wundsperrer	18.26
KOCHER Wundhaken	18.11, 18.14,			LORDAN Chalazion Pinzette	43.06
	18.15, 18.17			LORENZ Verband Schere	08.21
KOENIG Elevatorien	32.50			LORNA (EDNA) Tuchklemmen	14.03
KOENIG Führungshohlsonden	26.04			LORTAT JACOB Instrumenten Halter	88.23
KOENIG Wundhaken	18.10			Lösungs Schalen	88.03
KOERTE LUER Gallenstein Löffel	62.04			LOUTE Drahtspanner	33.13
KOERTE Wundhaken	18.17, 18.26			LOVE GRUENWALD Zangen Laminektomie	40.17
KOGAN Endo Spekula	70.13			LOVE Nerv Wurzelhaken	40.06
Komedonen Quetscher	74.02			LOVE Zäpfchen Retraktor	50.02
Komprimeter	33.02			LOVELACE Arterienklemmen	12.10
Kondylen Abstützplatte	36.20			LOVELACE Lungen Fasszange	56.13
Kondylen Platten	36.15			LOWER Gallenkanal Klemme	12.23
Kondylen Zielgerät	34.06			LOWMAN HÖGLUND Knochen Halteklammern	32.22
KONRICH Trommeln	88.05			LOWMAN Knochen Halteklammern	32.22
Konus Messer	70.29			LUBET BARBON Nasen Polypen Zangen	46.06
KOOS Gefäß Messer	40.29			LUC Nasen Zangen scharf	46.08
Kopfhautklemme	12.10			LUCAE Knopfhäkchen	44.09
Kopfraumfräser	33.24			LUCAE Stimmgabel	44.05
Kopfschwarzen Zange	72.05			LUCAE Trommelfell Nadel	44.07
Kornzangen	16.02, 16.06			LUER Haemorrhoiden Zange	68.08
Kortikalis Schrauben	36.11 - 36.13			LUER Hohlmeißel Zangen	32.03
Köcher für HF Elektroden	88.22			LUER KOERTE Gallenstein Löffel	62.04
Kranioklaste	72.07, 72.08			LUER Tracheal Kanülen	54.03
KRAUSE Nasen Schnürer	46.13			LUER Wundhaken	18.03
KRAUSE Ohrpolypen Schnürer	44.09			Luft Dusche	44.06
KRAUSE Zangen Aufsatz	52.03			LUKART BILL Zughebel	72.04
KRAYENBUEHL Nerv Häkchen	40.26			LUKART Geburts Zange	72.03
Kreissägen	33.09			Lumbal Punktions Kanülen	22.03, 22.04
KRESSNER Septum Zange	46.10			LUNDSGAARD Sklerotom 12 cm	42.06
Kreuz Platte	36.20			Lungen Fasszange	56.13
KRISTELLER Scheiden Halter	70.07 - 70.09			Lungen Schere	08.16
KRISTELLER Scheiden Spekula	70.07 - 70.09			Lungen Spatel	56.12
KROENLEIN Arterienklemme	12.11			Lupus Küretten	74.02
KRONECKER Nadel	26.02			Lupus Schaber	74.02
Kropf Fasszangen	56.02				
Kropf Sonden	54.04				
Kropf Sperrer	18.27, 18.28				
		L			
		LABORDE Tracheal Dilatorator	54.02		
		LACK Zungendrucker	48.03		
		LAFORCE Adenotome	46.28		
		LAFORCE Fremdkörper Instrument	42.06		
		LAHEY (SWEET) Gallenkanal Klemme	12.22		
		LAHEY Dura Haken	40.05		
		LAHEY Gallenkanal Klemme	12.22		
		LAHEY Kropf Fasszangen	54.04		
		LAMBERT Chalazion Pinzette	43.06		
		LAMBOTTE Knochen Haltezangen	32.15, 32.16		
		LAMBOTTE Meißel	32.36		
		LAMBOTTE Osteotome	32.36		
		LAMBOTTE Raspatorien	32.45		
		Laminektomie Sperrer	56.07		
		Laminektomie Zangen	40.17 - 40.20		
		LANCASTER Sperr Elevator	42.03		
		LANDAU Scheiden Spekula	70.13		
		LANDOLT Eukleatoren	40.25		
		LANDOLT Häkchen	40.25		
		LANDOLT Löffel	40.25		
		LANDOLT Mikro Skalpellgriffe	06.08		
		LANDOLT REULEN Dissektor	40.25		
		LANDOLT REULEN Raspatorien	40.25		
		LANDOLT Spreizzange für Spekula	40.23		
		LANDOLT Tumor Fasszange	40.18		
		LANE (PAUCHET) Tuchklemmen	14.04		
		LANE Knochen Haltezangen	32.16		
		LANE Knochenhebel	32.56		
		LANE Magen Klemmen	64.11		
		LANE Pinzetten	10.05		
		LANE Schraubendreher	33.20		
		LANE Wundhaken	18.03		
		LANG Tränensack Löffel und Dissektor	42.09		
		LANG E HOHMANN Knochenhebel	32.54		
		LANG E Zangen Aufsatz	52.03		
		LANGENBECK Elevatorien	32.46, 32.49		
		LANGENBECK Finger Säge	33.03		
		LANGENBECK Finger Schutz	48.12		
		LANGENBECK GREEN Wundhaken	18.10		
		LANGENBECK Lappen Messer	06.11		
		LANGENBECK MANNERFELDT Wundhaken	18.25		
		LANGENBECK Mini Wundhaken	18.10		
		LANGENBECK Nadelhalter	24.07		
		LANGENBECK Ohr Kürette	44.08		
		LANGENBECK Raspatorium	32.46		
		LANGENBECK Resektions Messer	06.10		
		LANGENBECK Wundhaken	18.13		
		Langen Messer	42.04		
		Laparotomie Rahmen Verwinyl	18.47		
		Laparotomie Sperrer rö.-durchlässig	18.47		
		Lärmtrommel	44.05		
		Laryngoskope	04.05 - 04.06		
		LAWRENCE Präparier und Ligatur Klemmen	12.19		
		LE MEE Zungen Spatel	48.03,		
			48.07 - 48.11		
		Lebensretter	54.03		
		Leberpunktions Nadeln	22.05		
		LEBSCH E Sternum Meißel	32.38		
		LEECH WILKINSON Intra Uterin Kanülen	70.30		
		LEFORT Harnröhren Bougies	66.08		
		LEGUEU Blasen Spatel	66.03		
		LEGUEU Blasen und Wundspreizer	66.04		
		Leichen Nadeln	26.07		
		LEKSELL (STILLE) Hohlmeißel Zangen	32.09		
		LEMMON Sternum Approximatoren	56.12		
		LEMPERT Elevatorien	44.19		
		LEMPERT scharfe Löffel	32.29		
		LEMPERT Wundsperrer	18.29		
		LERCHE Pinzette	10.05		
		LERICHE Arterienklemmen	12.12		

Alphabetisches Inhaltsverzeichnis

M	
Magen Klemmen	64.11
Magen Quetsch Klemmen	64.12
Magen- und Darm Nähapparat	64.13
MAGILL Katheter Einführzange	04.04
MAIER Kornzangen	16.02
MAIER Polypen Zange	16.02
MAIER Schwammzangen	16.02
MAINGOT Darmfloss Pinzette	10.10
MAINGOT Hysterektomie Klemmen	12.30
MAISONNEUVE Urethrotom	66.04
MALIS Cerebellum Sperrer	18.61
Malleolar Schrauben	36.13
MALTZ (COTTLE) Nasen Raspel	46.21
MANNERFELDT Federhaken	18.25
MANNERFELDT Gabel Haken	18.24
MANNERFELDT Häkchen	18.24
MANNERFELDT Haken	18.24
MANNERFELDT LANGENBECK Wundhaken	18.25
MARKHAM MEYERDING Spreizer	18.38
Marknägel	36.04 - 36.06
Markraum Haken Nägel	36.02
Markraum Nägel flexibel	36.03
Markraumbohrer elastisch	34.09
Markraumbohrer flexibel	34.09
MARKWALDER Rundmeißel Zange	32.13
MARQUARDT Hohlmeißel Zange	32.11
MARSCHIK Tonsillen Pinzette	50.05
MARTEL Kopfhautklemme	12.10
MARTIN Becken Zirkel	72.05
MARTIN Haken Zange	70.17
MARTIN Knorpel Fasszangen	32.20
MARTIN Kornzange	16.06
MARTIN Uterus Sonden	70.22
MARTIN Wundhaken	18.18
MARTINI scharfe Löffel	32.32
MASING Perioist Elevatorium	46.17
Mass. General Hospital Nadelhalter	24.06
Maßband	02.12
MASSON Nadelhalter	24.05
Maßstäbe	02.12
Mastdarm Spekuła	68.02 - 68.05
MATHIEU Fremdkörper Zangen	66.04
MATHIEU Nadelhalter	24.08
MATHIEU Rektal Spekulum	68.03
MATHIEU Wundhaken	18.03
MATSON ALEXANDER Raspatorium	32.48
MATSON Raspatorium	32.48
MAUNDER Mund Keil aus Holz	48.12
MAY Ophthalmoskop	02.07
MAYFIELD Hohlmeißel Zange	32.11
MAYO (HARRINGTON) Schere	08.03
MAYO ADAMS Wundsperrer	18.30
MAYO BLAKE Gallenstein Zange	62.02
MAYO COLLIN Wundhaken	18.02
MAYO Gallenstein Löffel	62.04
MAYO GUYON Nierenstielklemme	12.24
MAYO HEGAR Nadelhalter	24.04
MAYO Nierenstein Sonde	62.04
MAYO NOBLE Schere	08.03
MAYO ROBSON Darm Klemmen	64.07, 64.12
MAYO Russ. Pinzette	10.06
MAYO Schere	08.03
MAYO Sterilisier Klammer	28.02
MAYO STILLIE Schere	08.03
Mc CREA Harnröhren Bougies	66.08
Mc INDOE Knochen splitter Zange	32.14
McCULLOUGH Strabismus Pinzette	42.16
McDONALD Elevatorium	32.50
McGEE Drahtbiege Zängchen Ohr	44.12
McGEE Häkchen	44.18
McGIVNEY Fuß Zange	68.08
McGUIRE Hornhaut Schere	09.02
McINDOE Knorpelschere	08.15
McINDOE Pinzetten	10.07
McINTOSH Laryngoskope	04.05
McVOR Wundsperrer	48.08
McKENTY Septum Elevatorium	46.15
McKENZIE Bohrer	33.05
McKENZIE Clip Anlegezange	40.02
McKENZIE Klammerblock	40.03
McKISSOCK Schere	08.15
McLAUGHLIN Knochen Platte	36.07
McLEAN Geburts Zange	72.03
McLEAN TUCKER LUIKART Geburts Zange	72.03
McPHERSON Faden Pinzette	43.05

MEAD Hammer	32.42
MEAD Hohlmeißel Zangen	32.02
MED-I-TAPE Farb Kodier Band	88.10
Medizin Becher	88.03
MEEKER Klemme	12.20
MEEKER Präparier- und Ligatur Klemme	12.19
Mehrfragement Knochenplättchen	36.16
Meißel	32.32 - 32.39, 46.17 - 46.20
Meißel, Klängen auswechselbar	32.33
MELLINGER AXENFELD Sperr Elevator	42.02
MELLINGER Sperr Elevator	42.02
MENGHINI Nadel	22.05
MENGHINI Sougspritze	22.05
MENGHINI Trokar	22.05
Meniskotome	32.58
MERCEDES Thorax Sperrer	56.08
Mess Sonden	44.19
Messbecher	88.03
Messer	06.10 - 06.11, 06.13
Messer Amputation	06.10
Messer Resektion	06.10
Messlehre für Markraum Nägel	36.06
Messlehren für Schrauben	33.23
Messschieber	02.12, 42.11
METZENBAUM Nadelhalter	24.06
METZENBAUM Scheren	08.05
MEYER Repositions Zange	32.21
MEYERDING Laminektomie Spreizer	18.38
MEYERDING MARKHAM Spreizer	18.38
MEYERDING Valven	18.63
MEYERDING Wundhaken	18.12, 18.21
MEYHOEFER Chalazion Löffel	42.08
MICHEL Postrhinoskopie Spiegel	46.05
MICHEL Wundklammer Pinzette, Zängchen	26.07
MICHEL Wundklammer Zängchen	26.07
MICHEL Wundklammer Zängchen, Pinzette	26.08
MICHEL Wundklammern	26.08
Micro Pinzetten	11.02
Micro Scheren	09.02 - 09.04
MIDDELDORPF Bauchdecken Haken	18.22
MIDDELDORPF Wundhaken	18.16
MIDDLETON JANSEN Zange	46.12
Mikrochirurgie Nadelhalter	24.10 - 24.12
Mikrolaryngoskopie Zängchen, Scherchen	52.04
Mikro-Skalpellklinge	06.08
MIKULICZ Peritoneum Klemmen	12.26, 12.27
MIKULICZ Wundhaken	18.18
MILAN Uterus Biopsie Küretten	70.24
MILLIGAN Dura Dissektor	40.07
MILLIN Blasenhalsscherrer	66.04
MILLIN Faden Führungs Zange	66.02
MILLIN Kapsel Fasszangen	66.02
MILLIN Saugrohr	04.03
MILLIN Wundsperrer Blase	66.04
Mini Knochenschrauben	36.11
Mini Schrauben	36.11
Minifragment Knochenplatten	36.17
MISKIMON Cerebellum Retraktor	18.30
MIXTER Baby Arterienklemmen	12.21
MIXTER Gallenkanal Klemme	12.23
MIXTER Gallenstein Zange	62.02
MIXTER Klemmen	12.20 - 12.23
MIXTER O'SHAUGNESSY Klemmen	12.22
MOCK Nadel Heparin	22.04
MOELTGEN Winkelmesser	02.11
MOLLISON Wundsperrer	18.29
MOLLISON Wundsperrer	18.29
MOLT Wundsperrer	48.05
MOORE Bohrrapparat	33.04
MOORE Gallenstein Löffel	62.02
MOORFIELD Naht Pinzette	43.05
MORITZ SCHMIDT Zungen Drücker	48.03
MORRIS Wundhaken	18.18
MORSE FAVALORO Rippen Sperrer	56.09
MORSE Rippen Sperrer	56.08
Mosquito Klemmen	12.04, 12.09
MOYNIHAN Arterienklemmen	12.07
MOYNIHAN Gallenstein Sonde	62.03
MOYNIHAN Klemmzange	12.23
MOYNIHAN Tuchklemme	14.04
MUCK Messer Perioist	44.19
MUELLER Sperr Elevator	42.03
Mukosa Messer	46.13
MÜLLER Knochenhebel	32.53
München Uterus Biopsie Kürette	70.23

Mund Keil aus Holz	48.12
Mund Spatel	48.02
Mund Spatel Holz	48.02
Mundsperrer	48.05 - 48.11
MURDOCK Sperr Elevator	42.02
MURPHY LANE Doppellevatorium	32.52
MURPHY Wundhaken	18.12
MUSEUX Haken Zange	70.17, 70.19
Muskel Haken	18.64, 42.07
Muskel Pinzetten	43.02
Mutter für Kortikalis Schrauben	36.13
MYERS Venenstripper	20.03
MYLES Nasen Zange scharf	46.10
MYLES Spül Kanüle	46.29
Myom Heber	70.29
Myom Messer	70.29
Myrtenblatt Sonden	20.02
N	
NABATOFF Varicen Besteck	20.03
Nabelschnur-Scheren	08.14
Nachschlagbolzen	34.04
Nadel Dose	88.02
Nadel Kassette	88.02
Nadel und Meißel	42.10
Nadelhalter	24.02 - 24.12
Nadelhalter für Linkshänder	24.02 - 24.04
Nadeln, Näh-	26.05, 26.06
Nadeln, Ohr	44.17
Nadelrad	02.11
NAEGELE Geburts Zangen	72.02
Nagel Ausreißzange	33.03
Nagel Feile	74.04
Nagel Scheren	74.03
Nagel Zangen	74.03
Nagelhaut Zangen	74.04
Nagelspalt Schere	08.22
Nagelstarter für Dreiamellennägel	34.11
NAGER Tonsillen Nadel	50.03
Nähnadeln	26.05, 26.06
Naht Pinzetten	10.11, 43.05
Nasen Feile	46.20
Nasen Meißel	46.17 - 46.20
Nasen Messer	46.14, 46.15
Nasen Pinzetten	46.05
Nasen Raspeln	46.20 - 40.22
Nasen Sägen	46.23
Nasen Schnürer	46.13
Nasen Spekuła	46.02 - 46.04
Nasen Tampon Zange	46.06
Nasen Zangen	46.07
Nasen Zangen scharf	46.09 - 46.10, 46.12
Nasenflügel Haken	46.24, 46.25
Nasenplastik Meißel	46.18
Nasenplastik Messer	46.13, 46.14
Nasenspolypen Zangen	46.06, 46.07
Nasenrachen Zange scharf	46.26
Nasenrücken Haken	46.24
Nasenscheren	08.09
NATIONAL HOSPITAL Perkussionshammer	02.11
NAUNTON MORGAN Nadelhalter	24.07
NEFF Meniskotome	32.58
NEGUS Bruststütze für Mundsperrer	48.11
NEGUS Tonsillen Klemme	12.15
NEIVERT Haken doppelt	46.25
NEIVERT Nadelhalter	24.02
NELATON Hohlsonde	20.02
NELSON Pinzetten	10.09
NELSON Trokar Bruststich	22.03
NELSON Unterbindungs Nadel	26.02
Nerv Haken	40.05, 40.06
Nerv Präparier Schere	08.14
Nerv Wurzelhaken	40.06
NICOLA Küretten	40.24
Nieren Klemmen	12.24, 12.25
Nierenschalen	88.03
Nierenstein Sonde	62.05
Nierenstein Zangen	62.05, 62.06
Nierenstiel Klemmen	12.24, 12.25
Nippon Arterienklemmen	12.07
NISSEN Klemme	12.14, 12.21
Noppenmatten aus Silikon	88.10
NORFOLK und NORWICH Wundspreizer	18.36
NORTHBENT Ligatur Schere	08.17
NORTHFIELD Hohlmeißel Zange	32.07

Alphabetisches Inhaltsverzeichnis

NORTHFIELD Wundsperrer	18.35
NOTO Uterus Polypen Zange	70.20
NOVAK Saug Kürette	70.23
NOYES Iris Schere	09.02
NOYES Nasenpolypen Zange	46.07
NUGENT Augen Pinzette	42.16

O

OCHSNER DIXON Arterienklemmen	12.06
OCHSNER Fadenpinzette	26.07
OCHSNER Gallenstein Sonde	62.02
OCHSNER ROCHESTER Arterienklemmen	12.08
OCHSNER Trokar Bruststich	22.03
O'CONNOR Iris Häkchen	42.07
OETTINGEN Wundsperrer	18.60
Ohr Häkchen	44.09, 44.18
Ohr Katheter	44.07
Ohr Küretten	44.07, 44.18
Ohr Messer	44.08
Ohr Pinzetten	44.09
Ohr Scherchen Mikro	44.11, 44.12, 44.14
Öhr Sonden	20.02
Ohr Spekula	44.02, 44.03
Ohr Zängchen	44.10 - 44.16
Ohr Zängchen Mikro	44.12, 44.15, 44.16
Ohrflöfel	44.08
Ohrmesser	44.08, 44.17
Ohrpolypen Schnürer	44.09
Ohrsonde	20.02
Ohrspritzen	44.06
Ohrtrichter	44.02
OLDBERG Zange Laminektomie	40.18
OLIVECRONA Draht Sägen	40.06
OLIVECRONA Dura Dissektoren	40.07
OLIVECRONA Hirn Spatel	40.15
OLIVECRONA Hohlmeißel Zangen	32.04
OLIVECRONA TOENNIS Clip Zange	40.03
OLIVECRONA Trigenimus Messer	40.09
OLLIER Wundhaken	18.16
OLSEN HEGAR Nadelhalter	24.08
OMBREDANNE (JACKSON) Gewebe Fasszange	64.03
Operations Laryngoskope	52.05
Orbita Spatel	42.08
Organ Fasszangen	64.04
Organ Messer	06.13
O'SHAUGNESSY Klemmen	12.22
Osteotome	32.33, 32.35 - 32.38, 32.39
Osteotomie Klammer	36.25
O'SULLIVAN O'CONNOR Bauchdecken Halter	18.43
O'SULLIVAN O'CONNOR Scheidenspekulum	70.13
OTIS Harnröhren Bougies	66.08
OTIS Urethrotom	66.04
Otoskop	02.06
OVERHOLT Baby Arterien Klemme	12.15
OVERHOLT GEISSENDOERFER Klemmen	12.16
OVERHOLT Klemmen	12.16
OVERHOLT MIXTER Klemme	12.21
OVERHOLT Raspatorien	32.48

P

Pacific Biopsie Zange	70.27
PALMER Einschlaginstrument	34.12
PALMER Knochen Nägel	36.07
PALMER Nachschlaginstrument	34.12
PAPAVERO CASPAR Spekula	40.23
Paracentese Nadeln	44.07, 44.08
Parametrien Scheren	08.12
Parametrium Klemmen	12.29
PARHAM Band	32.22
PARHAM Band Spanner	32.22
PARK Sperr Elevator	42.03
PARKER LANGENBECK Wundhaken	18.03
PARKER MOTT Wundhaken	18.02
PARKER Wundhaken	18.02
PARTSCH Hammer	32.41
PARTSCH Meißel	32.34
PASSOW Meißel	44.19
PATON Hornhaut Dissektor	42.06
PAUCHET Tuchklemmen	14.04

PAUFIQUE Faden Pinzetten	43.05
PAYR Baby Quetsch Klemme	64.12
PAYR Führungshohlsonde	26.04
PAYR Magen Quetsch Klemmen	64.12
PEAN Arterienklemmen grazil	12.08
PEAN Arterienklemmen kurzfassend	12.11
PEAN Nippon Arterienklemmen	12.07
PEAN ROCHESTER Arterienklemmen	12.08
PEDERSEN Scheiden Spekula	70.02
PEERS BERTRAM Tuchklemme	14.03
PELKMANN Tupferzange	16.04
Pelvis Haken	18.19
PENFIELD Dura Dissektoren	40.08
Penis Klemmen	66.05
PENNINGTON Arterienklemmen	12.10
PENNYBACKER Hohlmeißel Zange	32.06
PERCY Retraktoren	33.02
Perineal Sperrer	18.56
Perineorrhaphie Sperrer	70.13
Periost Elevatorien	46.16, 46.17
Periost Messer	44.19
Peritoneum Klemmen	12.26, 12.27
Perkussions-Hämmer	02.10 - 02.11
PESTALOZZA Abortus Kürette	72.06
Petri Schalen	88.04
PETZ Magen- und Darm Nähapparat	64.13
Pflasterspatel	20.05
Pfriem Vierkant	33.10
Phalangen Hebel	32.51
Phalangen Messer	06.11
Phalangen Zange	32.20
PHANEUF Peritoneum Klemme	12.27
PHILLIPS Schraubendreher	33.20
Phlebo Instrumente	20.05
Picks, Ohr	44.17, 44.18
PIERCE Kieferhöhlen Trokar	22.02
PIFFARD Lupus Kürette	74.02
Pigtail Sonde	42.12
PINARD Stethoskop Aluminium	02.09
Pinzette für Spritzen und Kanülen	28.02
Pinzette russisches Modell	10.06
Pinzetten	10.02 - 11.06
PIPER Geburts Zangen	72.04
Plattensitz Instrumente für Winkelplatten	34.04 34.05
Plattenspanner	34.03
Plazenta und Abortus Zangen	72.06
PLESTER Lappen Messer	44.17
PLESTER Saug Kanüle	44.06
PLESTER Wundsperrer	18.28
Pleura Biopsie Nadel	22.03
PLEY Sperr Elevator	42.03
Pneumoperitoneum Nadel	22.03
POIRIER Gewebe Fußzängchen	12.11
POLITZER Luft Dusche	44.06
POLITZER Ohr Messer	44.08
POLITZER Paracentese Nadel	44.07, 44.08
POLLOSON Wundhaken	18.23
Polypen Zangen	16.02
POPPE Saugkanüle	40.15
Postrhinoskopie Spiegel	46.05
POTTS DE MARTEL Gefäß Schere	08.10
POTTS SMITH Gefäß Schere	08.11
POTTS SMITH Pinzette	10.02
POZZI Haken Zangen	70.18
Präparier Bestecke	32.39
Präparier Scheren	08.03 - 08.06, 08.09, 08.14
Präparier- und Ligatur Klemmen	12.16, 12.17, 12.19 - 12.21
PRATT (BILLROTH) Haken Zange	70.19
PRATT Arterienklemme	12.10
PRATT Cystikus Haken	68.06
PRATT Rektal Spekulum	68.02
PRATT Uterus Dilatatoren	70.16
PRICE THOMAS Bronchus Klemme	56.14
PRINCE Muskel Pinzette	43.02
PRINCE Tonsillenschere	08.10
Probe Absaug Küretten	70.36
Proktoskope	68.04, 68.05
Prostata Haken	66.02
Prostata Sperrer	66.03
PROVIDENCE HOSPITAL Arterienklemmen	12.06
Pudendus Anaesthesia Kanüle	22.03
Pulver Bläser	44.06
Punktions Kanülen	40.16
PYE SMITH (HARRISON) Sterilisier Zange	28.02
Pylorus Spreizer	64.04

Q

QUERVAIN Elevatorium	32.50
QUINBY Zahnfleisch Schere	08.19
QUIRE Hebel für Fremdkörper	44.10
QUISLING Hammer	32.44

R

Radiometrie Kanülen	22.06
Radius Platte	36.22
RADOLF Nagel Ausreißzange	33.03
RAGNELL DAVIS Wundhaken	18.05
RALK Bohraparat	33.06
RALK Splitterzange	10.13
RAMEL Pleura Biopsie Nadel	22.04
RAMPLEY Schwamm Zangen	16.03
RAMSAY Pinzette	10.06
RANDALL Nierenstein Zangen	62.05
RANDALL Saug Kürette	70.23
RANEY Anlege und Abnahme Zange	40.04
Rasierklinge	06.07
Rasiermesser	06.13
Raspatorien	32.45 - 32.52
Raspeln	32.59
RAY Hypophysen Küretten	40.28
RAY Küretten	40.24
RECAMIER Uterus Küretten	70.32, 70.33
Rectus Pinzette	43.02
REICHERT Kehldeckel Halter	52.02
REILL Repositions Zange	32.20
REILL Zwickzange	33.17
REINER Gips Messer	30.04
REINER Ohrspritzen	44.06
Reinigungs Bürste für Tracheal Kanülen	54.03
Rekonstruktionsplatte für Becken	36.14
Rektal Spekula	68.02 - 68.05
Rektoskope	68.04
Rektum Anastomosen Klemme	64.08
Rektum Biopsie Zangen	68.06, 68.07
Rektum Schere	08.16
Repositions Zangen	32.20, 48.12
RESANO Rektum Anastomosen Klemme	64.08
Resektions Messer	06.10
REVERDIN (ALBARRAN) Nadel	26.03
REVERDIN Nadel	26.03
REYNOLDS (JAMESON) Schere	08.07
Rhachiotom	32.38
RHEINSTAEDTER Uterus Spülküretten	70.24
RIBBON Bauchspatel	18.05
RICARD Bauchdeckenhalter	18.59
RICHARDSON EASTMAN Wundhaken	18.04
RICHARDSON Wundhaken	18.04
RICHTER HEATH Wundklammer Zange	26.08
RIECKER KLEINSASSER Bruststütze	52.06
RIGBY Wundsperrer	18.56
Ring Messer	46.27, 46.28
RING Zungenspatel	48.11
Rippen Kontraktor	56.12
Rippen Raspatorien	32.47, 32.48
Rippen Scheren	56.02, 56.03
Rippen Sperrer	56.04 - 56.11
Rippensperrer Kleinkind	56.10
RITCHEY Nagelstarter	34.11
RITTER HALLE Stirnhöhlen Dilatatoren	46.29
ROBB Gefäß Dissektoren	56.18
ROBIN MASSE Bauchdeckenhalter	18.60
ROBIN Tuchklemme	14.04
ROCHARD Wundhaken System	18.61
ROCHESTER CARMALT Arterienklemmen	12.09
ROCHESTER OCHSNER Arterienklemmen	12.08
ROCHESTER PEAN Arterienklemmen	12.08
ROEDER Binder	50.03
ROEDER Tuchklemmen	14.03
ROETTGEN RUSKIN Hohlmeißel Zange	32.08
ROGER Septum Elevatorium	46.16
ROGERS Parametrium Klemmen	12.29
ROGGE Sterilisier Zange	28.02
Rollen Klemme	12.32
ROLLET Exstirpations Meißel	42.06
ROLLET Häkchen	42.07
Rongeuere	40.19, 40.20
ROSEN Messer	44.17
ROSEN Nadel	44.17, 44.18
ROSENBERG Zangen Aufsatz	52.03
ROSER KOENIG Mundsperrer	48.05

Alphabetisches Inhaltsverzeichnis

ROSS Aorta Haken	56.13
Rotes Kreuz Verband Schere	08.21
ROUX MAGNUS Wundhaken	18.03
ROUX Wundhaken	18.02, 18.03
ROWE Zangen	48.12
ROY CAMILLE Wirbelsäulen Platte	36.23
RUBIN Septum Quetsch Zange	46.10
RUDD Haemorrhoidal Ligator	68.09
RUMEL Thoraxklemmen	12.17
Rundmeißel Zange	32.13
RUSKIN Hohlmeißel Zangen	32.08, 32.09
RUSKIN LISTON Knochen splitter Zangen	32.14
RUSSEL DAVIS Zangen Spatel	48.09
RYDEL SEIFFER Stimmgabel	44.05
RYDER Nadelhalter	24.04, 24.05

S	
SACHS Dura Dissektoren	40.07
SACHS Dura Separator	40.08
SACHS Nerv Haken	40.05
SAENGER Plazenta und Abortus Zangen	72.06
SALENIUS Meniskotome	32.58
Salpingograph	70.30
SANVENERO Schere	08.06
SAROT Bronchus Klemmen	56.14
SAROT Nadelhalter	24.07
SATINSKY Anastomosen Klemmen	56.15
SATINSKY Thorax Schere	08.16
SATINSKY Vena Cava Klemmen	56.15
SATO Hornhaut Messer	42.05
SATTERLEE Amputations Säge	33.03
SAUER Sperr Elevator	42.02
SAUERBRUCH Hohlmeißel Zangen	32.09
SAUERBRUCH Nadel Etui	88.02
SAUERBRUCH Raspatorium	32.46
SAUERBRUCH Rippen Schere	56.03
SAUERBRUCH Wundhaken	18.20, 18.21
Saug Elevatorium	46.29
Saug Küretten	70.23, 70.36
Saugkanüle	40.15, 44.06
Saugligator	68.10
Saugrohre	04.02 - 04.03, 40.15, 40.16, 44.06, 52.07

Saugrohre für Neurochirurgie	40.15
Saugrohre isoliert	40.16
SCAGLIETTI Hohlmeißel Zangen	32.10
Scapula Wundhaken	18.21
Schädel Halter	40.04
Schädel splitter	32.39
Schädelzange	40.07
SCHAEDEL (SHRADLE) Tuchklemme	14.02
SCHAMBERG Komedonen Quetscher	74.02
scharfe Löffel	32.26 - 32.32
SCHAEDE scharfe Löffel	32.26
SCHIEBE Organ Fasszangen	64.04
Scheiden Spektula	70.02 - 70.13
Scheiden Spektula für HF Chirurgie	70.02 - 70.04
Scheiden Spektula für Laser Chirurgie	70.02 - 70.04
SCHIEFE Augen Kanüle	43.08
SCHIEFE Goniotomie Messer	42.06
SCHNEIMANN Zangen Aufsatz	52.03
Schenkelhals Nägel	36.07, 36.08
Schenkelhals Platten	36.15
SCHPEPENS Orbita Spatel	42.08
SCHERBAK Scheiden Spektula	70.12
Scheren	08.02 - 09.04
Scheren für Linkshänder	08.02, 08.03, 08.05, 08.07, 08.20

Schieblehren	02.12
Schiel Haken	42.07
Schilddrüsen Haken	54.04
Schilddrüsen Sperrer	54.04
SCHIMMELBUSCH Trommeln	88.05
SCHINK Dermatom	06.11
SCHIOETZ Tonometer	43.09
Schlägel	32.43
Schlauch Klemmen	12.30 - 12.32
Schleimhaut (gyn.) Absauger	70.30
Schleimhaut Häkchen	18.07, 46.24
Schließ Zange für Anastomosen Klemmen	64.10
Schlitzhammer	34.04, 33.19
Schlüssel für DHS Schrauben	34.07

Schlüsselbein Zangen	32.21
SCHMEDEN Conchotom	46.10
SCHMID Intima Spatel	56.18
SCHMID Kanüle Gefäß	22.04
SCHMIEDEN Führungshohlsonde	26.03
SCHMIEDEN PAYR Führungshohlsonde	26.04
SCHMIEDEN TAYLOR Dura Schere	08.15
SCHNEIDER Raspatorium	32.46
SCHNEIDER SAUERBRUCH Raspatorium	32.46
SCHNIDT (BOETTCHER) Tonsillen Klemme	12.14
SCHOENBORN Schilddrüsen Haken	54.04
SCHOENBURG Fasszange	64.04
Schränkeisen für Knochenplatten	33.21
Schrauben Halter	33.20
Schrauben Messgeräte	33.23, 33.25
Schrauben Pinzette selbsthaltend	33.21
Schraubendreher	33.20, 33.23
Schraubendreher Einsätze	34.13
Schraubendreher für Distractions Schraube	18.41
Schraubendreher für Hohlschrauben	33.23
Schraubendreher Schnellspannfutter	34.13
SCHROEDER Haken Zange	70.18, 70.19
SCHUBERT Uterus Biopsie Zangen	70.24
SCHUKNECHT Messer	44.17
SCHUKNECHT Saugrohr	44.06
SCHULTZE Salpingograph	70.30
SCHULZE BERGMANN Mastdarm Spektula	68.02
SCHUMACHER Nabelschnur Schere	08.14
SCHUMACHER Sternum Schere	56.03
SCHUMACHER Uterus Biopsie Zange	70.25
SCHUMACHER Zangen Aufsatz	52.03
Schwamm Zangen	16.03 - 16.06
SCHWEIGGER Kapsel Pinzette	43.04
Schweizer Modell Scheiden Spektula	70.05
Schwester Garnitur	74.03
Schwingmesser	46.15
SCOVILLE Bandscheibenbruch Küretten	32.29
SCOVILLE Haken	18.63
SCOVILLE HAVERFIELD Spreizer	18.62
SCOVILLE Nerv Wurzel Haken	40.06
SCOVILLE scharfe Löffel	32.29
SCOVILLE Spreizer Laminektomie	18.62
SEBILAU Elevatorium	32.50
SEDLLOT Raspatorien	32.45
SEGOND Myom Messer	70.29
Sehnen Durchzug Zangen	32.23
Sehnen Fasspinzetten	32.23
Sehnen Fasszangen	32.24, 32.25
Sehnen Schere	09.02
Sehneneinflecht Klemme	32.24
Sehnenscheiden Haken	18.12
Sehnenstripper	32.59
SEIDEL Schieden Spektulum	70.11
SEIFFERT Zangen Aufsatz	52.03
Seitensperrer für Scheiden Spektula	70.06
Sektions Nadeln	26.07
SELLHEIM Geburts Löffel	72.07
SELLORS Rippen Kontraktor	56.12
SEMB Bronchus Klemmen	56.14
SEMB Hohlmeißel Zangen	32.10
SEMB Knochen Haltezangen	32.15
SEMB Knochen splitter Zange	32.14
SEMB Raspatorien	32.48
SEMB Rippen Raspatorien	32.48
SEMKEN Pinzetten	10.07
SEMM Scheiden Spektulum	70.06
SENN GREEN Wundhaken	18.10
SENN MILLER Wundhaken	18.05
SENN Wundhaken	18.05
SENNING (Schweden) Nadelhalter	24.04
Septatom	46.15
Septum Elevatorium	46.15 - 46.17
Septum Meißel	46.17
Septum Quetsch Zange	46.10
Septum Richtzange	46.25
Septum Scheren	46.11
Septum Spektula	46.04
Septum Zangen	46.07, 46.08 46.10, 46.12
Sequester Zangen	32.21
SEUTIN Gips Schere	30.02
SEWALL Elevatorium	46.16
SEXTON GERZOG Ohr Messer	44.08
SEXTON Ohr Messer	44.08
SEYFFERT Scheiden Spektula	70.05
Seziermesser	06.13
SHEA Schere mikro Ohr	44.11

SHEPARD Pinzette	42.18
SHRADLE Tuchklemme	14.02
Siebbein Zangen	46.07
SIEBOLD Schere	08.13
Siebschalen	88.08
Siebschalen Zubehör	88.09
SIEGLE Ohrspektula	44.03
Sigmoidoskope	68.04
Silber Klammern für Magen naht	66.02
Silberklammern	40.03
Silikon Noppenmatten	88.10
SILVER Dermatom	06.12
SILVER Nasenplastik Meißel	46.19
SIMCOE Saug- Spülkanüle	43.08
SIMON Bauchdeckenhaken	18.18
SIMON Fistelhaken	70.29
SIMON scharfe Löffel	32.27
SIMON Uterus Löffel	70.31
SIMPSON BRAUN Geburts Zange	72.02
SIMPSON Geburts Zangen	72.02
SIMS MAIER Polypen Zange	16.02
SIMS Rektal Spektulum	68.02
SIMS Scheiden Spektulum	70.10
SIMS Uterus Depressor	70.21
SIMS Uterus Dilator	70.17
SIMS Uterus Küretten	70.32, 70.33
SIMS Uterus Schere	08.12
SIMS Uterus Sonden	70.22
SINGLEY TUTTLE Pinzetten	10.09
Sinus Tupfer Zangen	16.04
Skalp Contour Wundsperrer	18.30
Skalpelle	06.09
Skalpellgriffe	06.02 - 06.04, 06.08
Skalpellklinge mikrochirurgisch	06.08
Skalpell-Klingen steril	06.05 - 06.06, 66.08
Skalpellklingen-Abnehmer	06.05
Skarifikateur	42.05
Sklerotom	42.06
Skaliose Meißel	32.37
SLUDER BALLENGER Tonsillotom	50.07
SMELLIE Geburts Haken	72.05
SMELLIE Perforatorium	72.08
SMILLIE Knie Haken	32.57
SMILLIE Meniskotome	32.58
SMITH BUIE Rektal Spreizer	68.03
SMITH PETERSEN Hohlmeißel Zangen	32.11
SMITH PETERSEN Knochen Nägel	36.07
SMITH PETERSEN Meißel	32.35
SMITH Sperr Elevator	42.02
SMITH US Army Gaze Schere	08.20
SMITHWICK Clip Anlegezange	40.02
SMITHWICK Nerv Haken	40.06
SNELLEN Draht Schlingen	42.09
SNELLEN Entropium Pinzetten	43.07
SNITMAN Wundsperrer	18.27
SOMER Uterus Fasszange	70.21
Sonden	20.02 - 20.04
Spanner für Knochen draht	34.13
Spannplatte zu Dermatom	06.11
Spannzange	33.13
Spannzange für Draht	33.13
Spektulum für lumbare Bandscheiben Operation	18.42
SPENCER Ligatur Scheren	08.17
SPENCER WELLS (CHANCE) Arterienklemmen	12.09
SPENCER WELLS (JONES) Arterienklemmen	12.09
Sperr Elevatoren	42.02, 42.03
Spiegel Postrhinoskopie	46.05
Spinal Elevator	32.52
Spinal Löffel scharf	32.30
Spinal Meißel	32.37
Spiralbohrer	18.41
Splitterpinzetten	10.12
Spongiosa Meißel	32.37
Spongiosa Schrauben	36.11 - 36.13
SPRATT scharfe Löffel	32.26
Spreizzange für Spektula	40.23
Spritzen, Tonsillen	50.08
Spül Kanülen	46.13, 46.29
Spül Schalen	88.03
SPURLING Zangen Laminektomie	40.17
ST. MARKS (LLOYD DAVIES) Pelvis Haken	18.19
ST. MARKS Perineal Sperrer	18.56
St. MARTIN Naht Pinzette	43.05
St. CLAIR THOMSON Ring Messer	46.28
STACKE Ohrsonde	20.02

Alphabetisches Inhaltsverzeichnis

Standgefäße	88.04
Standgefäße mit Kornzange	88.04
Stanzen Ohr	46.11, 46.12
Star Löffel	42.08
Star Messer	42.04
Star Nadeln	42.06
STAUDE Tuchklemme	14.04
STEINBACH Schlägel	32.43
STEINMANN Nägel	33.11
STELLBRINK Hohlmeißel Zangen	32.05
STELZNER Schere	08.16
Steriliser Container Zubehör	88.13, 88.19, 88.20, 88.21, 88.24
Sterilisier Behälter Stahl Filter in Deckel u. Boden	88.06
Sterilisier Container	88.11 - 88.19
Sterilisier Klammern	28.02
Sterilisier Trommeln	88.05
Sterilisier Tuch	88.10
Sterilisier Zangen, Pinzetten	28.02
Steril-Skalpellklingen	06.05 - 06.06, 66.08
STERNBERG Lippen Halter	48.03
Sternum Approximatoren	56.12
Sternum Schere	56.03
Sternum Sperrer	56.09
Stethoskope	02.09
STEVENS Iris Pinzetten	42.13
STEVENS Linsen Haken	42.07
STEVENS Nadelhalter	24.09
STEVENS Tenotomie-Schere	08.08
STEVENSON Sperr Elevator	42.03
STIEGLITZ (WILLIAMS) Splitterzange	10.13
STILLE BARRAYA Pinzette	10.09
STILLE Bohraparat	33.04
STILLE Gips Schere	30.02
STILLE LISTON Knochensplitter Zangen	32.14
STILLE LUER Hohlmeißel Zangen	32.08
STILLE Meißel	32.35
STILLE Nierenstielklemme	12.24
STILLE Osteotome	32.35
STILLE Pinzetten	10.02
STILLE RUSKIN Hohlmeißel Zange	32.09
STILLE SHERMAN Bohraparat	33.04
Stimmgabeln	44.04, 44.05
Stirnhöhlen Dilatatoren	46.29
Stirnlampe	02.05 - 22.06
Stirnspiegel	02.05
STOCKMANN Penis Klemme	66.05
STONE Pinzette	10.10
STONE Verschluss Klemme	64.10
STONE WATT Darm Klemme	64.10
STONE WATT Schloss für Darm Klemmen	64.10
Stößel für Knochen	32.38
Strabismus Pinzetten	42.16
Strabismus Schere	08.08
STRANDELL STILLE Wundhaken	18.10
Strassburg Pinzette	10.10
STRATTE Nadelhalter	24.07
STRAUSS Penis Klemme	66.05
STRAUSS Rektoskop	68.04
Stripper Gefäß	20.04, 20.05
STRUCK Rippensperrer Kleinkind	56.10
STRUEMPEL Ohrzangchen	44.11
STRULLY Gefäß Schere	08.15
STRULLY neurochirurgische Scheren	08.15
Struma Spreizer	18.28
STRUYCKEN Nasen Zange scharf	46.10
SVEN JOHANSSON Vorschläger	34.11
SYME Aneurysmen Nadel	26.02
SYPERT Hohlmeißel Zangen	32.12
SYSTRUNK Nagelspalz Schere	08.22

T	
TABB Sichelmesser	44.17
Tampon Pinzette	52.02
Tangential Klemmen	12.25
TARNIER Geburts Zange	72.04
TARNIER Kranioklast	72.08
TAYLOR Haken	18.63
TAYLOR Hammer	02.10
TAYLOR Pinzetten	10.07 - 10.08
TAYLOR Valven	18.63
Tenotomie-Schere	08.08
TERRIER Gefäßklemme	12.03

TERSON Kapsel Pinzette	43.04
T-Griff mit Schnellkupplung für DHS Schrauben	34.07
THIERRY Geburts Zange	72.04
THOMAS Uterus Küretten	70.34
THOMS GAYLOR Uterus Biopsie Zange	70.25
THOMSON WALKER Blasen und Wundsperrer	66.03
Thorax Scheren	08.16
Thorax Sperrer	56.04 - 56.11
Thorax Wundhaken	18.20
Thoraxklemmen	12.17
THOREK Lungen (Thorax) Schere	08.16
THUDICHUM (GOLDSMITH) Nasen Spekula	46.02
Tibia Platten	36.22
Tibia Platten anatomisch	36.21
TIECK HALLE Nasen Spekulum	46.04
TILLEY Ohr Zangchen	44.10
TISCHLER Baby Biopsie Zange	70.26
TISCHLER KEVORKIAN Biopsie Zange	70.28
TISCHLER MORGAN Uterus Biopsie Zangen	70.26 - 70.28
TIVNEN Tonsillen Faszange	50.05
TOBOLD Kehlkopf Watteträger	20.06
TOBOLD Zungen Drücker	48.03
TOENNIS ADSON neurochir.Scheren	08.15
TOENNIS Arterienklemme	12.18
TOENNIS Dura Dissektor	40.07
TOENNIS Nadelhalter	24.07
TOHOKU Tuchklemmen	14.03
Tonnen Zange	33.14
Tonsillen Dissektoren	50.02
Tonsillen Elevatorium	50.03
Tonsillen Faszangen	50.04, 50.05
Tonsillen Kanülen	50.08
Tonsillen Klemmen	12.14, 12.15
Tonsillen Kompressorium	50.06
Tonsillen Messer	50.03, 50.04
Tonsillen Nadeln	50.03
Tonsillen Pinzette	50.06
Tonsillen Schnürer	50.06, 50.07
Tonsillen Spritzen	50.08
Tonsillen Zangen	50.08
Tonsillenscheren	08.09 - 08.10
Tonsillenschlingen	50.07
Tonsillotome	50.07, 50.08
TOOK Hornhaut Messer	42.05
TOTI Fräser	33.09
TOWNLEY Messschieber	02.12
TOWNSEND Biopsie Zange	70.27
TOWNSEND KEVORKIAN Biopsie Zange drehbar	70.27
TOWNSEND TISCHLER Baby Biopsie Zange	70.27
TOWNSEND TISCHLER MORGAN Biopsie Zangen	70.27
TOYNBEE Ohrtrichter	44.02
Trabekular (Pigtail) Sonde	42.12
Trabekulotomie-Sonden	42.12
Tracheal Dilatatoren	54.02
Tracheal Häkchen	18.08, 54.02
Tracheal Sperrer	54.02
Tracheotomie Besteck	54.03
Tracheotomie Trokar	52.07
Trachom Pinzette	43.07
Tränenkanal Dilatatoren	42.11, 42.12
Tränenkanal Sonden	42.12
Tränensack Löffel und Dissektor	42.09
Tränensack Sperrer	42.03
Trapez Osteosynthese Platte	36.24
TRAUBE Hammer	02.10
TRAVERS Wundsperrer	18.32
TRELAT Scheiden Spekula	70.06
Trennbleche für Siebschalen	88.09
Trephinen	43.08, 43.09
TRETHOWAN Knochen Hebel	32.56
TREVES Pinzetten	10.03
Trigeminus Messer	40.09
TROELTSCH (WILDE) Ohr Pinzette	44.09
TROELTSCH Nasen Pinzette	46.05
TROEMNER Hammer	02.10
Trokar, Tracheotomie	54.02
Trokare	22.02, 22.03
TROTTER Hohlmeißel Zange	32.07
TROUSSEAU Tracheal Dilatorator	54.02
TROUTMAN CHRIS Klingensprecher	06.07
TROUTMAN Colibri Iris Pinzette	42.15
TROUTMAN Rectus Pinzette	43.02
Tübingen Faden Pinzette	43.05
Tübingen Iris Pinzette	42.17
Tübingen Luft Kanüle	43.08
Tübingen Wundsperrer	18.30
Tuchklemme mit Schlauchhalter	14.02

Tuchklemmen	14.02 - 14.04
TUCKER McLEAN Geburts Zange	72.03
TUFFIER Arterienklemme	12.11
TUFFIER Bauchdecken Haken	18.22
TUFFIER Rippen Sperrer	56.07
TUFFIER Spatel	18.05
Tumor Faszange	40.18
Tumor Pinzetten	11.05, 11.06
Tupfer Zangen	16.02 - 16.06
TURNBULL Nagel Zangen	74.04
TURNER WARWICK Bauchdeckenhalter	18.50 - 18.55
TYDING Tonsillen Faszange	50.05
TYDING Tonsillen Schnürer	50.07
TYRELL Iris Haken	42.07

U

UCKERMANN Trokar	54.02
UCKERMANN Watteträger	20.06
UFFENORDE scharfe Löffel	32.27
Uhrmacher Pinzetten	10.11
ULRICH Knochen Haltezange	32.17
ULRICH Tupfer Zangen	16.02
Umführungs Instrument	40.06
Umführungsinstrumente für Draht	33.13
Umführungsnadeln für Draht	33.13
Universal Drahtschere	08.19
Universal Faszangen	28.02
Universal Griff	52.03
UNIVERSAL Hohlmeißel Zange	32.06
Universal Verband Schere	08.22
UNNA Komedonen Quetscher	74.02
Unterbindungs Nadeln	26.02, 26.03
Unterlegscheibe für Kortikalis Schrauben	36.13
Unterlegscheiben für Hohlschrauben	36.11
Urethra Katheter Frauen	66.07
Urethra Katheter Männer	66.06
Urethrotome	66.04
Uro-Tangential Klemmen	12.25
US Army Gaze Schere	08.20
US Army Wundhaken	18.03
USA Pinzetten	10.02
Uterus Biopsie Zangen	70.24 - 70.28
Uterus Depressor	70.21
Uterus Dilatatoren	70.14 - 70.17
Uterus Faszangen	70.21
Uterus Küretten	70.31 - 70.36
Uterus Löffel	70.31
Uterus Polypen Zangen	16.03, 70.20
Uterus Probeexcisions Zangen	70.24 - 70.28
Uterus Schere	08.12
Uterus Sonden	70.22
Uterus Spül Katheter	70.35
Uterus Spülküretten	70.24
Uterus Biopsie Küretten	70.23, 70.24
Uvula Retraktor	50.02

V

Vaginal Spekula	70.02 - 70.13
Vagotomie Wundhaken	18.07
VALLEIX Uterus Sonde	70.22
van BUREN Harnröhren Bougies	66.06
van BUREN Sequester Zange	32.21
van DOREN Uterus Biopsie Zange	70.25
VANNAS Iridektomie Schere	09.03
VANT Uterus Polypen Zange	16.03
VARADY mini Venenstripper Besteck	20.04
VARADY Phlebo Instrumente	20.05
Vascular Nadelhalter	24.05
Vena Cava Klemmen	56.15
Venenkanüle	22.04
Venenstauer	02.05
Venenstripper	20.03, 20.04
Ventrikel Nadeln	40.16
Verband Scheren	08.20 - 08.22
Verbandstoff Zuschneideschere	08.20
VERBRUGGE HOHMANN Knochenhebel	32.53
VERBRUGGE Knochen Haltezangen	32.18
VERESS Pneumoperitoneum Nadel	22.03
Verlängerungs Rohre	52.03
Verlängerungsplatten	36.20
VERNIER Schiebellehre	02.12
Verschluss Klemme für Darm Klemme	64.10
Verwinyl Laparotomie Rahmen	18.47

Alphabetisches Inhaltsverzeichnis

VIDAL Lupus Schaber	74.02	WILDE Ohrpolypen Schnürer	44.09	Zungen Drücker	48.02, 48.03
Vierkant Zielgeräte	34.06	WILDE TROELTSCH Ohr Pinzetten	44.09	Zungen Halter	48.02
View More Scheiden Spektula	70.06	WILDER Draht Schlingen	42.09	Zungen Spatel	48.02
VIRCHOW Hirnmesser	06.13	WILDER Tränenkanal Dilatoren	42.11	Zungen Zangen	48.04
VIRCHOW Knorpelmesser	06.13	WILLET MARTEL Kopfhautklemme	12.10	ZWEIFEL Nadelhalter	24.07
VIRCHOW Schädelhalter	32.38	WILLIAMS Fasszangchen	64.04	Zwickzangen	33.16 - 33.18
VIRTUS (RALK) Splitterzange	10.13	WILLIAMS Mikro Bandscheiben Sperrer	18.62	Zwischenknochen Messer	06.11
VOLKMANN scharfe Löffel	32.26, 32.28, 32.31, 32.32	WILLIAMS Schraubendreher und -halter	33.20	Zyodialyse Spatel	42.09, 42.10
		WILLIAMS Sperr Elevatoren	42.03		
VOLKMANN Wundhaken	18.10 - 18.12	WILLIAMS Splitterzange	10.13		
VOLTOLINI (DUPLAY) Nasen Spektula	46.02	WILLIGER Elevatorien	32.49		
Vomer Zangen	46.07	WILLIGER Hämmer	32.41		
Vorböhrer für Knochennägel	33.18	WILLIGER Raspatorien	32.47		
Vorböhrer für Marknägel	33.18	WILLIGER scharfe Löffel	32.32		
Vorböhrer für Schädelhalter	40.04	WILMS Hohlmeißel Zange	32.07		
Vorlagerungs Pinzetten	43.02, 43.07	Winkelmesser	02.11		
Vorschläger für Marknägel	33.19	Winkelplatten	36.15, 36.18		
Vorschläger für Schenkelhalsnägel	34.11	WINTER Plazenta und Abortus Zangen	72.06		
vPETZ Magen- und Darm Nähapparat	64.13	Wirbelkörper Spreizer	40.16		
		Wirbelsäulen Meißel	32.38		
		Wirbelsäulen Platten	36.23		
		WITTNER Uterus Biopsie Zange	70.26		
		WOLFF Gipsabreiss Zange	30.04		
		WRIGHT Nadelhalter	24.02		
		WRIGLEY Geburts Zange	72.02		
		WULLSTEIN Mikro Ohr Scherchen	44.14		
		WULLSTEIN Sichelmesser	44.17		
		WULLSTEIN WEITLANER Wundsperrer	18.28		
		Wundhaken	18.02 - 18.25, 40.06		
			26.08		
		Wundklammer Besteck in Metalltui	26.07		
		Wundklammer Pinzetten, Zangen	26.08		
		Wundklammern	26.08		
		Wundnahtbesteck in Metalltui	26.07		
		Wundrand Fasspinzette	18.26 - 18.64		
		Wundsperrer	18.27 - 18.43		
		Wundspreizer	48.10		
		Würzburg Zungenspatel	70.17		
		WYLIE Uterus Dilator			

W

WACHENFELDT Wundklammer Pinzette	26.07
WADSWORTH TODD Kauter	42.09
WAGENER Häkchen	44.09
WAGENER MOSHER Lebensretter	54.03
WAGNER Schere	08.18
WAGNER Zange Laminektomie	40.18
WALB Organ Messer	06.13
WALLICH Abortus Löffel	72.07
WALSHAM Septum Richtzange	46.25
WALTER Fremdkörper Nadeln	42.06
WALTHER Dilatations Katheter	66.07
WALTHER Harnröhren Bougies	66.08
WALTON Fremdkörper Hohlmeißel	42.06
WALTON Hemilaminektomie Sperrer	18.35
WANE Wundsperrer	18.31
Wangen Halter	48.04
Wangen- und Weichteilehaken	18.23
WANGENSTEEN Nadelhalter	24.05
WANGENSTEEN Pinzetten	10.09
WARTENBERG Nadelrad	02.11
WATSON CHEYNE Dissektor	20.02
WATSON CHEYNE Elevatorium	32.50
WATSON Dermatome	06.12
WATSON JONES Knochenhebel	32.56
WATSON WILLIAMS Siebbein Zangen	46.07
Watteträger	20.06
WAUGH Pinzetten	10.09
WEBER Aesthesiometer	02.11
WEBER Draht Schlingen	42.09
WEBSTER Nadelhalter	24.02
WECKER Iris Schere	09.02
WECKER Iris Spatel	42.09
WEEK Sperr Elevator	42.02
WEIL BLAKESLEY Nasen Zangen scharf	46.09
WEINBERG Vagotomie Wundhaken	18.07
WEISS Schlauch Klemmen	12.30
WEISS Sperr Elevatoren	42.03
WEITLANER WULLSTEIN Wundsperrer	18.28
WEITLANER Wundsperrer	18.28 - 18.30
WELLS Enukleation Löffel	42.09
WERTHEIM Schere	08.13
WERTHEIM Anastomosen Klemme	12.28
WERTHEIM CULLEN Hysterektomie Klemme	12.28
WERTHEIM Hysterektomie Klemmen	12.27
WERTHEIM Klemmzangen	12.27
WERTHEIM Nadelhalter	24.06
WEST Nasen Meißel	46.20
WESTCOTT Sehnen Schere	09.02
WESTMACOTT Nasen Tampon Zange	46.06
WESTON Rektal Polypen Schnürer	68.06
WHEELER Disziplions Messer	42.05
WHEELER Zyodialyse Spatel	42.10
WHITE Tonsillen Fasszangen	50.04, 54.05
WHITEHEAD Mundsperrer	48.06
WIEDER Zungen Drücker	48.02
WIENER (AUFRIECHT) Nasen Raspel	46.21
WIENER Antrum Raspel	46.20
WIENER Iris Häkchen	42.07
Wiener Modell Nasen Spekulum	46.03
Wiener Modell Spekulum vaginal	70.11
WIGMORE Gips Säge	30.02
WIKSTROEM Arterienklemmen	12.20
WILDE Nasen Schnürer	46.13

Y

YANKAUER Nasenrachen Spekulum	46.05
YANKAUER Saugrohr	04.02
YASARGIL Arachnoidea Messer	40.29
YASARGIL Galea Haken	40.04
YASARGIL Hypophyphen Zangen	40.18
YASARGIL Nadelhalter	24.12
YASARGIL Pinzetten	11.05, 11.06
YASARGIL Raspatorien	40.27
YASARGIL SAMII Pinzette	11.05
YASARGIL Saugrohre	40.15
YASARGIL scharfe Löffel	40.28
YEOMAN Rektum Biopsie Zangen	68.06, 68.07
YOUNG Bumerang Nadelhalter	26.03
YOUNG Prostata Haken	66.02
YOUNG Zungen Zange	48.04
YOUNGE Uterus Biopsie Zange	70.26

Z

Zahnfleisch Scheren	08.18 - 08.19
Zängchen für Mikro Laryngoskopie	52.04
Zangen zur Drahtbearbeitung	33.14 - 33.18
Zäpfchen Retraktor	50.02
ZAUFAL JANSEN Hohlmeißel Zange	32.07
Zecken Entfernungspinzette	10.13
ZENKER Präparier und Ligatur Klemmen	12.19
ZENKER Wundhaken	18.21
Zentrierhülsen für DHS Schrauben	34.08
ZIEGLER Iris Messer	42.05
ZIEGLER Sperr Elevator	42.03
ZIEGLER Stirnspiegel	02.05
ZIEGLER Tränenkanal Dilatoren	42.12
Zielgerät für Bohrdrähite	33.24
Zielgerät für Winkelplatten	34.04
Zielgerät Kondylen	34.06
Zielgeräte	34.05 - 34.07
Zielgeräte für Hüftschrauben	34.07
Zielgeräte mit Gewinde	33.26
Zielgeräte Vierkant	34.06
ZIELKE Skoliose Meißel	32.37
Zielplatten Dreieck	34.05, 34.06
Zinn Sonden	20.02
ZOELLNER Saugrohr	44.06

Alphabetisches Inhaltsverzeichnis

A

abdominal retractor 18.43 - 18.60
 abdominal spatula 18.54
 abortion scoop 72.06
 ABRAHAM tonsil knife 50.04
 ABRAMS pleura biopsy needle 22.04
 accessoris for sterilization trays 88.09, 88.10
 accessories for sterilization containers 88.19 - 88.21
 adenoid curette 46.27, 46.28
 ADLERKREUTZ forceps 10.05
 ADSON (FRASIER) hemostatic forceps 12.13
 ADSON aspirating tube 40.15
 ADSON baby hemostatic forceps 12.13
 ADSON baby retractor 18.34
 ADSON BROWN forceps 10.04
 ADSON drill guide 40.04
 ADSON dura retractor 40.06
 ADSON elevator 32.49
 ADSON forceps 10.03, 10.04
 ADSON hemilaminectomy spreader 18.32, 18.33
 ADSON micro forceps 10.03, 10.04
 ADSON needleholder 24.06
 ADSON pituitary forceps 40.09
 ADSON retractor 18.31, 18.32
 ADSON rongeur 32.04
 advancement forceps 43.02, 43.07
 AEBLI corneal scissors 08.08
 aiming device for K-wires 33.24
 aiming devices 33.26, 34.04
 ALAN PARKS rectal speculum 68.03
 alar protector 46.24, 46.25
 ALBARRAN needle 26.03
 ALBEE burr 33.09
 alcohol dispenser 88.04
 ALDERDYCE dissector 32.56
 ALEXANDER chisel 32.34
 ALEXANDER gouge 32.34
 ALEXANDER periosteal 32.47
 ALLEN intestinal forceps 64.04
 ALLIS ADAIR forceps 64.02
 ALLIS tissue forceps 64.02
 ALLISON lung spatula 56.12
 ALLPORT retractor 18.27
 ALM retractor 18.26
 ALVIS foreign body curette 42.06
 amniotome 70.21
 amputation knife 06.10
 amputation saw 33.02, 33.03
 amputation shield 33.02
 anal speculum 68.05
 anastomosis clamp 56.15, 56.16
 anastomosis forceps 64.10
 ANDERSON ADSON retractor 18.30
 ANDREW tongue depressor 48.02
 ANDREWS PYNCHON aspirating tube 40.02
 angiotribe 12.09
 angle guide for hip screws 34.07, 33.08
 angled compression plate 36.15
 ANKENY sternal retractor 56.09
 anoscope 68.05
 antrum curette 46.26
 antrum punch 46.12
 antrum rasp 46.20, 46.22
 antrum retractor 46.29
 antrum trocar 22.02, 22.03
 antrum trocar needle 46.13
 AO drill bit 33.07
 appendectomy forceps 64.04
 applying and removing forceps for silver clips 40.04
 arachnoid knife 40.29
 ARCHER splinter forceps 10.13
 Arkansas sharpening stone 06.13
 Army gauze scissors 08.20
 Army retractor 18.03
 ARRUGA capsular forceps 43.04
 ARRUGA extraction hook 42.07
 ARRUGA eye speculum 42.02
 ARRUGA needle holder 24.09, 24.10
 ARRUGA protector 42.09
 arterial retractor 40.05
 ARTHUR iris forceps 42.15
 ASCH septum straightening forceps 46.25
 aspirating and irrigating cannula 43.08
 aspirating cannula 40.15, 44.06
 aspirating curette 70.23
 aspirating syringe 22.05

aspirating tube 04.02, 04.03, 40.15, 52.07
 aspirating tube insulated 40.16
 atrauma anastomosis clamp 12.28
 atraumatic forceps 11.03
 AUFBRANC Cobra bone retractor 32.54
 AUFBRANC nasal rasp 46.20, 46.21
 auricle clamp 56.16
 autopsy knife 06.13
 AUVARD speculum 70.10
 AXENFELD chalazion curette 42.08
 AYER chalazion forceps 43.06
 AYRE cone knife 70.29

B

BABCOCK forceps 64.03
 BABINSKY hammer 02.10
 baby abdominal retractor 18.46
 baby hemostatic forceps 12.03, 12.13, 12.15
 baby intestinal forceps 64.05
 baby rib approximator 56.12
 BACKHAUS KOCHER towel forceps 14.02
 BACKHAUS towel clip and tubing holder 14.02
 BACKHAUS towel forceps 14.02
 BACON bone rongeur 32.05
 BADGLEY laminectomy spreader 56.06
 BAGGISH biopsy punch 70.28
 BAILEY GIBBON rib approximator 56.12
 BAILEY rib approximator 56.12
 BAINBRIDGE hemostatic forceps 12.22
 BAKES gall stone probe 62.03
 BALFOUR abdominal retractor 18.45 - 18.47
 BALFOUR attachment fourth blade 18.46
 BALFOUR US retractor abdominal 18.47
 BALLENGER septum elevator 46.17
 BALLENGER sviwel knife 46.15
 band tightener 32.22
 bandage scissors 08.20 - 08.22
 bandage scissors universal 08.22
 BANE rongeur bone 32.04
 BANGERTER cytodialysis spatula 42.09
 BARANY noise apparatus 44.05
 BARBARA hooklet 44.17
 BARBARA needle 44.17
 BARBARA pick 44.17, 44.18
 BARKAN goniotomy knife 42.06
 BARNHILL adenoid curette 46.27
 BARON (SCHUKNECHT) suction tube 44.06
 BARR rectal speculum 68.03
 BARRAQUER anterior chamber forceps 43.02
 BARRAQUER cilia forceps 43.10
 BARRAQUER colibri eye speculum 42.02
 BARRAQUER colibri iris forceps 42.15
 BARRAQUER colibri iris scissors 09.02
 BARRAQUER colibri iris scissors 42.02
 BARRAQUER eye speculum modified 43.03
 BARRAQUER fixation forceps 42.15
 BARRAQUER KATZIN iris forceps 42.06
 BARRAQUER keratoplasty knife 24.10
 BARRAQUER needle holders 70.18
 BARRETT tenaculum forceps 68.09
 BARRON haemorrhoidal ligator 06.02
 BARRON scalpel handle 22.04
 BARTELHEIMER bone biopsy Instrument 32.32
 BARTH ear spoon 72.03
 BARTON obstetric forceps 72.03
 BARTON traction handle 04.06
 battery handles for laryngoscopes 24.03
 BAUMGARTNER needleholder 70.21
 BEACHAM amniotome 42.07
 BECKER cystotome 46.27
 BECKMANN adenoid curette 18.33
 BECKMANN EATON retractor 18.29
 BECKMANN FISCH retractor 46.03
 BECKMANN nasal speculum 18.33
 BECKMANN retractor 08.19
 BEEBEE scissors 43.10
 BEER cilia forceps 30.04
 BEESON plaster cast spreader 44.11
 BELLUCCI scissors 34.10
 bender for intramedullary nails 33.21, 33.22
 bending iron for bone plates 34.13
 bending iron for wire drills 33.21
 bending pliers for bone plates 33.22
 bending template 33.22

BENGOLEA hemostatic forceps 12.12
 BENNETT bone lever 32.52
 BENSUADE anoscope 68.05
 BERENS advancement forceps 43.07
 BERENS keratome 42.04
 BERENS muscle forceps 43.07
 BERGER biopsy forceps 70.28
 BERGMANN bandage scissors 08.20
 BERGMANN mallet 32.41
 BERGMANN plaster cast saw 30.02
 BERGMANN retractor 18.26
 BERKE muscle forceps 43.02
 BERLINER hammer 02.11
 BERNHARD (STAUDE) towel forceps 14.04
 BEST intestinal forceps 64.09
 BETHUNE rib shear 56.02
 BEUSE scissors 08.09
 BEYER bone rongeur 32.05, 32.07
 BEYER punch 46.12
 BEYER rongeur 32.07
 BIER lumbar puncture needle 22.04
 BILL tractor for standard delivery forceps handle 72.04
 BILLEAU ear loop 44.08
 BILLROTH vulsellum forceps 70.19
 BINKHORST lens implantation forceps 42.18
 biopsy curette 70.24
 biopsy forceps 70.24 - 70.28
 biopsy forceps rectum 68.06
 biopsy specimen forceps, gynecological 68.07, 70.24 - 70.28
 bipod for mouth gags 48.11
 bipolar coagulation forceps 92.04 - 92.05
 bipolar connection cards 92.06
 BIRCHER GANSKE bone holding forceps 32.19
 BIRCHER menisectome 32.58
 BIRKETT tonsil hemostatic forceps 12.14
 BISHOP HARMAN iris forceps 42.17
 bladder neck spreader 66.04
 bladder retractor 66.03, 66.04
 blade breaker 06.07
 blade ejector 18.39
 BLASCOVICS advancement forceps 43.02
 BLOHMKE tonsil seizing forceps 50.05
 BLOUNT bone lever 32.56
 BLOUNT bone staple extractor 34.12
 BLOUNT bone staple impactor 34.12
 BLOUNT bone staple inserter 34.12
 BLOUNT knee retractor 32.56
 BLUMENTHAL rongeur 32.03
 BODENHAMMER rectal speculum 68.02
 BOEHLER bone cutting forceps 32.14
 BOEHLER extension bow 33.12
 BOEHLER rongeur 32.08
 BOERMA obstetric forceps 72.04
 BOETTCHER tonsil forceps 12.15
 BOETTCHER tonsil scissors 08.10
 BONACCOLTO strabismus forceps 42.16
 bone band 32.22
 bone biopsy instrument 22.04
 bone chisel 32.33 - 32.38
 bone crusher 46.23
 bone curette 32.26 - 32.32
 bone cutting forceps 32.13, 32.14
 bone drill 33.04
 bone elevator, double 32.50, 32.52
 bone file 32.59, 46.20
 bone hammers 32.40 - 32.44
 bone hand drill 33.06
 bone holding forceps 32.15 - 32.22
 bone lever 32.52 - 32.57
 bone mill 32.60
 bone nail 36.07
 bone perforator 33.10
 bone plate „I“ 36.16, 36.22
 bone plate „I“ buttress 36.22
 bone plate „I“ small 36.17
 bone plate 1/2 tubular 36.14
 bone plate 1/3 tubular 36.16
 bone plate 1/4 tubular 36.16
 bone plate adolescent 36.19
 bone plate angled children's 33.21
 bone plate bending forceps 36.14
 bone plate broad 36.23
 bone plate cervical spinal 36.22
 bone plate cloverleaf 36.08
 bone plate dynamic compression 36.08
 bone plate dynamic hip compression 36.08

Alphabetical Index

bone plate femur	36.22
bone plate finger	36.16
bone plate for cervical spine	36.24
bone plate for reconstruction	36.14
bone plate infant	36.19
bone plate L buttress	36.23
bone plate lengthening	36.20
bone plate mini	36.16
bone plate mini finger	36.16
bone plate mini fragment	36.17
bone plate narrow compression	36.14
bone plate osteosynthetic trapezial	36.24
bone plate proximal humerus	36.22
bone plate radial	36.22
bone plate small fragment compression	36.17
bone plate spinal	36.23
bone plate tibia	36.23
bone plates	36.14 - 36.24
bone rasp	32.59
bone rongeur	32.02 - 32.12
bone screws	36.10 - 36.13
bone skid	32.52
bone staple	36.25, 36.26
bone staple extractor	34.12
bone staple impactor	34.12
bone staple inserter	34.12
bone surgery engine	33.07
bone wire soft	33.13
bone wire with eye	33.13
Bonn iris forceps	42.17
Bonn irrigating cannula	43.08
Bonn titanium iris forceps	42.17
BONNEY forceps	10.05, 10.06
boomerang needle holder	26.03
BORCHARDT burr	33.09
BOSE trachea hook	54.03
BOSE trachea spreader	54.02
BOUCHERON ear specula	44.02
bougie urethra	66.06
bow, extension	33.12
bow solution	88.03
BOWLES stethoscope	02.09
BOWMAN discision knife	42.05
BOWMAN lachrymal probe	42.12
box sterilizing stainless with filters	88.06
BOYNTON needleholder	24.09
BOYS ALLIS intestinal seizing forceps	64.02
BOZEMANN (WERTHEIM) needleholder	24.06
BOZEMANN DOUGLAS swab forceps	16.06
BOZEMANN FRITSCH uterine flushing tube	70.35
BOZEMANN swab forceps	16.05
brace complete	33.05
brain knife	06.13
brain spatula	40.15
BRAITHWAITE dermatome	06.12
BRAND tendon passer	32.23
BRAUN cranioclast	72.07
BRAUN STADLER episiotomy scissors	08.14
BRAUN tenaculum forceps	70.18
BRAUN uterine depressor	70.21
BRAUN vaginal retractor	70.11
BRAUN vaginal speculum	70.11
BRAUN vulsellum forceps	70.20
BREISKY speculum	70.13
BRIDGE hemostatic, dissecting, ligature forceps	12.20
BRISTOW periosteal elevator	32.46
BROCK needle holder	24.12
BRODIE director	20.02, 20.04
broncho oesophagoscopic forceps	52.04
bronchus clamp	12.18, 56.13, 56.14
BROPHY forceps	10.08
BROWN forceps	10.04
BROWN needle holder	24.03
BRUENINGS BRUNK antrum retractor	46.29
BRUENINGS ear speculum pneumatic	44.03
BRUENINGS extension tube	52.03
BRUENINGS forceps tip	52.03
BRUENINGS nasal cutting forceps	46.08
BRUENINGS septatome	46.15
BRUENINGS tongue depressor	48.02
BRUENINGS tonsil snare	50.06
BRUNETTI spine chisel	32.38
BRUNNER conductor	26.04
BRUNNER intestinal forceps	64.09
BRUNNER ligature conductor	26.04
BRUNNER ligature needle	26.03

BRUNNER retractor	18.20
BRUNNER rib shear	56.03
BRUNS bandage scissors	08.21
BRUNS bone curette	32.26 - 32.28
brush dispenser	74.05
brush for bone screw canal	33.23
brush for trachea tubes	54.03
BRYANT swab forceps	16.04
BÜCHS cheek and soft tissue retractor	18.23
BUCHWALD tongue depressor	48.02
BUCK ear curette	44.07
BUCK ear knife 15 cm	44.08
BUCK GRAMCKO gouge	32.34
BUCK hammer	02.11
BUCK lever foreign bodies	44.10
BUCK ligature scissors	08.18
BUFLAU trocar thoracic	22.03
BUIE aspirating cannula	68.06
Bulldog clamp atrauma	12.02
BUMM curette	70.32
BUMM uterine curette	70.32
BUNGE exenteration scoop	42.08
BUNNELL bone hand drill	33.06
BUNNELL probe	32.59
BUNNELL tendon stripper	32.59
BUNT 'safety needle'	28.02
BURCH fixation fork	42.06
BURKE biopsy punch	70.26
burr olive shape	33.09
burr pointed	33.09
burr spherical	33.04, 33.05, 33.06, 33.09
buttress plate	36.22, 36.23

C	
CAIRNS hemostatic forceps	12.06
caliper	02.12, 42.11
caliper aluminium	02.12
caliper, neurosurgery	02.12
CAMPBELL dilating bougie	66.07
canal brush for bone screws	33.23
canal cleaner for screws	33.23
CANFIELD tonsil knife	50.04
cannula, venous	22.04
CANNY RYALL retractor	18.22
CAPLAN septum scissors	46.11
capsular forceps	43.03, 43.04
capsule forceps atraumatic	66.02
capsulotomy knife	42.05
cardanic wrench	34.03
CARMALT splinter forceps	10.12
CAROL tendon seizing forceps	32.24
CARPENTER tonsil knife	50.03
CARREL vascular forceps	12.03
cartilage holding forceps	32.20
cartilage knife	06.13
CARTON mucus evacuator	70.30
case instrument stainless steel	88.07
case steel	88.02
CASPAR blade	18.38, 18.42
CASPAR counter retractor	18.42
CASPAR distraction screw	18.41
CASPAR distractor	18.41
CASPAR drill guide	18.41
CASPAR explorer and coagulating retractor	40.26
CASPAR hook	18.40
CASPAR micro scalpel handle	06.08
CASPAR retractor	18.38, 18.39
CASPAR rongeur	40.19, 40.20
CASPAR screw driver	18.41
CASPAR speculum for lumbar vertebral op.	18.42
CASPAR titanium blade	18.38
CASPAR trapezial osteosynthetic plate	36.24
CASPAR twist drill	18.41
CASPAR vertebral body distractor	18.41
CASTANEDA aluminium rib spreader	56.06
CASTROVIEJO blade breaker	06.07
CASTROVIEJO capsular forceps	43.04
CASTROVIEJO corneal scissors	09.03
CASTROVIEJO cyclodialysis spatula	42.09, 42.10
CASTROVIEJO eye speculum	42.03
CASTROVIEJO fixation forceps	43.03
CASTROVIEJO iridectomy scissors	09.02
CASTROVIEJO keratome	42.04
CASTROVIEJO lachrymal dilator	42.12

CASTROVIEJO marker	42.11
CASTROVIEJO needle holder	24.11, 24.12
CASTROVIEJO SCHACHAR marker curved	42.11
CASTROVIEJO suturing forceps	43.05
CASTROVIEJO trephine	43.08
cataract knife	42.04
cataract needle	42.06
cataract spoon	42.08
catheter dilating urethral	04.04, 66.07
catheter guide	04.04
catheter introduction forceps	04.04
catheter metal female	66.03, 66.07
catheter metal male	66.06
catheter prostate	66.07
cautery, ophthalmic	42.09
CAWOOD MINNESOTA cheek holder	48.04
centering sleeve	34.08
cephalometer	02.11
cerebellar retractor	18.30, 18.61
chalazion curette	42.08
chalazion forceps	43.06
CHAMPEAU cannula	22.06
CHANCE hemostatic forceps	12.09
CHANDLER iris forceps	42.13
CHAPUT hemostatic forceps	12.11
CHARNLEY forceps suturing	10.11
CHARNLEY horizontal spreader	18.35
CHARNLEY retractor initial incision	18.64
CHARRIERE amputation saw	33.03
CHARRIERE blade saw	33.03
CHEATLE sterilization forceps	28.02
cheek and soft tissue retractor	18.23
cheek retractor	48.04
CHELSEA EATON anal speculum	68.05
CHERON dressing forceps	16.05
chest support for laryngoscopes	52.06
chest support for mouth gags	48.11
CHEVALIER DE BOER rib spreader	56.11
CHEVALIER JACKSON forceps	52.04
CHEVRET abdominal retractor	18.05
CHEVRET retractor	18.05
child retractor support	18.59
CHILDE grasping forceps	26.07
chisel	32.33 - 32.35, 32.37, 46.18, 46.19
CINELLI chisel plastics	46.19
circular saw blade	33.09
circumcision instrument	66.05
CITELLI punch	46.11
clamp forceps	12.23, 12.27, 56.14
clamp holder	64.10
clamp vascular atrauma	12.02
CLAR head lamp complete	02.05
CLARK eye speculum	42.02
clavicular forceps	32.21
claw, fixation	42.07
CLAYMAN lens implantation forceps	42.18
cleaner for bone screw canal	33.23
cleaning brush for trachea tubes	54.03
CLEVELAND bone cutting forceps	32.13
clip applying forceps	26.07, 40.02
clip carrier	40.03
clip forceps	40.03
clip to hold bone plates	33.25
clips applying forceps	26.07
clips suturing	26.08
closing forceps	64.10
cloth fixing clip	88.13
cloth fixing frame	88.20, 88.21
CLOWARD blade	18.36, 18.37
CLOWARD laminar and cervical retractor	40.16
CLOWARD spreader only	18.37
CLOWARD spreader vertebrae	40.16
coagulation forceps bipolar	92.04 - 92.05
coagulation forceps monopolar	92.03
COAKLEY antrum curette	46.26
COAKLEY antrum trocar	22.03
COBB elevator spinal	32.52
COBB gouge spinal	32.37
COBB spinal fusion curette	32.30
COBBETT dermatome	06.12
cobra bone retractor	32.54
cobra plate	36.20
CODIVILLA clavicular forceps	32.21
COLCLOUGH punch	40.22

Alphabetical Index

cold light nasal specula	46.04	CRAIG septum and vomer forceps	46.07	De LEE HILLIS stethoscope	02.09
colibri eye speculum	42.02	cranial rongeur forceps	40.07	De LEE obstetric forceps	72.02
colibri iris forceps	42.15	cranioclast	72.07	De LEE pelvimeter for internal measuring	72.05
colibri iris scissor	09.02	CREA dilating bougie	66.08	De MARTEL saw conductor	40.06
COLLIER needleholder	24.02	Credo corn cutter	74.04	DEAN iris knife	42.05
COLLIN abdominal retractor	18.57, 18.58	CRILE hemostatic forceps	12.05	DEAN tonsil scissors	08.09
COLLIN clip forceps	26.08	CRILE MURRAY needleholder	24.03	DEAVER retractor	18.06, 18.07
COLLIN DUVAL forceps	10.06	CRILE needleholder	24.07	DEAVER retractor „grip“	18.07
COLLIN dynamometre	02.05	CRILE nerve hooklet	40.05	DEAVER scissors	08.03
COLLIN hammer	32.40	CRILE RANKIN (OCHSNER DIXON) hem. forceps	12.06	DEBAKEY atraumatic forceps (dissecting)	11.03, 11.04
COLLIN HARTMANN retractor wire	18.04	CRILE RANKIN hemostatic forceps	12.06	DEBAKEY bulldog clamp atrauma	12.02
COLLIN hemostic forceps	12.11	CRILE retractor double	18.03	DEBAKEY femur spreader	18.56
COLLIN pair of blades	18.58	CRILE titanium hemostatic forceps	12.05	DEBAKEY rib spreader	56.07
COLLIN pelvimeter	72.05	CRILE WOOD needleholder	24.03	DEBAKEY scissors vascular / thoracic	08.12
COLLIN retractor	18.02	CRITCHETT eye speculum	42.02	DEBAKEY sternotomy valves	56.07
COLLIN rib shear	56.02	CROTTI goitre retractor	18.28	DEBAKEY valves	56.07
COLLIN scalpel handle	06.03, 06.04	CRUTCHFIELD drill	40.04	decapitation hook	72.08
COLLIN speculum	70.08	CRUTCHFIELD traction tongs	40.04	DEJERINE hammer	02.10
COLLIN tongue holding forceps	48.04	CULLER iris spatula	42.09	delivery forceps	72.02 - 72.04
COLLIN umbilical cord clamp	72.05	curette antrum	40.24	DeMARTEL WOLFSON anastomosis forceps	64.10
COLLIN uterine curette	70.35	curette spinal fusion	32.30	DeMARTEL WOLFSON closing forceps	64.10
COLLIN uterine elevating forceps	70.21	curette, bone	32.26 - 32.32	DEMEL wire conductor	33.13
COLLIN vaginal speculum	70.03	curette, ear	44.18	DEMEL wire tightener	33.13
COLLYER pelvimeter	72.05	curette, hypophysectomy	40.24, 40.25,	DENHART mouth gag	48.05
columella clamp	46.26		40.28	DENIS BROWNE intestinal forceps	10.09
COLVER tonsil seizing forceps	50.04	curette, uterine	70.23, 70.24,	DENIS BROWNE retractor abdominal	18.49
combined clip forceps	26.07		70.31 - 70.36	depth gauge for bone screws	33.25
comedo extractor	74.02	CUSCO vaginal specula	70.04, 70.05	DERF (WRIGHT) needleholder	24.02
compression apparatus complete	33.02	CUSHING burr	33.05	dermatomes	06.11, 06.12
conchotome	46.10	CUSHING arterial retractor	40.05	DERRA anastomosis clamp	56.16
condylar buttress plate	36.20	CUSHING brain spatula	40.15	D'ERRICO drill	33.05
condylar compression plate	36.15	CUSHING dura retractor	40.05	DESCHAMPS needle	26.02
condylar plate guide	34.06	CUSHING forceps dissecting	10.05, 10.08	DESJARDINS gall duct clamp	12.23
CONE baby retractor	18.34	CUSHING forceps laminectomy	40.17	DESJARDINS gall stone forceps	62.02
cone knife	70.29	CUSHING hemostatic forceps	12.07	DESJARDINS gall stone probe	62.03
CONE retractor	18.34	CUSHING KOCHER retractor	18.14	DESJARDINS gall stone scoop	62.04
CONE skull punch	40.07	CUSHING laminectomy forceps	40.17	DESMARRES chalazion forceps	43.06
CONE ventricular needle	40.16	CUSHING LANDOLT speculum	40.23	DESMARRES retractor (eyelid)	18.08
conical burr	33.09	CUSHING Little Joker periosteal elevator	32.46	DEUTSCHMANN cataract knife	42.04
connecting adaptor	70.36	CUSHING nerve hook	40.05	DeVILBISS skull forceps	40.07
connecting nozzle	44.06	CUSHING retractor	18.09	DEWEY forceps	72.04
containers, sterilization	88.11 - 88.19	CUSHING TAYLOR forceps dissecting	10.08	DHS coupling screw	34.08
CONTOUR scalp retractor	18.30	cutaneous punch set	74.03	DHS guide pin	34.07
CONVERSE alar retractor	46.24	cutaneous trephine	74.03	DHS handle	34.07
CONVERSE knife nasal plastics	46.14	cuticle nipper	74.04	DHS reamer triple	34.08
COOLEY aspiration tube	04.03	cuticle scissors	74.04	DHS screw impactor	34.07
COOLEY atraumatic forceps	11.03	cutter for wire and nails	33.18	DHS screw tap	34.07
COOLEY dilator	56.17	cutting drum for bone mill	32.60	diagnostic set standard illumination	02.08
COOLEY forceps	11.03	cutting forceps nasal	46.12	Diamant wire cutter	33.16
COOLEY retractor atrium	56.11	CUZZI abortion scoop	72.06	DICK atrauma clamp anastomosis	12.28
COOPER needle	26.02	cytodialysis spatula	42.09, 42.10	DIEFFENBACH serrefine	12.03
CORDES forceps tip	52.03	cystic hook	68.06	DIETER malleus nipper	44.13
cords, diathermy	92.06	cystotome	42.07	DIETHRICH needleholder	24.09
corneal dissector	42.06	CZERNY rectal speculum	68.02	DIETHRICH scissors	08.11
corneal knife	42.05	CZERNY retractor	18.04	dilating bougie urethra	66.06 - 66.08
corneal scarifier	42.06	CZERNY vulsellum forceps	70.20	dilating catheter urethral	66.07
corneal scissors	08.08, 09.03			dilating set urethral	66.06
corneoscleral punch	42.11			dilating set uterine	70.14
CORYLLOS retractor (thorax)	18.20			dilator frontal sinus	46.29
CORYLLOS rib shear	56.02			dilator uterine	70.14 - 70.17
COS forceps wire bending	44.12			dilator vascular	56.17, 56.18
costal periosteal	32.47, 32.48			DINGMAN mouth gag	48.10
COTTLE alar protector	46.25	DAHLGREN cranial rongeur	40.07	DINGMANN bone holding forceps	32.19
COTTLE alar retractor	46.25	DALE bone rongeur	32.12	DINGMANN bone holding forceps	32.19
COTTLE applicator	46.23	DANDY hemostatic forceps	12.09	DINGMANN tongue depressor	48.10
COTTLE bone crusher	46.23	DANDY mosquito hemostatic forceps	12.09	direct measuring device for DHS screws	34.07
COTTLE chisel nasal plastics	46.18	DANDY nerve hook	40.05	directors	20.02, 20.04
COTTLE columella clamp	46.26	DANDY neurosurgical scissors	08.15	discision knife	42.05
COTTLE KAZANJIAN bone cutting forceps	32.13	DANIELS tonsillatome hemostatic	50.08	discision needle	42.06
COTTLE knife nasal plastics	46.14	DANIS wire tension pliers	33.13	dispenser for wiredrills	88.22
COTTLE mallet	32.40	DARLING spreader	18.34	disposable scalpel blade	06.05
COTTLE nasal rasp	46.21	DARTIGUES uterine elevating forceps	70.21	disposable scalpel sterile	06.06
COTTLE nasal scissors	08.09	DASTOOR erisophake	42.11	dissecting and ligature conducting forceps	12.16
COTTLE nasal speculum	46.04	DASTOOR strabismus forceps	42.16	dissecting and ligature forceps	12.16, 12.21
COTTLE periosteal elevator	46.17	DAUBENSPECK bone curette	32.27		
COTTLE retractor	46.24, 46.25	DAVIDSON scapula retractor	18.21	dissecting and ligature forceps	12.19
COTTLE septum elevator	46.16	DAVIEL cataract spoon	42.08	dissecting sets	32.39
COTTLE skin seizing forceps	46.26	DAVIS BOYLE mouth gag	48.07	dissector bone	32.56
cotton applicator	20.06	DAVIS dura dissector	40.08	dissector ear	44.18
counter retractor	18.42	DAVIS forceps for syringes and needles	28.02	dissector vascular	56.18
countersink	33.24	DAVIS foreign body needle	42.06	dissector, dura	40.08
coupling head	40.13	DAVIS MEYER mouth gag	48.09	dissector, hypophysectomy	40.24
coupling screw for DHS screws	34.08	DAY ear hooklet	44.09	distraction screw	18.41
COVENTRY staple	36.25	DCS plate	36.09	DITTEL bougie urethra	66.06
COXETER catheter prostate	66.07	DE BAKY DIETHRICH forceps	11.04	divider for wire basket trays	88.09
CRAFOORD (STELZNER) scissors	08.16	DE BAKY dilator	56.17	DIX foreign body spud	42.06
CRAFOORD bronchus clamp	12.18	DE BAKY forceps extra light atrauma	11.06	DIX needle and gouge	42.10
		DE BAKY needleholder	24.04	DIX needle and spud	42.10
		DE BAKY suction tube	04.02		

Alphabetical Index

DOUGLAS cilia forceps	43.10	ELSCHNIG corneal knife	42.05	FINOCHIETTO needleholder	24.06
DOUGLAS trocar and cannula	22.02	ELSCHNIG cyclodialysis spatula	42.09	FINOCHIETTO rib spreaders	56.04
DOWNING menisectome	32.58	ELSCHNIG fixation forceps	43.03	FINSEN retractor	18.26
DOYEN abdominal retractor	18.18	EMMET dressing forceps	16.06	FINSTERER suction tube	04.03
DOYEN baby intestinal forceps	64.05	EMMET fistula hook	70.29	FISCH dissector	44.18
DOYEN burr spherical	33.09	end cutter cannulated	33.18	FISCHER ARLT iris forceps	42.15
DOYEN conical burr	33.09	endocervical speculum	70.13	FISH ear probe	20.02
DOYEN costal periosteal	32.47	enterotomy scissors	08.17	fistula hook	70.29
DOYEN cylindrical burr	33.09	entropium forceps	43.07	fistula probe (krypt hook)	68.06
DOYEN grooved director	20.02	enucleation scissors	08.09	fistula scissors	08.13
DOYEN gynecological scissors	08.13	enucleator	40.24, 40.25	fixation claw	42.07
DOYEN hammer	32.41	epiglottis retractor	52.02	fixation forceps	43.03
DOYEN intestinal forceps	64.05	epiphyseal clamp	36.25	fixation fork	42.06
DOYEN JANSEN (MOLT) mouth gag	48.05	epiphyseal staples	36.25	fixing pin for partition walls	88.09
DOYEN myoma screw	70.29	episiotomy scissors	08.14	flap knife ear	44.17
DOYEN needleholder	24.03	Eppendorfer biopsy specimen forceps	70.28	flap knife general surgery	06.11
DOYEN retractor support child size	18.59	erisophake	42.11	flat burr	33.05
DOYEN speculum vaginal	70.10	ESMARCH bandage scissors	08.20	flat nose pliers	33.14 - 33.16
DOYEN STILLE retractor	18.22	ESMARCH plaster knife	30.04	FLETCHER (JAVERTS) sponge forceps	16.04
DOYEN tongue depressor	48.02	esthesiometer	02.11	FLEURANT trocar for bladder	22.02
DOYEN towel forceps	14.04	ethmoid forceps	46.07	FLIERINGA scleral fixation ring	42.18
DOYEN uterus polypus forceps	70.20	EYES tonsil snare	50.06	FLUHRER probe buttoned tin	20.02
DRAFFIN bipod for mouth gags	48.11	EWALD (HUDSON) forceps	10.04	flushing curette	70.24
drape green	88.10	excision forceps	64.09	FOERSTER iris forceps	42.14
dressing forceps	16.02 - 16.06	exenteration scoop	42.08	FOERSTER swab forceps	16.03
dressing forceps antiseptic	88.04	exploring and coagulating retractor	40.26	FOMON alar retractor	46.24
dressing forceps with jar	88.04	extension bow	33.12	FOMON chisel	46.18
drill bit	33.07, 33.22,	extension tube laryngeal forceps	52.03	FOMON nasal rasp	46.21
	40.04	extirpation chisel	42.06	FOMON nasal scissors	08.09
drill bit cannulated	33.22	extracting forceps for wire drills	33.14	FOMON retractor posterior nares	46.24
drill guide	18.41, 34.04,	extracting hook I.U.D.	70.21	FOMON scissors dissecting	08.09
	34.06, 40.04	extraction hook for intramedullary nails	33.19	forceps broncho oesophagoscopic	52.04
drill guide universal	34.02	extraction hook ophthalmic	42.07	forceps coagulation monopolar	92.03
drill sleeve	33.25, 33.26,	extractor for flexible medullary nails	34.10	forceps delivery	72.02 - 72.04
	34.02, 34.04	extractor for intramedullary nails	33.19	forceps extra light trauma	11.06
drilling chuck cannulated	33.06	eye cannula	43.08	forceps for atraumatic Bulldog clamps	12.02
drum, sterilizing	88.05	eye forceps	42.16	forceps for syringes and needles	28.02
DUBOIS gynecological scissors	08.13	eye magnet with loop	43.09	forceps hemostatic	12.02 - 12.30
DUBOST rib spreader	56.10	eye speculum	42.02, 42.03	forceps laminectomy	40.17 - 40.22
DUBOST rib spreader blades	56.10			forceps microlaryngeal	52.04
DUEHRSSSEN forceps	10.10			forceps neurosurgical micro	11.05
DUNHILL hemostatic forceps	12.06			forceps organ grasping	64.04
DUPLAY dressing forceps	16.06			forceps parametrium	12.29
DUPLAY nasal speculum	46.02			forceps phalangeal	32.20
DUPLAY tenaculum forceps	70.18			forceps Russian pattern	10.06
Duplex stethoscope	02.09			forceps screw holding	33.21
DUPUY DUTEMPS lachrymal sac spreader	42.03			forceps thoracic	12.17
DUPUY WEISS tonsil needle	50.03			forceps tips	52.03
dura dissector	40.05 - 40.08			forceps tissue	10.02 - 10.04
dura elevator	40.09			forceps tumor	11.05
dura knife	40.08			forceps uro-tangential atraumatic	12.25
dura retractor	40.05, 40.06			forceps USA pattern	10.02
dura scissors	08.15			forceps wire bending ear	44.12
dura separator	40.09			forceps wire twisting	33.15
DURANTE forceps	10.07			forceps, dressing and tissue	10.02 - 11.06
DURHAM retractor	18.22			forceps, fixation	43.03
DUVAL forceps	10.06			forceps, intestinal and tissue grasping	64.02 - 64.04
DUVAL grasping forceps	64.03			forceps, thumb and tissue	10.02 - 11.06
dynamometre	02.05			forceps, tissue and dressing	10.02 - 11.06
				forceps, tissue and intestinal grasping	64.02 - 64.04

Alphabetical Index

		F			
		FAHLBUSCH curette	40.25		
		FALCONER rongeur	32.07		
		FARABEUFF bone holding forceps	32.15		
		FARABEUFF COLLIN periosteal	32.45		
		FARABEUFF LAMBOTTE bone holding forceps	32.15		
		FARABEUFF periosteal	32.45		
		FARABEUFF retractor double	18.02		
		FARR spreader	18.26		
		FARREL cotton applicator	20.06		
		FARRIOR ear specula	44.02		
		FAULKNER curette sharp	46.26		
		FAURE peritoneum forceps	12.27		
		FAURE uterus biopsy forceps	70.24		
		FAVALORO scissors vascular	08.12		
		FEATHERSTONE mouth gag	48.05		
		FEHLAND intestinal forceps	64.09		
		FEILCHENFELD splinter forceps	10.12		
		FEIN cotton applicator	20.06		
		femoral plate anatomical	36.21		
		femur spreader	18.56		
		FERGUSON ACKLAND mouth gag	48.05		
		FERGUSON angiotribe	12.09		
		FERGUSON bone holding forceps	32.15		
		FERGUSON gall stone scoop	62.04		
		FERGUSON scissors angled	08.06		
		FERRIS SMITH forceps	10.05		
		FERRIS SMITH KERRISON punch	40.21		
		FERRIS SMITH KERRISON rongeur	40.21		
		FERRIS SMITH laminectomy forceps	40.18		
		FICKLING haemostatic (oral) forceps	12.07		
		filtré dispenser	88.24		
		final impactor	34.04		
		FINCH excision forceps	64.09		
		finger extension sleeve wire	33.12		
		finger nail perforator	33.03		
		finger protector	48.12		
		finger ring cutter	33.03		
		finger saw	33.03		
		fino scissors	08.04, 08.05		
		FINOCHIETTO aluminium rib spreader	56.04		
		FINOCHIETTO baby rib spreader	56.04		
		FINOCHIETTO bronchus clamp	56.14		
		FINOCHIETTO BURFORD aluminium rib spreader	56.05		
		FINOCHIETTO Infant rib spreader	56.05		

E					
ear catheter	44.07				
ear curette	44.07, 44.08,				
	44.18				
ear forceps	44.10 - 44.16				
ear forceps dressing	44.09				
ear knife	44.08, 44.17				
ear loop	44.08				
ear probe	20.02				
ear scissors micro, mini	44.14				
ear specula	44.02 - 44.03				
ear spoon and hook	44.08				
ear syringe	44.06				
ECHLIN bone rongeur	32.10				
EDNA towel forceps	14.03				
EISELSBERG MATHIEU needle holder	24.08				
electric plaster saw oscillating	30.03				
elevator ear	44.19				
elevator septum	46.16, 46.17				
elevator spinal	32.52				
elevators, periosteal	32.45 - 32.51				
ELLIOT obstetric forceps	72.02				
ELLIOT trephines	43.09				
ELLIS foreign body gouge	42.06				
ELSCHNIG capsular forceps	43.04				

FREER septum chisel 46.17
 FREER septum elevator 46.16, 46.29
 FREER septum knife 46.14
 FRENZEL tongue depressor 48.02
 FRELUND alcohol dispenser 88.04
 FRIEDMAN mini rongeur 32.02
 FRIEDMAN retractor perineorrhaphy 70.13
 FRIEDMAN rongeur delicate 32.02
 FRITSCH retractor 18.17
 frontal sinus dilator 46.29
 FRYKHOLM bone rongeur 32.10
 FUCHS capsular forceps 43.04
 FUCHSIG hemostatic forceps 12.14

G

GABRIEL rectal speculum 68.05
 galea retractor 40.04
 gall duct and cysticus forceps 12.21
 gall duct clamp 12.23
 gall duct forceps 12.22, 12.23
 gall stone forceps 62.02
 gall stone probe 62.02, 62.03
 gall stone scoop 62.04
 GALLAHER antrum rasp 46.22
 GARRETT dilator vascular 56.18
 gauge for drillbits and screws 33.25
 gauge for intradullary nails 36.06
 GAUSS scalp flap forceps 72.05
 gauze packer 50.03
 gauze scissors 08.20
 GELLHORN biopsy forceps 70.25
 GELPI perineal retractor 18.56
 Gemini dissecting/ligature forceps 12.17
 GERALD forceps 10.08
 GERSTER traction bar 32.22
 GERZOG hammer 32.40
 GIERTZ STILLE rib shear 56.03
 GIGLI handle for wire saw 40.06
 GIGLI wire saw 40.06
 GIL VERNET retractor 18.09
 GILL ARRUGA capsular forceps 43.03
 GILL corneal knife 42.05
 GILL HESS iris forceps 42.14
 GILL iris forceps 42.14
 GILLIES (FRENCH) osteotome 32.34
 GILLIES forceps 10.07
 GILLIES hooklet 46.25
 GILLIES needleholder 24.09
 GIRARD suturing forceps corneoscleral 43.05
 GLASER laminectomy retractor 18.64
 glass box 88.02, 88.03
 GLOVER clamp vascular atrauma 12.02
 GLUCK rib shear 56.02
 GOELET retractor double 18.04
 goitre director 54.04
 goitre director with hole 54.04
 goitre retractor 18.28
 goitre seizing forceps 54.04
 goitre spreader 18.27
 GOLDMAN FOX gum scissors 08.18
 GOLDSMITH nasal speculum 46.02
 GOLDSTEIN eye speculum 42.03
 goniometer 02.11
 goniotomy knife 42.06
 GOOD tonsil scissors 08.10
 GOODELL uterine dilator 70.17
 GORNEY scissors 08.04
 GOSSET abdominal retractor 18.44
 gouge 32.33 - 32.38, 46.20
 gouge for removing broken screws 32.37
 gouge nasal 46.20
 gouge spinal 32.37
 gouge V-shape 46.20
 GOURDET uterine scoop 70.31
 GRADLE cilia forceps 43.10
 GRAEFE cataract knife 42.04
 GRAEFE cataract spoon 42.08
 GRAEFE cystotome 42.07
 GRAEFE fixation forceps 43.03
 GRAEFE forceps 10.05
 GRAEFE iris forceps 42.12, 42.13
 GRAEFE scarifier 42.04
 GRAEFE strabismus hook 42.07
 GRAHAM nerve hook 40.05

grasping forceps, intestinal and tissue 64.03
 GRAVE „view more“ speculum 70.06
 GRAVE vaginal speculum 70.02
 GRAVE vaginal speculum insulated for HF surgery 70.02
 GRAVE vaginal speculum laser model 70.02
 GRAY gall duct clamp 12.24
 GREEN ARMYTAGE uterine hemostatic forceps 72.05
 GREEN corneal dissector 42.06
 GREEN fixation forceps 43.03
 GREEN muscular hook 42.07
 GREEN retractor 18.16
 GREENE uterine curette 70.34
 GREVEN forceps wire bending 44.12
 grip (seizing) forceps 33.14
 grip handle retractors 18.04, 18.05, 18.07

grooved director 20.02
 grooved director buttoned 20.02
 GROSS ear spoon and hook 44.08
 GROSS MAIER dressing forceps 16.02
 GRUBER ear specula 44.02
 GRUENWALD nasal forceps bayonet 46.05
 guide pin 33.19
 guide pin DHS 34.07
 guide rod for reamer 34.09
 GUILLEN irrigating cannula 46.29
 GULEKE bone rongeur 32.05
 gum scissors 08.18
 GUNNAR HEY roller forceps 12.32
 GUTHRIE double hooklet 18.07
 GUTMANN secretion scoop 66.05
 GUYON dilating bougie 66.06
 GUYON dilating set in case complete 66.06
 GUYON mandrel for rubber catheters 66.05
 GUYON pedicle clamp 12.24
 GUYTON LUNDSGAARD sclerotome 42.06
 gynecological scissors 08.13

H

HABERER (TUFFIER) retractor 18.05
 HACKSTOCK flat nose pliers 33.15
 haemorrhoidal aspirating ligator 68.10
 haemorrhoidal ligator 68.09, 68.10
 haemorrhoidal ligature rubber rings latex elastic 68.10
 haemostatic (oral) forceps 12.07
 HAGLUND STILLE plaster spreader 30.04
 HAIGHT rib spreader 56.05
 HAJEK BALLENGER septum elevator 46.17
 HAJEK CLAUDIUS antrum punch 46.12
 HAJEK gouge V-shape 46.20
 HAJEK KOFLER punch 46.11
 HAJEK mallet 32.41
 HAKANSSON bone rongeur lateral 32.04
 HALLE curette malleable 32.29
 HALLE dura knife 40.08
 HALLE septum elevator 46.16
 HALSEY needleholder 24.02
 HALSTED micro mosquito forceps 12.04
 HALSTED mosquito forceps 12.04
 HALSTED TITAN mosquito forceps 12.04
 Hamburg cannula buttoned 43.08
 hammer 32.40 - 32.44
 hammer post mortem 32.44
 hammers diagnostic 02.10
 hammers percussion 02.10
 hand dermatome 06.12
 hand drill with telescopic guide 33.05
 handle for laryngeal mirrors 52.07
 handle for vein stripper 20.05
 handle for wire saw 40.06
 handle with dental coupling 33.08
 handle with Jacobs chuck 33.06
 handle with quick coupling 33.08
 HANK uterine dilator 70.16
 HARDY curette 40.24
 HARDY dissector 40.24
 HARDY enucleator 40.24
 HARDY FAHLBUSCH dissector 40.24
 HARDY implantation fork 40.24
 HARKEN auricle clamp 56.16
 HARMIS trabeculotomy probe 42.12
 HARMANN ear speculum 44.02
 HARRINGTON bronchus clamp 56.13
 HARRINGTON retractor 18.07
 HARRINGTON scissors 08.03

HARTMANN baby hemostatic forceps 12.03
 HARTMANN bone rongeur 32.06
 HARTMANN ear catheter 44.07
 HARTMANN ear forceps 44.10, 44.11
 HARTMANN ear specula 44.02
 HARTMANN HALLE nasal speculum 46.02
 HARTMANN hemostatic forceps 12.03
 HARTMANN HOFFMANN ear forceps 44.11
 HARTMANN nasal cutting forceps 46.10
 HARTMANN nasal polypus forceps 46.06
 HARTMANN nasal speculum 46.02
 HARTMANN tongue depressor 48.02
 HARTMANN tonsil punch 50.08
 HARTMANN tuning fork 44.04
 HARTMANN tuning fork set 44.04
 HARTMANN WULLSTEIN ear forceps 44.11
 HARVEY scissors wire cutting 08.19
 HATFIELD spinal fusion curette 32.30
 HAUGH ear forceps 44.12
 HAWKIN AMBLER uterine dilator 70.16
 head mirror 02.05
 HEANEY (HEGAR) needleholder 24.05
 HEANEY biopsy curette 70.24
 HEANEY hysterectomy clamp forceps 12.30
 HEANEY retractor 18.19
 HEATH ligature scissors 08.18
 HEATH mallet 32.43
 HEBRA chalazion curette 42.08
 HEGAR dilator uterine 70.14, 70.15
 HEGAR needleholder 24.05
 HEGAR uterine dilator 70.14, 70.15
 HEGAR vascular needle holder 24.05
 HEGENBARTH clip applying forceps 26.07
 HEIFETZ brain spatula 40.15
 HEIFETZ forceps tumor 11.05
 HEIMING kidney stone forceps 62.06
 HEISS hemostatic forceps 12.13
 HEISTER mouth gag 48.05
 HELFERICH BIER amputation saw 33.02
 hemilaminectomy spreader 18.32, 18.33
 hemostat square 44.19
 hemostatic forceps 12.02 - 12.30
 HENKE tonsil elevator 50.02
 HENLY blade 18.31
 HENLY retractor 18.31
 HENNER (LEMPERT) retractor 18.29
 HENNING plaster spreader 30.04
 HENROTHIN vulsellum forceps 70.20
 heparin flushing needle 22.04
 HERBERHOLD tongue blade 48.10
 HERRICK pedicle clamp 12.25
 HERTZLER rib spreader 56.11
 HERZ tendon seizing forceps 32.25
 HESS capsular forceps 43.04
 HESS iris forceps 42.14
 HEY GROVES bone holding forceps 32.17
 HEYMANN KNIGHT nasal forceps 46.06
 HEYMANN nasal cutting forceps 46.08
 HEYMANN nasal scissors 08.09
 HEYWOOD SMITH pile forceps 68.08
 HF SURGERY 92.02 - 92.06
 HIBBS blade 18.63
 HIBBS bone chisel 32.38
 HIBBS gouge 32.38
 HIBBS osteotome 32.38
 HIBBS retractor 40.06
 hinged clamp 18.61
 HIRSCHMANN anoscope 68.05
 HIRSCHMANN cycloanalysis spatula 42.10
 HIRSCHMANN iris retractor 42.07
 HOEN dura elevator 40.09
 HOEN periotome 32.52
 HOEN spreader hemilaminectomy 18.43
 HOESEL needleholder 24.08
 HOESEL retractor 18.17
 HOFER pillar retractor 50.02
 HOFF towel clamp 14.03
 HOHMANN bone lever 32.53
 HOHMANN mini bone lever 32.55
 HOKE chisel 32.37
 holding forceps for small plates 33.21
 holding rod for fixation 40.13
 HOLTH corneoscleral punch 42.11
 HOLZBACH abdominal retractor 18.58
 hook, fistula 70.29
 hooklet mucous 46.24
 HOPKINS plaster knife 30.04

Alphabetical Index

HORGAN centre blade	18.46
HORSLEY dura dissector	40.08
HOSOBUCHI spatula bifurcated	40.25
hospital nurse set	74.03
HOUSE curette	44.18
HOWARTH elevator	32.50
HRYNYSCHAK retractor prostatic	66.03
HUBER universal handle	52.03
HUDSON brace complete	33.05
HUDSON forceps	10.03
HUMBY dermatome	06.12
humeral epicondylar plate	36.22
HUNT forceps, tumor and vessel	11.06
HUNTER splinter forceps	10.12
HUPP tracheal retractor	54.03
HURD palate needle	50.03
HURD tonsil dissector	50.02
HUSTINX perineal spreader	18.56
hypophysectomy curette	40.24, 40.25, 40.28
hypophysectomy speculum	40.23
hysterectomy clamp forceps	12.27, 12.30

JACOBSON micro forceps	12.14
JACOBSON probe buttoned	40.27
JACOBSON probe double end	40.27
JACOBSON vascular knife	40.29
JAEGER keratome	42.04
JAEGER lid plate	42.03
JAMESON caliper	42.11
JAMESON muscle clamp	43.07
JAMESON scissors	08.07
JAMESON strabismus forceps	42.16
JAMESON strabismus hook	42.07
JAMISON needleholder	24.05
JANSEN bone rongeur	32.05
JANSEN double spoon sharp	32.31
JANSEN ear forceps	44.09
JANSEN GIFFORD retractor	18.27
JANSEN nasal forceps	46.05
JANSEN periosteal	32.46
JANSEN retractor	18.27
JANSEN STRUYCKEN septum forceps	46.12
JANSEN WAGNER spreader	18.27
jar	88.04
jar with dressing forceps	88.04
JARCHO tenaculum forceps	70.18
JATHO nasopharyngeal forceps	46.26
JAVERTS sponge forceps	16.04
JEANS forceps	10.06
JENNINGS mouth gag	48.06
JEWETT dilating bougie	66.08
JEWETT nail	36.08
JEWETT nail impactor extractor	34.11
JOBSON HORNE cotton applicator	20.06
JOHNS HOPKINS serrefine	12.03
JOHNS HOPKINS hemostatic / gall duct forceps	12.23
JOHNSON needleholder	24.06
JOLL thyroid retractor	54.04
JONES hemostatic forceps	12.09
JONES towel clip	14.02
JOSEPH (LEWIS) nasal rasp	46.21
JOSEPH knife nasal	46.14
JOSEPH MASING periosteal elevator	46.17
JOSEPH mucous hooklet	18.07
JOSEPH nasal saw	46.23
JOSEPH periosteal elevator	46.16
JOSEPH plastic knife	46.13
JOSEPH scissors	08.06
JOSEPH septum elevator	46.16
JUDD ALLIS forceps	64.02
JUDD MASSON bladder retractor	66.03
JUERS forceps wire bending	44.12
JULIAN needle holder	24.05
JURASZ laryngeal polypus forceps	52.02

KEVORKIAN curette biopsy	70.23
KEVORKIAN Pacific biopsy punch	70.27
KEVORKIAN tip	70.28
KEY elevator	32.50
key for three-jaws-chuck	33.07
key inner hexagon	34.13
KEYES cutaneous punch set	74.03
KEYES handle	74.03
KEYES punch	74.03
kick bucket	88.04
kidney bowl	88.03
kidney stone forceps	62.05, 62.06
KIELLAND LUIKART obstetric forceps	72.03
KILLIAN CLAUSS gauge	46.20
KILLIAN septum compression forceps	46.07
KILLIAN septum elevator	46.17
KILLIAN septum gouge	46.20
KILLIAN septum scissors	46.11
KILLIAN septum speculum	46.04
KILLIAN wash cannula	46.13
KILNER alar retractor	46.24
KILNER DOUGHTY mouth gag	48.08
KILNER needle holder	24.03
KILNER scissors	08.06
KILNER skin retractor	74.02
KIRBY ARTHUR iris forceps	42.15
KIRK hammer	32.40
KIRSCHNER abdominal retractor	18.48
KIRSCHNER abdominal retractor folding	18.49
KIRSCHNER bow	33.12
KIRSCHNER bow American	33.12
KIRSCHNER drill with wire guide	33.05
KIRSCHNER frame	18.48
KIRSCHNER ligature conductor	26.04
KIRSCHNER wiredrill	33.10
KLAPP tendon sheath retractor	18.12
KLEINERT KUTZ bone cutting forceps	32.14
KLEINSASSER operating laryngoscope	52.05
KLEINSCHMIDT appendectomy forceps	64.04
KLINKENBERGH LOTH thoracic scissors	08.16
KNAPP cataract spoon	42.08
KNAPP iris knife	42.05
KNAPP LUER trachoma forceps	43.07
KNAPP retractor	42.07
KNNAUS vascular knife	40.29
knee retractor	32.56, 32.57
knife circular	44.17
knife nasal	46.14
knife nasal plastic	46.14
knife periosteal	44.19
knife, interosseous	06.11
knife, phalangeal	06.11
KNIGHT nasal cutting forceps	46.08
KNIGHTON laminotomy retractor blade	18.35
KNOLLE retractor blunt	42.07
KNOWLES bandage scissors finger	08.21
KOCHER goitre director	54.04
KOCHER goitre retractor	18.28, 66.03
KOCHER hemostatic forceps	12.08
KOCHER intestinal forceps	64.06
KOCHER LANGENBECK retractor	18.15
KOCHER Nippon hemostatic forceps	12.07
KOCHER retractor	18.11, 18.14, 18.15, 18.17

KOENIG elevator	32.50
KOENIG ligature conductor	26.04
KOENIG retractor	18.10
KOENIG suture needle fishhook	26.06
KOERTE retractor	18.17, 18.26
KOGAN endo speculum	70.13
KONRICH box	88.05
KOOS vascular knife	40.29
KRAUSE forceps tip	52.03
KRAUSE nasal snare	46.13
KRAUSE snare ear polypus	44.09
KRAYENBUEHL nerve retractor	40.26
KRESSNER septum forceps	46.10
KRISTELLER vaginal retractors	70.08
KRISTELLER vaginal specula	70.07 - 70.09
KROENLEIN hemostatic forceps	12.11
KRONECKER needle	26.02
KUEMMEL retractor abdominal	18.19
KUENTSCHER extractor	33.19
KUENTSCHER medullary reamer	33.18
KUENTSCHER nail driver	33.19
KUENTSCHER nail femur	36.04, 36.05
KUENTSCHER nail humerus	36.06

I.U.D. extracting hook	70.21
I.U.D. remover flexible grasper	70.21
identification tape for instruments	88.10
impactor and extractor	34.04
impactor extractor for flexible medullary nails	34.10
impactor for DHS screws	34.07
impactor for flexible medullary nails	34.10
impactor for staples	34.12
implant fork	40.24
incision scissors	08.10
Infant rib spreader	56.05
INGE spreader vertebrae	40.16
injection cannula for positive pressure	52.06
injection needle tonsil	50.08
insertor for angular blades	34.05
insertor for flexible medullary nails	34.10
instrument case stainless steel	88.07
instrument holder	88.23
instrument holder „safety pin“	28.02
instrument milk	88.23
instrument tray	88.04
intestinal crushing clamp	64.12
intestinal forceps	64.04 - 64.11
intestinal forceps atraumatic	64.05
intestinal forceps child size	64.04
intestinal needle	26.06
intestinal seizing forceps	64.03
intima spatula	56.18
intra uterine cannula	70.30
intramedullary nail flexible	36.03
introducer for bone nails	34.12
intubation tube	54.03
IOWA vulsellum forceps	70.19
IP lubrication spray	88.23
IR detergent for basic cleaning	88.23
iridectomy scissors	09.02, 09.03
iris forceps	42.13 - 42.17
iris hook	42.07
iris knife	42.05
iris retractor	42.07
iris scissors	08.07
iris spatula	42.09
irrigating cannula	46.29
irrigator	88.03
IRWIN MOORE nasal turbinate forceps	46.08
ISRAEL retractor	18.16
ITARD ear catheter	44.07
ITERSON trachea hook blunt	54.02
IVES FANSLER anoscope	68.05

JACKSON BURROWS retractor knee soft parts	18.31
JACKSON goitre spreader	18.27
JACKSON speculum	70.10
JACKSON tampon forceps	52.02
JACKSON trachea tube	54.03
Jacobs chuck	33.07
JACOBS vulsellum forceps	70.19
JACOBSON double curette	32.32

K	
KABIERSKE powder blower	44.05
KADER retractor	18.20
KALLMORGEN retractor	70.09
KALLMORGEN speculum	70.09
KALT ARRUGA needleholder	24.10
KALT capsular forceps	43.04
KALT needleholder	24.10
KANE umbilical cord clamp	72.05
KANTROWITZ forceps	12.20
KATZIN corneal scissors	09.03
KEITH suturing needle	26.06
KELLY (fistula) scissors	08.13
KELLY GRAY curette	70.23
KELLY grip retractor	18.05
KELLY hemostatic forceps	12.05, 12.15
KELLY proctoscope	68.05
KELLY RANKIN hemostatic forceps	12.05
KELLY retractor	18.05, 18.18
KELLY scissors	08.13
KELLY titanium hemostatic forceps	12.05
KELLY uterus polypus forceps.	70.20
keratome	42.04
keratoplasty knife	42.06
KERBOUL humeral epicondylar plate	36.22
KERBOUL proximal humerus plate	36.22
KERBOUL radial plate	36.22
KERBOUL tibial plate	36.22
KERN bone holding forceps	32.16
KERPEL bone curette	32.27
KERRISON punch	46.11
KEVORKIAN biopsy forceps	70.26

Alphabetical Index

KUENTSCHER reamer femur	33.18
KUHNT corneal scarifier	42.06
LABORDE tracheal dilator	54.02

L

lacrimal dilator	42.11, 42.12
lacrimal probe	42.12
lacrimal sac dissector	42.09
lacrimal sac spreader	42.03
LACK tongue depressor	48.03
LAFORCE adenotome	46.28
LAFORCE foreign body instrument	42.06
lag screw hip dynamic	36.09
LAHEY (SWEET) gall duct forceps	12.22
LAHEY dura retractor	40.05
LAHEY gall duct forceps	12.22
LAHEY goitre seizing forceps	54.04
LAMBERT chalazion forceps	43.06
LAMBOTTE bone holding forceps	32.15, 35.16
LAMBOTTE mini osteotome	32.36
LAMBOTTE osteotome	32.36
laminectomy and cervical retractor	40.16
laminectomy forceps	40.17 - 40.22
laminectomy punch	40.21, 40.22
laminectomy spreader	18.40, 18.64, 56.06
LANCASTER eye speculum	42.03
LANDAU speculum	70.13
LANDOLT curette	40.25
LANDOLT eudeator	40.25
LANDOLT micro scalpel handle	06.08
LANDOLT REULEN curette	40.25
LANDOLT REULEN dissector	40.25
LANDOLT REULEN hooklet	40.25
LANDOLT REULEN raspatory	40.25
LANDOLT spreader for specula	40.23
LANE (PAUCHET) towel forceps	14.04
LANE bone holding forceps	32.16
LANE bone lever	32.56
LANE forceps tissue	10.05
LANE retractor	18.03
LANE screwdriver	33.20
LANE stomach clamp forceps	64.11
LANG lacrimal sac dissector	42.09
LANG forceps tip	52.03
LANG HOHMANN bone lever	32.54
LANGENBECK bone holding forceps	32.15
LANGENBECK ear curette	44.08
LANGENBECK elevator	32.46, 32.49
LANGENBECK finger protector	48.12
LANGENBECK finger saw	33.03
LANGENBECK flap knife	06.11
LANGENBECK GREEN retractor	18.10
LANGENBECK MANNERFELDT retractor	18.25
LANGENBECK mini retractor	18.10
LANGENBECK needle holder	24.07
LANGENBECK periosteal	32.46
LANGENBECK resection knife	06.10
LANGENBECK retractor	18.13, 18.14
laparotomy frame nylon only	18.47
laryngeal cotton applicator	20.06
laryngeal mirrors	52.07
laryngeal polypus forceps	52.02
laryngoscope battery handles	04.06
laryngoscopes	04.05, 04.06, 52.05
lateral retractor for vaginal specula	70.06
LAWRENCE hemost., diss., ligature forceps	12.19
LE MEE tongue depressor aspirating	48.03
lead hand splint	32.22
LEBSCHER sternum chisel	32.38
LEE obstetric forceps	72.02
LEECH WILKINSON intra uterine cannula	70.30
LEFORT dilating bougie	66.08
left hander needle holders	24.02 - 24.04
left hander scissors	08.02, 08.03, 08.05, 08.07, 08.20
LEGUEU bladder retractor	66.03, 66.04
LEKSELL (STILLE) rongeur	32.09
LEKSELL rongeur	32.09
LEMMON sternal approximator	56.12
LEMPERT curette	32.29

LEMPERT elevator	44.19
LEMPERT retractor	18.29
LEMPERT rongeur	32.04
lens hook	42.07
lens implantation forceps	42.18
lens scoop	42.09
LERCHE forceps	10.05
LERICHE hemostatic forceps	12.12
LERICHE retractor abdominal	18.19
LESTER fixation forceps	43.03
lever foreign bodies	44.10
lever phalangeal	32.51
LEVINSON foreign body needle	42.06
LEWIN bone holding forceps	32.19
LEWIS nasal rasp	46.21
LEXER baby scissors	08.04
LEXER bone chisel	32.36
LEXER chisel spongiosa	32.37
LEXER fino scissors	08.04
LEXER gouge	32.36, 32.37
LEXER mini chisel	32.36
LEXER osteotome	32.37
LEXER scissors	08.04
LEXER spongiosa chisel	32.37
LEYLA ear specula holder	40.10
LEYLA retractor system	40.10 - 40.14
LICHTENBERG needle holder	24.08
LICHTWITZ antrum trocar needle	46.13
lid for tray miniperforation	88.08
lid plate	42.03
ligature conductor	26.03, 26.04, 40.26, 50.03, 66.02
ligature forceps	26.07
ligature fork for deep tying	26.04
ligature needle	26.02, 26.03
ligature rings rubber haemorrhoidal	68.10
ligature scissors	08.17, 08.18
lip and cheek retractor	48.04
lip retractor	48.03
LISTER (sinus) swab forceps	16.04
LISTER bandage scissors	08.20
LISTER BURCH eye speculum	42.03
LISTON amputation knife	06.10
LISTON bone cutting forceps	32.13
LITTAUER cilia forceps	43.10
LITTAUER ligature scissors	08.18
LITTAUER nasal polypus forceps	46.06
Little Joker periosteal elevator	32.46
LITTLE retractor	18.12
LITTLE scissors	08.04
LITTLEWOOD tissue forceps	64.04
LLOYD DAVIS biopsy specimen forceps	68.07
LLOYD DAVIS pelvis retractor	18.19
LLOYD DAVIS proctoscope	68.04
LLOYD DAVIS rectal scissors	08.16
LLOYD DAVIS rectoscope	68.04
LLOYD DAVIS sigmoid anastomosis forceps	64.08
LLOYD DAVIS sigmoidoscope	68.04
LLOYD impactor for femoral nails	34.11
LLOYD impactor/extractor	33.19
LOCKHART MUMMERY director	20.04
LOCKLIN scissors	08.07
LOCKWOOD ALLIS intestinal seizing forceps	64.03
LOCKWOOD intestinal forceps fenestrated	64.03
LOGAN retractor	18.26
loops nasal snare	46.13
LORDAN chalazion forceps	43.06
LORENZ bandage scissors	08.21
LORNA (EDNA) towel forceps	14.03
LORTAT JACOB instrument holder	88.23
LOUTE wire tightener/twister	33.13
LOVE GRUENWALD forceps laminectomy	40.17
LOVE nerve root retractor	40.06
LOVE uvula retractor	50.02
LOVELACE hemostatic forceps	12.10
LOVELACE lung grasping forceps	56.13
LOWER gall duct forceps	12.23
LOWMAN bone holding clamp	32.22
LUBET BARBON nasal polypus forceps	46.06
LUC nasal cutting forceps	46.08
LUCAE ear forceps	44.09
LUCAE hammer	32.41
LUCAE hooklet buttoned	44.09
LUCAE paracentesis needle horizontal	44.07
LUCAE tuning fork	44.05
LUER bone rongeur	32.03

LUER KOERTE gall stone scoop	62.04
LUER pile forceps	68.08
LUER retractor	18.03
LUER rongeur	32.03
LUER tracheotomy tube	54.03
LUIKART BILL tractor	72.04
LUIKART obstetric forceps	72.03
lumbar puncture needle	22.04
LUNDSGAARD sderotome	42.06
lung (thorax) scissors	08.16
lung grasping forceps	56.13
lung spatula	56.12
LUNIATSCHEK gauze packer	50.03
lupus curette	74.02
lupus scraper	74.02

M

MAGILL aspirating tube	04.03
MAGILL catheter introducing forceps	04.04
MAIER polypus forceps with ratchet	16.02
MAINGOT hysterectomy forceps	12.30
MAINGOT intestinal forceps	10.10
MAISONNEUVE urethrotome	66.04
MALIS blade system	18.61
MALIS cerebellar retractor	18.61
mallet	32.40, 32.41, 32.43
malleus nipper	44.13
MALTZ (COTTLE) nasal rasp	46.21
mandrel for rubber catheters	66.05
MANNERFELDT forked hook	18.24
MANNERFELDT hooklet	18.24
MANNERFELDT retractor	18.25
MANNERFELDT spatula double	18.25
MANNERFELDT spring hook	18.25
MANNERFELDT tendon hook double	18.25
marker	42.11
MARKHAM MEYERDING retractor	18.38
MARKWALDER rongeur	32.13
MARSCHIK tonsil forceps	50.05
MARTIN cartilage holding forceps	32.20
MARTIN dressing forceps	16.06
MARTIN pelvimeter	72.05
MARTIN retractor	18.18
MARTIN tenaculum forceps	70.17
MARTIN uterine sound	70.22
MARTINI double curette	32.32
MASING periosteal elevator	46.17
Mass. Gen. Hospital needle holder	24.06
MASSON needleholder	24.05
MASTIN muscular forceps	54.04
MATHIEU foreign body forceps	66.04
MATHIEU needleholder	24.08
MATHIEU rectal speculum	68.03
MATHIEU retractor	18.02, 18.03
MATSON ALEXANDER periosteal	32.48
MATSON periosteal	32.48
MAUNDER oral screw	48.12
MAY ophthalmoscope oto-ophthalmoscope	02.07
MAYFIELD bone rongeur	32.11
MAYO (HARRINGTON) scissors	08.03
MAYO ADAMS retractor	18.30
MAYO BLAKE gall stone forceps	62.02
MAYO COLLIN retractor	18.02
MAYO GUYON pedicle clamp	12.24
MAYO HEGAR needleholder	24.04
MAYO kidney stone probe	62.04
MAYO NOBLE scissors	08.04
MAYO ROBSON intestinal forceps	64.07, 64.12
MAYO Russian forceps	10.06
MAYO 'safety needle'	28.02
MAYO scissors	08.03
MAYO STILLE scissors	08.03
McCREA dilating bougie	66.08
McCULLOUGH strabismus forceps	42.16
McDONALD elevator	32.50
McGEE forceps wire bending	44.12
McGEE hooklet	44.18
McGIVNEY (SCHÜTZ) haemorrhoidal ligator	68.09
McGIVNEY grasping forceps	68.08
McGUIRE corneal scissors	09.02
McINDOE bone cutting forceps	32.14
McINDOE cartilage scissors	08.15
McINDOE forceps	10.07
McINTOSH laryngoscope	04.05

Alphabetical Index

McIVOR mouth gag	48.08
McIVOR tongue depressor	48.08
McKENY septum elevator	46.15
McKENZIE brain clip rack	40.03
McKENZIE clip applying forceps	40.02
McKENZIE drill	33.05
McKISSOCK scissors dural	08.15
McLAUGHLIN disc/washer/screw set	36.07
McLAUGHLIN plate	36.07
McLEAN LUIKART obstetric forceps	72.03
McLEAN TUCKER LUIKART obstetric forceps	72.03
McPHERSON tying forceps	43.05
McPHERSON tying forceps titanium	43.05
MEAD hammer	32.42
MEAD rongeur	32.02
measure graduated	88.03
measuring gauge for bone screws	33.23
measuring probe	44.19
medicine cup graduated	88.03
Med-i-Tape instrument identification tape	88.10
medullary reamer	33.18
MEEKER hemostatic, dissecting, ligature forceps	12.19
MELLINGER AXENFELD eye speculum	42.02
MELLINGER eye speculum	42.02
MENGHINI aspirating syringe	22.05
MENGHINI needle for liver puncture	22.05
MENGHINI trocar for liver puncture needle	22.05
meniscomome	32.58
MERCEDES thorax spreader	56.08
METZENBAUM fino scissors	08.05
METZENBAUM needleholder	24.06
METZENBAUM scissors	08.05
MEYER reduction forceps	32.21
MEYERDING blade	18.63
MEYERDING retractor	18.12
MEYERDING spreader laminectomy	18.38
MEYHOEFER chalazion curette	42.08
MICHEL clips	26.08
MICHEL clips applying forceps	26.07
MICHEL combined clip forceps	26.07
MICHEL mirror postrhinoscopic	46.05
micro grasping laryngeal forceps	52.04
micro mosquito forceps	12.04
micro needle holder	24.10 - 24.12
micro raspatory	40.27
micro scalpel blade	06.08
micro scalpel handle	06.08
micro scissors	09.04
micro thumb and tissue forceps	10.03, 10.04, 11.02, 12.14
microlaryngeal forceps	52.04
MIDDELORPF retractor	18.16, 18.22
MIDDLETON JANSEN cutting forceps	46.12
MIKULICZ peritoneum forceps	12.26
MIKULICZ retractor	18.18
MILAN curette malleable	70.24
MILLIGAN dura dissector	40.07
MILLIN suction tube	04.03
MILLIN bladder neck spreader	66.04
MILLIN capsule forceps	66.02
MILLIN ligature conductor	66.02
MILLIN prostatic lobe holding forceps	66.02
MILLIN spreader bladder	66.04
mini bone lever	32.55
mini chisel	32.36
mini container	88.19
mini gouge	32.36
mini head light	02.06
mini osteotome	32.36
mini retractor	18.03, 18.10
mini rongeur	32.02
mini vein stripper set	20.04
mirror postrhinoscopic	46.05
MISKIMON cerebellum retractor	18.30
MIXTER baby hemostatic forceps	12.21
MIXTER forceps serrated	12.20
MIXTER gall duct forceps	12.23
MIXTER gall stone forceps	62.02
MIXTER hemostatic, bronchus forceps	12.21
MIXTER hemostatic, broncus, gall duct forceps	12.22
MIXTER O'SHAUGNESSY forceps	12.22
MOCK heparin flushing needle	22.04
MOELTGEN goniometer	02.11
MOLLISON spreader	18.29, 18.34
MOORE bone hand drill	33.04
MOORE gall stone scoop	62.02
MOORFIELD suture forceps	43.05

MORITZ SCHMIDT tongue depressor	48.03
MORRIS retractor	18.18
MORSE FAVALORO rib spreader	56.09
MORSE rib spreader	56.08
mosquito forceps	12.04, 12.09
mouth gag	48.05 - 48.10
MOYNIHAN clamp forceps	12.23
MOYNIHAN gall stone probe	62.03
MOYNIHAN hemostatic forceps	12.07
MOYNIHAN towel forceps	14.04
MUCK knife periosteal	44.19
mucosa knife	46.14
mucous hooklet	18.07
mucus evacuator	70.30
MUELLER eye speculum	42.03
München biopsy curette	70.23
MURDOCK eye speculum	42.02
MURPHY LANE bone skid	32.52
MURPHY LANE elevator double	32.52
MURPHY retractor	18.12
muscle clamp	43.07
muscle forceps	43.07
muscle retractor	18.64
muscular forceps	43.02, 54.04
muscular hook	42.07
MUSEUX vulsellum forceps	70.17, 70.19
MYERS vein stripper	20.03
MYLES irrigating cannula	46.29
MYLES nasal cutting forceps	46.10
myoma knife	70.29
myoma screw	70.29

N

NABATOFF varicose vein probe set	20.03
NAEGELE obstetric forceps	72.02
NAGER palate retractor	50.02
NAGER tonsil needle	50.03
nail brush	74.05
nail driver	33.14, 33.19, 34.11
nail extracting forceps	33.03
nail femur neck	36.08
nail file	74.04
nail hook	36.02
nail humerus	36.06
nail impactor and extractor	33.18, 34.11
nail intramedullary	36.03 - 36.06
nail nipper	74.03, 74.04
nail splitting scissors	08.22
nail starter	34.11
nail three-flange	36.07
nasal cutting forceps	46.07 - 46.12
nasal polypus forceps	46.06
nasal rasp	46.21, 46.22
nasal saw	46.23
nasal scissors	08.09
nasal snare	46.13
nasal specula cold light	46.04
nasal speculum	46.02 - 46.04
nasal tampon forceps	46.06
nasopharyngeal forceps cutting	46.26
NATIONAL HOSPITAL percussion hammer	02.11
NAUNTON MORGAN needleholder	24.07
needle and gouge	42.10
needle and spud	42.10
needle case	88.02
needle holder	24.01 - 24.12
needle holders for left handers	24.02 - 24.04
needle ligature	26.02, 26.03
needle liver biopsy	22.05
NEFF meniscomome	32.58
NEGUS chest support for mouth gag	48.11
NEGUS tonsil forceps	12.15
NEIVERT needleholder	24.02
NEIVERT retractor	46.25
NELATON grooved director	20.02
NELSON forceps	10.09
NELSON ligature needle	26.02
NELSON trocar thorax	22.03
neodisher® IP lubrication spray	88.23
neodisher® IR detergent for basic cleaning	88.23
neodisher® IS detergent for basic cleaning	88.23
nerve hook	40.05, 40.06
nerve preparation scissors	08.14
nerve retractor	40.26

nerve root retractor	40.06
neurosurgical scissors	08.15
NICOLA curette malleable	40.24
Nippon hemostatic forceps	12.07
NISSEN gall duct and cysticus forceps	12.21
NISSEN hemostatic forceps	12.14
noise apparatus	44.05
NORFOLK and NORWICH retractor	18.36
NORTHBENT (SPENCER) ligature scissors	08.17
NORTHFIELD bone rongeur	32.07
NORTHFIELD retractor	18.35
NOTO uterus polypus forceps	70.20
NOVAK aspiration curette	70.23
NOYES iris scissors	09.02
NOYES nasal polypus forceps	46.07
NUGENT eye forceps	42.16
obstetric forceps	72.02 - 72.04

O

OCHSNER gall stone probe	62.02
OCHSNER ligature forceps	26.07
OCHSNER trocar thoracic	22.03
O'CONNOR iris hook sharp	42.07
OETTINGEN retractor	18.60
OLDBERG forceps laminectomy	40.18
OLIVECRONA brain spatula	40.15
OLIVECRONA dura dissector	40.07
OLIVECRONA rongeur	32.04
OLIVECRONA TOENNIS clip forceps	40.03
OLIVECRONA trigeminus knife	40.09
OLIVECRONA wire saw	40.06
OLLIER retractor	18.16
OLSEN HEGAR needleholder	24.08
OMBREDANNE mallet	32.40
operating laryngoscope	52.05
ophthalmoscope	02.07
oral screw	48.12
orbital retractor	42.08
organ knife	06.13
osteotome	32.33 - 32.39
osteotomy staple	36.25
O'SULLIVAN O'CONNOR abdominal retractor	18.43
O'SULLIVAN O'CONNOR vaginal speculum	70.13
OTIS dilating bougie	66.08
OTIS spare knife only	66.04
OTIS urethrotome	66.04
oto-ophthalmoscope	02.07
otoscope	02.06
OVERHOLT baby hemostatic forceps	12.15
OVERHOLT double periosteal	32.48
OVERHOLT forceps	12.16
OVERHOLT GEISSENDOERFER forceps	12.16
OVERHOLT MARTIN forceps	12.16
OVERHOLT MIXTER forceps	12.21

P

Pacific biopsy punch	70.27
palate needle	50.03
palate retractor	50.02
PALMER bone nail	36.07
PALMER impactor for bone nails	34.12
PALMER introducer for bone nails	34.12
PAPAVERO CASPAR speculum	40.23
paper filters for sterilizing containers	88.24
paracentesis needle	44.07, 44.08
parallel aiming device for bone wires	33.24
parametrium scissors	08.12
PARHAM band	32.22
PARHAM band tightener	32.22
PARK eye speculum	42.03
PARKER MOTT retractor set	18.02
PARKER retractor double pair	18.02
PARKER scalpel	06.10
partition wall for sterilizing trays	88.09
PARTSCH bone chisel	32.34
PARTSCH gouge	32.34
PARTSCH hammer	32.41
PASSOW hemostat	44.19
patella holding forceps	32.21
PATON corneal dissector	42.06
PAUCHET towel forceps	14.04
PAUFIQUE keratoplasty knife	42.06
PAUFIQUE tying forceps	43.05

Alphabetical Index

PAYR baby intestinal crushing clamp 64.12
 PAYR intestinal crushing clamp 64.12
 PAYR ligature conductor 26.04
 PEAN hemostatic forceps 12.08
 PEAN Nippon hemostatic forceps 12.07
 PEDERSON speculum 70.02
 pedicle clamp 12.24, 12.25
 PEERS BERTRAM towel clamp 14.03
 PEET splinter forceps 10.13
 PELKMANN dressing forceps 16.04
 pelvimetre 72.05
 pelvis retractor 18.19
 PENFIELD dura dissector 40.08
 penile clamp 66.05
 PENNINGTON hemostatic forceps 12.10
 PENNYBACKER rongeur 32.06
 percussion hammers 02.10
 PERCY retractor for amputation 33.02
 perineal retractor 18.56
 perineal spreader 18.56
 periosteal elevators 32.45 - 32.51, 46.17
 periostome 32.47 - 32.52
 peritoneum forceps 12.26, 12.27
 PERTHES reamer square 33.10
 PESTALOZZA abortion curette 72.06
 PETRI dish 88.04
 phalangeal lever 32.51
 PHANEUF peritoneum forceps 12.27
 PHILLIPS screwdriver blade 34.13
 phlebodissector 20.05, 44.17, 44.18
 PIERCE antrum trocar 22.02
 PIFFARD lupus curette 74.02
 pigtail probe 42.12
 pile forceps 68.08
 pin wrench 34.03
 PINARD stethoscope aluminium 02.09
 PINARD stethoscope plastic 02.09
 pin-wheel 02.11
 PIPER delivery forceps 72.04
 pituitary curette 40.28
 pituitary forceps 40.09
 placenta and ovum forcep 72.06
 plaster cast breaker 30.04
 plaster cast saw 30.02
 plaster cast shear 30.02
 plaster knife 30.04
 plaster scissors 08.21
 plaster spatula 20.05
 plaster spreader 30.04
 plastic knife 46.13
 PLESTER flap knife 44.17
 PLESTER retractor 18.29
 PLESTER suction cannula 44.06
 pleura biopsy needle 22.04
 PLEY eye speculum 42.03
 plugger 32.38
 pneumoperitoneum needle 22.03
 POIRIER tissue forceps 12.11
 POLITZER air bag complete 44.06
 POLITZER paracentesis needle 44.07
 POLLOSON retractor 18.23
 polypus forceps 16.02
 POOLE aspiration tube 04.02
 POPPEN aspirating tube 40.15
 positioning plates 34.05, 34.06
 post mortem needle 26.07
 post mortem set 32.39
 postnasal speculum 46.05
 POTTS DE MARTEL vascular scissors angular 08.10
 POTTS SMITH forceps 10.02
 POTTS SMITH vascular scissors 08.11
 powder blower 44.05
 POZZI tenaculum forceps 70.18
 PRATT (BILLROTH) vulsellum forceps 70.19
 PRATT cystic hook 68.06
 PRATT dilator double 70.16
 PRATT rectal speculum 68.02
 preparation scissors 08.13, 08.14
 PRICE THOMAS bronchus clamp 56.14
 PRINCE muscular forceps 43.02
 PRINCE tonsil scissors 08.10
 probe buttoned 20.02, 40.27
 probe myrtle leaf 20.02
 proctoscope 68.05
 prostate catheter 66.07

prostatic forceps 66.02
 prostatic retractor 66.02
 prostic lobe holding forceps 66.02
 protective hood 46.10
 PROVIDENCE HOSPITAL hemostatic forceps 12.06
 punch laminectomy 40.21, 40.22
 punch, nasal 46.11, 46.12
 PUTTI bone rasp 32.59
 PYE SMITH (HARRISON) sterilization forceps 28.02
 pylorus stenosis spreader 64.04

Q

QUERVAIN elevator 32.50
 QUINBY gum scissors 08.19
 QUIRE lever foreign bodies 44.10
 QUISLING hammer intranasal 32.44
 quiver for high frequency diathermy electrodes 88.22

R

rachiotome 32.38
 rack for sterilization and storage of wire drills 88.22
 rack portable for mini containers 88.19
 radiometry cannula curved 22.06
 RADOLF nail extracting forceps 33.03
 RAGNELL DAVIS retractor 18.05
 RALK bone hand drill 33.06
 RAMEL pleura biopsy needle 22.04
 RAMPLEY swab forceps 16.03, 16.04
 RAMSAY forceps serrated 10.06
 RANDALL aspirating curette 70.23
 RANDALL kidney stone forceps 62.05
 RANEY clip applying and removing forceps 40.04
 raspatory, hypophysectomy 40.24, 40.25, 40.27

RAY pituitary curette 40.24, 40.28
 razor blade for blade breaker 06.07
 razor knife 06.13
 reamer femur 33.18
 reamer for intramedullary pins 33.18
 reamer for quick-action chuck 34.04
 reamer medullary elastic 34.09
 reamer medullary flexible 33.10
 reamer square 34.08
 reamer triple for DHS screws 70.32
 RECAMIER curettes uterine 68.06
 rectal polypus snare 08.16
 rectal scissors 68.02, 68.03
 rectal speculum 68.03
 rectal spreader 68.04
 reotoscope 68.04
 rectus forceps 43.02
 Red Cross bandage scissors 08.21
 Redon needle 04.04
 reduction forceps 32.20, 32.21
 REICHERT epiglottis retractor 52.02
 REILL reduction forceps 32.20
 REILL wire cutting forceps 33.17
 REINER ear syringe 44.06
 REINER plaster knife 30.04
 remover for scalpel blades 06.05
 reposition forceps 32.20
 resection knife 06.10
 retractors 18.02 - 18.64
 REVERDIN (ALBARRAN) needle 26.03
 REVERDIN abdominal retractor 18.06
 REYNOLDS (JAMESON) scissors 08.07
 RF surgery 92.02 - 92.06
 RHEINSTAEDTER flushing curette 70.24
 rib approximator 56.12
 rib shear 56.02, 56.03
 rib spreader 56.04 - 56.11
 RIBBON retractor 18.05
 RICARD retractor abdominal 18.59
 RICHARDSON EASTMAN retractor 18.04
 RICHARDSON grip retractor 18.04
 RICHARDSON retractor 18.04
 RICHTER HEATH clip forceps 26.08
 RIECKER KLEINSASSER chest support 52.06
 RIGBY retractor rectum, vagina 18.56
 RING tongue blade 48.11
 RITCHEY nail starter 34.11
 RITTER HALLE frontal sinus dilator 46.29
 ROBB dissector 56.18

ROBERTS hemostatic forceps 12.18
 ROBIN MASSE abdominal retractor 18.60
 ROBIN towel clamp 14.04
 ROCHARD retractor system 18.61
 ROCHESTER CARMALT hemostatic forceps 12.09
 ROCHESTER OCHSNER hemostatic forceps 12.08
 ROCHESTER PEAN hemostatic forceps 12.08
 ROEDER ligator 50.03
 ROEDER towel forceps 14.03
 ROETTGEN RUSKIN rongeur 32.08
 ROGER septum elevator 46.16
 ROGERS forceps parametrium 12.29
 ROGGE sterilizing forceps 28.02
 roller forceps 12.32
 roller knife 44.17
 ROLLET extirpation chisel 42.06
 ROLLET retractor 42.07
 rongeur 32.02 - 32.13, 40.18 - 40.20

ROSE trachea hook 54.03
 ROSEN knife 44.17
 ROSEN needle 44.18
 ROSENBERG forceps tip 52.03
 ROSER KOENIG mouth gag 48.05
 ROSS retractor aorta 56.13
 round bowl 88.03
 round nose pliers 33.14
 ROUX baby retractor 18.03
 ROUX MAGNUS retractor 18.03
 ROUX mini retractor 18.03
 ROUX retractor 18.02
 ROWE forceps 48.12
 ROY CAMILLE plate cervical spinal 36.23
 ROY CAMILLE plate cervical straight 36.23
 ROY CAMILLE spinal plate curved 36.23
 RUBIN septum crushing forceps 46.10
 RUDD haemorrhoidal ligator complete 68.09
 ruler metal 02.12
 RUMEL thorax forceps 12.17
 ruptured disc curette 32.29
 RUSKIN bone rongeur 32.08
 RUSKIN LISTON bone cutting forceps 32.14
 RUSSEL DAVIS tongue depressor 48.09
 Russian forceps 10.06
 RYDEL SEIFFER tuning fork 44.05
 RYDER needleholder 24.04
 RYDER vascular needleholder 24.05

S

SAALFELD comedo extractor 74.02
 SACHS dura dissector 40.07, 40.08
 SACHS nerve hook 40.05
 SAENGER placenta and ovum forceps 72.06
 SALENIUS meniscatome 32.58
 salpingograph complete 70.30
 SANVENERO scissors 08.06
 SAROT bronchus clamp 12.18, 56.14
 SAROT needleholder 24.07
 SATINSKY anastomosis clamp 56.15
 SATINSKY thorax scissors 08.16
 SATINSKY vena cava clamp 56.15
 SATO corneal knife 42.05
 SATTERLEE amputation saw 33.03
 SAUER eye speculum 42.02
 SAUERBRUCH bone rongeur 32.09
 SAUERBRUCH FREY rib shear 56.03
 SAUERBRUCH needle case 88.02
 SAUERBRUCH retractor 18.20, 18.21
 SAUERBRUCH rib shear 56.03
 SAUERBRUCH waste forceps 28.02
 saw blade 30.03, 33.02, 33.03
 saw conductor 40.06
 saw, finger 33.03
 saws and burr set 33.07
 SAWTELL tonsil forceps 12.14
 SCAGLIETTI rongeur 32.10
 scalp flap forceps 12.10, 72.05
 scalp hemostasis clip 40.04
 scalp blade microsurgical 06.08
 scalp blade remover 06.05
 scalp blade sterile 06.05
 scalp blade delicate 06.10
 scalp handle 06.02 - 06.04
 scalp handle bayonet shape 06.04

Alphabetical Index

scalpel handle micro	06.08	secretion scoop	66.05	SMITH PETERSEN nail hip 3 flange	36.07
scalpel metal handle	06.09	SEDILLOT periosteal	32.45	SMITH PETERSEN rongeur	32.11
starifier	42.04	SEGOND myoma knife	70.29	SMITH US Army gauze scissors	08.20
SCHAEDEL (SHRADLE) towel clip	14.02	SEIDEL speculum set	70.11	SMITHWICK clip applying forceps	40.02
SCHAMBERG comedo extractor	74.02	SEIFFERT forceps tip	52.03	SMITHWICK nerve hook	40.06
SCHÉDE bone curette	32.26	seizing forceps for instruments universal	28.02	snare ear polypus	44.09
SCHÉIBE forceps organ grasping	64.04	seizing forceps intestinal, tissue	64.03	SNELLEN entropium forceps	43.07
SCHÉIE eye cannula	43.08	SELLHEIM elevating spoon	72.07	SNELLEN lens scoop	42.09
SCHÉIE goniotomy knife	42.06	SEMB bone cutting forceps	32.14	SNITMAN retractor	18.27
SCHHEINMANN forceps tip	52.03	SEMB bone rongeur	32.10	solution bowl	88.03
SCHÉPENS orbital retractor	42.08	SEMB bronchus clamp	56.14	SOMER uterine elevating forceps	70.21
SCHERBAK vaginal speculum	70.12	SEMB costal periosteal	32.48	spares for sterilization containers	88.13, 88.24
SCHIMMELBUSCH box (drum) sterilization	88.05	SEMB periosteal	32.48	speculum ear	44.02 - 44.02
SCHINK dermatome	06.11	SEMKEN forceps	10.07	speculum endocervical	70.13
SCHIOETZ tonometre	43.09	SEMM speculum	70.06	speculum for hypophysectomy	40.23
SCHMEDEEN conchotome	46.10	SENN GREEN retractor	18.10	speculum for lumbar vertebral operation	18.42
SCHMID intima spatula	56.18	SENN MILLER baby retractor	18.05	speculum nasal	46.02 - 46.04
SCHMID vascular cannula	22.04	SENN retractor	18.05	SPENCER ligature scissors	08.17
SCHMIEDEN ligature conductor	26.03	SENNING (Sweden) needle holder	24.04	SPENCER WELLS (CHANCE) hemostatic forceps	12.09
SCHMIEDEN PAYR ligature conductor	26.03	septatome	46.15	spherical burr	33.04
SCHMIEDEN TAYLOR dura scissors	08.15	septum and vomer forceps	46.07	sphygmomanometer	02.02 - 02.04
SCHNEIDER periosteal	32.46	septum chisel	46.17	spinal fusion curette	32.30
SCHNEIDER SAUERBRUCH periosteal	32.46	septum compression forceps	46.07	spinal plate	36.23
SCHNIDT (BOETTCHER) tonsil forceps	12.14	septum elevator	46.16, 46.17	spine chisel	32.38
SCHOENBORN thyroid retractor	54.04	septum forceps	46.07, 46.08	splinter forceps	10.12, 10.13
SCHOENBURG grasping forceps	64.04		46.10, 46.12	split needle	22.05
SCHROEDER tenaculum forceps	70.18	septum gouge	46.20	sponge forceps	16.02
SCHROEDER vulsellum forceps	70.19	septum knife	46.14	spoon shape bone plate	36.22
SCHUBERT biopsy forceps	70.24, 70.25	septum scissors	46.11	SPRATT bone curette	32.26
SCHUKNECHT retractor	18.29	septum speculum	46.04	spring hook	18.25
SCHUKNECHT roller knife	44.17	septum straightening forceps	46.25	spring retractor	18.26
SCHUKNECHT sickle knife	44.17	sequester forceps	32.21	SPURLING forceps laminectomy	40.17
SCHUKNECHT suction tube	44.06	serrefine	12.03	ST. MARKS (LLOYD DAVIES) pelvis retractor	18.19
SCHULZE BERGMANN rectal speculum	68.02	set of saws and burrs	33.07	ST. MARKS perineal retractor	18.56
SCHUMACHER biopsy forceps	70.25	SEUTIN plaster shears	30.02	St. MARTIN suture forceps	43.05
SCHUMACHER forceps tip	52.03	SEWALL elevator	46.16	STACKE ear probe	20.02
SCHUMACHER sternum shears	56.03	SEXTON ear knife	44.08	staple, bone	36.25
SCHUMACHER umbilical cord scissors	08.14	SEXTON GERZOG ear knife	44.08	STAUDE MOORE tenaculum forceps	70.18
SCHÜTZ haemorrhoidal ligator	68.09	SEYFFERT vaginal speculum	70.05	STAUDE towel forceps	02.11
SCHWEIGGER capsular forceps	43.04	sharp scoop	40.28	StCLAIR THOMSON curette	46.28
scissors	08.02 - 08.22, 09.04, 44.11, 44.14, 52.04	SHEA scissors micro	44.11	STEINBACH mallet	32.43
	74.04	SHEPARD lens implantation forceps	42.18	STEINMANN pin	33.11
scissors cuticle	74.04	sickle knife	44.17	STEINMANN tendon seizing forceps	32.23
scissors enterotomy	08.17	side cutter	33.18	STEINMANN tip protector	33.11
scissors enucleation	08.09	SIEBOLD gynaecological scissors	08.13	STELLBRINK bone rongeur	32.05
scissors episiotomy	08.14	sigmoid anastomosis forceps	64.08	STELZNER scissors rectal	08.16
scissors for left handers	08.02, 08.03, 08.05, 08.07, 08.20	sigmoidoscope	68.04	sterilization drape	88.10
	08.18	silicon studded mat for sterilization trays	88.10	sterilization basket from wire mesh	88.08
scissors gum	08.07	SILVER chisel plastics	46.19	sterilization container spares	88.09
scissors iris	38451	silver clips neurosurgical	40.03	sterilization containers	88.11 - 88.19
scissors micro	44.11	SILVER hand dermatome	06.12	sterilization forceps	28.02
scissors micro ear	52.04	SIMCOE cannula aspirating and irrigating	43.08	sterilization tray mini perforation	88.08
scissors micro laryngeal	09.04	SIMCOE suturing cannula	43.08	sterilization tray wiremesh	88.08
scissors micro vascular	08.22	SIMON abdominal retractor	18.19	sterilizing box	88.07
scissors nail splitting	08.11	SIMON bone curette	32.27	sterilizing box stainless with filters	88.06
scissors vascular	08.19	SIMON fistula hook	70.29	sterilizing drum	88.05
scissors wire cutting	42.18	SIMON uterus scoop	70.31	sterilizing tray sheetmetal	88.08
scleral fixation ring	42.06	SIMPSON BRAUN obstetric forceps	72.02	sternal approximator	56.12
sclerotome	32.37	SIMPSON LUKART obstetric forceps	72.03	sternal retractor	56.09
scoop malleable	18.62, 40.25	SIMPSON obstetric forceps	72.02	STERNBERG lip retractor	48.03
SCOVILLE hook	18.63	SIMS curette uterine	70.32	sternotomy valves	56.07
SCOVILLE nerve root retractor	40.06	SIMS MAIER polypus forceps	16.02	sternum chisel	32.38
SCOVILLE retractor laminectomy	18.62	SIMS rectal speculum	68.02	sternum shears	56.03
SCOVILLE ruptured disc curette	32.29	SIMS scissors	08.12	stethoscope	02.09
screw cancellous 6,5 mm thread	36.13	SIMS speculum vaginal	70.10	STEVENS iris forceps	42.13
screw cancellous small hexagonal head	36.12	SIMS uterine curette	70.32	STEVENS lens hook	42.07
screw cancellous small hexagonal head self tapping	36.12	SIMS uterine dilator	70.17	STEVENS needleholder	24.09
screw cannulated 3,5 mm full thread	36.11	SIMS uterine sound graduated	70.22	STEVENS tenotomy scissors	08.08
screw cannulated 3,5 mm short thread	36.11	SIMS uterus scissors	08.12	STEVENSON eye speculum	42.03
screw cannulated 4,5 mm thread 16 mm	36.11	SIMS vaginal speculum	70.10	STIEGLITZ (WILLIAMS) splinter forceps	10.13
screw cannulated 7 mm thread 16 mm	36.11	SINGLEY TUTTLE forceps	10.09	STIEGLITZ splinter forceps	10.13
screw cannulated 7 mm thread 32 mm	36.11	SKENE tenaculum forceps	70.18	STILLE BARRAYA forceps	10.09
screw compression	36.09	skin retractor	74.02	STILLE bone chisel	32.35
screw cortex large hexagonal head	36.12, 36.13	skin seizing forceps	46.26	STILLE bone hand drill	33.04
screw cortex large hexagonal head self tapping	36.12	skin straightening plate	06.11	STILLE bone hand drill	33.04
screw cortex small hexagonal head	36.11	skull breaker	32.38	STILLE forceps thumb and tissue	10.02
screw cortex small hexagonal head self tapping	36.12	skull punch	40.07	STILLE gouge	32.35
screw driver	33.20	skull traction tong	40.04	STILLE HORSLEY bone cutting forceps	32.14
screw holder	33.20	slotted hammer	33.19, 34.04	STILLE LISTON bone cutting forceps	32.14
screw holding forceps	33.21	SLUDER BALLENGER tonsillectome	50.07	STILLE LUER rongeur	32.08
screw malleolar large hexagonal head	36.13	SMELLIE obstetrical hook	72.05	STILLE osteotome	32.35
screw mini hexagonal head	36.11	SMILLIE knee retractor	32.57	STILLE pedicle clamp	12.24
seating chisel for angled plates	34.04, 34.05	SMILLIE meniscotome	32.58	STILLE plaster cast shear	30.02
SEBILAU elevator	32.50	SMITH BUIE rectal spreader	68.03	STILLE rib shear	56.02
		SMITH eye speculum	42.02	STILLE RUSKIN bone rongeur	32.09
		SMITH PETERSEN chisel	32.35	STILLE SHERMAN bone hand drill	33.04
		SMITH PETERSEN gouge	32.35	STOCKMANN penile clamp	66.05
				stomach clamp forceps	64.11

Alphabetical Index

STONE closing forceps 64.10
 STONE forceps 10.10
 STONE WATT intestinal forceps 64.10
 STONE WATT locking ferrule 64.10
 strabismus forceps 42.16
 strabismus hook 42.07
 strabismus scissors 08.08
 STRANDELL STILLE retractor 18.10
 Strasbourg model tissue forceps 10.10
 STRATTE needle holder 24.07
 STRAUSS rectoscope 68.04
 STRUCK rib spreader infant 56.10
 STRUEMPEL ear forceps 44.11
 STRULLY neurosurgical scissors 08.15
 STRULLY vascular scissors 08.15
 STRUYCKEN nasal forceps 46.10
 suction elevator 46.29
 suction tubes 04.02, 04.03, 44.06

suture clip set in metal case 26.08
 suture forceps 10.11
 suture needle 26.05
 suturing forceps eye 43.05
 suturing needles 26.05, 26.06
 suturing set in metal box 26.08
 SVEN JOHANSSON nail driver 34.11
 swivel knife 46.15
 swab forceps 16.02 - 16.06
 Sweden needle holder 24.04
 SWEET clip applying forceps 40.02
 SYME aneurysm needle 26.02
 SYPERT bone rongeur 32.12
 syringe record 18.64
 syringe tonsil 50.08
 SYSTRUNK scissors nail splitting 08.22

T

TABB sickle knife 44.17
 tampon forceps 52.02
 tap handle 33.08
 tap handle T bar 33.08, 33.22
 tape measure 02.12
 TARNIER cranioclast 72.08
 TAYLOR blade 18.63
 TAYLOR FORCEPS thumb and tissue 10.07
 TAYLOR hammer 02.10
 TAYLOR hook 18.63
 TAYLOR spinal retractor 32.57
 TEALE vulsellum forceps 70.19
 telescopic wire guide 33.05
 template bending 33.22
 tenaculum forceps 70.18
 tendon braiding forceps 32.24
 tendon hook double 18.25
 tendon passer 32.23
 tendon scissors 09.02
 tendon seizing forceps 32.23
 tendon sheath retractor 18.12
 tendon stripper 32.59
 tenotomy scissors 08.08
 tension device 34.03
 TERRIER vascular forceps 12.03
 TERSON capsular forceps 43.04
 textile filter for containers 88.24
 THIERRY obstetric forceps 72.04
 THOMAS uterine curette 70.34
 THOMS ALLIS forceps 64.03
 THOMS GAYLOR biopsy forceps 70.25
 THOMSON curette 46.28
 THOMSON WALKER bladder retractor 66.03
 thorax forceps 12.17
 thorax scissors 08.16
 thorax spreader 56.08
 THOREK lung (thorax) scissors 08.16
 THUDICHUM (GOLDSMITH) nasal speculum 46.02
 thyroid retractor 54.04
 tibia plate 36.21, 36.22
 tibia plate anatomical 36.21
 tick removal forceps 10.13
 TIECK HALLE nasal speculum 46.04
 tightener for bone wire 34.13
 TILLEY ear forceps 44.10
 TISCHLER baby biopsy specimen forceps 70.26
 TISCHLER KEVORKIAN punch 70.28
 TISCHLER MORGAN biopsy specimen forceps 70.26

TISCHLER MORGAN Eppendorfer biopsy forceps 70.28
 TISCHLER MORGAN forceps tips 70.27, 70.28
 tissue forceps 10.02 - 10.04
 tissue protector and tap sleeve 33.26
 TIVNEN tonsil seizing forceps 50.05
 TOBOLD laryngeal cotton applicator 20.06
 TOBOLD tongue depressor 48.03
 TOENNIS ADSON neurosurgical scissors 08.15
 TOENNIS dura dissector 40.07
 TOENNIS hemostatic forceps 12.18
 TOENNIS needleholder 24.07
 TOHOKU towel clamp 14.03
 tongue depressor 48.02, 48.03
 tongue holding forceps 48.04
 tonometre 43.09
 tonsil dissector 50.02
 tonsil elevator 50.02
 tonsil forceps 12.14, 12.15, 50.05

tonsil hemostat 50.06
 tonsil injection needle 50.08
 tonsil knife 50.04
 tonsil knife and dissector 50.04
 tonsil knife and enucleator 50.03
 tonsil loops 50.07
 tonsil needle 50.03
 tonsil punch forceps 50.08
 tonsil scissors 08.10
 tonsil seizing forceps 50.04, 50.05
 tonsil snare 50.06, 50.07
 tonsil syringe 50.08
 tonsillectome 50.07
 TOOK corneal knife 42.05
 TOTI drill 33.09
 tourniquet 'clip' 02.05
 towel clamp 14.02 - 14.04
 towel clip 14.02 - 14.04
 towel forceps 14.02 - 14.04
 TOWNLEY caliper 02.12
 TOWNSEND KEVORKIAN punch rotating 70.27
 TOWNSEND mini punch 70.27
 TOWNSEND punch 70.27
 TOWNSEND TISCHLER baby punch 70.27
 TOWNSEND TISCHLER MORGAN punch 70.27

TOYNBEE ear speculum 44.02
 trabeculectomy probe 42.12
 trachea hook 54.02, 54.03
 trachea retractor 54.03
 trachea spreader 54.02
 tracheal dilator 54.02
 tracheostomy set in metal case 54.03
 tracheostomy trocar 54.02
 tracheotomy tube 54.03
 trachoma forceps 43.07
 traction bar 32.22
 traction tongs skull 40.04
 tractor for delivery forceps 72.04
 TRAUBE hammer 02.10
 TRAVERS retractor 18.32
 tray sterilization mini perforation 88.08
 TRELAT speculum 70.06
 trephine ophthalmic 43.08
 TRETOWAN bone lever 32.56
 TREVES forceps 10.03
 trigenimus knife 40.09
 trocar abdominal 22.02
 trocar thoracic 22.03
 trocar tracheostomy 54.02
 TROELTSCH (WILDE) ear forceps 44.09
 TROELTSCH nasal forceps angled 46.05
 TROEMNER hammer 02.10
 TROTTER rongeur 32.07
 TROUSSEAU tracheal dilator 54.02
 TROUTMAN CHRIS blade breaker 06.07
 TROUTMAN colibri iris forceps 42.15
 TROUTMAN rectus forceps 43.02
 tubing clamp 12.30 - 12.32
 Tübingen air cannula 43.08
 Tübingen iris forceps 42.17
 Tübingen retractor 18.30
 Tübingen tying forceps 43.05
 Tübingen vaginal and abdominal retractor 70.11
 TUCKER delivery forceps 72.03
 TUFFIER hemostatic forceps 12.11
 TUFFIER retractor abdominal 18.22
 TUFFIER retractor 18.05
 TUFFIER rib spreader 56.07

tumor forceps 11.05, 11.06
 tumor grasping forceps 40.18
 tuning fork 44.04, 44.05
 TURNBULL nail nipper 74.04
 TURNER WARWICK abdominal retractor 18.50 - 18.55
 TURREL rectum biopsy forceps 68.07
 twist drill 18.41, 33.04, 33.05, 33.07
 TYDING tonsil seizing forceps 50.05
 TYDING tonsil snare 50.07
 tying forceps ophthalmic 43.05
 TYRELL iris hook 42.07

U

UCKERMANN cotton applicator 20.06
 UCKERMANN trocar 54.02
 UFFENORDE bone curette 32.27
 ULRICH bone holding forceps 32.17
 ULRICH swab forceps 16.02
 umbilical cord clamp 72.05
 umbilical cord scissors 08.14
 universal handle laryngeal 52.03
 UNNA comedo extractor 74.02
 urethral dilating set 66.06
 urethrotome 66.04
 US Army gauze scissors 08.20
 US Army retractor 18.03
 US model umbilical cord scissors 08.14
 USA thumb and tissue forceps 10.02
 uterine curettes 70.23, 70.24, 70.31 - 70.36
 uterine dilating set 70.14
 uterine dilator 70.14 - 70.16
 uterine elevating forceps 16.03, 70.20, 70.21
 uterine scissors 08.12
 uterus scoop 70.31
 uvula retractor 50.02

V

vaginal specula 70.02 - 70.13
 VALIN spreader 18.61
 VALLEIX uterine probe 70.22
 van BUREN dilating bougie 66.06
 van BUREN sequester forceps 32.21
 van DOREN biopsy forceps 70.25
 VANNAS iridectomy scissors 09.03
 VANT uterine polypus forceps 16.03
 VARADY double spatula 20.05
 VARADY mini vein stripper set 20.04
 VARADY phlebodissector 20.05
 varicose vein probe set 20.03
 vascular and thorax scissors 08.12
 vascular cannula 22.04
 vascular dilator 56.17, 56.18
 vascular dissector 56.18
 vascular forceps 12.03
 vascular knife 40.29
 vascular needle holder 24.05
 vascular scissors 08.10, 08.11
 vascular scissors angled 08.10, 08.11
 vein stripper 20.05
 vena cava clamp 56.15
 ventricular puncture cannula 40.16
 ventriculopuncture needle 40.16
 VERBRUGGE bone holding forceps 32.18
 VERBRUGGE HOHMANN bone lever 32.53
 VERESS pneumoperitoneum needle 22.03
 VERNIER caliper 02.12
 vertebral body distractor 18.41
 VIDAL lupus scraper 74.02
 Vienna model nasal speculum 46.03
 Vienna model vaginal speculum 70.11
 VIRCHOW brain knife 06.13
 VIRCHOW cartilage knife 06.13
 VIRCHOW skull breaker 32.38
 VIRTUS (RALK) splinter forceps 10.13
 VOLKMANN bone curette 32.26, 32.28, 32.31, 32.32
 VOLKMANN retractor 18.10 - 18.12
 VOLTOLINI (DUPLAT) nasal speculum 46.02
 vPETZ suturing apparatus 64.13
 vulsellum forceps 70.17, 70.19,

Alphabetical Index

W

WACHENFELDT clip applying forceps	26.07
WADSWORTH TODD cautery	42.09
WAGENER hooklet	44.09
WAGENER MOSHER tube for intubation	54.03
WAGNER forceps laminectomy	40.18
WAGNER hammer complete	32.42
WAGNER scissors	08.18
WALB organ knife	06.13
WALLICH abortion scoop	72.07
WALSHAM septum straightening forceps	46.25
WALTER foreign body needle	42.06
WALTHER dilating bougie	66.08
WALTON comedo extractor	74.02
WALTON foreign body gouge	42.06
WALTON hemilaminectomy retractor	18.35
WALTON YANKAUER suction tube	04.02
WANE retractor	18.31
WANGENSTEEN forceps	10.09
WANGENSTEEN needleholder	24.05
WARTENBERG pin-wheel	02.11
wash cannula	46.13
washers for bone screws	36.11, 36.13
WASSMUND retractor	18.23
waste forceps	28.02
watchmaker's forceps	10.11
WATSON CHEYNE dissector	20.02
WATSON dermatome	06.12
WATSON JONES bone lever	32.56
WATSON WILLIAMS ethmoid forceps	46.07
WAUGH thumb and tissue forceps	10.09
WEBER esthesiometer	02.11
WEBER lens scoop	42.09
WEBSTER needle holder	24.02
WECKER iris scissors	09.02
WECKER iris spatula	42.09
WEEK eye speculum	42.02
WEIL BLAKESLEY nasal cutting forceps	46.09
WEINBERG vagotomy retractor	18.07
WEISS eye speculum	42.03
WEISS tubing clamp	12.30
WEITLANER retractor	18.28 - 18.30
WEITLANER WULLSTEIN retractor	18.28
WELLS enucleation scoop	42.09
WERTHEIM atrauma clamp	12.28
WERTHEIM clamp forceps	12.27
WERTHEIM CULLEN hysterectomy forceps	12.28
WERTHEIM hysterectomy forceps	12.27
WERTHEIM needleholder	24.06
WERTHEIM preparation scissors	08.13
WERTHEIM scissors	08.13
WERTHEIM surgical scissors	08.13
WEST chisel nasal	46.20
WEST gouge nasal	46.20
WESTCOTT tendon scissors	09.02
WESTMACOTT nasal tampon forceps	46.06
WHEELER cyclodialysis spatula	42.10
WHEELER discision knife	42.05
WHITE tonsil seizing forceps	50.04
WHITEHEAD mouth gag 11 cm	48.06
WIEDER tongue depressor	48.02
WIENER (AUFRIECHT) nasal rasp	46.21
WIENER antrum rasp	46.20
WIENER iris hook	42.07
WIGMORE plaster saw	30.02
WIKSTROEM hemostatic forceps	12.20
WILBERG bone staple	36.26
WILDE nasal snare	46.13
WILDE snare ear polypus	44.09
WILDE TROELTSCH ear forceps	44.09
WILDER lachrymal dilator	42.11
WILDER lens scoop	42.09
WILLET MARTEL scalp flap forceps	12.10
WILLIAMS eye speculum	42.03
WILLIAMS intestinal and tissue grasping forceps	64.04
WILLIAMS retractor	18.62
WILLIAMS screw driver/holder	33.20
WILLIAMS splinter forceps	10.13
WILLIGER double curette	32.32
WILLIGER elevator	32.49
WILLIGER hammer	32.41
WILLIGER periosteal	32.47
WILLIGER periostotome	32.47

WILMS bone rongeur	32.07
WINTER placenta and ovum forceps	72.06
wire conductor	33.13
wire cutter	33.14, 33.16 - 33.18
wire cutter (side cutter)	33.18
wire guide	33.13
wire guide telescopic	33.05
wire saw	40.06
wire scissors universal	08.19
wire tension pliers	33.13
wire tightener	33.13
wire tightener/twister	33.13
wire twisting forceps	33.15
wiredrill	33.10
wiredrill dispenser	88.22
WITTNER biopsy forceps	70.26
WOLFF plaster cast breaker	30.04
WRIGLEY obstetric forceps	72.02
WULLSTEIN scissors micro and mini	44.14
WULLSTEIN sickle knife	44.17
WÜRZBURG tongue blade	48.10
WYLIE uterine dilator	70.17

Y

YANKAUER aspiration tube	04.02
YANKAUER postnasal speculum	46.05
YASARGIL arachnoid knife	40.29
YASARGIL aspirating tube	40.15
YASARGIL forceps tumor	11.05
YASARGIL galea retractor	40.04
YASARGIL micro bayonet forceps	11.05
YASARGIL micro raspatory	40.27
YASARGIL micro raspatory	40.27
YASARGIL needle holder micro	24.12
YASARGIL raspatory	40.27
YASARGIL rongeur pituitary	40.18
YASARGIL SAMII tumor forceps	11.05
YASARGIL sharp scoop	40.28
YEOMAN rectum biopsy forceps	68.06, 68.07
YOUNG boomerang needle holder	26.03
YOUNG prostatic forceps	66.02
YOUNG prostatic retractor	66.02
YOUNG tongue holding forceps	48.04

Z

ZAUFAL JANSEN rongeur	32.07
ZENKER retractor	18.21
ZENTER dissecting / ligature forceps	12.19
ZIEGLER capsulotomy knife	42.05
ZIEGLER eye speculum	42.03
ZIEGLER head mirror	02.05
ZIEGLER iris knife	42.05
ZIEGLER lachrymal dilator	42.12
ZIEGLER mirror	02.05
ZIELKE scoliosis gouge	32.37
ZOELLNER aspirating tube	44.06
ZOELLNER suction tube	44.06
ZWEIFEL needle holder	24.07

Alphabetical
Index

A	
abaisse langue	48.02, 48.03, 48.07, 48.08 - 48.11
ABRAHAM couteau amygdalien	50.04
ABRAMS aiguille à biopsie	22.04
accessoires pour les containers à stérilisation	88.13, 88.19 - 88.21, 88.21, 88.24
adaptateur pour petites plaques	33.22
ADLERKREUTZ pince	10.05
ADSON (FRASIER) pince hémostatique	12.13
ADSON baby (CONE) écarteur	18.34
ADSON baby pince hémostatique	12.13
ADSON BROWN pince	10.04
ADSON BROWN pince	10.04
ADSON écarteur	18.31, 18.32
ADSON écarteur à duremère	40.06
ADSON écarteur à héminaminectomie	18.32, 18.33
ADSON élévateur	32.49
ADSON micro pince	10.03, 10.04
ADSON mini pince	10.03
ADSON pince	10.04
ADSON pince à hypophyse	40.09
ADSON pince gouge	32.04
ADSON pinces à dissection	10.03, 10.04
ADSON porte-aiguille	24.06
ADSON tube d'aspiration	40.15
AEBLI ciseaux cornéens	08.08
AEOMAN pince à biopsie rectale	68.06
aesthésiomètre	02.11
AFORCE instrument à corps étrangers	42.06
agrafe à épiphyse	36.25
agrafe à ostéotomie escalonnée	36.26
agrafe osseuse	36.25, 36.26
agrafe pour le cuir chevelu	40.04
agrafes cutanées	26.08
agrafes en argent	40.03, 64.13
aiguill à corps étrangers	42.06
aiguille à amygdales	50.03
aiguille à anevrysmie	26.02
aiguille à autopsie	26.07
aiguille à biopsie osseuse	22.04
aiguille à cataracte	42.06
aiguille à corps étrangers	42.06
aiguille à discision	42.06
aiguille à injection amygdalienne	50.08
aiguille à irrigation d'héparine	22.04
aiguille à ligature	26.02, 26.03
aiguille à paracentèse	44.07
aiguille à pneumopéritoine	22.03
aiguille à ponction lombaire	22.03, 22.04
aiguille amygdalienne	50.03
aiguille d'introduction de drainages	04.04
aiguille et gouge	42.10
aiguille intestinale	26.06
aiguille pour la micrchirurgie auriculaire	44.17, 44.18
aiguille pour la ponction du foie	22.05
aiguille pour la ponction ventriculaire	40.16
aiguille pour la suture du palais	50.03
aiguille pour l'anesthésie pudendale	22.03
aiguille pour le sinus maxillaire	46.13
aiguille veineuse	22.04
aiguille/ciseau-burin	42.10
aiguilles à suture	26.05 - 26.07
aimant oculaire	43.09
ALAN PARKS adaptateur	68.03
ALBARRAN aiguille	26.03
ALBARRAN aiguille à ligature	26.03
ALBEE fraise olivaire	33.09
ALDERDYCE dissecteur	32.56
alésior élastique pour le canal médullaire	34.09
alésior fémoral	33.18
alésior flexible pour le canal médullaire	34.09
alésior pour dous centro-médullaires	33.18
alésior pour pince crânéenne	40.04
ALEXANDER ciseau	32.34
ALEXANDER gouge	32.34
ALEXANDER rugine raspatoire	32.47
ALLEN pince intestinale pédiatrique	64.04
ALLIS ADAIR pince	64.02
ALLIS baby pince	64.02
ALLIS pince à saisir les tissus et l'intestin	64.02
ALLISON écarteur pulmonaire	56.12
ALLPORT écarteur	18.27
ALM écarteur	18.26

ALVIS curette à corps étrangers	42.06
amygdalotome hémostatique	50.08
amygdalotomes	50.07, 50.08
ANDERSON ADSON écarteur	18.30
ANDREW abaisse-langue	48.02
ANDREWS PYNCHON tube d'aspiration	04.02
angiotribe	12.09
ANKENEY écarteur sternal	56.09
anneau bulbaire	42.18
anneaux à ligature hémorroïdale	68.10
anse auriculaire	44.08
anses pour l'ophtalmologie	42.09
anuscope	68.05
appareil compressif complet	33.02
approximateur sternal	56.12
ARCHER pince à échardes	10.13
Arkansas pierre à repasser	06.13
armée US ciseaux à gaze	08.20
armée US écarteur	18.03
ARRUGA blépharostat	42.02
ARRUGA crochet à extraction	42.07
ARRUGA pince capsulaire	43.04
ARRUGA porta-aiguille	24.09, 24.10
ARRUGA protecteur	42.09
ARTHUR pince à iris	42.15
ASCH pince à redresser la cloison	46.25
aspirateur capsulaire	42.11
assourdisseur	44.05
AUFRANC cobra levier à os	32.54
AUFRICHT écarteur nasal	46.25
AUFRICHT râpe nasale	46.20, 46.21
AUVARD spéculum	70.10
AXENFELD blépharostat	42.02
AXENFELD curette à chalazion	42.08
AYER pince à chalazion	43.06
AYRE couteau à conisation	70.29

B	
BABCOCK pince à saisir le tissu et les intestins	64.03
BABCOCK pince atraumatique	64.03
BABINSKY marteau percuteur	02.10
BACKHAUS KOCHER pince à champs	14.02
BACKHAUS pince à champs	14.02
BACKHAUS pince à champs et fixe-tube	14.02
BACON pince-gouge	32.05
BADGLEY écarteur à laminectomie	56.06
BAGGISH pince à biopsie	70.28
BAILEY baby rapprocheur des côtes	56.12
BAILEY GIBBON rapprocheur des côtes	56.12
BAILEY rapprocheur des côtes	56.12
baillon en bois	48.12
BAINBRIDGE pince hémostatique	12.22
BAKES sonde à calculs biliaires	62.03
BALFOUR baby écarteur abdominal	18.46
BALFOUR écarteur abdominal	18.45
BALFOUR U.S. écarteur abdominal	18.47
BALLENGER couteau mobile	46.15
BALLENGER élévateur pour la cloison	46.17
bande adhésive à identification des instruments	88.10
bande frontale	02.05
bandelette à os métallique	32.22
BANE pince gouge	32.04
BANGERTER pince musculaire	43.07
BANGERTER spatule à cyclodialyse	42.09
BARANY assourdisseur	44.05
BARBARA crochet	44.17
BARBARA pick (pointe)	44.17
BARBARE aiguille	44.17
BARKAN couteau à goniotomie	42.06
BARNHILL couteau à végétations adénoïdes	46.27
BARON (SCHUKNECHT) tube d'aspiration	44.06
BARR spéculum rectal	68.03
BARRAQUER blépharostat	42.02
BARRAQUER colibri blépharostat	42.02
BARRAQUER colibri ciseaux à iris	09.02
BARRAQUER colibri pince à iris	42.15
BARRAQUER couteau à kératoplastie	42.06
BARRAQUER KATZIN pince à iris	42.15
BARRAQUER pince à chambre antérieure	43.02
BARRAQUER pince à épilation	43.10
BARRAQUER pince à fixation	43.03
BARRAQUER porte-aiguille	24.10
barre de direction pour alésior	34.09
BARRETT pince utérine	70.18
BARRON ligateur hémorroïdal	68.09
BARRON manche de bistouris	06.02
BARTELHEIMER aiguille à biopsie	22.04
BARTH curette auriculaire	32.32
BARTON forceps	72.03
BARTON tracteur	72.03
BAUMGARTNER porte-aiguille	24.03
BEACHAM amniotome	70.21
BECKER kistitome malléable	42.07
BECKMANN couteau à végétations adénoïdes	46.27
BECKMANN EATON écarteur	18.33
BECKMANN écarteur	18.33
BECKMANN FISCH écarteur	18.29
BECKMANN spéculum nasal	46.03
BEEBEE ciseaux	08.19
BEER pince à épiler les cils	43.10
BEESON écarteur pour plâtre	30.04
BELLUCCI ciseaux micro	44.11
BENGOLEA pince hémostatique	12.12
BENNETT levier à os	32.52
BENSAUDE anuscope	68.05
BENSON écarteur pylorique	64.04
BERENS kératome	42.04
BERENS pince à avancement	43.07
BERENS pince musculaire	43.07
BERGER pince à biopsie	70.28
BERGMANN ciseaux à bandages	08.20
BERGMANN écarteur	18.26
BERGMANN maillet	32.41
BERGMANN scie à plâtres	30.02
BERKE pince musculaire	43.02
BERLINER marteau	02.11
BERTILLON céphalomètre	02.11
BEST pince intestinale	64.09
BETHUNE costotome	56.02
BEUSE ciseaux dentelés	08.09
BEYER pince emporte-pièce	46.12
BEYER pince gouge	32.05, 32.07
BIER aiguille pour la ponction lombaire	22.04
BILL tracteur pour manche standard de forceps	72.04
BILLEAU anse auriculaire	44.08
BINKHORST pince à implanter les lentilles	42.18
bipod pour ouvre-bouche	48.11
BIRCHER GANSKE davier porte-os	32.19
BIRCHER ménisctome	32.58
BIRKETT pince hémostatique amygdalienne	12.14
BISHOP HARMAN pince à iris	42.17
bistouri à duremère	40.08
bistouri à muqueuse	46.14
bistouri amygdalien	50.04
bistouri amygdalien et dissecteur	50.03
bistouri amygdalien et énucléateur	50.03
bistouri fin	06.10
bistouri manche métal	06.09
bistouri nasal boutoné	46.14
bistouri pour la chirurgie plastique	46.13
bistouri pour la plastie nasale	46.14
bistouri usage unique	06.06
BLAKE curette utérine	70.31
BLAKE pince à calculs biliaires	62.02
BLASCOVICS pince à avancement	43.02
blépharostat	42.02, 42.03
BLOHMKE pince à préhension amygdalienne	50.05
BLOUNT écarteur à genou	32.56
BLOUNT extracteur d'agrafes osseuses	34.12
BLOUNT introducteur d'agrafes osseuses	34.12
BLOUNT levier à os	32.56
BLUMENTHAL pince gouge	32.03
BODENHAMMER spéculum rectal	68.02
BOEHLER étrier à extension	33.12
BOEHLER pince coupante à os	32.14
BOEHLER pince gouge	32.08
BOERMA forceps	72.04
BOETTCHER ciseaux amygdaliens	08.10
boîte à aiguilles	88.02
boîte à instruments (stérilisation au poupinel)	88.07
boîte à instruments rectangulaire sans perforations	88.06
boîte à stérilisation rectangulaire avec filtres	88.05
boîte à stérilisation ronde (tambour)	26.08
boîte à suture en boîte métal	26.08
boîte à suture par agrafes	26.08
boîte acier rectangulaire étirée d'une seule pièce	88.02
boîte de scies, mèches et fraises	33.07
boîte en verre avec couvercle inox	88.02
BONACCOLTO pince à strabisme	42.16
Bonn canule à irrigation	43.08
Bonn crochet à iris	42.07
Bonn pince à iris	42.17

Index alphabétique

Bonn titane pince à iris	42.17	CAMPBELL bougie urétrale dilatatrice	66.07	ciseaux	08.02 - 09.04,
BONNEY pince	10.05, 10.06	CANFIELD bistouri amygdalien	50.04		44.14
boomerang porte-aiguille	26.03	CANNY RYALL écarteur	18.22	ciseaux à bandages	08.20 - 08.23
BORCHARDT fraise olivaire	33.09	canule à irrigation et aspiration	43.08	ciseaux à bandages universels	08.22
BOSE écarteur trachéal	54.02, 54.03	canule à suture	43.08	ciseaux à bandes	08.20
BOUCHERON spéculum auriculaire	44.02	canule à ventilation pour laryngoscope opératoire	52.06	ciseaux à cordon ombilical	08.14
bougie dilatatrice urétrale	66.06 - 66.08	canule intra-utérine	70.30	ciseaux à cordon ombilical modèle US	08.14
bougie dilatatrice urétrale à filet intérieur	66.06	canule ophtalmique	43.08	ciseaux à dure-mère	08.15
BOWLES stéthoscope	02.09	canule pour la radiométrie	22.06	ciseaux à entérotomie	08.17
BOWMAN blépharostat	42.02	canule trachéale	54.03	ciseaux à énucléation	08.09
BOWMAN couteau à dissection	42.05	canule vasculaire	22.04	ciseaux à envies	74.04
BOWMAN styler lacrymal	42.12	canules d'aspiration	04.02 - 04.03,	ciseaux à épisiotomie	08.14
BOWMANN aiguille à dissection	42.06		40.15, 40.16,	ciseaux à fendre les ongles	08.22
BOYNTON porte-aiguille	24.09		44.06, 46.29	ciseaux à fil métallique	08.19
BOYS ALLIS pince intestinale	64.02	CAPLAN ciseaux à cloison	46.11	ciseaux à gaze	08.20
BOZEMANN (WERTHEIM) porte-aiguille	24.06	CARMALT pince à échardes	10.12	ciseaux à gencives	08.18
BOZEMANN DOUGLAS pince à pansement	16.06	CAROLL pince à saisir les tendons	32.24	ciseaux à incisions	08.10
BOZEMANN FRITSCCH tube de lavage utérin	70.35	CARPENTER bistouri amygdalien et dissecteur	50.03	ciseaux à iridectomie	08.07, 08.08,
BOZEMANN pince à pansement	16.05	CARPENTER bistouri amygdalien et énucléateur	50.03		09.02
BRAITHWAITE dermatome	06.12	carquois pour électrodes haute fréquence	88.22	ciseaux à iris	08.07
BRAND pince à passer les tendons	32.23	CARREL pince vasculaire	12.03	ciseaux à ligatures	08.17 - 08.19
BRAUN cranioclaste	72.07	CARTON évacuateur de muqueuse	70.30	ciseaux à nerfs	08.14
BRAUN crochet à décapitation	72.08	CASPAR contre-écarteur	18.42	ciseaux à neurochirurgie	08.15
BRAUN dépressur utérin	70.21	CASPAR crochet	18.40	ciseaux à paramétrium	08.12
BRAUN pince pour l'abaissement du col	70.20	CASPAR crochet à exploration et coagulation	40.26	ciseaux à paramétrium	08.12
BRAUN pince utérine	70.18	CASPAR distracteur des corps vertébraux	18.41	ciseaux à plâtre	08.21, 30.02
BRAUN spéculum vaginal	70.11	CASPAR écarteur à hémilaminectomie	18.40	ciseaux à strabisme	08.08
BRAUN STADLER ciseaux à épisiotomie	08.14	CASPAR écarteur à laminectomie	18.40	ciseaux à tendons	09.02
BREISKY spéculum vaginal	70.13	CASPAR écarteur articulé	18.39	ciseaux à ténatomie	08.08
BRIDGE pince hémostatique et passe-fils	12.20	CASPAR guide-mèche	18.41	ciseaux amygdaliens	08.10
BRISTOW rugine	32.46	CASPAR manche de bistouris micro en baïonnette	06.08	ciseaux auriculaires micro	44.14
broche guide-clous	33.19	CASPAR mèche	18.41	ciseaux cornéens	09.03
broches	33.10	CASPAR pince emporte-pièce à laminectomie	40.19, 40.20	ciseaux dissecteur	08.04
BROCK porte aiguille	24.12	CASPAR plaque trapézoïdale pour l'ostéosynthèse	36.24	ciseaux fistulaires	08.13
BRODIE sonde cannulée	20.04	CASPAR spéculum pour les vertèbres lombaires	18.42	ciseaux micro	09.02 - 09.04
BRODIE styler malléable	20.02	CASPAR tournevis	18.41	ciseaux micro vasculaires	08.07,
BROPHY pince à dissection	10.08	CASPAR valve	18.38, 18.42		08.10 - 08.12,
brosse à nettoyer les canules trachéales	54.03	CASPAR vis à distraction	18.41		08.15, 09.04
brosse à ongles stérilisable	74.05	casse-crâne	32.39	ciseaux micro, mini, pour ORL	44.11, 44.14
brosse pour des vis canulés	33.23	casse-lames	06.07	ciseaux microlaryngiens	52.04
BROWN pince dentelée	10.04	CASTANEDA écarteur aluminium	56.05	ciseaux nasaux	08.09, 46.11
BROWN porte-aiguille	24.03	CASTROVIEJO blépharostat	42.03	ciseaux pour les gauchers	08.01, 08.03,
BRUENINGS abaisselangue	48.02	CASTROVIEJO casse-lames	06.07		08.05, 08.07,
BRUENINGS BRUNK écarteur sinus	46.29	CASTROVIEJO ciseaux à iridectomie	09.02		08.20
BRUENINGS couteau pour la cloison	46.15	CASTROVIEJO ciseaux cornéens	09.03	ciseaux pulmonaires	08.10
BRUENINGS embout pince	52.03	CASTROVIEJO compas marqueur	42.11	ciseaux rectaux	08.16
BRUENINGS pince coupante nasale	46.08	CASTROVIEJO dilateur lacrymal	42.12	ciseaux thoraciques	08.16
BRUENINGS rallonge	52.03	CASTROVIEJO kératome	42.04	ciseaux universels dentelés à fil métallique	08.19
BRUENINGS serre-nœud	50.06	CASTROVIEJO pince à fixation	43.03	ciseaux utérins	08.12
BRUENINGS spéculum auriculaire pneumatique	44.03	CASTROVIEJO pince à suture	43.05	ciseaux vasculaires	08.10, 08.11
BRUNETTI burin spinal	32.38	CASTROVIEJO pince à suture	24.11, 24.12	ciseaux-burins	32.33 - 32.34,
BRUNNER aiguille à ligature	26.03	CASTROVIEJO porte aiguille	42.09, 42.10		32.37 - 32.39,
BRUNNER costotome	56.03	CASTROVIEJO spatule à cyclodialyse	43.08		46.18 - 46.20
BRUNNER écarteur	18.20	CASTROVIEJO trépan	42.09	CITELLI pince emporte-pièce	46.11
BRUNNER pince intestinale	64.09	cautére ophtalmique	42.09	clamp cardiovasculaire atrauma	12.02
BRUNNER sonde conductrice à ligature	26.04	CAWOOD MINNESOTA écarteur des joues	48.04	clamp our la veine cave	56.15
BRUNS ciseaux à bandes	08.21	céphalomètre	02.11	clamp pour le conduit biliaire	12.22 - 12.24
BRUNS cuiller tranchante	32.26 - 32.28	CHAMPEAU canule à radiométrie	22.06	clamp pour le cordon ombilical	72.05
BRYANT pince à pansement	16.04	CHANCE pince hémostatique	12.09	clamps vasculaires auriculaires	56.16
BÜCHS écarteur des joues et tissus mous	18.23	CHANDLER pince à iris	42.13	CLAR lampe frontale	02.05
BUCHWALD abaisse langue	48.02	CHAPUT pince hémostatique	12.11	CLARK blépharostat	42.02
BUCK ciseaux à ligatures	08.18	CHARNLEY écarteur horizontal	18.35	CLAYMAN pince à implanter les lentilles	42.18
BUCK couteau auriculaire	44.08	CHARNLEY pince à sutures	10.11	clé à écrous	33.12, 34.03
BUCK curette auriculaire	44.07	CHARRIÈRE scie à amputation	33.03	clé de serrage pour vis DHS	34.07
BUCK GRAMCKO gouge	32.34	chasse-agrafes osseux	34.12	CLEVELAND pince coupante	32.13
BUCK levier à corps étrangers	44.10	chasse-clous	33.19	CLEVELAND pince gouge	32.02
BUCK marteau percuteur	02.11	chasse-vis DHS	34.07	clip porte-plaques	33.25
BUELAU trocart thoracique	22.03	châssis de container en treillis de fil	88.20, 88.21	cloison séparative pour les containers	88.20, 88.21
BUIE tube d'aspiration	68.06	CHEATLE pince à saisir les instruments	28.02	clou centromédullaire	36.02 - 36.06
Bulldog clamp atrauma	12.02	CHELSEA EATON spéculum anal	68.05	clou centromédullaire avec crochet	36.02
BUMM curette utérine	70.32	CHERON pince à pansements	16.05	clou humérus	36.06
BUNGE curette à exentération	42.08	CHEVALIER DE BOER écarteur des côtes	56.11	clou pour le col du fémur	36.07, 36.08
BUNNELL écarteur de tendons	32.59	CHEVALIER JACKSON pince broncho-œsophagique	52.04	clous centromédullaires flexibles	36.03
BUNNELL perforateur à main	33.06	CHEVRET écarteur (spatule)	18.05	CLOWARD écarteur	18.36, 18.37,
BUNNELL sonde malléable	32.59	CHILDE pince pour les bords de la plaie	26.07		18.40, 40.16
BUNT 'epingle de sécurité' porte-instruments	28.02	CHULTZE salpingographe	70.30		
BURCH fourchette à fixation	42.06	CILLIN costotome	56.02	CLOWARD HOEN écarteur	18.43
burin crânéen	32.38	CINELLI ciseau-burin	46.19	COAKLEY curette pour le sinus maxillaire	46.26
burin spinal	32.38	cisaille sternale	56.03	COAKLEY trocart pour le sinus maxillaire	22.03
BURKE pince à biopsie	70.26	ciseau à corps étrangers	42.06	COBB curette à fusion spinale	32.30
BUSCH ciseaux à cordon ombilical	08.14	ciseau à extirpation	42.06	COBB élévateur spinal	32.52
		ciseau hémostatique (pylon carré)	44.19	COBB gouge spinale	32.37
		ciseau pour enfoncer les plaques angulaires	34.05	COBBET dermatome	06.12
		ciseau sternal	32.38	cobra levier à os	32.54
		ciseau-burin	32.35	CODIVILLA pince pour la clavicule	32.21
		ciseau-burin à lames interchangeables	32.33	COLCLOUGH pince emporte-pièce intervertébrale	40.22
		ciseau-burin à spongieuse	32.37	colibri ciseaux iris	09.02
		ciseau-guide pour plaques angulaires	34.04	COLLIER porte-aiguille	24.02

C

cadre nylon pour laparotomie	18.47
CAIRNS pince hémostatique	12.06

Index alphabétique

COLLIN clamp pour le cordon ombilical 72.05
 COLLIN curette utérine 70.35
 COLLIN DUVAL pince 10.06
 COLLIN dynamomètre 02.05
 COLLIN écarteur 18.02
 COLLIN écarteur abdominal 18.57, 18.58
 COLLIN écarteur bébé 18.58
 COLLIN HARTMANN écarteur 18.04
 COLLIN hystéromètre 70.22
 COLLIN manche de bistouris 06.03, 06.04
 COLLIN marteau 32.40
 COLLIN pince à pansements 16.04
 COLLIN pince hémostatique 12.11
 COLLIN pince hystérolabe 70.21
 COLLIN pince pour agrafes, 26.08
 COLLIN pince tirelangue 48.04
 COLLIN spéculum vaginal 70.03
 COLLYER compas pelvimètre 72.05
 COLVER pince a prehension amygdalienne 50.04
 compas marqueur 42.11
 compas pelvimètre 72.05
 compresseur amygdalien 50.06
 compresseur urétral 66.05
 conchotome 46.10
 conducteur de fil métallique 33.13
 conducteur de ligatures 26.04
 CONE aiguille ventriculaire 40.16
 CONE écarteur à branches articulées 18.34
 CONE pince craniotome 40.07
 CONNIN AMSLER marqueur 42.11
 containers à stérilisation 88.11, 88.12, 88.14 - 88.19
 CONTOUR écarteur mousse 18.30
 contre-écarteur 18.42
 contrôleur d'angle 34.04
 CONVERSE bistouri pour la plastie nasale 46.14
 CONVERSE écarteur pour les ailes nasales 46.24
 COOLEY dilateur vasculaire 56.17
 COOLEY écarteur atrium 56.11
 COOLEY pince atraumatique 11.03
 COOLEY tube d'aspiration 04.03
 COOPER aiguille 26.02
 corbeille à stérilisation en fil métallique treillis 88.08
 CORDES embout de pince 52.03
 cordons à diathermie 92.06
 CORWIN compresseur amygdalien 50.06
 CORYLLOS costotome 56.02
 CORYLLOS écarteur thoracique 18.20
 COS pince à fil métallique 44.12
 costotome 56.02, 56.03
 COTTLE bistouri à plastie nasale 46.14
 COTTLE ciseau-burin à plastie nasale 46.18
 COTTLE ciseaux nasaux 08.09
 COTTLE écarteur 46.24
 COTTLE élévateur cloison 46.16
 COTTLE introducteur de cartilage 46.23
 COTTLE KAZANJIAN pince coupe-os 32.13
 COTTLE marteau 32.40
 COTTLE périostotome 46.17
 COTTLE pince à columella 46.26
 COTTLE pince à saisir la peau 46.26
 COTTLE presse pour la matière cartilagineuse 46.23
 COTTLE spéculum nasal 46.04
 coupe-bague 33.03
 coupe-cors 74.04
 coupe-fils et clous 33.18
 couteau à phalanges 06.11
 couteau à amputation 06.10
 couteau à autopsie 06.13
 couteau à capsulotomie 42.05
 couteau à cartilages 06.13
 couteau à cataracte 42.04
 couteau à cerveau 06.13
 couteau à cloison 46.14
 couteau à conisation 70.29
 couteau à dissection 42.05
 couteau à iridectomie 42.06
 couteau à organes 06.13
 couteau à périoste 44.19
 couteau à plâtre 30.04
 couteau à résection 06.10
 couteau à trigéminus 40.09
 couteau à végétations adénoïdes 46.27, 46.28
 couteau amygdalien 50.04
 couteau auriculaire 44.08, 44.17
 couteau circulaire 44.17

couteau cornéen 42.05
 couteau forme serpette 44.17
 couteau inter-osseux 06.11
 couteau lobaire 06.11, 44.17
 couteau mobile 46.15
 couteau pour kératoplastie 42.06
 couteau pour la cloison nasale 46.15
 couteau pour la plastie nasale 46.14
 couteau pour l'arachnoïde 40.29
 couteau vasculaire 40.29
 COVENTRY agrafe 36.25
 COXETER sonde prostatique 66.07
 CRAFOORD (STELZNER) ciseaux 08.16
 CRAFOORD pince bronchique 12.18
 CRAIG pince à cloison et vomer 46.07
 cranioclaste 72.07
 CREA bougie dilatatrice urétrale 66.08
 Credo coupe-cors 74.04
 CRILE crochet à nerfs 40.05
 CRILE pince hémostatique 12.05
 CRILE porte-aiguille 24.07
 CRILE RANKIN (OCHSNER DIXON) pince hémost. 12.06
 CRILE RANKIN pince hémostatique 12.06
 CRILE WOOD porte-aiguille 24.03
 CRITCHETT blépharostat 42.02
 crochet à duremère 18.07
 crochet à extraction ophthalmique 42.07
 crochet à fixation 42.07
 crochet à iris 18.07, 42.07
 crochet à muqueuse 46.24
 crochet à nerfs 40.05, 40.26
 crochet à peau 74.02
 crochet à strabisme 42.07
 crochet artériel 40.05
 crochet auriculaire 44.09
 crochet boutoné 44.09
 crochet a décapitation 72.08
 crochet délicat 46.25
 crochet d'extraction 70.21
 crochet fistulaire 70.29
 crochet malléable mousse 40.25
 crochet musculaire 42.07
 crochet obstétrique 72.05
 crochet pointu pour le contrôle 33.25
 crochet pour écarteur à hémilaminectomie 18.40
 crochet pour la chirurgie de l'ovule 44.17, 44.18
 crochet pour la lentille cristalline 42.07
 crochet pour la muqueuse 18.07
 crochet pour l'extaction des clous à os 33.19
 crochet rigide mousse 40.25
 crochet tire-clous 33.19
 crochets explorateurs et à coagulation 40.26
 crochets pour la chirurgie de la main 18.24
 crochets simple et double 18.07
 Croix Rouge ciseaux à pansements 08.21
 CROTTI écarteur à goitre 18.28
 CRUTCHFIELD alésoir 40.04
 cuiller à calculs biliaires 62.04
 cuiller à faux gemes 72.06, 72.07
 cuiller à sécrétion 72.07
 cuiller malléable 40.25
 cuiller micro coupante 40.28
 cuiller utérine tranchante 70.31
 CULLER spatule pour l'iris 42.09
 curette à aspiration utérine 70.36
 curette à biopsie à panier 70.24
 curette à cataracte 42.08
 curette à chalazion 42.08
 curette à corps étrangers 42.06
 curette à exentération 42.08
 curette à fusion spinale 32.30
 curette à irrigation utérine 70.24
 curette auriculaire 32.32, 44.07, 44.18
 curette et crochet 44.08
 curette et dissector pour le sac lacrymal 42.09
 curette grattoir 74.02
 curette pituitaire 40.28
 curette pour disque rompu 32.29
 curette pour le sinus maxillaire 46.26
 curette pour lupus 74.02
 curette tranchante à os 32.26 - 32.32, 46.26
 curettes à biopsie utérine 70.23, 70.24
 curettes à hypophysectomie 40.24, 40.25
 curettes utérines 70.31 - 70.36
 CUSCO spéculum vaginal 70.04, 70.05

CUSHING „Little Joker“ rugine 32.46
 CUSHING crochet artériel 40.05
 CUSHING écarteur 18.09
 CUSHING écarteur à nerfs 40.05
 CUSHING écarteur pour la dure-mère 40.05
 CUSHING KOCHER écarteur 18.14
 CUSHING LANDOLT spéculum 40.23
 CUSHING pince à dissection 10.05
 CUSHING pince à laminectomie 40.17
 CUSHING pince hémostatique 12.07
 CUSHING spatule cérébrale 40.15
 CUSHING TAYLOR pince atraumatique TC 38574
 cuvette ronde 88.03
 CUZZI cuiller à faux gemes 72.06
 cyclodialyse, spatule à 42.10
 CZERNY écarteur 18.04
 CZERNY pince pour l'abaissement du col 70.20
 CZERNY spéculum rectal 68.02

D

DAHLGREN pince crânienne 40.07
 DALE pince gouge 32.12
 DANDY ciseaux neurochirurgicaux 08.15
 DANDY écarteur à nerfs 40.05
 DANDY mosquito pince hémostatique 12.09
 DANDY pince hémostatique 12.09
 DANIELS amygdalotome hémostatique 50.08
 DANIS tendeur du fil métallique 33.13
 DARLING écarteur 18.34
 DARTIGUES pince hystérolabe 70.21
 DASTOOR aspirateur capsula 42.11
 DASTOOR pince à strabisme 42.16
 DAUBENSPECK curette à os 32.27
 DAVIDSON (scapula) écarteur 18.21
 DAVIEL curette à cataracte 42.08
 davier porte-os 32.15 - 32.22
 DAVIS aiguille pour corps étrangers 42.06
 DAVIS BOYLE ouvre-bouche 48.07
 DAVIS dissector à dure-mère 40.08
 DAVIS MEYER ouvre-bouche 48.09
 DAVIS pince à saisir seringues 28.02
 DAY crochet auriculaire 44.09
 DCS plaque 36.09
 DE BAKY DIETRICH pince à dissection 11.04
 DE BAKY dilateur vasculaire 56.17
 DE BAKY pince extra légère atrauma 11.06
 DE BAKY porte-aiguille 24.04
 DE BAKY tube d'aspiration 04.02
 de LEE forceps 72.02
 De LEE HILLIS stéthoscope 02.09
 De LEE pelvimètre pour mesurer intérieurement 72.05
 De MARTEL guide-scie 40.06
 DEAN ciseaux à amygdales 08.09, 08.10
 DEAN couteau à iridectomie 42.05
 DEAYER ciseaux 08.03
 DEAYER écarteur 18.06, 18.07
 DEAYER grip écarteur 18.07
 DEBAKEY atrauma pince 11.03
 DEBAKEY Bulldog clamp atrauma 12.02
 DEBAKEY ciseaux vasculaires 08.11
 DEBAKEY ciseaux vasculaires et thoraciques 08.12
 DEBAKEY dilateur vasculaire 56.17
 DEBAKEY écarteur 56.07
 DEBAKEY écarteur costal 56.07
 DEBAKEY écarteur pour le fémur 18.56
 DEBAKEY pince à dissection 11.04
 décolleur amygdalien 50.02
 décolleur pour la microchirurgie de l'oreille 44.18
 DEJERINE marteau 02.10
 DeMARTEL WOLFSON pince à anastomose 64.10
 DEMEL conducteur de fil métallique 33.13
 DEMEL pince serre-fil 33.13
 DENHART ouvre-bouche 48.05
 DENNIS BROWNE pince intestinale 10.09
 DENNIS BROWNE écarteur abdominal 18.49
 dépresseur d'épiglotte 52.02
 dépresseur utérin 70.21
 DERF (WRIGHT) porte-aiguille 70.22
 DERF porte-aiguille 24.02
 dermatome 06.12
 DERRA pince à anastomose 56.16
 D'ERRICO foret 33.05
 DESCHAMPS aiguille à ligature 26.02
 DESJARDINS clamp pour le conduit biliaire 12.23

Index alphabétique

fourchette pour ligatures en profondeur	26.04
FOX curette lupus	74.02
FRAENKEL embout de pince laryngienne	52.03
fraise	33.04, 33.05, 33.09, 34.08, 34.08
FRANCESCHETTI trépan cornéen	43.08
FRANCIS aiguille pour corps étrangers	42.06
FRANKLIN SILVERMANN aiguille à ponction	22.05
FRAZIER crochet à duremère	18.07
FRAZIER écarteur	18.44
FRAZIER séparateur pour la duremère	40.09
FRAZIER tube à ponction	40.16
FRAZIER tube d'aspiration	40.15
FRAZIER tube d'aspiration isolé	40.16
FREER bistouri à muqueuse	46.14
FREER ciseau-burin	46.17
FREER couteau à cloison	46.14
FREER crochet à muqueuse	46.24
FREER élévateur à cloison	46.16
FREER élévateur aspirateur	46.29
FREER gouge	46.20
FRIEDMAN écarteur à périnéorrhaphie	70.13
FRIEDMAN pince gouge	32.02
FRTSCH écarteur	18.17
FRYKHOLM pince gouge	32.10
FUCHS pince capsulaire	43.04
FUCHSIG pince hémostatique	12.14

G

gabarit pour clous intramédullaires	36.06
GABRIEL spéculum rectal	68.05
GALLAHER râpe pour le sinus	46.22
GARRETT dilateur vasculaire	56.18
GAST abaisse-langue	48.09
gouchers, ciseaux pour	08.01, 08.03, 08.05, 08.07, 08.20

gouchers, porte-aiguille pour	24.02 - 24.04
GAUSS pince péricarénienne	72.05
GELLHORN pince à biopsie	70.25
GELPI écarteur périméal	18.56
Gemini mini pince à dissection et a ligature	12.17
GERALD pince à griffes	10.08
GERSTER écarteur pour daviers porte-os	32.22
GIERTZ STILLE costotome	56.03
GIGLI manche pour scie en fil métallique	40.06
GIGLI scie fil métallique	40.06
GIL VERNET écarteur	18.09
GILL ARRUGA pince capsulaire	43.03
GILL couteau cornéen	42.05
GILL HESS pince à iris	42.14
GILL pince à iris	42.14
GILLIES (FRENCH) ostéotome	32.34
GILLIES crochet délicat	46.25
GILLIES pince à dissection	10.07
GILLIES pince à griffes	10.07
GILLIES porte-aiguille	24.09
GIRARD pince à suture cornéodérolale	43.05
GLASER écarteur à laminectomie	18.64
GLOVER clamp cardiovasculaire atrauma	12.02
GLUCK costotome	56.02
GOELET écarteur double	18.04
GOLDMAN FOX ciseaux à genèives	08.18
GOLDSTEIN blépharostat	42.03
GOOD ciseaux à amygdales	08.10
GOODELL dilateur utérin	70.17
GORNEY ciseaux à dissection fins	08.04
GOSSET écarteur abdominal	18.44
gouge	32.33 - 32.37, 42.06, 46.20

GOURDET curette utérine	70.31
GRADLE pince à épiler les cils	43.10
GRAEFE blépharostat	42.02
GRAEFE couteau à cataracte	42.04
GRAEFE crochet (iris)	18.07
GRAEFE crochet à strabisme	42.07
GRAEFE crochet à strabisme en titane	42.07
GRAEFE curette à cataracte	42.08
GRAEFE kistitome	42.07
GRAEFE pince à fixation	43.03
GRAEFE pince à iris	42.12, 42.13
GRAEFE pince dentelée	10.05

GRAHAM écarteur à nerfs	40.05
GRAVE spéculum vaginal	70.02, 70.06
GRAVE spéculum vaginal „view more“	70.06
GRAY pince clamp pour conduit biliaire	12.24
GREEN ARMYTAGÉ pince clamp utérin	72.05
GREEN crochet musculaire	42.07
GREEN dissecteur cornéen	42.06
GREEN écarteur	18.16
GREEN pince à fixation	43.03
GREENE curette utérine	70.34
GREVEN pince à fil métallique	44.12
GROSS curette et crochet	44.08
GROSS MAIER pince à pansement	16.02
GRUBER spéculum auriculaire	44.02
GRUENWALD pince nasale forme baïonnette	46.05
guide angulaire pour vis de hanche	34.08
guide de mèches réglable	34.06
guide pour broches téléscopique	33.05
guide téléscopique seule	33.05
guide-mèche	33.25, 33.26, 34.04
guide-mèche (viseur)	34.07
guide-mèche et protecteur de tissu	33.26
guide-sondes trachéales	04.04
guide-taraud et guide mèche	33.22
GUILLEN canule à irrigation	46.29
GUTHRIE crochet double	18.07
GUTMANN cuiller à sécrétion	66.05
GUTSCH périostotome	32.52
GUYON bougie dilatrice	66.06
GUYON bougie dilatrice à filet intérieur	66.06
GUYON mandrin pour sondes en caoutchouc	66.05
GUYON pince à pédicule rénal	12.24
GUYTON LUNDSGAARD sclérotome	42.06

H

HABERER (TUFFIER) écarteur	18.05
HABERER écarteur malléable	18.05
HACKSTOCK pince plate à rainures	33.15
HAGLUND STILLE écarteur à plâtre	30.04
HAIGHT écarteur	56.05
HAJEK BALLENGER élévateur à cloison	46.17
HAJEK CLAUD pince à sinus maxillaire	46.12
HAJEK gouge forme V	46.20
HAJEK KOFLER pince emporte-pièce	46.11
HAJEK marteau	32.41
HAKANSSON pince gouge	32.04
HALLE bistouri à duremère	40.08
HALLE curette malléable	32.29
HALLE élévateur pour la cloison nasale	46.16
HALSEY porte-aiguille	24.02
Hambourg canule boutonée	43.08
HANK dilateur utérin	70.16
HARDY curette malléable	40.24
HARDY dissecteur tranchant	40.24
HARDY énucléateur	40.24
HARDY FAHLBUSCH dissecteur tranchant	40.24
HARDY fourchette à implanter	40.24
haricot	88.03
HARKEN pince à auricule	56.16
HARMS sonde trabéculaire	42.12
HARRINGTON écarteur	18.07
HARRINGTON pince bronchique	56.13
HARTMANN abaisse-langue	48.02
HARTMANN diapason	44.04
HARTMANN HALLE spéculum nasal	46.02
HARTMANN pince à polypes nasaux	46.06
HARTMANN pince auriculaire	44.10, 44.11
HARTMANN pince coupante à amygdales	50.08
HARTMANN pince coupante nasale	46.10
HARTMANN pince hémostatique	12.03
HARTMANN pince-gouge	32.06
HARTMANN sonde auriculaire	44.07
HARTMANN spéculum auriculaire	44.02
HARTMANN spéculum nasal	46.02
HARTMANN WULLSTEIN pince auriculaire	44.11
HARTMANN HOFFMAN pince auriculaire	44.11
HARVEY ciseaux à fil métallique	08.19
HASTED pince hémostatique mosquito	12.04
HATFIELD curette à fusion spinale	32.30
HAUGH pince auriculaire	44.12
HAWKIN AMBLER dilateur utérin	70.16
HEANEY (HEGAR) porte-aiguille	24.05
HEANEY curette à biopsie utérine	70.24
HEANEY écarteur	18.19

HEANEY pince à hystérectomie	12.30
HEATH ciseaux à ligatures	08.18
HEATH marteau	32.43
HEBRA curette à chalazion	42.08
HEGAR dilateur utérin	70.14, 70.15
HEGAR porte-aiguille	24.04
HEGAR porte-aiguille vasculaire	24.05
HEGENBARTH pince pour agrafes	26.07
HEIFETZ pince à tumeurs	11.05
HEIFETZ spatule cérébrale	40.15
HEIMING pince à calculs rénaux	62.06
HEISS pince hémostatique	12.13
HEISTER ouvre-bouche	48.05
HELFERICH BIER scie à amputation	33.02
HENKE élévateur amygdalien	50.02
HENLY écarteur	18.31
HENNER (LEMPERT) écarteur	18.29
HENNIG écarteur à plâtre	30.04
HENROTIN pince pour l'abaissement du col	70.20
HERBERHOLD abaisse-langue	48.10
HERRICK pince à pédicule rénal	12.25
HERTZ pince à saisir les tendons	32.25
HERTZLER écarteur costal	56.11
HESS pince à iris	42.14
HESS pince capsulaire	43.04
HEY GROVES pince à os	32.17
HEYMANN ciseaux nasaux	08.09
HEYMANN KNIGHT pince nasale	46.06
HEYMANN pince coupante nasale	46.08
HEYWOOD SMITH pince hémorrhoidale	68.08
HIBBS ciseau-burin	32.38
HIBBS écarteur	40.06
HIBBS gouge	32.38
HIBBS ostéotome	32.38
HIRSCHMANN anoscope	68.05
HIRSCHMANN écarteur à iris	42.07
HIRSCHMANN spatule à cyclodialyse	42.10
histéromètre	70.22
HOEN (GUTSCH) périostotome	32.52
HOEN décolleur	32.52
HOEN écarteur à hémilaminectomie	18.43
HOEN élévateur pour la dure-mère	40.09
HOEN périostotome	32.52
HOESEL écarteur	18.17
HOESEL porte-aiguille	24.08
HOFER écarteur pilloire	50.02
HOFF pince à champs	14.03
HOHMANN levier à os	32.53 - 32.55
HOHMANN mini levier à os	32.55
HOKE ciseau-burin	32.37
HOLZBACH écarteur abdominal	18.58
HOPKINS couteau à plâtre	30.04
HORGAN valve centrale	18.46
HORSLEY dissecteur à duremère	40.08
HOSOBUCHI spatule bifurquée	40.25
HOUSE curette double	44.18
HOWARTH élévateur double	32.50
HRNTSCHAK écarteur prostatique	66.03
HUBER manche universel	52.03
HUDSON perforateur	33.05
HUMBY dermatome	06.12
HUNT pinces à tumeurs et à vaisseaux	11.06
HUNTER pince à échardes	10.12
HUPP écarteur trachéal	54.03
HURD aiguille pour le palais	50.03
HURD décolleur amygdalien	50.02
HUSTINX écarteur périméal	18.56

I.U.D. crochet d'extraction	70.21
I.U.D. préhenseur flexible	70.21
impacteur d'agrafes osseuses	34.12
impacteur et extracteur de clous osseux	33.18, 33.19, 34.04, 34.10, 34.11
impacteur final	34.04
impacteur initial pour clous 3 ailes	34.11
impacteur pour clous flexibles médullaires	34.10
INGE écarteur vertébral	40.16
instrument à circoncision	66.05
instrument à plier les broches	34.13
instrument pour courber les plaques à os	33.21
instrument pour enfoncer les plaques angulaires	34.05
instrument pour mesurer la longueur des vis	33.23
instrumentation pour le cerclage des os	35.24

Index alphabétique

instruments à corps étrangers	42.06
insufflateur auriculaire	44.06
introduceur d'agrafes osseuses	34.12
introduceur de cartilage	46.23
introduceur de clous osseuses	34.12
introduceur pour clous flexibles médullaires	34.10
IOWA pince utérine	70.19
irrigateur	88.03
IRWIN MOORE pince nasale	46.08
ISRAEL écarteur	18.16
ITARD sonde auriculaire	44.07
ITERSON écarteur trachéal	54.02
IVES FANSLER anuscopie	68.05

J

JACKSON BURROWS écarteur	18.31, 32.57
JACKSON canule trachéale	54.03
JACKSON écarteur à goitre	18.27
JACKSON écarteur trachéal 15 cm	54.02
JACKSON pince porte-tampons	52.02
JACKSON spéculum vaginal	70.10
JACOBS pince utérine	70.19
JACOBSON couteau vasculaire	40.29
JACOBSON curette double	32.32
JACOBSON micro pince	12.14
JACOBSON sonde	40.27
JAEGER kératome	42.04
JAEGER plaque à paupières	42.03
JAMESON ciseaux	08.07
JAMESON crochet à strabisme	42.07
JAMESON pied à coulisse	42.11
JAMESON pince à strabisme	42.16
JAMESON pince musculaire	43.07
JAMISON porte-aiguille	24.05
JANSEN curette tranchante	32.31
JANSEN écarteur	18.27
JANSEN GIFFORD écarteur	18.27
JANSEN pince auriculaire	44.09
JANSEN pince gouge	32.05, 32.06
JANSEN pince nasale	46.05
JANSEN STRUYCKEN pince coupante nasale	46.12
JANSEN WAGNER écarteur	18.27
JARCHO pince utérine	70.18
JATHO pince nasopharyngienne	46.26
jauge de profondeur pour vis osseuses	33.25
jauge pour mèches et vis	33.25
JEANS pince striée	10.06
JENNINGS ouvre-bouche	48.06
jeu de trachéotomie en boîte	54.03
JEWETT bougie urétrale dilatatrice	66.08
JEWETT clou pour le tal du fémur	36.08
JEWETT impacteur extracteur	34.11
JOBSON HORNE porte-coton	20.06
JOHNS HOPKINS serre-fine	12.03
JOHNSON porte-aiguille	24.06
JONES pince à champs	14.02
JONES pince hémostatique	12.09
JOSEPH (LEWIS) râpe nasale	46.21
JOSEPH bistouri à plastie nasale	46.13, 46.14
JOSEPH ciseaux	08.06
JOSEPH crochet à muqueuse	18.07
JOSEPH élévateur à cloison	46.16
JOSEPH lime à os	46.20
JOSEPH MASING élévateur de périoste	46.17
JOSEPH périostatome	46.16
JOSEPH scie nasale	46.23
JUDD ALLIS pince à intestins et tissus	64.02
JUDD MASSON écarteur vésical	66.03
JUERS pince auriculaire à fil métallique	44.12
JULIAN porte-aiguille	24.05
JURASZ pince à polypes laryngiens	52.02

K

KABIERSKE lance-poudre	44.05
KADER écarteur	18.20
KALLMORGEN spéculum vaginal	70.09
KALT ARRUGA porte-aiguille	24.10
KALT pince capsulaire	43.04
KALT porte-aiguille	24.10
KANE damp pour codon ombilical	72.05
KANTROWITZ pince passe-fil et dissector	12.20
KATZIN ciseaux cornéens	09.03
KEITH aiguille à suture	26.06

KELLY ciseaux fistulaires	08.13
KELLY écarteur	18.18
KELLY GRAY curette à biopsie utérine	70.23
KELLY pince à polypes utérins	70.20
KELLY pince hémostatique	12.05, 12.15
KELLY proctoscope	68.05
KELLY RANKIN pince hémostatique	12.05
kératome	42.04
KERBOUL plaque humérale épicondylaire	36.22
KERBOUL plaque radiale	36.22
KERBOUL plaque tibiale	36.22
KERN davier porte-os	32.16
KERPEL curette osseuse tranchante	32.27
KERRISON pince emporte-pièce	46.11
KEVORKIAN curette à biopsie utérine	70.23
KEVORKIAN embout de pince à biopsie	70.28
KEVORKIAN Pacific pince à biopsie	70.27
KEVORKIAN pince à biopsie	70.26
KEY élévateur	32.50
KEYES trépan cutané	74.03
KIELLAND forceps	72.02
KIELLAND LUIKART forceps	72.03
KILLIAN ciseaux à cloison	46.11
KILLIAN ciseaux pour la cloison	46.11
KILLIAN CLAUS gouge en V	46.20
KILLIAN élévateur à cloison	46.17
KILLIAN gouge pour la cloison	46.20
KILLIAN pince à cloison nasale	46.07
KILLIAN spéculum nasal lumière froide	46.04
KILLIAN spéculum pour la cloison nasale	46.04
KILNER ciseaux	08.06
KILNER crochet cutané	74.02
KILNER DOUGHTY ouvre-bouche	48.08
KILNER écarteur pour les ailes	46.24
KILNER porte-aiguille	24.03
KIRBY ARTHUR pince à iris	42.15
KIRK marteau	32.40
KIRSCHNER broche	33.10
KIRSCHNER écarteur abdominal	18.48, 18.49
KIRSCHNER étrier	33.12
KIRSCHNER étrier américain	33.12
KIRSCHNER perforateur avec guide télescopique	33.05
KIRSCHNER sonde conductrice	26.04
kitistome	42.07
KLAPP écarteur à gaines tendineuses	18.12
KLAPP écarteur à tendons	18.12
KLEINERT KUTZ pince à saisir les tendons	32.25
KLEINERT KUTZ pince coupe-os	32.14
KLEINSASSER laryngoscope	52.05
KLEINSCHMIDT pince à appendectomie	64.04
KLINKENBERGH LOTH ciseaux thoraciques	08.16
KNAPP curette à cataracte	42.08
KNAPP écarteur	42.07
KNAPP LUER pince à trachome	43.07
KNIGHT pince coupante nasale	46.08
KNIGHTON élévateur à laminectomie	18.35
KNOLLE écarteur	42.07
KNOWLES ciseaux à bandages	08.21
KOCHER écarteur	18.11, 18.14, 18.17, 18.28
KOCHER LANGENBECK écarteur	18.15
KOCHER Nippon pince hémostatique	12.07
KOCHER pince hémostatique	12.08
KOCHER pince intestinale	64.05, 64.06
KOCHER spatule à goitre	54.04
KOCHER spatule vésicale	54.04
KOENIG aiguille à suture	26.06
KOENIG écarteur	18.10
KOENIG élévateur	32.50
KOENIG sonde conductrice	26.04
KOERTE écarteur	18.17, 18.19
KOGAN endospéculum	18.26
KONRICH boîte à stérilisation à filtre	70.13
KOOS bistouri vasculaire	88.05
KRAUSE serrenæud auriculaire	40.29
KRAYENBUEHL crochet à nerfs	44.09
KRESSNER pince à cloison nasale	40.26
KRISTELLER spéculum vaginal	46.10
KRONECKER aiguille	70.07 - 70.09
KUEMMLER écarteur abdominal	26.02
KUENTSCHER alésior fémoral	18.19
KUENTSCHER chasse-clous	33.18
KUENTSCHER clou fémoral	33.19
KUENTSCHER clou huméral	36.04, 36.05
KUENTSCHER extracteur à deux crochets	36.06
KUENTSCHER impacteur	33.19

KUENTSCHER perforateur	33.18
KUHNT rugine cornéenne	42.06

L

LABORDE dilatateur trachéal	54.02
LACK abaisse langue	48.03
LAFORCE adénotome	46.28
LAHEY (SWEET) clamp pour le conduit biliaire	12.22
LAHEY écarteur	18.12
lait à instruments	88.23
LAMBERT pince à chalazion	43.06
LAMBOTTE davier porte-os	32.15, 32.16
LAMBOTTE mini ostéotome	32.36
LAMBOTTE ostéotome	32.36
LAMBOTTE rugine	32.45
lame de bistouri microchirurgicale	06.08
lame de bistouri stérile	06.05
lampe frontale	02.05
lance-poudre	44.05
LANDAU spéculum	70.13
LANDOLT crochet malléable mousse	40.25
LANDOLT curette malléable	40.25
LANDOLT écarteur pour ouvrir les spéculums	40.23
LANDOLT manche de bistouris micro baïonnette	06.08
LANDOLT pince à saisir tumeurs	40.18
LANDOLT REULEN crochet	40.25
LANDOLT REULEN curette	40.25
LANDOLT REULEN dissector	40.25
LANDOLT REULEN raspatoire	40.25
LANE (PAUCHET) pince à champs	14.04
LANE davier porte-os	32.16
LANE écarteur	18.03
LANE levier à os	32.56
LANE pince à dents	10.05
LANE pince clamp stomacale	64.11
LANE tourne-vis	33.20
LANG curette et dissector pour le sac lacrymal	42.09
LANG embout de pince	52.03
LANGE HOHMANN levier	32.54
LANGENBECK couteau à résection	06.10
LANGENBECK couteau lobaire	06.11
LANGENBECK curette auriculaire	44.08
LANGENBECK davier porte-os	32.15
LANGENBECK doigtier	48.12
LANGENBECK écarteur	18.13, 18.17
LANGENBECK écarteur mini	18.10
LANGENBECK élévateur	32.46
LANGENBECK GREEN écarteur	18.10
LANGENBECK MANNERFELDT écarteur	18.25
LANGENBECK porte-aiguille	24.07
LANGENBECK rugine raspatoire	32.46
laryngoscope	04.05, 04.06, 52.05
LAWRENCE pince hémostatique et dissector	12.19
LE MEE abaisse-langue et aspirateur	48.03
LEBSCHKE ciseau sternal	32.38
LEE forceps	72.02
LEE HILLIS stéthoscope	02.09
LEECH WILKINSON canule intra-utérine	70.30
LEFORT bougie urétrale dilatatrice	66.08
LEGUEU écarteur vésical	66.04
LEGUEU spatule vésicale	66.03
LEKSELL (STILLE) pince gouge	32.09
LEKSELL pince gouge	32.09
LEMMON approximateur sternal	56.12
LEMPERT curette tranchante	32.29
LEMPERT écarteur	18.29
LEMPERT élévateur	44.19
LEMPERT pince gouge	32.04
LERCHE pince à dents	10.05
LERICHE écarteur abdominal	18.19
LERICHE pince hémostatique	12.12
LESTER pince à fixation	43.03
levier à corps étrangers	44.10
levier à os	32.52 - 32.57
levier à phalanges	32.51
levier pour l'abaissement de la tête	72.07
LEWIN davier porte-os	32.19
LEXER baby ciseaux	08.04
LEXER ciseau-burin	32.36, 32.37
LEXER ciseaux	08.04
LEXER ciseau burin à spongieuse	32.37
LEXER fino ciseaux	08.04
LEXER gouge	32.36, 32.37
LEXER mini ciseau burin	32.36

LEXER mini gouge	32.36
LEXER ostéotome	32.37
LEYLA écarteur, système de	40.10 - 40.14
LICHTENBERG porte-aiguille	24.08
LICHTWITZ aiguille pour le sinus maxillaire	46.13
ligateur aspirateur hémorrhoidal	68.10
ligateur hémorrhoidal	68.09
lime à angles	74.04
lime à os	46.20
LISTER (sinus) pince à pansement	16.04
LISTER BURCH blépharostat	42.03
LISTER ciseaux à bandages	08.20
LISTON couteau à amputation	06.10
LISTON pince coupante à os	32.13
LITTAUER ciseaux à ligatures	08.18
LITTAUER pince à épilier	43.10
LITTAUER pince à polypes nasales	46.06
LITTAUER pince auriculaire	44.10
LITTLE écarteur	18.12
Little Joker rugine	32.46
LITTLER ciseaux	08.04
LITTLEWOOD pince à intestins et à tissus	64.04
LLOYD chasse-clou et extracteur	34.11
LLOYD DAVIS ciseaux redoux	08.16
LLOYD DAVIS écarteur pelvien	18.19
LLOYD DAVIS pince à anastomose rectale	64.08
LLOYD DAVIS pince à biopsie	68.07
LLOYD DAVIS protoscope pour enfants	68.04
LLOYD DAVIS rectoscope	68.04
LLOYD DAVIS sigmoïdoscope	68.04
LLOYD impacteur et extracteur de clous	33.19
LOCKHART MUMMERY sonde	20.04
LOCKLIN ciseaux à plastie	08.07
LOCKWOOD ALLIS pince à saisir les intestins	64.03
LOCKWOOD pince à saisir les intestins	64.03
LOGAN écarteur	18.26
LORDAN pince à chalazion	43.06
LORENZ ciseaux à bandes	08.21
LORNA (EDNA) pince à champs	14.03
LORTAT JACOB cadre porte instruments	88.23
LOUTE tendeur serre-fil	33.13
LOVE écarteur à racine de nerfs	40.06
LOVE écarteur uvulaire	50.02
LOVE GRUENWALD pince à laminectomie	40.17
LOVELACE pince hémostatique	12.10
LOVELACE pince pulmonaire	56.13
LOWER clamp pour le conduit biliaire	12.23
LOWMAN davier à os	32.22
LOWMAN HÖGLUND davier à os	32.22
LUBET BARBON pince aux polypes nasaux	46.06
LUC pince coupante nasale	46.08
LUCAE aiguille à paracémèse	44.07
LUCAE crochet boutonné	44.09
LUCAE diapason	44.05
LUCAE marteau	32.41
LUER canule trachéale	54.03
LUER écarteur	18.03
LUER KOERTE cuiller à calculs biliaires	62.04
LUER pince gouge	32.03
LUER pince hémorrhoidale	68.08
LUJKART BILL tracteur	72.04
LUJKART McLean forceps	72.03
LUNDSGAARD sclérotome	42.06
LUNIATSCHEK obturateur à gaze	50.03

M

MAGILL pince à introduire sondes	04.04
MAGILL tube d'aspiration	04.03
maillet	32.41
main en plomb	32.22
MAINGOT pince à hystérectomie	12.30
MAINGOT pince intestinale	10.10
MAISONNEUVE urétrorotome	66.04
MALIS écarteur cérébral	18.61
MALTZ (COTTLE) râpe nasale	46.21
manche de bistouris	06.02 - 06.04, 06.08
manche de bistouris micro	06.08
manche de scie en fil métallique	40.06
manche pour miroirs laryngiens	52.07
manche pour tire-veines	20.05
mandrin à 3 mâchoires	33.06
mandrin Jacobs	33.07
mandrin pour sondes coouthouc	66.05
MANNERFELDT crochet	18.24

MANNERFELDT écarteur	18.24, 18.25
MARKHAM MEYERDING écarteur	18.38
MARKWALDER pince gouge	32.13
MARSCHIK pince à amygdales	50.05
marteau percuteur	02.10, 02.11
marteau pour la chirurgie osseuse	32.40 - 32.44
MARTEL guide-scie	40.06
MARTEL pince pour le cuir chevelu	12.10
MARTIN écarteur	18.18
MARTIN hystéromètre	70.22
MARTIN pince à cartilages	32.20
MARTIN pince à polypes	16.06
MARTIN pince pour l'abaissement du col	70.17
MARTINI curette	32.32
MASING rugine a périoste	46.17
Mass. Gen. Hospital porte aiguille	24.06
MASSON porte-aiguille	24.05
MASTIN pince musculaire	54.04
MATHIEU écarteur	18.03
MATHIEU pince à coprs étrangers	66.04
MATHIEU porte-aiguille	24.08
MATHIEU spéculum rectal	68.03
MATSON ALEXANDER rugine	32.48
MATSON rugine à périoste	32.48
MAUNDER baillon en bois	48.12
MAY ophthalmoscope	02.07
MAYFIELD pince gouge	32.11
MAYO (HARRINGTON) ciseaux 23cm	08.03
MAYO ADAMS écarteur	18.30
MAYO BLAKE pince à calculs biliaires	62.02
MAYO ciseaux	08.03
MAYO COLLIN écarteur	18.02
MAYO cuiller à calculs biliaires	62.04
MAYO 'épingle de sécurité' porte-instruments	28.02
MAYO GUYON pince à pédicule	12.24
MAYO HEGAR porte-aiguille	24.04
MAYO NOBLE ciseaux	08.04
MAYO pince modèle russe	10.06
MAYO ROBSON pince intestinale	64.07, 64.12
MAYO sonde à calculs rénaux	62.04
MAYO STILLE ciseaux	08.03
McCREA bougie urétrale dilatatrice	66.08
McCULLOUGH pince à strabisme	42.16
McDONALD élévateur	32.50
McGEE crochet	44.18
McGEE pince auriculaire à fil métallique	44.12
McGIVNEY (SCHÜTZ) ligateur hémorrhoidal	68.09
McGIVNEY pince à prehension	68.08
McGUIRE ciseaux cornéens	09.02
McINDOE ciseaux à cartilages	08.15
McINDOE pince	10.07
McINDOE pince coupante à	32.14
McINTOSH laryngoscope	04.05
McIVOR abaisse-langue	48.08
McIVOR ouvre-bouche	48.08
McKENY élévateur pour la cloison nasale	46.15
McKENZIE foret	33.05
McKENZIE fraise	33.05
McKENZIE pince à poser les clips cérébraux	40.02
McKENZIE porte-agrafe	40.03
McKISSOCK ciseaux à dure-mère	08.15
McLAUGHLIN plaque pour le col du fémur	36.07
McLEAN forceps	72.03
McLEAN LUJKART forceps	72.03
McLEAN TUCKER forceps	72.03
McPERSON pince à ligatures	43.05
MEAD marteau	32.42
MEAD pince gouge	32.02
mèche osseuse	18.41, 33.04, 33.05, 33.07, 33.22
Med-i-Tape bande à identification des instruments	88.10
MEEKER pince hémostatique et dissecteur	12.19
MELLINGER AXENFELD blépharostat	42.02
MELLINGER blépharostat	42.02
MENGHINI aiguille pour la ponction du foie	22.05
MENGHINI seringue d'aspiration	22.05
MENGHINI trocart pour l'aiguille à ponction	22.05
méniscotome	32.58
MERCEDES écarteur thoracique	56.08
mesure graduée	88.03
METZENBAUM ciseaux	08.05
METZENBAUM fino ciseaux	08.05
METZENBAUM porte-aiguille	24.06
MEYER pince à réduction	32.21
MEYERDING écarteur	18.12, 18.21, 18.38

MEYERDING valve	18.63
MEYHOEFER curette à chalazion	42.08
MICHEL agrafes	26.08
MICHEL miroir laryngien	46.05
MICHEL pince à agrafes	26.07
micro mosquito pince	12.04
micro pinces	10.03, 10.04, 11.02, 12.14
MIDDELDRPF écarteur	18.16, 18.22
MIDDLETON JANSEN pince coupante	46.12
MIKULICZ baby pince à péritoine	12.26
MIKULICZ écarteur	18.18
MIKULICZ pince à péritoine	12.26
MILAN curette malléable	70.24
MILLIGAN dissecteur à dure-mère	40.07
MILLIN écarteur pour le col de la vessie	66.04
MILLIN écarteur vésical	66.04
MILLIN pince à saisir les lambeaux	66.02
MILLIN pince capsulaire atraumatique	66.02
MILLIN pince porte-fil	66.02
MILLIN tube d'aspiration	04.03
mini ciseau-burin	32.36
mini conteneur aluminium	88.19
mini écarteur	18.03
mini gouge	32.36
mini levier à os	32.55
mini ostéotome	32.36
mini pince gouge	32.02
mini tresse à varices	20.04
miroir frontal	02.05
miroir laryngien	52.07
miroir posthinoscopique	46.05
MISKIMON écarteur cérébral	18.30
MIXTER baby pince hémostatique	12.21
MIXTER clamp pour le conduit biliaire	12.23
MIXTER O'SHAUGNESSY pince	12.22
MIXTER passefil	12.20
MIXTER pince à calculs biliaires	62.02
MIXTER pince hémostatique et bronchique	12.21, 12.22
MOCK aiguille à irrigation d'héparine	22.04
MOELTGEN goniomètre	02.11
MOLLISON écarteur	18.29
MOORE cuiller à calculs biliaires	62.02
MOORE perforateur à main	33.04
MOORFIELD pince à suture	43.05
MORITZ SCHMIDT abaisse langue	48.03
MORRIS écarteur	18.18
MORSE écarteur	56.08
MORSE FAVALORO écarteur des côtes	56.09
mosquito pince hémostatique	12.04, 12.09
moteur à main électrique	33.07
moulin à os	32.60
MOYNIHAN pince à champs	14.04
MOYNIHAN pince clamp	12.23
MOYNIHAN pince hémostatique	12.07
MOYNIHAN sonde à calculs biliaires	62.03
MUCK couteau à périoste	44.19
MUELLER blépharostat	42.03
München curette à prélèvements	70.23
Munich curette à prélèvements	70.23
MURDOCK blépharostat	42.02
MURPHY écarteur	18.12
MURPHY LANE élévateur double 'bone skid'	32.52
MUSEUX pince utérine	70.17, 70.19
MYERS tire-veine	20.03
MYLES canule à irrigation	46.29
MYLES pince coupante nasale	46.10

N

NABATOFF tresse à varices	20.03
NAEGELE forceps	72.02
NAGER aiguille à amygdales	50.03
NAGER écarteur du palais	50.02
NATIONAL HOSPITAL marteau-percuteur	02.11
NAUTON MORGAN porte aiguille	24.07
NEFF méniscotome	32.58
NEGUS pince hémostatique amygdalienne	12.15
NEGUS support contre-poitrine	48.11
NEIVERT écarteur double	46.25
NEIVERT porte aiguille	24.02
NELATON stylet cannelé	20.02
NELSON aiguille à ligature	26.02
NELSON pince	10.09
NELSON trocart thoracique	22.03
neodisher® détérisif pour nettoyer à fond	88.23

Index alphabétique

neodisher® IP spray lubrifiant	88.23
nettoie-canal pour vis osseuses	33.23
NICOLA curette malléable	40.24
NICOLA décolleur	40.24
Nippon pince hémostatique	12.07
NISSEN pince à colédoque	12.21
NORFOLK et NORWICH écarteur	18.36
NORTHBENT (SPENCER) ciseaux à ligature	08.17
NORTHFIELD écarteur	18.35
NORTHFIELD pince gouge	32.07
NOTO pince à polypes utérins	70.20
NOVAK curette d'aspiration	70.23
NOYES ciseaux à iris	09.02
NOYES pince à polypes nasaux	46.07
NUGENT pince ophtalmique	42.16

O

obturateur à gaze	50.03
OCHSNER pince à ligature	26.07
OCHSNER sonde à calculs biliaires	62.02
OCHSNER trocart thoracique	22.03
O'CONNOR crochet à iris	42.07
OETTINGEN écarteur	18.60
OLDBERG pince à laminectomie	40.18
OLIVECRONA couteau à trigeminus	40.09
OLIVECRONA dissecteur à duremère	40.07
OLIVECRONA pince gouge	32.04
OLIVECRONA scie en fil métallique	40.06
OLLIER écarteur	18.16
OLSEN HEGAR porte aiguille	24.08
OMBREDANNE marteau	32.40
OMBREDANNE pince à préhension	64.03
ophtalmoscope	02.07
ostéotome	32.33 - 32.39
otoscope	02.06
O'SULLIVAN O'CONNOR spéculum vaginal	70.13
OTIS bougie urétrale dilatatrice	66.08
OTIS urétrotome	66.04
ouvre-bouche	48.05 - 48.11
OVERHOLT baby pince hémostatique	12.15
OVERHOLT GEISSENDOERFER passe-fil	12.16
OVERHOLT MIXTER passe-fil	12.21
OVERHOLT passe-fil	12.16
OVERHOLT rugine à périoste	32.48

P

Pacific pince à biopsie	70.27
PALMER chasse-clous à os	34.12
PALMER clou à os	36.07
PALMER introducteur des clous à os	34.12
PAPAVERO CASPAR spéculum	40.23
PARHAM bandelette métallique	32.22
PARHAM serre-bandelette	32.22
PARK biécharostat	42.03
PARKER bistouri	06.10
PARKER écarteur	18.02
PARKER MOTT écarteur	18.02
parties de rechange pour les containers	88.24
PARTSCH ciseau-burin	32.34
PARTSCH gouge	32.34
PARTSCH marteau	32.41
passé-fil	12.16, 12.20, 12.21
passé-fil et dissecteur	12.16
PASSOW pylône hémostatique carré	44.19
PATON dissecteur cornéen	42.06
patron pour plier les plaques à os	33.22
PAUFIQUE couteau pour kératoplastie	42.06
PAUFIQUE pince à ligature	43.05
PAYR baby écreuseur intestinal	64.12
PAYR sonde conductrice	26.04
PEAN Nippon pince hémostatique	12.07
PEAN pince hémostatique	12.11
PEAN pince hémostatique fine	12.08
PEDERSON spéculum vaginal	70.02
PEERS BERTRAM pince à champs	14.03
PELKMANN pince à pansements	16.04
PENFIELD dissecteur à dure-mère	40.08
PENNINGTON pince hémostatique	12.10
PENNYBACKER pince gouge	32.06
perce-crâne	72.08
PERCY retracteur à amputation	33.02
perforateur à ongles	33.05
perforateur à os	33.04 - 33.06,

perforateur avec guide télescopique de broches périostotome	33.10 33.05 32.52, 46.16, 46.17
PERTHES perforateur	33.10
PESTALOZZA curette à faux germes	72.06
PETRI boîte avec couvercle	88.04
PHANEUF pince à péritoine	12.27
PHILLIPS lame de tourne-vis	34.13
PHILLIPS tournevis	33.20
phlébodissecteur	20.05
pick pour la chirurgie de l'oreille	44.17, 44.18
pièces de rechange pour containers à stérilisation	88.24
piéd à coulisse	02.12, 42.11
PIERCE trocart pour le sinus maxillaire	22.02
PIFFARD curette pour lupus	74.02
PINARD stéthoscope	02.09
pince à agrafes	26.07
pince à amygdales	50.05
pince à anastomose	56.15, 56.16
pince à anastomose rectale	64.08
pince à appendectomie	64.04
pince à avancement	43.02, 43.07
pince à biopsie du col de l'utérus	70.28
pince à biopsie gynécologique	70.24 - 70.28
pince à biopsie rectale	68.06, 68.07
pince à biopsie utérine	70.24 - 70.28
pince à calculs biliaires	62.02
pince à calculs rénaux	62.06
pince à cartilages	32.20
pince à chalazion	43.06
pince à champs	14.02 - 14.04
pince à clips pour la suture cérébrale	40.03
pince à cloison et vomer	46.07, 46.08
pince à colédoque	12.21
pince à columella	46.26
pince à corps étrangers	66.04
pince à couper et plier le fil	33.14 - 33.18
pince à courber les plaques osseuses	33.21, 33.22
pince à déchets	28.02
pince à dents	10.02 - 10.11
pince à dissection	10.02 - 10.11
pince à dissection modèle USA	10.02
pince à échardes	10.12 - 10.13
pince à entrelacer les tendons	32.24
pince à entropion	43.07
pince à envies	74.04
pince à épilation	43.10
pince à épiler les ails	43.10
pince à excision	64.09
pince à extraction des broches	33.14
pince à extraire les ongles	33.03
pince à faux germes	72.06
pince à fixation	43.03
pince à griffes modèle USA	10.02
pince à hypophyse	40.09
pince à hystérectomie	12.27 - 12.30
pince à implanter les lentilles	42.18
pince à introduire les sondes	04.04
pince à iris	42.12 - 42.15, 42.17
pince à laryngo-, broncho-œsophagoscopie	52.04
pince à ligature	43.05
pince à ongles	74.03, 74.04
pince à pansements	16.02 - 16.06
pince à pansements antiseptique	88.04
pince à pansements et à tampons	16.02
pince à paramétrium	12.29
pince à passer les tendons	32.23, 32.24
pince à pédicule rénal	12.24, 12.25
pince à péritoine	12.26, 12.27
pince à phalanges	32.20
pince à plâtres	30.04
pince à plier les plaques à os	33.21
pince à polypes nasaux	46.06, 46.07
pince à polypes utérins	16.03, 70.20
pince à poser les agrafes	26.07
pince à poser les clips Bulldog	12.02
pince à poser les clips neuro	40.02
pince à préhension amygdalienne	50.04, 50.05
pince à préhension de la patella	32.21
pince à préhension des instruments	28.02
pince à préhension des intestins et du tissu	12.11, 64.03, 64.04
pince à préhension des lambeaux	66.02
pince à préhension des organes	64.04
pince à préhension des os	32.17, 32.20

pince à préhension des tendons	32.23, 32.25
pince à préhension des tumeurs	40.18
pince à préhension du goitre	54.04
pince à préhension intestinale et des tissus	64.02 - 64.04
pince à redresser la cloison	48.12
pince à réduction	32.20, 32.21
pince à rouleaux	12.32
pince à saisir la glande et le prépuce	66.05
pince à saisir la peau	46.26
pince à saisir la prostate	66.02
pince à saisir le fil métallique	33.14
pince à saisir le tissu pour la biopsie	68.07
pince à saisir les instruments	28.02
pince à saisir les petites plaques	33.21
pince à saisir les seringues	28.02
pince à séquestres	32.21
pince à strabisme	42.16
pince à suture	10.11, 43.05
pince à suture cornéosclérale	43.05
pince à torsader le fil	33.15
pince à trachome	43.07
pince à tumeurs	11.05, 11.06
pince atraumatique	11.03
pince atraumatique capsulaire	66.02
pince atraumatique pour saisir l'intestin	64.03
pince auriculaire	44.11
pince auriculaire à fil métallique	44.12
pince auriculaire coudée	44.09
pince auriculaire coupe-maillet	44.13
pince auriculaire croisée coudée	44.09
pince auriculaire en baïonnette	44.09
pince auriculaire micro	44.12, 44.15
pince auriculaire micro mini	44.16
pince auxiliaire pour la stérilisation des instruments	28.02
pince bronchique	12.18
pince capsulaire	43.04
pince clamp à anastomose atraumatique	12.28, 56.13
pince clamp à bronches	12.18, 56.14
pince clamp stomacale	64.11
pince clamp thoracique	12.17
pince clamp utérin	72.05
pince coupante à amygdales	50.08
pince coupante à cloison nasale	46.12
pince coupante à os	32.13, 32.14
pince coupante à polypes laryngiens	52.02
pince coupante nasale	46.08, 46.10
pince coupante pour le sinus maxillaire	46.12
pince coupe-fil	33.17
pince coupe-fil métallique	33.16, 33.17
pince coupe-fil métallique percée	33.18
pince crânienne	40.07
pince crâniotome	40.07
pince d'horloger	10.11
pince emporte-pièce à laminectomie	40.17 - 40.19
pince emporte-pièce nasale	46.11, 46.12
pince emporte-pièce pour capsulo-iridotomie	42.11
pince emporte-pièce pour la chirurgie du nez	46.11
pince emporte-pièce pour la laminectomie	40.20, 40.22
pince ethmoïdale	46.07
pince fixe-toile	88.13
pince gouge	32.02 - 32.12, 40.18, 40.19
pince gouge à hypophysectomie	40.18
pince gouge à laminectomie	40.19
pince guide-foret et de protection	40.04
pince hémorrhoidale	68.08
pince hémostatique	12.02 - 12.30
pince hémostatique	12.02 - 12.30
pince hémostatique amygdalienne	12.14, 12.15
pince hémostatique et passé-fil	12.19
pince hémostatique et pour le conduit biliaire	12.23
pince hystérolabe	70.21
pince intestinale	64.04 - 64.11
pince intestinale pédiatrique	64.04
pince micro baïonnette pour la neurochirurgie	11.05
pince micro laryngienne	52.04
pince modèle russe	10.06
pince musculaire	43.02, 43.07, 54.04
pince nasale	46.06
pince nasale à tampons	46.06
pince nasale coudée	46.05
pince nasopharyngienne coupante	46.26
pince ophtalmique	42.16
pince ophtalmique à suture	43.05
pince passé-fil	12.20
pince péricrânienne	72.05

Index alphabétique

pince plate 33.16
 pince plate 33.14 - 33.16
 pince porte-fil 66.02
 pince porte-os 32.15 - 32.17
 pince porte-tampons laryngienne 52.02
 pince porte-vis 33.21
 pince pour abaissement du col de l'utérus 70.17 - 70.20
 pince pour agrafes 26.07, 26.08
 pince pour extraire les tiques 10.13
 pince pour la clavicula 32.21
 pince pour la cloison nasale 46.07, 46.10
 pince pour le cuir chevelu 12.10
 pince pour les agrafes pour le cuir chevelu 40.04
 pince pour les bords de la plaie 26.08
 pince pour les calculs biliaires 62.02
 pince pour les calculs rénaux 62.05
 pince pour redresser la cloison 46.25
 pince pour redresser la cloison 46.25
 pince pour saisir les tendons 32.23
 pince pour saisir l'intestin 64.02 - 64.04
 pince pulmonaire 56.13
 pince serre-fil 33.13
 pince serre-tubes 12.30, 12.31
 pince tire-langue 48.04
 pince tire-tendons 32.24
 pince ura-tangentielle 12.25
 pince vasculaire 12.03
 pinces à dissection atraumatiques 11.03, 11.06
 pinces à coagulation bipolaire 92.04 - 92.05
 pinces à coagulation monopolaire 92.03
 pinces à tumeurs et à vaisseaux 11.02
 pinces bipolaires 92.04 - 92.05
 pinces auriculaires micro 44.15, 44.16
 pinces coupantes nasales 46.09
 PIPER forceps avec tracteur 72.04
 plaque 36.16, 36.17
 plaque 1/2 tubulaire 36.14
 plaque 1/3 tubulaire 36.16
 plaque 1/4 tubulaire 36.16
 plaque à mini fragments compression 36.17
 plaque condylienne à compression 36.15
 plaque de pose triangulaire 34.05 - 34.06
 plaque de reconstruction pelvienne 36.14
 plaque de soutien condylien 36.20
 plaque en cuiller 36.22
 plaque en T 36.17, 36.22
 plaque étroite à compression 36.14
 plaque étroite d'élongation 36.20
 plaque fémorale 36.18
 plaque fémorale anatomique 36.21
 plaque humérale épicondylienne 36.22
 plaque L de soutien 36.23
 plaque large de compression 36.14
 plaque large d'élongation 36.20
 plaque multi fragments 36.16
 plaque osseuse large d'élongation 36.20
 plaque osseuse mini 36.17
 plaque petits fragments 36.17
 plaque pour étendre la peau 06.11
 plaque pour le col du fémur à compression dyn. 36.08
 plaque pour le rachis 36.23
 plaque pour le rachis cervical 36.24
 plaque proximale pour l'humérus 36.22
 plaque radiale 36.22
 plaque tibia latérale 36.21 - 36.23
 plaque trapézoïdale pour ostéosynthèse 36.24
 plaques à os mini et à petits fragments 36.16, 36.17
 plaques osseuses 36.08, 36.09, 36.14 - 36.24
 plateau à stérilisation à perforations mini 88.08
 plateau à stérilisation en fil métallique 88.08
 plateau à stérilisation perforé 88.08
 plateau pour instruments 88.04
 PLESTER couteau lobaire 44.17
 PLESTER écarteur mousse 18.28
 PLESTER tube d'aspiration 44.06
 PLEY blépharostat 42.03
 plieuse pour clous centromédullaires 34.10
 poignée à tarouds 33.08
 poignée avec mandrin Jacobs 33.06
 poignées à mandrins 33.08
 POIRIER pince à tissu 12.11
 POLITZER aiguille à paracentèse 44.07
 POLITZER couteau auriculaire 44.08
 POLITZER insufflateur complet 44.06
 POLLOSON écarteur 18.23
 POOLE tube d'aspiration 04.02

POPPEN tube d'aspiration 40.15
 porte aiguille 24.02 - 24.12
 porte aiguille avec ciseaux 24.08, 24.09
 porte aiguille micro 24.10 - 24.12
 porte-aiguille pour les gauchers 24.02 - 24.04
 porte coton 20.06
 porte crâne réglable 40.04
 porte ligature à hypophysectomie 40.26
 porte mini containers portable 88.19
 porte-agrales pour la suture cérébrale 40.03
 porte-aiguille vasculaire 24.05
 porte-instruments 'épingle de sécurité' 28.02
 POTTS DE MARTEL ciseaux vasculaires coudés 08.10
 POTTS SMITH ciseaux vasculaires 08.11
 POTTS SMITH pince à dents 10.02
 POTTS SMITH pince à dissection 10.02
 PRATT (BILLROTH) pince utérine 70.19
 PRATT dilateur utérin 70.16
 PRATT écarteur cystique 68.06
 PRATT pince hémostatique 12.10
 PRATT spéculum rectal 68.02
 préhenseur I.U.D. flexible 70.21
 présentoir de filtres pour containers 88.24
 presse pour courber les attelles 33.22
 presse pour du matériel cartilagineux 46.23
 PRICE THOMAS pince clamp bronchique 56.14
 PRINCE ciseaux à amygdales 08.10
 PRINCE pince musculaire 43.02
 proctoscope 68.04, 68.05
 protecteur de tissu 33.24, 33.26
 protecteur de tissu et guide mèche 33.26
 protecteur des ailes 46.25
 PROVIDENCE HOSPITAL pince hémostatique 12.06
 PUTTI râpe à os 32.59
 PYE SMITH (HARRISON) pince à stérilisation 28.02
 pylône 32.38

Q

QUERVAIN élévateur 32.50
 QUINBY ciseaux à genèves 08.19
 QUIRE levier des corps étrangers 44.10
 QUISLING marteau intranasal 32.44

R

rachiotome 32.38
 RADOLF pince à extraire ongles 33.03
 RADY spatule double 20.05
 RAGNELL DAVIS écarteur 18.05
 RALK perforateur 33.06
 RAMEL aiguille à biopsie 22.04
 RAMPLEY pince à éponges 16.03, 16.04
 RAMSAY pince striée 10.06
 RAMSAY pince striée 1x2 dents 10.06
 RANDALL curette aspirante 70.23
 RANDALL pince à calculs rénaux 62.05
 RANEY pince pour les agrafes à cuir chevelu 40.04
 râpe à os 32.59
 râpe nasale 46.20 - 46.22
 râpe/lima à os 32.59
 rapprocheur des côtes 56.12
 rasoir 06.13
 raspatoire pour la hypophysectomie 40.25
 RAY curette horizontale 40.24
 RAY curette pituitaire 40.28
 RAY curette verticale 40.24
 RECAMIER curette utérine 70.32
 récipient cylindrique 88.04
 reotoscope 68.04
 règles 02.12
 REICHERT dépressur d'épiglotte 52.02
 REILL pince à couper le fil métallique 33.17
 REILL pince à réduction 32.20
 REINER couteau à plâtre 30.04
 REINER seringue auriculaire 44.06
 RESANO pince à anastomose rectale 64.08
 rétracteur à amputation 33.02
 REVERDIN (ALBARRAN) aiguille 26.03
 REVERDIN écarteur abdominal 18.06
 REYNOLDS (JAMESON) ciseaux 08.07
 RHEINSTAEDTER curette utérine à irrigation 70.24
 RIBBON écarteur 18.05
 RICARD écarteur abdominal 18.59
 RICHARDSON EASTMAN écarteur 18.04

RICHARDSON écarteur 18.04
 RICHARDSON grip écarteur 18.04
 RICHTER HEATH pince à agrafes 26.08
 RIECKER KLEINSASSER support de poitrine 52.06
 RIGBY écarteur, rectum, vagina 18.56
 RING abaisse langue 48.11
 RITCHEY impacteur de clous 34.11
 RITTER HALLE dilateur du sinus frontal 46.29
 ROBB dissecteur 56.18
 ROBERTS pince hémostatique 12.18
 ROBIN MASSE écarteur abdominal 18.60
 ROBIN pince à champs 14.04
 ROCHARD écarteur 18.61
 ROCHESTER CARMALT pince hémostatique 12.09
 ROCHESTER OCHSNER pince hémostatique 12.08
 ROCHESTER PEAN pince hémostatique 12.08
 ROEDER pince à champs 14.03
 ROEDER serrenœud 50.03
 ROETTGEN RUSKIN pince gouge 32.08
 ROGER élévateur à cloison 46.16
 ROGERS pince à paramétrium 12.29
 ROGGE pince auxiliaire à stérilisation 28.02
 ROLLET ciseau à extirpation 42.06
 ROLLET écarteur 42.07
 rondelles pour vis osseuses 36.11, 36.13
 ROSE écarteur trachéal 54.03
 ROSEN aiguille 44.18
 ROSEN couteau circulaire 44.17
 ROSENBERG embout de pince 52.03
 ROSER KOENIG ouvre-bouche 48.05
 ROSS écarteur à aorte 56.13
 ROUX écarteur 18.02, 18.03
 ROUX MAGNUS écarteur 18.03
 ROWE pince à redresser la cloison 48.12
 ROY CAMILLE plaque cervicale 36.23
 ROY CAMILLE plaque pour le rachis 36.23
 ruban métrique 02.12
 RUBIN pince à cloison nasale 46.10
 RUDD ligateur hémorrhoidal 68.09
 rugine 32.45 - 32.47, 32.48, 32.50, 32.51, 40.27, 42.06, 46.17
 rugine „Little Joker“ 32.46
 rugine raspatoire 32.46, 32.47
 RUMEL pince thoracique 12.17
 RUSKIN LISTON pince coupante à os 32.14
 RUSKIN pince gouge 32.08
 RUSSEL DAVIS abaisse langue 48.09
 RYDEL SEIFFER diaposon 44.05
 RYDER porte aiguilles 24.04, 24.05
 RYDER vascular porte-aiguilles 24.05

S

SAALFELD tire comédons 74.02
 SACHS dissecteur à duremère 40.07
 SACHS séparateur pour la duremère 40.08
 SAENGER pince à faux germes 72.06
 SALENIUS méniscotome 32.58
 salpingographe 70.30
 SANVENERO ciseaux 08.06
 SAROT clamp bronchique 56.14
 SAROT pince clamp bronchique 12.18
 SAROT porte aiguille 24.07
 SATINSKI clamp vena cava 56.15
 SATINSKY ciseaux thoraciques 08.16
 SATINSKY pince à anastomose 56.15
 SATO couteau cornéen 42.05
 SATTERLEE scie à amputation 33.03
 SAUER blépharostat 42.02
 SAUERBRUCH boîte à aiguilles perforée 88.02
 SAUERBRUCH costotome 56.03
 SAUERBRUCH écarteur 18.21
 SAUERBRUCH FREY costotome 56.03
 SAUERBRUCH pince à déchets 28.02
 SAUERBRUCH pince gouge 32.09
 SAWTELL pince amygdalienne 12.14
 SCAGLIETTI pince gouge 32.10
 scarificateur 42.04
 SCHAEDEL (SHRADLE) pince à champs 14.02
 SCHAMBERG tire-comédons 74.02
 SCHEDE curette à os tranchante 32.26
 SCHEIBE pince à préhension d'organes 64.04
 SCHEIE canule ophtalmique 43.08
 SCHEIE couteau à goniotomie 42.06

Index alphabétique

SCHNEIDMANN embout de pince	52.03	SILVER ciseau-burin à plastique nasale	46.19	ST.MARKS (LLOYD DAVIES) écarteur pelvien	18.19
SCHEPENS spatule orbitale	42.08	SILVER dermatome manuel	06.12	St.MARTIN pince à suture	43.05
SCHERBACK spéculum vaginal	70.12	SIMCOE canule à suture	43.08	STACKE sonde auriculaire	20.02
SCHIMMELBUSCH tambour à stérilisation	88.05	SIMON cuiller utérine tachante	70.31	STAUDE MOORE pince utérine	70.18
SCHINK dermatome	06.11	SIMON curette tranchante à os	32.27	StCLAIR THOMSON curette à végétations adénoïdes	46.28
SCHIOETZ tonomètre	43.09	SIMON écarteur abdominal	18.19	STEINBACH marteau	32.43
SCHMEDEN conchotome	46.10	SIMON écarteur fistulaire	70.29	STEINMANN clou à os	33.11
SCHMID canule vasculaire	22.04	SIMPSON BRAUN forceps	72.02	STELLBRINK pince gouge	32.05
SCHMID spatule pour la tunique interne	56.18	SIMPSON forceps	72.02	STERNBERG écarteur des lèvres	48.03
SCHMIEDEN PAYR sonde conductrice	26.03	SIMPSON LUIKART forceps	72.03	sternum, cisaille à	56.03
SCHMIEDEN TAYLOR ciseaux à duremère	08.15	SIMS ciseaux utérins	08.12	stéthoscope	02.09
SCHNEIDER rugine raspatoire	32.46	SIMS curette utérine	70.32	STEVENS ciseaux à ténatomie	08.08
SCHNEIDER SAUERBRUCH rugine raspatoire	32.46	SIMS dépresseur utérin	70.21	STEVENS crochet pour la lentille cristalline	42.07
SCHNIDT (BOETTCHER) pince amygdalienne	12.14	SIMS dilateur utérin	70.17	STEVENS pince à iris	42.13
SCHOENBORN écarteur à thyroïde	54.04	SIMS hystéromètre	70.22	STEVENS porte-aiguille	24.09
SCHOENBURG pince pour tissu	64.04	SIMS MAIER pince à pansements	16.02	STEVENSON blépharostat	42.03
SCHROEDER pince pour abaissement du col	70.19	SIMS spéculum rectal	68.02	STIEGLITZ (WILLIAMS) pince à échardes	10.13
SCHROEDER pince utérine	70.18, 70.19	SIMS spéculum vaginal	70.10	STIEGLITZ pince à échardes	10.13
SCHUBERT pince à biopsie	70.24, 70.25	SINGLEY TUTTLE pince	10.09	STILLE ciseau-burin	32.35
SCHUKNECHT couteau circulaire	44.17	sinus pince à pansement	16.04	STILLE ciseaux à plâtres	30.02
SCHUKNECHT couteau falciforme	44.17	SKENE pince utérine	70.18	STILLE costotome	56.02
SCHUKNECHT écarteur pointu	18.29	SLUDER BALLENGER amygdalotome	50.07	STILLE gouge	32.35
SCHUKNECHT tube d'aspiration	44.06	SMELLIE crochet obstétrique	72.05	STILLE HORSLEY pince coupante pour os	32.14
SCHULZE BERGMANN spéculum rectal	68.02	SMELLIE perce-arête	72.08	STILLE LISTON pince coupante pour os	32.14
SCHUMACHER cisaille sternale	56.03	SMILLIE écarteur à genou	32.57	STILLE LUER pince gouge	32.08
SCHUMACHER ciseaux à cordon ombilical	08.14	SMILLIE méniscotome	32.58	STILLE ostéotome	32.35
SCHUMACHER embout de pince	52.03	SMITH blépharostat	42.02	STILLE perforateur à main	33.04
SCHUMACHER pince à biopsie	70.25	SMITH BUJE écarteur rectal	68.03	STILLE pince à dissection	10.02
SCHÜTZ ligateur hémorrhoidal	68.09	SMITH PETERSEN ciseau-burin	32.35	STILLE pince à pédicule rénal	12.24
SCHWEIGGER pince capsulaire	43.04	SMITH PETERSEN clou pour le col du fémur	36.07	STILLE RUSKIN pince gouge	32.09
scie à amputation	33.02, 33.03	SMITH PETERSEN gouge	32.35	STILLE SHERMAN perforateur	33.04
scie à appareils plâtrés	30.02	SMITH PETERSEN pince gouge	32.11	STOCKMANN compresseur urétral	66.05
scie à bogues	33.03	SMITH US Army ciseaux à gaze	08.20	STONE pince à dissection	10.10
scie à doigts	33.03	SMITHWICK écarteur des nerfs	40.06	STONE WATT pince intestinale	64.10
scie à plâtre électrique	30.03	SMITHWICK pince à poser clips de suture cérébrale	40.02	STRANDELL STILLE écarteur	18.10
scie circulaire, lames seules et doubles	33.09	SNELLEN anse	42.09	STRATTE porte-aiguille	24.07
scie fil métallique	40.06	SNELLEN pince à entropion	43.07	STRAUSS compresseur urétral	66.05
scie nasale	46.23	SNITMAN écarteur	18.27	STRAUSS rectoscope	68.04
scierotome	42.06	SOMER pince hystérolabe	70.21	STRUCK écarteur thoracique	56.10
SCOVILLE curette pour disque rompu	32.29	sonde à calculs biliaires	62.03	STRUEMPEL pince auriculaire	44.11
SCOVILLE écarteur	18.32, 18.63, 40.06	sonde à calculs rénaux	62.04	STRULLY ciseaux neurochirurgicaux	08.15
		sonde à irrigation	46.13	STRULLY ciseaux vasculaires	08.15
		sonde à mesurer pour la microchirurgie de l'oeil	44.19	STRUYCKEN pince nasale coupante	46.10
seau à déchets roulant	88.04	sonde auriculaire	20.02, 44.07	stylet lacrymal	42.12
SEBILAU élévateur	32.50	sonde boutonée pour hypophysectomie	40.27	stylets et sondes	20.02
scéculum pour l'hypophysectomie transsphenoidale	40.23	sonde conductrice à ligature	26.02, 26.04	stylets, sondes, directeurs	20.02
SEDILLOT rugine	32.45	sonde conductrice à sutures	26.03, 26.04	Suisse spéculum vaginal	70.05
SEGOND éviseur de fibromes	70.29	sonde de dilatation prostatique	66.07	support contre-poitrine pour laryngoscope opératoire	52.06
SEIDEL spéculum vaginal	70.11	sonde dilatrice urétrale	66.07	support contre-poitrine pour ouvre-bouche	48.11
SEIFFERT embout de pince	52.03	sonde fistulaire	68.06	supports pour la stérilisation des porte-broches	88.22
SELLHEIM levier pour l'abaissement de la tête	72.07	sonde trabéculaire	42.12	SWEET pince à poser les clips en neurochirurgie	40.02
SELLORS rapprocheur des côtes	56.12	sonde urétrale pour femmes en métal	66.07	SYME aiguille à aneurysme	26.02
SEMB clamp bronchique	56.14	sondes et stylets	20.04	SYPERT pince gouge	32.12
SEMB davier porte-os	32.15	sondes et stylets	20.02	SYSTRUNK ciseaux à fendre ongles	08.22
SEMB pince coupante à os	32.14	SÖNNENSCHNEIN spéculum nasal	46.03		
SEMB rugine costale	32.48	spatule à cyclodialyse	42.09, 42.10		
SEMKEN pince à griffes	10.07	spatule à énucléation	42.09		
SEMKEN pince striée	10.07	spatule à goitre	54.04		
SEMM spéculum vaginal	70.06	spatule à iris	42.09		
SENN écarteur	18.05	spatule à iris	42.09		
SENN GREEN écarteur	18.10	spatule abdominale	18.54		
SENN MILLER bébé écarteur	18.05	spatule bifurquée	40.25		
SENNING (Suède) porte-aiguille	24.04	spatule cérébrale	40.15		
sensimètre	02.11	spatule orbitale	42.08		
séparateur pour la duremère	40.09	spatule pour la tunique interne	56.18		
seringue à amygdales	50.08	spatule pulmonaire	56.12		
seringue auriculaire	44.06	spatule vésicale	66.03		
seringue d'aspiration pour la ponction du foie	22.05	spéculum anal	68.05		
seringue Record	18.64	spéculum auriculaire	44.02, 44.03		
serre-fine	12.03	spéculum endocervical	70.13		
serre-liens osseux	32.22	spéculum nasopharyngien	46.05		
serre-nœud à amygdales	50.03, 50.06, 50.07	spéculum pour la doïson nasale	46.04		
		spéculum pour opération vertébrale lombaire	18.42		
serre-nœud à polypes auriculaires	44.09	spéculum vaginal „view more“	70.06		
serre-nœud pour les polypes rectaux	68.06	spéculum vaginal modèle suisse	70.05		
set de diagnostic	02.08	spéculum vaginal pour la chirurgie au laser	70.02 - 70.04, 70.06		
set de dissection	32.39		70.02 - 70.04, 70.06		
set de trépan cutanés	74.03	spéculum vaginal pour la chirurgie haute fréquence	70.02 - 70.04, 70.06		
SEUTIN ciseaux à plâtre	30.02		70.06		
SEWALL élévateur	46.16	spéculums nasaux	46.02 - 46.04		
SEXTON couteau auriculaire	44.08	spéculums vaginaux	70.02 - 70.12		
SEXTON GERZOG couteau auriculaire	44.08	SPENCER ciseaux à ligatures	08.17		
SEYFFERT spéculum vaginal	70.05	SPENCER WELLS (CHANCE) pince hémostatique	12.09		
SHEA ciseaux micro	44.11	SPENCER WELLS (JONES) pince hémostatique	12.09		
SHEPARD II pince à implanter les lentilles	42.18	sphygmomanomètre	02.02 - 02.04		
SIEBOLD ciseaux gynécologiques	08.13	SPRATT curette tranchante osseuse	32.26		
SIEGLE spéculum auriculaire pneumatique	44.03	SPURLING pince à laminectomie	40.17		
sigmoïdoscope	68.04	ST. MARKS écarteur périnéal	18.56		

Index alphabétique

TABB couteau forme serpette	44.17
tambour à stérilisation	88.05
tambour de coupe pour moulin à os	32.60
tapis porte-instruments en silicone	88.10
taraud	33.08, 33.22
taraud „T“ mm avec manche	33.08
TARNIER cranioclaste	72.08
TARNIER forceps avec tracteur	72.04
TAYLOR écarteur	18.63, 32.57
TAYLOR marteau	02.10
TAYLOR pince à dissection et à griffes	10.07
TEALE pince utérine	70.19
tendeur de plaques	34.03
tendeur du fil métallique	33.13
tendeur serre-fil	33.13, 34.13
tensiomètre	02.02 - 02.04
TERRIER pince vasculaire	12.03
THIERRY forceps obstétrique	72.04
THOMAS curette utérine	70.34
THOMS ALLIS à préhension	64.03
THOMS GAYLOR pince à biopsie	70.25
THOMSON WALKER écarteur vésical	66.03
THOREK ciseaux à poumons	08.16
THUDICHUM (GOLDSMITH) spéculum nasal	46.02
TIECK HALLE spéculum nasal	46.04
tige guide DHS	34.07
TILLEY pince auriculaire	44.10
tire-coriédon	74.02
tire-veine	20.03, 20.05

TISCHLER baby pince à biopsie	70.26
TISCHLER KEVORKIAN embout pour pince à biopsie	70.27
TISCHLER KEVORKIAN pince à biopsie	70.28
TISCHLER MORGAN Eppendorfer pince à biopsie	70.28
TISCHLER MORGAN pince à biopsie	70.26
TIVNEN pince à préhension des amygdales	50.05
TOBOLD abaiselangue	48.03
TOBOLD porte-coton laryngien	20.06
TOENNIS ADSON ciseaux neurochirurgicaux	08.15
TOENNIS dissecteur à duremère	40.07
TOENNIS pince hémostatique	12.18
TOENNIS porte-aiguille	24.07
TOHOKU pince à champs tonomètre	43.09
TOTTI fraise	33.09
tournevis	18.41, 33.20, 33.22
tournevis	02.05
tousse à manucure pour infirmières	74.03
TOWNLEY pied à coulisse	02.12
TOWNSEND KEVORKIAN pince à biopsie	70.27
TOWNSEND mini pince à biopsie	70.27
TOWNSEND TISCHLER baby pince à biopsie	70.27
TOWNSEND TISCHLER MORGAN pince à biopsie	70.27
TOYNEBEE spéculum auriculaire	44.02
tracteur crânien	40.04
tracteur pour fibromes	70.29
tracteur pour forceps obstétrique	72.03, 72.04
TRAUBE marteau-percuteur	02.10
TRELAT spéculum vaginal	70.06
trépan cornéen	43.08, 43.09
trépan cutané	74.03
TRETHOWAN levier à os à anneau	32.56
TREVES pince à griffes	10.03
trocart à trachéotomie	54.02
trocart abdominal	22.02
trocart abdominal universel	22.02
trocart et canule pour la ponction du cul de sac	22.02
trocart pour la vessie	22.02
trocart pour le sinus maxillaire	22.02, 22.03
trocart pour l'introduction des aiguilles à ponction	22.03
trocart thoracique	22.03
TROELTSCH (WILDE) pince auriculaire	44.09
TROELTSCH pince nasale coudée	46.05
TROEMNER marteau-percuteur	02.10
TROTTER pince gouge	32.07
trousse à varices	20.03
TROUSSEAU dilateur trachéal	54.02
TROUTMAN CHRIS casse-lames	06.07
TROUTMAN colibri pince à iris	42.15
TROUTMAN pince pour le rectus	43.02
tube à intubation	54.03
tube d'aspiration	04.02, 04.03, 40.15, 40.16, 44.06, 52.06, 68.06
tube de lavage utérin	72.04
Tübingen canule à air	43.08
Tübingen écarteur	18.30
Tübingen écarteur vaginal et abdominal	70.11
Tübingen pince à iris	42.17
Tübingen pince à ligatures	43.05
TUFFIER écarteur	18.22, 56.07
TUFFIER pince hémostatique	12.11
TURNBULL pince à ongles	74.04
TURREL pince à biopsie utérine	68.07
TYDING pince à préhension amygdalienne	50.05
TYDING serre-nœud à amygdales	50.07
TYRELL crochet à iris	42.07

U	
UCKERMANN porte-coton	20.06
UCKERMANN trocart	54.02
UFFENORDE curette à os	32.27
ULRICH davier porte-os	32.17
ULRICH pince à tampons	16.02
UNNA tire-comédons urétérotome	74.02
US Army écarteur	66.04
USA modèle pince à dissection	18.03
	10.02

V	
VALIN écarteur	18.61

VALLEIX hystéromètre	70.22
van BUREN bougie urétrale dilatatrice	66.06
van BUREN pince à séquestres	32.21
van DOREN pince à biopsie	70.25
VANNAS ciseaux à iridectomie	09.03
VANT pince à polypes utérins	16.03
VARADY mini trousse à varices	20.04
VARADY phlébodissecteur	20.05
VARADY phléboextracteur	20.05
vase à médicaments	88.03
VERBRUGGE davier porte-os	32.18
VERBRUGGE HOHMANN levier à os	32.53
VERESS aiguille à pneumopéritoine	22.03
VERNIER pied à coulisse	02.12
VIDAL curette grattair	74.02
Vienne modèle spéculum vaginal	70.11
Vienne spéculum nasal	46.03
VIRCHOW burin pour crâne	32.38
VIRCHOW couteau à cartilages	06.13
VIRCHOW couteau à cerveau	06.13
VIRTUS (RALK) pince à échardes	10.13
vis de connexion pour vis DHS	34.08
vis perforée 4,5 mm	36.11
vis de connexion longue DHS	34.08
vis de connexion pour vis DHS	34.08
vis dynamique pour le fémur	36.09
vis pour l'ostéosynthèse	36.10 - 36.13
vis spongieuse	36.11 - 36.13
viseur	33.26, 34.06, 34.07
VOLKMANN curette tranchante	32.26, 32.28, 32.31, 32.32
VOLKMANN écarteur	18.10 - 18.12
VOLTOLINI (DUPLAY) spéculum nasal	46.02
vPETZ appareil à suturer l'estomac	64.13

W	
WACHENFELDT pince pour agrafes	26.07
WADSWORTH TODD cautère	42.09
WAGENER crochet boutoné	44.09
WAGENER MOSHER tube à intubation	54.03
WAGNER ciseaux	08.18
WAGNER marteau	32.42
WAGNER pince à laminectomie	40.18
WALB couteau à organes	06.13
WALLICH auiller à faux germes	72.07
WALSHAM pince à redresser la cloison	46.25
WALTER aiguille à corps étrangers	42.06
WALTHER bougie urétrale dilatatrice	66.08
WALTHER sonde urétrale dilatatrice	66.07
WALTON écarteur à hémilaminectomie	18.35
WALTON gouge à corps étrangers	42.06
WALTON tire-comédons	74.02
WALTON YANKAUER tube d'aspiration à robinet	04.02
WANÉ écarteur	18.31
WANGENSTEEN pince	10.09
WANGENSTEEN porte-aiguille	24.05
WARTENBERG sensimètre	02.11
WASSMUND écarteur	18.23
WATSON CHEYNE élévateur	32.50
WATSON CHEYNE rugine	20.02
WATSON dermatome	06.12
WATSON JONES levier à os	32.56
WATSON WILLIAMS pince ethmoïdale	46.07
WAUGH pince à dissection	10.09
WEBER aësthésiomètre	02.11
WEBER anse	42.09
WEBSTER porte aiguille	24.02
WECKER ciseaux à iris	09.02
WECKER spatule iris	42.09
WEEK blépharostat	42.02
WEIL BLAKESLEY pince coupante nasale	46.09
WEINBERG écarteur à vagotomie	18.07
WEISS blépharostat	42.03
WEISS pince serre-tubes	12.30
WEITLANER écarteur	18.28 - 18.30
WEITLANER WULLSTEIN écarteur	18.28
WELLS spatule à enucléation	42.09
WERTHEIM ciseaux dissecteurs	08.13
WERTHEIM clamp à anastomose atraumatique	12.28
WERTHEIM CULLEN pince à hystérectomie	12.28
WEST ciseau-burin nasal	46.20
WEST gouge nasale	46.20
WESTCOTT ciseaux à tendons	09.02
WESTMACOTT pince nasale à tampons	46.06

WESTON serre-nœud à polypes rectaux	68.06
WHEELER couteau à discision	42.05
WHEELER spatule à cyclodialyse	42.10
WHITE pince à préhension amygdalienne	50.04
WHITEHEAD ouvre-bouche	48.06
WIEDER abaiselangue	48.02
WIENER (AUFRIEHT) râpe nasale	46.21
WIENER crochet à iris	42.07
WIENER râpe pour le sinus	46.20
WIGMORE scie à plâtres	30.02
WIKSTROEM dissecteur	12.20
WILBERG agrafe à os	36.26
WILDE serre-nœud auriculaire	44.09
WILDE TROELTSCH pince auriculaire	44.09
WILDER anse	42.09
WILDER dilateur lacrymal	42.11
WILLET MARTEL pince pour le cuir chevelu	12.10
WILLIAMS blépharostat	42.03
WILLIAMS écarteur	18.62
WILLIAMS pince à échardes	10.13
WILLIAMS pince à préhension de tissu	64.04
WILLIAMS tournevis/porte-vis	33.20
WILLIGER curette tranchante	32.32
WILLIGER élévateur	32.49
WILLIGER marteau	32.41
WILLIGER rugine	32.47
WILMS pince gouge	32.07
WINTER pince à faux germes	72.06
WITTNER pince à biopsie	70.26
WOLFF pince à plâtre	30.04
WRIGLEY forceps	72.02
WULLSTEIN ciseaux micro pour l'otologie	44.14
WULLSTEIN couteau forme de serpente	44.17
WÜRZBURG abaisse langue	48.10
WYLIE dilateur urétrin	70.17

Y	
YANKAUER spéculum nasopharyngien	46.05
YANKAUER tube d'aspiration	04.02
YASARGIL couteau pour l'arachnoïde	40.29
YASARGIL curette tranchante	40.28
YASARGIL décolleur	40.27
YASARGIL écarteur galéa	40.04
YASARGIL pince à tumeurs	11.05
YASARGIL pince gouge pour hypophysectomie	40.18
YASARGIL pince micro	11.05
YASARGIL pince micro baïonnette	11.05
YASARGIL porte-aiguille micro	24.12
YASARGIL raspatoire	40.27
YASARGIL rugine	40.27
YASARGIL SAMIL pince à tumeurs	11.05
YASARGIL tube d'aspiration	40.15
YOUNG boomerang porte-aiguille	26.03
YOUNG écarteur prostatique	66.02
YOUNG pince à préhension de la prostate	66.02
YOUNG pince tirelangue	48.04

Z	
ZAUFAL JANSEN pince gouge	32.07
ZENKER écarteur	18.21
ZENKER passe-fils	12.19
ZIEGLER blépharostat	42.03
ZIEGLER couteau à capsulotomie	42.05
ZIEGLER couteau à iridectomie	42.05
ZIEGLER dilateur lacrymal	42.12
ZIEGLER miroir frontal complet	02.05
ZIELKE gouge à scoliose	32.37
ZOELLNER tube d'aspiration	44.06
ZWEIFEL porte-aiguille	24.07

Index alphabétique

A

abajalengua	48.02, 48.03, 48.07, 48.09, 48.10 - 48.12
ABRAHAM cuchillo para amígdalas	50.04
ABRAMS aguja de biopsia	22.04
abreboca	48.05 - 48.10
accesorios para containers de esterilización	88.13, 88.19 - 88.21
adenótomo	46.28
ADLERKREUTZ pinza	10.05
ADSON (FRASIER) pinza hemostática	12.13
ADSON baby (CONE) separador	18.34
ADSON baby pinza hemostática	12.13
ADSON BROWN pinza	10.04
ADSON elevador	32.49
ADSON micro pinza	10.03, 10.04
ADSON pinza pituitaria	40.09
ADSON pinza protectora	40.04
ADSON pinzas de disección	10.04
ADSON porta aguja	24.06
ADSON separador	18.31 - 18.33, 40.06
ADSON separador para duramadre	40.06
ADSON separador para hemilaminectomía	18.32, 18.33
ADSON tubo de aspiración	40.15
ADSONPN pinza gubia	32.04
AEBLL tijera corneal	08.08
agrafe para huesos	36.26
agrafes	26.08
aguja de aneurisma	26.02
aguja de autopsia	26.07
aguja de biopsia	22.04
aguja de catarata	42.06
aguja de disección	42.06
aguja de introducción de catéteres	04.04
aguja de inyección para amígdalas	50.08
aguja de irrigación con heparina	22.04
aguja de ligaduras	26.03
aguja de paracentesis	44.07
aguja de punción lumbar	22.03
aguja de sutura	26.05, 26.06
aguja de sutura intestinal	26.06
aguja para amígdalas	50.03
aguja para cuerpos extraños	42.06
aguja para el paladar	50.03
aguja para la cirugía del oído	44.17, 44.18
aguja para la punción del hígado	22.05
aguja para la sutura de amígdalas	50.03
aguja para ligadura	26.02 - 26.04, 50.03
aguja para neumoperitoneo	22.03
aguja para seno maxilar	46.13
aguja para venas	22.04
aguja ventricular	40.16
aguja y cíncel invertibles	42.10
aguja y gubia invertibles	42.10
agujas para anestesia pudendal	22.03
alambre para huesos	33.13
alambre para huesos con asa	33.13
ALAN PARKS espéculo rectal	68.03
ALBEE fresa	33.09
ALDERDYCE disector doble	32.56
ALEXANDER cíncel	32.34
ALEXANDER gubia	32.34
ALEXANDER periostótomo	32.47
ALEXANDER pinza para biopsia	70.25
alicates para alambre	33.14 - 33.18
ALLEN pinza intestinal pediátrica	64.04
ALLIS ADAIR pinza para coger intestinos y tejidos	64.02
ALLIS baby pinza para coger intestinos y tejidos	64.02
ALLISON espátula pulmonar	56.12
ALLPORT separador	18.27
ALM separador	18.26
ALVIS cureta para cuerpos extraños	42.06
amigdalótomo hemostático	50.08
amniótomo	70.21
ANDERSON ADSON separador	18.30
ANDREW abajalengua	48.02
ANDREWS PINCHON tubo de aspiración	04.02
anillo para el bulbo	42.18
anillos de ligadura hemorroidal	68.10
ANKENEY separador esternal	56.09
anoscopio	68.05
aparato de compresión	33.02
aproximador de costillas	56.12

aproximador del esternón	56.12
ARCHER pinza para espigas	10.13
Arkansas piedra de afilar	06.13
ARRUGA blefarostato	42.02
ARRUGA gancho de extracción	42.07
ARRUGA pinza capsular	43.04
ARRUGA pinza para iris	42.15
ARRUGA porta aguja	24.09, 24.10
ARRUGA protector	42.09
asa auricular	44.08
asa estriada de oftalmología	42.09
asas para cierranudos	44.09, 46.13, 50.07
ASCH pinza para enderezar tabique nasal	46.25
AUFRANC cobra elevador para huesos	32.54
AUFRICHT lima nasal	46.20, 46.21
AUFRICHT separador nasal	46.25
AUVARD espéculo vaginal	70.10
avellanador	33.24
AXENFELD cucharilla para chalazión	42.08
AYER pinza para chalazión	43.06
AYRE cuchillo para calización	70.29

B

BABCOCK pinza para coger intestinos y tejidos	64.03
BABINSKY martillo de percusión	02.10
BACKHAUS KOCHER pinza para campos	14.02
BACON pinza gubia	32.05
BADGLEY separador para laminectomía	56.06
BAGGISH pinza de biopsia	70.28
BAILEY aproximador de costillas	56.12
BAILEY GIBBON aproximador de costillas	56.12
BAINBRIDGE pinza hemostática	12.22
BAKES sonda para cálculos biliares	62.03
BALFOUR separador abdominal	18.45 - 18.47
BALLENGER cuchillo para vegetaciones	46.15
BALLENGER elevador para tabique nasal	46.17
BALLENGER pinza para coger amígdalas	50.05
bandeja de esterilización con mini perforaciones	88.08
bandeja de esterilizar de alambre	88.08
bandeja de esterilizar perforada	88.08
bandeja para instrumentos	88.04
BANE pinza gubia	32.04
BANGERTER espátula de cicloidalisis	42.09
BANGERTER pinza muscular	43.07
BARANY ensordecedor	44.05
BARBARA gancho para oídos	44.17
BARBARA pick para oídos	44.17, 44.18
BARKAN cuchillo para goniotomía	42.06
BARNHILL cuchillo para vegetaciones adenoides	46.27
BARON (SCHUKNECHT) tubo de aspiración	44.06
BARR espéculo rectal	68.03
barra de tracción para fórceps obstétrico	32.22
BARRAQUER blefarostato	42.02
BARRAQUER colibri blefarostato	42.02
BARRAQUER colibri pinza para iris	42.15
BARRAQUER colibri tijeras para iris	09.02
BARRAQUER cuchillo para queratoplastia	42.06
BARRAQUER KATZIN pinza para iris	42.15
BARRAQUER pinza de fijación	43.03
BARRAQUER pinza depilatoria	43.10
BARRAQUER pinza para la cámara anterior	43.02
BARRAQUER porta aguja	24.10
BARRON ligador hemorroidal	68.09
BARRON mango de bisturíes	06.02
BARTELHEIMER aguja de biopsia	22.04
BARTH cureta auricular	32.32
BARTON fórceps obstétrico	72.03
BARTON tractor para fórceps obstétrico	72.03
BAUMGARTNER porta aguja	24.03
BEACHAM amniótomo	70.21
BECKER quistótomo	42.07
BECKMANN cuchillo para vegetaciones adenoides	46.27
BECKMANN EATON separador	18.33
BECKMANN espéculo	46.03
BECKMANN FISCH separador	18.29
BECKMANN separador	18.33
BEEBEE tijera	08.19
BEER pinza depilatoria	43.10
BEESON separador para yesos	30.04
BELLUCCI tijera	44.11
BENGOLEA pinza hemostática	12.12
BENNETT elevador para huesos	32.52
BENSAUDE anoscopio	68.05

BENSON separador pilórico	64.04
BERENS pinza de avanzamiento	43.07
BERENS pinza muscular	43.07
BERENS querátomo	42.04
BERGER pinza para biopsia	70.28
BERGMANN martillo	32.41
BERGMANN separador	18.26
BERGMANN sierra para yesos	30.02
BERGMANN tijera para vendajes	08.20
BERKE pinza muscular	43.02
BERLINER martillo de percusión	02.11
BERNHARD (STAUDE) pinza para campos	14.04
BERTILLON cefalómetro	02.11
BEST pinza intestinal	64.09
BETHUNE costótomo	56.02
BEUSE tijera dentada	08.09
BEYER pinza gubia	32.05, 32.07
BEYER pinza sacabocado	46.12
BIER aguja de punción lumbar	22.04
BILL tractor para fórceps con mango estándar	72.04
BILLEAU asa auricular	44.08
BINKHORST pinza para implantar lentes	42.18
bipod para abre-boca	48.11
BIRCHER GANSKE pinza para huesos	32.19
BIRCHER meniscótomo	32.58
BIRKETT pinza hemostática para amígdalas	12.14
BISHOP HARMAN pinza para iris	42.17
bisturí desechable estéril	06.06
bisturí fino mango metal	06.10
bisturí mango metal	06.09
bisturí nasal	46.14
bisturí para amígdalas	50.04
bisturí para duramadre	46.14
bisturí para fibroma	70.29
bisturí para plastia nasal	46.13, 46.14
bisturí vascular	40.29
BLAKE cureta uterina	70.31
BLASCOVIC pinza para avanzamiento	43.02
blefarostato	42.02, 42.03
blefarostato pediátrico	42.03
BLOHMKE pinza para coger amígdalas	50.05
BLOUNT elevador para huesos	32.56
BLOUNT extractor de grapa ósea	34.12
BLOUNT introductor de grapa ósea	34.12
BLUMENTHAL pinza gubia	32.03
BODENHAMMER espéculo rectal	68.02
BOEHLER estribo de extensión	33.12
BOEHLER pinza cortante para huesos	32.14
BOEHLER pinza gubia	32.08
BOERMA fórceps obstétrico	72.04
BOETTCHEER tijera para amígdalas	08.10
BONACOLTO pinza para estrabismo	42.16
Bonn cánula de irrigación	43.08
Bonn gancho para iris	42.07
Bonn pinza para iris	42.17
BONNEY pinza de disección	10.05, 10.06
boomerang porta aguja	26.03
BORCHARDT fresa	33.09
BOSE gancho traqueal	54.03
BOSE separador traqueal	54.02
BOUCHERON espéculo auricular	44.02
BOWLES estetoscopio	02.09
BOWMAN aguja de disección	42.06
BOWMAN blefarostato	42.02
BOWMAN cuchillo de disección	42.05
BOWMAN sonda lagrimal	42.12
BOYNTON porta aguja	24.09
BOYS ALLIS pinza para coger intestinos y tejidos	64.02
BOZEMANN (WERTHEIM) porta aguja	24.06
BOZEMANN DOUGLAS pinza para pólipos	16.06
BOZEMANN FRITSCH tubo de irrigación uterina	70.35
BOZEMANN pinza para pólipos	16.05
BRAITHWAITE dermatótom	06.12
BRAND pinza para pasar tendones	32.23
BRAUN cranioclasto	72.07
BRAUN depresor uterino	70.21
BRAUN espéculo vaginal	70.11
BRAUN gancho de decapitación	72.08
BRAUN pinza uterina	70.18
BRAUN STADLER tijera para episiotomía	08.14
BREISKY espéculo vaginal	70.13
BRIDGE pinza hemostática/disección/pasahilos	12.20
BRISTOW periostótomo	32.46
broca elástica para canal medular	34.09
broca espiral	33.05
broca flexible para canal medular	34.09
BROCK porta aguja	24.12

Índice alfabético



BRODIE estilete	20.02	CASTROVIEJO pinza de fijación	43.03	COLLIN costótomo	56.02
BRODIE sonda acanalada	20.04	CASTROVIEJO porta aguja	24.11, 24.12	COLLIN cureta uterina	70.35
BROPHY pinza de disección	10.08	CASTROVIEJO querátomo	42.04	COLLIN dinamómetro	02.05
BROWN pinza	10.04	CASTROVIEJO rompe hojas	06.07	COLLIN DUVAL pinza	10.06
BROWN porta agujas	24.03	CASTROVIEJO SCHACHAR compás marcador	42.11	COLLIN espéculo vaginal	70.03
BRUENINGS abajalengua	48.02	CASTROVIEJO tijera corneal	09.03	COLLIN HARTMANN separador	18.04
BRUENINGS BRUNK separador para seno maxilar	46.29	CASTROVIEJO tijera de iridectomía	09.02	COLLIN histerómetro	70.22
BRUENINGS cierranudos para amígdalas	50.06	CASTROVIEJO trépano	43.08	COLLIN mango de bisturíes	06.03
BRUENINGS cuchillo para tabique	46.15	cateter auricular	44.07	COLLIN martillo	32.40
BRUENINGS espéculo auricular neumático	44.03	cateter de metal para hombre	66.06	COLLIN pelvímetero	72.05
BRUENINGS pinza cortante nasal	46.08	cateter de metal para mujer	66.07	COLLIN pinza hemostática	12.11
BRUENINGS punta de pinza	52.03	cateter dilatador prostático	66.07	COLLIN pinza para grapas	26.08
BRUNETTI cincel espinal	32.38	cateter dilatador uretral	66.07	COLLIN pinza para pólipos	16.04
BRUNNER aguja de ligaduras	26.03	cauterio oftálmico	42.09	COLLIN pinza tira-lengua	48.04
BRUNNER conductor de ligadura	26.04	CAWOOD MINNESOTA separador de mejillas	48.04	COLLIN separador	18.02
BRUNNER costótomo	56.03	cefalómetro	02.11	COLLIN separador abdominal	18.58
BRUNNER pinza intestinal	64.09	cepillo para limpiar cánulas traqueales	54.03	COLLIN separador abdominal	18.57, 18.58
BRUNNER separador	18.20	cepillo para tornillos canulados	33.23	COLLYER pelvímetero	72.05
BRUNNER sonda conductora de ligadura	26.04	cepillo para uñas esterilizable	74.05	COLLYER pinza para coger amígdalas	50.04
BRUNS cucharilla cortante	32.26 - 32.28	CHAMPEAU cánula	22.06	compás marcador	42.11
BRUNS tijera para vendajes	08.21	CHANCE pinza hemostática	12.09	compresor para amígdalas	50.06
BRYANT pinza para medicación	16.04	CHANDLER pinza para iris	42.13	compresor uretral	66.05
BÜCHS separador de mejillas y tejidos	18.23	CHAPUT pinza hemostática	12.11	conductor de hilo metálico	33.13
BUCK cuchillo auricular	44.08	CHARNLEY pinza para suturas	10.11	conductor de ligadura	26.03, 26.04
BUCK cureta auricular	44.07	CHARNLEY separador	18.64	CONE aguja ventricular	40.16
BUCK elevador para cuerpos extraños	44.10	CHARRIERE sierra para amputación	33.03	CONE pinza para craneotomía	40.07
BUCK GRAMCKO gubia	32.34	CHEATLE pinza para instrumentos	28.02	CONE separador	18.34
BUCK martillo de percusión	02.11	CHELSEA EATON espéculo anal	68.05	CONNIN AMSLER marcador	42.11
BUCK tijera para ligaduras	08.18	CHERON pinza para pólipos	16.05	contenedor de esterilización	88.11 - 88.21
BUELAU trócar torácico	22.03	CHEVALIER DE BOER separador de castillas	56.11	CONTOUR separador	18.30
BUIE tubo de aspiración	68.06	CHEVALIER JACKSON pinza	52.04	contra separador	18.42
bujía dilatadora uretral	66.06 - 66.08	CHEVRET separador	18.05	controlador de ángulo	34.04
bujía dilatadora uretral con rosca interior	66.06	CHILDE pinza para los bordes de la herida	26.07	CONVERSE bisturí para plastia nasal	46.14
BUMM cureta uterina	70.32	cierranudo para amígdalas	50.06, 50.07	CONVERSE separador alar	46.24
BUNGE cucharilla para exenteración	42.08	cierranudo para pólipos del oído	44.09	COOLEY dilatador vascular	56.17
BUNNELL perforador a mano	33.06	cierranudo para pólipos nasales	46.13	COOLEY pinza atrauma	11.03
BUNNELL separador para tendones	32.59	cierranudo rectal	68.06	COOLEY separador de atrio	56.11
BUNNELL sonda maleable	32.59	cincel	32.33, 32.34, 32.37 - 32.39, 46.18 - 46.20	COOLEY tubo de aspiración	04.03
BUNT clip porta instrumentos	28.02	cincel hemostático	44.19	COOPER aguja de ligadura	26.02
BURCH horquilla fijadora	42.06	CINELLI cincel para plastia	46.19	copa graduada	88.03
BURKE pinza sacabocado	70.26	cinta métrica cm/pulgadas	02.12	CORDESE punta de pinza	52.03
BUSCH tijera para cordón umbilical	08.14	cinta para huesos	32.22	corta-anillos	33.03
BVLAKE pinza para cálculos biliares	62.02	CITELLI pinza sacabocado	46.11	corta-hilos y clavos	33.18

C ables de conexión para instrumentos de AF	92.05
CAIRNS pinza hemostática	12.06
caja de esterilización con filtros en tapa y fondo	88.06
caja de vidrio para instrumentos con tapa inoxidable	88.02
caja para instrumentos sin perforar	88.07
calibre para brocas y tornillos	33.25
calibre para clavos intramedulares	36.06
CAMPBELL bujía dilatadora uretral	66.07
CANFIELD bisturí para amígdalas	50.04
CANNY RYALL separador	18.22
cánula de aspiración	40.15, 44.06
cánula de irrigación	46.13, 46.29
cánula de radiometría	22.06
cánula ocular	43.08
cánula para sutura	43.08
cánula para ventilación asistida por presión	52.06
cánula vascular	22.04
carcaí para electrodos de alta frecuencia	88.22
CARMALT pinza para espigas	10.12
CAROLL pinza para coger tendones	32.24
CARPENTER cuchillo para amígdalas y disecador	50.03
CARRREL pinza hemostática	12.03
CASPAR contra separador	18.42
CASPAR destornillador	18.41
CASPAR distractor para cuerpos vertebrales	18.41
CASPAR espéculo para operación vertebral lumbar	18.42
CASPAR gancho para exploración y coagulación	40.26
CASPAR guía-taladro	18.41
CASPAR mango de bisturíes micro bayoneta	06.08
CASPAR pinza para laminectomía	40.20
CASPAR pinzas cortantes para laminectomía	40.19
CASPAR placa trapezoidal para columna cervical	36.24
CASPAR separador para laminectomía	18.38 - 18.40
CASPAR taladro	18.41
CASPAR tornillo de distracción	18.41
CASTANEDA separador de castillas	56.06
CASTROVIEJO blefarostato	42.03
CASTROVIEJO compás marcador	42.11
CASTROVIEJO espátula para cidodialis	42.09, 42.10
CASTROVIEJO pinza capsular	43.04

clamp atrauma para anastomosis	12.28
clamp bulldog atrauma	12.02
clamp cardiovascular atrauma	12.02
clamp cierra-pene	66.05
clamp de aurícula	56.16
clamp de vena cava	56.15
clamp para anastomosis	64.10
clamp para apéndice	64.04
clamp para el conducto biliar	12.24
clamp para huesos	32.22
clamp umbilical	72.05
CLAR lámpara frontal	02.05
CLARK blefarostato	42.02
clavo intramedular	36.04 - 36.06
clavo intramedular con gancho	36.02
clavo intramedular flexible	36.03
clavo para el cuello del fémur	36.07, 36.08
clavo para huesos	33.11, 36.02 - 36.08
CLAYMAN pinza para implantar lentes	42.18
CLEVELAND pinza corta huesos	32.13
clip porta instrumentos	28.02
clip porta placas	33.25
CLOWARD HOEN separador	18.43
CLOWARD separador	18.36, 18.37
coagulación, instrumentos para	92.02 - 92.05
COAKLEY cureta para seno	46.26
COBB cureta para la fusión espinal	32.30
COBB elevador espinal	32.52
COBB gubia espinal	32.37
COBBET dermatótom	06.12
cobra elevador para huesos	32.54
CODIVILLA pinza para clavícula	32.21
COLCLOUGH pinza sacabocado para discos interv.	40.22
colibri blefarostato	42.02
colibri pinza para iris	42.15
colibri tijera	09.02
COLLIN bisturí para la plastia nasal	46.14
COLLIN cincel para la plastia nasal	46.18
COLLIN clamp umbilical	72.05
COLLIN costótomo	56.02
COLLIN cureta uterina	70.35
COLLIN dinamómetro	02.05
COLLIN DUVAL pinza	10.06
COLLIN espéculo vaginal	70.03
COLLIN HARTMANN separador	18.04
COLLIN histerómetro	70.22
COLLIN mango de bisturíes	06.03
COLLIN martillo	32.40
COLLIN pelvímetero	72.05
COLLIN pinza hemostática	12.11
COLLIN pinza para grapas	26.08
COLLIN pinza para pólipos	16.04
COLLIN pinza tira-lengua	48.04
COLLIN separador	18.02
COLLIN separador abdominal	18.58
COLLIN separador abdominal	18.57, 18.58
COLLYER pelvímetero	72.05
COLLYER pinza para coger amígdalas	50.04
compás marcador	42.11
compresor para amígdalas	50.06
compresor uretral	66.05
conductor de hilo metálico	33.13
conductor de ligadura	26.03, 26.04
CONE aguja ventricular	40.16
CONE pinza para craneotomía	40.07
CONE separador	18.34
CONNIN AMSLER marcador	42.11
contenedor de esterilización	88.11 - 88.21
CONTOUR separador	18.30
contra separador	18.42
controlador de ángulo	34.04
CONVERSE bisturí para plastia nasal	46.14
CONVERSE separador alar	46.24
COOLEY dilatador vascular	56.17
COOLEY pinza atrauma	11.03
COOLEY separador de atrio	56.11
COOLEY tubo de aspiración	04.03
COOPER aguja de ligadura	26.02
copa graduada	88.03
CORDESE punta de pinza	52.03
corta-anillos	33.03
corta-hilos y clavos	33.18
CORWIN compresor para amígdalas	50.06
CORYLLOS costótomo	56.02
CORYLLOS separador torácico	18.20
COS pinza para doblar alambre	44.12
costótomo	56.02, 56.03
COTTLE cuchillo para la plastia nasal	46.14
COTTLE elevador para tabique nasal	46.16
COTTLE espéculo nasal	46.04
COTTLE instrumento para magullar cartilago	46.23
COTTLE introductor de cartilago	46.23
COTTLE KAZANJIAN pinza cortante para huesos	32.13
COTTLE martillo	32.40
COTTLE NEIVERT separador	46.24
COTTLE perióstomo	46.17
COTTLE pinza de columela	46.26
COTTLE pinza para sacar la piel	46.26
COTTLE protector de alas	46.25
COTTLE retractor de alas	46.25
COTTLE separador	46.24
COTTLE tijera nasal	08.09
COVENTRY grapa ósea	36.25
COXETER cateter prostático	66.07
CRAFOORD (STELZNER) tijera	08.16
CRAFOORD pinza clamp bronquial	12.18
CRAIG pinza para tabique y vomer	46.07
cranioclasto	72.07
CREA bujía dilatadora uretral	66.08
Credo corta-callos	74.04
CRILE gancho para nervios	40.05
CRILE MURRAY porta aguja	24.03
CRILE pinza hemostática	12.05
CRILE porta aguja	24.07
CRILE RANKIN (OCHSNER DIXON) pinza	12.06
CRILE RANKIN pinza hemostática	12.06
CRILE separador	18.03
CRILE WOOD porta aguja	24.03
CRITCHETT blefarostato	42.02
CROTTI separador para bocio	18.28
CRUTCHFIELD perforador inicial	40.04
Cruz Roja tijera para vendajes	08.21
CSTROVIEJO pinza para sutura	43.05
cubeta con tapa	88.04
cubeta redonda	88.03
cubo móvil para desperdicios	88.04

Índice alfabético

cuchara para cálculos biliares	62.04
cuchara para secreciones	66.05
cucharilla cortante para hipofisectomía	40.25, 40.28
cucharilla cortante para huesos	32.26 - 32.32
cucharilla para aborto	72.06, 72.07
cucharilla para catarata	42.08
cucharilla para chalazión	42.08
cucharilla uterina cortante	70.31
cuchillo auricular	44.08, 44.17
cuchillo circular	44.17
cuchillo corneal	42.05
cuchillo de autopsia	06.13
cuchillo de disociación	42.05
cuchillo de goniotomía	42.06
cuchillo de peristio	06.13
cuchillo de resección	06.10
cuchillo de tabique nasal	46.14
cuchillo de trigémino	40.09
cuchillo forma de hoz	44.17
cuchillo inter óseo	06.11
cuchillo lobar	44.17
cuchillo para amígdalas	50.04
cuchillo para amputación	06.10
cuchillo para arachnoide	40.29
cuchillo para cartílagos	06.13
cuchillo para catarata	42.04
cuchillo para cerebro	06.13
cuchillo para conización	70.29
cuchillo para falanges	06.11
cuchillo para iridectomía	42.05
cuchillo para iris	42.05
cuchillo para lóbulos	06.11
cuchillo para órganos	06.13
cuchillo para peristio	44.19
cuchillo para plastia nasal	46.14
cuchillo para queratoplastia	42.06
cuchillo para tabique nasal	46.15
cuchillo para vegetaciones	46.15
cuchillo para vegetaciones adenoides	46.27
cuchillo para yeso	30.04
cuchillo vascular	40.29
cureta para seno	46.26
CULLER espátula para iris	42.09
cureta auricular	32.32, 44.07, 44.08
cureta cortante para disco roto	32.29
cureta de biopsia aspiradora uterina	70.23, 70.36
cureta de biopsia uterina	70.23, 70.24
cureta doble para la microcirugía del oído	44.18
cureta maleable para hipofisectomía	40.24, 40.25
cureta para cuerpos extraños	42.06
cureta para disco roto	32.29
cureta para fusión espinal	32.30
cureta para fusión espinal	32.30
cureta para lupus	74.02
cureta pituitaria	40.28
cureta uterina	70.31 - 70.36
cureta uterina con irrigación	70.24
cureta uterina de aspiración	70.36
cureta y diseccionador para canal lagrimal	42.09
cureta y gancho	44.08
CUSCO espéculo vaginal	70.04, 70.05
CUSHING espátula cerebral	40.15
CUSHING KOCHER separador	18.14
CUSHING LANDOLT espéculo para hipofisectomía	40.23
CUSHING 'little joker' peristiotomo	32.46
CUSHING perforador plano	33.05
CUSHING pinza de disección	10.05
CUSHING pinza hemostática	12.07
CUSHING pinza para laminectomía	40.17
CUSHING separador	18.09
CUSHING separador arterial	40.05
CUSHING separador para duramadre	40.05
CUSHING TAYLOR pinza de disección traumática	10.08
CUZZI cuchara para aborto	72.06
CZERNY espéculo rectal	68.02
CZERNY pinza para coger el útero	70.20
CZERNY separador	18.04

D

DAHLGREN pinza craneana	40.07
DALE pinza gubia	32.12
DANDY mosquito pinza hemostática	12.09
DANDY pinza hemostática	12.09
DANDY separador para nervios	40.05

DANDY tijera neuroquirúrgica	08.15
DANIELS amigdalótomo hemostático	50.08
DANIS tensor de hilo metálico	33.13
DARLING separador	18.34
DARTIGUES pinza histerólabo	70.21
DASTOOR aspirador capsular	42.11
DASTOOR pinza para estrabismo	42.16
DAUBENSPECK cucharilla cortante	32.27
DAVIDSON (escápula) separador	18.21
DAVIEL cucharilla para catarata	42.08
DAVIS aguja para cuerpos extraños	42.06
DAVIS BOYLE abre-boca	48.07
DAVIS descolador de duramadre	40.08
DAVIS MEYER abre-boca	48.09
DAVIS pinza para coger jeringas	28.02
DAY gancho auricular	44.09
DE BAKEY clamp bulldog traumática	12.02
DE BAKEY DIETHRICH pinza de disección traum.	11.04
DE BAKEY dilatador vascular	56.17
DE BAKEY pinza de disección traumática	11.03, 11.04
DE BAKEY pinza extra ligera traumática	11.06
DE BAKEY porta agujas	24.04
DE BAKEY separador de castillas	56.07
DE BAKEY separador femoral	18.56
DE BAKEY tijera vascular	08.11, 08.12
DE BAKEY tubo de aspiración	04.02
De LEE fórceps obstétrico	72.02
De LEE HILLIS estetoscopio	02.09
De LEE pelvómetro para medir el interior	72.05
De MARTEL guía-sierra	40.06
DEAN cuchillo para iris	42.05
DEAN tijera para amígdalas	08.10
DEAVER grip separador	18.07
DEAVER separador	18.06
DEAVER tijera	08.03
dedal	48.12
DEJERINE martillo de percusión	02.10
DeMARTEL WOLFSON pinza para anastomosis	64.10
DeMARTEL WOLFSON porta clamps	64.10
DEMEL conductor de alambre	33.13
DEMEL tensor cierra-hilos	33.13
DENHART abreboca	48.05
DENIS BROWNE pinza intestinal	10.09
DENNIS BROWN separador abdominal	18.49
depresor de epiglotis	52.02
depresor uterino	70.21
DERF (WRIGHT) porta aguja	24.02
DERF porta aguja	24.02
dermatómo	06.11, 06.12
DERRA pinza para anastomosis	56.16
D'ERRICO perforador	33.05
DESCHAMPS aguja de ligadura	26.02
descolador de duramadre	40.07, 40.08
descolador para hipofisectomía	40.24
descolador para la microcirugía del oído	44.18
DESJARDINS clamp para conducto biliar	12.23
DESJARDINS cuchara para cálculos biliares	62.04
DESJARDINS pinza para cálculos biliares	62.02
DESJARDINS sonda para cálculos biliares	62.03
DESMARRES pinza para chalazión	43.06
DESMARRES separador (párpados)	18.08
desobliterador de vena	20.03, 20.05
destornillador	18.41, 33.20, 33.22
DEUTSCHMANN cuchillo para catarata	42.04
DeVILBISS pinza craneana	40.07
DEWEY fórceps obstétrica con tractor	72.04
Diamant corta-hilos	33.16
diaspasón	44.04, 44.05
DICK trauma clamp para anastomosis	12.28
DIEFFENBACH serra-fina	12.03
DIETER pinza para la cabeza del martillo	44.13
DIETHRICH porta aguja	24.09
DIETHRICH tijera	08.11
dilatador lagrimal	42.11, 42.12
dilatador del fémur	33.18
dilatador para el seno frontal	46.29
dilatador traqueal	54.02
dilatador uterino	70.14 - 70.17
dilatador vascular	56.17, 56.18
dinamómetro	02.05
DINGMAN abreboca	48.10
DINGMANN pinza para huesos	32.19
diseccionador corneal	42.06
diseccionador de duramadre	40.07, 40.08
diseccionador para amígdalas	50.02
diseccionador para hipofisectomía	40.24, 40.25

diseccionador vascular	56.18
distractor para cuerpos vertebrales	18.41
distribuidor de alcohol	88.04
distribuidor de cepillos	74.05
distribuidor de filtros	88.24
distribuidor de taladros filiformes	88.22
DITTEL buja dilatadora uretral	66.06
DIX aguja y cincel	42.10
DIX aguja y gubia	42.10
DIX cincel para cuerpos extraños	42.06
DOUGLAS pinza depilatoria	43.10
DOUGLAS trócar y cánula	22.02
DOWNING meniscótomo	32.58
DOYEN abajalengua	48.02
DOYEN baby pinza intestinal	64.05
DOYEN espéculo vaginal	70.10
DOYEN estilete acanalado	20.02
DOYEN fresa	33.09
DOYEN JANSEN abreboca	48.05
DOYEN martillo	32.41
DOYEN peristiotomo costal	32.47
DOYEN pinza intestinal	64.05
DOYEN pinza para campos	14.04
DOYEN pinza para pólipos uterino	70.20
DOYEN porta aguja	24.03
DOYEN separador abdominal	18.18
DOYEN STILLE separador	18.22
DOYEN tijera ginecológica	08.13
DOYEN tirabuzón para fibromas	70.29
DRAFFIN bipod para abre-boca	48.11
DUBOIS tijera ginecológica	08.13
DUBOST separador de castillas	56.10
DUEHRSEN pinza de disección	10.10
DUNHILL pinza hemostática	12.06
DUPLAY pinza para curaciones	16.06
DUPLAY pinza uterina	70.18
Duplex estetoscopio	02.09
DUPUY DUTEMPS separador para el saco lagrimal	42.03
DUPUY WEISS aguja para amígdalas	50.03
DURANTE pinza	10.07
DURHAM separador	18.22
DUVAL pinza	10.06
DUVAL pinza para agarrar intestinos y tejido	64.03

E

ECHLIN pinza gubia	32.10
EDNA pinza para campos	14.03
EISELSBERG MATHIEU porta aguja	24.08
ejército EEUU separador	18.03
ejército EEUU tijera para garza	08.20
electrodos de corte y de coagulación	92.02
elevador	32.49 - 32.57, 44.19, 46.16, 46.17, 46.29
elevador para amígdalas	50.02
elevador para cuerpos extraños	44.10
elevador para huesos	32.52 - 32.57
elevador para la duramadre	40.09
elevador para tabique nasal	46.16, 46.17
ELLIOT fórceps obstétrico	72.02
ELLIOT trépano	43.09
ELLIS gubia para cuerpos extraños	42.06
ELSCHNIG cuchillo corneal	42.05
ELSCHNIG espátula de cistodilisis	42.09
ELSCHNIG pinza capsular	43.04
EMMET gancho fistular	70.29
EMMET pinza para pólipos	16.06
empujador de clavos	34.11
empujador final	34.04
empujador inicial para clavos	34.11
empujador para clavos intramedulares flexibles	34.10
empujador para clavos intramedulares	33.19
empujador para grapas óseas	34.12
empujador para tornillos DHS	34.07
empujador y extractor para clavos	33.18, 33.19, 34.11, 34.12
empujador y extractor para placas angulares	34.04, 34.05
endoespéculo vaginal	70.13
ENGEL sierra para vendajes enyesados	30.02
ensordecedor	44.05
enucleador para hipofisectomía	40.25
Eppendorfer KEVORKIAN pinza de biopsia uterina	70.20
escariador	33.18
escarificador	42.04
esclerótomo	42.06

Índice alfabético

esofina nasal	46.22
escaplo guía para placa angular	34.04
esfigmomómetro	02.02 - 02.04
ESMARCH cuchillo para yeso	30.04
ESMARCH tijera para vendajes	08.20
espátula abdominal	18.22, 18.54
espátula bifurcada	40.25
espátula cerebral	40.15
espátula de cicloclísis	42.09, 42.10
espátula de curación	20.05
espátula doble	20.05
espátula para enucleación	42.09
espátula para iris	42.09
espátula para la íntima	56.18
espátula pulmonar	56.12
espátula vesical	66.03
espéculo auricular	44.02, 44.03
espéculo auricular neumático	44.03
espéculo de nasofaringe	46.05
espéculo endocervical	70.13
espéculo nasal	46.02 - 46.04
espéculo para tabique nasal	46.04
espéculo rectal	68.02, 68.03
espéculo vaginal	70.02 - 70.13
espejo frontal	02.05
espejo laringeo	52.07
espejo prostrinoscópico	46.05
estantería portátil para mini containers	88.19
estesiómetro	02.11
estetoscopio	02.09
estiletos y sondas	20.02
Estrasburgo pinza estriada	10.10
estribo de extensión	33.12
estuche de acero	88.02
estuche de sutura con agrafes	26.08
estuche para agujas de sutura	88.02
EYES cierranudos para amígdalas	50.06
EWALD (HUDSON) pinza	10.04
excisión, pinza de	64.09
extensor de dedos	33.12
extractor para clavos flexibles medulares	34.10
extractor para grapas óseas	34.12

F	
FAHLBUSCH cucharilla maleable	40.25
FAHLBUSCH cureta maleable	40.25
FALCONER pinza gubia	32.07
FARABEUF COLLIN periostótomo	32.45
FARABEUF LAMBOTTE pinza para huesos	32.15
FARABEUF periostótomo	32.45
FARABEUF pinza para huesos	32.15
FARABEUF separador doble pareja	18.02
FARR separador	18.26
FARREL porta-algodón	20.06
FARRIOR espéculo auricular	44.02
FAULKNER cureta cortante	46.26
FAURE pinza para biopsia uterina	70.24
FAURE pinza para peritoneo	12.27
FAVALORO tijera vascular	08.12
FEATHERSTONE abreboca	48.05
FEHLAND pinza intestinal	64.09
FEILCHENFELD pinza para espigas	10.12
FEIN porta algodón	20.06
FERGUSSON ACKLAND abreboca	48.05
FERGUSSON cuchara para cálculos biliares	62.04
FERGUSSON pinza clamp de presión progresiva	12.09
FERGUSSON pinza para huesos	32.15
FERGUSSON tijera	08.06
FERRIS SMITH pinza	10.05
FERRIS SMITH pinza cortante para laminectomía	40.18
FICKLING pinza hemostática	12.07
FINCH pinza de excisión	64.09
FINOCHIETTO BURFORD separador de costillas	56.05
FINOCHIETTO clamp bronquial	56.04
FINOCHIETTO porta aguja	24.06
FINOCHIETTO separador de costillas	56.04, 56.05
FINSEN separador	18.26
FINSTERER tubo de aspiración	04.03
FISCH descolador	44.18
FISCHER ARLT pinza para iris	42.15
FISCHER cuchillo para amígdalas	50.04
FISCHER pinza para iris	42.15
FISH sonda auricular	20.02
flebodisecador	20.05
FLETCHER (JAVERTS) pinza para esponjas	16.04

FLEURANT trócar para la vejiga	22.02
FLIERINGA anillo para el bulbo	42.18
FLUHRER sonda	20.02
FOERSTER pinza para esponjas	16.03
FOERSTER pinza para iris	42.14
FOMON cincel	46.18
FOMON esofina nasal	46.22
FOMON lima nasal	46.21
FOMON separador para alas	46.24
FOMON tijera de disección	08.09
FOMON tijera nasal	08.09
fonendoscopia	02.09
fórceps obstétrico	72.02 - 72.04
FORD BOWLES estetoscopio	02.09
FOX cureta para lupus	74.02
FRAENKEL pinza para pólipos laringeos	52.02
FRAENKEL punta de pinza	52.03
FRANCESCHETTI trépano corneal	43.08
FRANCIS aguja para cuerpos extranjeros	42.06
FRANKLIN SILVERMANN aguja de punción	22.05
FRASIER pinza hemostática	12.13
FRAZIER ganchito de duramadre	18.07
FRAZIER separador	18.44
FRAZIER tubo de aspiración	40.15, 40.16
FREER bisturí para mucosa	46.14
FREER cincel para tabique nasal	46.17
FREER cuchillo para tabique nasal	46.14
FREER elevador para tabique nasal	46.16
FREER gancho para mucosa	46.24
FRENZEL abajalengua	48.02
fresa	33.04, 33.05
	33.08, 33.09
FRIEDMAN pinza gubia	32.02
FRIEDMAN separador para perineorrafia	70.13
FRITSCH separador	18.17
FRYKHOLM pinza gubia	32.10
FUCHS pinza capsular	43.04
FUCHSIG pinza hemostática	12.14

G	
GABRIEL espéculo rectal	68.05
GALLAHER lima para seno ganchito	46.22
	18.07, 33.25,
	40.05, 40.25,
	40.26, 42.07,
	44.09, 44.17,
	44.18, 46.25
	44.09
gancho auricular	
gancho cístico	68.06
gancho de decapitación	72.08
gancho de extracción para clavos óseos	33.19
gancho de extracción para I.U.D.	70.21
gancho de fijación	42.07
gancho fistular	70.29
gancho muscular	42.07
gancho obstétrico	72.05
gancho para estrabismo	42.07
gancho para exploración y coagulación	40.26
gancho para iris	42.07
gancho para mucosa	46.24
gancho para nervios	40.05
gancho traquea	54.02, 54.03
GARRETT dilatador vascular	56.18
garrote de madera	48.12
GELPI separador perineal	18.56
Gemini pinza de disección y para ligadura	12.17
GERALD pinza de disección	10.08
GERSTER barra de tracción	32.22
GERZOG martillo	32.40
GIERTZ STILLE costótomo	56.03
GIGLI mango para sierra de hilo	40.06
GIGLI sierra hilo	40.06
GIL VERNET separador	18.09
GILL ARRUGA pinza capsular	43.03
GILL cuchillo corneal	42.05
GILL HESS pinza para iris	42.14
GILL pinza para iris	42.14
GILLIES (FRENCH) osteótomo	32.34
GILLIES ganchito fino	46.25
GILLIES pinza de disección	10.07
GILLIES porta aguja con tijera	24.09
GILLIES pinza de disección	10.07
GIRARD pinza para sutura corneoescleral	43.05
GLASER separador para laminectomía	18.64
GLOVER clamp cardiovascular atrauma	12.02

GLUCK costótomo	56.02
GOELET separador	18.04
GOLDMAN FOX tijera	08.18
GOLDSTEIN blefarostato	42.03
goniómetro	02.11
GOOD tijera para amígdalas	08.10
GOODELL dilatador uterino	70.17
GORNERY tijera de disección	08.04
GOSSET separador abdominal	18.44
GOURET cureta uterina	70.31
GRADLE pinza depilatoria	43.10
GRAE espéculo vaginal	70.02, 70.06
GRAEFE blefarostato	42.02
GRAEFE cucharilla para catarata	42.08
GRAEFE cuchillo para catarata	42.04
GRAEFE escarificador	42.04
GRAEFE ganchito para iris	18.07
GRAEFE gancho para estrabismo	42.07
GRAEFE gancho para estrabismo de titanio	42.07
GRAEFE pinza	10.05
GRAEFE pinza de fijación	43.03
GRAEFE pinza para iris	42.12, 42.13
GRAEFE quistótomo	42.07
GRAHAM gancho para nervios	40.05
grapa para huesos	36.25
grapa para osteotomía	36.26
grapas de plata para sutura cerebral	40.03
grapas de plata para sutura del estómago	64.13
GRAVE espéculo vaginal „view more“	70.06
GRAY clamp para conducto biliar	12.24
GREEN ARMYTAGE pinza clamp uterina	72.05
GREEN disecador corneal	42.06
GREEN gancho muscular	42.07
GREEN pinza de fijación	43.03
GREEN separador	18.16
GREENE cureta uterina	70.34
GREVEN pinza auricular para doblar hilo	44.12
grip pinza de agarre	33.14
grip separador	18.04, 18.05,
	18.07
GROSS cureta y gancho	44.08
GROSS MAIER pinza para esponjas	16.02
GROSS MAIER pinza para pólipos	16.02
GRUBER espéculo para oídos	44.02
GRUENWALD pinza nasal	46.05
gubia	32.33 - 32.38,
	33.22, 42.06,
	46.20
guía para catéteres traqueales	04.04
guías para brocas	18.41, 33.05,
	33.25, 33.26,
	34.02, 34.04,
	34.06, 34.08
guía-sierra de hilo	40.06
GUILLEN cánula de irrigación	46.29
GUNNAR HEY pinza con rodillos	12.32
GUTHRIE ganchito doble	18.07
GUTMANN cuchara para secreciones	66.05
GUYON bujía dilatadora uretral	66.06
GUYON bujía dilatadora uretral con rosca interior	66.06
GUYON mandril para catéteres	66.05
GUYON pinza para el pedículo renal	12.24, 12.25
GUYTON LUNDGAARD esclerótomo	42.06

H	
HABERER separador maleable	18.05
HACKSTOCK pinza plana con ranura	33.15
HAGLUND STILLE separador para yeso	30.04
HAIGHT separador	56.05
HAJEK BALLENGER elevador de tabique nasal	46.17
HAJEK CLAUD pinza para seno maxilar	46.12
HAJEK gubia forma V	46.20
HAJEK KOFLER pinza sacabocados	46.11
HAJEK martillo	32.41
HAKANSSON pinza gubia	32.04
HALLE bisturí para duramadre	40.08
HALLE cucharilla cortante maleable	32.29
HALLE elevador para tabique	46.16
HALSEY porta aguja	24.02
HALSTED micro mosquito pinza hemostática	12.04
HALSTED mosquito pinza hemostática	12.04
HALSTED mosquito pinza hemostática de titanio	12.04
Hamburg cánula abotonada	43.08
HANK dilatador uterino	70.16
HARDY cureta maleable	40.24

Índice alfabético

HARDY disecador	40.24
HARDY enucleador	40.24
HARDY FAHLBUSCH disecador	40.24
HARDY tenedor de implantación	40.24
HARKEN damp auricular	56.16
HARMS sonda trabecular	42.12
HARRINGTON pinza bronquial	56.13
HARRINGTON separador	18.07
HARTMANN abajalengua	48.02
HARTMANN baby pinza hemostática	12.03
HARTMANN cateter para oídos	44.07
HARTMANN diapasón	44.04
HARTMANN espéculo nasal	46.02
HARTMANN espéculo para oídos	44.02
HARTMANN HOFFMANN pinza auricular	44.11
HARTMANN pinza auricular	44.10, 44.11
HARTMANN pinza cortante para amígdalas	50.08
HARTMANN pinza gubia	32.06
HARTMANN pinza hemostática	12.03
HARTMANN pinza nasal cortante	46.10
HARTMANN pinza para pólipos	46.06
HARTMANN WULLSTEIN pinza auricular	44.11
HARVEY tijera para alambre	08.19
HATFIELD cureta para fusión espinal	32.30
HAUGH pinza auricular	44.12
HAWKIN AMBLER dilatador uterino	70.16
HEANEY (HEGAR) porta aguja	24.05
HEANEY cureta para biopsia uterina	70.24
HEANEY pinza para histerectomía	12.30
HEANEY separador	18.19
HEATH martillo	32.43
HEATH tijera para ligaduras	08.18
HEBRA cucharilla para chalazión	42.08
HEGAR dilatador uterino	70.14, 70.15
HEGAR porta aguja	24.04
HEGAR vascular porta aguja	24.05
HEGENBARTH pinza para agrafes	26.07
HEIFETZ espátula cerebral	40.15
HEIFETZ pinza para tumores	11.05
HEIMING pinza para cálculos renales	62.06
HEISS pinza hemostática	12.13
HEISTER abreboza	48.05
HELFERICH BIER sierra para amputación	33.02
HENKE elevador para amígdalas	50.02
HENLY separador	18.31
HENNER (LEMPERT) separador	18.29
HENNIG separador para yesos	30.04
HENROTH pinza	70.20
HERBERHOLD abajo lengua	48.10
HERRICK pinza para pedículo renal	12.25
HERTZLER separador costal	56.11
HERZ pinza para coger tendones	32.25
HESS pinza capsular	43.04
HESS pinza para iris	42.14
HEY GROVES pinza para huesos	32.17
HEYMANN KNIGHT pinza nasal	46.06
HEYMANN pinza cortante nasal	46.08
HEYMANN tijera nasal	08.09
HEYWOOD SMITH pinza para hemorroides	68.08
HIBBS cincel	32.38
HIBBS osteótomo	32.38
HIBBS separador	40.06
HIBBS valva de separador	18.63
HIRSCHMANN anoscopio	68.05
HIRSCHMANN espátula para ciclodialisis	42.10
histerómetro	70.22
HOEN descalador	32.52
HOEN elevador para la duramadre	40.09
HOEN separador para hemilaminectomía	18.43
HOESEL porta aguja	24.08
HOESEL separador	18.17
HOFER separador de pilar	50.02
HOFF pinza para campos	14.03
HOHMANN elevador para huesos	32.53, 32.54
hoja de bisturíes estéril	06.05
hoja de bisturíes microquirúrgica estéril	06.08
hoja de cincel intercambiable	32.33
hojas de afeitar para rompehojas	06.07
HOKÉ cincel	32.37
HOLTH pinza para capsuloridectomía	42.11
HOLZBACH separador abdominal	18.58
HOPKINS cuchillo para yeso	30.04
horquilla fijadora	42.06
HORSLEY disecador de duramadre	40.08
HOSOBUCHI espátula bifurcada	40.25
HOUSE cureta doble	44.18
HOWARTH elevador	32.50

HRVNTSCHAK separador prostático	66.03
HUBER mango universal	52.03
HUDSON perforador completo	33.05
HUMBY dermatótopo	06.12
HUNT pinzas de disección	11.06
HUNTER pinza para espigas	10.12
HUPP separador traqueal	54.03
HURD aguja para paladar	50.03
HURD disecador para amígdalas	50.02
HUSTINX separador perineal	18.56

I	
I.U.D. gancho de extracción	70.21
imán oculístico con asa	43.09
INGE separador vertebral	40.16
instrumento de circuncisión	66.05
instrumento para doblar perforadores	34.13
instrumento para doblar placas para huesos	33.21
instrumento para magullar cartilago	46.23
instrumento para medir el largo de los tornillos	33.23
insuflador de aire	44.06
introdutor para clavos medulares flexibles	34.10
introdutor de grapas óseas	34.12
introdutor para cartilago	46.23
introdutor para clavos	34.12
IOWA pinza uterina	70.19
irrigador	88.03
IRWIN MOORE pinza nasal	46.08
ISRAEL separador	18.16
ITARD cateter auricular	44.07
IVES FANSLER anoscopio	68.05

J	
JACKSON BURROWS separador	32.57
JACKSON espéculo vaginal	70.10
JACKSON gancho traqueal	54.02
JACKSON pinza para tapones	52.02
JACKSON separador para bocio	18.27
JACKSON separador traqueal	54.02
JACKSON tubo traqueal	54.03
JACOBS pinza uterina	70.19
JACOBSON cuchillo vascular	40.29
JACOBSON cureta cortante para huesos	32.32
JACOBSON micro pinza	12.14
JACOBSON sonda	40.27
JAEGER placa para párpados	42.03
JAEGER querátomo	42.04
JAMESON gancho para estrabismo	42.07
JAMESON pie de rey	42.11
JAMESON pinza muscular	43.07
JAMESON pinza para estrabismo	42.16
JAMISON porta agujas	24.05
JANSEN cucharilla cortante	32.31
JANSEN GIFFORD separador agudo	18.27
JANSEN perióstotomo	32.46
JANSEN pinza auricular forma bayoneta	44.09
JANSEN pinza gubia	32.05, 32.06
JANSEN pinza nasal forma de bayoneta	46.05
JANSEN separador	18.27
JANSEN STRUYCKEN pinza cortante nasal	46.12
JANSEN WAGNER separador	18.27
JARCHO pinza uterina	70.18
JATHO pinza nasofaríngea cortante	46.26
JEANS pinza de disección	10.06
JENNINGS abreboza	48.06
jeringa auricular	44.06
jeringa de aspiración para la punción del hígado	22.05
jeringa para amígdalas	50.08
jeringa record	18.64
JEWETT buja uretal dilatadora	66.08
JEWETT clavo para el cuello del fémur	36.08
JEWETT empujador y extractor	34.11
JOBSON HORNE porta-algodón	20.06
JOHNS HOPKINS pinza hemostática biliar	12.23
JOHNS HOPKINS serra-fina	12.03
JOHNSON porta aguja	24.06
JOLL separador para tiroide	54.04
JONES pinza hemostática	12.09
JONES pinza para campos	14.02
JOSEPH (LEWIS) lima nasal	46.21
JOSEPH bisturí nasal para plastia	46.13, 46.14
JOSEPH gancho para mucosa	18.07
JOSEPH lima para huesos	46.20

JOSEPH MASING elevador de perióstio	46.17
JOSEPH perióstotomo	46.16
JOSEPH sierra nasal	46.23
JOSEPH tijera	08.06
JUDD ALLIS pinza para coger intestinos y tejidos	64.02
JUDD MASSON separador vesical	66.03
juego de instrumentos para autopsia	32.39
juego de manicura para enfermeras	74.03
juego de sierras, taladros y fresas	33.07
juego de traquetotomía con estuche	54.03
juego de trefinas cutáneas	74.03
JUERS pinza para doblar alambre	44.12
JULIAN porta aguja	24.05
JURASZ pinza para pólipos	52.02

K	
KABIERSKE lanza-palvo	44.05
KADER separador	18.20
KALLMORGEN espéculo vaginal	70.09
KALT ARRUGA porta aguja	24.10
KALT pinza capsular	43.04
KALT porta aguja	24.10
KANE clamp umbilical	72.05
KANTROWITZ pinza hemostática	12.20
KAPLAN tijera para tabique nasal	46.11
KATZIN tijera corneal	09.03
KEITH aguja de sutura	26.06
KELLY GRAY cureta uterina maleable	70.23
KELLY grip separador	18.05
KELLY pinza hemostática	12.05, 12.15
KELLY pinza hemostática de titanio	12.05
KELLY pinza para pólipo uterino	70.20
KELLY proctoscopio	68.05
KELLY RANKIN pinza hemostática	12.05
KELLY separador	18.05, 18.18
KELLY tijera para fistulas	08.13
KELLY tijeras	08.13
KERBOUL placa humeral epicondilar	36.22
KERBOUL placa proximal para el húmero	36.22
KERBOUL placa radial	36.22
KERBOUL placa tibial	36.22
KERN pinza para huesos	32.16
KERPEL cucharilla cortante	32.27
KEVORKIAN cureta para biopsia uterina	70.23
KEVORKIAN Pacific pinza para biopsia uterina	70.27
KEVORKIAN pinza para biopsia uterina	70.26
KEVORKIAN punta de pinza para biopsia	70.28
KEY elevador	32.50
KEY trefina cutánea	74.03
KIELLAND fórceps obstétrico	72.02
KILLIAN cánula de irrigación	46.13
KILLIAN CLAUD gubia en V	46.20
KILLIAN elevador para tabique nasal	46.17
KILLIAN espéculo para tabique nasal	46.04
KILLIAN espéculo para tabique con luz fría	46.08
KILLIAN gubia para tabique nasal	46.20
KILLIAN tijera para tabique nasal	46.11
KILNER DOUGHTY abreboza	48.08
KILNER ganchito para la piel	74.02
KILNER porta aguja	24.03
KILNER separador alar	46.24
KILNER tijera	08.06
KIRBY ARTHUR pinza para iris	42.15
KIRESTELLER espéculo vaginal	70.07 - 70.09
KIRK martillo	32.40
KIRSCHNER estribo de extensión	33.12
KIRSCHNER estribo de extensión americano	33.12
KIRSCHNER perforador con guía telescópica	33.05
KIRSCHNER sonda conductora de ligadura	26.04
KIRSCHNER taladro filiforme	33.10
KIRSCHNER separador abdominal	18.48, 18.49
KLAPP separador para tendones	18.12
KLEINERT KUTZ gízala para hueso	32.14
KLEINERT KUTZ pinza cortante para huesos	32.14
KLEINERT KUTZ pinza para coger tendones	32.25
KLEINSASSER laringoscopio	52.05
KLEINSCHMIDT clamp para apéndice	64.04
KLINKENBERGH LOTH tijera torácica	08.16
KNAPP cucharilla para catarata	42.08
KNAPP cuchillo para iris	42.05
KNAPP LUER pinza para tracoma	43.07
KNAPP separador	42.07
KNNAUS cuchillo vascular	40.29
KNIGHT pinza cortante nasal	46.08
KNIGHTON separador para laminectomía	18.35

Índice alfabético

KNOLLE ganchito romo	42.07
KNOWLES tijeras para vendajes de los dedos	08.21
KOCHER espátula vesical	66.03
KOCHER LANGENBECK separador	18.15
KOCHER Nippon pinza hemostática	12.07
KOCHER pinza hemostática fina	12.08
KOCHER pinza intestinal	64.05, 64.06
KOCHER pinza intestinal atraumática	64.06
KOCHER separador	18.17
KOCHER separador para bocio	18.11, 18.14, 18.15, 18.17, 18.28
KOCHER sonda para bocio	54.04
KOENIG aguja de sutura	26.06
KOENIG elevador	32.50
KOENIG separador	18.10
KOENIG sonda conductora de ligadura	26.04
KOERTE separador	18.17, 18.26
KOGAN endospeculo	70.13
KONRICH tambor de estilización	88.05
KOOS bisturí vascular	40.29
KOOS cuchillo vascular	40.29
KRAUSE cierranudo para pólipos auriculares	44.09
KRAUSE cierranudo para pólipos nasales	46.13
KRAUSE punta de pinza	52.03
KRAYENBUEHL ganchito para nervio	40.26
KRESSNER pinza para tabique nasal	46.10
KROENLEIN pinza hemostática	12.11
KRONECKER aguja de ligadura	26.02
KUEMMEL separador abdominal	18.19
KUENTSCHER clavo para el fémur	36.04, 36.05
KUENTSCHER clavo para húmero y tibia	36.06
KUENTSCHER dilatador para el fémur	33.18
KUENTSCHER empujador de clavos	33.19
KUENTSCHER extractor de clavos	33.19
KUENTSCHER punzón medular	33.18
KUHNT legra para la córnea	42.06

L	
LABORDE dilatador traqueal	54.02
LACK abajalengua	48.03
LAFORCE adenótomo	46.28
LAFORCE instrumento para cuerpos extraños	42.06
LAHEY (SWEET) pinza para el conducto biliar	12.22
LAHEY pinza para agarrar bocio	54.04
LAHEY pinza para el conducto biliar	12.22
LAHEY separador	18.12
LAHEY separador para duramadre	40.05
LAMBOTTE mini osteótomo	32.36
LAMBOTTE osteótomo	32.36
LAMBOTTE periostótomo	32.45
LAMBOTTE pinza para chalazión	43.06
LAMBOTTE pinza para huesos	32.15
lámpara frontal	02.05
LANCASTER blefarostato	42.03
LANDAU espéculo vaginal	70.13
LANDOLT cureta maleable	40.25
LANDOLT enudeador maleable	40.25
LANDOLT ganchito maleable	40.25
LANDOLT mango de bisturíes micro bayoneta	06.08
LANDOLT pinza para sacar tumores	40.18
LANDOLT REULEN cureta	40.25
LANDOLT REULEN ganchito	40.25
LANDOLT REULEN raspador	40.25
LANDOLT separador para espéculos	40.23
LANE (PAUCHET) pinza para campos	14.04
LANE destornillador	33.20
LANE palanca para huesos	32.56
LANE pinza clamp estomacal	64.11
LANE pinza de disección	10.05
LANE pinza para huesos	32.16
LANGE HOHMANN elevador para huesos	32.54
LANGÉ punta de pinza	52.03
LANE separador	18.03
LANGENBECK cuchillo de resección	06.10
LANGENBECK cuchillo para lóbulos	06.11
LANGENBECK cureta auricular	44.08
LANGENBECK dedal	48.12
LANGENBECK elevador	32.46, 32.49
LANGENBECK GREEN separador	18.10
LANGENBECK KOCHER separador	18.15
LANGENBECK MANNERFELDT separador	18.25
LANGENBECK periostótomo	32.46
LANGENBECK pinza para huesos	32.15
LANGENBECK porta aguja	24.07

LANGENBECK separador	18.10, 18.13, 18.14
LANGENBECK separador mini	18.10
LANGENBECK sierra a dedo	33.03
lanza-polvo	44.05
laringoscopia	04.05, 04.06, 52.05, 52.06
LAWRENCE pinza hemostática y de ligadura	12.19
LE MEE abajalengua con aspiración	48.03
LEBSCHÉ cincel de esternón	32.38
leche para instrumentos	88.23
LEE fórceps obstétrico	72.02
LEECH WILKINSON cánula intra uterina	70.30
LEFORT bujía dilatadora uretral	66.08
legra	32.47, 32.50, 32.51, 40.27, 42.06, 74.02
legra para la córnea	42.06
legra para lupus	74.02
LEGUEU espátula vesical	66.03
LEGUEU separador vesical	66.04
LEKSELL (STILLE) pinza gubia	32.09
LEKSELL pinza gubia	32.09
LEMMON aproximador del esternón	56.12
LEMPERT cucharilla cortante	32.29
LEMPERT elevador	44.19
LEMPERT pinza gubia	32.04
LEMPERT separador	18.29
LERCHE pinza de disección	10.05
LERICHE pinza hemostática	12.12
LERICHE separador abdominal	18.19
LESTER pinza de fijación	43.03
LEVINSON aguja para cuerpos extraños	42.06
LEWIN pinza para huesos	32.19
LEXER baby tijera	08.04
LEXER cincel	32.36, 32.37
LEXER cincel para esponjosa	32.37
LEXER gubia	32.36, 32.37
LEXER mini cincel	32.36
LEXER mini gubia	32.36
LEXER osteótomo	32.37
LEXER tijera	08.04
LEYLA sostén de separadores y espéculos	40.10 - 40.14
LICHTENBERG porta aguja	24.08
LICHTWITZ aguja para el seno maxilar	46.13
LICHTWITZ trócar para el seno maxilar	22.03
ligador aspirador hemorroidal	68.10
ligador para hemorroides	68.09
lima nasal	46.20, 46.21
lima para el seno	46.20, 46.22
lima para huesos	32.59, 46.20
lima para uñas	74.04
limpia-canal para tornillos perforados	33.23
LISTER (sinus) pinza para medicación	16.04
LISTER BURCH blefarostato	42.03
LISTER tijera para vendajes	08.20
LISTON cuchillo de amputación	06.10
LISTON pinza cortante para huesos	32.13
LITTAUER pinza auricular	44.10
LITTAUER pinza depilatoria	43.10
LITTAUER pinza para pólipos nasales	46.06
LITTAUER tijeras para ligadura	08.18
little joker periostótomo	32.46
LITTLE separador	18.12
LITTLE tijera perforada	08.04
LITTLEWOOD pinza para tejido	64.04
llave cardánica para tuercas	34.03
llave para mandril de tres mordazas	33.07
llave para tornillos DHS	34.07
llave para tuercas	34.03
LLOYD DAVIS pinza para anastomosis	64.08
LLOYD DAVIS protoscopia	68.04
LLOYD DAVIS rectoscopia	68.04
LLOYD DAVIS pinza de biopsia	68.07
LLOYD DAVIS sigmoidoscopia	68.04
LLOYD DAVIS tijera rectal	08.16
LLOYD empujador de clavos para el cuello del fémur	34.11
LLOYD empujador y extractor	33.19
LOCKHART MUMMERY sonda	20.04
LOCKLIN tijera para plastia	08.07
LOCKWOOD ALLIS pinza para coger intestinos	64.03
LOCKWOOD pinza para coger intestinos y tejidos	64.03
LOGAN separador	18.26
LORDAN pinza para chalazión	43.06
LORENZ tijera para vendajes	08.21
LORNA (EDNA) pinza para campos	14.03
LORTAT JACOB sostén porta-instrumentos	88.23

LOVE GRUENWALD pinza para laminectomía	40.17
LOVE separador para raíz de nervio	40.06
LOVELACE pinza hemostática	12.10
LOVELACE pinza pulmonar	56.13
LOWER pinza para el conducto biliar	12.23
LOWMAN clamp para huesos	32.22
LOWMAN HÖGLUND clamp para huesos	32.22
LUBET BARBON pinza para pólipos nasales	46.06
LUC pinza cortante nasal	46.08
LUCAE aguja de paracétesis	44.07
LUCAE diapasón	44.05
LUCAE gancho abotonado	44.09
LUCAE martillo	32.41
LUCAE pinza auricular	44.09
LUER cánula traqueal	54.03
LUER KOERTE cuchara para cálculos biliares	62.04
LUER pinza gubia	32.03
LUER pinza hermorroidal	68.08
LUER separador	18.03
LUIKART BILL tractor para fórceps obstétrico	72.04
LUIKART fórceps obstétrico	72.03
LUNDSGAARD esclerótomo 12 cm	42.06
LUNIATSCHEK obturador de gaza	50.03

M	
macho	33.08
macho para tornillos DHS	34.07
MAGILL pinza para introducir catéteres	04.04
MAGILL tubo de aspiración	04.03
MAIER pinza para pólipos	16.02
MAINGOT pinza intestinal	10.10
MAINGOT pinza para histerectomía	12.30
MAISONNEUVE uretrótomo	66.04
MALIS separador cerebral	18.61
mandril Jacobs	33.07
mandril para catéteres	66.05
mango con cierre rápido	33.08
mango con mandril dental	33.08
mango con mandril Jacobs	33.06
mango de bisturíes	06.02 - 06.04, 06.08
mango de bisturíes micro forma bayoneta	06.08
mango de cincel intercambiable	32.33
mango de destornillador acción rápida	34.13
mango de espejos laringeos	52.07
mango para machos	33.08
mango para sierras de hilo	40.06
mango para trefinas cutáneas	74.03
mango universal	52.03
MANNERFELDT espátula doble	18.25
MANNERFELDT gancho agudo	18.24
MANNERFELDT separador	18.24, 18.25
MANNERFELDT separador mango con resorte	18.25
MANNERFELDT separador para tendones	18.25
mano de plomo	32.22
marcador	42.11
MARKHAM MEYERDING separador	18.38
MARKWALDER pinza gubia	32.13
MARQUARDT pinza gubia	32.11
MARSHIK pinza para amígdalas	50.05
MARTEL pinza para el pericráneo	12.10
martillo de percusión	02.10, 02.11
martillo diapasón	34.04
martillos y mazos	32.40 - 32.44
MARTIN histerómetro	70.22
MARTIN pelvimetro	72.05
MARTIN pinza para cartilagos	32.20
MARTIN pinza para coger el cuello del útero	70.17
MARTIN pinza para curaciones	16.06
MARTIN separador	18.18
MARTINI cureta doble	32.32
MASING periostótomo	46.17
Mass. Gen. Hospital porta aguja	24.06
MASSON porta aguja	24.05
MASTIN pinza muscular	54.04
MATHIEU espéculo rectal	68.03
MATHIEU pinza para cuerpos extraños	66.04
MATHIEU porta aguja	24.08
MATHIEU separador	18.03
MATSON ALEXANDER periostótomo	32.48
MATSON periostótomo	32.48
MAUNDER garrote de madera	48.12
MAY oftalmoscopia	02.07
MAY oto-oftalmoscopia	02.07
MAYFIELD pinza gubia	32.11

MAYO (HARRINGTON) tijera	08.03
MAYO ADAMS separador	18.30
MAYO BLAKE pinza para cálculos biliares	62.02
MAYO clip porta-instrumentos	28.02
MAYO cucharilla para cálculos biliares	62.04
MAYO GUYON pinza para pedículo renal	12.24
MAYO HEGAR porta aguja	24.04
MAYO NOBLE tijera	08.04
MAYO pinza modelo ruso	10.06
MAYO ROBSON pinza intestinal	64.07
MAYO sonda para cálculos renales	62.04
MAYO STILLE tijera	08.03
McCREA bujía dilatadora uretal	66.08
McCULLOUGH pinza para estrabismo	42.16
McDONALD elevador	32.50
McGEE gancho	44.18
McGEE pinza para doblar alambre	44.12
McGIVNEY (SCHÜTZ) ligador para hemorroides	68.09
McGIVNEY pinza agarradora para hemorroides	68.08
McGUIRE tijera corneal	09.02
McINDOE pinza	10.07
McINDOE pinza cortante para huesos	32.14
McINDOE tijeras para cartilago	08.15
McINTOSH laringoscopia	04.05
McIVOR abre-boca	48.08
McKENTY elevador para tabique nasal	46.15
McKENZIE bloque para agrafes	40.03
McKENZIE perforador	33.05
McKENZIE pinza para poner grapas	40.02
McKISSOCK tijera para duramadre	08.15
McLAUGHLIN placa para el cuello del fémur	36.07
McLEAN fórceps obstétrico	72.03
McLEAN TUCKER LUIKART fórceps obstétrico	72.03
McPHERSON pinza para ligaduras	43.05
MEAD martillo	32.42
MEAD pinza gubia	32.02
medidor de profundidad para tornillos óseos	33.25
Med-i-Tape cinta en colores para identificar instrum.	88.10
MEEKER pinza hemostática y pasahilos	12.19
MELLINGER AXENFELD blefarostato	42.02
MELLINGER blefarostato	42.02
MENGHINI aguja para la punción del hígado	22.05
MENGHINI jeringa de aspiración	22.05
MENGHINI trócar para agujas de punción meniscótomo	22.05
MERCEDES separador torácico	32.58
METZENBAUM fino tijera	56.08
METZENBAUM porta aguja	08.05
METZENBAUM tijera	24.06
METZENBAUM tijera	08.05, 08.06
MEYER pinza de reducción	32.21
MEYERDING separador	18.12, 18.21, 18.38, 18.63
MEYHOEFER cucharilla para chalazión	42.08
MICHEL agrafes	26.08
MICHEL espejo postrinoscópico	46.05
MICHEL pinza combinada para agrafes	26.07
MICHEL pinza para poner grapas	26.07
micro mosquito pinza	12.04
micro pinza hemostática	12.14
micro tijera	09.04
MIDDELDRORFF separador	18.16
MIDDELDRORFF separador abdominal	18.22
MIDDLETON JANSEN pinza cortante	46.12
MIKULICZ pinza de peritoneo	12.26
MIKULICZ separador	18.18
MILAN cureta uterina de biopsia	70.24
MILLIN pinza capsular	66.02
MILLIN pinza para lóbulo anterior.	66.02
MILLIN separador vesical	66.04
MILLIN tubo de aspiración	04.03
mini cincel	32.36
mini contenedor	88.19
mini elevador para huesos	32.55
mini gubia	32.36
mini lámpara frontal	02.06
mini osteótomo	32.36
MISKIMON separador cerebral	18.30
MIXTER baby pinza hemostática	12.21
MIXTER O'SHAUGHNESSY pinza	12.22
MIXTER pasahilos	12.20
MIXTER pinza hemostática y bronquial	12.21
MIXTER pinza hemostática y pasahilos	12.22
MIXTER pinza para cálculos biliares	62.02
MOCK aguja para irrigación con heparina	22.04
MOELTGEN goniómetro	02.11
molino para huesos	32.60
MOLLISON separador	18.29, 18.34

MOORE cuchara para cálculos biliares	62.02
MOORE perforador a mano	33.04
MOORFIELD pinza para sutura	43.05
MORITZ SCHMIDT abajalengua	48.03
MORRIS separador	18.18
MORSE FAVALORO separador de castillas	56.09
mosquito pinza hemostática	12.04, 12.09
motor a mano eléctrico	33.07
MOYNIHAN pinza clamp	12.23
MOYNIHAN pinza hemostática	12.07
MOYNIHAN pinza para campos	14.04
MOYNIHAN sonda para cálculos biliares	62.03
MUCK cuchillo para periostio	44.19
MUELLER blefarostato	42.03
Munich cureta para biopsia	70.23
MURDOCK blefarostato	42.02
MURPHY LANE elevador doble 'bone skid'	32.52
MURPHY separador	18.12
MUSEUX pinza uterina	70.17, 70.19
MYERS desoblitorador	20.03
MYLES cánula de irrigación	46.29
MYLES pinza cortante nasal	46.10

N

NABATOFF sonda para varices	20.03
NAEGELE forceps obstétrica	72.02
NAGER aguja para amígdalas	50.03
NAGER separador paladar	50.02
NATIONAL HOSPITAL martillo de percusión	02.11
NAUNTON MORGAN porta aguja	24.07
navaja hoja plana/concava	06.13
NEFF meniscótomo	32.58
NEGUS pinza para amígdalas	12.15
NEIVERT porta aguja	24.02
NEIVERT separador doble	46.25
NELATON sonda acanalada	20.02
NELSON aguja de ligadura	26.02
NELSON pinza	10.09
NELSON trócar torácico	22.03
neodisher® IP spray	88.23
neodisher® IR detergente	88.23
NICOLA cureta para hipofisectomía	40.24
Nippon pinza hemostática	12.07
NISSEN pinza para colédoco y cístico	12.21
NORFOLK y NORWICH separador	18.36
NORTHBENT (SPENCER) tijera para ligadura	08.17
NORTHFIELD separador	18.35
NOTO pinza para pólipos uterino	70.20
NOVAK cureta aspiradora	70.23
NOYES pinza para pólipos nasales	46.07
NOYES tijeras para iris	09.02
NUGENT pinza oftálmica	42.16

O

obturador de gaza	50.03
OCHSNER pinza para ligadura	26.07
OCHSNER sonda para cálculos biliares	62.02
OCHSNER trócar torácico	22.03
O'CONNOR gancho para iris	42.07
OETTINGEN separador oftalmoscopia	18.60
OLDBERG pinza para laminectomía	02.07
OLIVECRONA sierra de hilo	40.18
OLIVECRONA cuchillo de trigémino	40.06
OLIVECRONA diseccionador de duramadre	40.09
OLIVECRONA espéculo cerebral	40.07
OLIVECRONA pinza gubia	40.15
OLIVECRONA TOENNIS pinza para grapas	32.04
OLLIER separador	40.03
OLSEN HEGAR porta aguja	18.16
OMBREDANNE martillo	24.08
OMBREDANNE pinza para sujetar tejido osteótomo	32.40
O'SULLIVAN O'CONNOR espéculo vaginal	64.03
O'SULLIVAN O'CONNOR separador abdominal	32.33 - 32.88
OTIS bujía dilatadora uretal	70.13
OTIS uretrótomo	18.43
oto-oftalmoscopia	66.08
otoscopia	66.04
OVERHOLT baby pinza hemostática	02.07
OVERHOLT GEISSENDERFER pinza pasahilos	02.06
OVERHOLT MIXTER pasahilos	12.15
OVERHOLT MIXTER pasahilos	12.16
OVERHOLT periostótomo	12.21
OVERHOLT periostótomo	32.48

OVERHOLT pinza	12.16
----------------	-------

P

Pacific pinza para biopsia uterina	70.27
palanca para falanges	32.51
palanca para huesos	32.56
PALMER clavo para huesos	36.07
PALMER empujador para clavos	34.12
pañó de esterilización	88.10
PAPAVERO CASPAR espéculo	40.23
PARHAM cinta para huesos	32.22
PARHAM tensor de cintas	32.22
PARK blefarostato	42.03
PARKER bisturí fino	06.10
PARKER MOTT separador	18.02
PARKER separador	18.02
PARTSCH cincel	32.34
PARTSCH gubia	32.34
PASSOW cincel hemostático	44.19
PATON diseccionador corneal	42.06
patrón maleable para doblar placas para huesos	33.22
patrón para posicionar placas óseas	34.06
PAUCHET pinza para campos	14.04
PAUFIQUE cuchillo para queratoplastia	42.06
PAUFIQUE pinza para ligaduras	43.05
PAYR baby pinza clamp intestinal	64.12
PAYR sonda conductora de ligaduras	26.04
PEAN Nippon pinza hemostática	12.07
PEAN pinza hemostática	12.08, 12.11
PEDERSON espéculo vaginal	70.02
PEERS BERTRAM pinza para campos	14.03
PEET pinza para espigas	10.13
PELMANN pinza para pólipos pelvimetro	16.04
PELVIMETRO	72.05
PENFIELD diseccionador de duramadre	40.08
PENNINGTON pinza hemostática	12.10
PENNYBACKER pinza gubia	32.06
PERCY retractor para amputación perfore-tráneo	33.02
perforador con guía telescópica para taladro filiforme	33.05
perforador inicial	40.04
perforador para clavos intramedulares	33.18
perforador para huesos cuadrado	33.10
perforador para uñas	33.03
perforador plano	33.05
perforadores	33.04 - 33.06, 33.10
periostótomo	32.45 - 32.52, 46.16, 46.17
PERTHES escariador	33.10
PERTHES perforador	33.10
PESTALOZZA cureta para aborto	72.06
PETRI cubeta	88.04
PHANEUF pinza para el peritoneo	12.27
PHILLIPS destornillador	33.20
pick para la cirugía de oído	44.17, 44.18
pie de rey	02.12, 42.11
PIERCE trócar para el seno maxilar	22.02
PIFFARD cureta para lupus	74.02
PINARD estetoscopio	02.09
pinza apra coger intestinos y tejido	64.02, 64.03
pinza traumática para coger intestinos y tejidos	64.03
pinza auricular	44.10 - 44.13, 44.15, 44.16
pinza auricular micro mini	44.14
pinza auricular mini	44.16
pinza auricular para doblar alambre	44.12
pinza auricular para la cabeza del martillo	44.13
pinza auxiliar para la esterilización	28.02
pinza capsular	43.03, 43.04
pinza capsular traumática	66.02
pinza capsular retropubica	66.02
pinza cierratubo	12.30, 12.31
pinza clamp bronquial	12.18, 56.13, 56.14
pinza clamp de presión progresiva	12.09
pinza clamp estomacal	64.11
pinza clamp intestinal	64.12
pinza clamp uterina	72.05
pinza combinada para grapas	26.07
pinza con rodillos	12.32
pinza corta-alambre	33.16 - 33.18
pinza cortante nasal	48.08 - 46.10
pinza cortante para huesos	32.13, 32.14
pinza cortante para laminectomía	40.18 - 40.20

Índice alfabético

pinza cortante para tabique nasal	46.12	pinza para esponjas	16.02 - 16.04	placa de reconstrucción pelviana	36.14
pinza cuticular	74.04	pinza para estabismo	42.16	placa espinal dorsal lumbar	36.23
pinza de anastomosis	56.16	pinza para extraer garrapatos	10.13	placa femoral anatómica distal-lateral	36.21
pinza de aurícula	56.16	pinza para extraer taladros filiformes	33.14	placa femoral anatómica proximal-lateral	36.21
pinza de avanceamiento	43.07	pinza para falanges	32.20	placa humeral epicondilar	36.22
pinza de biopsia rectal	68.06, 68.07	pinza para hemorroides	68.08	placa ósea acodada de compresión	36.15
pinza de biopsia uterina	70.24 - 70.28	pinza para histerectomía	12.27, 12.28, 12.30	placa ósea ancha de alargamiento	36.20
pinza de columela	46.26			placa ósea ancha de compresión	36.14
pinza de disección	10.02 - 10.11	pinza para huesos	32.15, 32.16, 32.18 - 32.20	placa ósea cobra	36.20
pinza de disección atraumática	11.03 - 11.04			placa ósea de compresión dinámica	36.08
pinza de disección extra ligera	11.06	pinza para implantar lentes	42.18	placa ósea de sostén condileo	36.20
pinza de disección micro	10.03, 10.04, 11.02, 11.05	pinza para introducir catéteres	04.04	placa ósea de sostén forma L	36.23
		pinza para iris	42.12 - 42.15, 42.17	placa ósea estrecha de alargamiento	36.20
pinza de disección modelo USA	10.02			placa ósea estrecha de compresión	36.14
pinza de disección para oídos	44.09	pinza para la clavícula	32.21	placa ósea forma de cuchara	36.22
pinza de enderezar tabique nasal	48.12	pinza para la extracción de taladros	33.14	placa ósea forma de trébol	36.22
pinza de entropión	43.07	pinza para laminectomía	40.18	placa ósea forma T	36.17, 36.22
pinza de estrabismo	42.16	pinza para ligadura de titanio	43.05	placa ósea mini	36.16, 36.17
pinza de etmoide	46.07	pinza para ligaduras	26.07, 43.05	placa ósea mini para dedos	36.16
pinza de excisión	64.09	pinza para los bordes de la herida	26.07	placa ósea para dedos	36.16
pinza de extracción de tendones	32.24	pinza para magullar tabique	46.10	placa ósea para mini fragmentos	36.17
pinza de fijación	43.03	pinza para medicación	16.04	placa ósea para multi fragmentos	36.16
pinza de hipofisectomía	40.18	pinza para parametrio	12.29	placa ósea para pequeños fragmentos	36.17
pinza de histerectomía	12.27	pinza para pasar tendones	32.23, 32.24	placa ósea proximal para húmero	36.22
pinza de pedículo renal	12.24, 12.25	pinza para pericráneo	72.05	placa ósea radial	36.22
pinza de pericráneo	12.10	pinza para peritoneo	12.26	placa ósea semi tubular	36.14
pinza de peritoneo	12.26, 12.27	pinza para pólipos	16.02, 16.04 - 16.06	placa ósea un cuarto de tubo	36.16
pinza de picos chatos	33.14 - 33.16			placa ósea un tercio de tubo	36.16
pinza de reducción	32.20, 32.21	pinza para pólipos laríngeos	52.02	placa para el fémur	36.18
pinza de relojero	10.11	pinza para pólipos nasales	46.06, 46.07	placa para extender la piel	06.11
pinza de sostén durante biopsia	68.07	pinza para pólipos uterinos	70.20	placa para la espina cervical	36.24
pinza depilatoria	43.10	pinza para poner agrafes	26.07	placa para osteotomías intertrocanterías del adulto	36.18, 36.19
pinza gubia	32.02 - 32.13	pinza para poner grapas	40.02	placa para párpados	42.03
pinza hemostática	12.02 - 12.30	pinza para poner grapas para la sutura cerebral	40.02	placa tibial	36.22
pinza hemostática para el cuero cabelludo	40.04	pinza para poner y quitar grapas	40.04	placa tibial anatómica distal-medial	36.21
pinza hemostática y pasahilo	12.16	pinza para retorcer alambre	33.15	placa tibial anatómica para fibula	36.21
pinza histerólabo	70.21	pinza para sacar la piel	46.26	placa tibial anatómica proximal-lateral	36.21
pinza intestinal	64.04 - 64.12	pinza para sacar la próstata	66.02	placa tibial lateral	36.23
pinza laringo-, bronco-, esofagoscópica	52.04	pinza para sacar tendones	32.25	placa trapecoidal para osteosíntesis	36.24
pinza micro laríngea	52.04	pinza para sacar tumores	40.18	pegador para clavos intramedulares	34.10
pinza modelo ruso	10.06	pinza para sacuestros	32.21	PLESTER cucharilla lobar	44.17
pinza muscular	43.02, 43.07, 54.04	pinza para sostener glans y prepucio	66.05	PLESTER separador	18.28, 18.29
		pinza para sostener huesos	32.20, 21.21	PLESTER tubo de aspiración	44.06
pinza nasal	46.05, 46.06	pinza para sostener intestino y tejido	64.03, 64.04	PLEY blefarostato	42.03
pinza nasofaríngea cortante	46.26	pinza para sostener placas pequeñas	33.21	POLITHER insuflador de aire	44.06
pinza para aborto y placenta	72.06	pinza para sujetar huesos	32.17	POLITZER aguja de paracéntesis	44.07, 44.08
pinza para agafes	26.08	pinza para sujetar tejido	64.03	POLITZER cuchillo auricular	44.08
pinza para agarrar bocio	54.04	pinza para sutura	43.05	ponza cortante para laminectomía	40.17
pinza para agrafes	26.07	pinza para sutura conoescleral	43.05	POOLE tubo de aspiración	40.02
pinza para amígdalas	12.14, 12.15, 50.05	pinza para suturas	10.11	POPPEL tubo de aspiración	40.15
		pinza para tabique nasal	46.07, 46.10	porta alodón	20.06, 20.07
pinza para anastomosis	56.15, 64.08	pinza para tabique y vomer	46.07, 46.08, 46.10	porta cráneo ajustable	40.04
pinza para arrancar uñas	33.03			porta grapas para sutura cerebral	40.03
pinza para avanceamiento	43.02	pinza para taponamiento	52.02	porta ligaduras obotonado	40.26
pinza para biopsia uterina	70.24 - 70.28	pinza para tapones	16.02	porta aguja	24.02 - 24.12
pinza para cálculos biliares	62.02	pinza para tejido	12.11	porta aguja para zurdos	24.02 - 24.04
pinza para cálculos renales	62.05, 62.06	pinza para torcer alambre	33.15	POTTS DE MARTEL tijera vascular	08.10
pinza para cámara anterior	43.02	pinza para tracoma	43.07	POTTS SMITH pinza de disección	10.02
pinza para campos	14.02 - 14.04	pinza para tumores	11.05	POTTS SMITH tijera vascular	08.11
pinza para capsulo-iridectomía	42.11	pinza para uñas	74.04	POVIDENCE HOSPITAL pinza hemostática	12.06
pinza para cartílagos	32.20	pinza para yesos	30.04	PRATT dilatador uterino	70.16
pinza para chalazión	43.06	pinza pituitaria	40.09	PRATT espéculo rectal	68.02
pinza para coger amígdalas	50.04, 50.05	pinza plana paralela y corta-alambre	33.15	PRATT pinza hemostática	12.10
pinza para coger el cuello del útero	70.18 - 70.20	pinza porta tapones	52.02	PRATT gancho cístico	68.06
pinza para coger el cuello del útero	70.20	pinza porta tornillos	33.21	prensa para doblar placas	33.22
pinza para coger intestinos	64.02	pinza protectora	40.04	PRICE THOMAS pinza bronquial	56.14
pinza para coger jeringas	28.02	pinza pulmonar	56.13	PRINCE pinza muscular	43.02
pinza para coger órganos	64.04	pinza sacabocado nasal	46.11, 46.12	PRINCE tijera para amígdalas	08.10
pinza para coger tendones	32.23 - 32.25	pinza sacabocado para discos intervertebrales	40.21, 40.00	protoscopio	68.04, 68.05
pinza para colédoco y cístico	12.21	pinza tira-lengua	48.04	protector de alas	46.25
pinza para conducto biliar	12.22	pinza torácica	12.17	protector de tejido	33.26
pinza para cortar huesos	32.13, 32.14	pinza universal para agarrar instrumentos	28.02	protector de tejido y guía-broca	33.26
pinza para craneotomía	40.07	pinza uro tangencial	12.25	punta de destornillador	33.20, 34.13
pinza para cueros extranjeros uretrales	66.04	pinza uterina	70.17 - 70.20	puntas de pinzas intercambiables	52.03, 70.27, 70.28
pinza para curaciones	16.06	pinzas auriculares	44.10 - 44.16		
pinza para curaciones antiséptica	88.04	pinzas autocentrantes para huesos	32.18	punzón para clavos intramedulares	33.18
pinza para desperdicios	28.02	pinzas de coagulación bipolar	92.04 - 92.05	PUTTI lima para huesos	32.59
pinza para doblar placas óseas	33.21, 33.22	pinzas de coagulación monopolar	92.03	PYE SMITH (HARRISON) pinza para esterilización	28.02
pinza para el conducto biliar	12.23	pinzas para enderezar tabique	48.12		
pinza para el lóbulo anterior	66.02	pinzas para esponjas	16.04		
pinza para el peritoneo	12.27	pinzas para huesos	32.19		
pinza para el rectus	43.02	PIPER fórceps obstétrico con tractor	72.04		
pinza para el seno maxilar	46.12	placa cervical espinal	36.23		
pinza para enderezar tabique nasal	46.25	placa cervical recta	36.23		
pinza para entrelazar tendones	32.24	placa condilea con agujeros de compresión	36.09		
pinza para estenoides	46.07	placa condilea de compresión	36.15		
pinza para espigas	10.12, 10.13	placa de guía condilar	34.06		

Índice alfabético

Q	
querátomo	42.04
QUERVAIN elevador	32.50
QUINBY tijera para encías	08.19
QUIRE elevador para cuerpos extranjeros	44.10
QUISLING martillo intranasal	32.44

quistótomo	42.07
quita hojas de bisturíes	06.05

R

RADOLF pinza para arrancar uñas	33.03
RAGNELL DAVIS separador	18.05
RALK perforador	33.06
RAMEL aguja de punción para biopsia	22.04
RAMPLEY pinza para esponjas	16.03, 16.04
RAMSAY pinza estriada	10.06
RAMSAY pinza para esponjas	16.03
RANDALL cureta aspiradora para biopsia uterina	70.23
RANDALL pinza para cálculos renales	62.05
RANEY pinza hemostática para cuero cabelludo	40.04
RANEY pinza para poner y quitar raquíotomo	40.04, 32.38
raspador	32.45 - 32.52
raspador para hipofisectomía	40.25, 40.27
RAY cureta pituitaria	40.24
RECAMIER cureta uterina	70.32
retoscopia	68.04
regla de medir	02.12
REICHERT depresor de epiglottis	52.02
REILL alicata para cortar alambre	33.17
REILL pinza de reducción	32.20
REINER cuchillo para yeso	30.04
REINER jeringa auricular	44.06
repuestos para containers de esterilización	88.13, 88.24
RESANO pinza para anastomosis	64.08
retractor de alas	46.25
retractor para amputación	33.02
REVERDIN (ALBARRAN) aguja de ligadura	26.03
REVERDIN separador abdominal	18.06
REYNOLDS (JAMESON) tijera	08.07
RHEINSTAEDTER cureta uterina con irrigación	70.24
RIBBON separador	18.05
RICARD separador abdominal	18.59
RICHARDSON EASTMAN separador	18.04
RICHARDSON grip separador	18.04
RICHTER HEATH pinza para agrafes	26.08
RIGBY separador rectal y vaginal	18.56
RING abajalengua	48.11
riñonera	88.03
RITCHEY empujador de clavos	34.11
RITTER HALLE dilatador para seno frontal	46.29
ROBB diseador	56.18
ROBERTS pinza hemostática	12.18
ROBIN MASSE separador abdominal	18.60
ROBIN pinza para campos	14.04
ROCHARD separador	18.61
ROCHESTER CARMALT pinza hemostática	12.09
ROCHESTER OCHSNER pinza hemostática	12.08
ROCHESTER PEAN pinza hemostática	12.08
ROEDER cierranudo	50.03
ROEDER pinza para campos	14.03
ROETTGEN RUSKIN pinza gubia	32.08
ROGER elevador para el tabique nasal	46.16
ROGERS pinza para parametrio	12.29
ROGGE pinza auxiliar para esterilizar	28.02
ROLLET cinceal para extirpación	42.06
ROLLET separador	42.07
rompe hojas	06.07
rompecráneo	32.38
ROSE gancho traqueal	54.03
ROSEN aguja para la cirugía del oído	44.17, 44.18
ROSENBERG punta de pinza	52.03
ROSER KOENIG abrebooca	48.05
ROSS separador de aorta	56.13
ROUX separador	18.03
ROWE pinza sostenedora de huesos	48.12
ROY CAMILLE placa cervical espinal	36.23
ROY CAMILLE placa espinal dorsal lumbar	36.23
RUBIN pinza para magullar tobique	46.10
RUDD ligador para hemorroides	68.09
RUMEL pinza torácica	12.17
RUSKIN LISTON pinza cortante para huesos	32.14
RUSSEL DAVIS abajalengua	48.09
RYDEL SEIFFER diapasón	44.05
RYDER porta aguja	24.04, 24.05

S

SAALFELD saca comedones	74.02
saca comedones	74.02

saca-I.U.D. flexible grasper	70.21
SACHS descolador de duramadre	40.07
SACHS gancho para nervios	40.05
SACHS separador para la duramadre	40.08
SAENGER para aborto y placenta	72.06
SALENIUS meniscótomo	32.58
salpingógrafo	70.30
SANVENERO tijera	08.06
SAROT pinza bronquial	56.14
SAROT pinza clamp bronquial	12.18
SAROT porta aguja	24.07
SATINSKY clamp para vena cava	56.15
SATINSKY pinza para anastomosis	56.15
SATINSKY tijera torácica	08.16
SATO cuchillo corneal	42.05
SAUER blefarostato	42.02
SAUERBRUCH costótomo	56.03
SAUERBRUCH FREY costótomo	56.03
SAUERBRUCH pinza gubia	32.09
SAUERBRUCH pinza para desperdicios	28.02
SAUERBRUCH separador	18.20, 18.21
SAWTELL pinzas para amígdalas	12.14
SCAGLIETTI pinza gubia	32.10
SCHAEDEL (SHRADLE) pinza para campos	14.02
SCHAMBERG saca comedones	74.02
SCHAEDE cucharilla cortante	32.26
SCHAEDE pinza para coger órganos	64.04
SCHAEDE cánula oftálmica	43.08
SCHAEDE cuchillo para goniotomía	42.06
SCHNEIMANN punta de pinza	52.03
SCHPEPENS separador orbital hendido	42.08
SCHERBAK espéculo vaginal	70.12
SCHIMMELBUSCH tambor de esterilización	88.05
SCHINK dermatomo	06.11
SCHIOETZ tonómetro	43.09
SCHMEDEEN concótomo	46.10
SCHMID cánula vascular 3 mm	22.04
SCHMID espátula para la íntima	56.18
SCHMIEDEN PAYR sonda conductora	26.03
SCHMIEDEN sonda conductora	26.03
SCHMIEDEN TAYLOR tijera de duramadre	08.15
SCHNEIDER periostótomo	32.46
SCHNEIDER SAUERBRUCH periostótomo	32.46
SCHNIDT (BOETTCHER) pinza para amígdalas	12.14
SCHOENBORN separador para tiroide	54.04
SCHOENBURG pinza para tejido	64.04
SCHROEDER pinza para el cuello del útero	70.18, 70.19
SCHROEDER pinza uterina	70.18, 70.19
SCHUBERT pinza para biopsia uterina	70.24
SCHUKNECHT cuchillo circular	44.17
SCHUKNECHT tubo de aspiración	44.06
SCHULTZE salpingógrafo	70.30
SCHULZE BERGMANN espéculo rectal	68.02
SCHUMACHER pinza para biopsia uterina	70.25
SCHUMACHER punta de pinza	52.03
SCHUMACHER tijera para cordón umbilical	08.14
SCHUMACHER tijera para esternón	56.03
SCHWEIGGER pinza capsular	43.04
SCOVILLE cureta para disco roto	32.29
SCOVILLE HAVERFIELD separador	18.62
SCOVILLE pinza para disco roto	32.29
SCOVILLE separador de raíz de nervio	40.06
SCOVILLE separador para laminectomía	18.62
searador para tendones	32.59
SEBILAU elevador	32.50
SEDILLOT periostótomo	32.45
SEGOND bisturí para fibroma	70.29
SEIDEL espéculo vaginal	70.11
SEIFFERT punta de pinza	52.03
SELLHEIM separador para la salida de la cabeza	72.07
SELLORS aproximador de castillas	56.12
SEMB periostótomo de castillas	32.48
SEMB pinza bronquial	56.14
SEMB pinza cortante para huesos	32.14
SEMB pinza gubia	32.10
SEMB pinza para huesos	32.15
SEMKEN pinza de disección	10.07
SEMM espéculo	70.06
SENN GREEN separador	18.10
SENN MILLER baby separador	18.05
SENN separador	18.05
SENNING (Suecia) porta aguja	24.04
sensímetro	02.11
separador	18.02 - 18.64, 40.10 - 40.14, 56.04 - 56.11
separador abdominal	18.43 - 18.60

separador alar	46.24
separador de castillas	56.04 - 56.11
separador de duramadre	40.05
separador de esternón	56.09
separador de incisión inicial	18.64
separador de labios y mejillas	48.04
separador de laminectomía	18.30, 18.31, 18.33, 18.35, 18.38, 18.40
separador de paladar	50.02
separador de párpados	18.08
separador de perineorrafia	70.13
separador de raíz de nervio	40.06
separador de rodilla	32.57
separador de tendones	18.12, 18.25, 32.59
separador espinal	32.57
separador lateral ginecológico	70.06
separador muscular	18.64
separador orbital	42.08
separador para abrir espéculos	40.23
separador para bocio	18.27, 18.28
separador para el atrio	56.11
separador para el saco lagrimal	42.03
separador para fistula	70.29
separador para hemilaminectomía	18.32, 18.33, 18.35, 18.38
separador para iris	42.07
separador para la cirugía de la mano	18.24, 18.25
separador para la duramadre	40.08
separador para la rodilla	32.56
separador para nervios	40.05
separador para úvula	50.02
separador para vagotomía	18.07
separador para yesos	30.04
separador pelviano	18.19
separador perineal	18.56
separador pilórico	64.04
separador prostático	66.02, 66.03
separador rectal	68.03
separador torácico	18.20, 56.04 - 56.11
separador traqueal	18.03, 54.02, 54.03
separador vertebral	40.16
separador vesical	66.03, 66.04
separador para tiroide	54.04
separador rectal y vaginal	18.56
separador para tiroide	12.03
separador para tiroide	33.02, 33.03
separador rectal y vaginal	30.02, 30.03
separador para tiroide	44.08
separador para tiroide	44.08
separador para tiroide	70.05
separador para tiroide	44.11
separador para tiroide	42.18
separador para tiroide	08.13
separador para tiroide	44.03
separador para tiroide	33.09
separador para tiroide	33.02, 33.03
separador para tiroide	30.02, 30.03
separador para tiroide	40.06
separador para tiroide	46.23
separador para tiroide	33.03
separador para tiroide	33.03
separador para tiroide	68.04
separador para tiroide	46.19
separador para tiroide	06.12
separador para tiroide	43.08
separador para tiroide	43.08
separador para tiroide	70.31
separador para tiroide	32.27
separador para tiroide	18.19
separador para tiroide	70.29
separador para tiroide	72.02
separador para tiroide	72.02
separador para tiroide	72.03
separador para tiroide	70.32
separador para tiroide	70.21
separador para tiroide	70.17
separador para tiroide	68.02
separador para tiroide	70.10
separador para tiroide	70.22
separador para tiroide	16.02
separador para tiroide	08.12
separador para tiroide	10.09

Índice alfabético

sinus pinza para medicación	16.04
SKENE pinza uterina	70.18
SLUDER BALLENGER amigdalótomo	50.07
SMELLIE gancho obstétrico	72.05
SMELLIE perfora-cráneo	72.08
SMILLIE meniscotómo	32.58
SMILLIE separador para rodillas	32.57
SMITH blefarostato	42.02
SMITH BUIE separador rectal	68.03
SMITH PETERSEN clavo para el cuello del fémur	36.07
SMITH PETERSEN cincel	32.35
SMITH PETERSEN gubia	32.35
SMITH PETERSEN pinza gubia	32.11
SMITH US Army tijera	08.20
SMITHWICK gancho para nervios	40.06
SNELLEN asa	42.09
SNELLEN pinza de entropión	43.07
SNITMAN separador	18.27
SOMER pinza histerólabo	70.21
sonda	20.02, 20.04
sonda auricular	20.02
sonda conductora de ligaduras	26.03, 26.04
sonda de cálculos renales	62.04
sonda de medición	44.19
sonda lagrimal	42.12
sonda para bocio	54.04
sonda para cálculos biliares	62.03
sonda para fistula	68.06
sonda para hipofisectomía	40.27
sonda para vórices	20.03
sonda trabecular	42.12
sondas y estiletes	20.02, 26.04
SÖNNENSCHEIN espéculo nasal	46.03
SPENCER tijera para ligaduras	08.17
SPENCER WELLS (CHANCE) pinza hemostática	12.09
SPENCER WELLS (JONES) pinza hemostática	12.09
SPRATT cucharilla cortante	32.26
SPURLING pinza para laminectomía	40.17
ST. MARKS separador perineal	18.56
ST. MARKS (LLOYD DAVIES) separador pelviano	18.19
St. MARTIN pinza para sutura	43.05
STACKE sonda auricular	20.02
STAUDE MOORE pinza uterina	70.18
STAUDE pinza para campos	14.04
St. CLAIR THOMSON cuchillo para vegetaciones aden.	46.28
STEINBACH mazo	32.43
STEINMANN davo para huesos	33.11
STEINMANN pinza para coger tendones	32.23
STELLBRINK pinza gubia	32.05
STERNBERG separador de labios	48.03
STEVENS gancho para el cristalino	42.07
STEVENS pinza para iris	42.13
STEVENS porta aguja	24.09
STEVENS tijera de tenotomía	08.08
STEVENSON blefarostato	42.03
STIEGLITZ (WILLIAMS) pinza para espigas	10.13
STILLE BARRAYA pinza de disección	10.09
STILLE cincel	32.35
STILLE cizalla para yesos	30.02
STILLE costótomo	56.02
STILLE gubia	32.35
STILLE HORSLEY pinza para cortar huesos	32.14
STILLE LISTON pinza para cortar huesos	32.14
STILLE LUER pinza gubia	32.08
STILLE osteótomo	32.35
STILLE perforador a mano	33.04
STILLE pinza de disección	10.02
STILLE pinza par el pedículo renal	12.24
STILLE RUSKIN pinza gubia	32.09
STILLE SHERMAN perforador	33.04
STONE pinza de disección	10.10
STONE WATT pinza intestinal	64.10
STRANDELL STILLE separador	18.10
STRATTE porta aguja	24.07
STRAUSS pinza cierra-pene	66.05
STRAUSS rectoscopio	68.04
STRUCK separador de costillas	56.10
STRUEMPEL pinza auricular	44.11
STRULLY tijera neuroquirúrgica	08.15
STRULLY tijera vascular	08.15
STRUYCKEN pinza nasal	46.10
Suecia porta aguja	24.04
supercut tijeras	08.01
SVEN JOHANSSON empujador para clavos	34.11
SWEET pinza para el conducto biliar	12.22
SWEET pinza para poner grapas	40.02
SYME aguja para aneurisma	26.02

SYPERT pinza gubia	32.12
SYSTRUNK tijera para hendir uñas	08.22
T	
TABB cuchillo forma de hoz	44.17
taladro filiforme	33.10
taladro para huesos	33.07
taladros	18.41, 33.04,
	33.07
	33.19
tallo-guía	88.05
tambor para esterilización	72.08
TARNIER cranioclasto	72.04
TARNIER fórceps obstétrico	88.04
tarro	02.10
TAYLOR martillo de percusión	10.07
TAYLOR pinza de disección	32.57
TAYLOR separador espinal	26.04
tenedor para ligaduras en la profundidad	33.13
tensor cierra-hilo	32.22
tensor de cintas óseas	33.13
tensor de hilo metálico	34.13
tensor de hilos para huesos	34.03
tensor de placas	33.23
terraja para tornillos perforados	72.04
THIERRY fórceps obstétrico	70.34
THOMAS cureta uterina	70.25
THOMAS GAYLOR pinza para biopsia uterina	66.03
THOMSON WALKER separador vesical	08.16
THOREK tijera pulmonar	46.02
THUDICHUM (GOLDSMITH) espéculo nasal	46.04
TIECK HALLE espéculo nasal	08.03, 08.06,
tijera corneal	08.08, 08.09,
	09.03
	74.04
tijera cuticular	08.04, 08.05
tijera de disección	08.08, 09.02,
tijera de iridectomía	09.03
	08.17
tijera de ligaduras	08.12
tijera de parametrio	08.16
tijera de pulmón (torácica)	08.13
tijera fistular	08.13
tijera ginecológica	08.13
tijera microlaringea	52.04
tijera nasal	08.06, 08.09
tijera neuroquirúrgica	08.15
tijera para alambre y chapa	08.19
tijera para amígdalas	08.10
tijera para cordón umbilical	08.14
tijera para cortar vendajes	08.20
tijera para duramadre	08.15
tijera para encías	08.18, 08.19
tijera para enucleación	08.08, 08.09
tijera para esternón	56.03
tijera para estrabismo	08.08
tijera para fistulas	08.13
tijera para hendir uñas	08.22
tijera para incisiones	08.10
tijera para iris	08.07, 09.02
tijera para la cirugía plástica	08.06
tijera para ligaduras	08.17, 08.18
tijera para plastia	08.07
tijera para preparaciones	08.13
tijera para preparaciones de nervios	08.14
tijera para tabique nasal	46.11
tijera para tendones	09.02
tijera para tenotomía	08.08
tijera para uñas	74.03
tijera para vendajes	08.20 - 08.22
tijera para yesos	08.21
tijeras para zurdos	08.02, 08.03,
	08.05, 08.07,
	08.20
tijera rectal	08.16
tijera torácica	08.16
tijera universal para alambre	08.19
tijera uterina	08.12
tijera vascular	08.10 - 08.12,
	09.04
tijeras	08.02 - 09.04,
	44.14
tijeras de enterotomía	08.17
tijeras micro y mini auriculares	44.11, 44.14
tijeras para episiotomía	08.14
tijeras para iris	08.07

tijeras 'supercut'	08.01 - 08.14,
	08.18, 08.20
tijera neuroquirúrgica	08.15
TILLEY pinza auricular	44.10
tirabuzón para fibroma	70.29
TISCHLER baby pinza para biopsia uterina	70.26
TISCHLER baby punta de pinza	70.27
TISCHLER KEVORKIAN pinza para biopsia uterina	70.28
TISCHLER KEVORKIAN punta de pinza	70.27
TISCHLER MORGAN Eppendorfer pinza de biopsia	70.28
TISCHLER MORGAN pinza de biopsia	70.26
TISCHLER MORGAN punta de pinza	70.27
TIVNEN pinza para coger amígdalas	50.05
TOBOLD abajalengua	48.03
TOBOLD porta-algodón laríngeo	20.06
TOENNIS ADSON tijera neuroquirúrgica	08.15
TOENNIS descolador de duramadre	40.07
TOENNIS pinza hemostática	12.18
TOENNIS porta aguja	24.07
TOHOKU pinza para campos	14.03
tonómetro	43.09
TOOK cuchillo corneal	42.05
tornillo cartilago	36.11 - 36.13
tornillo de compresión	36.09
tornillo de conexión para tornillos DHS	34.08
tornillo de distracción	18.41
tornillo de fémur dinámico	36.09
tornillo esponjosa	36.12, 36.13
tornillo perforado	36.11
torniquete para exsanguínea	02.05
TOTI fresa	33.09
TOWNLEY pie de rey	02.12
TOWNSEND KEVORKIAN pinza de biopsia uterina	70.27
TOWNSEND mini pinza de biopsia uterina	70.27
TOWNSEND pinza de biopsia	70.27
TOWNSEND TISCHLER baby pinza de biopsia	70.27
TOYNBEE espéculo auricular	44.02
tractor craneal	40.04
tractor para fórceps obstétrico	72.03, 72.04
TRAUBE martillo de percusión	02.10
TRELAT espéculo vaginal	70.06
trépano corneal	43.08
trépano cutáneo	74.03
TREHOWAN elevador para huesos	32.56
TREVES pinza de disección	10.03
trócar abdominal	22.02
trócar par aguja de punción para hígado	22.05
trócar para el seno maxilar	22.02
trócar para la vejiga	22.02
trócar para traqueotomía	54.02
trócar torácico	22.03
trócar universal abdominal	22.02
TROELTSCH (WILDE) pinza auricular	44.09
TROELTSCH pinza nasal	46.05
TROEMNER martillo de percusión	02.10
TROTTER pinza gubia	32.07
TROUSSEAU dilatador traqueal	54.02
TROUTMAN CHRIS rompe hojas	06.07
TROUTMAN calibre pinza para iris	42.15
TROUTMAN pinza de rectus	43.02
Tübingen cánula de aire	43.08
Tübingen pinza para iris	42.17
Tübingen pinza para ligaduras	43.05
Tübingen separador	18.30
Tübingen separador vaginal	70.11
tubo de aspiración	04.02, 04.03,
	40.15, 40.16,
	44.06, 52.06
tubo de irrigación uterina	70.35
tubo de punción graduado	40.16
tubo endotraqueal	54.03
tubo traqueal	54.03
TUCKER McLEAN fórceps obstétrico	72.03
TUFFIER pinza hemostática	12.11
TUFFIER separador	56.07
TUFFIER separador abdominal	18.22
TURNBULL pinza para uñas	74.04
TURNER WARWICK separador abdominal	18.50 - 18.55
TURREL pinza de biopsia rectal	68.07
TYDING cierra nudos para amígdalas	50.07
TYRELL gancho para iris	42.07
U	
UCKERMANN porta-algodón	20.06

Índice alfabético

UCKERMANN trócar	54.02
UFFENORDE cureta para huesos	32.27
ULRICH pinza para sujetar huesos	32.17
ULRICH pinza para tapones	16.02
UNNA saca comedones	74.02
uretrótomo	66.04
US Army separador	18.03
US tijera para cordón umbilical	08.14
USA pinza de disección	10.02

V

VALIN separador	18.62
VALLEIX histerómetro	70.22
van BUREN pinza para secuestrós	32.21
van DOREN pinza de biopsia uterina	70.25
VANNAS tijera de iridectomía	09.03
VANT pinza porta esponjas	16.03
VARADY flebo-disecador	20.05
VARADY mini set de desoblitadores	20.04
vaso para medicamentos	88.03
vBUREN bujía dilatadora uretral	66.06
VERBRUGGE HOHMANN elevador para huesos	32.53
VERBRUGGE pinza para huesos	32.18
VERESS aguja de neumoperitoneo	22.03
VERNIER pie de rey	02.12
VIDAL legra para lupus	74.02
Viena modelo espéculo nasal	46.03
Vienés modelo, espéculo vaginal	70.11
VIRCHOW cuchillo para cerebro	06.13
VIRCHOW rompecráneo	32.38
VIRTUS (RALK) pinza para espigas	10.13
VOLKMANN cucharilla cortante	32.26, 32.28, 32.31, 32.32
VOLKMANN cureta cortante para huesos	32.26, 32.28, 32.31, 32.32
VOLKMANN separador	18.10 - 18.12
VOLTOLINI (DUPLAY) espéculo nasal	46.02
vPETZ aparato para suturar estómago	64.13

W

WACHENFELDT pinza para grapas	26.07
WADSWORTH TODD cauterio	42.09
WAGENER ganchito	44.09
WAGENER MOSHER tubo endotraqueal	54.03
WAGNER martillo	32.42
WAGNER pinza de laminectomía	40.18
WAGNER tijera	08.18
WALB cuchillo para órganos	06.13
WALLICH cuchara para aborto	72.07
WALSHAM pinza para enderezar tabique nasal	46.25
WALTER aguja para cuerpos extraños	42.06
WALTHER bujía dilatadora uretral	66.08
WALTHER cateter dilatador uretral	66.07
WALTON gubia para cuerpos extraños	42.06
WALTON saca comedones	74.02
WALTON separador para hemilaminectomía	18.35
WALTON YANKAUER tubo de aspiración	04.02
WANÉ separador	18.31
WANGENSTEEN pinza de disección	10.09
WANGENSTEEN porta-aguja	24.05
WARTENBERG sensímetro	02.11
WASSMUND separador	18.23
WATSON CHEYNE elevador	32.50
WATSON CHEYNE perióstotomo	20.02
WATSON dermatótom	06.12
WATSON JONES elevador para hueso	32.56
WATSON WILLIAMS pinza etmoidal	46.07
WATSON WILLIAMS pinza para esfenoides	46.07
WAUGH pinza de disección	10.09
WEBER asa auricular	42.09
WEBER estesiómetro	02.11
WEBSTER porta aguja	24.02
WECKER espátula para iris	42.09
WECKER tijera para iris	09.02
WEEK blefarostato	42.02
WEIL BLAKESLEY pinza cortante nasal	46.09
WEINBERG separador para vagotomía	18.07
WEISS blefarostato	42.03
WEISS pinza cierratubo	12.30
WEITLANER separador	18.28 - 28.30
WEITLANER WULLSTEIN separador	18.28
WELLS espátula para enucleación	42.09
WERTHEIM atrauma pinza de anastomosis	12.28

WERTHEIM CULLEN pinza para histerectomía	12.28
WERTHEIM pinza clamp	12.27
WERTHEIM pinza de histerectomía	12.27
WERTHEIM porta aguja	24.06
WERTHEIM tijera de preparación	08.13
WERTHEIM tijera quirúrgica	08.13
WEST cíncel nasal	46.20
WESTMACOTT pinza nasal para tapones	46.06
WESTON cierranudo para pólipos rectales	68.06
WETCOTT tijera para tendones	09.02
WHEELER cuchillo para disección	42.05
WHEELER espátula de ciclodíalisis	42.10
WHITE pinza para coger amígdalas	50.04
WHITEHEAD abreboza	48.06
WIEDER abajalengua	48.02
WIENER (AUFRICHT) lima nasal	46.21
WIENER gancho para iris	42.07
WIENER lima para el seno	46.20
WIGMORE sierra para yesos	30.02
WIKSTROEM pinza hemostática	12.20
WILBERG agrafe para huesos	36.26
WILDE cierranudo auricular	44.09
WILDE cierranudo nasal	46.13
WILDE TROELTSCH pinza auricular	44.09
WILDER asa	42.09
WILDER dilatador lagrimal	42.11
WILKINS cánula intra uterina	70.30
WILLET MARTEL pinza para pericráneo	12.10
WILLIAMS blefarostato	42.03
WILLIAMS destornillador/soporte de tornillos	33.20
WILLIAMS pinza para tejido	64.04
WILLIAMS separador	18.62
WILLIGER cureta doble	32.32
WILLIGER elevador	32.49
WILLIGER legra	32.47
WILLIGER martillo	32.41
WILLIGER perióstotomo	32.47
WILMS pinza gubia	32.07
WINER pinza para placenta y aborto	72.06
WOLFF pinza para yesos	30.04
WRIGHT porta aguja	24.02
WRIGLEY fórceps obstétrico	72.02
WULLSTEIN cuchillo forma de hoz	44.14
WULLSTEIN tijera auricular mini	44.14
WÜRZBURG abajalengua	48.10
WYLIE dilatador uterino	70.17

Y

YANKAUER espéculo nasofaringeal	46.05
YANKAUER tubo de aspiración	04.02
YASARGIL cucharilla cortante	40.28
YASARGIL cuchillo para arachnoide	40.29
YASARGIL legra	40.27
YASARGIL perióstotomo	40.27
YASARGIL pinza de hipofisectomía cortante	40.18
YASARGIL pinza micro	11.05
YASARGIL pinza para tumores	11.05
YASARGIL porta aguja	24.12
YASARGIL raspador	40.27
YASARGIL SAMIL pinza para tumores	11.05
YASARGIL separador de gálea	40.04
YASARGIL tubo de aspiración	40.15
YEMAN pinza para biopsia rectal	68.06, 68.07
YOUNG boomerang porta aguja	26.03
YOUNG pinza para sacar la próstata	66.02
YOUNG pinza tira-lengua	48.04
YOUNG separador prostático	66.02

Z

ZAUHAL JANSEN pinza gubia	32.07
ZENKER pinza de disección y de ligadura	12.19
ZENKER separador	18.21
ZIEGLER blefarostato	42.03
ZIEGLER cuchillo de capsulotomía	42.05
ZIEGLER cuchillo de iridectomía	42.05
ZIEGLER dilatador lagrimal	42.12
ZIEGLER espejo frontal	02.05
ZIELKE gubia para escoliosis	32.37
ZOELLNER tubo de aspiración	44.06
zurdos, porta aguja para	24.02 - 24.04
zurdos, tijeras para	08.02, 08.03, 08.05, 08.07, 08.20

ZWEIFEL porta aguja

24.07

Índice
alfabético

ZEPF®
INSTRUMENTS

A	
abbassalingua	48.02, 48.03, 48.07 - 48.11
ABRAHAM coltello per tonsille	50.04
ABRAMS ago per biopsia	22.04
accessori per container	88.09, 88.10, 88.20, 88.21
adenotomo	46.28
ADLERKREUTZ pinza	10.05
ADSON (FRASIER) pinza emostatica	12.13
ADSON baby (CONE) divaricatore	18.34
ADSON baby pinza emostatica	12.13
ADSON BROWN pinza	10.04
ADSON divaricatore	18.31
ADSON divaricatore di duramide	40.06
ADSON divaricatore per emilaminectomia	18.33
ADSON elevatorio	32.49
ADSON pinza	10.03, 10.04, 32.04, 40.09
ADSON portaghi	24.06
ADSON tubo di aspirazione	40.15
AEBLI forbici corneali	08.08
aghi per sutura	26.05 - 26.07
ago da biopsie	22.04
ago da iniezione tonsillare	50.08
ago da paracentesi	44.07
ago da puntura lombare	22.03, 22.04
ago di biopsia	22.04, 22.05
ago e scalpello invertibili	42.10
ago palatale	50.03
ago per anestesia pudenda	22.03
ago per aneurisma	26.02
ago per autopsia	26.07
ago per cataratta	42.06
ago per corpi estranei	42.06
ago per il seno mascellare	46.13
ago per la microchirurgia auricolare	44.17, 44.18
ago per la puntura del fegato	22.05
ago per la puntura ventricolare	40.16
ago per legatura	26.02, 26.03
ago per pneumoperitoneo	22.03
ago per sutura	26.05 - 26.07
ago per tonsille	50.03
ago tonsillare	50.03
agrafe in argento	64.13
agrafe per ossa	36.26
agrafe per sutura	26.08
ALAN PARKS specolo rettale	68.03
ALBARRAN ago da legatura	26.03
ALBEE fresa	33.09
ALDERCYCE dissettore	32.56
alesatore per chiodi centromidollari	33.18, 34.09
alesatori	33.10, 33.18, 33.24, 40.04
ALEXANDER periostotomo	32.47
ALEXANDER pinza per biopsia	70.25
ALEXANDER scalpello	32.34
ALEXANDER sgorbia	32.34
ALLEN pinza intestinale	64.04
ALLIS ADAIR pinza	64.02
ALLIS pinza per afferrare intestini e tessuto	64.02
ALLISON spatola polmonare	56.12
ALM divaricatore	18.26
ALVIS curetta per corpi estranei	42.06
ANDERSON ADSON divaricatore	18.30
ANDREW abbassalingua	48.02
ANDREWS PYNCHON tubo da aspirazione	04.02
anelli per legatura emorroidale	68.10
anello per il bulbo	42.18
ANKENEY divaricatore sternale	56.09
ansa auricolare	44.08, 44.09
ansa oftalmica	42.09
anse per serranodi nasali	46.13
anse per serranodi tonsillari	50.07
apribocca	48.05 - 48.11
ARCHER pinza per schegge	10.13
arco per estensione	33.12
Arkansas pietra per affilare	06.13
ARRUGA blefarostato	42.02
ARRUGA cutchio isolato	42.08
ARRUGA pinza capsulare	43.04
ARRUGA portaghi	24.09
ARRUGA protettore	42.09
ARRUGA uncino per estrazione	42.07
ARTHUR pinza per iride	42.15
ASCH pinza per raddrizzare il setto	46.25

aspiratore capsulare	42.11
assordatore	44.05
asta guida per alesatore	34.09
AUFRANC cobra elevatore per ossa	32.54
AUFRICHT divaricatore nasale	46.24
AUFRICHT raspa nasale	46.21
autopsia, strumenti per	32.39
AUVARD specolo vaginale	70.10
avvicinatore di castole	56.12
AXENFELD curetta per calazio	42.08
AXENFELD MELLINGER blefarostao	42.02
AYER pinza per calazio	43.06
AYRE bisturi per il cono d'attrazione	70.29

B	
BABCOCK pinza per afferrare intestine e tessuti	64.03
BABINSKY martello da percussione	02.10
bacinella per sterilizzazione	88.08
bacinella per strumenti	88.04
bacinella reniforme	88.03
bacinella rettangolare per strumenti	88.04
bacinella rotonda	88.03
BACKHAUS fissateli	14.02
BACKHAUS KOCHER fissateli	14.02
BACON pinza sgorbia	32.05
BADGLEY divaricatore per laminectomia	56.06
BAGGISH pinza per biopsia	70.28
BAILEY avvicinatore costale	56.12
BAILEY GIBBON avvicinatore costale	56.12
BAINBRIDGE pinza emostatica	12.22
BAKES sonda per calcoli biliari	62.03
BALFOUR divaricatore addominale	18.45 - 18.47
BALLENGER coltello girevole	46.15
BALLENGER elevatore per setto	46.17
BALLENGER pinza per tonsille	50.05
BANE pinza assivora	32.04
BANGERTER pinza muscolare	43.07
BANGERTER spatola per ciodialidiosi	42.09
BARANY assordatore	44.05
BARBARA ago per la microchirurgia auricolare	44.17, 44.18
BARBARA pick	44.17, 44.18
BARBARA uncinetto	44.17
BARKAN coltello per goniotomia	42.06
BARNHILL coltello per vegetazioni adenoidee	46.27
BARON (SCHUKNECHT) tubo da aspirazione	44.06
BARR specolo rettale	68.03
BARRAQUER blefarostato	42.02
BARRAQUER colibri blefarostato	42.02
BARRAQUER coltello per cheratoplastica	42.06
BARRAQUER KATZIN pinza per iride	42.15
BARRAQUER pinza fissatrice	43.03
BARRAQUER pinza per la camera anteriore	43.02
BARRAQUER portaghi	24.10
BARRETT pinza uterina	70.18
BARRON legatore emorroidale	68.09
BARRON manico per bisturi	06.02
BARTAQUER pinza depilatoria	43.10
BARTH curetta tagliente	32.32
BARTON trattore per forcipe ostetrico	72.03
BAUMGARTNER portaghi	24.03
BEACHAM amniotomo	70.21
BECKER cistitomo	42.07
BECKMANN coltello per vegetazioni adenoidee	46.27
BECKMANN divaricatore	18.33
BECKMANN EATON divaricatore	18.33
BECKMANN FISCH divaricatore	18.29
BECKMANN specolo nasale	46.03
BEEBEE forbici	08.19
BEESON divaricatore per gessi	30.04
BELLUCCI forbici	44.11
benda per emostasi	02.05
BENGOLEA pinza emostatica	12.12
BENNETT elevatore per ossa	32.52
BENSAUDE anoscopio	68.05
BERENS cheratomo	42.04
BERENS pinza da avanzamento	43.07
BERENS pinza muscolare	43.07
BERGER pinza per biopsia uterina	70.28
BERGMANN divaricatore	18.26
BERGMANN forbici per bendaggi	08.20
BERGMANN martello	32.41
BERGMANN sego per gessi	30.02
BERGMANN specolo rettale	68.02
BERKE pinza muscolare	43.02

BERLINER martello di percussione	02.11
BERNHARD (STAUDE) fissateli	14.04
BERTILLON cefalometro	02.11
BEST pinza intestinale	64.09
BETHUNE costotomo	56.02
BEUSE forbici	08.09
BEYER cesoia per ossa	46.12
BEYER pinza sgorbia	32.05, 32.07
bicchiere graduato	88.03
BIER ago da puntura lombare	22.04
BILL trattore per forcipi con manici standard	72.04
BILLEAU ansa auricolare	44.08
BINKHORST pinza per impiantare lente	42.18
bipod per apribocca	48.11
BIRCHER GANSKE tenaglia per ossa	32.19
BIRCHER meniscotomo	32.58
BIRKETT pinza emostatica	12.14
BISHOP HARMAN pinza per iride	42.17
bisturi fino	06.10
bisturi manico metallo	06.09
bisturi nasale	46.14
bisturi per cono d'attrazione	70.29
bisturi per duramide	40.08
bisturi per la plastica nasale	46.14
bisturi per l'aracnoide	40.29
bisturi per mucosa	46.14
bisturi per tonsille	50.04
bisturi uso unico sterile	06.06
bisturi vascolare	40.29
BLAKE curetta uterina	70.31
BLAKE pinza per calcoli biliari	62.02
BLASCOVICIS pinza per avanzamento	43.02
blefarostato	42.02, 42.03
BLOHMKE pinza per tonsille	50.05
BLOUNT elevatore per il ginocchio	32.56
BLOUNT elevatore per ossa	32.56
BLOUNT estrattore di cambre per ossa	34.12
BLUMENTHAL pinza sgorbia	32.03
BODENHAMMER specolo rettale	68.02
BOEHLER arco per estensione	33.12
BOEHLER cesoia per ossa	32.14
BOEHLER pinza sgorbia	32.08
BOERMA forcipe	72.04
BOETTCHER forbici tonsillari	08.10
BONACCOLTO pinza per strabismo	42.16
Bonn cannula per irrigazione	43.08
Bonn pinza per iride	42.17
BONNEY pinza	10.05
boomerang portaghi	26.03
BORCHARDT fresa	33.09
BOSE divaricatore tracheale	54.02
BOSE uncino tracheale	54.03
BOUCHERON specolo auricolare	44.02
BOWLES stetoscopio	02.09
BOWMAN ago da discissione	42.06
BOWMAN blefarostato	42.02
BOWMAN coltello per discissione	42.05
BOWMAN specillo lacrimale	42.12
BOYNTON portaghi	24.09
BOYS ALLIS pinza per afferrare intestini e tessuti	64.02
BOZEMANN (WERTHEIM) portaghi	24.06
BOZEMANN DOUGLAS pinza per polipi	16.06
BOZEMANN FRITSCH tubo da irrigazione uterina	70.35
BOZEMANN pinza per polipi	16.05
BRAND pinza passatendini	32.23
BRAUN cranioclasto	72.07
BRAUN depressore uterino	70.21
BRAUN pinza per abbassare il collo uterino	70.20
BRAUN pinza uterina	70.18
BRAUN STADLER forbici per episiotomia	08.14
BRAUN uncino per decapitazione	72.08
BRAUN valva vaginale	70.11
BREISKY specolo vaginale	70.13
BRIDGE pinza emostatica, da dissezione e passafili	12.20
BRISTOW periostotomo	32.46
BROCK portaghi curvo	24.12
BRODIE sonda	20.02, 20.04
BROPHY pinza	10.08
BROWN pinza	10.04
BROWN portaghi	24.03
BRUENINGS abbassalingua	48.02
BRUENINGS BRUNK divaricatore	46.29
BRUENINGS coltello per setto	46.15
BRUENINGS pinza tagliente nasale	46.08
BRUENINGS punta di pinza	52.03
BRUENINGS serranodi tonsillare	50.06
BRUENINGS specolo auricolare neumatico	44.03

Indice alfabetico

BRUNETTI scalpello spinale	32.38	CASTROVIEJO pinza oer sutura	43.05	coltello interosseo	06.11
BRUNNER ago per legatura	26.03	CASTROVIEJO portaghi	24.11, 24.12	coltello lobare	44.17
BRUNNER conduttore di legature	26.04	CASTROVIEJO rompe lamette	06.07	coltello per amputazione	06.10
BRUNNER costotomo	56.03	CASTROVIEJO SCHARCHAR compasso marcatore	42.11	coltello per anatomia	06.13
BRUNNER divaricatore	18.20	CASTROVIEJO spatola di ciclodialisi	42.09, 42.10	coltello per capsulotomia	42.05
BRUNNER pinza intestinale	64.09	CASTROVIEJO trapano	43.08	coltello per cartilagine	06.13
BRUNS curretta tagliente	32.26 - 32.28	cateter uretrale dilatatore	66.07	coltello per cataratta	42.04
BRUNS forbici per bendaggi	08.21	cauterio	42.09	coltello per cervello	06.13
BRYANT pinza per medicazione	16.04	cavachiodi	33.19	coltello per cheratoplastica	42.06
BÜCHS divaricatore per guance e tessuti	18.23	cefalometro	02.11	coltello per falangi	06.11
BUCHWALD abbassalingua	48.02	cesoia per ossa	32.13, 32.14	coltello per gesso	30.04
BUCK coltello auricolare	44.08	cesoia per posizionare placche angolari 'T'	34.05	coltello per goniotomia	42.06
BUCK forbici per legature	08.18	CHAMPEAU cannula di radiometria	22.06	coltello per il trigemino	40.09
BUCK GRAMCKO sgorbia	32.34	CHANDLER pinza per iride	42.13	coltello per iridectomia	42.05
BUCK leva per corpi estranei	44.10	CHAPUT pinza emostatica	12.11	coltello per la plastica nasale	46.14
BUCK martello di percussione	02.11	CHARNELY divaricatore	18.35, 18.64	coltello per lobi	06.11
BUELAU trequarti per torace	22.03	CHARNLEY pinza per sutura	10.11	coltello per organi	06.13
BUIE tubo di aspirazione	68.06	CHARRIERE sega da amputazione	33.03	coltello per plastica nasale	46.13
BUMM curretta uterina	70.32	CHEATLE pinza per strumenti	28.02	coltello per resezione	06.10
BUNGE curretta per palpebre	42.08	CHELSEA EATON specolo anale	68.05	coltello per setto	46.14, 46.15
BUNNELL perforatore a mano	33.06	cheratomo	42.04	coltello per tonsille	50.04
BUNNELL scollatendini	32.59	CHERON pinza per polipi	16.05	coltello per vegetazioni adenoidiee	46.27
BUNNELL sonda malleabile	32.59	CHEVALIER DE BOER divaricatore costale	56.11	coltello periostale	44.19
BUNT pinza per sterilizzazione	28.02	CHEVALIER JACKSON per bronco-esofagoscopia	52.04	coltello tonsillare e dissettore	50.03
BURCH forchetta di fissaggio	42.06	CHEVRET divaricatore	18.05	coltello tonsillare ed enucleatore	50.03
BURKE pinza per biopsia uterina	70.26	chiave cardanica	34.03	COLVER pinza per tonsille	50.04
BUSCH forbici ombelicali	08.14	chiave per dadi	32.33, 33.12, 34.03, 34.13	compasso da fissaggio	18.61

C	
cacciavite	18.41, 33.20, 33.22, 34.13
CAIRNS pinza emostatica	12.06
calamita oculistica	43.09
calibratore	02.12
calibro per chiodi centromidollari	36.06
calibro per trapani e vite	33.25
cambra per ossa	36.25, 36.26
cambra per osteotomia	36.26
camicia centrante DHS	34.08
CAMPBELL candeletta dilatatrice uretrale	66.07
candeletta dilatatrice uretrale	66.06 - 66.08
candeletta dilatatrice uretrale con filetto inferiore	66.06
CANFIELD bisturi per tonsille	50.04
cannula da aspirazione	40.15, 44.06
cannula intra uterina	70.30
cannula oftalmica	43.08
cannula per intubazione	54.03
cannula per irrigazione ed aspirazione	43.08
cannula per irrigazione nasale	46.13, 46.29
cannula per la puntura lombare	22.03
cannula per radiometria	22.06
cannula per sutura	43.08
cannula per vene	22.04
cannula per ventilazione assistita di pressione	52.06
cannula vascolare	22.04
CANNY RYALL divaricatore	18.22
CAPLAN forcipe per setto	46.11
capsula	88.03
CARMALT pinza per schegge	10.12
CARPENTER coltello tonsillare e dissettore	50.03
CARREL pinza vascolare	12.03
CARROLL pinza afferratendine	32.24
CARTON evacuatore di mucosa	70.30
CASPAR cacciavite	18.41
CASPAR contra divaricatore	18.42
CASPAR distrattore per corpi vertebrali	18.41
CASPAR divaricatore articolato	18.39
CASPAR divaricatore per la colonna vertebrale	18.39
CASPAR divaricatore per laminectomia	18.39, 18.40
CASPAR divaricatori	18.38 - 18.42
CASPAR guida-trapano	18.41
CASPAR manico da bisturi micro	06.08
CASPAR pinza tagliente per laminectomia	40.19 - 40.21
CASPAR placca trapezoidale	36.24
CASPAR specolo per operazioni vertebrali	18.42
CASPAR uncino per esplorazione e coagulazione	40.26
CASTANEDA divaricatore costale	56.05
CASTROVIEJO blefarostato	42.03
CASTROVIEJO cheratomo	42.04
CASTROVIEJO compasso marcatore	42.11
CASTROVIEJO dilatatore lacrimale	42.12
CASTROVIEJO forbici corneali	09.03
CASTROVIEJO forbici per iridectomia	09.02
CASTROVIEJO pinza capsulare	43.04
CASTROVIEJO pinza fissatrice	43.03

CHILDE pinza per afferrare i bordi della ferita	26.07
chiodo centromidollare	36.02 - 36.06
chiodo per il collo del femore	36.07, 36.08
chiodo per ossa	33.11, 36.02 - 36.08
chiodo per ossa con gancio	36.02
chirurgia della mano	18.24, 18.25
cistitomo	42.07
CITELLI pinza tagliente	46.11
CLAR lampada frontale	02.05
CLARK blefarostato	42.02
CLAYMAN pinza per impiantare lente	42.18
CLEVELAND cesoia per ossa	32.13
CLEVELAND pinza sgorbia	32.02
clip portaplacche	33.25
CLOWARD divaricatore	18.36, 18.37, 40.16
CLOWARD HOEN divaricatore	18.43
coagulazione bipolare, pinze per	92.04 - 92.05
coagulazione monopolare, pinze per	92.03
COAKLEY curretta per seno	46.26
COAKLEY trequarti	22.03
COBB curretta per fusione spinale	32.30
COBB elevatore spinale	32.52
COBB sgorbia spinale	32.37
COBBETT dermatomo	06.12
cobra elevatore per ossa	32.54
CODIVILLA pinza per clavicola	32.21
COLCLOUGH pinza tagliente	40.22
Colibri blefarostato	42.02
Colibri forbici per iride	09.02
Colibri pinza per iride	42.15
COLLIER portaghi	24.02
COLLIN costotomo	56.02
COLLIN curretta uterina	70.35
COLLIN dinamometro	02.05
COLLIN divaricatore	18.02
COLLIN divaricatore addominale	18.57, 18.58
COLLIN DUVAL pinza	10.06
COLLIN HARTMANN divaricatore	18.04
COLLIN isterometro	70.22
COLLIN manico da bisturi	06.04
COLLIN martello	32.40
COLLIN pelvimetro	72.05
COLLIN pinza emostatica	12.11
COLLIN pinza isterolobo	70.21
COLLIN pinza ombelicale	72.05
COLLIN pinza per agrafe	26.08
COLLIN pinza per polipi	16.04
COLLIN pinza trilingua	48.04
COLLIN specolo vaginale	70.03
COLLYER pelvimetro	72.05
coltellino corneale	42.06
coltello auricolare	44.08, 44.17
coltello circolare	44.17
coltello corneale	42.05
coltello da discissione	42.05, 42.06
coltello falciiforme	44.17
coltello girevole	46.15

coltello per setto	46.14, 46.15
coltello per tonsille	50.04
coltello per vegetazioni adenoidiee	46.27
coltello periostale	44.19
coltello tonsillare e dissettore	50.03
coltello tonsillare ed enucleatore	50.03
COLVER pinza per tonsille	50.04
compasso da fissaggio	18.61
compasso marcatore	42.11
compressore per tonsille	50.06
concomito	46.10
conduttore di filo di acciaio per ossa	33.13
CONE ago ventricolare	40.16
CONE divaricatore	18.34
CONE pinza per craniotomia	40.07
conficatore estrattore per chiodi del collo del femore	34.11
conficatore estrattore per chiodi midollari	34.04, 34.10
conficatore per cambre ossee	34.12
conficatore per chiodi midollari	33.19, 34.04, 34.10
conficatore per vite DHS	34.07
CONNIN AMSLER marcatore	42.11
container per sterilizzazione	88.12 - 88.21
CONTOUR divaricatore	18.30
controllore dell'angolo	34.04
CONVERSE bisturi per plastica nasale	46.14
CONVERSE uncino alare	46.24
COOLEY dilatatore vascolare	56.17
COOLEY divaricatore per il atrio	56.11
COOLEY pinza traumatica	11.03
COOLEY tubo da aspirazione	04.03
COOPER ago	26.02
CORDES punta di pinza	52.03
CORWIN compressore per tonsille	50.06
CORYLLOS costotomo	56.02
CORYLLOS divaricatore toracico	18.20
COS pinza auricolare per filo di metallo	44.12
costotomo	56.02, 56.03
COTTLE bisturi per plastica nasale	46.14
COTTLE divaricatore	46.24
COTTLE elevatore per il setto	46.16
COTTLE forbici nasali	08.09
COTTLE KAZANJIAN cesoia per ossa	32.13
COTTLE martello	32.40
COTTLE NEIVERT divaricatore	46.24
COTTLE periostotomo	46.17
COTTLE pinza per afferrare la pelle	46.26
COTTLE pinza per columella	46.26
COTTLE protettore delle pinne del naso	46.25
COTTLE raspa nasale	46.21
COTTLE scalpello per plastica	46.18
COTTLE specolo nasale	46.04
COTTLE strumento da applicazione	46.23
COTTLE tritacartilagine	46.23
COVENTRY cambra	36.25
COXFETER sonda prostatica	66.07
CRAFOORD (STELZNER) forbici	08.16
CRAFOORD pinza bronchiale	12.18
CRAIG pinza per setto e vomer	46.07
cranioclasto	72.07
CREA candeletta dilatatrice uretrale	66.08
Crede tagliacilli	74.04
CRILE divaricatore	18.03
CRILE MURRAY portaghi	24.03
CRILE pinza emostatica	12.05
CRILE portaghi	24.07
CRILE RANKIN (OCHSNER DIXON) pinza emostatica	12.06
CRILE RANKIN pinza emostatica	12.06

Indice alfabetico

CRILE uncinetto per nervi 40.05
 CRILE WOOD portaghi 24.03
 CRITCHETT blefarostato 42.02
 Croce Rossa forcipi per bendaggi 08.21
 CROTTI divaricatore per gozzo 18.28
 CRUTCHFIELD alesatore 40.04
 CRUTCHFIELD trazione craniale 40.04
 cucchiaio malleabile 40.25
 cucchiaio isolato 42.08
 cucchiaio micro tagliente 40.28
 cucchiaio osterico 72.07
 cucchiaio per aborto 72.06, 42.07
 cucchiaio per calcoli biliari 62.04
 cucchiaio per secrezione 66.05
 cucchiaio uterino tagliente 70.31
 CULLER spatola per iride 42.09
 curetta auricolare 44.07, 44.08
 curetta e dissettore per il sacco lacrimale 42.09
 curetta e uncinio 44.08
 curetta malleabile per ipofisectomia 40.24, 40.25
 curetta per aborto 72.06
 curetta per calazio 42.08
 curetta per cataratta 42.08
 curetta per disco rotto 32.29
 curetta per fusione spinale 32.30
 curetta per lupus 74.02
 curetta per microchirurgia auricolare 44.18
 curetta per palpebre 42.08
 curetta per seno 46.26
 curetta pituitaria 40.28
 curetta tagliente per ossa 32.26 - 32.32
 curetta uterina 70.24,
 70.31 - 70.36

curetta uterina con irrigazione 32.26
 curetta uterina di aspirazione 70.36
 curetta uterina per biopsia 70.23, 70.24,

70.36
 curetta uterina per biopsia con aspirazione 70.23
 CUSCO specolo vaginale 70.04, 70.05
 CUSHING divaricatore 18.09, 40.05
 CUSHING divaricatore per nervi 40.05
 CUSHING LANDOLT specolo per ipofisectomia 40.23
 CUSHING "Little Joker" periostotomo 32.46
 CUSHING KOCHER divaricatore 18.14
 CUSHING perforatore 33.05
 CUSHING pinza di dissezione 10.05
 CUSHING pinza emostatica 12.07
 CUSHING pinza per laminectomia 40.17
 CUSHING spatola cerebrale 40.15
 CUSHING TAYLOR pinza 10.08
 CUSHING uncinio artriale 40.05
 CUSHING uncinio per duramadre 40.05
 CUZZI cucchiaio per aborto 72.06
 CZERNY divaricatore 18.04
 CZERNY pinza per abbassare il collo dell'utero 70.20
 CZERNY specolo rettale 68.02

D

dado per vite corticali 36.13
 DAHLGREN pinza per craniotomia 40.07
 DALE pinza sgorbia 32.12
 DANDY forcipa neurochirurgiche 08.15
 DANDY mosquito pinza emostatica 12.09
 DANDY pinza emostatica 12.09
 DANDY uncinio per nervi 40.05
 DANIS tendifili 33.13
 DARLING divaricatore 18.34
 DARTIGUES pinza isterolobo 70.21
 DASTOOR aspiratore capsulare 42.11
 DASTOOR pinza per strabismo 42.16
 DAUBENSPECK curetta tagliente 32.27
 DAVIDSON divaricatore di scapula 18.21
 DAVIEL curetta per cataratta 42.08
 DAVIS ago per corpi estranei 42.06
 DAVIS BOYLE apribocca 48.07
 DAVIS dissettore di duramadre 40.08
 DAVIS MEYER apribocca 48.09
 DAVIS pinza per afferrare siringhe 28.02
 DAY uncinio auricolare 44.09
 DCS placche 36.09
 DE BAKEY DIETRICH pinza 11.04
 DE BAKEY dilatatore vascolare 56.17
 DE BAKEY pinza extra leggera atraumatica 11.06
 DE BAKEY portaghi 24.04
 DE BAKEY tubo di aspirazione 04.02

De LEE forcipe 72.02
 De LEE HILLIS pelvimetro per misurare all'interno 72.05
 De LEE HILLIS stetoscopio 02.09
 DEAN coltello per iridectomia 42.05
 DEAN forcipi tonsillari 08.09
 DEAYER divaricatore 18.07
 DEAYER forcipi 08.03
 DEAYER grip divaricatore 18.07
 DEBAKEY divaricatore costale 56.07
 DEBAKEY divaricatore femorale 18.56
 DEBAKEY forcipi vascolari e toraciche 08.12
 DEBAKEY pinza Bulldog atraumatica 12.02
 DEBAKEY pinza di dissezione 11.03, 11.04
 DEBAKEY valve per sternotomia 56.07
 DEJERINE martello di percussione 02.10
 DeMARTEL WOLFSON pinza per 64.10
 DeMARTEL WOLFSON portapinze 64.10
 DeMARTEL WOLFSON serrapinze 64.10
 DEMEL guida per filo di metallo 33.13
 DEMEL pinza tendifili 33.13
 DENHART apribocca 48.05
 DENNIS BROWNE divaricatore addominale 18.49
 DENNIS BROWNE pinza per afferrare intestini 10.09
 depressore per epiglottide 52.02
 depressore uterino 70.21
 DERF (WRIGHT) portaghi 24.02
 DERF portaghi 24.02
 dermatomo 06.11, 06.12
 DERRA pinza per anastomosi 56.16
 D'ERRICO trapano 33.05
 DESCHAMPS ago per legature 26.02
 DESJARCINS cucchiaio per calcoli biliari 62.04
 DESJARDINS pinza per calcoli biliari 62.02
 DESJARDINS pinza per il condotto biliare 12.23
 DESJARDINS sonda per calcoli biliari 62.03
 DESMARRES divaricatore per palpebre 18.08
 DESMARRES pinza di calazio 43.06
 DEUTSCHMANN coltello per cataratta 42.04
 DeVILBISS pinza di craniotomia 40.07
 DEWEY forcipi con trattore 72.04
 DHS chiave per vite 34.07
 DHS conficatore per vite 34.07
 DHS maschiatore per vite 34.07
 DHS strumento da misurare 34.07
 DHS vite da connessione lunga 34.08
 Diamant tagliafili 33.16
 diapason 44.04, 44.05
 DICK trauma pinza per anastomosi 12.28
 DIEFFENBACH serrafina 12.03
 DIETER pinza per la testa del martello 44.13
 DIETRICH forcipi vascolari 08.11
 DIETRICH portaghi 24.09
 dilatatore lacrimale 42.11, 42.12
 dilatatore per il seno frontale 46.29
 dilatatore tracheale 54.02
 dilatatore uterino 70.14 - 70.17
 dilatatore vascolare 56.17, 56.18
 dinamometro 02.05
 DINGMAN apribocca 48.10
 disco per limitare il taglio 33.09
 dispositivo per piegare placche per ossa 33.22
 dissettore corneale 42.06
 dissettore di duramadre 40.07, 40.08
 dissettore per ipofisectomia 40.24, 40.25
 dissettore per ossa 32.56
 dissettore per tonsille 50.02
 dissettore vascolare 56.18
 distrattore per corpi vertebrali 18.41
 distributore di alcool 88.04
 distributore di fili per ossa 88.22
 distributore di filtri per container 88.24
 distributore di spazzole 74.05
 ditale 48.12
 DITTEL candelella di dilatazione uretrale 66.06
 divaricatore addominale 18.06, 18.18,
 18.43 - 18.61

divaricatore atriale 56.11
 divaricatore cerebellare 18.30
 divaricatore costale 56.04 - 56.11
 divaricatore delle radici di nervi 40.06
 divaricatore di aorta 56.13
 divaricatore di ginocchio 32.57
 divaricatore di gozzo 18.28
 divaricatore di guance 48.04
 divaricatore di labbra 48.03
 divaricatore di labbra e guance 48.04
 divaricatore di laminectomia 18.64

divaricatore di palpebre 18.08
 divaricatore di perineorafia 70.13
 divaricatore laterale vaginale 70.06
 divaricatore muscolare 18.64
 divaricatore orizzontale 18.35
 divaricatore pelviano 18.19
 divaricatore per coane 46.24
 divaricatore per emilaminectomia 18.32, 18.33,
 18.38
 divaricatore per falange 32.51
 divaricatore per gessi 30.04
 divaricatore per gozzo 18.27, 18.28
 divaricatore per guaine tendinee 18.12
 divaricatore per guance e labbra 48.04
 divaricatore per guance e tessuti 18.23
 divaricatore per il sacco lacrimale 42.03
 divaricatore per il torace 18.20
 divaricatore per incisione iniziale 18.64
 divaricatore per la colonna cervicale 18.39
 divaricatore per la laminectomia 18.32, 18.33,
 18.35, 18.38,
 18.40, 18.62,
 56.06

divaricatore per le pinne nasali 46.24
 divaricatore per nervi 40.05, 40.06
 divaricatore per ossa 32.55
 divaricatore per specoli di ipofisectomia 40.23
 divaricatore per tenaglie 32.22
 divaricatore per tendini 18.25
 divaricatore per tiroide 54.04
 divaricatore per vagotomia 18.07
 divaricatore perineale 18.56
 divaricatore perineale 18.56
 divaricatore pilorico 64.04
 divaricatore popliteale 18.34
 divaricatore prostatico 66.02, 66.03
 divaricatore rettale e vaginale 18.56
 divaricatore spinale 32.57
 divaricatore sternale 56.09
 divaricatore tracheale 18.08, 54.02
 divaricatore US Army 18.03
 divaricatore vescicale 66.03
 divaricatore vescicale 66.04

divaricatori 18.02 - 18.64,
 56.04 - 56.11

divaricatori nasali 46.24, 46.25
 divaricatori per la chirurgia della mano 18.24
 divaricatore per la duramadre 40.06
 divisore per cranio 32.38
 DIX ago e sgorbia 42.10
 DOREN pinza per biopsia uterina 70.25
 DOUGLAS pinza depilatoria 43.10
 DOWNING meniscotomo 32.58
 DOYEN abbassalingua 48.02
 DOYEN divaricatore addominale 18.18
 DOYEN fissatili 14.04
 DOYEN forcipi ginecologiche 08.13
 DOYEN fresa 33.09
 DOYEN JANSEN apribocca 48.05
 DOYEN martello 32.41
 DOYEN periostotomo costale 32.47
 DOYEN pinza intestinale 64.05
 DOYEN pinza per polipo uterino 70.20
 DOYEN portaghi 24.03
 DOYEN specillo scanalato 20.02
 DOYEN specolo vaginale 70.10
 DOYEN STILLE divaricatore 18.22
 DOYEN tiramiomi 70.29
 DRAFFIN bipod per apribocca 48.11
 DUBOIS forcipi ginecologiche 08.13
 DUBOST divaricatore costale 56.10
 DUEHRSSSEN pinza zigrinata 10.10
 DUNHILL pinza emostatica 12.06
 DUPLAY pinza uterina 70.18
 Duplex stetoscopio 02.09
 DUPUY DUTEMPS divaricatore 42.03
 DUPUY WEISS ago tonsillare 50.03
 DURANTE pinza 10.07
 DURHAM divaricatore 18.22
 DUVAL pinza 10.06
 DUVAL pinza per afferrare intestini e tessuti 64.03

E

ECHLIN pinza sgorbia 32.10
 EDNA fissatili 14.03

Indice alfabetico

EISELSBERG MATHIEU portaghi elettrodi di taglio e di coagulazione elevatore	24.08 92.02 32.46, 32.49 - 32.52, 32.56, 40.09, 44.19, 44.26, 46.16, 46.17 46.29 32.56 32.50, 46.16, 46.17 32.52 - 32.57 72.02 43.09 42.06 42.05 43.04 43.03 42.09 16.06 70.29 70.13 30.02 40.24, 40.25 70.28 70.28 70.28 30.04 08.20 34.10 33.12 02.11 34.12 70.30 50.06 10.03, 10.04
elevatore aspiratore	46.29
elevatore per il ginocchio	32.50, 46.16, 46.17
elevatore per il setto	32.52 - 32.57
elevatore per ossa	72.02
ELLIOT forcipe	43.09
ELLIOT trefine	42.06
ELLIS sgorbia per corpi estranei	42.05
ELSCHNIG coltello corneale	43.04
ELSCHNIG pinza capsulare	43.03
ELSCHNIG pinza fissatrice	42.09
ELSCHNIG spatola per ciclodialisi	16.06
EMMET pinza per polipi	70.29
EMMET uncino fistolare	70.13
endospecolo cervicale	30.02
ENGEL sega per gessi	40.24, 40.25
enucleatore per ipofisectomia	70.28
EPPENDORFER KEVORKIAN pinza per biops.uterina	70.28
EPPENDORFER pinza per biopsia uterina	70.28
EPPENDORFER TISCHLER MORGAN pinza biopsia	30.04
ESMARCH coltello per gesso	08.20
ESMARCH forcipi per bendaggi	34.10
estatore per chiodo flessibile midollare	33.12
estensore per dita	02.11
estesiometro	34.12
estrattore per cambra ossea	70.30
evacuatore di mucosa	50.06
EVES serranodi per tonsille	10.03, 10.04
EWALD (HUDSON) pinza	

F

FAHLBUSCH cucchiaino malleabile	40.25
FAHLBUSCH curetta malleabile	40.25
FALCONER pinza sgorbia	32.07
FARABEUF COLLIN periostotomo	32.45
FARABEUF divaricatore	18.02
FARABEUF LAMBOTTE tenaglia per ossa	32.15
FARABEUF periostotomo	32.45
FARABEUF tenaglia per ossa	32.15
faretra per elettrodi di AF	88.22
FARR divaricatore	18.26
FARREL portacatone	20.06
FARRIOR specolo auricolare	44.02
FAULKNER curetta tagliente	46.26
FAURE pinza per biopsia uterina	70.24
FAURE pinza per peitoneo	12.27
FAVOLORO forcipi vascolari	08.12
FEATHERSTONE apribocca	48.05
FEHLAND pinza intestinale	64.09
FEILCHENFELD pinza per schegge	10.12
FEIN portacatone	20.06
FERGUSSON ACKLAND apribocca	48.05
FERGUSSON cucchiaino per calcoli biliari	62.04
FERGUSSON forcipi	08.06
FERGUSSON pinza per pressione progressiva	12.09
FERGUSSON tenaglia per ossa	32.15
FERRIS SMITH KERRISON pinza per laminectomia	40.21
FERRIS SMITH pinza	10.05
FERRIS SMITH pinza tagliente per laminectomia	40.18
FICKLING pinza emostatica	12.07
filo per ossa di acciaio	33.13
filtri per contenitori di carta	88.13, 88.24
FINCH pinza da escissione	64.09
FINOCCHIETTO BURFORD divaricatore costale	56.05
FINOCCHIETTO divaricatore costale	56.04, 56.05
FINOCCHIETTO pinza bronchiale	56.14
FINOCCHIETTO portaghi	24.06
FINSEN divaricatore	18.26
FINSTERER tubo di aspirazione	04.03
FISCH scaltatore	44.18
FISCHER ARLT pinza per iride	42.15
FISCHER coltello per tonsille	50.04
FISCHER pinza per iride	42.15
FISH sonda auricolare	20.02
fissateli	14.02 - 14.04
flebo-dissettore	20.05
FLETCHER (JAVERTS) pinza per tamponi	16.04
FLEURANT trequarti per vescica	22.02

FLIERINGA anello per il bulbo	42.18
FLUHRER sonda	20.02
FOERSTER pinza per iride	42.14
FOERSTER pinza per spugne	16.03
FOMON forcipi nasali	08.09
FOMON pinza di dissezione	08.09
FOMON raspa nasale	46.21
FOMON scalpello	46.18
fonendoscopio	02.09
forcipi	08.02 - 09.04, 30.02, 44.11, 44.14, 46.11, 52.04 44.11, 44.14 09.03 08.15 08.12 08.13 08.14 08.16 08.08 08.16 08.12 - 08.14 44.11, 44.14 52.04 52.04 09.04 08.06, 08.09 08.15 08.14 08.14 08.20, 08.21 08.21, 08.22 08.17 08.09 08.14 08.22 08.19 08.13 08.21, 30.02 08.18, 08.19 08.10 08.07, 08.08, 09.02 09.02, 09.03 44.14 74.04 08.17, 08.18 56.03 08.02, 08.03, 08.05, 08.07, 08.20 46.11 08.08 09.02 08.10 08.22, 74.03 08.12 08.08 08.09, 08.10 08.16 08.20 08.10 - 08.12, 08.15 40.24 42.06 26.04 72.02 - 72.04 02.09 02.09 04.06 74.02 52.02 52.03 43.08 42.06 22.05 18.44 40.09 40.16 40.15, 40.16 18.07 46.14 46.14 46.29 46.16 46.17
forbici auricolare micro	44.11, 44.14
forbici corneali	09.03
forbici di duramide	08.15
forbici di parametro	08.12
forbici di preparazione	08.13
forbici di preparazione di nervi	08.14
forbici di pulmone	08.16
forbici di tenotomia	08.08
forbici di torace	08.16
forbici ginecologiche	08.12 - 08.14 44.11, 44.14
forbici micro-laringeali	52.04
forbici microlaringoscopiche	52.04
forbici microvascolari	09.04
forbici nasali	08.06, 08.09
forbici neurochirurgiche	08.15
forbici ombelicali	08.14
forbici ombelicali modello US	08.14
forbici per bendaggi	08.20, 08.21
forbici per bende	08.21, 08.22
forbici per enterotomia	08.17
forbici per enucleazione	08.09
forbici per episiotomia	08.14
forbici per fendere unghie	08.22
forbici per filo di metallo	08.19
forbici per fistole	08.13
forbici per gessi	08.21, 30.02
forbici per guance	08.18, 08.19
forbici per incisioni	08.10
forbici per iride	08.07, 08.08, 09.02 09.02, 09.03 44.14 74.04 08.17, 08.18 56.03 08.02, 08.03, 08.05, 08.07, 08.20 46.11 08.08 09.02 08.10 08.22, 74.03 08.12 08.08 08.09, 08.10 08.16 08.20 08.10 - 08.12, 08.15 40.24 42.06 26.04 72.02 - 72.04 02.09 02.09 04.06 74.02 52.02 52.03 43.08 42.06 22.05 18.44 40.09 40.16 40.15, 40.16 18.07 46.14 46.14 46.29 46.16 46.17
forbici per iridectomia	09.02, 09.03
forbici per la microchirurgia auricolare	44.14
forbici per la pelle	74.04
forbici per legature	08.17, 08.18
forbici per lo sterno	56.03
forbici per mancini	08.02, 08.03, 08.05, 08.07, 08.20 46.11 08.08 09.02 08.10 08.22, 74.03 08.12 08.08 08.09, 08.10 08.16 08.20 08.10 - 08.12, 08.15 40.24 42.06 26.04 72.02 - 72.04 02.09 02.09 04.06 74.02 52.02 52.03 43.08 42.06 22.05 18.44 40.09 40.16 40.15, 40.16 18.07 46.14 46.14 46.29 46.16 46.17
forbici per setto	46.11
forbici per strabismo	08.08
forbici per tendini	09.02
forbici per tonsille	08.10
forbici per unghie	08.22, 74.03
forbici per utero	08.12
forbici rettili	08.08
forbici tonsillari	08.09, 08.10
forbici toraciche	08.16
forbici US Army	08.20
forbici vascolari	08.10 - 08.12, 08.15 40.24 42.06 26.04 72.02 - 72.04 02.09 02.09 04.06 74.02 52.02 52.03 43.08 42.06 22.05 18.44 40.09 40.16 40.15, 40.16 18.07 46.14 46.14 46.29 46.16 46.17
forchetta da impiantare	08.15
forchetta di fissaggio	40.24
forchetta per legature profonde	42.06
forcipi	26.04
FORD BOWLES stetoscopio	72.02 - 72.04
FORD stetoscopio	02.09
FOREGGER laringoscopio	02.09
FOX curetta per lupus	04.06
FRAENKEL pinza per polipi laringei	74.02
FRAENKEL punta di pinza	52.02
FRANCESCHETTI trefina corneale	52.03
FRANCIS ago per corpi estranei	43.08
FRANKLIN SILVERMANN ago per puntura del fegato	42.06
FRAZIER divaricatore	22.05
FRAZIER elevatore per la duramide	18.44
FRAZIER tubo da puntura ventricolare	40.09
FRAZIER tubo di aspirazione	40.16
FRAZIER uncinetto per la duramide	40.15, 40.16
FREER bisturi per mucosa	18.07
FREER coltello per setto	46.14
FREER elevatore aspiratore	46.14
FREER elevatore per il setto	46.29
FREER scalpello per il setto	46.16 46.17

FREER sgorbia	46.20
FREER uncino per mucosa	46.24
FRENZEL abbassalingua fresca	48.02 33.04, 33.05, 33.09, 34.04, 34.08, 34.09
FRIEDMAN divaricatore per perineorrafia	70.13
FRIEDMAN pinza sgorbia	32.02
FRITSCH divaricatore	18.17
FRYKHOLM pinza sgorbia	32.10
FUCHS pinza capsulare	43.04
FUCHSIG pinza emostatica	12.14

G

GABRIEL specolo rettale	68.05
GALLAHER raspa per seno	46.22
gancio cavachiodi	33.19
GARRETT dilatatore vascolare	56.18
GAST abbassalingua	48.09
GAUSS pinza di pericranio	72.05
GELLHORN pinza per biopsia uterina	70.25
GELPI divaricatore perineale	18.56
Gemini mini pinza emost. per dissezione e passafili	12.17
GERALD pinza	10.08
GERSTER divaricatore per tenaglie	32.22
GERZOG martello	32.40
GIERTZ STILLE costotomo	56.03
GIGLI manico per sega filo	40.06
GIGLI sega filo metallico	40.06
GIL VERNET divaricatore	18.09
GILL ARRUGA pinza capsulare	43.03
GILL coltello corneale	42.05
GILL HESS pinza per iride	42.14
GILL pinza per iride	42.14
GILLIES (FRENCH) osteotomo	32.34
GILLIES pinza	10.07
GILLIES portaghi con forcipi	24.09
GILLIES uncinetto	46.25
GIRARD pinza per sutura corneodeslerale giravite	43.05 33.20
GLASER divaricatore per laminectomia	18.64
GLOVER pinza vascolare atraumatica	12.02
GLUCK costotomo	56.02
GOELET divaricatore	18.04
GOLDMAN FOX forcipi per guance	08.18
GOLDSTEIN bifarostato	42.03
goniometro	02.11
GOOD forcipi per tonsille	08.10
GOODELL dilatatore uterino	70.17
GORNEY forcipi da dissezione	08.04
GOSSET divaricatore addominale	18.44
GOURET curetta uterina	70.31
GRADLE pinza depilatoria	43.10
GRAEFE bifarostato	42.02
GRAEFE cistotomo	42.07
GRAEFE coltello per cataratta	42.04
GRAEFE curetta per cataratta	42.08
GRAEFE pinza	10.05
GRAEFE pinza fissatrice	43.03
GRAEFE pinza per iride	42.12, 42.13
GRAEFE scarificatore	42.04
GRAEFE uncinetto per iride	18.07
GRAEFE uncino da strabismo	42.07
GRAHAM divaricatore per nervi	40.05
GRARETT dilatatore vascolare	56.18
GRAVE specolo vaginale	70.02, 70.06
GRAVE specolo vaginale „view more“	70.06
GRAY pinza per il condotto biliare	12.24
GREEN ARMYTAGE pinza damp uterina	72.05
GREEN dissettore corneale	42.06
GREEN divaricatore	18.16
GREEN pinza di fissaggio	43.03
GREENE curetta uterina	70.34
GREVEN pinza per filo di metallo	44.12
grip divaricatore	18.04, 18.05, 18.07 33.14 44.08
grip pinza	33.14
GROSS curetta e uncino	44.08
GROSS MAIER pinza per polipi	16.02
GROSS MAIER pinza per tamponi	16.02
GROSS pinza per spugne	16.02
GRUBER specolo auricolare	44.02
GRUENWALD pinza nasale	46.05
guida angolare per vite per anta	34.08
guida di cateteri endotracheali	04.04

Indice alfabetico

guida di perforatore e di maschio	33.22
guida di trapano	33.25, 33.26, 34.04
guida di trapano con visore	34.04
guida per filo di metallo	33.13
guida per filo per ossa	33.05
guida telescopica sola	33.05
guida-perforatore	34.02
guida-trapani regolabile per vite femorali dinamiche	34.06
guida-trapano	34.02
GUILLEN cannula per irrigazione	46.29
GUNNAR HEY pinza mangitubo	12.32
GUTHRIE uncinetto	18.07
GUTMANN cuchiaio	66.05
GUYON candeletta dilatatrice uretrale	66.06
GUYON mandrino per cateteri	66.05
GUYON pinza per il peduncolo renale	12.24
GUYTON LUNDSGAARD sclerotomo	42.06

H

HABERER (TUFFIER) divaricatore	18.05
HABERER divaricatore malleabile	18.05
HACKSTOCK pinza piegafili	33.15
HAGLUND STILLE divaricatore per gessi	30.04
HAIGHT divaricatore	56.06
HAJEK BALLENGER elevatore per setto	46.17
HAJEK KOFLER pinza nasale tagliente	46.11
HAJEK martello	32.41
HAJEK sgorbia forma V	46.20
HAKANSSON pinza sgorbia	32.04
HALLE bisturi per duramadre	40.08
HALLE curretta malleabile	32.29
HALLE elevatore per setto	46.16
HALSEY portaghi	24.02
HALSTED micro mosquito pinza	12.04
HALSTED mosquito pinza	12.04
Hamburg cannula bottonuta	43.08
HANK dilatatore uterino	70.16
HARDY curretta malleabile	40.24
HARDY dissettore	40.24
HARDY enucleatore	40.24
HARDY FAHLBUSCH dissettore	40.24
HARDY forchetta per impiantare	40.24
HARKEN pinza per il auricolo	56.16
HARMS sonda trabecolare	42.12
HARRINGTON divaricatore	18.07
HARRINGTON pinza bronchiale	56.13
HARTMANN abbassalingua 15 cm	48.02
HARTMANN baby pinza emostatica	12.03
HARTMANN diapason	44.04
HARTMANN HALLE specolo nasale	46.02
HARTMANN HOFFMANN pinza auricolare	44.11
HARTMANN pinza auricolare	44.10, 44.11
HARTMANN pinza emostatica	12.03
HARTMANN pinza per polipi nasali	46.06
HARTMANN pinza per tonsille	50.08
HARTMANN pinza sgorbia	32.06
HARTMANN pinza tagliente nasale	46.10
HARTMANN sonda auricolare	44.07
HARTMANN specolo auricolare	44.02
HARTMANN specolo nasale	46.02
HARTMANN WULLSTEIN pinza auricolare	44.11
HARVEY forbici per filo di metallo	08.19
HATFIELD curretta per fusione spinale	32.30
HAUGH pinza auricolare	44.12
HAWKIN AMBLER dilatatore uterino	70.16
HEANEY (HEGAR) portaghi	24.05
HEANEY curretta per biopsia uterina	70.24
HEANEY divaricatore	18.19
HEANEY pinza per isterectomia	12.30
HEATH forbici per legature	08.18
HEATH martello	32.43
HEBRA curretta per calazio	42.08
HEGAR dilatatore uterino	70.14, 70.15
HEGAR portaghi	24.04, 24.05
HEGAR portaghi vascolare	24.05
HEGENBARTH pinza per agrafe	26.07
HEIFETZ pinza per tumori	11.05
HEIFETZ spatola cerebrale	40.15
HEIMING pinza per calcoli renali	62.06
HEISS pinza emostatica	12.13
HEISTER apribrocca	48.05
HELFERICH BIER sega per amputazione	33.02
HENKE elevatore per tonsille	50.02
HENLY divaricatore	18.31

HENNER (LEMPERT) divaricatore	18.29
HENNIG divaricatore per gessi	30.04
HENROTIN pinza per abbassamento del collo uterino	70.20
HERBERHOLD abbassalingua	48.10
HERRICK pinza per il peduncolo renale	12.25
HERTZLER divaricatore costale	56.11
HERZ pinza afferratendini	32.25
HESS pinza capsulare	43.04
HESS pinza per iride	42.14
HEY GROVES pinza per ossa	32.17
HEYMANN forbici nasali	08.09
HEYMANN KNIGHT pinza nasale	46.06
HEYMANN pinza tagliente nasale	46.08
HEYWOOD SMITH pinza emorroidale	68.08
HIBBS divaricatore	40.06
HIBBS osteotomo	32.38
HIBBS scalpello	32.38
HIBBS sgorbia	32.38
HIBBS valva	18.63
HIRSCHMANN anoscopio	68.05
HIRSCHMANN spatola per didadialisi	42.10
HOEN divaricatore per emilaminectomia	18.43
HOEN elevatorio per la duramadre	40.09
HOEN periototomo	32.52
HOESEL divaricatore	18.17
HOESEL portaghi	24.08
HOFFER elevatore palatale	50.02
HOFF fissateli	14.03
HOHMANN elevatore per ossa	32.53 - 32.55
HOHMANN mini elevatore per ossa	32.55
HOKE scalpello	32.37
HOLTH pinza per capsuloiroidectomia	42.11
HOLZBACH divaricatore addominale	18.58
HOPKINS coltello per gessi	30.04
HORSLEY scallatore per duramadre	40.08
HOSOBUCHI spatola biforcata	40.25
HOUSE curretta doppia	44.18
HOWARTH elevatore doppio	32.50
HRYNYSCHAK divaricatore prostatico	66.03
HUBER manico universale	52.03
HUDSON perforatore	33.05
HUMBY dermatomo	06.12
HUNT pinza per tumori	11.06
HUNTER pinza per schegge	10.12
HUPP divaricatore tracheale	54.03
HURD ago per il palato	50.03
HURD dissettore di tonsille	50.02
HUSTINX divaricatore perineale	18.56

I

I.U.D. uncinco di estrazione	70.21
INGE divaricatore vertebrale	40.16
insoffiatore	44.05
introduttore di cambre assee	34.12
introduttore di cartilagine	46.23
introduttore di chiodi flessibili midollari	34.10, 34.12
introduttore di chiodi per ossa	34.12
IOWA pinza uterina	70.19
irrigatore	88.03
IRWIN MOORE pinza nasale	46.08
ISRAEL divaricatore	18.16
isterometro	70.22
ITARD sonda auricolare	44.07
ITERSON uncinco tracheale	54.02
IVES FANSLER anoscopio	68.05

J

JACKSON BURROWS divaricatore	18.31, 32.57
JACKSON divaricatore per gozzo	18.27
JACKSON pinza per tamponi	52.02
JACKSON specolo vaginale	70.10
JACKSON tubo tracheale	54.03
JACKSON uncinco tracheale	54.02
JACOBS chiave per mandrino	33.07
JACOBS pinza uterina	70.19
JACOBSON bisturi vascolare	40.29
JACOBSON curretta	32.32
JACOBSON micro pinza	12.14
JACOBSON sonda	40.27
JAEGER cheratomo	42.04
JAEGER placca per palpebre	42.03
JAMESON forbici	08.07
JAMESON pinza muscolare	43.07

JAMESON pinza per strabismo	42.16
JAMESON uncinco per strabismo	42.07
JAMISON calibro	42.11
JAMISON portaghi	24.05
JANSEN curretta tagliente	32.31
JANSEN divaricatore	18.27
JANSEN GIFFORD divaricatore	18.27
JANSEN periototomo	32.46
JANSEN pinza auricolare	44.09
JANSEN pinza nasale	46.05
JANSEN pinza sgorbia	32.05
JANSEN STRUYCKEN pinza per setto	46.12
JANSEN WAGNER divaricatore	18.27
JARCHO pinza uterina	70.18
JATHO pinza nasofaringea	46.26
JEAN pinza di dissezione	10.06
JENNINGS apribrocca	48.06
JEWETT candeletta dilatatrice uretrale	66.08
JEWETT chiodo per il collo di femore	36.08
JEWETT conficatore e cavachiodi	34.11
JOBSON HORNE portacotone	20.06
JOHNS HOPKINS pinza emost. e di condotto biliare	12.23
JOHNS HOPKINS serrafina	12.03
JOHNSON portaghi	24.06
JOLL divaricatore per tiroide	54.04
JONES fissateli	14.02
JOSEPH (LEWIS) raspa nasale	46.21
JOSEPH bisturi nasale	46.14
JOSEPH coltello per plastica	46.13
JOSEPH elevatore per setto	46.16
JOSEPH forbici	08.06
JOSEPH lima per ossa	46.20
JOSEPH MASING elevatore per periototomo	46.17
JOSEPH periototomo	46.16
JOSEPH sega nasale	46.23
JOSEPH uncinco per la mucosa	18.07
JUDD ALLIS pinza per afferrare intestini e tessuti	64.02
JUDD MASSON divaricatore vescicale	66.03
JUERS pinza auricolare per filo di metallo	44.12
JULIAN port'aghi	24.05
JURASZ pinza per polipi larlaringei	52.02

K

KABIERESKE insoffiatore	44.05
KADER spatola	18.20
KALLMORGEN specolo vaginale	70.09
KALLMORGEN valva vaginale	70.09
KALT ARRUGA portaghi	24.10
KALT pinza capsulare	43.04
KALT portaghi	24.10
KANE pinza ombelicale	72.05
KANTROWITZ pinza emostatica e passafili	12.20
KATZIN forbici corneali	09.03
KEITH ago di sutura	26.06
KELLY divaricatore	18.05, 18.18
KELLY forbici per fistole	08.13
KELLY GRAY curretta uterina	70.23
KELLY pinza emostatica	12.05, 12.15
KELLY pinza per polipi uterini	70.20
KELLY protoscopio	68.05
KELLY RANKIN pinza emostatica	12.05
KERBOUL placca omerale epicondiale	36.22
KERBOUL placca prossimale per umero	36.22
KERBOUL placca radiale	36.22
KERBOUL placca tibiale	36.22
KERN tenaglio per ossa	32.16
KERPEL curretta tagliente	32.27
KERRISON pinza tagliente per il setto	46.11
KEVORKIAN curretta per biopsia uterina	70.23
KEVORKIAN Pacific pinza per biopsia uterina	70.27
KEVORKIAN pinza per biopsia uterina	70.26
KEVORKIAN punta di pinza per biopsia uterina	70.28
KEY elevatorio	32.50
KEYES manico	74.03
KEYES trefina cutanea	74.03
KIELLAND forcipe	72.02
KIELLAND LUKART forcipe	72.03
KILLIAN cannula da irrigazione	46.13
KILLIAN CLAUSS sgorbia	46.20
KILLIAN elevatore per il setto	46.17
KILLIAN forbici per il setto	46.11
KILLIAN pinza per il setto	46.07
KILLIAN sgorbia per il setto	46.20
KILLIAN specolo per il setto	46.04
KILNER divaricatore nasale	46.24

Indice alfabetico

KILNER DOUGHTY abbassalingua	48.08	LANDOLT enudeatore malleabile	40.25	LOGAN divaricatore	18.26
KILNER DOUGHTY apribocca	48.08	LANDOLT manico per bisturi micro	06.08	LORDAN pinza per calazio	43.06
KILNER forbici	08.06	LANDOLT pinza per afferrare tumori	40.18	LORENZ forbici per bendaggi	08.21
KILNER portaghi	24.03	LANDOLT REULEN aurette	40.25	LORNA (EDNA) fissateli	14.03
KILNER uncinetto per pelle	74.02	LANDOLT REULEN rasoio	40.25	LORTAT JACOB telaio per strumenti	88.23
KIRBY ARTHUR pinza per iride	42.15	LANDOLT REULEN uncino	40.25	LOUTE tendifilo	33.13
KIRK martello	32.40	LANDOLT uncino	40.25	LOVE divaricatore uvulare	50.02
KIRSCHNER arco da estensione	33.12	LANE (PAUCHET) fissateli	14.04	LOVE divaricatore di radici di nervi	40.06
KIRSCHNER arco da estensione modello americano	33.12	LANE divaricatore	18.03	LOVE GRUENWALD pinza per laminectomia	40.17
KIRSCHNER divaricatore addominale	18.48	LANE elevatore per ossa	32.56	LOVELACE pinza emostatica	12.10
KIRSCHNER perforatore con guida telescopica	33.05	LANE giravite	33.20	LOVELACE pinza polmonare	56.13
KIRSCHNER perforatore filiforme	33.10	LANE pinza	10.05	LOWER pinza per condotto biliare	12.23
KIRSCHNER protettore	26.04	LANE pinza damp stomacale	64.11	LOWMAN HUGLUND tensore per ossa	32.22
KIRSCHNER sonda conduttrice	26.04	LANE tenaglia per ossa	32.16	LOWMAN tenaglia per ossa	32.22
KIRSCHNER telaio di divaricatore addominale	18.48, 18.49	LANG curetta e dissettore per sacco lacrimale	42.09	LUBET BARBON pinza per polipi nasali	46.06
KLAPP divaricatore per guaine tendinee	18.12	LANGE HOHMANN elevatore per ossa	32.54	LUCAE ago da paracentesi	44.07
KLEINERT KUTZ cesoia per ossa	32.14	LANGE punta di pinza	52.03	LUCAE diapason	44.05
KLEINSASSER laringoscopia	52.05	LANGENBECK coltello di resezione	06.10	LUCAE martello	32.41
KLEINSCHMIDT pinza per apendice	64.04	LANGENBECK coltello per lobi	06.11	LUCAE pinza auricolare	44.09
KLINKENBERGH LOTH forcipe toracica	08.16	LANGENBECK curretta auricolare	44.08	LUER divaricatore	18.03
KLEINERT KUTZ pinza afferratendini	32.25	LANGENBECK ditale	48.12	LUER KOERTE cucchiaino per calcoli biliari	62.04
KNAPP coltello per iridectomia	42.05	LANGENBECK divaricatore	18.13, 18.14	LUER pinza emorroidale	68.08
KNAPP curretta per cataratta	42.08	LANGENBECK elevatorio	32.46, 32.49	LUER pinza sgorbia	32.03
KNAPP divaricatore	42.07	LANGENBECK GREEN divaricatore	18.10	LUER tubo tracheale	54.03
KNAPP LUER pinza per trichiasi	43.07	LANGENBECK MANNERFELDT divaricatore	18.25	LUKART BILL trattore	72.04
KNAUS bisturi vascolare	40.29	LANGENBECK mini divaricatore	18.10	LUKART McLEAN forcipe	72.03
KNIGHT pinza tagliente nasale	46.08	LANGENBECK periostotomo	32.46	LUNDSGAARD sderotomo	42.06
KNIGHTON divaricatore per laminectomia	18.35	LANGENBECK portaghi	24.07	LUNIATSCHEK otturatore per garza	50.03
KNOLLE uncino smusso	42.07	LANGENBECK sega a dita	33.03		
KNOWLES forbici per bende	08.21	laringoscopia	04.05, 04.06, 52.05, 52.06		
KOCHER divaricatore	18.11, 18.14, 18.17, 18.28	latte per strumenti	88.23		
		LAWRENCE pinza emost. di dissezione e passafili	12.19		
KOCHER divaricatore per gozzo	18.28	LE MEE abbassalingua	48.03		
KOCHER LANGENBECK divaricatore	18.15	LEBSCHKE scalpello di sterno	32.38		
KOCHER Nippon pinza emostatica	12.07	LEE forcipe	72.02		
KOCHER pinza emostatica	12.08	LEECH WILKINSON cannula intra uterina	70.30		
KOCHER pinza intestinale	64.05, 64.06	LEFORT condeletta dilatatrice uretrale	66.08		
KOCHER sonda per gozzo	54.04	LEGUEU divaricatore vescicale	66.04		
KOCHER spatola vescicale	66.03	LEKSELL (STILLE) pinza sgorbia	32.09		
KOENIG ago da sutura	26.06	LEKSELL pinza sgorbia	32.09		
KOENIG divaricatore	18.10	LEMMON avvicinatore dello sterno	56.12		
KOENIG elevatore	32.50	LEMPERT curretta	32.29		
KOENIG protettore	26.04	LEMPERT elevatore	44.19		
KOENIG sonda conduttrice	26.04	LEMPERT pinza sgorbia	32.04		
KOERTE divaricatore	18.17, 18.26	LERCHE pinza	10.05		
KOGAN endospecolo cervicale	70.13	LERICHE divaricatore addominale	18.19		
KONRICH tamburo da sterilizzazione	88.05	LERICHE pinza emostatica	12.12		
KOOS bisturi vascolare	40.29	LESTER pinza fissatrice	43.03		
KRAUSE punta di pinza	52.03	leva per corpi estranei	44.10		
KRAUSE serranodi auricolare	44.09	LEVINSON ago per corpi estranei	42.06		
KRAUSE serranodi nasale	46.13	LEWIN tenaglia per ossa	32.19		
KRAYENBUHL uncinetto per nervi	40.26	LEXER forbici	08.04		
KRESSNER pinza per il setto nasale	46.10	LEXER osteotomo	32.37		
KRISTELLER specolo vaginale	70.08	LEXER scalpello	32.36		
KRISTELLER valva vaginale	70.07 - 70.09	LEXER sgorbia	32.36, 32.37		
KROENLEIN pinza emostatica	12.11	LEYLA sistema di divaricatori	40.10 - 40.14		
KRONECKER ago	26.02	LICHTENBERG portaghi	24.08		
KUEMMEL divaricatore addominale	18.19	LICHTWITZ ago per il seno mascellare	46.13		
KUENTSCHER chiodo centroamidollare	36.04 - 36.06	LICHTWITZ trequarti per il seno mascellare	22.03		
KUENTSCHER strumento per conficcare chiodi	33.19	ligatore aspiratore emorroidale	68.10		
KUHNT coltellino corneale	42.06	ligatore emorroidale	68.09		

KOCHER LANGENBECK divaricatore	18.15	latte per strumenti	88.23		
KOCHER Nippon pinza emostatica	12.07	LAWRENCE pinza emost. di dissezione e passafili	12.19		
KOCHER pinza emostatica	12.08	LE MEE abbassalingua	48.03		
KOCHER pinza intestinale	64.05, 64.06	LEBSCHKE scalpello di sterno	32.38		
KOCHER sonda per gozzo	54.04	LEE forcipe	72.02		
KOCHER spatola vescicale	66.03	LEECH WILKINSON cannula intra uterina	70.30		
KOENIG ago da sutura	26.06	LEFORT condeletta dilatatrice uretrale	66.08		
KOENIG divaricatore	18.10	LEGUEU divaricatore vescicale	66.04		
KOENIG elevatore	32.50	LEKSELL (STILLE) pinza sgorbia	32.09		
KOENIG protettore	26.04	LEKSELL pinza sgorbia	32.09		
KOENIG sonda conduttrice	26.04	LEMMON avvicinatore dello sterno	56.12		
KOERTE divaricatore	18.17, 18.26	LEMPERT curretta	32.29		
KOGAN endospecolo cervicale	70.13	LEMPERT elevatore	44.19		
KONRICH tamburo da sterilizzazione	88.05	LEMPERT pinza sgorbia	32.04		
KOOS bisturi vascolare	40.29	LERCHE pinza	10.05		
KRAUSE punta di pinza	52.03	LERICHE divaricatore addominale	18.19		
KRAUSE serranodi auricolare	44.09	LERICHE pinza emostatica	12.12		
KRAUSE serranodi nasale	46.13	LESTER pinza fissatrice	43.03		
KRAYENBUHL uncinetto per nervi	40.26	leva per corpi estranei	44.10		
KRESSNER pinza per il setto nasale	46.10	LEVINSON ago per corpi estranei	42.06		
KRISTELLER specolo vaginale	70.08	LEWIN tenaglia per ossa	32.19		
KRISTELLER valva vaginale	70.07 - 70.09	LEXER forbici	08.04		
KROENLEIN pinza emostatica	12.11	LEXER osteotomo	32.37		
KRONECKER ago	26.02	LEXER scalpello	32.36		
KUEMMEL divaricatore addominale	18.19	LEXER sgorbia	32.36, 32.37		
KUENTSCHER chiodo centroamidollare	36.04 - 36.06	LEYLA sistema di divaricatori	40.10 - 40.14		
KUENTSCHER strumento per conficcare chiodi	33.19	LICHTENBERG portaghi	24.08		
KUHNT coltellino corneale	42.06	LICHTWITZ ago per il seno mascellare	46.13		

		ligatore aspiratore emorroidale	68.10		
		ligatore emorroidale	68.09		
		lima per ossa	32.59, 46.20		
		lima per unghie	74.04		
		LISTER (sinus) pinza per medicazione	16.04		
		LISTER BURCH blefarostato	42.03		
		LISTER forbici per bendaggi	08.20		
		LISTON cesoia per ossa	32.13		
		LISTON coltello per amputazione	06.10		
		LITTAUER forbici per legature	08.18		
		LITTAUER pinza auricolare	44.10		
		LITTAUER pinza depilatoria	43.10		
		LITTAUER pinza per polipi nasali	46.06		
		LITTLE divaricatore	18.12		
		Little Joker periostotomo	32.46		
		LITTLER forbici	08.04		
		LITTLEWOOD pinza per tessuti	64.04		
		LLOYD DAVIS (GOLIGHER) forbici rettili	08.16		
		LLOYD DAVIS pinza per anastomosi	64.08		
		LLOYD DAVIS pinza per biopsia	68.07		
		LLOYD DAVIS protoscopia per bambini	68.04		
		LLOYD DAVIS rettoscopio	68.04		
		LLOYD DAVIS sigmoiscopio	68.04		
		LLOYD DAVIS strumento da conficcare chiodi	34.11		
		LOCKHART MUMMERY sonda	20.04		
		LOCKLIN forbici dentellate	08.07		
		LOCKWOOD ALLIS pinza intestinale	64.03		

		MANCINI pinza per introdurre sonde	04.04		
		MAIER pinza per polipi	16.02		
		MAINGOT pinza intestinale	10.10		
		MAINGOT pinza per isterectomia	12.30		
		MAISONNEUVE uretrotomo	66.04		
		MALIS divaricatore cerebrale	18.61		
		MALTZ (AUFRIECHT) raspa nasale	46.20		
		MALTZ (COTTLE) raspa nasale	46.21		
		manicini, forbici per	08.02, 08.03, 08.05, 08.07, 08.20		
		manicini, port'aghi per	24.02 - 24.04		
		mandrino Jacobs	33.07		
		mandrino per sonde di gomma	66.05		
		mandrino per sonde tracheali	04.04		
		manico con mandrino	33.06, 33.08		
		manico di bisturi	06.02 - 06.04, 06.06		
		manico di bisturi micro	06.08		
		manico di scalpello intercambiabile	32.33		
		manico di specchi laringei	52.07		
		manico per maschiatori	33.08		
		manico per sega filo	40.06		
		manico per specchi laringei	52.07		
		manico per tiravene	20.05		
		manico per trefine cutanee	74.03		
		manico T con mandrino veloce DHS	34.07		
		manico universale HUBER	52.03		
		MANNERFELDT divaricatore	18.24, 18.25		
		mano di piombo	32.22		
		marcatore	42.11		
		MARKHAM MEYERDING divaricatore	18.38		
		MARKWALDER pinza sgorbia	32.13		
		MARSCHIK pinza tonsillare	50.05		
		MARTEL pinza per il cuoio capelluto	12.10		
		martello di percussione	02.10, 02.11		
		martello diapason	34.04		
		martello intranasale	32.44		
		martello per ossa	32.40 - 32.44		
		MARTIN divaricatore	18.18		
		MARTIN isterometro	70.22		
		MARTIN pelvimetro	72.05		
		MARTIN pinza per abbassare il collo uterino	70.17, 70.19		
		MARTIN pinza per medicatura	16.06		
		MARTIN tenaglia per cartilagine	32.20		
		MARTINI curretta doppia	32.32		
		maschera di foratura manuale	33.06		
		maschiatore	33.08		
		maschio per viti perforate	33.22		
		MASING elevatore per periostio	46.17		
		Mass. Gen. Hospital portaghi	24.06		
		MASSON portaghi	24.05		
		MASTIN pinza muscolare	54.04		
		MATHIEU divaricatore	18.03		
		MATHIEU pinza per corpi estranei	66.04		

Indice alfabetico

MATHIEU portaghi	24.08
MATHIEU specolo rettale	68.03
MATSON ALEXANDER peristotomo	32.48
MATSON peristotomo	32.48
MAUNDER apribocca di legno	48.12
MAY oftalmoscopia	02.07
MAY oto-oftalmoscopia	02.07
MAYFIELD pinza sgorbia	32.11
MAYO (HARRINGTON) forbici	08.03
MAYO ADAMS divaricatore	18.30
MAYO BLAKE pinza per calcoli biliari	62.02
MAYO COLLIN divaricatore	18.02
MAYO cucchiaino per calcoli biliari	62.04
MAYO forbici	08.03
MAYO GUYON pinza per il peduncolo renale	12.24
MAYO HEGAR portaghi	24.04
MAYO NOBLE forbici	08.04
MAYO pinza modello russo	10.06
MAYO pinza per sterilizzazione	28.02
MAYO ROBSON pinza intestinale	64.07, 64.12
MAYO sonda per calcoli biliari	62.04
MAYO STILLE forbici	08.03
McCREA candeletta dilatatrice uretrale	66.08
McCULLOUGH pinza per strabismo	42.16
McDONALD elevatore	32.50
McGEE pinza per filo di metallo	44.12
McGEE uncinetto	44.18
McGIVNEY (SCHÜTZ) ligatore emorroideale	68.09
McGIVNEY pinza afferrante	68.08
McGUIRE forbici corneali	08.15, 09.02
McINDOE cesoia per ossa	32.14
McINDOE pinza di dissezione	10.07
McINTOSH laringoscopia	04.05
McIVOR abbassalingua	48.08
McIVOR apribocca	48.08
McKENTY elevatore per il setto	46.15
McKENZIE perforatore	33.05
McKENZIE pinza per applicare agrafe	40.02
McKENZIE supporto portaagrafe	40.03
McKENZIE trapano	33.05
McKISSOCK forbici per la duramadre	08.15
McLAUGHLIN placca	36.07
McLEAN forcipe	72.03
McLEAN LUKART forcipe	72.03
McLEAN TUCKER forcipe	72.03
McPHERSON pinza per legatura	43.05
MEAD martello	32.42
MEAD pinza sgorbia	32.02
Med-i-Tape per identificare strumenti	88.10
MEEKER pinza emostatica, dissettore e portafilii	12.19
MELLINGER AXENFELD blefarostato	42.02
MELLINGER blefarostato	42.02
MENGHINI ago per la puntura del fegato	22.05
MENGHINI siringa	22.05
MENGHINI trequarti per aghi da puntura meniscotomo	32.58
MERCEDES divaricatore di torace	56.08
METZENBAUM forbici	08.05
METZENBAUM portaghi	24.06
MEYER pinza per riposizione	32.21
MEYERDING divaricatore	18.12, 18.21, 18.38, 18.63
MEYHOEFER curretta per calazio	42.08
MICHEL agrafo	26.08
MICHEL pinza combinata per agrafo	26.07
MICHEL specchio postrinoscopico	46.05
micro forbici	09.04
micro mosquito pinza	12.04
micro pinza di dissezione	10.03, 10.04, 11.02
micro pinza emostatica	12.04, 12.14
MICULICZ pinza per peritoneo	12.26
MIDDELDORPF divaricatore	18.16, 18.22
MIDDLETON JANSEN pinza tagliente	46.12
MIKULICZ baby pinza per peritoneo	12.26
MIKULICZ divaricatore	18.18
MIKULICZ pinza per peritoneo	12.26
MILAN curretta di biopsia uterina	70.24
MILLIGAN dissettore di duramadre	40.07
MILLIN divaricatore per il collo della vescica	66.04
MILLIN pinza per capsula	66.02
MILLIN pinza per lobuli	66.02
MILLIN tubo di aspirazione	04.03
mini container	88.19
mini divaricatore	18.03, 18.10
mini elevatore per ossa	32.55
mini lampada frontale	02.06

mini osteotomo	32.36
mini pinza di biopsia uterina	70.27
mini pinza sgorbia	32.02
mini scalpello	32.36
mini set per vari	20.04
mini sgorbia	32.36
MISKIMON divaricatore cerebellare	18.30
misuratore di profondità per vite per ossa	33.25
MIXTER baby pinza emostatica	12.21
MIXTER O'SHAUGNESSY pinza	12.22
MIXTER passafilii	12.20
MIXTER pinza emostatica, bronchiale e passafilii	12.21, 12.22
MIXTER pinza per calcoli biliari	62.02
MOCK ago di irrigazione con eparino	22.04
MOELTGEN goniometro	02.11
MOLLISON divaricatore	18.34
MOORE cucchiaino per calcoli biliari	62.02
MOORE perforatore a mano	33.04
MOORFIELD pinza per sutura	43.05
MORITZ SCHMIDT abbassalingua	48.03
MORRIS divaricatore	18.18
MORSE divaricatore costale	56.08
MORSE FAVALORO divaricatore costale	56.09
mosquito pinza emostatica	12.04, 12.09
motore a mano elettrico	33.07
MOYNIHAN fissateli	14.04
MOYNIHAN pinza clamp	12.23
MOYNIHAN pinza emostatica	12.07
MOYNIHAN sonda per calcoli biliari	62.03
MUCK coltello periostale	44.19
MUELLER blefarostato	42.03
mulino per ossa	32.60
München curretta per biopsia	70.23
MURDOCK blefarostato	42.02
MURPHY divaricatore	18.12
MURPHY LANE elevatore doppio (bone skid)	32.52
MUSEUX pinza per abbassare il collo uterino	70.17, 70.19
MYERS tiravene	20.03
MYLES cannula da irrigazione	46.29
MYLES pinza nasale tagliente	46.10

N

NABATOFF set per vari	20.03
NAEGELE forcipe	72.02
NAGER ago per tonsille	50.03
NAGER divaricatore palatale	50.02
nastro metrico cm/pollici	02.12
nastro per ossa	32.22
NATIONAL HOSPITAL martello percussore	02.11
NAUNTOM MORGAN portaghi	24.07
NEFF meniscotomo	32.58
NEGUS pinza tonsillare	12.15
NEGUS supporto contro-petto per apribocca	48.11
NEIVERT divaricatore	46.25
NEIVERT portaghi	24.02
NELATON sonda scanalata	20.02
NELSON ago di legatura	26.02
NELSON pinza	10.09
NELSON trequarti toracico	22.03
neodisher® detergente per la pulizia degli strumenti	88.23
neodisher® IP spray lubrificante per strumenti	88.23
NICOLA curretta per ipofisectomia	40.24
NICOLA raspatorio per ipofisectomia	40.24
Nippon pinza emostatica	12.07
NISSEN pinza emostatica	12.14
NISSEN pinza per coledoco	12.21
NORFOLK and NORWICH divaricatore	18.36
NORTHBENT (SPENCER) forbici per legature	08.17
NORTHFIELD divaricatore	18.35
NORTHFIELD pinza sgorbia	32.07
NOTO pinza per polipi uterini	70.20
NOVAK curretta di aspirazione	70.23
NOYES forbici per iride	09.02
NOYES pinza per polipi nasali	46.07
NUGENT pinza oftalmica	42.16

O

OCHSNER pinza per legatura	26.07
OCHSNER sonda per calcoli biliari	62.02
OCHSNER trequarti toracico	22.03
O'CONNOR uncino per iride	42.07
OETTINGEN divaricatore oftalmoscopia	18.60, 02.07

OLDBERG pinza per laminectomia	40.18
oliva auricolare	44.06
oliva nasale	44.06
OLIVECRONA coltello dil trigemino	40.09
OLIVECRONA dissettore di duramadre	40.07
OLIVECRONA pinza sgorbia	32.04
OLIVECRONA sego di filo di metallo	40.06
OLIVECRONA spatola cerebrale	40.15
OLIVECRONA TOENNIS pinza per agrafo	40.03
OLLIER divaricatore	18.16
OLSEN HEGAR portaghi	24.08
OMBREDANNE martello	32.40
OMBREDANNE pinza per afferrare tessuto osteotomo	64.03, 32.33 - 32.38
O'SULLIVAN O'CONNOR divaricatore addominale	18.43
O'SULLIVAN O'CONNOR specolo vaginale	70.13
OTIS candeletta dilatatrice uretrale	66.08
OTIS uretrotomo	66.04
otoscopia	02.06
otturatore per garza	50.03
OVERHOLT baby pinza emostatica	12.15
OVERHOLT GEISSENDOERFER pinza	12.16
OVERHOLT MIXTER pinza passafilii	12.21
OVERHOLT peristotomo	32.48
OVERHOLT pinza passafilii	12.16

P

padrone guida condilare	34.06
padrone malleabile per piegare placche	33.22
padrone per posizionare impianti	34.05, 34.06
PALMER chiodo per ossa	36.07
PALMER introduttore per chiodi	34.12
PALMER strumento per conficcare chiodi	34.12
panno di sterilizzazione	88.10
PAPAVERO CASPAR specolo	40.23
PARHAM nastro per ossa	32.22
PARHAM tiranastro	32.22
PARK blefarostato	42.03
PARKER bisturi	06.10
PARKER divaricatore	18.02
PARKER MOTT divaricatore	18.02
PARTSCH martello	32.41
PARTSCH scalpello	32.34
PARTSCH sgorbia	32.34
PASSOW scalpello emostatico	44.19
PATON dissettore corneale	42.06
PAUFIQUE coltello per cheratoplastica	42.06
PAUFIQUE pinza per legature	43.05
PAYR schiacciatore intestinale	64.12
PAYR sonda conduttrice di legature	26.04
Pazific KEVORKIAN pinza per biopsia uterina	70.27
PEAN Nippon pinza emostatica	12.07
PEAN pinza emostatica	12.07, 12.08, 12.11
PEAN pinza emostatica fino	12.08
PEDERSON specolo vaginale	70.02
PEERS BERTRAM pinza fissateli	14.03
PEET pinza per schegge	10.13
PELKMANN pinza per polipi pelvimetro	16.04, 72.05
pelvimetro	72.05
pelvimetro per misurare all'interno	72.05
PENFELD scollatore	40.08
PENFIELD dissettore per duramadre	40.08
PENNINGTON pinza emostatica	12.10
PENNYBACKER pinza sgorbia	32.06
PERCY retrattore per amputazione perforatore	33.02, 33.05
perforatore a mano	33.04 - 33.06
perforatore con guida telescopica	33.05
perforatore con mandrino Jacobs	33.06
perforatore filiforme per ossa	33.10
perforatore per unghie	33.03
PERTHES alesatore	33.10
PERTHES perforatore	33.10
PESTALOZZA curretta per aborto	72.06
PETRI scatola con coperchio	88.04
PHANEUF pinza per peritoneo	12.27
piastra per tendere la pelle	06.11
pick per microchirurgia	44.17, 44.18
piegatore per chiodi centromidollari	34.10
PIERCE trequarti per il seno mascellare	22.02
PIFFARD curretta per lupus	74.02
PINARD fonendoscopia	02.09
pinza a becchi piatti per filo di metallo	33.14 - 33.16
pinza a becchi tondi	33.14

Indice alfabetico

pinza afferratendini	32.23 - 32.25	pinza per capsuloidiectomia	42.11	pinze auricolare per la microchirurgia	44.15, 44.16
pinza atraumatica di dissezione	11.03, 11.04, 11.06	pinza per entropio	43.07	pinze per coagulazione bipolare	92.04 - 92.05
pinza auricolare	44.10 - 44.16	pinza per estrarre fili Kirschner	33.14	pinze per coagulazione monopolare	92.03
pinza auricolare (dissezione)	44.09	pinza per falanghi	32.20	pinze di dissezione	10.02 - 11.06
pinza auricolare micro	44.12 - 44.15	pinza per gessi	30.04	pinze per isterectomia	12.27
pinza auricolare micro-mini	44.16	pinza per il condotto biliare	12.22 - 12.24	pinza per afferrare il gozzo	54.04
pinza auricolare per filo di metallo	44.12	pinza per il cuoio capelluto	12.10	PIPER forcipe	72.04
pinza auricolare per la testa del martello	44.13	pinza per il peduncolo renale	12.24, 12.25	placca angolare	36.18
pinza bronchiale	12.18, 56.13, 56.14	pinza per il rectus	43.02	placca angolare di compressione	36.15
pinza bulldog atraumatica	12.02	pinza per impiantare lente	42.18	placca angolare per osteomie introtrochanteriche	36.18, 36.19
pinza capsulare	43.03, 43.04	pinza per introdurre sonde	04.04	placca cervicale	36.23
pinza clamp stomacale	64.11	pinza per ipofisi	40.09	placca cobra	36.20
pinza clamp uterino	72.05	pinza per iride	42.12 - 42.15, 42.17	placca condilea di compressione	36.15
pinza da biopsia uterina	70.24 - 70.28	pinza per isterectomia	12.27, 12.28, 12.30	placca condiloidea di compressione	36.09
pinza da craniotomia	40.07	pinza per la camera anteriore	43.02	placca cuchiaio	36.22
pinza da dissezione modello russo	10.06	pinza per la vena cava	56.15	placca di comp. dinamica per il collo del femore	36.08
pinza da dissezione modello USA	10.02	pinza per lacerazione di unghie	33.03	placca di ricostruzione pelvica	36.14
pinza da escissione	64.09	pinza per laminectomia	40.17	placca di sostegno condiloideo	36.20
pinza da legatura	43.05	pinza per laringo-bronco- esofagoscopia	52.04	placca di supporto L	36.23
pinza da peritoneo	12.26	pinza per legatura	26.07	placca femorale anatomica	36.21
pinza da posizionare e tagliare agrafe p. cuoio capelluto	40.04	pinza per lobuli anteriori	66.02	placca forma T	36.17, 36.22
pinza da riduzione	32.20, 32.21	pinza per medicature	16.06	placca L di supporto	36.23
pinza da sterilizzazione	28.02	pinza per medicazione	16.04	placca larga di allungamento	36.20
pinza depilatoria	43.10	pinza per parametrio	12.29	placca larga di compressione	36.14
pinza di anastomosi	64.10	pinza per peritoneo	12.27	placca omerale epicondylare	36.22
pinza di avanzamento	43.07	pinza per peritoneo	12.26, 12.27	placca ossea 1/2 tubulare	36.14
pinza di clavicola	32.21	pinza per piegare placche	33.21, 33.22	placca ossea 1/3 tubulare	36.16
pinza di coledoco	12.21	pinza per piegare placche per ossa	33.21	placca ossea 1/4 tubulare	36.16
pinza di columella	46.26	pinza per polipi	16.02, 16.04 - 16.06	placca per dita mini	36.16
pinza di dissezione micro	10.04	pinza per polipi laringei	52.02	placca per la spina cervicale	36.24
pinza di legatura	43.05	pinza per polipi nasali	46.06, 46.07	placca per miniframmenti	36.16, 36.17
pinza di orologio	10.11	pinza per polipi uterini	16.02, 16.03, 16.06, 70.20	placca per multiframmenti	36.16
pinza di pericranio	72.05	pinza per posizionare agrafe cervicali	40.02	placca per ossa	36.14 - 36.24
pinza di pressione progressiva	12.09	pinza per posizionare pinze bulldog	12.02	placca per osteomie intertrochanteriche di comp.	36.18
pinza di riduzione	32.20, 33.21	pinza per radizzare il setto	46.25	placca per palpebre	42.03
pinza di sutura	43.05	pinza per rifiuti	28.02	placca per piccoli frammenti	36.16, 36.17
pinza di trazione craniale	40.04	pinza per ritorcere fili di metallo	33.15	placca prossimale per omero	36.22
pinza emorroidale	68.08	pinza per ritorcere tendini	32.24	placca radiale	36.22
pinza emostatica	12.03 - 12.30	pinza per schegge	10.13	placca spinale dorsale	36.23
pinza emostatica e di condotto biliare	12.23	pinza per schegge	10.12, 10.13	placca stretta di allungamento	36.20
pinza emostatica e portalegature	12.14, 12.15	pinza per sequestri	32.21	placca stretta di compressione	36.14
pinza emostatica per tonsille	12.15	pinza per setto e vomer	46.07, 46.08	placca tibiale	36.21, 36.22
pinza emostatica per tonsille	12.17	pinza per spugne	46.10	placca tibiale anatomica	36.21
pinza emostatica toracica	12.03	pinza per strabismo	16.02 - 16.04	placca tibiale laterale	36.23
pinza emostatica vascolare	46.07	pinza per sutura	42.16	placca trapezoidale per osteosintesi	36.24
pinza etmoidale	14.02 - 14.04	pinza per sutura corneosclerale	10.11	placca trifoglio	36.16
pinza fissatili	43.03	pinza per tamponi	43.05	placche per dita	36.07 - 36.09
pinza fissatrice	40.04	pinza per tamponi amfetici	16.02, 52.02	placche per ossa	36.14 - 36.24
pinza guida-trapani	64.05 - 64.12	pinza per tamponi laringali	88.04	PLESTER coltello lobare	44.17
pinza intestinale	70.21	pinza per tamponi nasali	52.02	PLESTER divaricatore	18.29
pinza isterolobo	52.04	pinza per tonsille	46.06	PLESTER tubo di aspirazione	44.06
pinza microlaringoscopica	43.02, 43.07, 54.04	pinza per torcere fili per ossa	50.04, 50.05	PLEY bifurcato	42.03
pinza muscolare	46.05 - 46.12	pinza per tumori	33.15	POLITZER ago da paracentesi	44.08
pinza nasale	46.09	pinza polmonare	11.05, 11.06	POLITZER coltello auricolare	44.08
pinza nasale tagliente	72.05	pinza portafillo	56.13	POLITZER insufflatore di aria	44.06
pinza ombelicale	32.04	pinza portaoggetti universale	66.02	POLITZER strumento da paracentesi	44.08
pinza ossivora	12.16, 12.21	pinza portaplacche	28.02	POLLOSON divaricatore	18.23
pinza passafili	32.23, 32.24	pinza portasiringhe	33.21	POOLE tubo di aspirazione	04.02
pinza per abbassare il collo dell'utero	70.17 - 70.20	pinza portavite	28.02	POPPEL cannula di aspirazione	40.15
pinza per aborto e placenta	72.06	pinza quadrettata	33.21	portagrafe di sutura cerebrale	40.03
pinza per afferrare glans e prepuzio	66.05	pinza serrapene	10.06	portacatone	20.06
pinza per afferrare i bordi della ferita	26.07	pinza serratubi	66.05	portaghi	24.02 - 24.12
pinza per afferrare intestini e tessuti	64.02 - 64.04	pinza sgorbia	12.30, 12.31	portaghi con forbici	24.09
pinza per afferrare la capsula retropubica	66.02	pinza tagliafilii	32.02 - 32.12	portaghi micro	24.12
pinza per afferrare organi	64.04	pinza tagliente forata longitudinalmente	33.14, 33.16 - 33.18	portaghi mancini	24.02 - 24.04
pinza per afferrare ossa	32.15 - 32.22	pinza tagliente nasale	33.18	portaghi vascolare	24.05
pinza per afferrare prostata	66.02	pinza tagliente per dischi intervertebrali	46.06, 46.08 - 46.12	portalegatura per ipofisectomia	40.26
pinza per afferrare tessuti per biopsia	68.07	pinza tagliente per il seno mascellare	40.17 - 40.22	portapinze	64.10
pinza per afferrare tonsille	50.05	pinza tagliente per il setto	46.12	POTTS DE MARTEL forbici vascolari	08.10
pinza per afferrare tumori	40.18	pinza tagliente per il setto nasale	46.12	POTTS SMITH forbici vascolari	08.10
pinza per agrafe	26.07, 26.08	pinza tagliente per ipofisectomia	46.11, 46.12	POTTS SMITH pinza	10.02
pinza per agrafe da sutura cerebrale	40.02, 40.03	pinza tagliente per laminectomia	40.18	POZZI pinza per abbassare il collo uterino	70.18
pinza per ammaccare il setto	46.10	pinza tagliente per setto	40.17	PRATT (BILLROTH) pinza uterina	70.19
pinza per anastomosi	56.15, 56.16, 64.08	pinza tagliente per tonsille	40.18	PRATT dilatatore uterino	70.16
pinza per appendice	64.04	pinza tendifili	40.17 - 40.22	PRATT pinza emostatica	12.10
pinza per auricola	56.16	pinza tiralingua	46.07	PRATT specolo rettale	68.02
pinza per avanzamento	43.02	pinza toracica	50.08	PRATT uncino cistico	68.06
pinza per biopsia rettale	68.06, 68.07	pinza uro-tangenziale	33.13	PRICE THOMAS pinza bronchiale	56.14
pinza per biopsia uterina	70.24 - 70.28	pinza vascolare atraumatica	48.04	PRINCE forbici per tonsille	08.10
pinza per calazio	43.06	pinza per corpi estranei	12.17	PRINCE pinza muscolare	43.02
pinza per calcoli biliari	62.02		12.25	protoscopio	68.04, 68.05
pinza per calcoli renali	62.05, 62.06		12.02	protettore delle pinne del naso	46.25
			66.04	protettore di tessuto	33.24, 33.26
				protettore per tessuto e guida-trapano	33.26
				PROVIDENCE HOSPITAL pinza emostatica	12.06
				pulitore il canale delle vite forate	33.23

Indice alfabetico

punta a spirale di perforatore a mano	33.04, 33.05
punta di cacciavite	33.20
punta di pinza laringeale	52.03
punzione midollare	33.18
PUTTI lima per ossa	32.59
PYE SMITH (HARRISON) pinza portastrumenti	28.02

Q

QUERVAIN elevatore	32.50
QUINBY forbici per guance	08.19
QUIRE leva per corpi estranei auricolari	44.10
QUISLING martello intranasale	32.44

R

rachiotomo	32.38
RADOLF pinza per lacerazione delle unghie	33.03
RAGNELL DAVIS divaricatore	18.05
RAMEL ago di biopsia	22.04
RAMPLEY pinza per spugne	16.03
RAMSAY pinza di dissezione	10.06
RANDALL curetta di biopsia uterina aspirante	70.23
RANDALL pinza per calcoli renali	62.05
RANEY agrafe emostatica per il cuoio capelluto	40.04
raschiatoio di lupus	74.02
rasoio	06.13
raspa nasale	46.20 - 46.22
raspa per il seno frontale	46.22
raspa per il seno mascellare	46.20
raspatorio per ipofisectomia	40.25, 40.25, 40.27, 40.28
raspino micro per ipofisectomia	40.27
RAY curetta	40.24, 40.28
RECAMIER curetta uterina	70.32
recipiente cilindrico	88.04
regolo	02.12
REICHERT depressore per epiglottide	52.02
REILL pinza da riduzione	32.20
REINER coltello per gesso	30.04
REINER siringa auricolare	44.06
RESANO pinza per anastomosi	64.08
retrotorre per amputazione	33.02
rettoscopio	68.04
REVERDIN (ALBARRAN) ago da legatura	26.03
REVERDIN divaricatore addominale	18.06
REYNOLDS (JAMESON) forbici	08.07
RHEINTAEDTER curetta uterina con irrigazione	70.24
RIBBON divaricatore	18.05
RICARD divaricatore addominale	18.59
RICHARDSON divaricatore	18.04
RICHARDSON EASTMAN divaricatore	18.04
RICHTER HEATH pinza per agrafe	26.08
RIECKER KLEINSASSER supporto per laringoscopia	52.06
RIGBY divaricatore rettale e vaginale	18.56
RING abbassalingua	48.11
RITCHEY strumento da conficcare chiodi	34.11
RITTER HALLE dilatatore per il seno frontale	46.29
ROBB dissettore	56.18
ROBERTS pinza emostatica	12.18
ROBIN MASSE divaricatore addominale	18.60
ROBIN pinza fissateli	14.04
ROCHARD divaricatore	18.61
ROCHESTER CARMALT pinza emostatica	12.09
ROCHESTER PEAN pinza emostatica	12.08
ROEDER fissateli	14.03
ROEDER pinza fissateli	14.03
ROEDER serranodi	50.03
ROETTGEN RUSKIN pinza sgorbia	32.08
ROGERS pinza per il parametrio	12.29
ROGGE pinza portastrumenti per sterilizzazione	28.02
ROLLET divaricatore	42.07
ROLLET scalpello per il sacco lacrimale	42.06
rompelamette	06.07
rondella per vite per ossa	36.11
ROSE uncino tracheale	54.03
ROSEN ago per la micorchirurgia del orecchio	44.17, 44.18
ROSEN coltello circolare	44.17
ROSENBERG punta di pinza	52.03
ROSER KOENIG apribocca	48.05
ROSS divaricatore per aorta	56.13
ROUX divaricatore	18.02
ROUX MAGNUS divaricatore	18.03
ROWE pinza per radriizzare setto	48.12
ROY CAMILLE placca cervicale	36.23

RUBIN pinza per ammaccare setto	46.10
RUBIN protettore	46.10
RUDD ligatore emorroidale	68.09
RUMEL pinza emostatica toracica	12.17
RUSKIN LISTON cesoia per ossa	32.14
RUSKIN pinza sgorbia	32.08
RUSSEL DAVIS abbassalingua	48.09
RYDEL SEIFFER diapason	44.05
RYDER portaghi	24.04, 24.05

S

SAALFELD tiracomedoni	74.02
SACHS dissettore di duramadre	40.07
SACHS divaricatore per nervi	40.05
SACHS separatore per duramadre	40.08
SAENGER pinza per aborto e placenta	72.06
SALENIUS meniscotomo	32.58
salpingografo	70.30
SANVENERO forbici	08.06
SAROT pinza bronchiale	12.18, 56.14
SAROT portaghi	24.07
SATINSKY forbici toraciche	08.16
SATINSKY pinza per anastomosi	56.15
SATINSKY pinza per la vena cava	56.15
SATO coltello corneale	42.05
SATTERLEE sega da amputazione	33.03
SAUERBRUCH costotomo	56.03
SAUERBRUCH divaricatore	18.21
SAUERBRUCH FREY costotomo	56.03
SAUERBRUCH pinza per rifiuti	28.02
SAUERBRUCH pinza sgorbia	32.09
SAUERBRUCH scatola per aghi da sutura	88.02
SAWTELL pinza per tonsille	12.14
SCAGLIETTI pinza sgorbia	32.10
scalpello di guida per placche per ossa	34.04
scalpello emostatico	44.19
scalpello per il sacco lacrimale	42.06
scalpello per ossa	32.35 - 32.38, 46.18
scalpello per plastica nasale	46.17 - 46.19
scalpello per setto	46.17
scalpello per spongiosa	32.37
scalpello sternale	32.38
scatola da sterilizzazione per strumenti con filtri	88.06
scatola in acciaio per strumenti	88.02
scatola in vetro con coperchio	88.02, 88.03
scatola per aghi	88.02
scatola per strumenti con coperchio in acciaio	88.07
scatola Petri con coperchio	88.04
SCHAEDEL (SHRADLE) fissateli	14.02
SCHAMBERG tiracomedoni	74.02
SCHAEDE curetta tagliente	32.26
SCHAEBE pinza per afferrare organi	64.04
SCHAEIE cannula oftalmica	43.08
SCHAEIE coltello per goniotomia	42.06
SCHNEIMANN punta di pinza	52.03
SCHPEPENS spatola orbitale	42.08
SCHERBAK specolo vaginale	70.12
schiacciatore intestinale	64.12
SCHIMMELBUSCH tamburo di sterilizzazione	88.05
SCHINK dermatomo	06.11
SCHIOETZ tonometro	43.09
SCHMEDEEN concotomo	46.10
SCHMID cannula vascolare	22.04
SCHMID spatola per la intima	56.18
SCHMIEDEN PAYR sonda conduttrice	26.03
SCHMIEDEN TAYLOR forbici di duramadre	08.15
SCHNEIDER periostotomo	32.46
SCHNEIDER SAUERBRUCH periostotomo	32.46
SCHNIDT (BOETTCHER) pinza per tonsille	12.15
SCHOENBORN divaricatore per tiroide	54.04
SCHOENBURG pinza per tessuti	64.04
SCHROEDER pinza per abbassare il collo uterino	70.19
SCHROEDER pinza uterina	70.18, 70.19
SCHUBERT pinza per biopsia	70.24
SCHUKNECHT coltello circolare	44.17
SCHUKNECHT divaricatore	18.29
SCHUKNECHT tubo da aspirazione	44.06
SCHULTZE salpingografo	70.30
SCHULZE BERGMANN specolo rettale	68.02
SCHUMACHER forbici ombelicali	08.14
SCHUMACHER forbici per sterno	56.03
SCHUMACHER pinza per biopsia	70.25
SCHUMACHER punta di pinza	52.03
SCHWEIGGER pinza capsulare	43.04

sclerotomo	42.06
scollatendini	32.59
scollatore di duramadre	40.08
scollatore doppio per la chirurgia degli orecchi	44.18
SCOVILLE curetta per disco rotto	32.29
SCOVILLE divaricatore di laminectomia	18.62
SCOVILLE HAVERFIELD divaricatore	18.62
SCOVILLE uncino per radici di nervi	40.06
SCOVILLE valva	18.63
SEBILAU elevatore	32.50
secchia per rifiuti con ruote	88.04
SEDLLOT periostotomo	32.45
sega a dita	33.03
sega circolare	33.09
sega da amputazione	33.02, 33.03
sega di filo	40.06
sega elettrica per gessi oscillante	30.03
sega nasale	46.23
sega per anelli	33.03
sega per gessi	30.02
SEGOND bisturi per fibromi	70.29
SEIDEL specolo vaginale	70.11
SEIFFERT punta di pinza	52.03
SEIFFERT specolo vaginale	70.05
SELLHEIM cucchiaio osteretrico	72.07
SELLORS avvicinatore costale	56.12
SEMB cesoia per ossa	32.14
SEMB periostotomo costale	32.48
SEMB pinza bronchiale	56.14
SEMB pinza sgorbia	32.10
SEMB tenaglia per ossa	32.15
SEMKEN pinza di dissezione	10.07
SEMM specolo vaginale	70.06
SENN divaricatore	18.05
SENN GREEN divaricatore	18.10
SENN MILLER baby divaricatore	18.05
SENNING (Svezia) portaghi	24.04
sensimetro	02.11
separatore per duramadre	40.08
serrafina	12.03
serranodi per polipi auricolari	44.09
serranodi per polipi nasali	46.13
serranodi per polipi rettali	68.06
serranodi per tonsille	50.06, 50.07
serrapinze	64.10
set di diagnostico	02.08
set di dissezione in astuccio	32.39
set di maniche per infermiere	74.03
set di seghe, perforatori e frese	33.07
set di sutura con agrafe	26.08
set di tracheotomia in astuccio	54.03
set per varici	20.03
SEUTIN forbici per gessi	30.02
SEWALL elevatorio	46.16
SEXTON coltello auricolare	44.08
SEXTON GERZOG coltello auricolare	44.08
SEYFFERT specolo vaginale	70.06
stigmomanometria	02.02 - 02.04
sgorbia	32.33 - 32.38, 44.11, 46.20
sgorbia per corpi estranei	42.06
sgorbia per esporre vite rotte	32.37
sgorbia per scoliosi	32.37
SHEA forbici micro	44.11
SHEPARD II pinza per impiantare lente	42.18
SIEBOLD forbici ginecologiche	08.13
SIEGLE specolo auricolare pneumatico	44.03
sigmoiscopio	68.04
SILVER dermatomo a mano	06.12
SILVER scalpello per plastica	46.19
SIMCOE cannula da irrigazione ed aspirazione	43.08
SIMON cucchiaio uterino tagliente	70.31
SIMON curetta uterina tagliente	32.27
SIMON divaricatore addominale	18.19
SIMON uncino per fistole	70.29
SIMPSON BRAUN forcipe	72.02
SIMPSON forcipe	72.02
SIMPSON LUKART forcipe	72.03
SIMS curetta uterina	70.32
SIMS depressore uterino	70.21
SIMS dilatatore uterino	70.17
SIMS forbici uterini	08.12
SIMS isterometro	70.22
SIMS MAIER pinza per polipi	16.02
SIMS specolo rettale	68.02
SIMS specolo vaginale	70.10
SINGLEY TUTTLE pinza	10.09

Indice alfabetico

sinus pinza per medicazione	16.04	STEVENS uncino per cristallino	42.07	tenaglia tagliafili	33.17
siringa auricolare	44.06	STEVENSON blefarostato	42.03	tendifili	33.13
siringa per tonsille	50.08	STIEGLITZ (WILLIAMS) pinza per schegge	10.13	tenditore di fili di metallo	33.12, 34.03, 34.13
sistema di divaricatori cerebrali	40.10 - 40.14	STIEGLITZ pinza per schegge	10.13		
SKENE pinza uterina	70.18	STILLE BARRAYA pinza	10.09	tensore di placche per osso	34.03
SLUDER BALLENGER tonsillotomo	50.07	STILLE costatomo	56.02	TERRIER pinza vascolare	12.03
SMELLIE spezzacraneo	72.08	STILLE forcipi per gessi	30.02	TERSON pinza capsulare	43.04
SMELLIE uncino ostetrico	72.05	STILLE HORSLEY cesoia per osso	32.14	THIERRY forcipe ostetrica	72.04
SMILLIE divaricatore di ginocchio	32.57	STILLE LISTON cesoia per osso	32.14	THOMAS curetta uterina	70.34
SMILLIE meniscotomo	32.58	STILLE LUER pinza sgorbia	32.08	THOMS ALLIS pinza	64.03
SMITH blefarostato	42.02	STILLE osteotomo	32.35	THOMS GAYLOR pinza per biopsia uterina	70.25
SMITH BUIE divaricatore rettale	68.03	STILLE perforatore a mano	33.04	THOREK forcipi pulmonari (toraciche)	08.16
SMITH PETERSEN chiodo	36.07	STILLE pinza di dissezione	10.02	THUDICHUM (GOLDSMITH) specolo nasale	46.02
SMITH PETERSEN pinza sgorbia	32.11	STILLE pinza per peduncolo renale	12.24	TIECK HALLE specolo nasale	46.04
SMITH PETERSEN scalpello	32.35	STILLE RUSKIN pinza sgorbia	32.09	TILLEY pinza auricolare	44.10
SMITH PETERSEN sgorbia	32.35	STILLE scalpello	32.35	tiracomodoni	74.02
SMITH US Army forcipi per garza	08.20	STILLE sgorbia	32.35	tira-I.U.D. 'flexible grasper'	70.21
SMITHWICK pinza per applicare agrafe	40.02	STILLE SHERMAN perforatore	33.04	tiramioami	70.29
SNELLEN ansa	42.09	STOCKMANN pinza serrapene	66.05	tiranastro	32.22
SNELLEN pinza per entropio	43.07	STONE pinza di dissezione	10.10	tiravene	20.03, 20.05
SNITMAN divaricatore	18.27	STONE serrapinze	64.10	TISCHLER baby pinza di biopsia uterina	70.26
SOMER pinza isterolabo 23 cm	70.21	STONE WATT pinza intestinale	64.10	TISCHLER baby punta di pinza per biopsia	70.27
sonda	20.02, 20.04	STONE WATT serratura sola	64.10	TISCHLER KEVORKIAN pinza di biopsia uterina	70.28
sonda auricolare	20.02	STRANDELL STILLE divaricatore	18.10	TISCHLER KEVORKIAN punta di pinza uterina	70.27
sonda bottonuta per ipofistomia	40.27	Strasburgo pinza di dissezione	10.10	TISCHLER MORGAN pinza di biopsia	70.26
sonda conduttrice per legature	26.03, 26.04	STRATTE portaghi	24.07	TISCHLER MORGAN punta di pinza di biopsia	70.27, 70.28
sonda di gozzo	54.04	STRAUSS pinza serrapene	66.05	TIVNEN pinza per tonsille	50.05
sonda fistolare	68.06	STRUCK divaricatore costale	56.10	TOBOLD abbassalingua	48.03
sonda misuratrice per microchirurgia auricolare	44.19	STRUENPEL pinza auricolare	44.11	TOBOLD portacatone laringeale	20.06
sonda per calcoli biliari	62.03	STRULLY forcipi per neurochirurgia	08.15	TOENNIS ADSON forcipi neurochirurgicali	08.15
sonda per calcoli biliari	62.03	STRULLY forcipi vascolari	08.15	TOENNIS dissettore di duramadre	40.07
sonda per calcoli renali	62.04	strumento da conficcare	32.38	TOENNIS pinza emostatica	12.18
sonda trabecolare	42.12	strumento da introdurre cateteri laringei	04.04	TOENNIS portaghi	24.07
sonda uretrale metallica per donne	66.07	strumento di concisione	66.05	TOHOKU pinza fissatili	14.03
sonda uretrale metallica per uomini	66.06	strumento di fissaggio	42.07	tonometro	43.09
sonda uterina	70.22	strumento per conficcare cambre	34.12	TOOK coltello corneale	42.05
SÖNNENSCHNEIN specolo nasale	46.03	strumento per conficcare chiodi centromidollari	33.19	TOTI fresa	33.09
spaccacraneo	32.39	strumento per conficcare placche angolari	34.05	TOWNSEND KEVORKIAN pinza di biopsia uterina	70.27
spatola addominale	18.22, 18.54	strumento per corpi estranei	42.06	TOWNSEND TISCHLER baby pinza di biopsia uterina	70.27
spatola cerebrale	40.15	strumento per il inchiodamento di osso	33.18, 33.19, 34.11, 34.12	TOYNBEE specolo auricolare	44.02
spatola orbitale	42.08			trapano asta AO	33.07
spatola per ciclodialisi	42.09, 42.10	strumento per mis. la lunghezza delle viti perforate	33.23	trapano per osso	33.04 - 33.09
spatola per enucleazione	42.09	strumento per misurare per DHS	34.07	trattore per forcipi	72.03
spatola per iride	42.09	strumento per paracentesi	44.08	TRAUBE martello di percussione	02.10
spatola per la intima	56.18	strumento per piegare aghi Kirschner	34.13	TRAVERS divaricatore	18.32
spatola polmonare	56.12	strumento per piegare perforatori filiformi	34.13	trazione craniale	40.04
spatola vescicale	66.03	strumento per piegare placche per osso	33.21	trefina corneale	43.08, 43.09
spazzola per unghie sterilizzabile	74.05	strumento per togliere lame da bisturi	06.05	trefina cutanea	74.03
spazzola per viti perforate	33.23	strumento tendifilo	33.13	TRELAT specolo vaginale	70.06
spazzolino per pulire canule tracheali	54.03	STRUYCKEN pinza tagliente nasale	46.10	trequarti	22.02, 22.03, 22.05, 54.02
specchio frontale	02.05	supporto per spatole cerebrali	40.11		
specchio laringeo	52.07	supporto per specoli auricolari	40.10	TRETHOWAN elevatore per osso	32.56
specchio postroscopico	46.05	supporto pettorale per apribracca	48.11	TREVES pinza	10.03
specillo	20.02	supporto pettorale per laringoscopi	52.06	tritacartilagine	46.23
specillo lacrimale	42.12	supporto portabile per mini container	88.19	TROELTSCH (WILDE) pinza auricolare	44.09
specillo scanalato	20.02, 26.04	SVEN JOHANSSON strumento da conficcare	34.11	TROELTSCH pinza nasale	46.05
specolo anale	68.05	Svezia portaghi	24.04	TROEMNER martello di percussione	02.10
specolo auricolare	44.02, 44.03	SWEET pinza per applicare agrafe	40.02	tronchesina per pelle	74.04
specolo nasale	46.02 - 46.04	SYME ago per aneurisma	26.02	tronchesina per unghie	74.03, 74.04
specolo per il setto con luce fredda	46.04	SYPERT pinza sgorbia	32.12	TROTTER pinza sgorbia	32.07
specolo per la ipofistomia transfenoidale	40.23	SYSTRUNK forcipi per unghie	08.22	TROUSSEAU dilatatore tracheale	54.02
specolo per operazione vertebrale lombare	18.42			TROUTMAN CHRIS rompelamette	06.07
specolo rettale	68.02			TROUTMAN calibri pinza per iride	42.15
specolo vaginale	70.02 - 70.13			Tübingen cannula per aria	43.08
specolo vaginale mod. Vienna	70.11			Tübingen divaricatore	18.30
specolo vaginale svizzero	70.05			Tübingen pinza per iride	42.17
SPENCER forcipi per legature	08.17			Tübingen pinza per legature	43.05
SPENCER WELLS (CHANCE) pinza emostatica	12.09			tubo di aspirazione	04.02, 04.03, 40.15, 40.16, 44.06, 52.06, 52.07, 68.06
spezzacraneo	72.08			tubo di puntura ventricolare	40.16
spiedo di guida per chiodi per osso	33.19			tubo tracheale	54.03
SPRATT curetta tagliente	32.26			TUCKER forcipe	72.03
SPURLING pinza per laminectomia	40.17			Tuebingen divaricatore vaginale e rettale	70.11
St. MARKS divaricatore perineale	18.56			TUFFIER divaricatore	56.07
St. MARKS (LLOYD DAVIES) divaricatore pelviano	18.19			TUFFIER divaricatore addominale	18.22
St. MARTIN pinza per sutura	43.05			TUFFIER pinza emostatica	12.11
STACKE sonda auricolare	20.02			TURNER WARWICK divaricatore addominale	18.50 - 18.55
STAUDE MOORE pinza uterina	70.18			TURREL pinza di biopsia rettale	68.07
StCLAIR THOMSON coltello	46.28			TYDING pinza per tonsille	50.05
STEINBACH martello	32.43			TYDING serranodi	50.07
STEINMANN chiodo	33.11			TYRELL uncino per iride	42.07
STEINMANN pinza afferratendini	32.23				
STELLBRINK pinza sgorbia	32.05				
STERNBERG divaricatore delle labbra	48.03				
stetoscopia	02.09				
STEVENS forcipi per tenotomia	08.08				
STEVENS pinza per iride	42.13				
STEVENS portaghi	24.09				

Indice
alfabetico

U	
UCKERMANN portacatone	20.06
UCKERMANN trequarti	54.02
UFFENORDE curretta per ossa	32.27
ULRICH pinza per afferrare ossa	32.17
ULRICH pinza per tamponi	16.02
UNIVERSAL pinza sgorbia	32.06
UNNA tiracomedoni	74.02
uretrotomo	66.04
US Army divaricatore	18.03
USA pinza di dissezione	10.02

V	
vacumetro per vuoti di sangue	33.02
VALIN divaricatore	18.62
VALLEIX sonda uterina	70.22
valva per sternotomia	56.07
valva vaginale	70.07 - 70.10
van BUREN pinza per sequestri	32.21
van DOREN pinza per biopsia vaginale	70.25
VANNAS forbici per iridectomia	09.03
VANT pinza per tamponi	16.03
VARADY flebodissettore	20.05
VARADY mini set per vari	20.04
VARADY spatola	20.05
vassoio per medicinali	88.03
vassoio per strumenti	88.04
vBUREN candeletta dilatatrice uretrale	66.06
VERBRUGGE HOHMANN elevatore per ossa	32.53
VERBRUGGE tenaglia per ossa	32.18
VERNIER calibro	02.12
VERRES ago per pneumoperitoneo	22.03
VIDAL raschiatoio per lupus	74.02
Vienna modello specolo nasale	46.03
Vienna modello specolo vaginale	70.11
VIRCHOW coltello di cervello	06.13
VIRCHOW coltello per cartilagine	06.13
VIRCHOW spaccacranio	32.38
VIRTUS (RALK) pinza per schegge	10.13
visore con filetto	33.26
visore con punta	33.26
visore parallelo per aghi Kirschner	33.24
visore per viti dinamiche ferromali	34.07
vite con perforazione longitudinale	36.11
vite corticale	36.11 - 36.13
vite corticale mini	36.11
vite da compressione	36.09
vite da connessione	34.08
vite da distrazione	18.41
vite femorale dinamica	36.09
vite malleolare	36.13
vite spungiosa	36.11 - 36.13
VOLKMANN curretta tagliente per ossa	32.26, 32.28, 32.32
VOLKMANN divaricatore	18.10, 18.11
VOLTOLINI (DUPLAY) specolo nasale	46.02
vPETZ apparecchio per la sutura stomacale	64.13

W	
WACHENFELDT pinza per agrafe	26.07
WADSWORTH TODD cauterio	42.09
WAGENER MOSHER tubo da intubazione	54.03
WAGENER uncinetto bottonuto	44.09
WAGNER forbici	08.18
WAGNER martello	32.42
WAGNER pinza per laminectomia	40.18
WALB coltello per organi	06.13
WALLICH cucchiaino per aborto	72.07
WALSHAM pinza per raddrizzare setto	46.25
WALTER ago per corpi estranei	42.06
WALTHER candeletta dilatatrice uretrale	66.08
WALTHER cateter dilatatore	66.07
WALTON divaricatore per emilaminectomia	18.35
WALTON sgorbia per corpi estanei	42.06
WALTON tiracomedoni	74.02
WALTON YANKAUER tubo di aspirazione	04.02
WANE divaricatore	18.31
WANGENSTEEN portaghi	24.05
WARTENBERG sensimetro	02.11
WASSMUND divaricatore	18.23
WATSON CHEYNE elevatore	32.50
WATSON CHEYNE periotostomo	20.02

WATSON dermatomo	06.12
WATSON JONES elevatore per ossa	32.56
WATSON WILLIAMS pinza etmoidale	46.07
WAUGH pinza per dissezione	10.09
WEBER ansa	42.09
WEBER estesiometro	02.11
WEBSTER portaghi	24.02
WECKER forbici per iride	09.02
WECKER spatola per iride	42.09
WEEK blefarostato	42.02
WEIL BLAKESLEY pinza tagliente nasale	46.09
WEINBERG divaricatore per vagotomia	18.07
WEISS blefarostato	42.03
WEISS pinza serratubi	12.30
WEITLANER divaricatore	18.28 - 18.30
WEITLANER WULLSTEIN divaricatore	18.28
WELLS spatola per enucleazione	42.09
WERTHEIM CULLEN pinza per isterectomia	12.28
WERTHEIM forbici	08.13
WERTHEIM pinza	12.27
WERTHEIM pinza per isterectomia	12.27
WEST scalpello nasale	46.20
WESTCOTT forbici per tendini	09.02
WESTMACOTT pinza per tamponamento nasale	46.06
WESTON serranodi di polipi rettali	68.06
WHEELER coltello di dissezione	42.05
WHEELER spatola per ciclodialisi	42.10
WHITE pinza per tonsille	50.04
WHITEHEAD apribocca	48.06
WIEDER abbassalingua	48.02
WIENER (American) raspa per il seno	46.20
WIENER uncino per iride	42.07
WIGMORE sega per gessi	30.02
WIKSTROEM pinza emostatica	12.20
WILBERG agrafe per ossa	36.26
WILDE serranodi	46.13
WILDE TROELTSCH pinza	44.09
WILDER ansa	42.09
WILDER dilatatore lacrimale	42.11
WILLET MARTEL pinza per il cuoio capelluto	12.10
WILLIAMS blefarostato	42.03
WILLIAMS divaricatore	18.62
WILLIAMS giraviti e portaviti	33.20
WILLIAMS pinza per tessuti	64.04
WILLIGER curretta tagliente	32.32
WILLIGER elevatorio	32.49
WILLIGER martello	32.41
WILLIGER periotostomo	32.47
WILMS pinza sgorbia	32.07
WINTER pinza per aborto e placenta	72.06
WITTNER pinza per biopsia uterina	70.26
WOLFF pinza per gessi	30.04
WULLSTEIN coltello falciiforme	44.17
WULLSTEIN forbici micro	44.14
WÜRZBURG abbassalingua	48.10
WYLIE dilatatore uterino	70.17

Y	
YANKAUER specolo nasofaringeale	46.05
YANKAUER tubo di aspirazione	04.02
YASARGIL bisturi per l'aracnoide	40.29
YASARGIL curretta tagliente	40.28
YASARGIL pinza micro	11.05
YASARGIL pinza per tumori	11.05
YASARGIL pinza tagliente per ipofisi	40.18
YASARGIL portaghi micro	24.12
YASARGIL portalegature	40.26
YASARGIL raspino	40.27
YASARGIL SAMII pinza per tumori	11.05
YASARGIL tubo di aspirazione	40.15
YASARGIL uncino di galea	40.04
YEOMAN pinza di biopsia rettale	68.06, 68.07
YOUNG boomerang portaghi	26.03
YOUNG divaricatore prostatico	66.02
YOUNG pinza per afferrare la prostata	66.02
YOUNG pinza tiralingua	48.04

Z	
ZAUFAL JANSEN pinza sgorbia	32.07
ZENKER divaricatore	18.21
ZENKER pinza di dissezione e passafili	12.19
ZIEGLER blefarostato	42.03
ZIEGLER coltello di capsulotomia	42.05

ZIEGLER coltello per iridectomia	42.05
ZIEGLER dilatatore lacrimale	42.12
ZIEGLER specchio frontale	02.05
ZIELKE sgorbia per scoliosi	32.37
ZOELLNER tubo di aspirazione	44.06
ZWEIFEL portaghi	24.07

Indice
alfabetico

ZEPF[®]
α
INSTRUMENTS

