

KNOCHENCHIRURGIE, TRAUMATOLOGIE

BONE SURGERY, TRAUMATOLOGY

CHIRURGIE OSSEUSE, TRAUMATOLOGIE

CIRUGÍA ÓSEA, TRAUMATOLOGÍA

CHIRURGIA OSSEA, TRAUMATOLOGIA

Amputation
Amputation
Amputation
Amputación
Amputazione



compl.
33-1001-01

Komprimeter zur Erzeugung einer Blutleere in den Gliedern
Compression Apparatus for producing blood vacuum in the limbs
Appareil compressif permettant d'obtenir un milieu exsangue des membres
Aparato de compresión para producir el vacío de sangre en los miembros
Vacumetro per determinare vuoti di sangue nelle membra

**KNOCHENCHIRURGIE,
TRAUMATOLOGIE**

**BONE SURGERY,
TRAUMATOLOGY**

**CHIRURGIE OSSEUSE,
TRAUMATOLOGIE**

**CIRUGÍA ÓSEA,
TRAUMATOLOGÍA**

**CHIRURGIA OSSEA,
TRAUMATOLOGIA**



PERCY
33-1098-00



PERCY
33-1100-00



HELFERICH-BIER
33-1101-39

Komplett mit 3 Blättern 5, 6 und 8 mm
Complete with 3 blades 5, 6, and 8 mm
Complète avec 3 lames 5, 6 et 8 mm
Completa con 3 hojas de 5, 6 y 8 mm
Completa di 3 lame 5, 6 e 8 mm

mm	
5	33-1101-05
6	33-1101-06
8	33-1101-08



mm
12 33-1102-12
15 33-1102-15
18 33-1102-18

CHARRIERE (FARABEUF)
33-1102-00

Kompl. m. 2 Blättern 12 u. 15 mm
 Compl. w. 2 blades 12 and 15 mm
 Compl. av. 2 lames 12 et 15 mm
 Compl. c. 2 hojas 12 y 15 mm
 Compl. di 2 lame 12 e 15 mm



RUST
33-1104-00

mm
6 33-1104-06
8 33-1104-08
15 33-1104-15
20 33-1104-20

cm
27,0 33-1106-98
30,0 33-1106-99

Blätter
blades
lames
hoja
hame



cm **CHARRIERE**
27,0 33-1106-27
30,0 33-1106-30

Blätter
blades
lames
hoja
hame

33-1108-99



cm **SATTERLEE**
31,0 33-1108-31

cm **LANGENBECK**
23,0 33-1200-23



**KNOCHENCHIRURGIE,
TRAUMATOLOGIE**

**BONE SURGERY,
TRAUMATOLOGY**

**CHIRURGIE OSSEUSE,
TRAUMATOLOGIE**

**CIRUGÍA ÓSEA,
TRAUMATOLOGÍA**

**CHIRURGIA OSSEA,
TRAUMATOLOGIA**

Finger Instrumente
 Finger Instruments
 Instruments à doigts
 Instrumentos para dedos
 Strumenti per dita

Set 3=
33-1600-01



33-1600-00
compl. incl. 33-1600-01

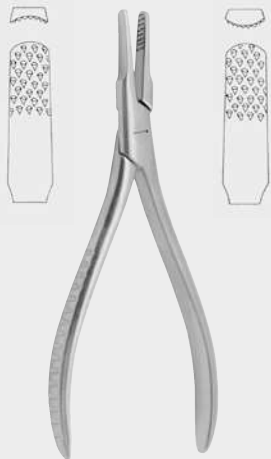

cm **RADOLF**
13,5 33-1602-13



cm **PENNER**
16,0 33-1604-16



cm
14,5 33-1606-14

ZEPF®
INSTRUMENTS

Amputation
Amputation
Amputation
Amputación
Amputazione

KNOCHENCHIRURGIE,
TRAUMATOLOGIE

BONE SURGERY,
TRAUMATOLOGY

CHIRURGIE OSSEUSE,
TRAUMATOLOGIE

CIRUGÍA ÓSEA,
TRAUMATOLOGÍA

CHIRURGIA OSSEA,
TRAUMATOLOGIA



cm WALTON
16,0 33-1701-00



cm
17,0 33-1703-00



33-1705-01
33-1705-99
33-1705-00



cm FELDHEIM
10,0 33-1710-10



cm STILLE compl.
20,0 33-2100-20

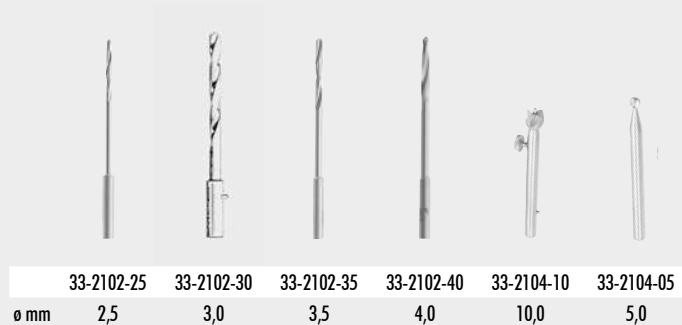

	33-2102-25	33-2102-30	33-2102-35	33-2102-40	33-2104-10	33-2104-05
ø mm	2,5	3,0	3,5	4,0	10,0	5,0

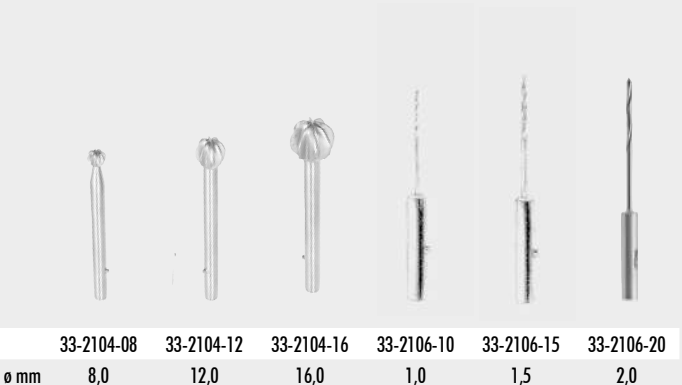

	33-2104-08	33-2104-12	33-2104-16	33-2106-10	33-2106-15	33-2106-20
ø mm	8,0	12,0	16,0	1,0	1,5	2,0

Handbohrapparate
Bone Hand Drills
Perforateurs à main
Perforadores a mano
Perforatori a mano

KNOCHENCHIRURGIE,
TRAUMATOLOGIE

BONE SURGERY,
TRAUMATOLOGY

CHIRURGIE OSSEUSE,
TRAUMATOLOGIE

CIRUGÍA ÓSEA,
TRAUMATOLOGÍA

CHIRURGIA OSSEA,
TRAUMATOLOGIA

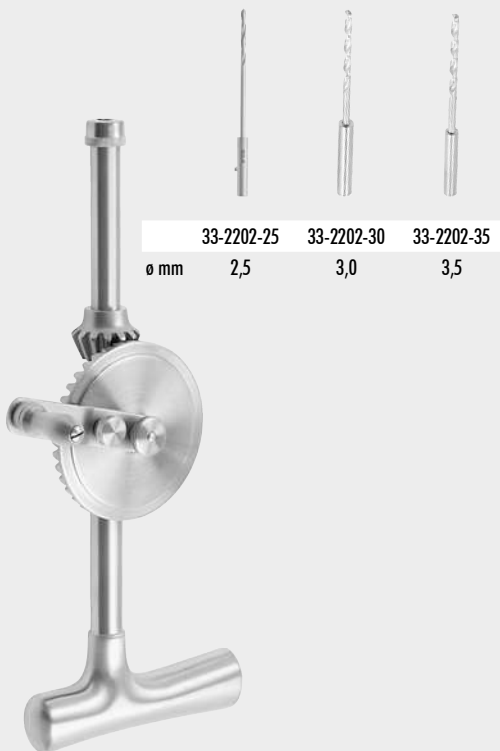

cm STILLE SHERMAN compl.
24,0 33-2200-24

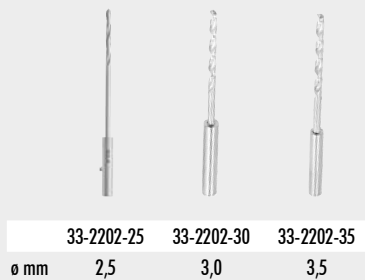

	33-2202-25	33-2202-30	33-2202-35
ø mm	2,5	3,0	3,5



Set / 3
33-2302-00



cm MOORE compl.
28,0 33-2300-28



Handbohrapparate
Bone Hand Drills
Perforateurs à main
Perforadores a mano
Perforatori a mano



cm
27,0 33-2400-99

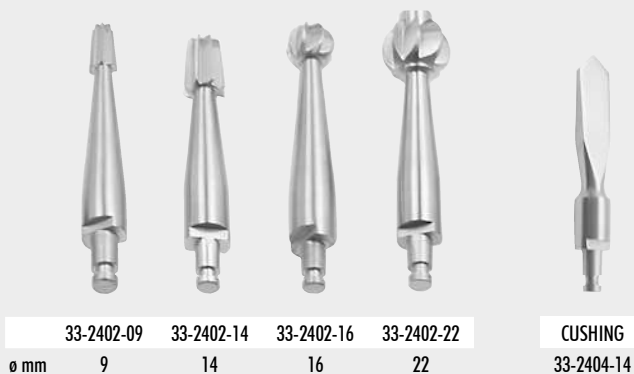

	33-2402-09	33-2402-14	33-2402-16	33-2402-22	CUSHING
ø mm	9	14	16	22	33-2404-14

KNOCHENCHIRURGIE,
TRAUMATOLOGIE

BONE SURGERY,
TRAUMATOLOGY

CHIRURGIE OSSEUSE,
TRAUMATOLOGIE

CIRUGÍA ÓSEA,
TRAUMATOLOGÍA

CHIRURGIA OSSEA,
TRAUMATOLOGIA

cm HUDSON compl.

27,0 33-2400-27
incl. 33-2402-09 / -14 / -16 / -22 / 33-2406-00

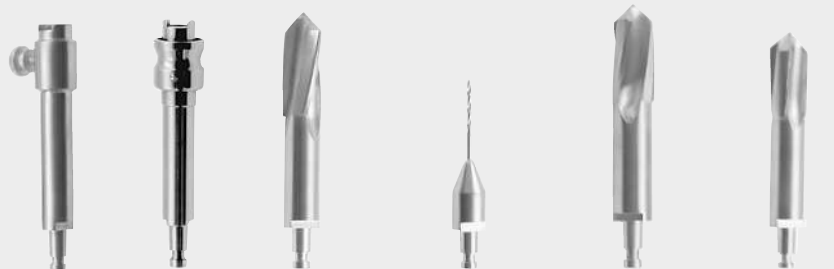

	33-2406-00	33-2406-01	McKENZIE	ø mm	McKENZIE	ø mm	McKENZIE	ø mm	D'ERRICO
			33-2408-00	2,0	33-2410-02	13,0	33-2412-13	16,0	33-2414-16



HUDSON
33-2450-01

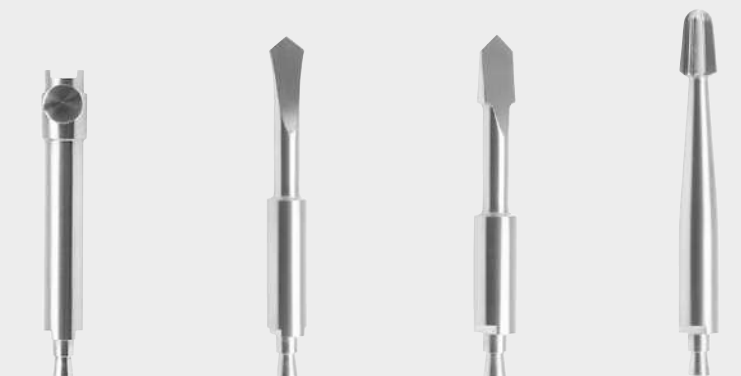

HUDSON	HUDSON	ø mm	CUSHING	ø mm	LEWIS	ø mm	
33-2450-10		10	33-2452-10	10	33-2454-10	11	33-2456-11
		12	33-2452-12	12	33-2454-12	13	33-2456-13
		15	33-2452-15	15	33-2454-15	16	33-2456-16



Handbohrapparate
Bone Hand Drills
Perforateurs à main
Perforadores a mano
Perforatori a mano



ø mm	CUSHING	ø mm	MC KENZIE	ø mm	MC KENZIE
11	33-2458-11	16	33-2460-16	16	33-2462-00
13	33-2458-13				
16	33-2458-16				
19	33-2458-19				
22	33-2458-22				

KNOCHENCHIRURGIE,
TRAUMATOLOGIE

BONE SURGERY,
TRAUMATOLOGY

CHIRURGIE OSSEUSE,
TRAUMATOLOGIE

CIRUGÍA ÓSEA,
TRAUMATOLOGÍA

CHIRURGIA OSSEA,
TRAUMATOLOGIA



KIRSCHNER compl.
33-2500-00

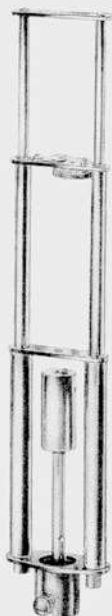

33-2502-00

Teleskopische Bohrdrahtstütze
Telescopic Wire Drill Guide
Guide de broches télescopant
Conductor telescópico p. taladros filiformes
Condottoe a telescopio per taladri filiformi



compl.
33-2600-00



33-2602-00

Teleskopische Bohrdrahtstütze
Telescopic Wire Drill Guide
Guide de broches télescopant
Conductor telescópico p. taladros filiformes
Condottoe a telescopio per taladri filiformi

Handbohrapparate
Bone Hand Drills
Perforateurs à main
Perforadores a mano
Perforatori a mano

KNOCHENCHIRURGIE,
TRAUMATOLOGIE

BONE SURGERY,
TRAUMATOLOGY

CHIRURGIE OSSEUSE,
TRAUMATOLOGIE

CIRUGÍA ÓSEA,
TRAUMATOLOGÍA

CHIRURGIA OSSEA,
TRAUMATOLOGIA



cm BUNNELL
16,0 33-2700-00



RALK
33-2800-00
33-2810-00

Lange Welle
long shaft
arbre lay
arbol Largo
albero Lungo



33-2900-00



33-2906-00



33-2910-00
cap. 6,35 mm · L = 125 mm

Schlüssellos
keyless
sans clé
sin llave
senza chiave

Bohrer-, Fräser-, Sägen-Besteck
Set of Saws, Drills, and Burrs
Jeu de scies, mèches et fraises
Juego de sierras, taladros y fresas
Set di seghe, perforatori e frese

**KNOCHENCHIRURGIE,
TRAUMATOLOGIE**

**BONE SURGERY,
TRAUMATOLOGY**

**CHIRURGIE OSSEUSE,
TRAUMATOLOGIE**

**CIRUGÍA ÓSEA,
TRAUMATOLOGÍA**

**CHIRURGIA OSSEA,
TRAUMATOLOGIA**

Knochenbohrer
Bone Drills
Mèches à os
Taladros para huesos
Trapani per ossa



ø mm	cyl.
1,0	33-3504-10
1,2	
1,5	33-3504-15
1,8	
2,0	33-3504-20
2,2	
2,5	33-3504-25
2,8	33-3504-28
3,0	33-3504-30
3,2	33-3504-32
3,5	33-3504-35
4,0	33-3504-40
4,5	33-3504-45
5,0	33-3504-50
6,0	33-3504-60
7,0	

ø mm	mm	cyl.	AO	AO
1,1	60 / 35		33-3506-11	
1,5	85 / 60		33-3506-15	
1,5	110 / 85			33-3507-15
2,0	100 / 75		33-3506-20	
2,0	125 / 100			33-3507-20
2,5	110 / 85		33-3506-25	
2,7	100 / 75		33-3506-27	
2,7	125 / 100			33-3507-27
3,2	145 / 120		33-3506-32	
3,2	180 / 165	33-3505-32		
3,2	195 / 170			33-3507-32
3,5	110 / 85			
3,5	180 / 165	33-3505-35		
3,5	195 / 170			33-3507-35
4,5	145 / 120		33-3506-45	
4,5	180 / 165	33-3505-45		
4,5	195 / 170			33-3507-45
6,0	195 / 170		33-3506-60	

Gewindebohrer, Handstücke
 Taps, Tap and Drill Holders
 Tarauds, Poignées pour tarauds et mèches
 Terrajas, mangos para terrajas y taladros
 Maschi, manici per maschi e trapani

**KNOCHENCHIRURGIE,
 TRAUMATOLOGIE**

**BONE SURGERY,
 TRAUMATOLOGY**

**CHIRURGIE OSSEUSE,
 TRAUMATOLOGIE**

**CIRUGÍA ÓSEA,
 TRAUMATOLOGÍA**

**CHIRURGIA OSSEA,
 TRAUMATOLOGIA**



ø mm	s	l	xl
1,5		33-3510-15	
2,0		33-3510-20	33-3511-20
2,7		33-3510-27	33-3511-27
3,5		33-3510-35 cort.	
3,5		33-3512-35 spong.	
4,5	33-3510-45		33-3511-45 1,25
4,5			33-3512-45 1,75
6,5		33-3510-65	



ø mm	s	l	
2,7	33-3514-27		
3,5	33-3514-35	33-3515-35	1,25
3,5	33-3515-35		1,75
4,0	33-3514-40		1,75
4,5	33-3514-45	33-3515-14	
6,5	33-3514-65		

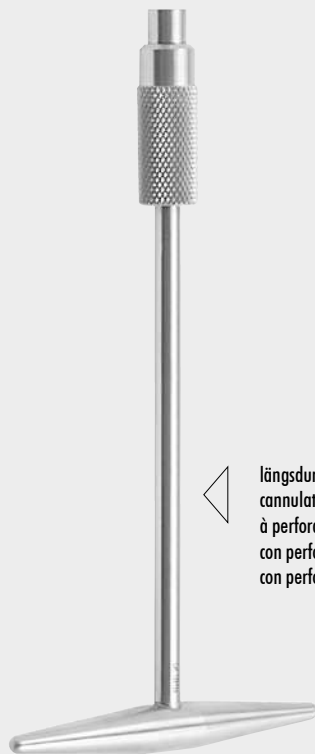

33-3518-00



33-3520-00

längsdurchbohrt
 cannulated
 à perforation longitudinale
 con perforación longitudinal
 con perforazione longitudinale



33-3522-00



33-3524-00



Fräser, Trephine
 Burrs, Trephine
 Fraises, Trépan
 Fresas, Trefina
 Frese, Trefina

ø mm	DOYEN	DOYEN	DOYEN	DOYEN	ALBEE	ALBEE	BORCHARDT	TOTI
4,0	33-3602-04	33-3604-04						
6,0	33-3602-06	33-3604-06						
7,0						33-3704-07		
8,0	33-3602-08	33-3604-08		33-3608-08	33-3702-08			33-3708-08
10,0	33-3602-10	33-3604-10		33-3608-10	33-3702-10			
12,0	33-3602-12	33-3604-12	33-3606-12		33-3700-12	33-3702-12		
13,0							33-3706-13	
14,0	33-3602-14	33-3604-14			33-3700-15			
15,0								
16,0	33-3602-16	33-3604-16						
25,0								33-3707-25

KNOCHENCHIRURGIE,
 TRAUMATOLOGIE

BONE SURGERY,
 TRAUMATOLOGY

CHIRURGIE OSSEUSE,
 TRAUMATOLOGIE

CIRUGÍA ÓSEA,
 TRAUMATOLOGÍA

CHIRURGIA OSSEA,
 TRAUMATOLOGIA



compl.
 33-3807-00

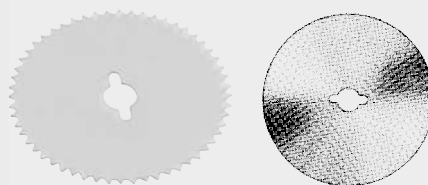
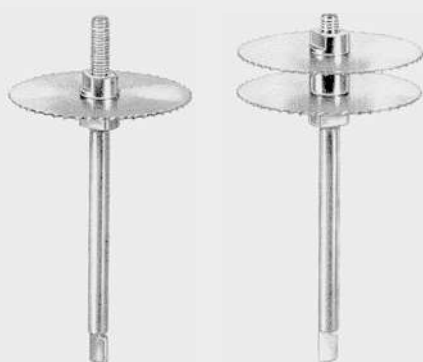

Set
 33-3808-00

Kreissägen für Chirurgie-Handmotor
 Circular Saws for Surgical Hand Motor
 Scies circulaires pour moteur à main
 Sierras circulares para motor a mano
 Seghe circolari per motore a mano

ø mm			
17,0			33-3806-17
20,0	33-3800-20	33-3802-20	33-3804-20
22,0			33-3806-22
25,0	33-3800-25	33-3802-25	33-3804-25
27,0			33-3806-27
30,0	33-3800-30	33-3802-30	33-3804-30
32,0			33-3806-32
35,0	33-3800-35	33-3802-35	33-3804-35
37,0			33-3806-37
40,0	33-3800-40	33-3802-40	33-3804-40
42,0			33-3806-42
45,0	33-3800-45	33-3802-45	33-3804-45
47,0			33-3806-47
50,0	33-3800-50	33-3802-50	33-3804-50

ZEPF[®]

 INSTRUMENTS

33-3808-00

33.11

Pfrieme
Reamers
Alésoirs
Escariadores
Alesatori

KNOCHENCHIRURGIE,
TRAUMATOLOGIE

BONE SURGERY,
TRAUMATOLOGY

CHIRURGIE OSSEUSE,
TRAUMATOLOGIE

CIRUGÍA ÓSEA,
TRAUMATOLOGÍA

CHIRURGIA OSSEA,
TRAUMATOLOGIA

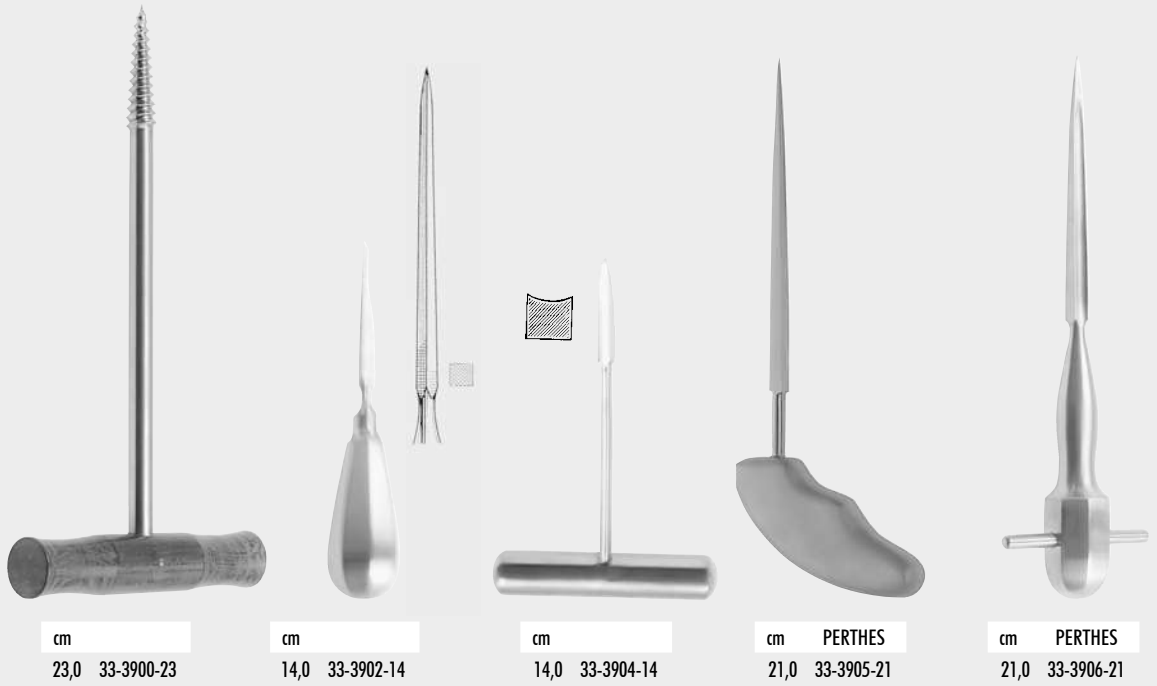

cm
23,0 33-3900-23

cm
14,0 33-3902-14

cm
14,0 33-3904-14

cm PERTHES
21,0 33-3905-21

cm PERTHES
21,0 33-3906-21



cm ISSELIN
16,5 33-3908-16



cm ISSELIN
16,5 33-3910-16



mm 16,5 cm
2 33-3912-02
3 33-3912-03



mm x mm 18,0 cm
3 x 3 33-3914-03
4 x 4 33-3914-04
5 x 5 33-3914-05
6 x 6 33-3914-06
8 x 8 33-3914-08
10 x 10 33-3914-10



mm x mm 25,0 cm
3 x 3 33-3916-03
4 x 4 33-3916-04
5 x 5 33-3916-05
6 x 6 33-3916-06
8 x 8 33-3916-08
10 x 10 33-3916-10



mm x mm	30,0 cm
3 x 3	33-3918-03
4 x 4	33-3918-04
5 x 5	33-3918-05
6 x 6	33-3918-06
8 x 8	33-3918-08
10 x 10	33-3918-10



mm x mm	OMBREDANNE 18,5 cm
3 x 3	33-3920-03
4 x 4	33-3920-04
5 x 5	33-3920-05
6 x 6	33-3920-06



mm x mm	OMBREDANNE 25,0 cm
3 x 3	33-3922-03
4 x 4	33-3922-04
5 x 5	33-3922-05
6 x 6	33-3922-06

Příeme
Reamers
Alésoirs
Escariadores
Alesatori



ø mm	70 mm	150 mm	310 mm
0,8	33-4010-08	33-4012-08	33-4020-08
0,9		33-4012-09	33-4020-09
1,0	33-4010-10	33-4012-10	33-4020-10
1,2		33-4012-12	33-4020-12
1,3		33-4012-13	33-4020-13
1,4		33-4012-14	33-4020-14
1,5	33-4010-15	33-4012-15	33-4020-15
1,6		33-4012-16	33-4020-16
1,8		33-4012-18	33-4020-18
2,0		33-4012-20	33-4020-20
2,2		33-4012-22	33-4020-22
2,5	33-4010-25	33-4012-25	33-4020-25
3,0		33-4012-30	33-4020-30



ø mm	150 mm	310 mm
0,8	33-4022-08	33-4024-08
1,0	33-4022-10	33-4024-10
1,2	33-4022-12	33-4024-12
1,4	33-4022-14	33-4024-14
1,5	33-4022-15	33-4024-15
1,6	33-4022-16	33-4024-16
1,8	33-4022-18	33-4024-18
2,0	33-4022-20	33-4024-20
2,2	33-4022-22	33-4024-22
2,5	33-4022-25	33-4024-25



Länge des Gewindes
Length of thread
Longueur filet
Largo de la rosca
Lunghezza del filetto

ø mm	mm	150 mm	200 mm	230 mm
1,6	5	33-4030-16		
1,6	15	33-4032-16		
2,0	15	33-4034-20		
2,0	15		33-4036-20	
2,5	15		33-4038-20	
2,5	20			33-4038-23

KNOCHENCHIRURGIE,
TRAUMATOLOGIE

BONE SURGERY,
TRAUMATOLOGY

CHIRURGIE OSSEUSE,
TRAUMATOLOGIE

CIRUGÍA ÓSEA,
TRAUMATOLOGÍA

CHIRURGIA OSSEA,
TRAUMATOLOGIA

KIRSCHNER Bohrdrähte
KIRSCHNER Wire Drills
KIRSCHNER Broches
KIRSCHNER Taladros filiformes
KIRSCHNER Fili

Spitze: Trokar
Tip: Trocar
Pointe: Trocart
Punta: Trócar
Punta: Trequarti
Ende: Rund
Rear End: Round
Bout: Rond
Cabo: Redondo
Capo: Rotondo

Trokarspitze beide Seiten
Both Sides Trocar Tips
Pointes trocart des deux côtés
Puntas de trócar en los dos lados
Punte a trequarti ambedue lati

Spitze: Trokar mit Gewinde
Tip: Trocar with thread
Pointe: Trocart avec filet
Punta: Trócar con rosca
Punta: Trequarti filettato
Ende: Rund
Rear End: Round
Bout: Rond
Cabo: Redondo
Capo: Rotondo



* nicht kalibriert
not calibrated
pas calibré
no calibrado
non calibrato

STEINMANN Nägel
STEINMANN Pins
STEINMANN Clous à os
STEINMANN Clavos para huesos
STREINMANN Chiodi per ossa



Ø mm KIRSCHNER
0,7 - 3,0 33-4038-90 *

KNOCHENCHIRURGIE, TRAUMATOLOGIE

BONE SURGERY, TRAUMATOLOGY

CHIRURGIE OSSEUSE, TRAUMATOLOGIE

CIRUGÍA ÓSEA, TRAUMATOLOGÍA

CHIRURGIA OSSEA, TRAUMATOLOGIA

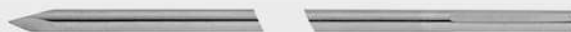

Ø mm	120 mm	150 mm	180 mm	200 mm	250 mm	300 mm
3,5	33-4039-12	33-4039-15	33-4039-18	33-4039-20	33-4039-25	33-4039-30
4,0	33-4040-12	33-4040-15	33-4040-18	33-4040-20	33-4040-25	33-4040-30
4,5	33-4045-12	33-4045-15	33-4045-18	33-4045-20	33-4045-25	33-4045-30
5,0	33-4050-12	33-4050-15	33-4050-18	33-4050-20	33-4050-25	33-4050-30

Spitze: Trokar Ende: Dreikant
Tip: Trocar Rear: Triangular Shaft
Pointe: Trocart Bout: Triangulaire
Punta: Trócar Cabo: Triangular
Punta: a trequarti Capo: Triangolare



Ø mm	150 mm	180 mm	200 mm	230 mm	250 mm	300 mm
3,0	33-4130-15	33-4130-18	33-4130-20	33-4130-23		
3,5	33-4135-15	33-4135-18	33-4135-20	33-4135-23		
4,0	33-4140-15	33-4140-18	33-4140-20	33-4140-23	33-4140-25	
4,5	33-4145-15	33-4145-18	33-4145-20	33-4145-23	33-4145-25	33-4145-30
5,0	33-4150-15	33-4150-18	33-4150-20	33-4150-23	33-4150-25	33-4150-30

Spitze: Trokar Ende: Dreikant mit zentralem Gewinde (Durchmesser 0,5 mm größer als Schaft)
Tip: Trocar Rear: Triangular Shaft with central thread (Diam. 0,5 mm more than shaft)
Pointe: Trocart Bout: Triangulaire avec filet central (Diam. 0,5 mm supérieur à la tige)
Punta: Trócar Cabo: Triangular con rosca central (Díam. 0,5 mm superior al clavo)
Punta: a trequarti Capo: Triangolare con filetto centrale (Diam. 0,5 mm superiore al chiodo)

In Packungen zu 5 Stück
In packages of 5 ea.
En paquets de 5 pièces
En paquetes de 5 c/u
In pacchi di 5 pezzi



Ø mm	
3,0	33-4159-97
4,0	33-4159-98
5,0	33-4159-99

Schutzkappen
Tip Protectors
Protecteurs de la pointe
Protectores de la punta
Protettori della punta

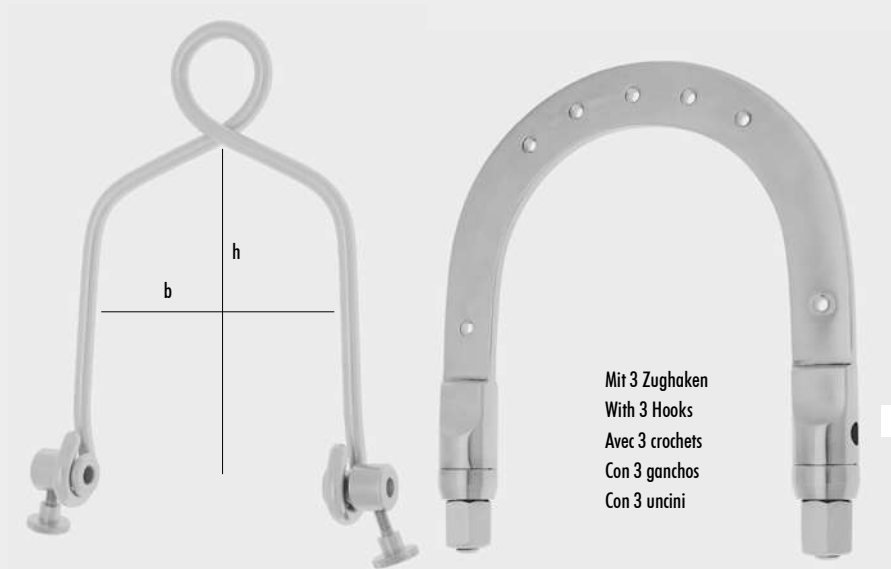

Mit 3 Zughaken
With 3 Hooks
Avec 3 crochets
Con 3 ganchos
Con 3 uncini



SW 14/17
33-5105-01



33-5105-02

h x b cm	BOEHLER
16 x 9	33-5002-16
21 x 11	33-5002-21
21 x 15	33-5002-22

h x b cm	KIRSCHNER
6,0 x 5,0	33-5102-06
9,5 x 7,0	33-5102-09
10,5 x 10,5	33-5102-10
9,5 x 11,0	33-5102-11
12,0 x 12,0	33-5102-12
13,5 x 13,0	33-5102-13
15,5 x 15,5	33-5102-15
20,0 x 15,5	33-5102-20

Extensionsbügel
Extension Bows
Étriers à extension
Estribos para extensión
Archi per estensione

KNOCHENCHIRURGIE,
TRAUMATOLOGIE

BONE SURGERY,
TRAUMATOLOGY

CHIRURGIE OSSEUSE,
TRAUMATOLOGIE

CIRUGÍA ÓSEA,
TRAUMATOLOGÍA

CHIRURGIA OSSEA,
TRAUMATOLOGIA



33-5109-01

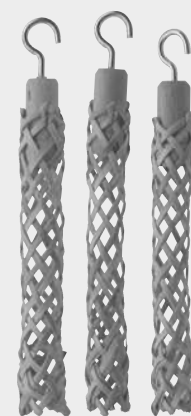

Fig. 1 Fig. 2 Fig. 3

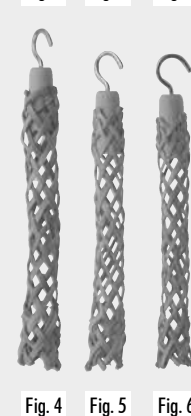

Fig. 4 Fig. 5 Fig. 6

h x b cm	
18 x 10	33-5104-18
27 x 16	33-5104-27

Mit 3 Zughaken
With 3 Hooks
Avec 3 crochets
Con 3 ganchos
Con 3 uncini

cm	KIRSCHNER U.S.
S 13,0	33-5108-01
L 18,5	33-5108-02
XL 22,0	33-5108-03

33-5109-02
Zughaken allein
Hooks only
Crochets seuls
Ganchos sueltos
Uncini soli

Fig.	
1 L	33-5202-01
2 M	33-5202-02
3 S	33-5202-03
Für Finger	
For Fingers	
Pour doigts	
Para dedos	
Per dita	

Fig.	
1	33-5204-01
2	33-5204-02
3	33-5204-03
4	33-5204-04
5	33-5204-05
6	33-5204-06

Fingerhülsen aus Bast

Extensionsbügel
Extension Bows
Étriers à extension
Estribos para extensión
Archi per estensione

Instrumente für Knochendraht
 Instruments for Bone Wire
 Instruments pour le fil à os
 Instrumentos para huesos
 Strumenti per ossa

**KNOCHENCHIRURGIE,
 TRAUMATOLOGIE**

**BONE SURGERY,
 TRAUMATOLOGY**

**CHIRURGIE OSSEUSE,
 TRAUMATOLOGIE**

**CIRUGÍA ÓSEA,
 TRAUMATOLOGÍA**

**CHIRURGIA OSSEA,
 TRAUMATOLOGIA**

Knochendraht und -Instrumente
 Bone Wire and Instruments
 Fil à os et instruments
 Hilo para huesos e instrumentos
 Filo per ossa e strumenti

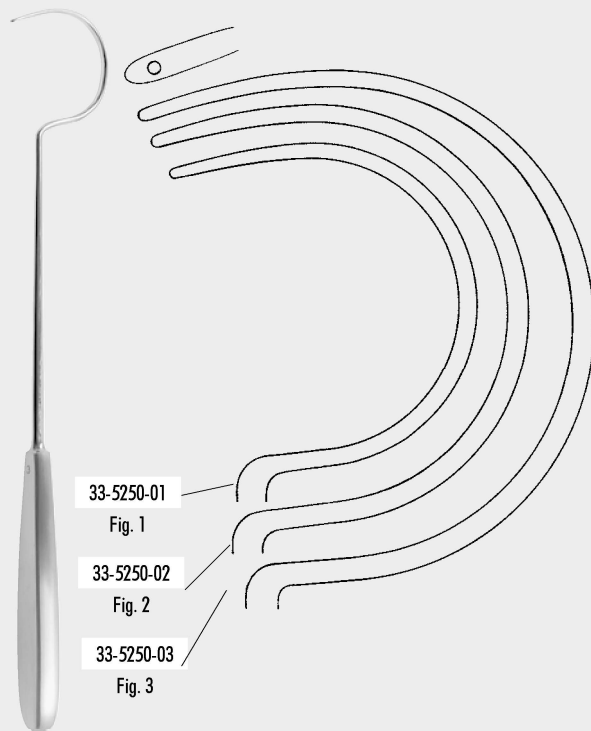

DEMEL
 33-5250-01 - 33-5250-03



cm DEMEL
 28,0 33-5254-28



cm DANIS
 20,0 33-5258-20



ø mm	ø mm	cm	DANIS	cm	DANIS	cm	DANIS	cm	DANIS	cm	DANIS
45	70	17,0	33-5262-17	19,0	33-5262-19	21,0	33-5262-21	24,0	33-5263-24	27,0	33-5263-27

Knochendraht und -Instrumente
 Bone Wire and Instruments
 Fil à os et instruments
 Hilo para huesos e instrumentos
 Filo per ossa e strumenti

KNOCHENCHIRURGIE,
 TRAUMATOLOGIE

BONE SURGERY,
 TRAUMATOLOGY

CHIRURGIE OSSEUSE,
 TRAUMATOLOGIE

CIRUGÍA ÓSEA,
 TRAUMATOLOGÍA

CHIRURGIA OSSEA,
 TRAUMATOLOGIA

Knochendraht weich, mit Öse
 Bone Wire, soft, with eye
 Fil à os, souple, avec œil
 Hilo p. huesos, blando, con ojo
 Filo p. ossa, morbido, con ansa



Knochendraht, weich
 Bone Wire, Soft
 Fil à os, souple - Hilo p.
 huesos blando - Filo p. ossa
 morbido

ø mm	
0,2	33-5300-02
0,3	33-5300-03
0,4	33-5300-04
0,5	33-5300-05
0,6	33-5300-06
0,7	33-5300-07
0,8	33-5300-08
0,9	33-5300-09
1,0	33-5300-10
1,1	33-5300-11
1,2	33-5300-12
1,5	33-5300-15



cm	LOUTE
21,0	33-5301-21

l = cm		ø mm
28,0	33-5291-08	0,8
28,0	33-5291-10	1,0
28,0	33-5291-12	1,2
60,0	33-5292-10	1,0
60,0	33-5292-12	1,2



Drahtfasszangen, Flachzangen
 Wire Holding Forceps, Flat-Nosed Pliers
 Pinces à saisir le fil métallique, Pinces plates
 Pinzas para agarrar hilo, pinzas de picos chatos
 Pinze per afferrare fili, pinze piatte

KNOCHENCHIRURGIE,
 TRAUMATOLOGIE

BONE SURGERY,
 TRAUMATOLOGY

CHIRURGIE OSSEUSE,
 TRAUMATOLOGIE

CIRUGÍA ÓSEA,
 TRAUMATOLOGÍA

CHIRURGIA OSSEA,
 TRAUMATOLOGIA



cm
 17,0 33-5302-17



cm VISE GRIP
 18,0 33-5303-18

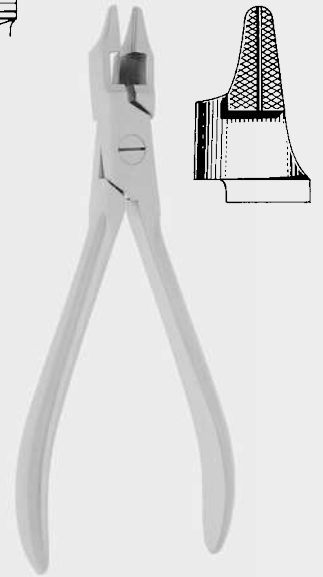

cm
 15,0 33-5304-15



cm
 13,0 33-5305-13
 18,0 33-5305-18



cm
 14,0 33-5306-14



cm
 19,0 33-5306-19

rund
 round
 rond
 redondo
 rondo



Fig.
 1 33-5307-01



Fig.
 2 33-5307-02



Fig.
 3 33-5307-03



Fig.
 4 33-5307-04



cm
 18,0 33-5307-01 - 33-5307-04

Mit TC-Einsätzen
 TC Lined
 A mors TC
 Con bocas TC
 Con morso TC



33-5308-01



33-5308-02



cm
 17,0 33-5308-01 - 33-5308-02



cm
 20,0 33-5309-20

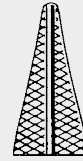

cm HACKSTOCK
 16,0 33-5310-16

Drahtfazzangen, Flachzangen
 Wire Holding Forceps, Flat-Nosed Pliers
 Pinces à saisir le fil métallique, Pinces plates
 Pinzas para agarrar hilo, pinzas de picos chatos
 Pinze per afferrare fili, pinze piatte

KNOCHENCHIRURGIE,
 TRAUMATOLOGIE

BONE SURGERY,
 TRAUMATOLOGY

CHIRURGIE OSSEUSE,
 TRAUMATOLOGIE

CIRUGÍA ÓSEA,
 TRAUMATOLOGÍA

CHIRURGIA OSSEA,
 TRAUMATOLOGIA



33-5312-14



33-5314-14



cm
 14,0 33-5312-14 - 33-5314-14



cm
 14,0 33-5315-14



cm
 15,5 33-5316-15
 18,0 33-5316-18





Mit TC-Einsätzen
 TC Lined
 A mors TC
 Con bocas TC
 Con morso TC

Draht-Zwirbelzangen
 Wire Twisting Forceps
 Pinces à torsader le fil
 Pinzas para retorcer el hilo
 Pinze per ritorcere fili

KNOCHENCHIRURGIE,
 TRAUMATOLOGIE

BONE SURGERY,
 TRAUMATOLOGY

CHIRURGIE OSSEUSE,
 TRAUMATOLOGIE

CIRUGÍA ÓSEA,
 TRAUMATOLOGÍA

CHIRURGIA OSSEA,
 TRAUMATOLOGIA



cm
 18,0 33-5318-18

cm
 14,5 33-5319-15

mm 22,0 cm
 5 33-5319-22

mm 25,5 cm
 5 33-5319-25

mm 30,0 cm
 7 33-5319-30

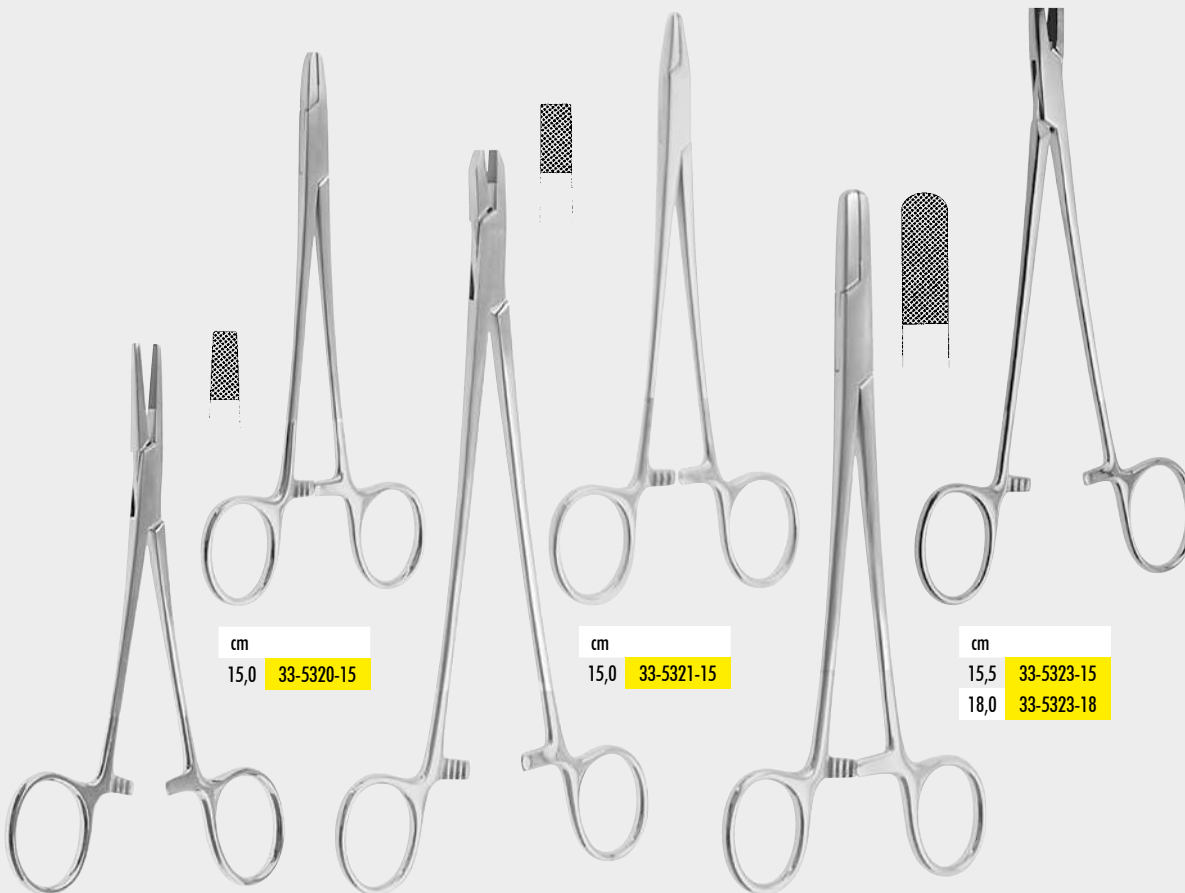

cm
 15,0 33-5320-15

cm
 15,0 33-5321-15

cm
 15,5 33-5323-15
 18,0 33-5323-18

cm
 14,0 33-5320-14

cm
 20,0 33-5320-20

cm
 18,0 33-5322-18

Mit TC-Einsätzen
TC Lined
A mors TC
Con bocas TC
Con morso TC



cm
18,0 33-5324-01 - 33-5324-03

Fig. 1 33-5324-01



Fig. 2 33-5324-02

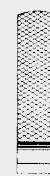

Fig. 3 33-5324-03



cm
18,0 33-5326-18 - 33-5328-18

mm
5,0 33-5326-18



mm
7,0 33-5328-18



Draht-Zwirbelzangen
Wire Twisting Forceps
Pinces à torsader le fil
Pinzas para retorcer el hilo
Pinze per ritorcere fili

KNOCHENCHIRURGIE,
TRAUMATOLOGIE

BONE SURGERY,
TRAUMATOLOGY

CHIRURGIE OSSEUSE,
TRAUMATOLOGIE

CIRUGÍA ÓSEA,
TRAUMATOLOGÍA

CHIRURGIA OSSEA,
TRAUMATOLOGIA

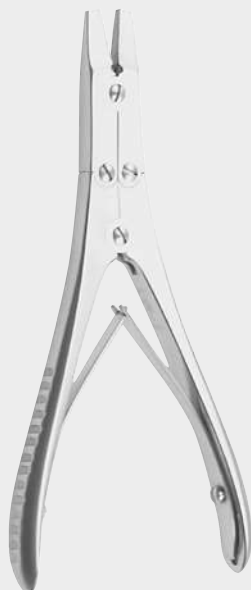

cm
14,0 33-5330-14



cm
14,0 33-5360-14

Für weichen Draht: bis 1,4 mm
Für harten Draht: bis 1,0 mm
For Soft Wire: up to 1,4 mm
For Hard Wire: up to 1,0 mm
Pour fil souple: jusqu'à 1,4 mm
Pour fil dur: jusqu'à 1,0 mm
Para hilo blando: hasta 1,4 mm
Para hilo duro: hasta 1,0 mm
Per filo morbido: fino a 1,4 mm
Per filo duro: fino a 1,0 mm

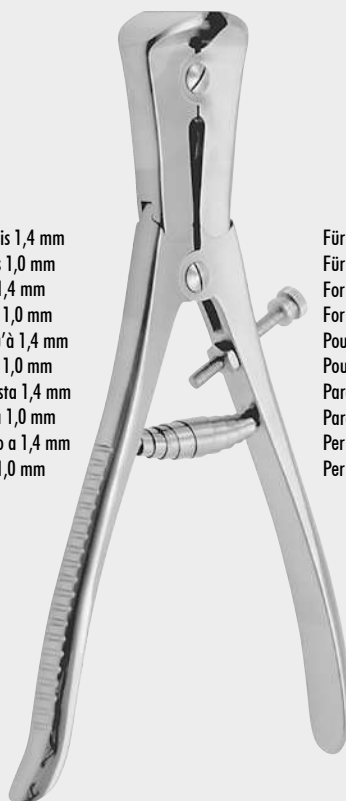

cm
23,0 33-5362-23

Für weichen Draht: bis 3,0 mm
Für harten Draht: bis 2,5 mm
For Soft Wire: up to 3,0 mm
For Hard Wire: up to 2,5 mm
Pour fil souple: jusqu'à 3,0 mm
Pour fil dur: jusqu'à 2,5 mm
Para hilo blando: hasta 3,0 mm
Para hilo duro: hasta 2,5 mm
Per filo morbido: fino a 3,0 mm
Per filo duro: fino a 2,5 mm

TC Schneiden
TC Cutting Edges
Tranchant TC
Filos de corte TC
Taglio TC

Drahtschneidezangen
Wire Cutting Forceps
Pinces à couper le fil
Pinzas para cortar alambre
Tronchesi taglafili

KNOCHENCHIRURGIE,
TRAUMATOLOGIE

BONE SURGERY,
TRAUMATOLOGY

CHIRURGIE OSSEUSE,
TRAUMATOLOGIE

CIRUGÍA ÓSEA,
TRAUMATOLOGÍA

CHIRURGIA OSSEA,
TRAUMATOLOGIA

Drahtschneidezangen
Wire Cutting Forceps
Pinces à couper le fil
Pinzas para cortar alambre
Tronchesi taglafili



Für weichen Draht: bis 2,2 mm
Für harten Draht: bis 2,0 mm
For Soft Wire: up to 2,2 mm
For Hard Wire: up to 2,0 mm
Pour fil souple: jusqu'à 2,2 mm
Pour fil dur: jusqu'à 2,0 mm
Para hilo blando: hasta 2,2 mm
Para hilo duro: hasta 2,0 mm
Per filo morbido: fino a 2,2 mm
Per filo duro: fino a 2,0 mm

cm Diamant
16,0 33-5400-16

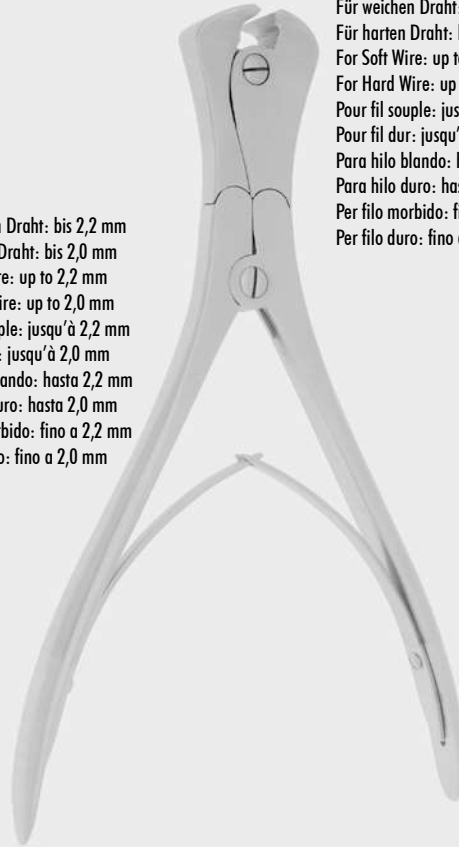

Für weichen Draht: bis 3,5 mm
Für harten Draht: bis 2,5 mm
For Soft Wire: up to 3,5 mm
For Hard Wire: up to 2,5 mm
Pour fil souple: jusqu'à 3,5 mm
Pour fil dur: jusqu'à 2,5 mm
Para hilo blando: hasta 3,5 mm
Para hilo duro: hasta 2,5 mm
Per filo morbido: fino a 3,5 mm
Per filo duro: fino a 2,5 mm

cm
22,0 33-5401-22



Für weichen Draht: bis 2,0 mm
Für harten Draht: bis 1,5 mm
For Soft Wire: up to 2,0 mm
For Hard Wire: up to 1,5 mm
Pour fil souple: jusqu'à 2,0 mm
Pour fil dur: jusqu'à 1,5 mm
Para hilo blando: hasta 2,0 mm
Para hilo duro: hasta 1,5 mm
Per filo morbido: fino a 2,0 mm
Per filo duro: fino a 1,5 mm

cm
15,0 33-5402-15



Für weichen Draht: bis 2,0 mm
Für harten Draht: bis 1,6 mm
For Soft Wire: up to 2,0 mm
For Hard Wire: up to 1,6 mm
Pour fil souple: jusqu'à 2,0 mm
Pour fil dur: jusqu'à 1,6 mm
Para hilo blando: hasta 2,0 mm
Para hilo duro: hasta 1,6 mm
Per filo morbido: fino a 2,0 mm
Per filo duro: fino a 1,6 mm

cm
18,0 33-5405-18

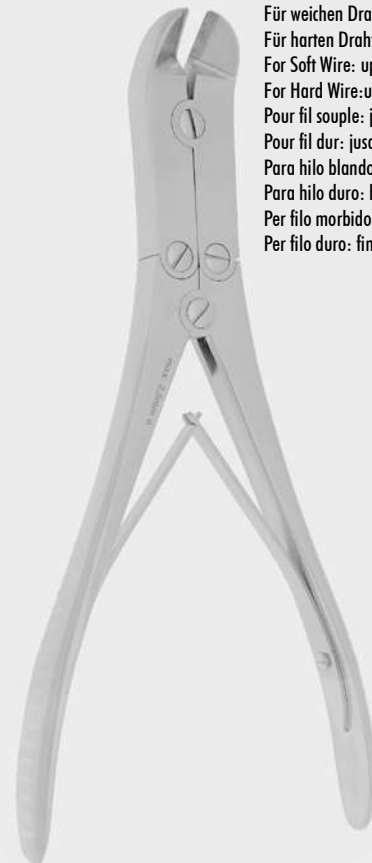

Für weichen Draht: bis 2,0 mm
Für harten Draht: bis 1,5 mm
For Soft Wire: up to 2,0 mm
For Hard Wire: up to 1,5 mm
Pour fil souple: jusqu'à 2,0 mm
Pour fil dur: jusqu'à 1,5 mm
Para hilo blando: hasta 2,0 mm
Para hilo duro: hasta 1,5 mm
Per filo morbido: fino a 2,0 mm
Per filo duro: fino a 1,5 mm

cm
22,0 33-5405-22

TC Schneiden
 TC Cutting Edges
 Tranchant TC
 Filos de corte TC
 Taglio TC

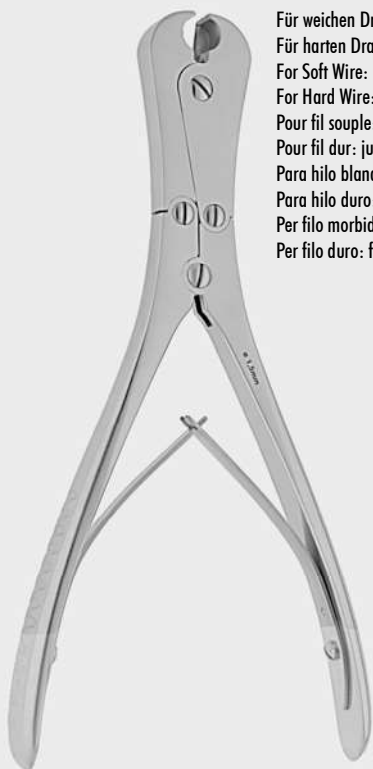

Für weichen Draht: bis 2,0 mm
 Für harten Draht: bis 1,5 mm
 For Soft Wire: up to 2,0 mm
 For Hard Wire: up to 1,5 mm
 Pour fil souple: jusqu'à 2,0 mm
 Pour fil dur: jusqu'à 1,5 mm
 Para hilo blando: hasta 2,0 mm
 Para hilo duro: hasta 1,5 mm
 Per filo morbido: fino a 2,0 mm
 Per filo duro: fino a 1,5 mm

cm
 18,0 33-5406-18



Für weichen Draht: bis 2,0 mm
 Für harten Draht: bis 1,6 mm
 For Soft Wire: up to 2,0 mm
 For Hard Wire: up to 1,6 mm
 Pour fil souple: jusqu'à 2,0 mm
 Pour fil dur: jusqu'à 1,6 mm
 Para hilo blando: hasta 2,0 mm
 Para hilo duro: hasta 1,6 mm
 Per filo morbido: fino a 2,0 mm
 Per filo duro: fino a 1,6 mm

cm REILL
 17,0 33-5407-17

Drahtschneidezangen
 Wire Cutting Forceps
 Pinces à couper le fil
 Pinzas para cortar alambre
 Tronchesi taglafili

KNOCHENCHIRURGIE,
 TRAUMATOLOGIE

BONE SURGERY,
 TRAUMATOLOGY

CHIRURGIE OSSEUSE,
 TRAUMATOLOGIE

CIRUGÍA ÓSEA,
 TRAUMATOLOGÍA

CHIRURGIA OSSEA,
 TRAUMATOLOGIA

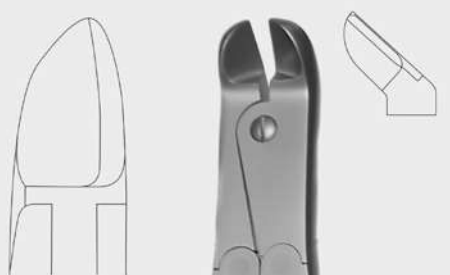

33-5408-23

33-5409-23

Für weichen Draht: bis 3,0 mm
 Für harten Draht: bis 2,2 mm
 For Soft Wire: up to 3,0 mm
 For Hard Wire: up to 2,2 mm
 Pour fil souple: jusqu'à 3,0 mm
 Pour fil dur: jusqu'à 2,2 mm
 Para hilo blando: hasta 3,0 mm
 Para hilo duro: hasta 2,2 mm
 Per filo morbido: fino a 3,0 mm
 Per filo duro: fino a 2,2 mm

cm
 23,0 33-5408-23 - 33-5409-23



cm
 16,5 33-5415-16

Mit TC-Einsätzen
TC Lined
A mors TC
Con bocas TC
Con morso TC

Für weichen Draht: bis 2,0 mm
Für harten Draht: bis 1,6 mm
For Soft Wire: up to 2,0 mm
For Hard Wire: up to 1,6 mm
Pour fil souple: jusqu'à 2,0 mm
Pour fil dur: jusqu'à 1,6 mm
Para hilo blando: hasta 2,0 mm
Para hilo duro: hasta 1,6 mm
Per filo morbido: fino a 2,0 mm
Per filo duro: fino a 1,6 mm

Für weichen Draht: bis 2,0 mm
Für harten Draht: bis 1,6 mm
For Soft Wire: up to 2,0 mm
For Hard Wire: up to 1,6 mm
Pour fil souple: jusqu'à 2,0 mm
Pour fil dur: jusqu'à 1,6 mm
Para hilo blando: hasta 2,0 mm
Para hilo duro: hasta 1,6 mm
Per filo morbido: fino a 2,0 mm
Per filo duro: fino a 1,6 mm

Kapazität bis 6 mm
Capacity up to 6 mm
Capacité jusqu'à 6 mm
Capacidad hasta 6 mm
Capacità fino a 6 mm

Drahtschneidezangen
Wire Cutting Forceps
Pinces à couper le fil
Pinzas para cortar alambre
Tronchesi tagliafili

KNOCHENCHIRURGIE,
TRAUMATOLOGIE

BONE SURGERY,
TRAUMATOLOGY

CHIRURGIE OSSEUSE,
TRAUMATOLOGIE

CIRUGÍA ÓSEA,
TRAUMATOLOGÍA

CHIRURGIA OSSEA,
TRAUMATOLOGIA

Instrumente zur Knochenagelung
Bone Nailing Instruments
Instruments pour l'enclouage des os
Instrumentos para el enclavamiento de huesos
Strumenti per il inchiodamento di ossa



cm
18,0 33-5500-18

Durchbohrt
Cannulated
Canulée
Canulada
Cannulata

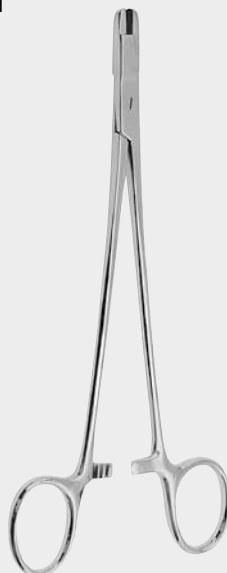

cm
17,0 33-5502-17



cm
24,0 33-5505-24

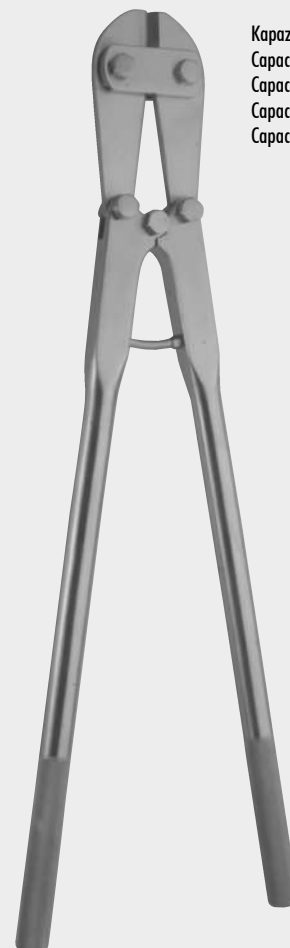

cm
48,0 33-5506-48 33-5508-48
56,0 33-5506-56



ø mm	
2,4	33-5600-24
3,2	33-5600-32
4,8	33-5600-48
6,4	33-5600-64



f. p. ø mm	
2,4	33-5602-24
3,2	33-5602-32
4,8	33-5602-48
6,4	33-5602-64



mm	KUENTSCHER 26,0 cm
8,0	33-5701-08
10,0	33-5701-10
12,5	33-5701-12



cm	KUENTSCHER
35,0	33-5703-35



ø mm	L=35 cm	L=46 cm	L=60 cm
2,5	33-5801-35	33-5801-46	
3,0	33-5802-35	33-5802-46	33-5802-60
3,5	33-5803-35	33-5803-46	33-5803-60
4,0	33-5804-35	33-5804-46	33-5804-60
5,0	33-5805-35	33-5805-46	33-5805-60



cm KUENTSCHER
21,0 33-5806-21



mm KUENTSCHER 21,0 cm
6-8 33-5807-13
9-12 33-5807-17
13-20 33-5807-21



cm KUENTSCHER
56,0 33-5900-00



Fig. KUENTSCHER
1 33-5900-01



Fig. KUENTSCHER
2 33-5900-02

Instrumente zur Knochnagelung
Bone Nailing Instruments
Instruments pour l'enclouage des os
Instrumentos para el enclavamiento de huesos
Strumenti per il inchiodamento di ossa

KNOCHENCHIRURGIE,
TRAUMATOLOGIE

BONE SURGERY,
TRAUMATOLOGY

CHIRURGIE OSSEUSE,
TRAUMATOLOGIE

CIRUGÍA ÓSEA,
TRAUMATOLOGÍA

CHIRURGIA OSSEA,
TRAUMATOLOGIA



L cm
29,0 33-5906-29
37,0 33-5906-37
42,0 33-5906-42
49,0 33-5906-49



33-5908-30



cm LLOYD
20,0 33-6002-20



Schraubendreher
Screw Drivers
Tournevis
Destornilladores
Giravite

KNOCHENCHIRURGIE,
TRAUMATOLOGIE

BONE SURGERY,
TRAUMATOLOGY

CHIRURGIE OSSEUSE,
TRAUMATOLOGIE

CIRUGÍA ÓSEA,
TRAUMATOLOGÍA

CHIRURGIA OSSEA,
TRAUMATOLOGIA



cm WILLIAMS
24,0 33-6204-24



SW mm
1,5 33-6208-15



SW mm
2,5 33-6208-25
3,5 33-6208-35



PHILLIPS
33-6212-25



cm
17,0 33-6214-17
25,0 33-6214-25



SW mm
1,5 33-6259-15



SW mm
2,5 33-6259-25



SW mm
3,5 33-6259-35



SW mm
1,5 33-6300-15

33-6300-98



SW mm
2,5 33-6300-25

33-6300-99



LANE
33-6302-25



cm
12,0 33-6303-13

cm
18,0 33-6305-18

cm
23,0 33-6307-23

cm
22,0 33-6309-22

cm
8,0 33-6350-08

Haltezange für kleine Plättchen
Holding Forceps for Small Plates
Pince à saisir les petites plaques
Pinza para sostener placas pequeñas
Pinza per afferrare placche piccole

Schraubenhaltepinzette, selbsthaltend
Screw Holding Forceps, Self-Retaining
Pince porte-vis automatique
Pinza porta-tornillos
Pinza porta-viti

Instrumente für Knochenplatten und -schrauben
Instruments for Bone Plates and Screws
Instruments pour plaques et vis osseuses
Instrumentos para placas y tornillos para huesos
Strumenti per placche e viti per ossa

KNOCHENCHIRURGIE,
TRAUMATOLOGIE

BONE SURGERY,
TRAUMATOLOGY

CHIRURGIE OSSEUSE,
TRAUMATOLOGIE

CIRUGÍA ÓSEA,
TRAUMATOLOGÍA

CHIRURGIA OSSEA,
TRAUMATOLOGIA

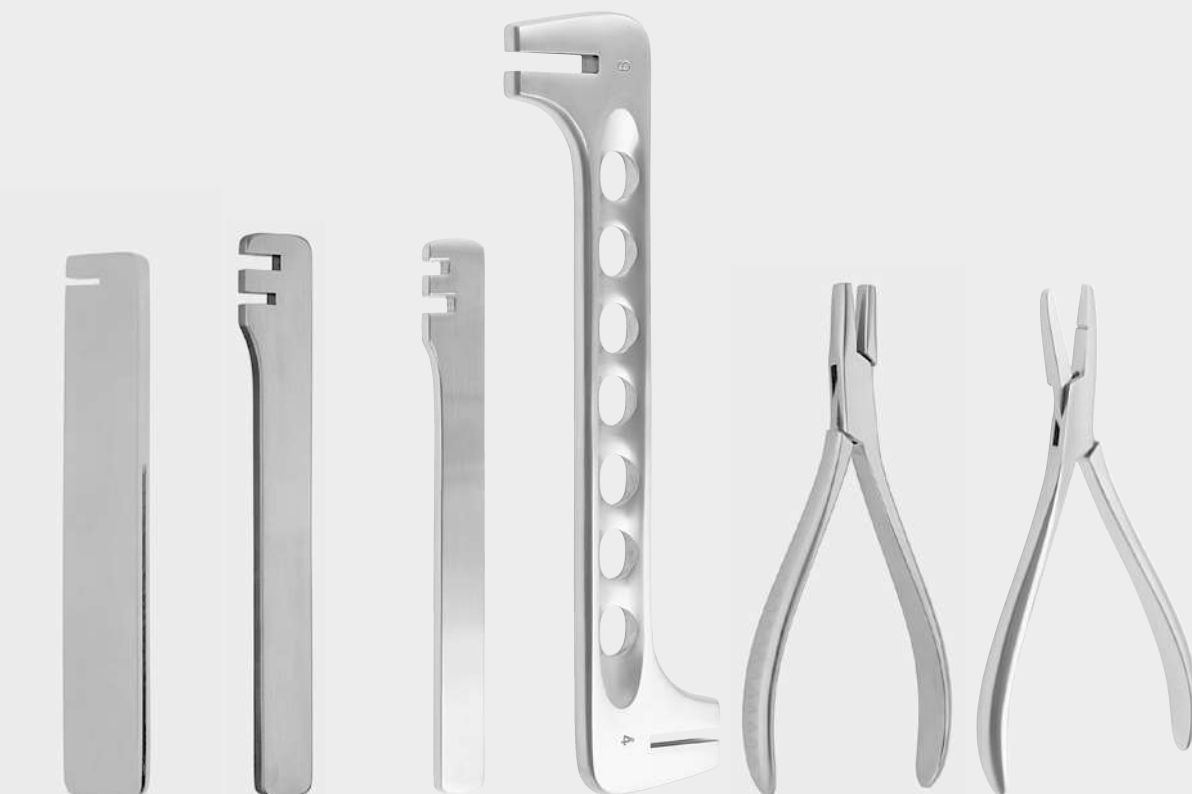

cm
13,0 33-6402-00

cm
14,5 33-6403-01

cm
14,5 33-6403-02

cm
25,0 33-6405-00

cm
14,0 33-6498-14

cm
14,0 33-6500-14

Schränkeisen für kleine Knochenplatten
Bending Irons for Small Bone Plates
Instruments pour courber les petites plaques
Instrumentos para doblar placas pequeñas
Strumenti per piegare placche piccole

Instrumente für Knochenplatten
Instruments for Bone Plates
Instruments pour plaques osseuses
Instrumentos para placas óseas
Strumenti per placche per ossa

KNOCHENCHIRURGIE, TRAUMATOLOGIE

BONE SURGERY, TRAUMATOLOGY

CHIRURGIE OSSEUSE, TRAUMATOLOGIE

CIRUGÍA ÓSEA, TRAUMATOLOGÍA

CHIRURGIA OSSEA, TRAUMATOLOGIA

Instrumente zur Osteosynthese
Osteosynthesis Instruments
Instruments pour l'ostéosynthèse
Instrumentos para osteosíntesis
Strumenti per osteosintesi



cm
22,0 33-6502-22

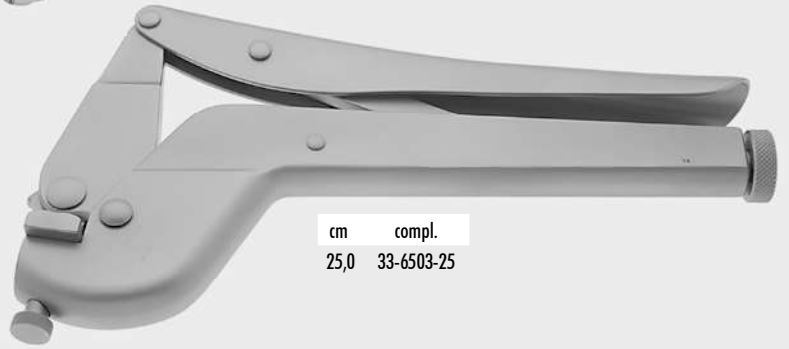
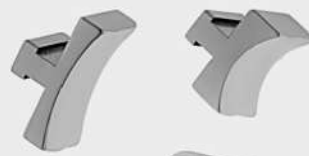

cm compl.
25,0 33-6503-25



33-6700-00

Bieseschablone für Knochenplatten
Bending template for bone plates
Patron pour plier les plaques à os
Patrón para doblar placas para huesos
Padrone per piegare placche per ossa



33-6704-09 - 33-6706-08

mm	mm	
5	90	33-6704-09
7	120	33-6704-12
9	150	33-6704-15
12	200	33-6704-20
7	60	33-6706-06
9	85	33-6706-08

A



160 mm

Knochenbohrer längsdurchbohrt
Drill bit cannulated
Mèche à os perforée longitudinalement
Taladro perforado longitudinalmente
Perforatore forato longitudinalmente

ø mm	A mm	
2,7	1,35	33-7900-27
3,2	1,75	33-7900-32
3,5	1,35	33-7900-35
4,5	1,75	33-7900-45
5,0	2,0	33-7900-50



33-7910-27
2,7 / 1,0 mm

Kleine Bohrbüchse
Tap Sleeve and drill sleeve
Guide-taraud et guide-mèche
Guía de broca y de terraja
Guida di perforatore e di maschio

* nicht kalibriert
not calibrated
pas calibré
no calibrado
non calibrato

Gewindeschneider, Schraubendreher
Taps and Screwdrivers
Tarauds et tourne-vis
Terraños y destornilladores
Maschiettori e giraviti



ø mm	
3,5	33-8102-35
4,0	33-8102-40
4,5	33-8102-45
7,0	33-8102-70



33-8104-00

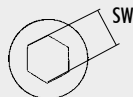

33-8107-25
33-8107-35

SW	
2,5 mm	33-8106-25
3,5 mm	33-8106-35

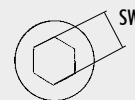

SW	
5,0 mm	33-8106-50

KNOCHENCHIRURGIE,
TRAUMATOLOGIE

BONE SURGERY,
TRAUMATOLOGY

CHIRURGIE OSSEUSE,
TRAUMATOLOGIE

CIRUGÍA ÓSEA,
TRAUMATOLOGÍA

CHIRURGIA OSSEA,
TRAUMATOLOGIA

Instrumente zur Osteosynthese
Osteosynthesis Instruments
Instruments pour l'ostéosynthese
Instrumentos para osteosíntesis
Strumenti per osteosintesi



33-8110-70 *
7,0 mm



33-8111-21
2,1 mm



33-8112-20
2,0 mm



33-8114-45 *
4,5 mm



33-8115-17
1,75 mm



33-8116-16
1,6 mm



33-8120-35 *
3,5 mm



33-8121-12
1,2 mm



33-8121-13
1,35 mm

Direkt-Längenmesslehren für Hohlschrauben mit Kanalbürsten und -reinigern
Direct screw length gauges for cannulated screws with canal brushes and canal cleaners
Mesureurs de longueur pour les vis à perforations longitudinales avec ses brosses et nettoyeurs des canaux
Medidores del largo de los tornillos con perforaciones longitudinales con sus cepillos y limpiadores de los canales
Misuratori della lunghezza delle viti con canali longitudinali con i suoi spazzole e pulitori dei canali

Instrumente zur Osteosynthese
Osteosynthesis Instruments
Instruments pour l'ostéosynthèse
Instrumentos para osteosíntesis
Strumenti per osteosintesi

KNOCHENCHIRURGIE,
TRAUMATOLOGIE

BONE SURGERY,
TRAUMATOLOGY

CHIRURGIE OSSEUSE,
TRAUMATOLOGIE

CIRUGÍA ÓSEA,
TRAUMATOLOGÍA

CHIRURGIA OSSEA,
TRAUMATOLOGIA

Kopfraumfräser
Countersinks
Forets-aléseurs
Avellanadores
Alesatori



33-8192-00

7,0 mm

Parallel-Zielgerät für Führungsdrähte \varnothing 2,0 mm
Parallel aiming device for guide wires \varnothing 2,0 mm
Viseur parallèle pour des broches \varnothing 2,0 mm
Visor paralelo para taladros filiformes \varnothing 2,0 mm
Visore parallelo per KIRSCHNER aghi \varnothing 2 mm



33-8200-00

Gewebeschutzhülse für Hohlsschrauben \varnothing 7 mm
Tissue protector sleeve for cannulated screws \varnothing 7 mm
Protecteur de tissu pour les vis à perforation longitudinale \varnothing 7 mm
Protector de tejido para tornillos con perforación longitudinal \varnothing 7 mm
Protettore di tessuto per viti con perforazione longitudinale \varnothing 7 mm

Kopfraumfräser
Countersinks
Forets-aléseurs
Avellanadores
Alesatori

1,1 mm



33-8201-11

1,5 / 2,0 mm

Für Mini-Schrauben
For mini screws
Pour les vis mini
Para los tornillos mini
Per viti mini

2,0 mm



33-8202-20

2,7 / 3,5 / 4,0 mm

Für kleine Schrauben
For small screws
Pour les petites vis
Para los tornillos pequeños
Per viti piccole

Malleolar
Malleolar
Malléolaire
Maleolar
Malleolare



33-8204-32

4,5 mm

4,5 mm



33-8206-45

4,5 / 6,5 mm

Für große Schrauben
For large screws
Pour les grandes vis
Para tornillos grandes
Per viti grandi

* nicht kalibriert
not calibrated
pas calibré
no calibrado
non calibrato

Tiefenmessgeräte, Messschablone
Depth Gauges, Measuring Gauge
Mesureurs de profondeur, de vis
Medidores de profundidad, de tornillos
Misuratori di profondità, di viti

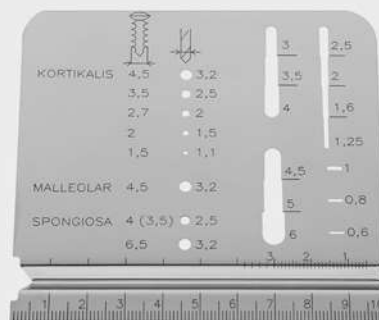

L 15,5 cm 33-8207-00 *
XL 20,5 cm 33-8207-01 *

L 15,5 cm 33-8208-00 *
XL 20,5 cm 33-8208-01 *

33-8209-01 *

33-8300-00 *

Mini

Klein - Small - Petit -
Pequeño - Piccolo

Groß - Large - Grand
Grande - Grande

KNOCHENCHIRURGIE,
TRAUMATOLOGIE

BONE SURGERY,
TRAUMATOLOGY

CHIRURGIE OSSEUSE,
TRAUMATOLOGIE

CIRUGÍA ÓSEA,
TRAUMATOLOGÍA

CHIRURGIA OSSEA,
TRAUMATOLOGIA



2,0 33-8402-20
2,7 33-8402-27
3,5 33-8402-35

33-8410-00

1,1 / 1,5 mm 33-8700-15
1,5 / 2,0 mm 33-8700-20

33-8702-20
2,0 mm

2,7 / 2,0 mm 33-8704-27
3,5 / 2,5 mm 33-8704-35
4,5 / 3,2 mm 33-8704-45

Halteklammer für Plättchen
Holding clamp for small plates
Porte-plaque - Porta-placas
Portaplacche

Scharfes Häkchen
Hooklet sharp
Crochet aigu
Ganchito agudo
Uncinetto acuto

Minibohrbüchse
Mini drill sleeve
Guide-mèche mini
Guía de broca mini
Guida di trapano mini

Ziel- und Plattenbohrbüchse
Drill guide and drill sleeve
Guide-mèche pour viseur
Guía-broca para visor
Guida di trapano per visore

Steckbohrbüchse
Insert drill sleeve
Guide-mèche à insérer
Guía de broca inyectable
Guida di trapano inseribile

Instrumente zur Osteosynthese
Osteosynthesis Instruments
Instruments pour l'ostéosynthese
Instrumentos para osteosíntesis
Strumenti per osteosintesi

ZEPF®
INSTRUMENTS

33-8704-45

33.31

Instrumente zur Osteosynthese
Osteosynthesis Instruments
Instruments pour l'ostéosynthèse
Instrumentos para osteosíntesis
Strumenti per osteosintesi

KNOCHENCHIRURGIE, TRAUMATOLOGIE

BONE SURGERY, TRAUMATOLOGY

CHIRURGIE OSSEUSE, TRAUMATOLOGIE

CIRUGÍA ÓSEA, TRAUMATOLOGÍA

CHIRURGIA OSSEA, TRAUMATOLOGIA



3,5 mm 33-8800-35
4,5 mm 33-8800-45

Zielgerät mit Gewinde
C-Clamp drill guide with thread
Guide-mèche avec filet
Guía de taladro con rosca
Guida di trapano con filetto



33-8801-45

Zielgerät mit Spitze
Pointed drill guide
Guide-mèche pointu
Guía de taladro puntiaguda
Guida di trapano con punta



33-8803-45

Anschlag-Steckbohrbüchse mit 2 Einsätzen
Drill guide with adjustable stop with 2 inserts
Guide-mèche avec arrêt réglable et 2 adaptateurs
Guía de broca con tope ajustable y 2 insertos
Guida di trapano con arresto regolabile e 2 innesti

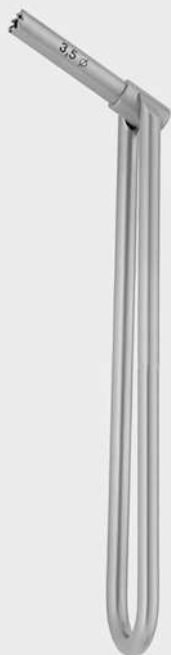

33-8805-35

Gewebeschutzhülse 3,5 mm für
Gewindeschneider 2,7 mm
Tap sleeve 3,5 mm for tap 2,7 mm
Guide-mèche 3,5 mm pour taraud 2,7 mm
Guía de broca 3,5 mm para macho 2,7 mm
Guida di trapano 3,5 mm per
maschiatore 2,7 mm



2,7 / 2,0 mm 33-8807-27
3,5 / 2,5 mm 33-8807-35

Gewebeschutzhülse und Bohrbüchse
für Bohrer und Gewindeschneider
für 3,5 mm Kortikalis-Schrauben
Tap sleeve and drill sleeve for
drill bit and tap for 3,5 mm cortex screws
Guide pour mèches et tarauds pour
des vis corticales 3,5 mm
Guía de broca y de macho para
tornillos corticales 3,5 mm
Guida di trapano e maschiatore per
viti corticali 3,5 mm



4,5 mm 33-8809-45

Gewebeschutzhülse für große Hohl-schrauben
Tap sleeve for large cannulated screws
Guide-mèche pour les grandes vis perforées
longitudinalement
Guía de brocas para los grandes tornillos
perforados longitudinalmente
Guida di trapano per grandi viti con
canale longitudinale

KNOCHENCHIRURGIE, TRAUMATOLOGIE

BONE SURGERY, TRAUMATOLOGY

CHIRURGIE OSSEUSE, TRAUMATOLOGIE

CIRUGÍA ÓSEA, TRAUMATOLOGÍA

CHIRURGIA OSSEA, TRAUMATOLOGIA

Instrumente zur Osteosynthese
 Instruments for Osteosynthesis
 Instruments pour l'ostéosynthèse
 Instrumentos para osteosíntesis
 Strumenti per osteosintesi

**KNOCHENCHIRURGIE,
 TRAUMATOLOGIE**

**BONE SURGERY,
 TRAUMATOLOGY**

**CHIRURGIE OSSEUSE,
 TRAUMATOLOGIE**

**CIRUGÍA ÓSEA,
 TRAUMATOLOGÍA**

**CHIRURGIA OSSEA,
 TRAUMATOLOGIA**

Doppel- und Universal-Bohrbüchsen
 Double and Universal Drill Guides
 Guide-mèches doubles et universels
 Guías de brocas dobles y universales
 Guida-trapani doppi ed universali



34-1002-32

Bohrlehre für Plattenspanner für Bohrer 3,2 mm
 Drill sleeve for tension device for drill bit ø 3,2 mm
 Guide-mèche pour tenseur de plaques pour mèches ø 3,2 mm
 Guía de brocas para tensor de placas para broca ø 3,2 mm
 Guida trapano per tensori di placche per trapano ø 3,2 mm



34-1005-40



34-1005-60

Bohrlehren für Rundlochplatten für Bohrer ø 3,2 mm
 Drill guides for round hole plates for drill bits ø 3,2 mm
 Guide-mèche pour les plaques à trous ronds pour des mèches ø 3,2 mm
 Guía de brocas para las placas con agujeros redondos para taladros ø 3,2 mm
 Guida trapano per le placche con fori rotondi per trapani ø 3,2 mm

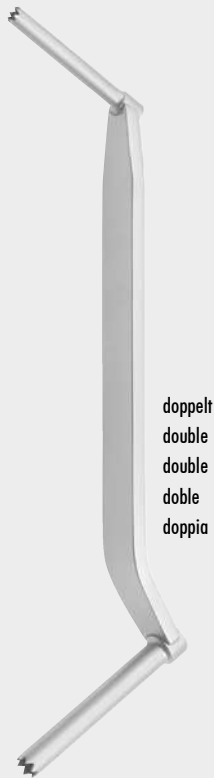

doppelt
 double
 double
 doble
 doppia

34-1010-45

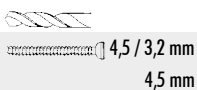

doppelt
 double
 double
 doble
 doppia

34-1012-65

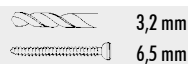

universal
 universal
 universal
 universale

34-1014-35



universal
 universal
 universal
 universale

34-1016-45



Plattenspanner
 Compression Devices
 Compresseurs de plaques
 Compresores de placas
 Compresori per placche



34-1100-08
 8 mm

Hub 8 mm
 Range 8 mm
 Course 8 mm
 Curso 8 mm
 Curso 8 mm



34-1101-16
 20 mm

Hub 20 mm
 Range 20 mm
 Course 20 mm
 Curso 20 mm
 Curso 20 mm



34-1101-99
 ø 4,5 mm / 12,0 cm

Stiftschlüssel
 Pin wrench
 Clé
 Llave
 Chiave

KNOCHENCHIRURGIE,
 TRAUMATOLOGIE

BONE SURGERY,
 TRAUMATOLOGY

CHIRURGIE OSSEUSE,
 TRAUMATOLOGIE

CIRUGÍA ÓSEA,
 TRAUMATOLOGÍA

CHIRURGIA OSSEA,
 TRAUMATOLOGIA



34-1105-11
 SW 11 mm



34-1106-11
 SW 11 mm

Schraubenschlüssel
 Socket and Combination Wrenches
 Clés à écrous
 Llaves para tuercas
 Chiavi per dadi

Bohrbüchsen, Zapfenfüßer
 Drill Guides, Reamer
 Guide-mèche, Fraise
 Guías de broca, Fresa
 Guida-tapano, Fresa

**KNOCHENCHIRURGIE,
 TRAUMATOLOGIE**

**BONE SURGERY,
 TRAUMATOLOGY**

**CHIRURGIE OSSEUSE,
 TRAUMATOLOGIE**

**CIRUGÍA ÓSEA,
 TRAUMATOLOGÍA**

**CHIRURGIA OSSEA,
 TRAUMATOLOGIA**

Instrumente für Winkelplatten
 Instruments for Angled Plates
 Instruments pour les plaques angulaires
 Instrumentos para placas angulares
 Strumenti per placche angolari



	2,0 mm	34-1205-20	neutr. / exc.
	2,7 mm	34-1205-27	neutr. / exc.
	3,5 mm	34-1205-35	neutr. / exc.
	4,5 mm	34-1207-45	neutr. / exc.



Hüfte - Hip-
 Hanche - Cadera -
 Anca

	4,5 mm	34-1209-60	60 mm
--	--------	------------	-------



Dreifach
 Triple
 Triplice

	3,2 mm	34-2100-13
--	--------	------------



AO 34-2102-02



34-2104-00



34-2302-13



34-2302-15



34-2304-20



34-2304-22

* nicht kalibriert
not calibrated
pas calibré
no calibrado
non calibrato

Instrumente für Winkelplatten
Instruments for Angled Plates
Instruments pour les plaques angulaires
Instrumentos para placas angulares
Strumenti per placche angolari



34-2306-07

Für Kleinkinder
For infants
Pour les petits enfants
Para niños pequeños
Per piccoli bambini



34-2308-17

Für kleinwüchsige Erwachsene und Jugendliche
For small adults and adolescents
Pour les petits adultes et les adolescents
Para adultos pequeños y adolescentes
Per adulti piccoli ed adolescenti



34-2310-02

Für Jugendliche und Kinder
For adolescents and children
Pour adolescents et enfants
Para adolescentes y niños
Per adolescenti e bambini

**KNOCHENCHIRURGIE,
TRAUMATOLOGIE**

**BONE SURGERY,
TRAUMATOLOGY**

**CHIRURGIE OSSEUSE,
TRAUMATOLOGIE**

**CIRUGÍA ÓSEA,
TRAUMATOLOGÍA**

**CHIRURGIA OSSEA,
TRAUMATOLOGIA**



34-2313-01 *
90° / 50° / 40°



34-2313-02 *
80° / 70° / 30°



34-2313-03 *
100° / 60° / 20°

Dreieckzielplatten für Erwachsene
Triangular Positioning Plates Adult Size
Plaques de pose triangulaires pour adultes
Patrones triangulares para adultos
Placche per posizionare per adulti

* nicht kalibriert
not calibrated
pas calibré
no calibrado
non calibrato

Dreieckzielplatten für Kinder
Triangular Positioning Plates Child Size
Plaques de pose triangulaires pour enfants
Patrones triangulares para niños
Placche triangolari per posizionare per bambini



34-2313-06 *
90° / 50° / 40°



34-2313-07 *
80° / 70° / 30°



34-2313-08 *
100° / 60° / 20°

Viereckzielplatten
Quadrangular Positioning Plates
Plaques de pose quadrangulaires
Patrones cuadrangulares
Placche quadrangolari per posizionare



34-2313-10 *
110° / 90° / 90° / 70°

Für Erwachsene
Adult size
Pour adultes
Para adultos
Per adulti



34-2313-16 *
110° / 90° / 90° / 70°

Für Kinder
Child size
Pour enfants
Para niños
Per bambini



34-2313-20 *

Kondylenzielgerät - Condylar plate guide - Viseur pour le positionnement de plaques condyliennes - Visor para posicionar placas condíleas - Visore per posizionare placche condiloidee

KNOCHENCHIRURGIE,
TRAUMATOLOGIE

BONE SURGERY,
TRAUMATOLOGY

CHIRURGIE OSSEUSE,
TRAUMATOLOGIE

CIRUGÍA ÓSEA,
TRAUMATOLOGÍA

CHIRURGIA OSSEA,
TRAUMATOLOGIA

Bohrziellehren verstellbar für dynamische Hüftschrauben
Drill Guides Adjustable for Dynamic Hip Screws
Guides de mèches réglables pour les vis fémorales dynamiques
Guías de brocas ajustables para tornillos femorales dinámicos
Guida-trapani regolabili per viti femorali dinamiche



34-3307-00 *
135° / 140° / 145° / 150°

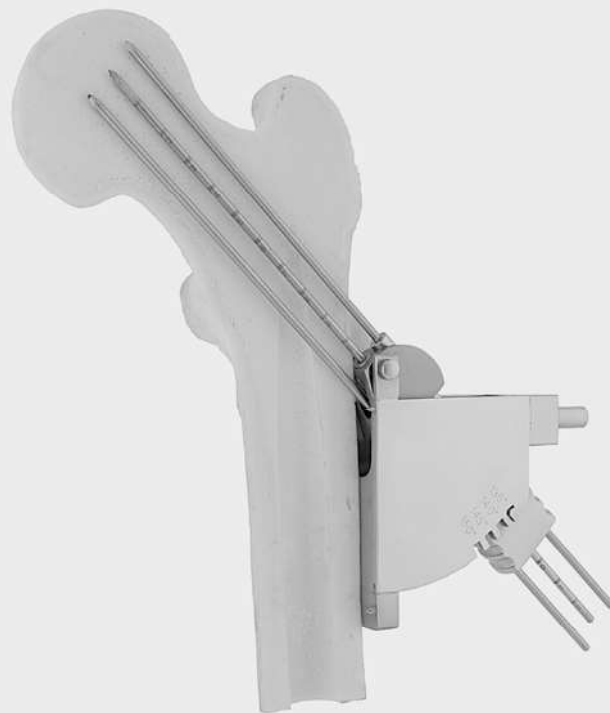

34-3307-03 *
135° / 140° / 145° / 150°



Führungsstift kalibriert mit Gewinde
 Guide pin threaded and calibrated
 Broche-guide calibré avec filet
 Guía calibrada con rosca
 Guida calibrata con filetto

34-3308-00
 L = 230 mm ø 2,5 mm



Bohrerführung
 Drill Guide
 Guide-mèche
 Guía taladro
 Guida trapano

135° 34-3308-01
 140° 34-3308-02
 145° 34-3308-03
 150° 34-3308-04



Schraubenmessgerät
 Measuring Gauge
 Mesureur des vis
 Medidor de los tornillos
 Misuratore delle viti

34-3308-05



Schraubenschlüssel
 Wrench
 Clé
 Llave
 Chiave

34-3308-06



Handgriff
 Handle
 Manche
 Mango
 Manico

34-3308-08



Einschläger
 Impactor
 Impacteur
 Impactor
 Conficcatore

34-3308-14



Gewindeschneider
 Tap
 Taraud
 Macho
 Maschiatore

34-3308-17 *

* nicht kalibriert
 not calibrated
 pas calibré
 no calibrado
 non calibrato

Instrumente für dynamische Hüftschrauben
 Instruments for Dynamic Hip Screws
 Instruments pour vis fémorales dynamiques
 Instrumentos para tornillos dinámicos femorales
 Strumenti per viti dinamiche femorali

KNOCHENCHIRURGIE,
 TRAUMATOLOGIE

BONE SURGERY,
 TRAUMATOLOGY

CHIRURGIE OSSEUSE,
 TRAUMATOLOGIE

CIRUGÍA ÓSEA,
 TRAUMATOLOGÍA

CHIRURGIA OSSEA,
 TRAUMATOLOGIA

Führungshülsen
Guide Sleeves
Gaines conductrices
Piezas de conducción
Pezzi per condurre

Instrumente für dynamische Hüftschrauben
Instruments for Dynamic Hip Screws
Instruments pour vis fémorales dynamiques
Instrumentos para tornillos dinámicos femorales
Strumenti per viti dinamiche femorali



34-3308-18

kurz, für
Gewindeschneider
short, for tapping
courte, pour les tarauds
corta, para machos
corto, per maschiatori



34-3308-19

lang, zum Einsetzen der
Hüftschrauben
long, for inserting the
hip screws
longue, pour l'introduction
des vis dynamiques
larga, para la introducción
de los tornillos dinámicos
lunga, per introdurre le
viti dinamiche



34-3308-20

Führungsschaft
Guide shaft
Tige conductrice
Asta conductora
Asta conduttrice



34-3308-21

Führungsschaft für
Kupplungsschraube
Guide shaft for coupling
screw
Guide pour l'introduction
des vis connectrices
Guía para la introducción
de los tornillos de acople
Guida per introdurre le
viti connetrici

**KNOCHENCHIRURGIE,
TRAUMATOLOGIE**

**BONE SURGERY,
TRAUMATOLOGY**

**CHIRURGIE OSSEUSE,
TRAUMATOLOGIE**

**CIRUGÍA ÓSEA,
TRAUMATOLOGÍA**

**CHIRURGIA OSSEA,
TRAUMATOLOGIA**



34-3308-22

Kupplungsschraube
Coupling Screw
Vis connectrice
Tornillo de acople
Vite connetrice



34-3308-42

Bohrerführung
Drill Guide
Guide-mèche
Guía de brocas
Guida di trapano



34-3308-93

Langer Fräser
Long reamer
Fraise longue
Fresa larga
Fresa lunga

Dreistufen-Bohrer
Triple Reamers
Fraises triples
Fresas triples
Frese triplici



34-3308-95

Kurzer Fräser
Short reamer
Fraise courte
Fresa corta
Fresa corta



Markraumborher flexibel mit HUDSON Ansatz
 Intramedullary reamers with HUDSON drive connection
 Mèches centromédullaires avec connecteurs HUDSON
 Taladros flexibles intramedulares con adaptadores HUDSON
 Trapani flessibili centromidollari con raccordi HUDSON

ø mm		ø mm	
5,5	34-3400-55	12,0	34-3401-20
6,0	34-3400-60	12,5	34-3401-25
6,5	34-3400-65	13,0	34-3401-30
7,0	34-3400-70	13,5	34-3401-35
7,5	34-3400-75	14,0	34-3401-40
8,0	34-3400-80	14,5	34-3401-45
8,5	34-3400-85	15,0	34-3401-50
9,0	34-3400-90	15,5	34-3401-55
9,5	34-3400-95	16,0	34-3401-60
10,0	34-3401-00	16,5	34-3401-65
10,5	34-3401-05	17,0	34-3401-70
11,0	34-3401-10	17,5	34-3401-75
11,5	34-3401-15	18,0	34-3401-80

34-3400-55 - 34-3401-80
L = 480 mm



Flexible Markraum-Bohrer, Ansatz Aesculap DIN 58809
 Flexible Intramedullary Reamers, adaptor Aesculap DIN 58809
 Mèches flexibles centromédullaires, adaptateurs Aesculap DIN 58809
 Brocas flexibles intramedulares, adaptadores Aesculap DIN 58809
 Trapani flessibili centromidollari, raccordi Aesculap DIN 58809

ø mm		ø mm	
5,5	34-3402-55	12,0	34-3403-20
6,0	34-3402-60	12,5	34-3403-25
6,5	34-3402-65	13,0	34-3403-30
7,0	34-3402-70	13,5	34-3403-35
7,5	34-3402-75	14,0	34-3403-40
8,0	34-3402-80	14,5	34-3403-45
8,5	34-3402-85	15,0	34-3403-50
9,0	34-3402-90	15,5	34-3403-55
9,5	34-3402-95	16,0	34-3403-60
10,0	34-3403-00	16,5	34-3403-65
10,5	34-3403-05	17,0	34-3403-70
11,0	34-3403-10	17,5	34-3403-75
11,5	34-3403-15	18,0	34-3403-80

34-3402-55 - 34-3403-80
L = 480 mm

Instrumente zur Markraumnagelung
 Instruments for Intramedullary Nailing
 Instruments pour l'enclouage centromédullaire
 Instrumentos para el enclavamiento intramedular
 Strumenti per il inchiodamento centro-midollare

**KNOCHENCHIRURGIE,
TRAUMATOLOGIE**

**BONE SURGERY,
TRAUMATOLOGY**

**CHIRURGIE OSSEUSE,
TRAUMATOLOGIE**

**CIRUGÍA ÓSEA,
TRAUMATOLOGÍA**

**CHIRURGIA OSSEA,
TRAUMATOLOGIA**



Führungsstäbe für Markraumborher
 Guide Rods for intramedullary reamers
 Guides pour les perforateurs centromédullaires
 Barras-guía para perforadores intramedulares
 Aste di guida per perforatori centro-midollari

34-3408-02

ø 3,0 mm L = 900 mm



34-3408-03

ø 4,0 mm L = 900 mm



Markraumborher
 Intramedullary Reamers
 Perforateurs centromédullaires
 Perforadores intramedulares
 Perforatori centro-midollari

ø mm	
6,0	34-3414-06
7,0	34-3414-07
8,0	34-3414-08
9,0	34-3414-09
10,0	34-3414-10
11,0	34-3414-11
12,0	34-3414-12
13,0	34-3414-13
14,0	34-3414-14
15,0	34-3414-15
16,0	34-3414-16
17,0	34-3414-17
18,0	34-3414-18
19,0	34-3414-19
20,0	34-3414-20

34-3414-06 - 34-3414-20

ZEPF®
INSTRUMENTS

Instrumente für flexible Markraumnägel
 Instruments for Flexible Intramedullary Nails
 Instruments pour les clous centromédullaires flexibles
 Instrumentos para los clavos intramedulares flexibles
 Strumenti per chiodi centromidollari flessibili

KNOCHENCHIRURGIE,
 TRAUMATOLOGIE

BONE SURGERY,
 TRAUMATOLOGY

CHIRURGIE OSSEUSE,
 TRAUMATOLOGIE

CIRUGÍA ÓSEA,
 TRAUMATOLOGÍA

CHIRURGIA OSSEA,
 TRAUMATOLOGIA



Einführer
 Inserer
 Introducteur
 Introducitor
 Introduuttore

34-3604-00



Einschläger
 Impactor
 Chasse-clou
 Empujador
 Conficatore

34-3605-00



Biegehebel
 Bender
 Plieur
 Plegador
 Piegatore

34-3608-00



Ein- und Ausschläger
 Impactor - Extractor
 Chasse-clou et extracteur
 Empujador y extractor
 Conficatore e cavachiodi

34-3610-00



Ausschläger
 Extractor
 Extracteur
 Extractor
 Cavachiodi

34-3614-00

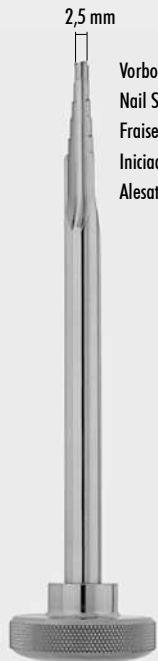

2,5 mm

Vorbohrer-Nagelstarter
Nail Starter and Cortex Broach
Fraise et chasse-clous
Iniciador para clavos y empujador
Alesatore corticale e strumento per conficcare

cm RITCHEY
20,0 34-3620-20



Einschläger-Ausschläger
Impactor-Extractor
Chasse-clous et extracteur
Empujador y extractor
Strumento per conficcare e cavachiodi

cm LLOYD
21,0 34-3621-21



Vorschläger
Nail Driver
Chasse-clous
Conductor
Conficcatore

cm SVEN JOHANSSON
16,0 34-3622-16

Instrumente für Drei-Lamellen-Nägel
Instruments for Three-Flange-Nails
Instruments pour les clous à trois ailettes
Instrumentos para clavos con tres aletas
Strumenti per chiodi con tre alette

KNOCHENCHIRURGIE,
TRAUMATOLOGIE

BONE SURGERY,
TRAUMATOLOGY

CHIRURGIE OSSEUSE,
TRAUMATOLOGIE

CIRUGÍA ÓSEA,
TRAUMATOLOGÍA

CHIRURGIA OSSEA,
TRAUMATOLOGIA



Nagelstarter
Nail Starter
Chasse-clous
Empujador
Strumento per conficcare

SMITH PETERSEN
34-3630-00



Einschläger-Ausschläger
Impactor-Extractor
Chasse-clous et extracteur
Empujador y extractor
Conficcatore e cavachiodi

JEWETT
34-3632-00

Instrumente für Knochennägel
 Instruments for Bone Nails
 Instruments pour les clous à os
 Instrumentos para los clavos para huesos
 Strumenti per chiodi per ossa

**KNOCHENCHIRURGIE,
 TRAUMATOLOGIE**

**BONE SURGERY,
 TRAUMATOLOGY**

**CHIRURGIE OSSEUSE,
 TRAUMATOLOGIE**

**CIRUGÍA ÓSEA,
 TRAUMATOLOGÍA**

**CHIRURGIA OSSEA,
 TRAUMATOLOGIA**

Instrumente für Knochenklammern
 Instruments for Bone Staples
 Instruments pour les agrafes à os
 Instrumentos para agrafes para huesos
 Strumenti per agrafe per ossa



Einschlaginstrument
 Impactor
 Chasse-clous
 Empujador
 Strumento da conficcare

cm PALMER
 15,0 34-3652-15



Nachschlaginstrument
 Final Impactor
 Impacteur final
 Empujador final
 Strumento da conficcare finale

cm PALMER
 17,0 34-3654-17



Auszieher
 Extractor
 Extracteur
 Extractor
 Estrattore

34-3702-00



Einschläger
 Driver
 Chasse-agrafes
 Empujador
 Strumento per conficcare

34-3704-00



Einsetzer
 Introducer
 Introducteur
 Introductor
 Introduttore

34-3706-00



Einschläger
 Driver
 Chasse-agrafes
 Empujador
 Strumento per conficcare

34-3708-00



Einschläger
 Driver
 Chasse-agrafes
 Empujador
 Strumento per conficcare

34-3710-01
 34-3710-02

Drahtspanner
Wire Tighteners
Tenseurs de fils
Tensores de alambre
Tensori per filo



34-3810-01



34-3810-02

Biegeisen für Bohrdrähte
Bending Iron for wire drills
Fer à plier les perforateurs filiformes
Instrumento para doblar perforadores filiformes
Strumento per piegare KIRSCHNER aghi



34-3820-00

Instrumente für Draht
Wire Instruments
Instruments pour le fil
Instrumentos para alambre
Strumenti per fili

KNOCHENCHIRURGIE,
TRAUMATOLOGIE

BONE SURGERY,
TRAUMATOLOGY

CHIRURGIE OSSEUSE,
TRAUMATOLOGIE

CIRUGÍA ÓSEA,
TRAUMATOLOGÍA

CHIRURGIA OSSEA,
TRAUMATOLOGIA



34-3850-01



34-3850-02



34-3850-03



34-3850-04



34-3850-05



34-3850-06



Schraubendreher mit auswechselbaren Klingen
Screwdriver with Interchangeable Blades
Tourne-vis avec les pointes interchangeables
Destornillador con hojas intercambiables
Cacciaviti con punte intercambiabili

34-3850-10

ZEPF®
INSTRUMENTS

**KNOCHENCHIRURGIE,
TRAUMATOLOGIE**

**BONE SURGERY,
TRAUMATOLOGY**

**CHIRURGIE OSSEUSE,
TRAUMATOLOGIE**

**CIRUGÍA ÓSEA,
TRAUMATOLOGÍA**

**CHIRURGIA OSSEA,
TRAUMATOLOGIA**

NEUROCHIRURGIE

NEUROSURGERY

NEUROCHIRURGIE

NEUROCIURUGÍA

NEUROCHIRURGIA

Clip-Anlegezangen
 Clip Applying Forceps
 Pincas à poser les clips
 Pinzas para poner grapas
 Pinze per posizionare agrafe

NEUROCHIRURGIE

NEUROSURGERY

NEUROCHIRURGIE

NEUROCIURUGÍA

NEUROCHIRURGIA



cm	McKENZIE
15,0	40-0101-15
19,0	40-0101-19



cm	McKENZIE
15,0	40-0103-15
19,0	40-0103-19



cm	SMITHWICK
23,0	40-0105-23
26,0	40-0105-26



cm	SWEET
23,0	40-0107-23
26,0	40-0107-26



OLIVECRONA TOENNIS

40-0109-14

Hirrnaht
Brain Suture
Suture cérébrale
Sutura cerebral
Sutura cerebrale

NEUROCHIRURGIE

NEUROSURGERY

NEUROCHIRURGIE

NEUROCIRUGÍA

NEUROCHIRURGIA

Schädelhalter
 Cervical Traction Tongs
 Pinces de traction crânienne
 Pinzas de tracción craneal
 Pinze per trazione craniale

NEUROCHIRURGIE

NEUROSURGERY

NEUROCHIRURGIE

NEUROCIRUGÍA

NEUROCHIRURGIA



STRAFFORD-CONE

40-0202-01

KOMPLETT/COMPLETE

40-0202-00

bestehend aus / consisting of / composé de/
 compuesto de / composto da:

1 x 40-0202-01

2 x 40-0202-35

2 x 40-0202-45

1 x 40-0202-90



ø mm

3,5 40-0202-35



ø mm

4,5 40-0202-45



40-0202-90



40-0204-00

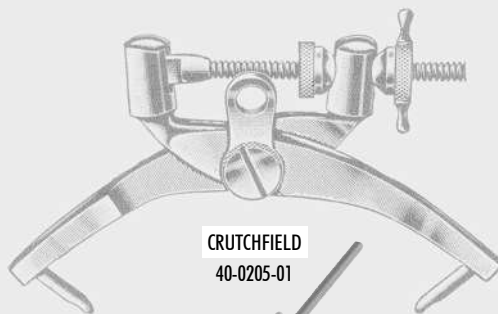

CRUTCHFIELD
40-0205-01



CRUTCHFIELD
40-0205-02



40-0206-35
3,5 mm ø



40-0206-50
5,0 mm ø

Schädelhalter
Cervical Traction Tongs
Pincès de traction crânienne
Pinzas de tracción cranial
Pinze per trazione craniale

NEUROCHIRURGIE

NEUROSURGERY

NEUROCHIRURGIA

NEUROCIRUGÍA

NEUROCHIRURGIA

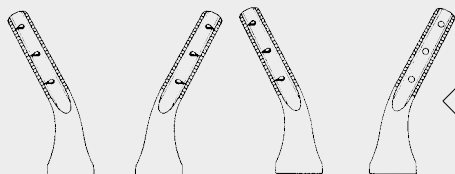

Federhaken zur Galea-Fixation
Spring Hooks for Galea Fixation
Écarteurs à ressort pour la fixation de la galéa
Separadores de resorte para la fijación de la galea
Divaricatori a molla per il fissaggio della galea



RANEY
40-0207-00

RANEY
40-0208-00

Kopfhautklammer, -anlegezange
Scalp Hemostasis Clip, Applying Forceps
Agrafe hémostatique pour le cuir chevelu, pince à poser - Grapa hemostática para cuero cabelludo, pinza para ponerla - Agrafe emostatiche per il cuoio capelluto, pinza per posizionare e togliere



cm YASARGIL ø mm
31,0 40-0490-31 7,0



cm YASARGIL ø mm
41,0 40-0490-41 9,0



cm ADSON
15,0 40-0495-15

Bohrerführungs- und Dura-Schutzzange
Drill Guide and Dura Protecting Forceps
Pince guide-foret et de protection de la dure-mère
Pinza guía-brocas y de protección de la dura madre
Guida-perforatori e protettore della dura-madre

Nervhaken
Nerve Retractors
Écarteurs à nerfs
Separadores para nervios
Divaricatori per nervi

NEUROCHIRURGIE

NEUROSURGERY

NEUROCHIRURGIE

NEUROCIRUGÍA

NEUROCHIRURGIA



Fig. 1
40-0504-01



Fig. 2
40-0505-02

cm HOEN
22,0 40-0500-22

cm DANDY
20,0 40-0501-20

cm DANDY
20,0 40-0502-20

cm DANDY
20,0 40-0503-20

CRILE
40-0504-01 - 40-0505-02

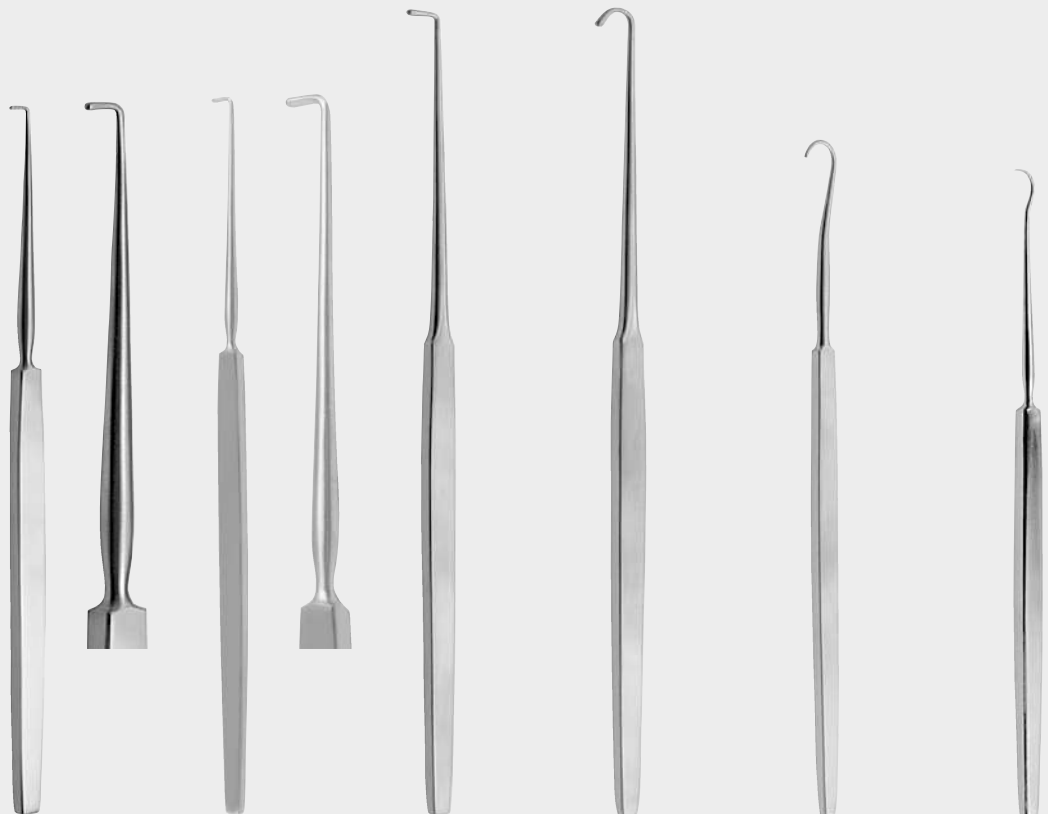

cm CUSHING
19,0 40-0506-19
28,0 40-0506-28

cm CUSHING
19,0 40-0508-19
28,0 40-0508-28

cm GRONINGEN
26,5 40-0510-26

cm GRONINGEN
26,5 40-0512-26

cm SMITHWICK
16,5 40-0514-17
21,0 40-0514-21

cm TOENNIS
15,0 40-0516-15

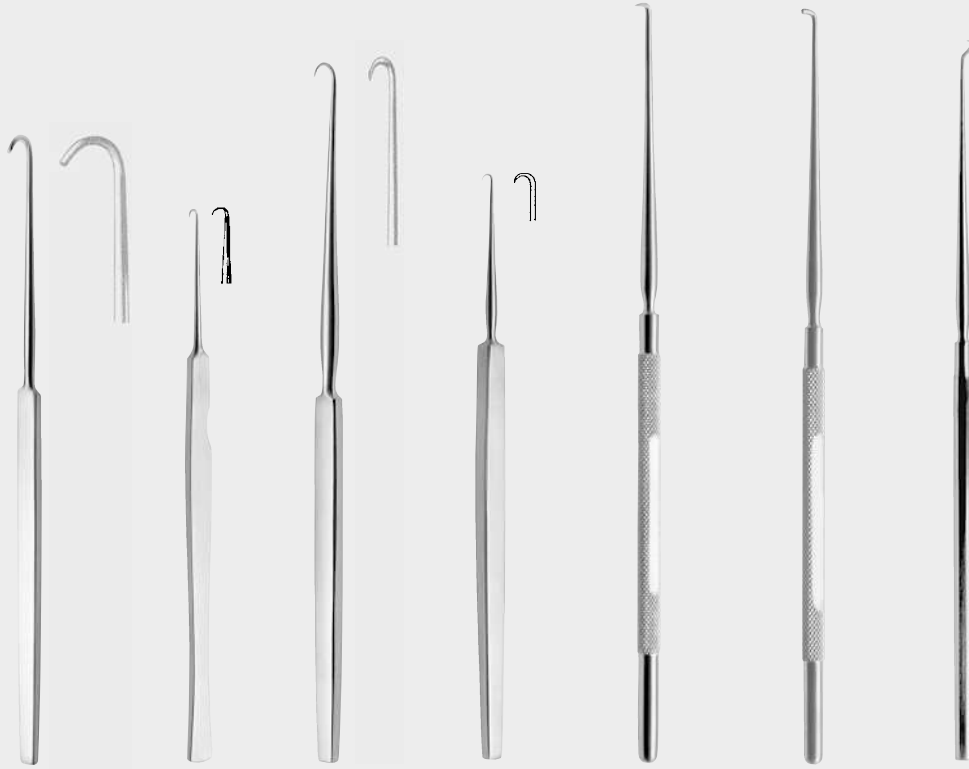

Nervhaken
Nerve Retractors
Écarteurs à nerfs
Separadores para nervios
Divaricatori per nervi

cm	GRAHAM	cm	LAHEY	cm	SACHS	cm	CUSHING	cm	ADSON	cm	ADSON	SELVERSTONE
16,5	40-0601-16	13,0	40-0602-13	18,5	40-0604-18	14,0	40-0606-14	20,0	40-0608-20	20,0	40-0609-20	40-0612-01
												40-0614-01
												19,0 cm

NEUROCHIRURGIE

NEUROSURGERY

NEUROCHIRURGIE

NEUROCIRUGÍA

NEUROCHIRURGIA



Nerv und Dura-Haken
Nerve and Dura Retractors
Écarteurs à nerfs et dure-mère
Separadores para nervios y la dura-madre
Divaricatori per nervi e duramadre

SELVERSTONE
40-0613-01
40-0615-01
19,0 cm

cm	SCOVILLE
30,0	40-0696-30

cm	SCOVILLE
30,0	40-0698-30

cm	SMITHWICK
29,0	40-0700-29

Nervwurzelhaken
Nerve Root Retractors
Écarteurs pour racines de nerfs
Separadores para raíz de nervios
Divaricatori per radici di nervi

NEUROCHIRURGIE

NEUROSURGERY

NEUROCHIRURGIE

NEUROCIRUGÍA

NEUROCHIRURGIA



mm HESS 17,5 cm
3 40-0703-03
5 40-0703-05
7 40-0703-07



cm LOVE
21,0 40-0799-21



mm CASPAR 24,0 cm
6 40-0792-06
8 40-0792-08
10 40-0792-10

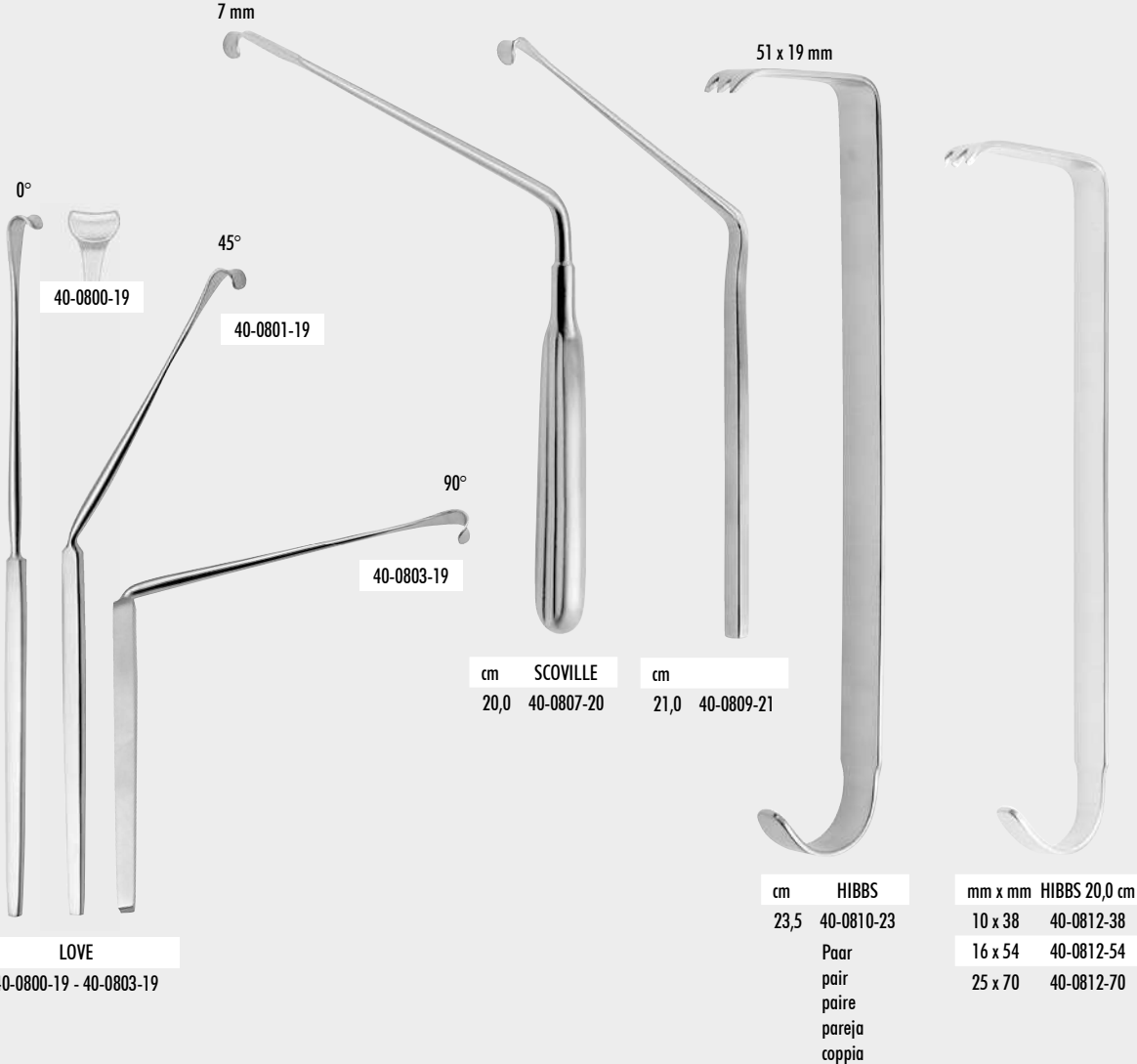

0°
40-0800-19

45°
40-0801-19

90°
40-0803-19

7 mm

51 x 19 mm

LOVE
40-0800-19 - 40-0803-19

cm SCOVILLE
20,0 40-0807-20

cm
21,0 40-0809-21

cm HIBBS
23,5 40-0810-23
Paar
pair
paire
pareja
coppia

mm x mm HIBBS 20,0 cm
10 x 38 40-0812-38
16 x 54 40-0812-54
25 x 70 40-0812-70



cm SCOVILLE
23,0 40-0820-23



cm HOLSHER
24,0 40-0823-24

Nervwurzelhaken
Nerve Root Retractors
Écarteurs pour racines de nerfs
Separadores para raíz de nervios
Divaricatori per radici di nervi

NEUROCHIRURGIE

NEUROSURGERY

NEUROCHIRURGIE

NEUROCIRUGÍA

NEUROCHIRURGIA

Umführungsinstr. für Drahtsägen
Conductor for Wire Saws
Conducteur pour fils-scies
Guía para sierras de hilo
Sonda per introdurre i fili di sega



cm LEBSCHE
25,0 40-0898-25



cm DeMARTEL
33,0 40-0900-33



GIGLI
40-0904-00



GIGLI
40-0905-00

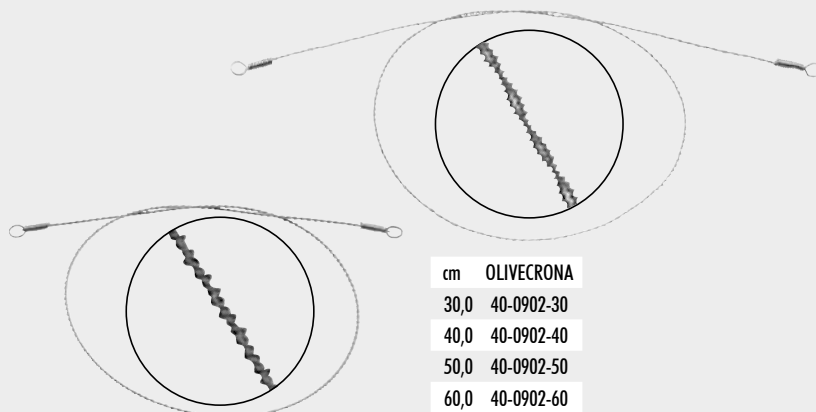

cm OLIVECRONA
30,0 40-0902-30
40,0 40-0902-40
50,0 40-0902-50
60,0 40-0902-60
70,0 40-0902-70

cm GIGLI
30,0 40-0901-30
40,0 40-0901-40
50,0 40-0901-50
60,0 40-0901-60
70,0 40-0901-70

Drahtsägen, Drahtsägengriffe
Wire Saws, Wire Saw Handles
Scies en fil métallique, Manches
Sierras de hilo de metal, Mangos
Fili sega, Manici per fili sega



Schädelzangen
Skull Punches
Pincas emporte-pièces crâniennes
Pinzas sacabocado para cráneo
Pinze per craniectomia

NEUROCHIRURGIE

NEUROSURGERY

NEUROCHIRURGIE

NEUROCIRUGÍA

NEUROCHIRURGIA



cm DeVILBISS
21,0 40-0906-21
mit 2 Haken
with 2 hooks
avec 2 crochets
con 2 ganchos
con 2 uncini



cm DAHLGREN
20,0 40-0907-20

40-0907-99



cm CONE
20,0 40-0908-20
23,0 40-0908-23



ø mm MICHELLE
5 40-0920-05
6 40-0920-06
8 40-0920-08

Trephine
Tréphine
Trépano
Trapano



7 mm
cm OLIVECRONA
19,5 40-1391-19
24,0 40-1391-24



3 mm
cm OLIVECRONA
18,0 40-1393-18
24,0 40-1393-24



mm TOENNIS 24,0 cm
5/6 40-1399-24



3,5 mm
cm TOENNIS
25,0 40-1401-25

Dura-Dissektoren
Dura Dissectors
Dissecteurs à dure-mère
Descoladores de duramadre
Scollatori di duramadre

NEUROCHIRURGIE

NEUROSURGERY

NEUROCHIRURGIE

NEUROCIRUGÍA

NEUROCHIRURGIA



SACHS
40-1403-21



5 mm
SACHS
40-1405-21



3 mm
MILLIGAN
4 mm
40-1407-21



Dura-Dissektoren, -Messer
 Dura Dissectors, Knife
 Dissecteur, Bistouri à dure-mère
 Descoladores, Bisturí para duramadre
 Scollatori, Bisturi per la duramadre

NEUROCHIRURGIE

NEUROSURGERY

NEUROCHIRURGIE

NEUROCIURUGÍA

NEUROCHIRURGIA

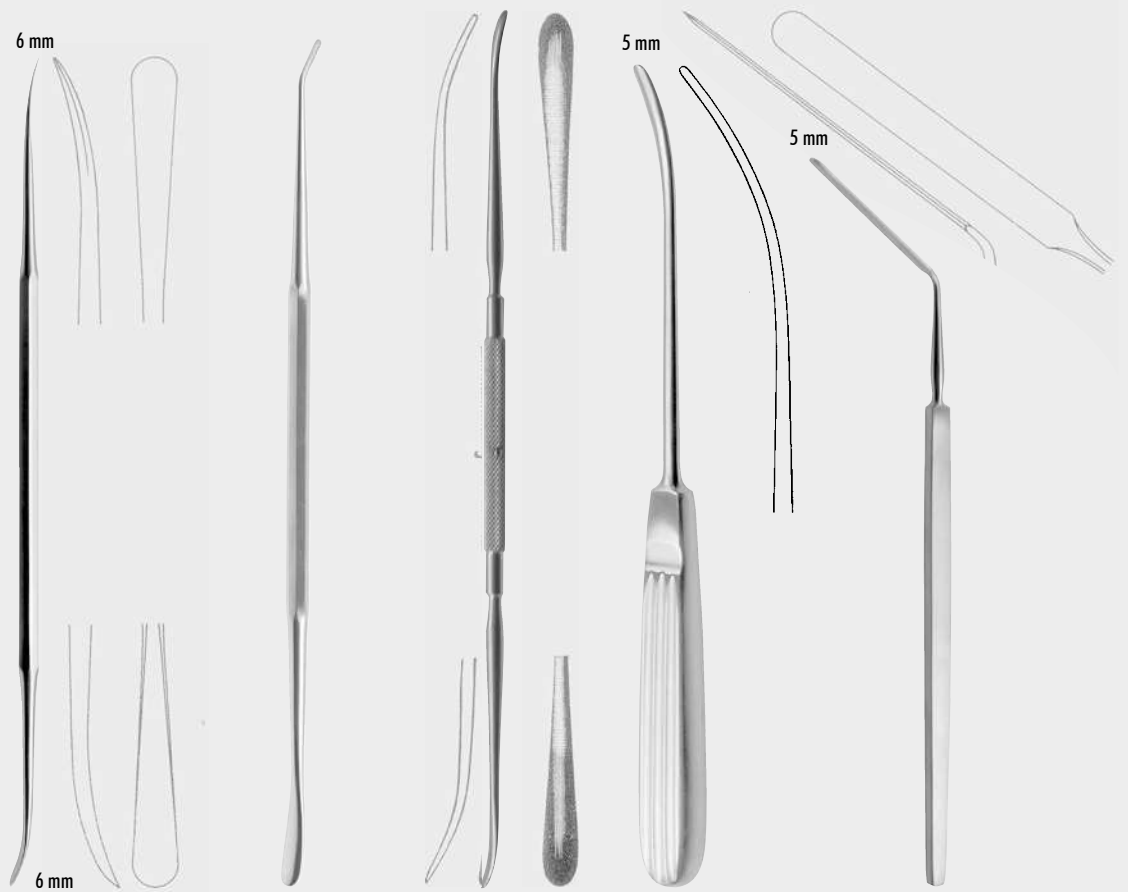

cm	PENNYBACKER	cm	DAVIS	cm	SACHS	cm	HORSLEY
22,0 40-1409-22	23,0 40-1420-23	24,5 40-1501-24	21,0 40-1503-21	20,0 40-1505-20			

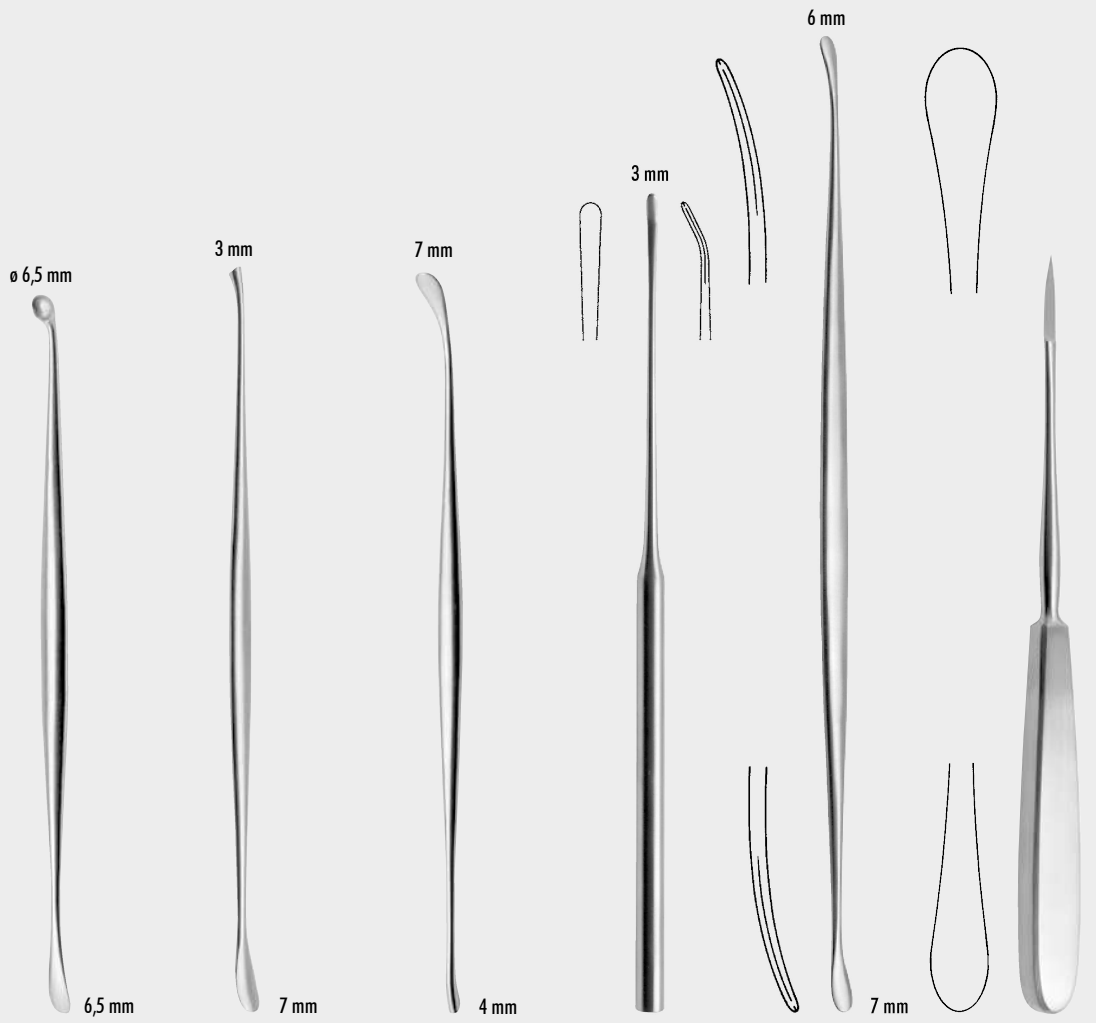

cm	PENFIELD	cm	PENFIELD	cm	PENFIELD	cm	PENFIELD	cm	PENFIELD	cm	HALLE
17,5 40-1409-22	19,5 40-1601-01	19,5 40-1601-02	19,5 40-1601-03	21,5 40-1601-04	29,0 40-1601-05	20,0 40-1700-20					



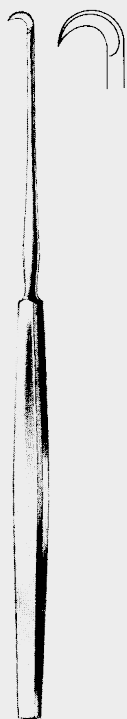

cm OLIVECRONA
19,0 40-1707-19



cm TOENNIS
13,0 40-1708-13
19,0 40-1708-19



cm FRAZIER
15,0 40-1711-15



cm HOEN
40-1713-15



cm HOEN
40-1715-15

Dura-Messer, Dura-Elevatorien
Dura Knife, Dura Dissectors
Bistouri à dure-mère, Elevateurs pour la dure-mère
Bisturí para la duramadre, Elevadores para la duramadre
Bisturi per la duramadre, Elevatori per la duramadre

NEUROCHIRURGIE

NEUROSURGERY

NEUROCHIRURGIE

NEUROCIRUGÍA

NEUROCHIRURGIA



cm ADSON
23,0 40-2100-23



cm ADSON
23,0 40-2101-23



cm ADSON
23,0 40-2103-23

Hypophysenpinzetten
Hypophyseal Forceps
Pinces à hypophyse
Pinzas para hipófisis
Pinze per ipofisi

LEYLA Retraktor System
 LEYLA Retractor System
 LEYLA système d'écarteurs
 LEYLA sistema de separadores
 LEYLA sistema di divaricatori

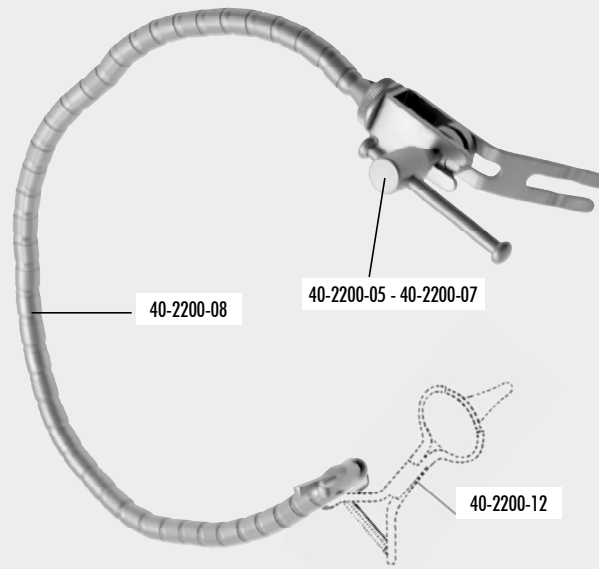

40-2200-08 Spannarm, allein
 Flexible Arm only
 Bras flexible seul
 Brazo flexible suelto
 Braccio flessibile solo

40-2200-12 Ohrtrichterhalter, allein
 Ear Specula Holder only
 Support pour spéculum auriculaire
 Soporte para espéculo de oídos
 Sostegno per specolo auricolare

NEUROCHIRURGIE

NEUROSURGERY

NEUROCHIRURGIE

NEUROCIRUGÍA

NEUROCHIRURGIA

Bestandteile
 Components
 Composants
 Componentes
 Componenti



40-2200-05

Fixiervorrichtung am Schädel für 1 Arm
 Fixation Base for 1 arm at skull
 Base de fixation pour 1 bras au crâne
 Fijador para 1 brazo al cráneo
 Fissatore per 1 braccio al cranio



40-2200-06

Fixiervorrichtung am Schädel für 2 Arme
 Fixation Base for 2 arms at skull
 Base de fixation pour 2 bras au crâne
 Fijador para 2 brazos al cráneo
 Fissatore per 2 bracci al cranio



40-2200-07

Fixiervorrichtung am Starrarm für 1 Arm
 Fixation Base for 1 arm at rigid arm
 Base de fixation pour 1 bras au bras rigide
 Fijador para 1 brazo al brazo rígido
 Fissatore per 1 braccio al braccio rigido

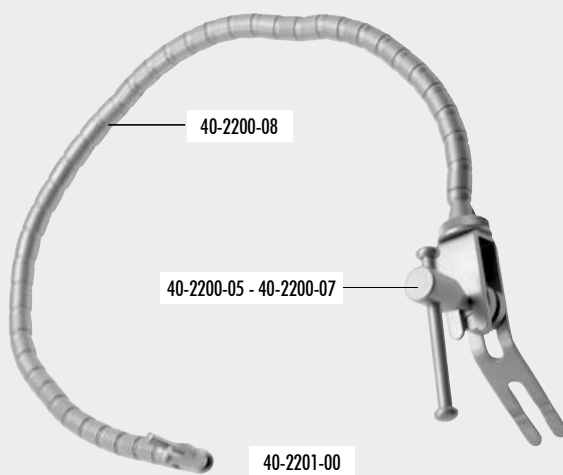

Hirnspatelhalter, selbsthaltend, flexibel, für flache Spatel, mit 1 Spannarm, komplett, bestehend aus:
 Brain Retractor, Self Retaining, Flexible, for flat spatula, with 1 flexible arm, complete, consisting of:
 Écarteur autostatique, flexible, pour les spatules plates, avec un bras flexible, complet, composé de: 40-2200-05, 40-2200-08, 40-2200-09
 Separador autorretentivo, flexible, para espátulas llanas, con 1 brazo flexible, completo, compuesto de:
 Divaricatore autostatico, flessibile, per spatole piatte, con 1 braccio flessibile, completo, composto da:

LEYLA Retraktor Set Nr. 1 (1 Arm)
 LEYLA Retractor Set No. 1 (1 Arm)
 LEYLA Set no. 1 (1 bras)
 LEYLA Set núm. 1 (1 brazo)
 LEYLA Set nro. 1 (1 braccio)

NEUROCHIRURGIE

NEUROSURGERY

NEUROCHIRURGIE

NEUROCIRUGÍA

NEUROCHIRURGIA

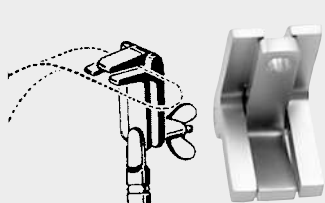

40-2200-09

Halter für flache Hirnspatel
 Holder for flat brain spatula
 Support pour les spatules plates
 Soporte para espátulas llanas
 Sostegno per spatole piatte

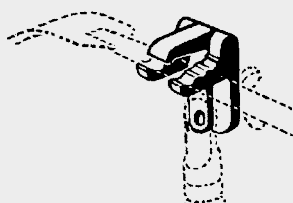

40-2200-10

Halter für Hirnspatel mit rundem Schaft
 Holder for brain spatula with round stem
 Support pour les spatules à tige ronde
 Soporte para espátulas con vástago redondo
 Sostegno per spatole con asta rotonda

Bestandteile
 Components
 Composants
 Componentes
 Componenti



LEYLA Retraktor Set Nr. 2
 LEYLA Retractor Set No. 2
 LEYLA Set no. 2
 LEYLA Set núm. 2
 LEYLA Set nro. 2



40-2202-00

Hirnspatelhalter, selbsthaltend, flexibel, für flache Spatel, mit 2 Spannarmen, komplett, bestehend aus:

Brain Retractor, Self Retaining, flexible, for flat spatula, with 2 flexible arms, complete, consisting of:

2 x 40-2200-08

Écarteur autostatique, flexible, pour les spatules plates, avec 2 bras flexibles, complet, composé de:

1 x 40-2200-06

Separador autorretentivo, flexible, para espátulas llanas, con 2 brazos flexibles, completo, compuesto de:

1 x 40-2200-09

Divaricatore autostatico, flessibile, per spatole piatte, con 2 bracci flessibili, completo, composto da:

NEUROCHIRURGIE

NEUROSURGERY

NEUROCHIRURGIE

NEUROCIRUGÍA

NEUROCHIRURGIA

LEYLA Retraktor Set Nr. T1
 LEYLA Retractor Set No. T1
 LEYLA Set no. T1
 LEYLA Set núm. T1
 LEYLA Set Nro. T1

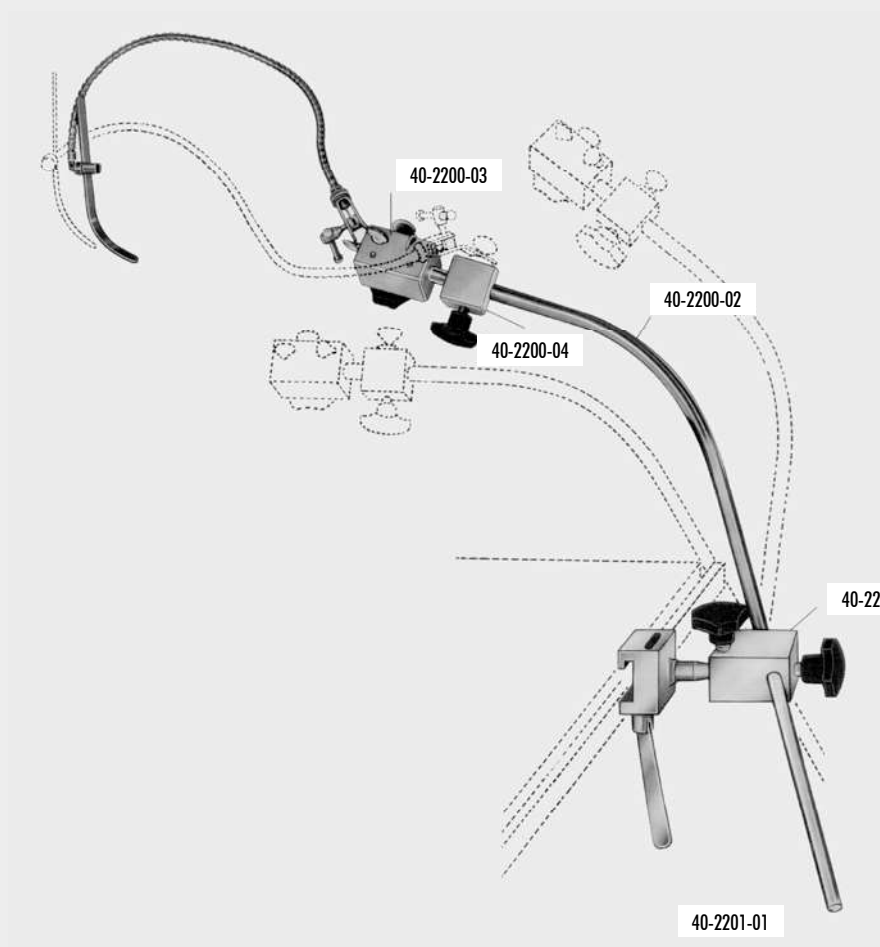

Set Nr. T1 zur Montage an Op-Tisch-Seitenschienen, bestehend aus:

Set No. T1 for fixation to OR table side rails, consisting of:

1 x 40-2200-01

Set no. T1, pour le montage aux rails latéraux de la table d'OP, composé de:

1 x 40-2200-02

Set núm. T1, para montar al carril lateral de la mesa operatoria, compuesto de:

1 x 40-2200-08

Set nro. T1, per montaggio al tavolo di operazione, composto da:

1 x 40-2200-09

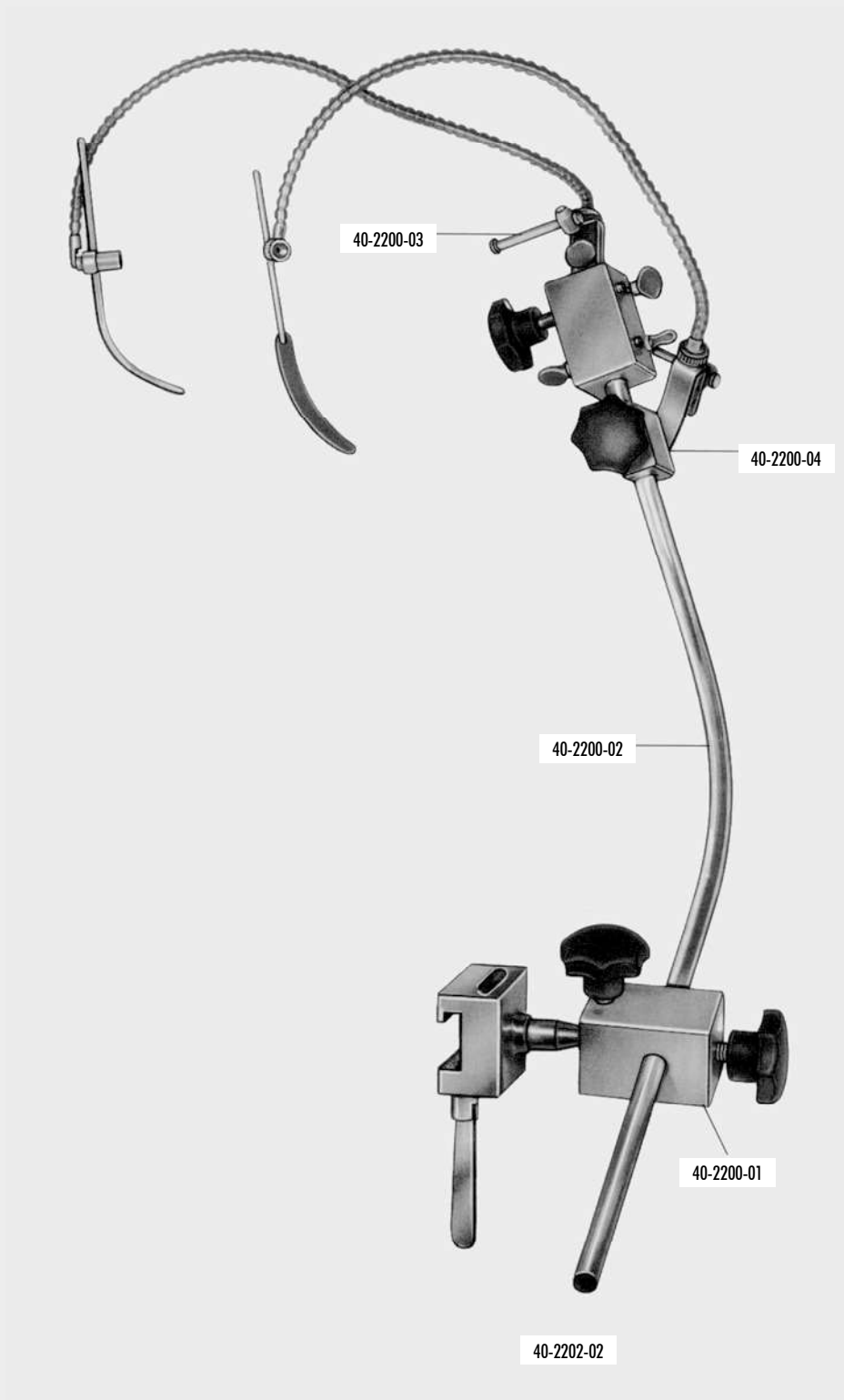

Set Nr. T2 (2 Arme) zur Montage an OP-Tisch-Seitenschiene, bestehend aus:
 Set No. T2 (2 Arms), for fixation to OR table siderails, consisting of:
 Set no. T2 (2 bras), pour le montage aux rails latéraux de la table d'OP, composé de:
 Set núm. T2 (2 brazos), para montar al carril lateral de la mesa operatoria, compuesto de:
 Set nro. T2 (2 bracci) per montaggio al tavolo di operazione, composto da:

40-2200-01, 40-2200-02,
 40-2200-03, 40-2200-04,
 2 x 40-2200-07, 2 x 40-2200-08,
 2 x 40-2200-09

LEYLA Retraktor Set Nr. T2
 LEYLA Retractor Set No. T2
 LEYLA Set no. T2
 LEYLA Set núm. T2
 LEYLA Set Nro. T2

NEUROCHIRURGIE

NEUROSURGERY

NEUROCHIRURGIE

NEUROCIRUGÍA

NEUROCHIRURGIA

ZEPF[®]

 INSTRUMENTS

40-2200-09

40.17

Saugrohre
Aspirating Tubes
Tubes d'aspiration
Tubos de aspiración
Tubi per aspirazione



Charr. / F.G.	POPEN
6	40-2809-06
8	40-2809-08
10	40-2809-10
12	40-2809-12



FRAZIER		
cm	19,0	19,0
Charr. / F.G.	30°	75°
6	40-2905-06	40-2907-06
7	40-2905-07	40-2907-07
8	40-2905-08	40-2907-08
9	40-2905-09	40-2907-09
10	40-2905-10	40-2907-10
11	40-2905-11	40-2907-11
12	40-2905-12	40-2907-12
15	40-2905-15	40-2907-15

NEUROCHIRURGIE

NEUROSURGERY

NEUROCHIRURGIE

NEUROCIURGÍA

NEUROCHIRURGIA

Gehirnventrikel-Punktionkanülen
Ventriculopuncture Cannulae
Aiguilles pour la ponction ventriculaire
Agujas para la punción ventricular
Aghi per la puntura ventricolare

YASARGIL				
ø mm	13,0 cm	15,0 cm	18,0 cm	22,0 cm
1,5	40-2806-13	40-2806-15	40-2806-18	40-2806-22
2,0	40-2807-13	40-2807-15	40-2807-18	40-2807-22
2,5	40-2808-13	40-2808-15	40-2808-18	40-2808-22
3,5	40-2809-13	40-2809-15	40-2809-18	40-2809-22

mm	ADSON	cm
3	40-2900-14	14,0
4	40-2900-21	21,0



mm	FRAZIER, 12,0 cm
2,0	40-2908-08
2,5	40-2908-10
3,0	40-2908-12



RHOTON			
Charr. / Fr.	15,0 cm	17,0 cm	20,0 cm
3	40-3015-03	40-3017-03	40-3020-03
5	40-3015-05	40-3017-05	40-3020-05
7	40-3015-07	40-3017-07	40-3020-07
10	40-3015-10	40-3017-10	40-3020-10
12	40-3015-12	40-3017-12	40-3020-12

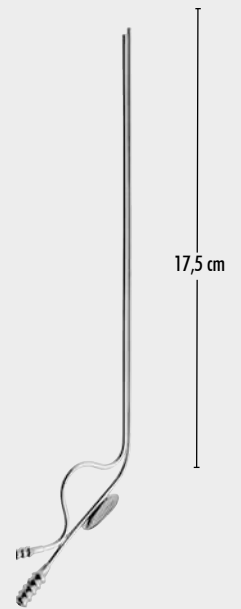

ø mm	FRAZIER
2,5	40-3301-17



mm MEARY INGE 16,0 cm
38 40-3996-16



cm MEARY
26,0 40-3998-26



CLOWARD
40-4001-16

Gehirnventrikel-Punktionskanülen
Ventriculopuncture Cannulae
Aiguilles pour la ponction ventriculaire
Agujas para la punción ventricular
Aghi per la puntura ventricolare

NEUROCHIRURGIE

NEUROSURGERY

NEUROCHIRURGIE

NEUROCIRUGÍA

NEUROCHIRURGIA

Wirbelkörperspreizer
Lamina Spreader
Écarteur pour corps vertébraux
Separador para cuerpos vertebrales
Divaricatore per corpi vertebrali

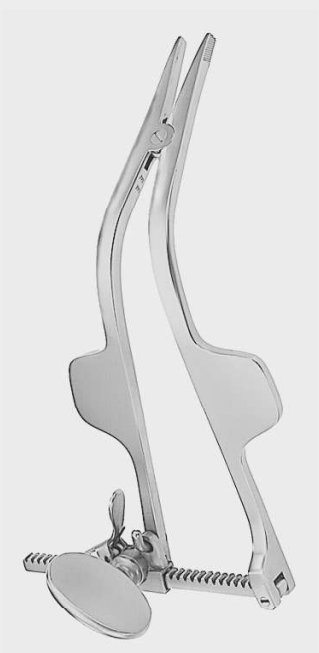

cm CLOWARD
15,0 40-4002-15



cm INGE
17,0 40-4005-17
27,0 40-4005-27

Wirbelkörperspreizer
Lamina Spreaders
Écarteurs pour corps vertébraux
Separadores para cuerpos vertebrales
Divaricatori per corpi vertebrali

Laminektomie-Zangen
 Laminectomy Rongeurs
 Pinces emporte-pièce à laminectomie
 Pinzas cortantes para laminectomía
 Pinze taglianti per laminectomia



NEUROCHIRURGIE

NEUROSURGERY

NEUROCHIRURGIE

NEUROCIURUGÍA

NEUROCHIRURGIA

2 mm CUSHING



	L cm	2 x 10 mm
(CAIRNS)	12,5	40-4200-01
	15,0	40-4201-01
	18,0	40-4202-01

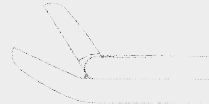

	L cm	2 x 10 mm / 45°
	12,5	40-4200-02
	15,0	40-4201-02
	18,0	40-4202-02



	L cm	2 x 10 mm / 45°
	12,5	40-4200-03
	15,0	40-4201-03
	18,0	40-4202-03

3 mm LOVE-GRUENWALD



	L cm	3 x 10 mm
	12,5	40-4300-01
	15,0	40-4301-01
	18,0	40-4302-01

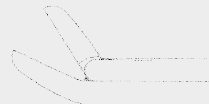

	L cm	3 x 10 mm / 45°
	12,5	40-4300-02
	15,0	40-4301-02
	18,0	40-4302-02



	L cm	3 x 10 mm / 45°
	12,5	40-4300-03
	15,0	40-4301-03
	18,0	40-4302-03

4 mm SPURLING



	L cm	4 x 10 mm
	12,5	40-4400-01
	15,0	40-4401-01
	18,0	40-4402-01



	L cm	4 x 10 mm / 45°
	12,5	40-4400-02
	15,0	40-4401-02
	18,0	40-4402-02



	L cm	4 x 10 mm / 45°
	12,5	40-4400-03
	15,0	40-4401-03
	18,0	40-4402-03

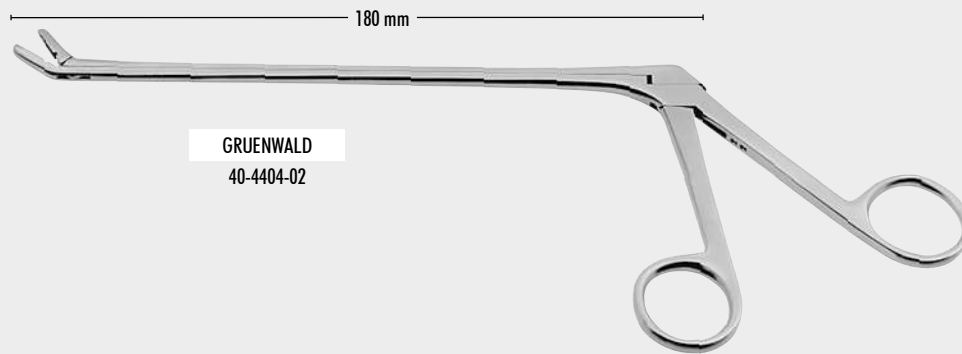

GRUENWALD
40-4404-02

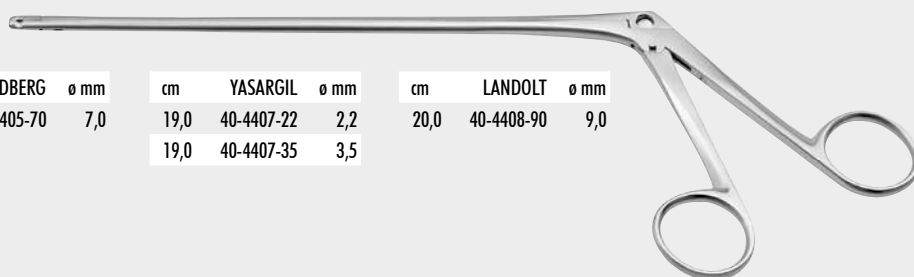

cm	OLDBERG	ø mm	cm	YASARGIL	ø mm	cm	LANDOLT	ø mm
18,0	40-4405-70	7,0	19,0	40-4407-22	2,2	20,0	40-4408-90	9,0
			19,0	40-4407-35	3,5			

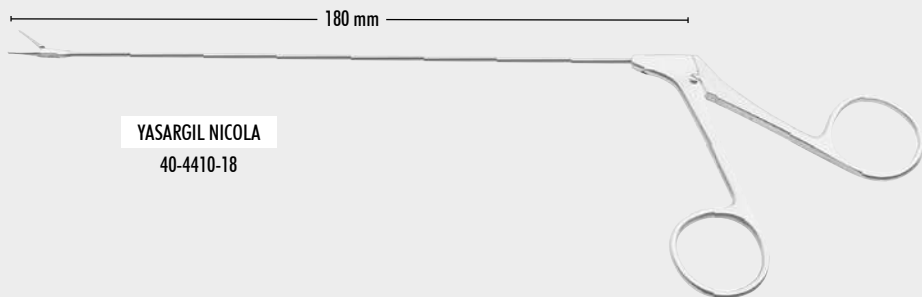

YASARGIL NICOLA
40-4410-18

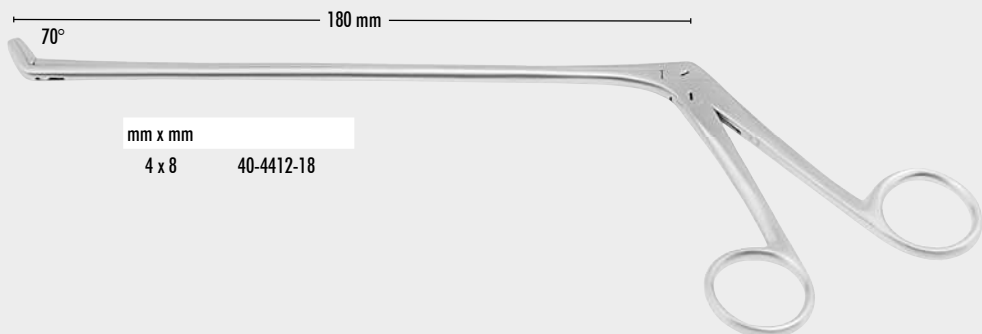

mm x mm
4 x 8 40-4412-18

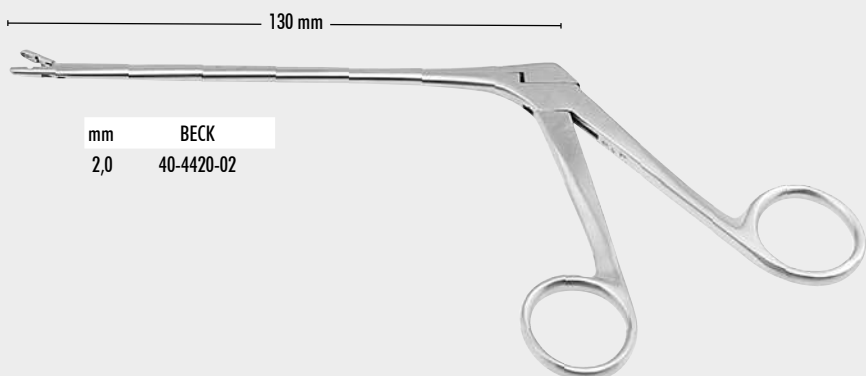

mm **BECK**
2,0 40-4420-02

Laminektomie-Zangen
Laminectomy Rongeurs
Pinces emporte-pièce à laminectomie
Pinzas cortantes para laminectomía
Pinze taglianti per laminectomia

NEUROCHIRURGIE

NEUROSURGERY

NEUROCHIRURGIE

NEUROCIRUGÍA

NEUROCHIRURGIA

Laminektomie-Zangen
Laminectomy Rongeurs
Pincas emporte-pièce à laminectomie
Pinzas cortantes para laminectomía
Pinze taglianti per laminectomia

NEUROCHIRURGIE

NEUROSURGERY

NEUROCHIRURGIE

NEUROCIURUGÍA

NEUROCHIRURGIA

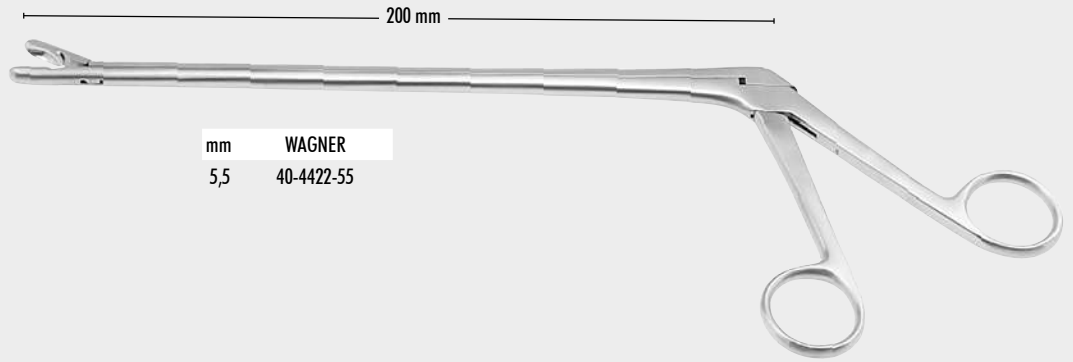

mm	WAGNER
5,5	40-4422-55

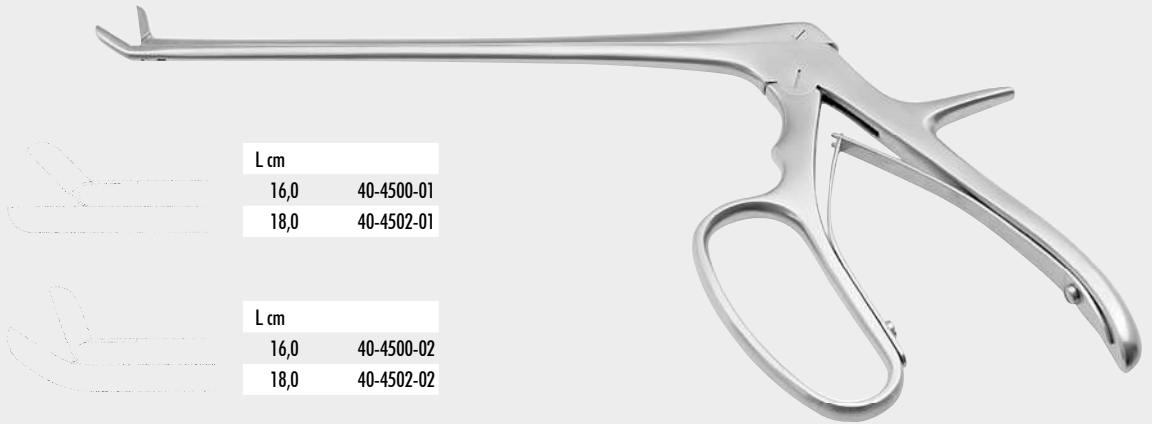

L cm	
16,0	40-4500-01
18,0	40-4502-01

L cm	
16,0	40-4500-02
18,0	40-4502-02



L cm	
16,0	40-4500-03
18,0	40-4502-03

FERRIS-SMITH
40-4500-01 - 40-4502-03
3 x 10 mm

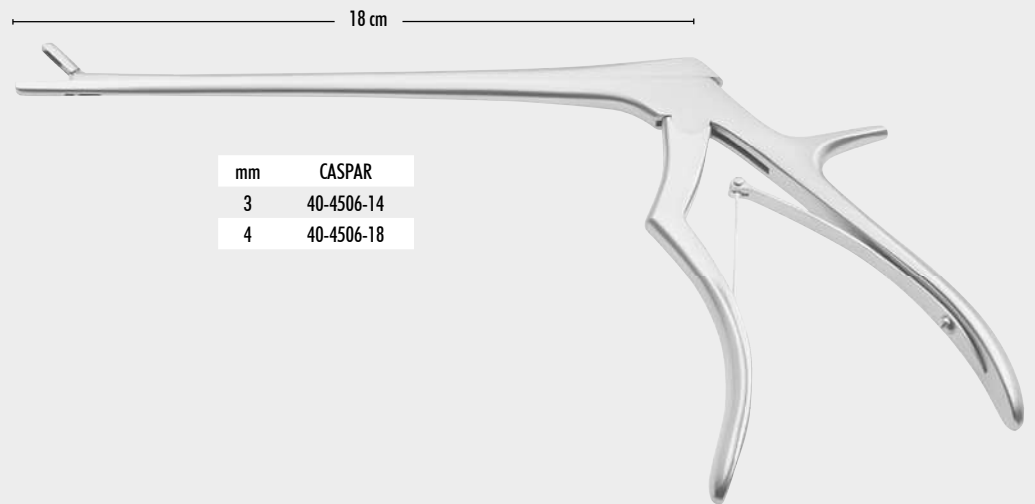

mm	CASPAR
3	40-4506-14
4	40-4506-18

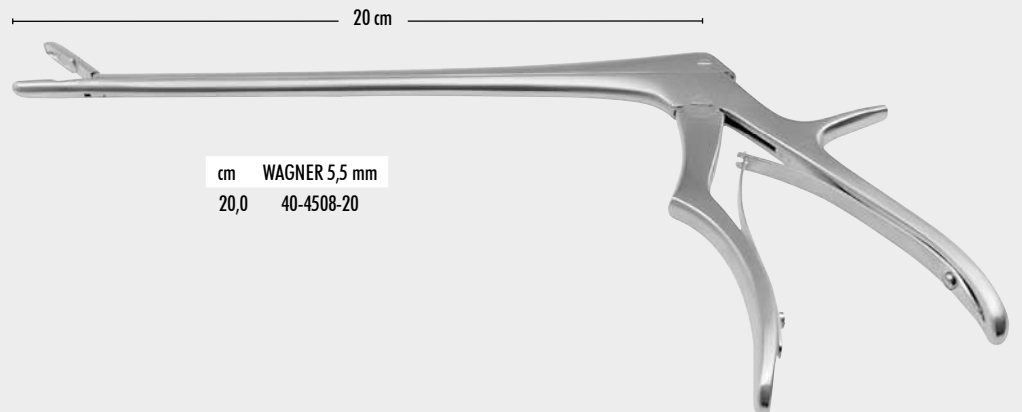

cm	WAGNER 5,5 mm
20,0	40-4508-20



Laminektomie-Zangen
Laminectomy Rongeurs
Pinces emporte-pièce à laminectomie
Pinzas cortantes para laminectomía
Pinze taglianti per laminectomia

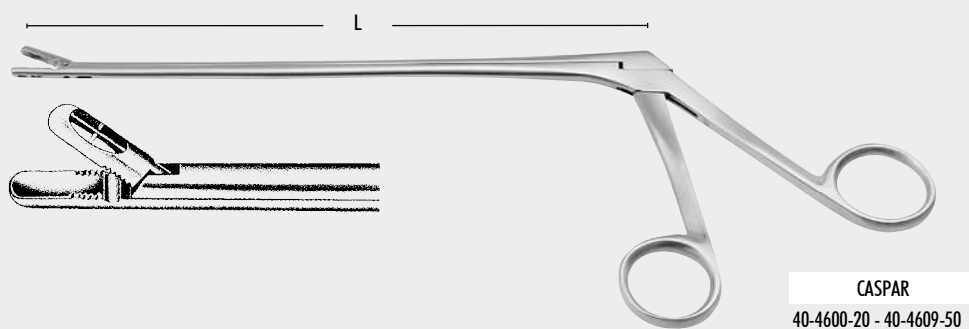

NEUROCHIRURGIE

NEUROSURGERY

NEUROCHIRURGIE

NEUROCIRUGÍA

NEUROCHIRURGIA



CASPAR
2 x 12 mm

L cm			
14,0	40-4600-20	40-4601-20	40-4603-20
16,0	40-4604-20	40-4605-20	40-4607-20
18,5	40-4608-20		



CASPAR
3 x 12 mm

L cm			
14,0	40-4600-30	40-4601-30	40-4603-30
16,0	40-4604-30	40-4605-30	40-4607-30
18,5	40-4608-30	40-4609-30	40-4615-30



CASPAR
4 x 14 mm

L cm			
14,0	40-4600-40	40-4601-40	40-4603-40
16,0	40-4604-40	40-4605-40	40-4607-40
18,5	40-4608-40	40-4609-40	40-4615-40



CASPAR
5 x 14 mm

L cm			
14,0	40-4600-50	40-4601-50	
16,0	40-4604-50	40-4605-50	40-4607-50
18,5	40-4608-50	40-4609-50	40-4615-50



CASPAR
6 x 16 mm

L cm			
14,0	40-4600-60		
16,0	40-4604-60		
18,5	40-4608-60		

Laminektomie-Zangen
 Laminectomy Rongeurs
 Pincas emporte-pièce à laminectomie
 Pinzas cortantes para laminectomía
 Pinze taglianti per laminectomia



cm CASPAR
 15,5 40-4700-02 - 40-4703-04

NEUROCHIRURGIE

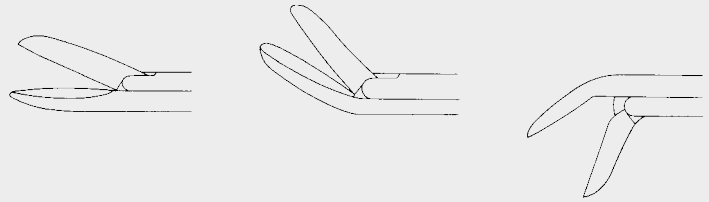

NEUROSURGERY



CASPAR
 2 mm

L cm	40-4700-02	40-4701-02	40-4703-02
15,5			

NEUROCHIRURGIE



CASPAR
 3 mm

L cm	40-4700-03	40-4701-03	40-4703-03
15,5			

NEUROCIURUGÍA

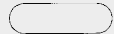

CASPAR
 4 mm

L cm	40-4700-04	40-4701-04	40-4703-04
15,5			

NEUROCHIRURGIA

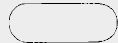

CASPAR
 5 mm

L cm	40-4700-05
15,5	



cm	FERRIS-SMITH-KERRISON
18,0	40-5100-01 - 40-5100-06
20,0	40-5110-01 - 40-5110-06
23,0	40-5120-01 - 40-5120-06
25,0	40-5130-01 - 40-5130-06
27,0	40-5140-01 - 40-5140-06

Bandscheiben-Stanzen
 Intervertebral Disc Rongeurs
 Pincas emporte-pièce pour lames intervertébrales
 Pinzas sacabocado para discos
 Pinze taglienti per laminectomia

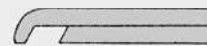

cm	mm
18,0	40-5100-01 1
20,0	40-5110-01 1
23,0	40-5120-01 1
25,0	40-5130-01 1
27,0	40-5140-01 1

cm	mm
18,0	40-5101-01 1
20,0	40-5111-01 1
23,0	40-5121-01 1
25,0	40-5131-01 1
27,0	40-5141-01 1

cm	mm
18,0	40-5102-01 1
20,0	40-5112-01 1
23,0	40-5122-01 1
25,0	40-5132-01 1
27,0	40-5142-01 1

cm	mm
18,0	40-5103-01 1
20,0	40-5113-01 1
23,0	40-5123-01 1
25,0	40-5133-01 1
27,0	40-5143-01 1

NEUROCHIRURGIE

NEUROSURGERY

NEUROCHIRURGIE

NEUROCIROGÍA

NEUROCHIRURGIA

cm	mm
18,0	40-5100-02 2
20,0	40-5110-02 2
23,0	40-5120-02 2
25,0	40-5130-02 2
27,0	40-5140-02 2

cm	mm
18,0	40-5101-02 2
20,0	40-5111-02 2
23,0	40-5121-02 2
25,0	40-5131-02 2
27,0	40-5141-02 2

cm	mm
18,0	40-5102-02 2
20,0	40-5112-02 2
23,0	40-5122-02 2
25,0	40-5132-02 2
27,0	40-5142-02 2

cm	mm
18,0	40-5103-02 2
20,0	40-5113-02 2
23,0	40-5123-02 2
25,0	40-5133-02 2
27,0	40-5143-02 2

cm	mm
18,0	40-5100-03 3
20,0	40-5110-03 3
23,0	40-5120-03 3
25,0	40-5130-03 3
27,0	40-5140-03 3

cm	mm
18,0	40-5101-03 3
20,0	40-5111-03 3
23,0	40-5121-03 3
25,0	40-5131-03 3
27,0	40-5141-03 3

cm	mm
18,0	40-5102-03 3
20,0	40-5112-03 3
23,0	40-5122-03 3
25,0	40-5132-03 3
27,0	40-5142-03 3

cm	mm
18,0	40-5103-03 3
20,0	40-5113-03 3
23,0	40-5123-03 3
25,0	40-5133-03 3
27,0	40-5143-03 3

cm	mm
18,0	40-5100-04 4
20,0	40-5110-04 4
23,0	40-5120-04 4
25,0	40-5130-04 4
27,0	40-5140-04 4

cm	mm
18,0	40-5101-04 4
20,0	40-5111-04 4
23,0	40-5121-04 4
25,0	40-5131-04 4
27,0	40-5141-04 4

cm	mm
18,0	40-5102-04 4
20,0	40-5112-04 4
23,0	40-5122-04 4
25,0	40-5132-04 4
27,0	40-5142-04 4

cm	mm
18,0	40-5103-04 4
20,0	40-5113-04 4
23,0	40-5123-04 4
25,0	40-5133-04 4
27,0	40-5143-04 4

cm	mm
18,0	40-5100-05 5
20,0	40-5110-05 5
23,0	40-5120-05 5
25,0	40-5130-05 5
27,0	40-5140-05 5

cm	mm
18,0	40-5101-05 5
20,0	40-5111-05 5
23,0	40-5121-05 5
25,0	40-5131-05 5
27,0	40-5141-05 5

cm	mm
18,0	40-5102-05 5
20,0	40-5112-05 5
23,0	40-5122-05 5
25,0	40-5132-05 5
27,0	40-5142-05 5

cm	mm
18,0	40-5103-05 5
20,0	40-5113-05 5
23,0	40-5123-05 5
25,0	40-5133-05 5
27,0	40-5143-05 5

cm	mm
18,0	40-5100-06 6
20,0	40-5110-06 6
23,0	40-5120-06 6
25,0	40-5130-06 6
27,0	40-5140-06 6

cm	mm
18,0	40-5101-06 6
20,0	40-5111-06 6
23,0	40-5121-06 6
25,0	40-5131-06 6
27,0	40-5141-06 6

cm	mm
18,0	40-5102-06 6
20,0	40-5112-06 6
23,0	40-5122-06 6
25,0	40-5132-06 6
27,0	40-5142-06 6

cm	mm
18,0	40-5103-06 6
20,0	40-5113-06 6
23,0	40-5123-06 6
25,0	40-5133-06 6
27,0	40-5143-06 6



Bandscheiben-Stanzen
 Intervertebral Disc Rongeurs
 Pincas emporte-pièce pour
 lames intervertébrales
 Pinzas sacabocado para
 discos intervertebrales
 Pinze taglienti per
 dischi intervertebrali

NEUROCHIRURGIE

NEUROSURGERY

NEUROCHIRURGIE

NEUROCIRUGÍA

NEUROCHIRURGIA



COLCLOUGH
 40-5200-03 - 40-5205-05



L cm	3 mm
15,0	40-5200-03
20,0	40-5202-03



L cm	5 mm
15,0	40-5200-05
20,0	40-5202-05



L cm	3 mm
15,0	40-5204-03
20,0	40-5206-03



L cm	5 mm
15,0	40-5204-05
20,0	40-5206-05



L cm	3 mm
15,0	40-5207-03
20,0	40-5209-03



L cm	5 mm
15,0	40-5207-05
20,0	40-5209-05

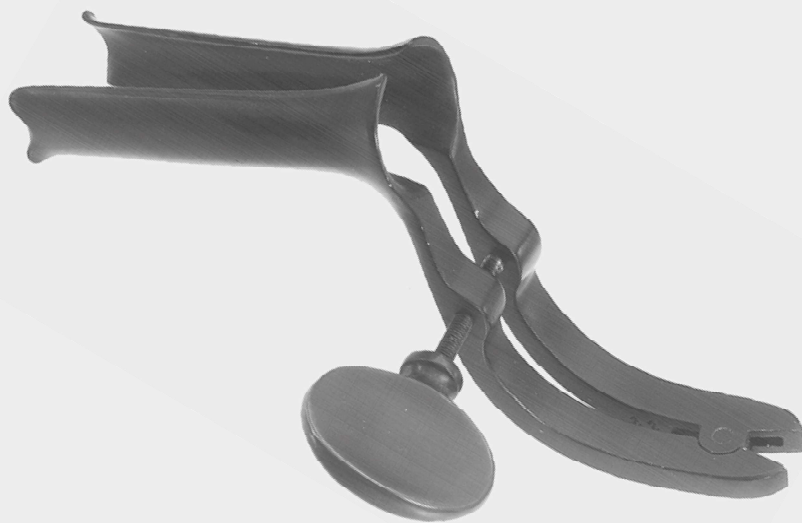

mm	CUSHING LANDOLT
70 x 15	40-8001-70
90 x 15	40-8001-90
110 x 15	40-8002-10

Spekula für transsphenoïdale
Hypophysektomie
Specula for transsphenoïdal
Hypophysectomy
Spécuments pour la hypophysectomie
transsphénoïdale
Espéculos para la hipofisectomia
trans-esfenoidal
Specoli per la ipofisectomia
trans-sfenoidale

NEUROCHIRURGIE

NEUROSURGERY

NEUROCHIRURGIE

NEUROCIRUGÍA

NEUROCHIRURGIA

Spreizzange für Spekula
Spreading Forceps for Specula
Pince à écarter les spéculums
Pinza para abrir espéculos
Pinza per aprire specoli

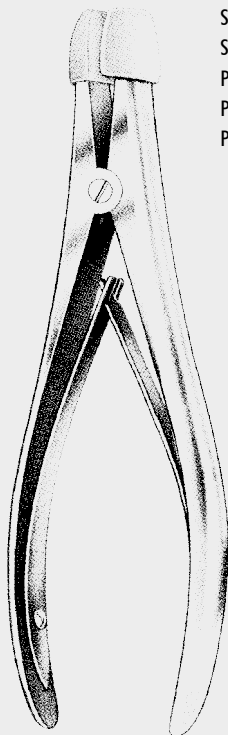

cm	LANDOLT
21,0	40-8004-21



mm	PAPAVERO CASPAR
80 x 11	40-8007-80
90 x 13	40-8007-90
100 x 15	40-8008-00



Hypophysektomie-Instrumente
 Pituitary Instruments
 Instruments pour la hypophysectomie
 Instrumentos para hipofisectomía
 Strumenti per ipofisectomia

NEUROCHIRURGIE

NEUROSURGERY

NEUROCHIRURGIE

NEUROCIRUGÍA

NEUROCHIRURGIA

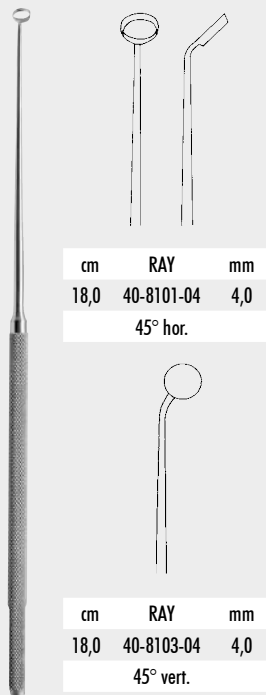

cm	RAY	mm
18,0	40-8101-04	4,0
45° hor.		

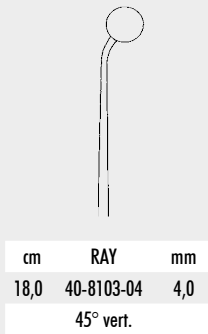

cm	RAY	mm
18,0	40-8103-04	4,0
45° vert.		

RAY
 40-8101-04 - 40-8103-04

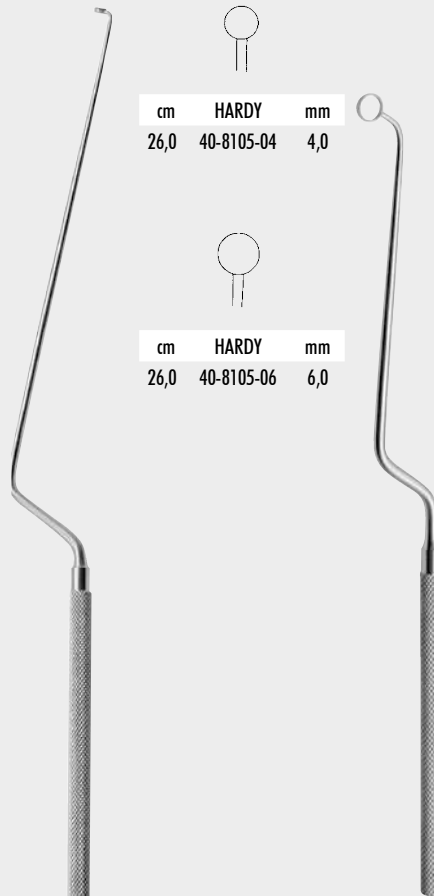

cm	HARDY	mm
26,0	40-8105-04	4,0

cm	HARDY	mm
26,0	40-8105-06	6,0

HARDY
 40-8105-04 - 40-8105-06



cm	NICOLA	mm
21,5	40-8107-65	6,5

cm	NICOLA	mm
21,5	40-8109-65	6,5

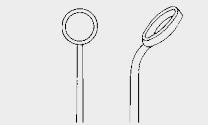

cm	NICOLA	mm
21,5	40-8201-65	6,5

NICOLA
 40-8107-65 - 40-8203-00

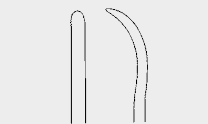

cm	NICOLA
21,5	40-8203-00

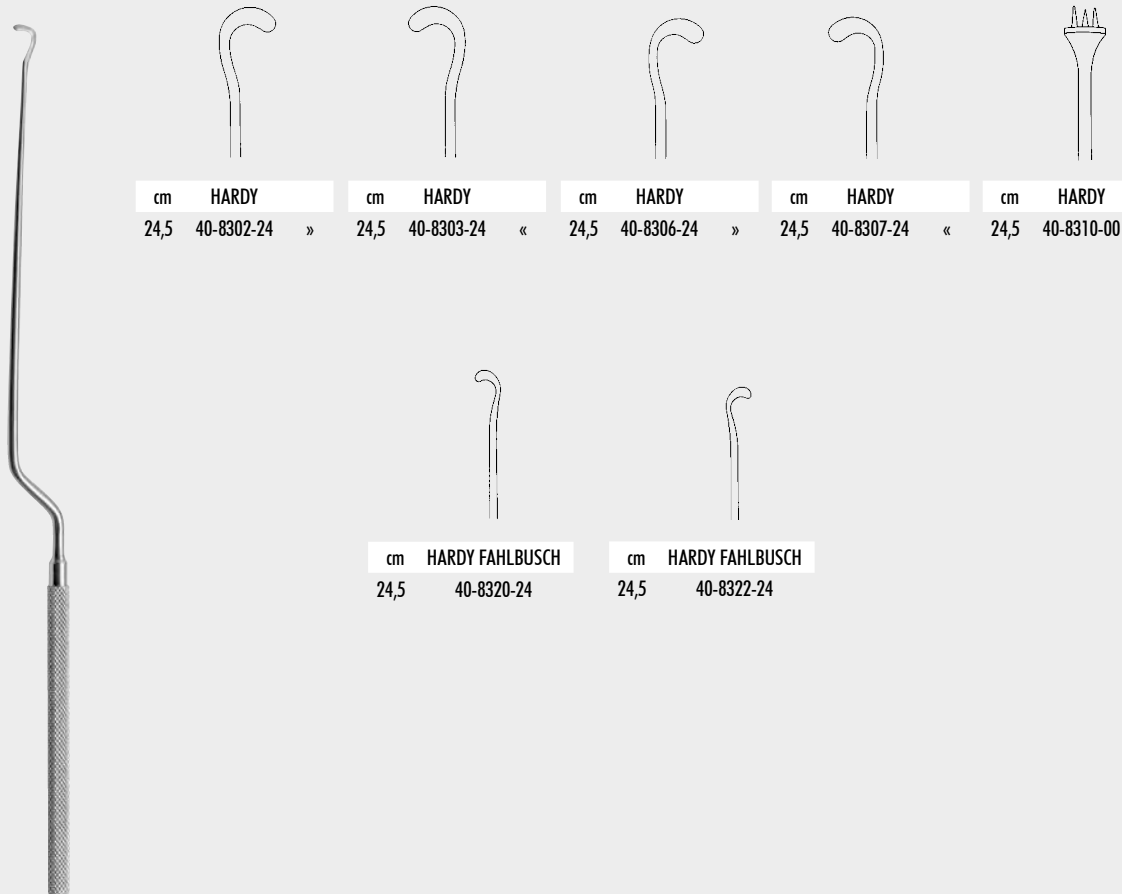

cm	HARDY
24,5	40-8302-24 »

cm	HARDY
24,5	40-8303-24 «

cm	HARDY
24,5	40-8306-24 »

cm	HARDY
24,5	40-8307-24 «

cm	HARDY
24,5	40-8310-00

cm	HARDY FAHLBUSCH
24,5	40-8320-24

cm	HARDY FAHLBUSCH
24,5	40-8322-24

40-8302-24 - 40-8322-24
 24,5 cm

Hypophysektomie-Instrumente
 Pituitary Instruments
 Instruments pour la hypophysectomie
 Instrumentos para hipofisectomía
 Strumenti per ipofisectomia

NEUROCHIRURGIE

NEUROSURGERY

NEUROCHIRURGIE

NEUROCIRUGÍA

NEUROCHIRURGIA

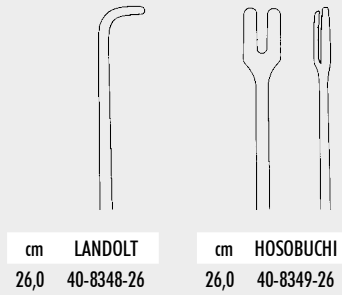
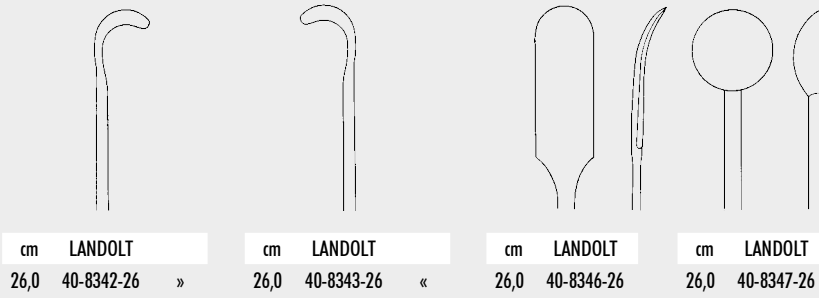

40-8342-26 - 40-8349-26
 26,0 cm

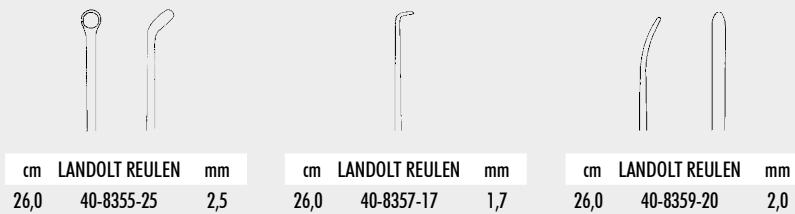
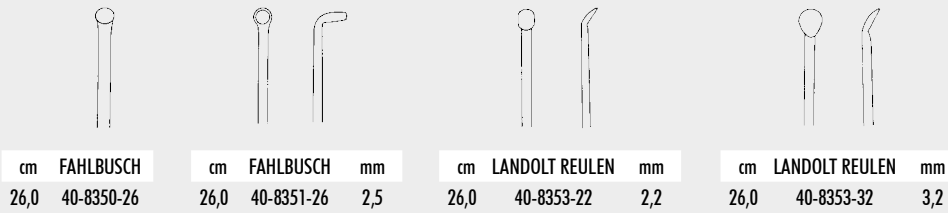

40-8350-26 - 40-8359-20
 26,0 cm



Hypophysektomie-Instrumente
 Pituitary Instruments
 Instruments pour la hypophysectomie
 Instrumentos para la hipofisectomía
 Strumenti per ipofisectomia

NEUROCHIRURGIE

NEUROSURGERY

NEUROCHIRURGIE

NEUROCIRUGÍA

NEUROCHIRURGIA



cm CASPAR
24,5 40-8365-01



cm CASPAR
24,5 40-8365-02



cm CASPAR
24,5 40-8365-03



cm CASPAR
24,5 40-8365-05



CASPAR 24,5 cm
40-8365-01 - 40-8365-05



cm YASARGIL
18,5 40-8371-01



cm YASARGIL
18,5 40-8371-02



cm YASARGIL
18,5 40-8371-03



cm YASARGIL
18,5 40-8371-04



cm KRAYENBÜHL
18,5 40-8373-01



cm KRAYENBÜHL
18,5 40-8373-02



cm KRAYENBÜHL
18,5 40-8373-03



cm KRAYENBÜHL
18,5 40-8373-04

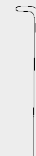

40-8371-01 - 40-8373-04
18,5 cm



Hypophysektomie-Instrumente
 Pituitary Instruments
 Instruments pour la hypophysectomie
 Instrumentos para hipofisectomía
 Strumenti per ipofisectomia



cm
23,5 40-8375-01



cm YASARGIL
18,5 40-8375-02

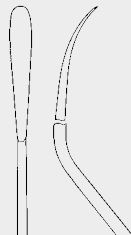

cm YASARGIL
18,5 40-8375-03

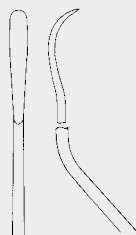

cm YASARGIL
18,5 40-8375-04

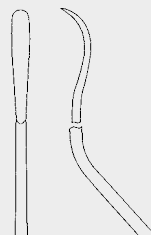

40-8375-01- 40-7375-04

NEUROCHIRURGIE

NEUROSURGERY

NEUROCHIRURGIE

NEUROCIRUGÍA



cm YASARGIL
18,5 40-8377-01



cm YASARGIL
18,5 40-8377-02



cm YASARGIL
18,5 40-8377-03

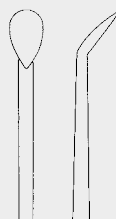

cm YASARGIL
18,5 40-8377-04

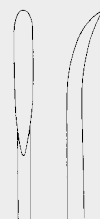

cm YASARGIL
18,5 40-8377-05



cm YASARGIL
18,5 40-8377-06

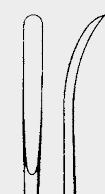

cm
23,0 40-8377-07



cm
23,0 40-8377-08

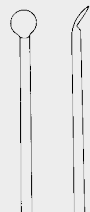

cm JACOBSON
19,0 40-8379-19



cm JACOBSON
19,0 40-8380-19



YASARGIL
40-8377-01- 40-7377-08

Hypophysektomie-Instrumente
 Pituitary Instruments
 Instruments pour la hypophysectomie
 Instrumentos para hipofisectomía
 Strumenti per ipofisectomia



cm
 23,0 40-8385-23



cm
 23,0 40-8386-23

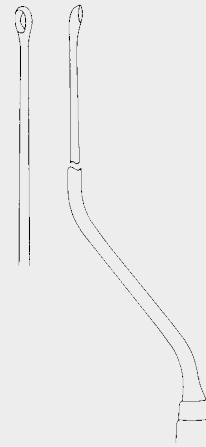

cm YASARGIL
 18,5 40-8387-18

40-8385-23- 40-8387-18

NEUROCHIRURGIE

NEUROSURGERY

NEUROCHIRURGIE

NEUROCIURGÍA

NEUROCHIRURGIA

Hypophysen-Küretten
 Pituitary Curettes
 Curettes pituitaires
 Curetas pituitarias
 Curette pituitarie



cm	RAY	RAY	RAY	RAY
19,0	40-8390-45	40-8390-90	40-8391-45	40-8391-90
	4 mm	4 mm	4 mm	4 mm
	45°	90°	45°	90°

Gefäß-Messer
 Vessel Knives
 Bistouris vasculaires
 Cuchillos vasculares
 Coltelli vascolari

NEUROCHIRURGIE

NEUROSURGERY

NEUROCHIRURGIE

NEUROCIRUGÍA

NEUROCHIRURGIA

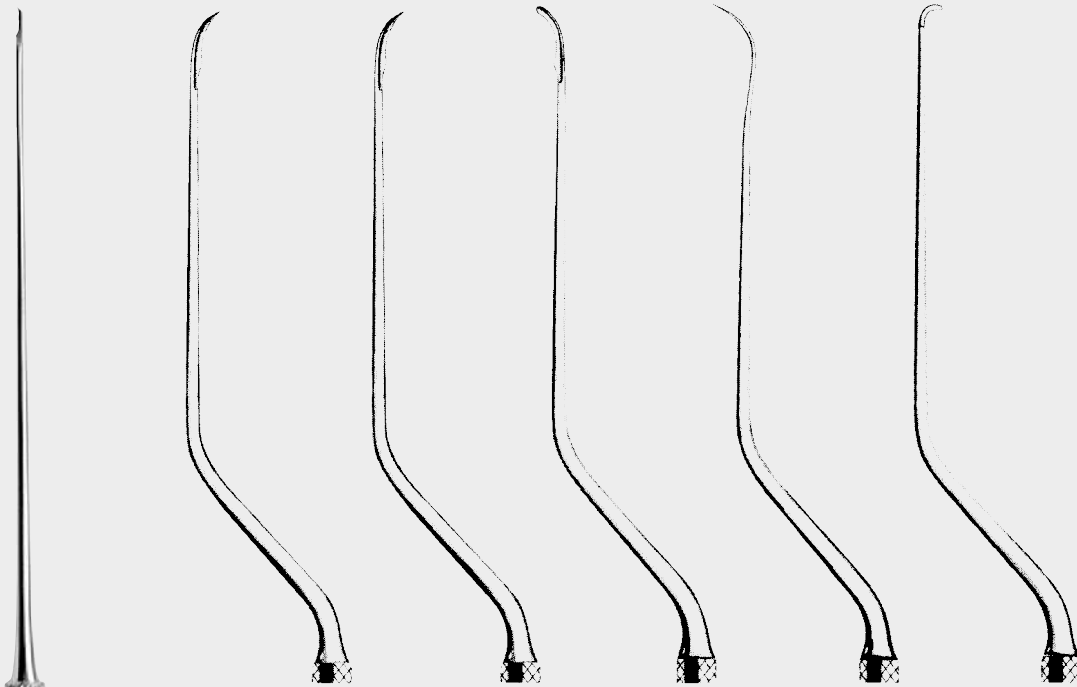

cm	KOOS	KOOS	KOOS	KRAUS	YASARGIL
19,0	40-8411-19	40-8413-19	40-8415-19	40-8417-19	40-8419-19



cm JACOBSON
 19,0 40-8410-19



NEUROCHIRURGIE

NEUROSURGERY

NEUROCHIRURGIE

NEUROCIRUGÍA

NEUROCHIRURGIA



OPHTHALMOLOGIE

OPHTHALMOLOGY

OPHTALMOLOGIE

OFTALMOLOGÍA

OFTALMOLOGIA

Sperrelevatoren
Eye Specula
Blépharostats
Blefarostatos
Blefarostati



cm	BARRAQUER (COLIBRI)
3,0	42-1001-03
4,0	42-1001-04



cm	BARRAQUER modif.
4,0	42-1002-04



cm	SAUER
3,0	42-1003-03



cm	BOWMAN
7,0	42-1004-07



cm	CRITCHETT
7,0	42-1005-06



cm	SMITH
5,0	42-1006-05

OPHTHALMOLOGIE

OPHTHALMOLOGY

OPHTHALMOLOGIE

OFTALMOLOGÍA

OFTALMOLOGIA



cm	CLARK
8,0	42-1007-08



cm	GRAEFE
7,0	42-1009-06
9,0	42-1009-09



cm	WEEK
8,0	42-1100-08

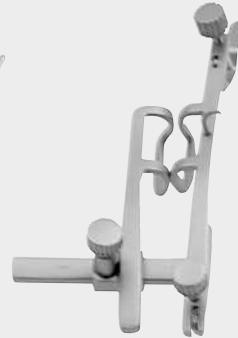

cm	ARRUGA »
7,0	42-1101-07



cm	ARRUGA «
7,0	42-1103-07



cm	MURDOCK
5,0	42-1105-05

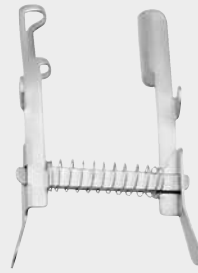

cm	MELLINGER-AXENFELD
7,0	42-1201-07



cm	MELLINGER-AXENFELD
7,0	42-1203-07



cm	MELLINGER
5,0	42-1205-05
7,0	42-1205-07

Sperrelevatoren
Eye Specula
Blépharostats
Blefarostatos
Blefarostati



cm LISTER-BURCH
8,0 42-1207-08



cm WILLIAMS
7,0 42-1208-07
8,0 42-1208-08



cm LANCASTER
7,0 42-1209-07



cm PLEY
6,0 42-1211-06



cm ZIEGLER
7,0 42-1300-07



cm CASTROVIEJO
8,0 42-1302-08



cm PARK
8,0 42-1303-08



cm MUELLER
7,0 42-1305-07



cm GOLDSTEIN
3,0 42-1307-03



cm STEVENSON
7,0 42-1309-07

OPHTHALMOLOGIE

OPHTHALMOLOGY

OPHTHALMOLOGIE

OFTALMOLOGÍA

OFTALMOLOGIA



cm WEISS
7,0 42-1315-07
9,0 42-1315-09



cm WEISS
7,0 42-1317-07
9,0 42-1317-09



cm WEISS
8,0 42-1319-08



cm JAEGER
11,0 42-1500-11

Lidplatte
Suturing Speculum
Plaque à paupières
Placa para párpados
Placca per palpebbre

Starmesser
 Cataract Knives
 Bistouris à cataracte
 Bisturías para catarata
 Bisturi per cataratta



GRAEFE
 42-1700-00 - 42-1700-03



42-1700-00
 Fig. 0



42-1700-01
 Fig. 1



42-1700-02
 Fig. 2



42-1700-03
 Fig. 3



cm DEUTSCHMANN
 13,0 42-1702-13

OPHTHALMOLOGIE

OPHTHALMOLOGY

OPHTHALMOLOGIE

OFTALMOLOGÍA

OFTALMOLOGIA



42-1800-01 - 42-1801-03



JAEGER
 42-1800-01 42-1800-02 42-1800-03
 Fig. 1 Fig. 2 Fig. 3



JAEGER 45°
 42-1801-01 42-1801-02 42-1801-03
 Fig. 1 Fig. 2 Fig. 3



Lanzenmesser (Keratome)
 Keratomes
 Bistouris lanceolaires (Kératomes)
 Cuchillos lanceolares (Querátomos)
 Coltelli lanceolari (Cheratotomi)



cm BERENS
 13,0 42-1803-13



cm CASTROVIEJO
 13,0 42-1805-13
 4 x 13 mm



cm GRAEFE
 13,0 42-1807-13

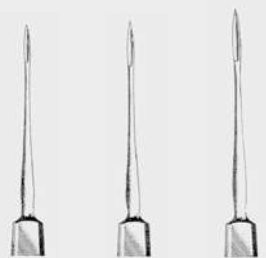

KNAPP		
42-2002-01	42-2002-02	42-2002-03
Fig. 1	Fig. 2	Fig. 3



ZIEGLER		
42-2100-01	42-2100-02	42-2100-03
Fig. 1	Fig. 2	Fig. 3
5 mm	6 mm	7 mm



cm	DEAN
12,5	42-2103-12

Verschiedene Augenmesser
Various Eye Knives
Couteaux oculaires divers
Cuchillos oculares varios
Coltelli per oculistica vari

OPHTHALMOLOGIE

OPHTHALMOLOGY

OPHTHALMOLOGIE

OFTALMOLOGÍA

OFTALMOLOGIA

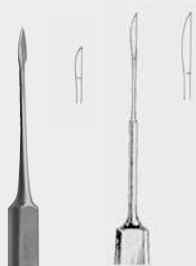

cm	BOWMAN	
13,0	42-2104-04	42-2104-08
	0,4 mm	0,8 mm

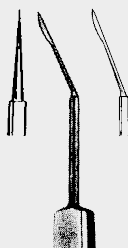

cm	BOWMAN
13,0	42-2105-13

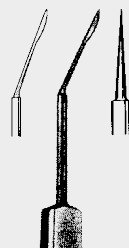

cm	BOWMAN
13,0	42-2107-13



cm	WHEELER
12,0	42-2108-12

Verschiedene Augeninstrumente
Various Ophthalmic Instruments
Instruments divers oculaires
Instrumentos varios para oftalmología
Strumenti vari per oftalmologia



cm	ZIEGLER
11,0	42-2201-11
	3,5 mm



cm	SATO
12,5	42-2206-12



cm	TOOK
12,0	42-2208-12



cm	GILL
12,0	42-2301-12



cm	ELSCHMIG
13,0	42-2303-13

Verschiedene Augeninstrumente
 Various Ophthalmic Instruments
 Instruments oculaires divers
 Instrumentos varios de oftalmología
 Strumenti oculistici vari



OPHTHALMOLOGIE

OPHTHALMOLOGY

OPHTHALMOLOGIE



OFTALMOLOGÍA

OFTALMOLOGIA

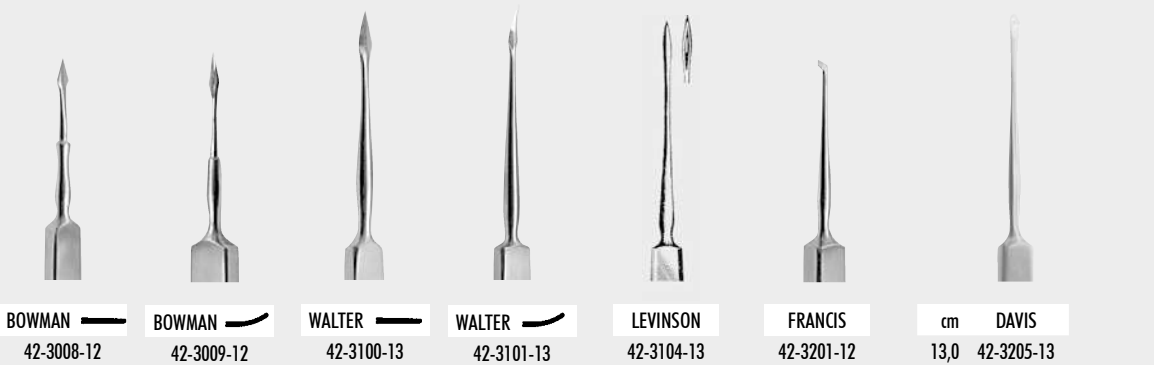

Fremdkörper-Instrumente,
 Hornhaut-Dissektor, Extirpations-Meissel
 Foreign Body Instruments, Corneal
 Dissector, Extirpation chisel
 Instruments à corps étrangers, dissecteur
 cornéen, ciseaux à extirpation
 Instrumentos para cuerpos extraños,
 disecador corneal, cincel de extirpación
 Strumenti per corpi estranei, scollatore
 corneale, scalpelli per estirpazione



Titanium
Titanium
Titane
Titanio



GRAEFE
42-3501-01 42-3501-02 42-3501-03
42-3502-01 42-3502-02 42-3502-03
Fig. 1 Fig. 2 Fig. 3

JAMESON
42-3503-13

GREEN
42-3505-13

cm **STEVENS**
12,0 42-3506-12

STEVENS
42-3507-13

cm **GRAEFE**
13,0 42-3508-13

ARRUGA
42-3603-01 42-3603-02
Fig. 1 Fig. 2

Schiel-, Muskel-, Linsen-, Extraktionshaken, Iris-, Wundhäkchen, Cystotome Muskel, Lens, and Extraction Hooks, Iris and Delicate Retractors, Cystotomes Crochets à strabisme, musculaires, pour le cristallin, à extraction et à iris, Kystotomes Ganchos para estrabismo, musculares, para el cristalino y de extracción, Ganchitos para iris y ganchitos finos Uncini per strabismo, muscolari, per cristallino e per estrazione, divaricatori per iride e fini, Cistotomi

OPHTHALMOLOGIE

OPHTHALMOLOGY

OPHTHALMOLOGIE

OFTALMOLOGÍA

OFTALMOLOGIA

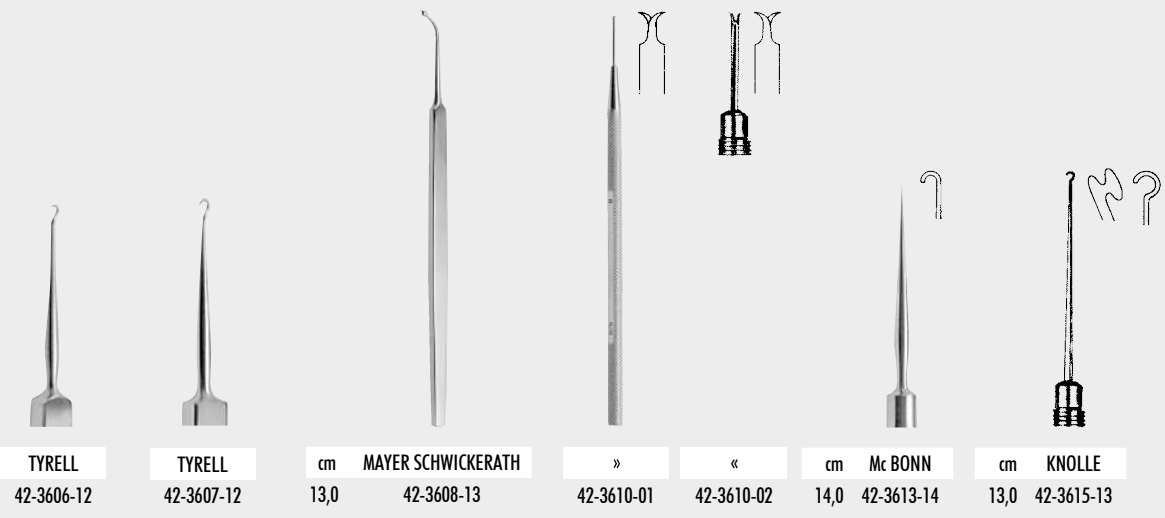

TYRELL
42-3606-12

TYRELL
42-3607-12

cm **MAYER SCHWICKERATH**
13,0 42-3608-13

» 42-3610-01

« 42-3610-02

cm **Mc BONN**
14,0 42-3613-14

cm **KNOLLE**
13,0 42-3615-13



cm **HIRSCHMANN**
13,0 42-3619-13

cm **Mc GANNAN**
13,0 42-3622-13

cm **GUTHRIE**
12,0 42-3624-12

cm **GUTHRIE**
13,0 42-3626-13

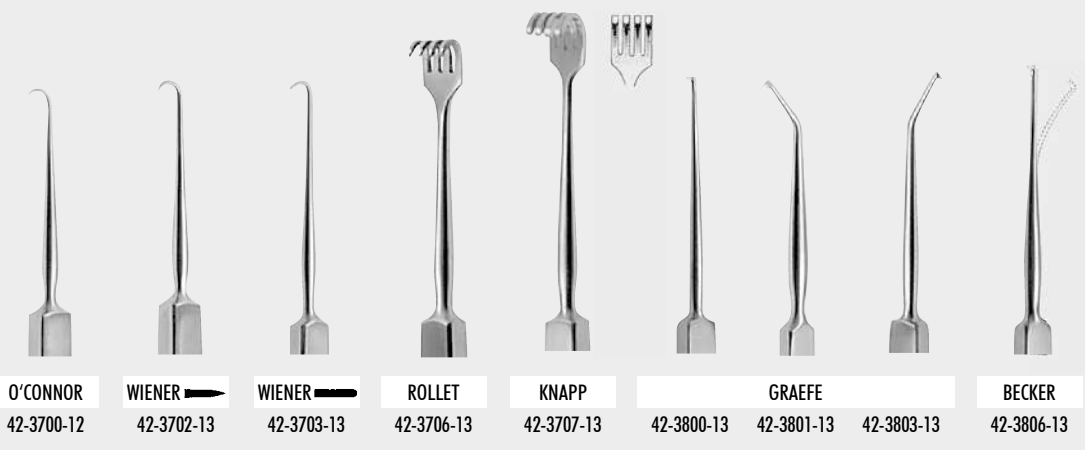

O'CONNOR
42-3700-12

WIENER
42-3702-13

WIENER
42-3703-13

ROLLET
42-3706-13

KNAPP
42-3707-13

42-3800-13

GRAEFE
42-3801-13 42-3803-13

BECKER
42-3806-13





Chalazions-Löffel
 Chalazion Scoops
 Cuillères à chalazion
 Cucharillas para chalazión
 Cucchiari per calazio

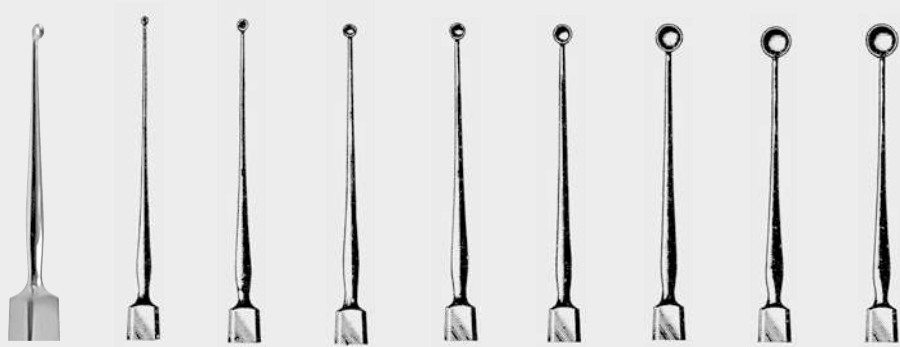

MEYERHOEFER									
	42-4002-05	42-4002-10	42-4002-15	42-4002-18	42-4002-20	42-4002-25	42-4002-35	42-4002-40	42-4002-45
ø mm	0,5	1,0	1,5	1,8	2,0	2,5	3,5	4,0	4,5

OPHTHALMOLOGIE

OPHTHALMOLOGY

OPHTHALMOLOGIE

OFTALMOLOGÍA

OFTALMOLOGIA

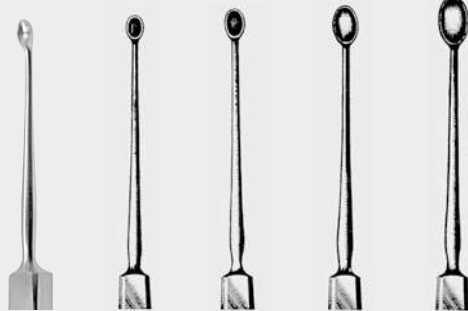

HEBRA					
	42-4004-10	42-4004-20	42-4004-25	42-4004-30	42-4004-35
ø mm	1,0	2,0	2,5	3,0	3,5

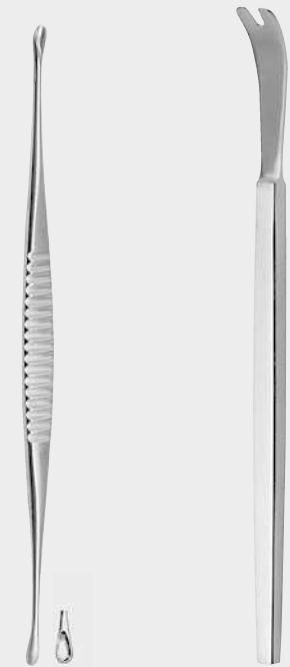

cm AXENFELD
13,0 42-4007-13

cm SCHEPENS
14,5 42-4009-14

Star-, Exenterations-Löffel
 Cataract and Exenteration Scoops
 Cuillères à cataracte et à exentération
 Cucharillas para catarata y exentención
 Cucchiari per cataratta e palpebre



GRAEFE
42-4100-01 42-4100-02

DAVIEL
42-4102-01 42-4102-02

KNAPP
42-4104-02

BUNGE
42-4200-01 42-4200-02 42-4200-03





LANG
42-4204-13



WEBER
42-4401-01 42-4401-02
Fig. 1 Fig. 2



SNELLEN
42-4403-13



WILDER
42-4405-13 42-4407-13
Fig. 1 Fig. 2



ARLT
42-4409-01 42-4409-02

Tränensack-Dissektor, Drahtschlingen
Lachrymal Sac Dissector, Wire Loops
Dissecteur à sac lacrymal, Anses
Disecador para saco lacrimal, Asas
Dissettore per sacco lacrimale, Anse

Iris-Spatel - Iris Spatula - Spatules à iris -
Espátulas para iris - Spatole per iride

Enukleationslöffel - Enucleation
Scoop - Cuillère à énucléation -
Cucharilla de enucleación -
Cucchiaio per enucleazione

Wundlöffel - Protectors
Protecteurs - Protectores -
Protettori

Kauter - Cautery
Cautère - Cauterio



WECKER
42-4601-13 42-4602-13



CULLER
42-4607-13



WELLS
42-4802-20



ARRUGA
42-4805-13



ARRUGA
42-4806-13

isoliert
insulated
isolé
aislado
isolato



WADSWORTH-TODD
42-4807-14

OPHTHALMOLOGIE

OPHTHALMOLOGY

OPHTALMOLOGIE

OFTALMOLOGÍA

OFTALMOLOGIA

Zyklodialyse-Spatel
Cyclodialysis Spatula
Spatules à cyclodialyse
Espátulas para ciclodialísi
Spatole per ciclodialisi



BANGERTER
42-5001-06 42-5001-10 42-5001-12
6 mm 10 mm 12 mm

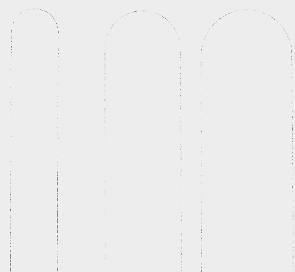

42-5101-13 - 42-5107-09



CASTROVIEJO
42-5101-13 42-5103-14
1,2 x 10 mm 1,5 x 15 mm



ELSCHING
42-5105-14
1,2 x 12 mm



CASTROVIEJO
42-5107-09
0,8 x 15 mm

Zyklodialyse-Spatel
 Cyclodialysis Spatula
 Spatules à cyclodialyse
 Espátulas para ciclodíalisis
 Spatole per ciclodialisi

OPHTHALMOLOGIE

OPHTHALMOLOGY

OPHTHALMOLOGIE

OFTALMOLOGÍA

OFTALMOLOGIA



HIRSCHMANN
42-5111-14



CASTROVIEJO
42-5201-12



WHEELER
42-5203-12



mm	CASTROVIEJO
0,5	42-5205-05
0,75	42-5205-07
1,0	42-5205-10

Fremdkörper-Instrumente
 Foreign Body Instruments
 Instruments à corps étrangers
 Instrumentos para cuerpos extraños
 Strumenti per corpi estranei



DIX
42-5402-12



DIX
42-5404-12



DIX
42-5406-13



DIX
42-5408-13



CASTROVIEJO
42-5802-07



CASTROVIEJO
42-5803-07
0-20 mm



CASTROVIEJO-SCHACHAR
42-5805-07

Markier-Instrumente
Markers
Marqueurs
Marcadores
Marcatori

OPHTHALMOLOGIE

OPHTHALMOLOGY

OPHTHALMOLOGIE

OFTALMOLOGÍA

OFTALMOLOGIA

Kapselsauger - Erisophake -
Aspirateur capsulaire -
Aspirador capsular -
Aspiratore capsulare



cm DASTOOR
6,0 42-5900-06

Kapselstanze - Corneoscleral
Punch - Pince emporte-pièce
pour capsulo-iridotomie - Pinza
sacabocado para capsulotomía -
Pinza tagliente per capsulo-
iridectomia



HOLTH
42-5903-09

Tränenang-Dilatatoren
Lachrymal Dilators
Dilatateurs pour le canal lacrymal
Dilatadores para el canal lacrimal
Dilatatori per il canale lacrimale

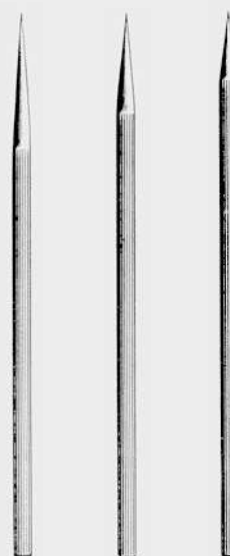

WILDER
42-6002-01 42-6002-02 42-6002-03

Tränenang-Dilatatoren,
Tränenkanal Sonden, Trabekular Sonden
Lachrymal Dilators,
Lachrymal Probes, Trabeculotomy Probes
Dilatateurs pour le canal lacrymal,
Stylets pour le canal lacrymal, Sondes trabécul
Dilatadores para canal lacrimal
Estiletos para canal lacrimal, Sondas trabecula
Dilatatori per canale lacrimale
Specilli per canale lacrimale, Sonde trabecular

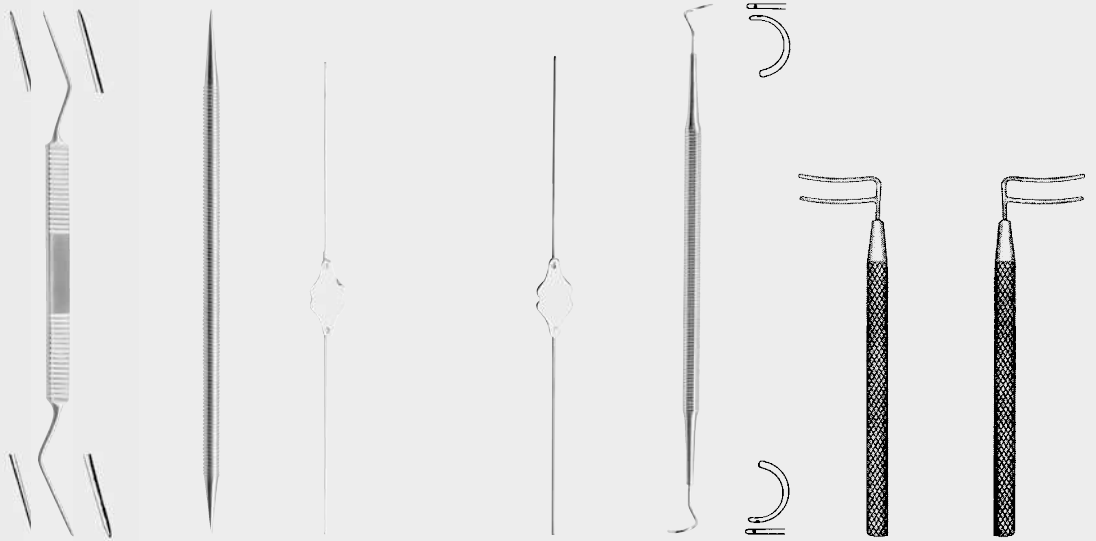

OPHTHALMOLOGIE

OPHTHALMOLOGY

OPHTHALMOLOGIE

OFTALMOLOGÍA

OFTALMOLOGIA

Iris-Pinzetten
Iris Forceps
Pincas à iris
Pinzas para iris
Pinze per iride

Fig.	ZIEGLER	CASTROVIEJO	BOWMAN	Fig.	ø mm	BOWMAN	cm	WORST (Pigtail)	HARMS	HARMS
1/2	42-6005-12	42-6008-12	42-6104-00	00/0	0,7	42-6106-00	14,5	42-6200-14	42-6210-01	42-6210-02
3/4	42-6005-34		42-6104-01	0/1	0,8	42-6106-01				
5/6	42-6005-56		42-6104-12	1/2	0,9	42-6106-12				
			42-6104-23	2/3	1,1	42-6106-23				
			42-6104-34	3/4	1,3	42-6106-34				
			42-6104-45	4/5	1,4	42-6106-45				
			42-6104-56	5/6	1,5	42-6106-56				
			42-6104-67	6/7	1,6	42-6106-67				
			42-6104-78	7/8	1,9	42-6106-78				

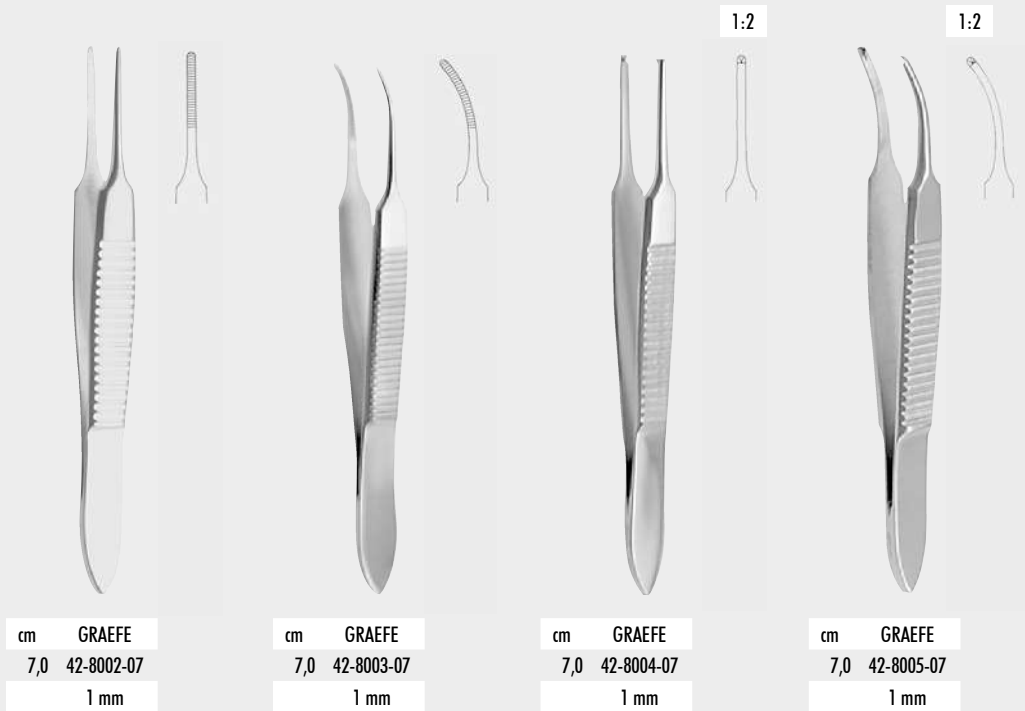

cm	GRAEFE	cm	GRAEFE	cm	GRAEFE	cm	GRAEFE
7,0	42-8002-07	7,0	42-8003-07	7,0	42-8004-07	7,0	42-8005-07
	1 mm		1 mm		1 mm		1 mm



cm GRAEFE
10,0 42-8100-10



cm GRAEFE
10,0 42-8101-10
42-8106-10
glatt
smooth
lisse
lisa
liscia



cm GRAEFE
10,0 42-8103-10
42-8107-10
glatt
smooth
lisse
lisa
liscia



1:2
cm GRAEFE
10,0 42-8200-10



1:2
cm GRAEFE
10,0 42-8201-10



1:2
cm GRAEFE
10,0 42-8203-10

Iris-Pinzetten
Iris Forceps
Pincas à iris
Pinzas para iris
Pinze per iride

OPHTHALMOLOGIE

OPHTHALMOLOGY

OPHTHALMOLOGIE

OFTALMOLOGÍA

OFTALMOLOGIA



cm STEVENS
10,5 42-8300-10



cm STEVENS
10,5 42-8301-10



cm STEVENS
10,5 42-8303-10



1:2
cm STEVENS
10,5 42-8400-10



1:2
cm STEVENS
10,5 42-8401-10



1:2
cm STEVENS
10,5 42-8403-10



cm CHANDLER
7,5 42-8410-07 - 42-8412-07



42-8410-07
gerieft
serrated
striée
estriada
zigrinata

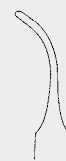

42-8412-07
glatt
smooth
lisse
lisa
liscia

Iris-Pinzetten
Iris Forceps
Pincès à iris
Pinzas para iris
Pinze per iride

OPHTHALMOLOGIE

OPHTHALMOLOGY

OPHTHALMOLOGIE

OFTALMOLOGÍA

OFTALMOLOGIA



cm FOERSTER
8,5 42-8500-08

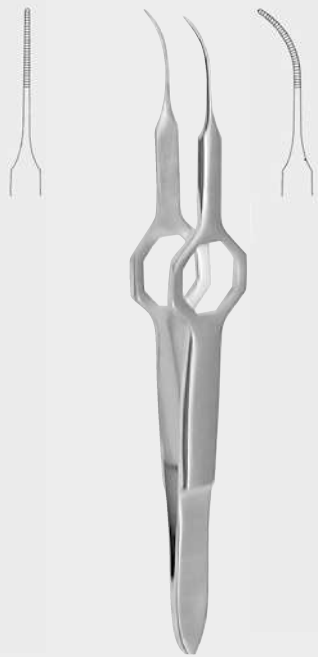

cm FOERSTER
8,5 42-8501-08



cm FOERSTER
8,5 42-8502-08

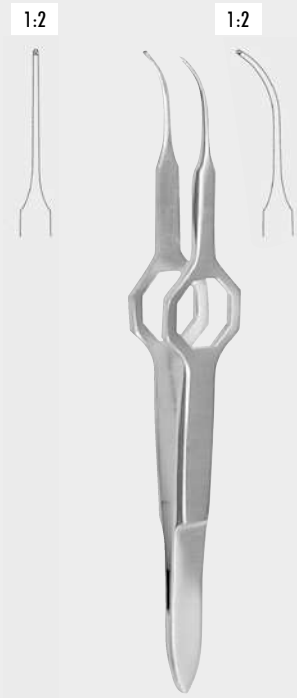

cm FOERSTER
8,5 42-8503-08

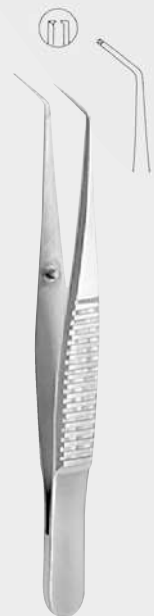

cm HESS
7,0 42-8505-07
0,3 mm



cm HESS
7,0 42-8507-07
0,3 mm



cm GILL
7,5 42-8601-07
0,3 mm



cm GILL-HESS
7,5 42-8603-07
0,3 mm



cm GILL-HESS
7,5 42-8605-07
0,3 mm

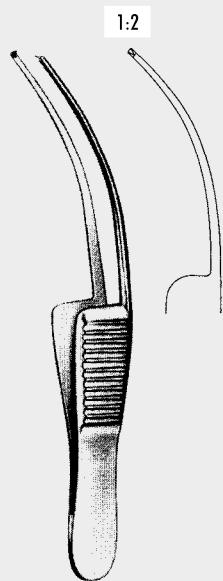

cm FISCHER
7,0 42-8607-07

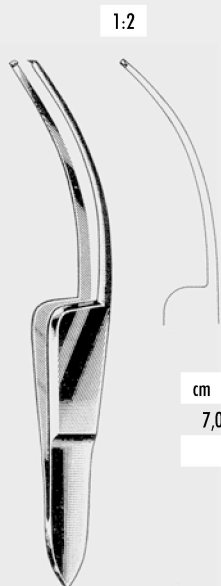

cm FISCHER-ARLT
7,0 42-8609-07



cm BARRAQUER-KATZIN
7,0 42-8801-07
0,4 mm

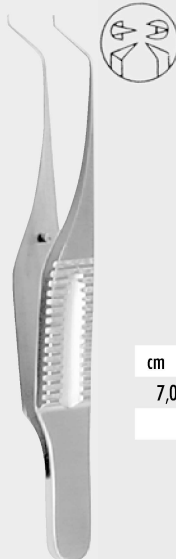

cm BARRAQUER KATZIN (Colibri)
7,0 42-8804-07
0,12 mm

cm TROUTMAN (Colibri)
7,0 42-8803-07
0,12 mm

Iris-Pinzetten
Iris Forceps
Pincès à iris
Pinzas para iris
Pinze per iride

OPHTHALMOLOGIE

OPHTHALMOLOGY

OPHTALMOLOGIE

OFTALMOLOGÍA

OFTALMOLOGIA



cm BARRAQUER (Colibri)
7,0 42-8805-07
0,12 mm

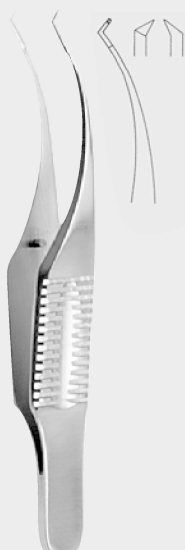

cm BARRAQUER (Colibri)
7,0 42-8807-07
0,12 mm



cm KIRBY-ARTHUR
9,0 42-8901-09
0,2 mm



cm KIRBY-ARTHUR
9,0 42-8903-09
0,2 mm



Strabismus-Pinzetten
 Strabismus Forceps
 Pincès à strabisme
 Pinzas para estrabismo
 Pinze per strabismo

OPHTHALMOLOGIE

OPHTHALMOLOGY

OPHTHALMOLOGIE

OFTALMOLOGÍA

OFTALMOLOGIA

1:2



cm McCULLOUGH
 9,5 42-9002-09



cm McCULLOUGH
 9,5 42-9004-09



cm JAMESON
 10,0 42-9007-10



cm JAMESON
 10,0 42-9009-10



cm NUGENT
 10,0 42-9011-10 - 42-9013-10



42-9011-10



42-9013-10

1:2



cm BONACCOLTO
 10,0 42-9104-10



cm BONACCOLTO
 10,0 42-9106-10



cm BONACCOLTO
 11,0 42-9200-11



cm DASTOOR
 11,0 42-9204-11



cm DASTOOR
 11,0 42-9206-11



Iris-Pinzetten
Iris Forceps
Pincès à iris
Pinzas para iris
Pinze per iride

OPHTHALMOLOGIE

OPHTHALMOLOGY

OPHTALMOLOGIE

OFTALMOLOGÍA

OFTALMOLOGIA



cm BISHOP-HARMAN
8,5 42-9400-05
0,5 mm



cm BISHOP-HARMAN
8,5 42-9400-08
0,8 mm



cm BISHOP-HARMAN
8,5 42-9402-05
0,5 mm



cm BISHOP-HARMAN
8,5 42-9402-08
0,8 mm



1:2



cm Mod. BONN
7,0 42-9404-07
0,12 mm



1:2



cm Mod. BONN
7,0 42-9406-07
0,12 mm



1:2



cm Mod. BONN
10,0 42-9406-10
0,12 mm



cm Mod. TUEBINGEN
10,0 42-9500-10
42-9504-10

1:2



cm Mod. BONN
10,0 42-9502-10
42-9506-10
0,12 mm



cm Mod. TUEBINGEN
10,0 42-9503-10
42-9507-10

Linsen-Implantationspinzetten
 Lens Implantation Forceps
 Pinces à planter les lentilles
 Pinzas para implantar lentes
 Pinze per impiantare lenti

OPHTHALMOLOGIE



cm BINKHORST
 7,5 42-9601-07



cm CLAYMAN
 7,5 42-9603-08



cm SHEPARD
 8,0 42-9605-08



cm SHEPARD
 7,5 42-9607-07

Mit Irrigator - with irrigator - avec irrigateur - con irrigador - con irrigatore

OPHTHALMOLOGY

OPHTHALMOLOGIE

cm CLAYMAN
 7,5 42-9613-08

cm SHEPARD
 8,0 42-9615-08

cm SHEPARD
 7,5 42-9617-07

Ohne Irrigator - without irrigator - sans irrigateur - sin irrigador - senza irrigatore

OFTALMOLOGÍA

OFTALMOLOGIA

Bulbus-Ringe
 Scleral Fixation Rings
 Anneaux bulbaires
 Anillos para el bulbo
 Anelli per il bulbo

OPHTHALMOLOGIE

OPHTHALMOLOGY

OPHTALMOLOGIE

OFTALMOLOGÍA

OFTALMOLOGIA



Vorlagerungs-, Muskel-Pinzetten
 Advancement, Muscle Forceps
 Pincés à avancement et pincés musculaires
 Pinzas de avanzamiento y pinzas musculares
 Pinze per avanzamento e pinze muscolari

OPHTHALMOLOGIE

OPHTHALMOLOGY

OPHTHALMOLOGIE

OFTALMOLOGÍA

OFTALMOLOGIA



cm BLASCOVICS
 9,0 43-0093-09
 «

cm BLASCOVICS
 9,0 43-0095-09
 »

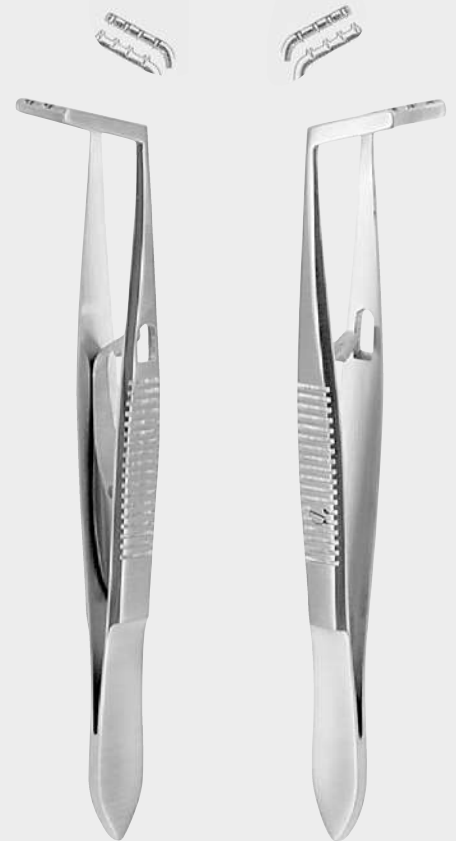

cm PRINCE
 10,0 43-0101-10
 «

cm PRINCE
 10,0 43-0103-10
 »



cm BERKE
 10,0 43-0105-20 - 43-0105-27

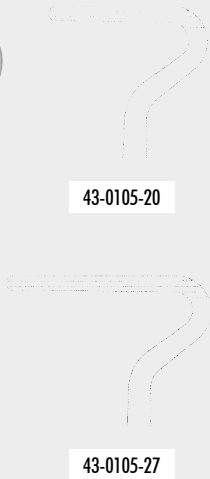

cm TROUTMAN mm
 8,5 43-0107-08 0,8

Vorderkammer-Pinzette
 Anterior Chamber Forceps
 Pince à chambre antérieure
 Pinza para cámara anterior
 Pinza per camera anteriore

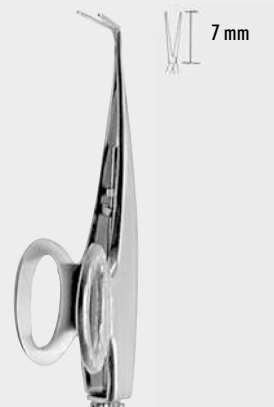

cm BARRAQUER mm
 5,5 43-0201-05 7,0

1:2



cm ELSCHING
11,0 43-0406-11



cm GRAEFE
11,0 43-0500-11 - 43-0502-11



43-0500-11

ohne Schloss
without catch
sans arrêt
sin cierre
senza arresto



43-0502-11

mit Schloss
with catch
avec arrêt
con cierre
con arresto



cm LESTER
9,0 43-0504-09 - 43-0506-09

1:2



43-0504-09

2:3



43-0506-09

1:1



CASTROVIEJO
43-0606-09

1:1



CASTROVIEJO
43-0607-09

Fixier-Pinzetten
Fixation Forceps
Pinces à fixation
Pinzas para fijación
Pinze per fissaggio

OPHTHALMOLOGIE

OPHTHALMOLOGY

OPHTALMOLOGIE

OFTALMOLOGÍA

OFTALMOLOGIA

2:2



cm CASTROVIEJO
9,0 43-0608-09

2:2



cm CASTROVIEJO
9,0 43-0609-09



cm BARRAQUER
10,0 43-0704-10



cm GREEN
10,0 43-0706-05 - 43-0708-10



43-0706-05

5 mm

ohne Schloss
without catch
sans arrêt
sin cierre
senza arresto



43-0708-05

5 mm

mit Schloss
with catch
avec arrêt
con cierre
con arresto



43-0706-10

10 mm

ohne Schloss
without catch
sans arrêt
sin cierre
senza arresto



43-0708-10

10 mm

mit Schloss
with catch
avec arrêt
con cierre
con arresto



cm GILL-ARRUGA
7,5 43-1001-07

Fixier-Pinzetten, Kapsel-Pinzette
Fixation Forceps, Capsular Forceps
Pinces à fixation, Pince capsulaire
Pinzas para fijación, Pinza capsular
Pinze per fissaggio, Pinza capsulare



Kapsel-Pinzetten
 Capsular Forceps
 Pincas capsulaires
 Pinzas capsulares
 Pinze capsulari

OPHTHALMOLOGIE



cm Terson
 9,0 43-1003-09

cm KALT
 10,0 43-1006-10

cm ELSCHING
 10,0 43-1009-10

cm ARRUGA
 10,0 43-1101-10

cm ARRUGA
 10,0 43-1104-10

cm CASTROVIEJO
 10,0 43-1105-10

OPHTHALMOLOGY

OPHTHALMOLOGIE

OFTALMOLOGÍA

OFTALMOLOGIA



cm SCHWEIGGER
 10,0 43-1107-10

cm SCHWEIGGER
 10,0 43-1109-10

cm ELSCHING
 10,0 43-1201-10

cm HESS
 6,0 43-1205-06

cm HESS
 6,0 43-1207-06

cm HESS
 7,0 43-1209-07

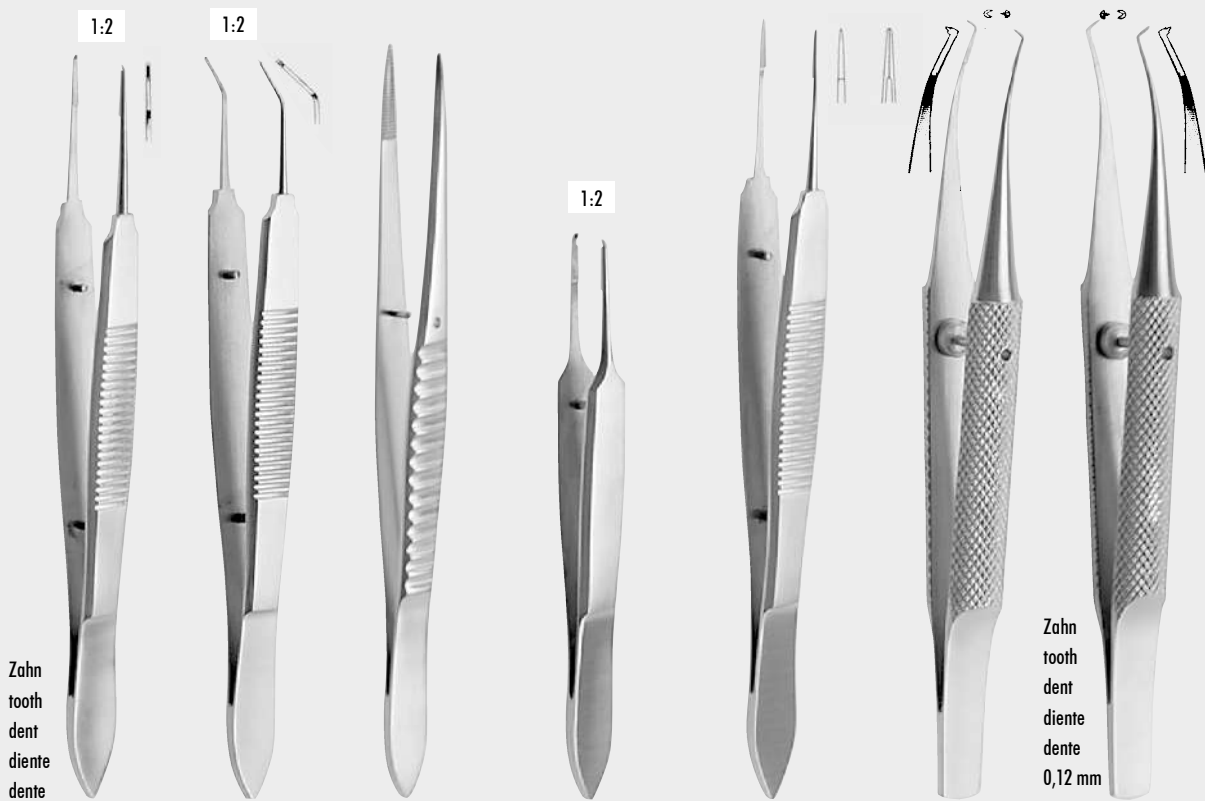

mm	CASTROVIEJO 10,0 cm	
0,12	43-1500-01	
0,30	43-1500-03	
0,50	43-1500-05	43-1501-05
1,00	43-1500-10	43-1501-10
1,50	43-1500-15	43-1501-15

cm	MOORFIELD
10,0	43-1604-10

cm	St. MARTIN
7,0	43-1606-07

cm	Mod. Tübingen
10,0	43-1801-10

cm	GIRARD (Colibri)
10,0	43-1805-10
	»

cm	GIRARD (Colibri)
10,0	43-1807-10
	«

Zahn
tooth
dent
diente
dente
0,12 mm

OPHTHALMOLOGIE

OPHTHALMOLOGY

OPHTALMOLOGIE

OFTALMOLOGÍA

OFTALMOLOGIA

Titan
Titanium
Titane
Titanio

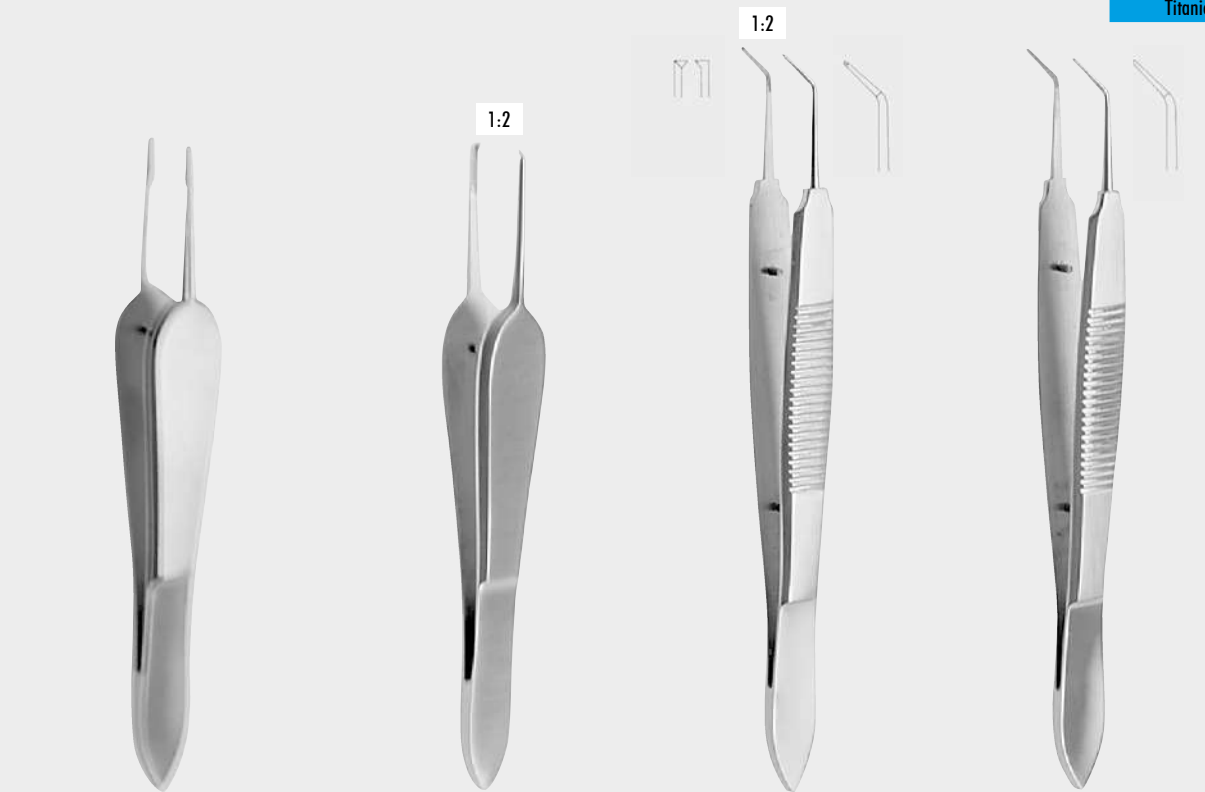

cm	PAUFIQUE
8,5	43-1900-08
8,5	43-1904-08

cm	PAUFIQUE
8,5	43-2002-08
8,5	43-2006-08

cm	McPHERSON
10,0	43-2100-10
10,0	43-2104-10

cm	McPHERSON
10,0	43-2200-10
10,0	43-2204-10

ZEPF®
INSTRUMENTS

43-2204-10

Pinzetten für Chalazion
 Chalazio Forceps
 Pincès à chalazion
 Pinzas de chalazión
 Pinze per calazio

OPHTHALMOLOGIE

OPHTHALMOLOGY

OPHTHALMOLOGIE

OFTALMOLOGÍA

OFTALMOLOGIA



cm AYER
 9,0 43-2400-09



cm AYER
 9,0 43-2402-09



cm LAMBERT
 9,0 43-2406-09



cm DESMARRES
 9,0 43-2504-09 - 43-2508-09



43-2504-09
 Fig. 1

43-2506-09
 Fig. 2

43-2508-09
 Fig. 3

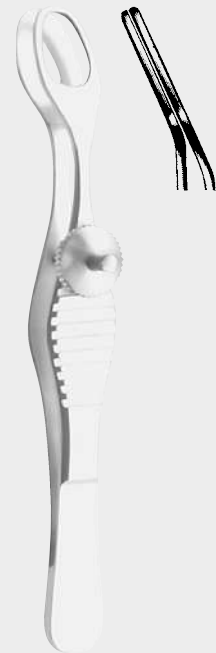

cm LORDAN
 9,0 43-2511-09



cm SNELLEN
10,0 43-2605-10
Fig. 1

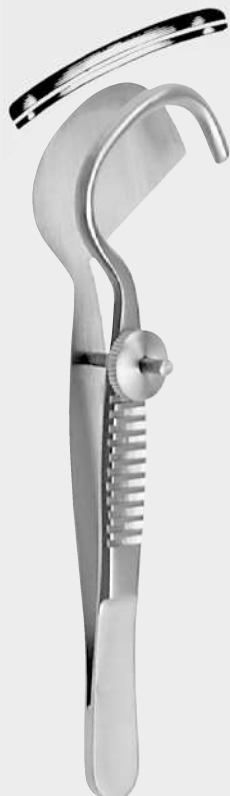

cm SNELLEN
10,0 43-2607-10
Fig. 2



cm KNAPP-LUER
11,0 43-2704-11

Pinzetten für Entropium und Trachom
Forceps for Entropium and Trachoma
Pincès à entropion et à
granulations du trachome
Pinzas de chalazión y para tracoma
Pinze per entropio e per trichiasi

OPHTHALMOLOGIE

OPHTHALMOLOGY

OPHTHALMOLOGIE

OFTALMOLOGÍA

OFTALMOLOGIA



cm JAMESON
10,0 43-2711-10
»



cm JAMESON
10,0 43-2713-10
«



cm BERENS
10,0 43-2721-10

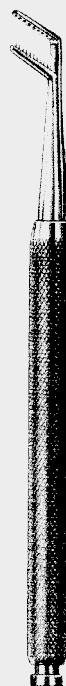

cm BANGERTER
10,0 43-2725-10

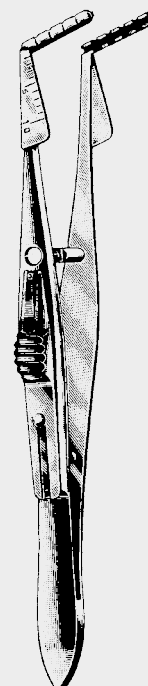

cm BERENS
10,0 43-2731-10

Vorlagerungs-, Muskel-Pinzetten
Advancement, Muscle Forceps
Pincès à avancement et pincès musculaires
Pinzas de avanzamiento y pinzas musculares
Pinze per avanzamento e pinze muscolari



Augen-Kanülen
 Eye Cannulas
 Canules oculaires
 Cánulas oculares
 Cannule oculistiche



SCHEIE
 43-3002-28
 1,0 x 28 mm



SCHEIE
 43-3002-33
 1,5 x 33 mm



Mod. Tübingen
 43-3003-45



Mod. Hamburg
 43-3005-00

OPHTHALMOLOGIE

OPHTHALMOLOGY

OPHTHALMOLOGIE

OFTALMOLOGÍA



SIMCOE
 43-3006-00



Mod. Bonn
 43-3007-00



Mod. Bonn
 43-3009-00



SIMCOE
 43-3010-00

OFTALMOLOGIA

Hornhaut-Trephinen
 Corneal Trephines
 Trépanos cornéens
 Trépanos corneales
 Trefine corneali



CASTROVIEJO
 43-3100-50 - 43-3101-01

mm	CASTROVIEJO
5,0	43-3100-50
5,5	43-3100-55
6,0	43-3100-60
6,5	43-3100-65
7,0	43-3100-70
8,0	43-3100-80
9,0	43-3100-90
10,0	43-3101-00
11,0	43-3101-01



FRANCESCHETTI
 43-3200-50 - 43-3201-00

mm	FRANCESCHETTI
5,0	43-3200-50
5,1	43-3200-51
6,0	43-3200-60
6,1	43-3200-61
7,0	43-3200-70
7,1	43-3200-71
8,0	43-3200-80
8,1	43-3200-81
9,0	43-3200-90
9,1	43-3200-91
10,0	43-3201-00



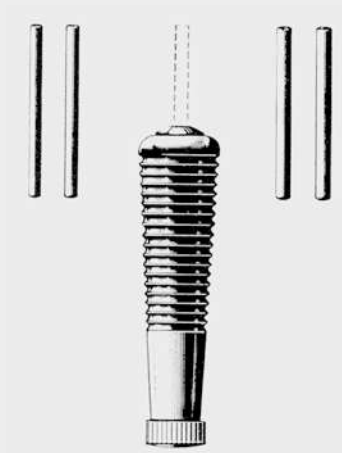

ELLIOT
43-3400-00
compl. = 4



43-4008-00

Hornhaut-Trephine
Corneal Trephine
Trépan cornéen
Trépano corneal
Trefina corneale

OPHTHALMOLOGIE

OPHTHALMOLOGY

OPHTHALMOLOGIE

OFTALMOLOGÍA

OFTALMOLOGIA

Augenmagnet
Eye Magnet
Aimant à corps étrangers
Imán para cuerpos extraños
Calamita per corpi estranei

Cilien-Pinzetten
Cilia Forceps
Pincès à épiler
Pinzas depilatorias
Pinze depilatorie

OPHTHALMOLOGIE

OPHTHALMOLOGY

OPHTHALMOLOGIE

OFTALMOLOGÍA

OFTALMOLOGIA

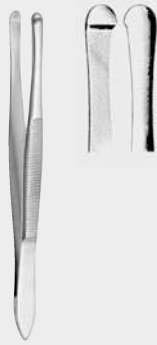

cm BEER
9,0 43-4200-09

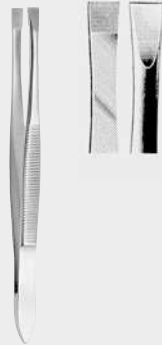

cm DOUGLAS 4,5 mm
9,0 43-4202-09



cm DOUGLAS 2,5 mm
9,0 43-4203-09

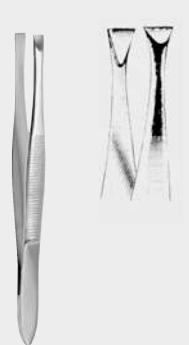

cm LITTAUER
8,5 43-4204-08



cm BARRAQUER
10,5 43-4205-10



cm
9,0 43-4206-09



cm SHAAF
9,0 43-4207-09

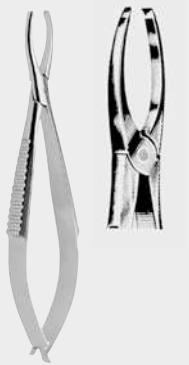

cm GRADLE
9,5 43-4208-09

OTOLOGIE

OTOLOGY

OTOLOGIE

OTOLOGÍA

OTOLOGIA





Ohrspekula (Ohrtrichter)
Ear Specula
Spéculeurs auriculaires
Espéculos auriculares
Specoli auricolari



HARTMANN
44-0100-00
Set=4
4,5 - 7,5 mm

ø mm	3,0	44-0100-30	44-0101-30
ø mm	4,5	44-0100-45	44-0101-45
ø mm	5,5	44-0100-55	44-0101-55
ø mm	6,5	44-0100-65	44-0101-65
ø mm	7,5	44-0100-75	44-0101-75



TOYNBEE
44-0102-00
Set=3
5,5 - 7,5 mm

ø mm	5,5	44-0102-55
ø mm	6,5	44-0102-65
ø mm	7,5	44-0102-75

schwarz
black
noirs
negros
neri



GRUBER
44-0104-00
Set=4
4,5 - 7,5 mm

ø mm	4,5	44-0104-45
ø mm	5,5	44-0104-55
ø mm	6,5	44-0104-65
ø mm	7,5	44-0104-75

rund - round - rondes
redondos - rotondi



GRUBER
44-0105-00
Set=3
5,5 - 7,5 mm

ø mm	4,5	44-0105-45
ø mm	5,5	44-0105-55
ø mm	6,5	44-0105-65
ø mm	7,5	44-0105-75

OTOLOGIE

OTOLOGY

OTOLOGIE

OTOLOGÍA

OTOLOGIA



BOUCHERON
44-0108-00
Set=4
5,0 - 8,0 mm

ø mm	5,0	44-0108-50
ø mm	6,0	44-0108-60
ø mm	7,0	44-0108-70
ø mm	8,0	44-0108-80



ROSEN
44-0110-41 - 44-0110-95

mm x mm	3,3 x 4,1	44-0110-41
mm x mm	4,0 x 5,5	44-0110-55
mm x mm	5,0 x 7,5	44-0110-75
mm x mm	6,0 x 8,5	44-0110-85
mm x mm	7,0 x 9,5	44-0110-95



ROSEN
44-0112-03 - 44-0112-07

ø mm	3,0	44-0112-03
ø mm	4,0	44-0112-04
ø mm	5,0	44-0112-05
ø mm	6,0	44-0112-06
ø mm	7,0	44-0112-07



FARRIOR
44-0200-01 - 44-0200-09
44-0200-00 Set=9
3,3 - 7,7 mm

ø mm	3,3	44-0200-01
ø mm	4,3	44-0200-02
ø mm	4,8	44-0200-03
ø mm	5,3	44-0200-04
ø mm	5,8	44-0200-05
ø mm	6,3	44-0200-06
ø mm	6,7	44-0200-07
ø mm	7,2	44-0200-08
ø mm	7,7	44-0200-09

schwarz
black
noirs
negros
neri

mm x mm
5,5 x 6,5 44-0204-01
mm x mm
6,5 x 7,5 44-0204-02
mm x mm
7,5 x 8,5 44-0204-03
mm x mm
8,5 x 9,5 44-0204-04
mm x mm
9,0 x 10,5 44-0204-05
mm x mm
10,5 x 11,5 44-0204-06



ZÖLLNER
44-0204-00
Set=6

schwarz
black
noirs
negros
neri

mm x mm
3,5 x 6,5 44-0206-40
mm x mm
4,0 x 5,5 44-0206-55
mm x mm
5,0 x 7,3 44-0206-73
mm x mm
6,0 x 8,5 44-0206-85
mm x mm
7,3 x 9,0 44-0206-90



SHEA
44-0206-00
Set=5

schwarz
black
noirs
negros
neri

ø mm
3,2 44-0208-32
ø mm
5,0 44-0208-50
ø mm
5,5 44-0208-55
ø mm
6,2 44-0208-62
ø mm
6,6 44-0208-66
ø mm
7,0 44-0208-70
ø mm
7,2 44-0208-72
ø mm
9,2 44-0208-92



TUMARKIN
44-0208-00
Set=8

Ohrspekula (Ohrtrichter)
Ear Specula
Spéculems auriculaires
Espéculos auriculares
Specoli auricolari

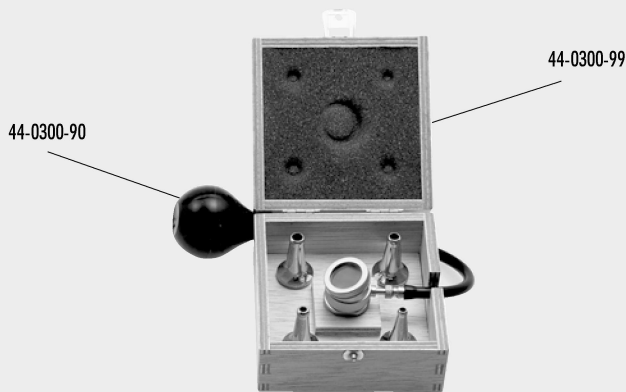

44-0300-99

44-0300-90

BRUENINGS compl.
44-0300-04

OTOLOGIE

OTOLOGY

OTOLOGIE

Mit Lupe, 4 Ohrspekula
mit Gebläse, in Holzetui

With Magnifying Lens,
4 Ear Specula, Rubber Ball,
in Wooden Box

Avec loupe grossissante,
4 spéculems auriculaires,
poire soufflante, en boîte bois

Con lente de aumentar,
4 espéculos auriculares,
soflera, en estuche de madera

Con lente d'ingrandimento,
4 specoli auricolari, con
soffiera, in scatola di legno



ø mm	6,5 44-0306-11	ø mm	7,0 44-0306-12	ø mm	8,0 44-0306-13
------	----------------	------	----------------	------	----------------

Mit 3 Spekula und Gebläse
With 3 Specula and Rubber Tube with Bulb
Avec 3 spéculems en métal, poire soufflante et tube
Con 3 espéculos, insuflador y tubo
Con 3 specoli, palla soffiatrice e tubo



44-0306-90

SIEGLE compl.
44-0306-03

Ohrspekula für die pneumatische Prüfung
Ear Specula for Pneumatic Test
Spéculems auriculaires pour le test pneumatique
Espéculos auriculares para el test neumático
Specoli auricolari per il test pneumatico



Stimmgabeln
Tuning Forks
Diapasons
Diapasones
Diapason

OTOLOGIE

OTOLOGY

OTOLOGIE

OTOLOGÍA

OTOLOGIA

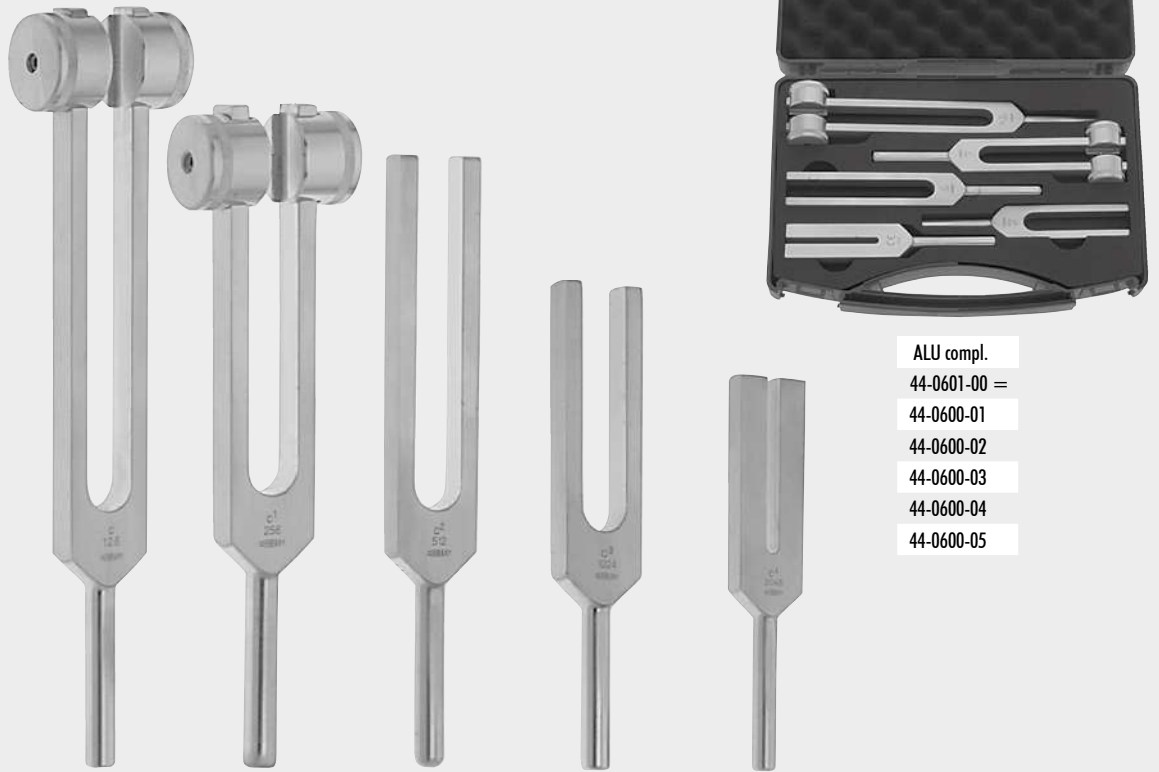

ALU compl.
44-0601-00 =
44-0600-01
44-0600-02
44-0600-03
44-0600-04
44-0600-05

ALU				
44-0600-01	44-0600-02	44-0600-03	44-0600-04	44-0600-05
C 128	C 256	C ² 512	C ³ 1024	C ⁴ 2048

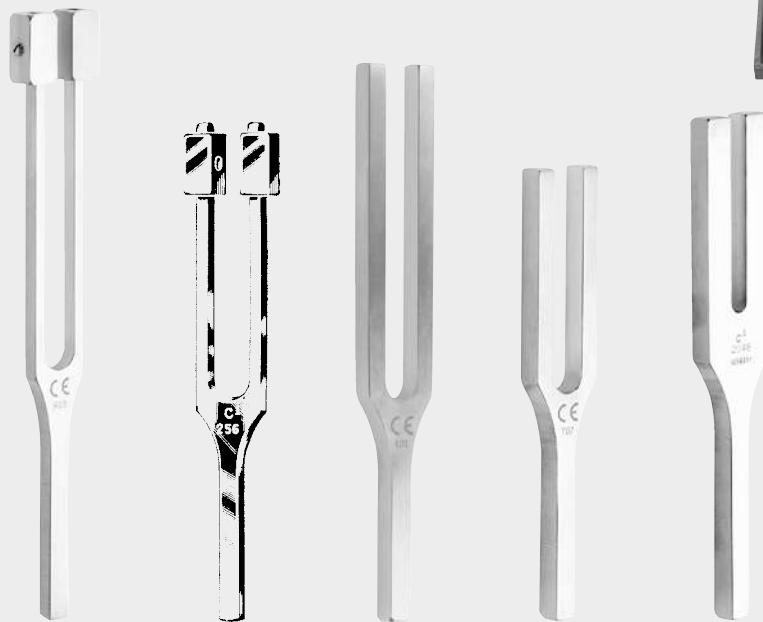

HARTMANN compl.
44-0700-00 =
44-0700-01
44-0700-02
44-0700-03
44-0700-04
44-0700-05

HARTMANN				
44-0700-01	44-0700-02	44-0700-03	44-0700-04	44-0700-05
C 128	C 256	C ² 512	C ³ 1024	C ⁴ 2048

Stimmgabeln
Tuning Forks
Diapasons
Diapasones
Diapason

OTOLOGIE

OTOLOGY

OTOLOGIE

OTOLOGÍA

OTOLOGIA

Pulverbläser
Powder Blowers
Lance-Poudre
Lanzapolvo
Insuffiadori per polvere

ZEPF®
INSTRUMENTS

44-0900-01

44.5



LUCAE

C	128	44-0702-00
C¹	253	44-0702-01
C²	512	44-0702-02
C³	1024	44-0702-03
C⁴	2011	44-0702-04
C⁵	4096	44-0702-05



LUCAE

44-0704-01
C 128

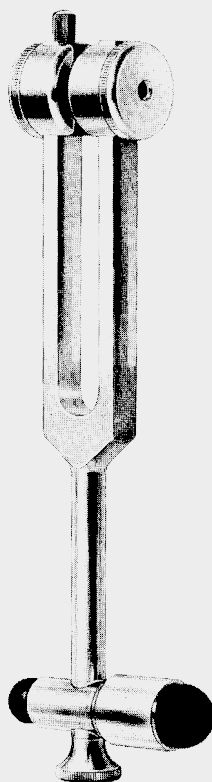

44-0705-00
neuro.



RYDEL-SEIFFER
44-0706-01
C 64 / C128



44-0708-00
A¹ 440



Komplett mit 3 Kanülen für Nase, Rachen, Kehlkopf
Complete with 3 cannulas for nose, throat, and larynx
Complet avec 3 différentes canules pour nez, pharynx et larynx
Completo con 3 cánulas diferentes para nariz, faringe y laringe
Completo di 3 cannule diversi per naso, faringe e laringe



KABIERSKE
44-0900-00
30 cc



Komplett mit 3 Kanülen für Nase, Rachen, Kehlkopf,
mit Metallfuß
Complete with 3 cannulas for nose, throat, and larynx,
with Metal Base
Complet avec 3 différentes canules pour nez, pharynx et
larynx, avec socle en métal
Completo con 3 cánulas diferentes para nariz, faringe y
laringe, con soporte de metal
Completo di 3 cannule diversi per naso, faringe e laringe,
con placca di metallo

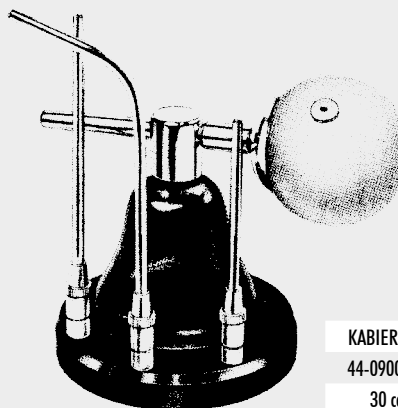

KABIERSKE
44-0900-01
30 cc



Luftdusche
Air Bag
Insufflateur d'air
Insulador de aire
Insoffiatore d'aria



POLITZER
44-0901-00 = incl. 44-0901-15, 44-0901-17, 44-0901-22, 44-0901-03, 44-0901-35
44-0901-01 = incl. 44-0901-15, 44-0901-17, 44-0901-22, 44-0901-03, 44-0901-04, 44-0901-35

OTOLOGIE

OTOLOGY

OTOLOGIE

OTOLOGÍA

OTOLOGIA

* Ganzmetall, komplett, mit 2 Aufsätzen und 1 Schutzstiller
All Metal, complete, with 2 Tips and 1 Protective Shield
Entièrement en métal, complet avec 2 embouts et plaque protectrice
Completamente de metal, con 2 cánulas y placa protectora
Completamente in metallo, con 2 punte e placca protettiva

Ohrspritzen, Saugrohre
Ear Syringes, Aspirating Tubes
Seringues auriculaires, Tubes d'aspiration
Jeringas para oídos, Tubos de aspiración
Siringhe auricolari, Tubi da aspirazione

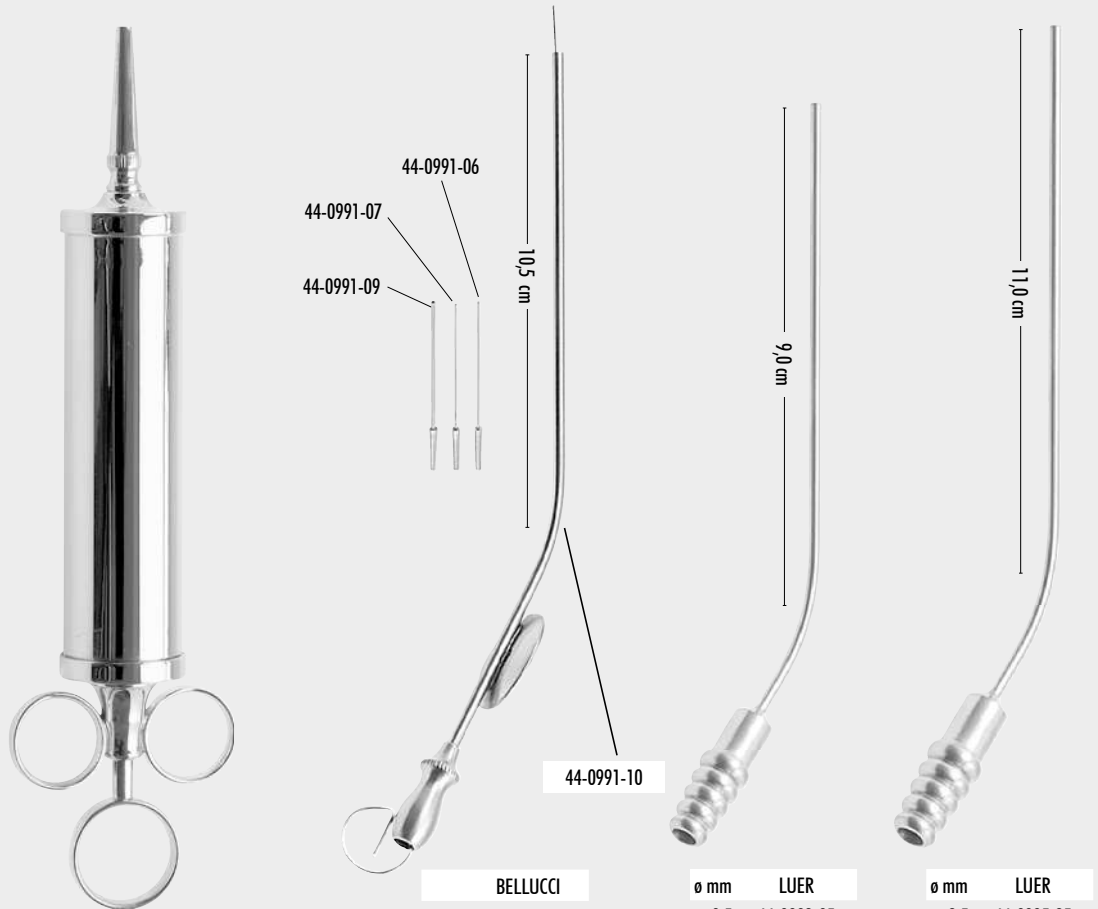

ml	REINER *
50	44-0906-50
75	44-0906-75
100	44-0907-10
150	44-0907-15

BELLUCCI		ø mm	LUER	ø mm	LUER
Set	44-0991-00	0,5	44-0993-05	2,5	44-0995-25
=		0,7	44-0993-07	3,0	44-0995-30
1x	44-0991-10	1,0	44-0993-10	4,0	44-0995-40
1x	44-0991-06	1,5	44-0993-15	5,0	44-0995-50
1x	44-0991-07	2,0	44-0993-20		
1x	44-0991-09				



Saugrohre
Aspirating Tubes
Tubes d'aspiration
Tubos de aspiración
Tubi da aspirazione

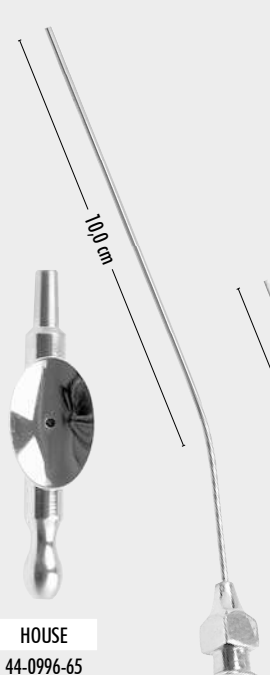

ø mm HOUSE
7 44-0996-65

ø mm	WULLSTEIN
Set	44-1000-00
0,4	44-1000-04
0,6	44-1000-06
0,8	44-1000-08

ø mm	BARON (SCHUKNECHT)
1,0	44-1001-03
1,5	44-1001-05
2,0	44-1001-06



mm	mm	Fig.	HOUSE
0,9	0,7	1	44-1003-01
1,2	0,9	2	44-1003-02
1,5	1,2	3	44-1003-03
1,8	1,8	4	44-1003-04

Swg	ø mm	VERHOEFEN
24	0,6	44-0998-06
22	0,7	44-0998-07
20	0,9	44-0998-09
18	1,2	44-0998-12
16	1,6	44-0998-16
	10,0 cm	

ø mm	HOUSE
0,5	44-0999-05
0,7	44-0999-07
0,8	44-0999-08
1,0	44-0999-10
1,3	44-0999-13
1,5	44-0999-15
2,0	44-0999-20
2,5	44-0999-25
	6,0 cm



ø mm PLESTER
1,5 44-1003-15
2,0 44-1003-20
2,5 44-1003-25
3,0 44-1003-30
19,5 cm



cm WULLSTEIN
13,0 44-1004-13



ø1 mm ø2 mm FISCH 9,5 cm
3,2 mm 2,0 mm 44-1005-32



cm ZOEGLNER
15,0 44-1007-15

1	2	FISCH 9,5 cm
1,0	1,0	44-1006-10
1,5	1,5	44-1006-15
1,9	1,9	44-1006-19
2,5	2,5	44-1006-25
3,0	2,0	44-1006-30
4,0	2,0	44-1006-45

ø mm	
0,5	44-1008-05
0,7	44-1008-07

OTOLOGIE

OTOLOGY

OTOLOGIE

OTOLOGÍA

OTOLOGIA

Ohrküretten
Ear Curettes
Curettes auriculaires
Curetas auriculares
Curette auricolari

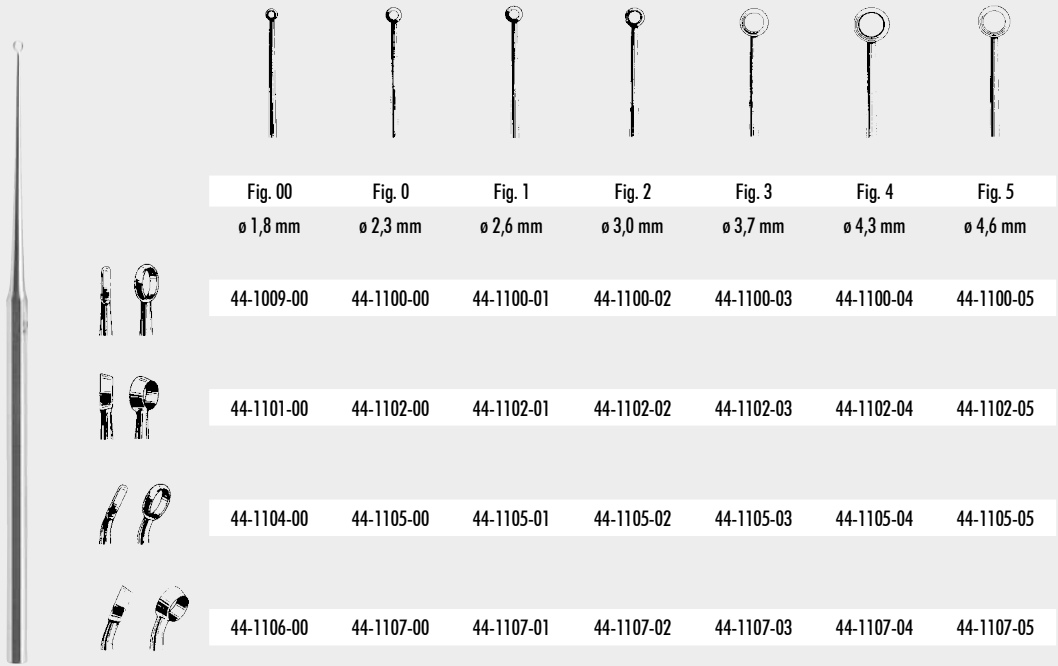

OTOLOGIE

BUCK

44-1009-00 - 44-1107-05

44-1009-00 - 44-1100-05
44-1101-00 - 44-1102-05
44-1104-00 - 44-1105-05
44-1106-00 - 44-1107-05

gerade, stumpf / straight, blunt / droites, mousses / rectas, romas / rette, smusse
gerade, scharf / straight, sharp / droites, tranchantes / rectas, cortantes / rette, taglianti
abgewinkelt, stumpf / angled, blunt / coudées, mousses / acodadas, romas / angolate, smusse
abgewinkelt, scharf / angled, sharp / coudées, tranchantes / acodadas, cortantes / angolate, taglianti

OTOLOGY

OTOLOGIE

OTOLOGÍA

OTOLOGIA

Ohrkatheter, Paracentesenadeln
Ear Catheters, Paracentesis Needles
Cathéters auriculaires, Aiguilles à paracentèse
Catéteres auriculares, Agujas para paracentesis
Cateteri auricolari, Aghi per paracentesi

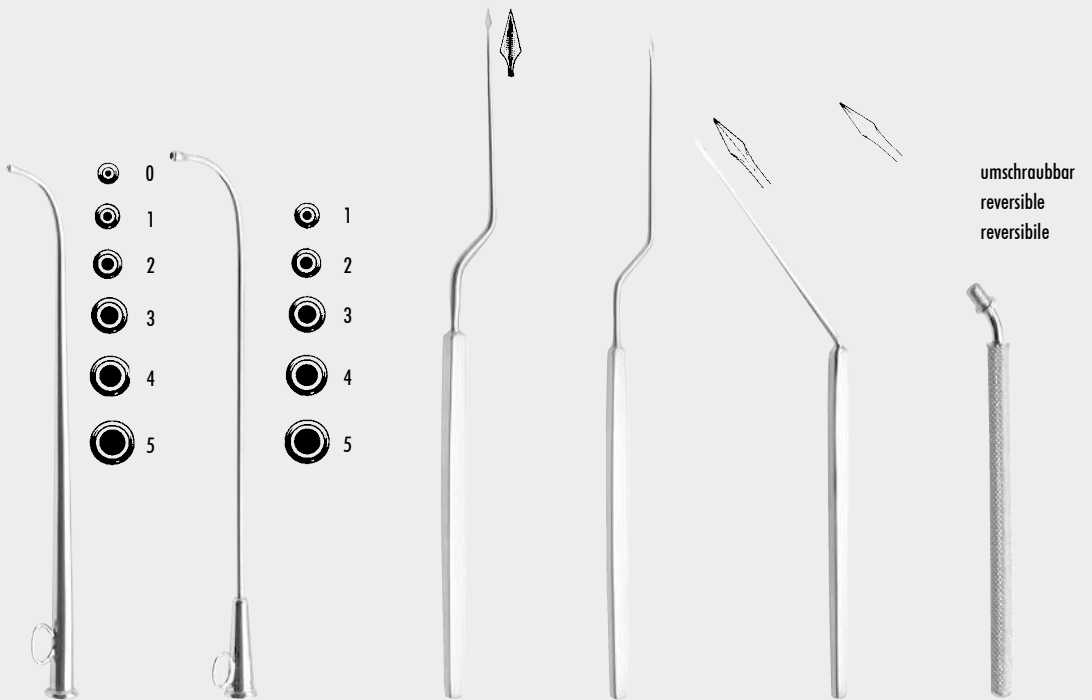
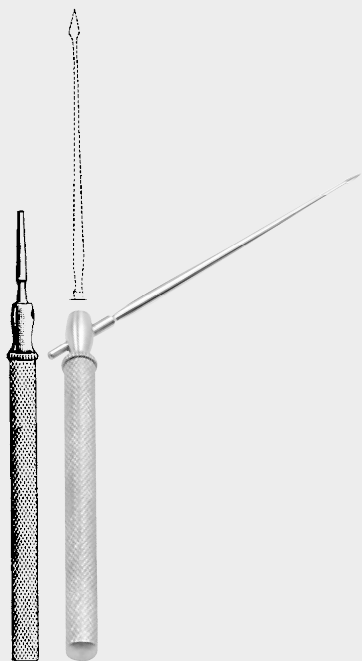

Fig.	HARTMANN	ITARD	cm	LUCAE	cm	POLITZER	cm	POLITZER	POLITZER
0	44-1301-00		18,0	44-1498-18	18,0	44-1500-18	16,5	44-1501-16	44-1503-16
1	44-1301-01	44-1303-01							
2	44-1301-02	44-1303-02							
3	44-1301-03	44-1303-03							
4	44-1301-04	44-1303-04							
5	44-1301-05	44-1303-05							



cm POLITZER
17,0 44-1505-17



cm THORBURN
16,0 44-1508-16



cm BUCK (POLITZER)
15,0 44-1600-15



cm SEXTON
18,0 44-1602-18

Ohrmesser
Ear Knives
Couteaux auriculaires
Cuchillos auriculares
Coltelli auricolari

OTOLOGIE

OTOLOGY

OTOLOGIE

OTOLOGÍA

OTOLOGIA



cm SEXTON-GERZOG
17,0 44-1604-17



cm POLITZER
16,0 44-1608-16



cm GARDINER BROWN
12,5 44-1690-12



cm GROSS
12,0 44-1700-12

scharf / stumpf
sharp / blunt
tranchant / mousse
cortante / romo
tagliente / smusso



cm GROSS
12,0 44-1701-12

stumpf/ stumpf
blunt / blunt
mousse / mousse
romo / romo
smusso / smusso

Ohröffel, Ohrschlingen
Ear Spoons, Ear Loops
Cuillers, Anses auriculaires
Cucharas, Asas auriculares
Cucchiai, Anse auricolari

Ohrlöffel, Ohrschlingen
 Ear Spoons, Ear Loops
 Cuillers, Anses auriculaires
 Cucharas, Asas auriculares
 Cucchiai, Anse auricolari

OTOLOGIE

OTOLOGY

OTOLOGIE

OTOLOGÍA

OTOLOGIA



cm FORMBY
 18,0 44-1703-18



cm MUSGROVE
 18,0 44-1705-18



cm SHAPHLEIGH
 13,0 44-1706-01
 13,0 44-1706-02



cm SHAPHLEIGH
 13,0 44-1707-01
 13,0 44-1707-02



cm BARKER 17,0 cm
 3 mm 44-1709-03
 4 mm 44-1709-04



44-1800-01

44-1800-02

44-1800-03

BILLEAU
 44-1800-01 - 44-1800-03



cm LANGENBECK
 13,0 44-1802-13



cm MOLDENHAUER
 16,0 44-1808-16



cm ZAUFAL
 15,0 44-1810-15

Ohrhäkchen, Ohrpinzetten
 Ear Hooklets, Ear Forceps
 Crochets auriculaires, Pinces auriculaire
 Ganchitos auriculares, Pinzas auriculares
 Uncinetti auricolari, Pinze auricolari

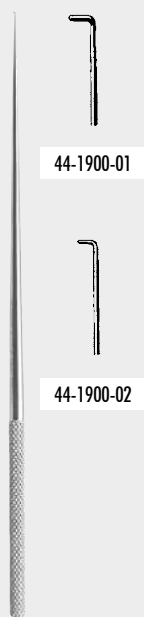

DAY
 44-1900-01 - 44-1900-02

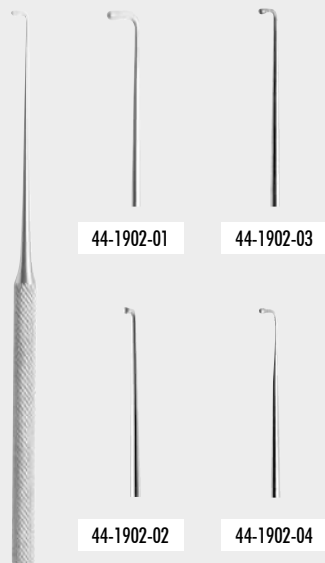

WAGENER
 44-1902-01 - 44-1902-04

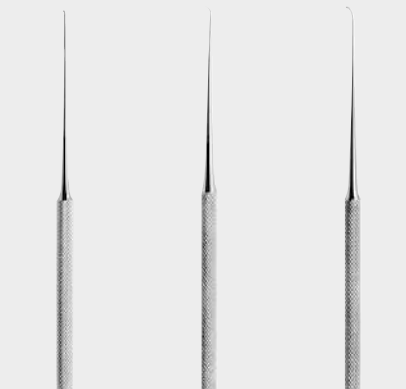

44-1902-05 44-1902-06 44-1902-07

OTOLOGIE

OTOLOGY

OTOLOGIE

OTOLOGÍA

OTOLOGIA

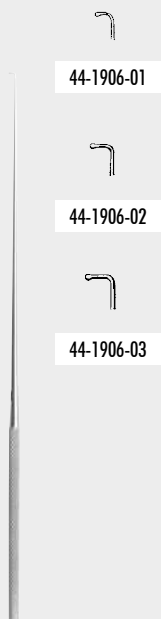

cm **LUCAE**
 14,0 44-1906-01 - 44-1906-03



cm **HARTMANN**
 16,0 44-1908-16



cm **CAWTHORNE**
 14,0 44-1909-14



cm **ST. BARTS**
 18,0 44-1911-18



Ohrpinzetten, Ohrpolypenschnürer
 Ear Forceps, Ear Polypus Snare
 Pincés auriculaires, Serre-nœud à polypes auriculaires
 Pinzas auriculares, Cierranudos para pólipos auriculares
 Pinze auricolari, Serranodi per polipi auricolari



OTOLOGIE

cm	WILDE (TROELTSCH)	cm	TROELTSCH (WILDE)	cm	LUCAE	cm	JANSEN	cm	LUCAE
12,0	44-2001-11 - 44-2003-11	13,0	44-2005-13	14,0	44-2006-14	16,0	44-2006-16 20,0 44-2006-20	14,0	44-2008-14

OTOLOGY

OTOLOGIE

OTOLOGÍA

OTOLOGIA

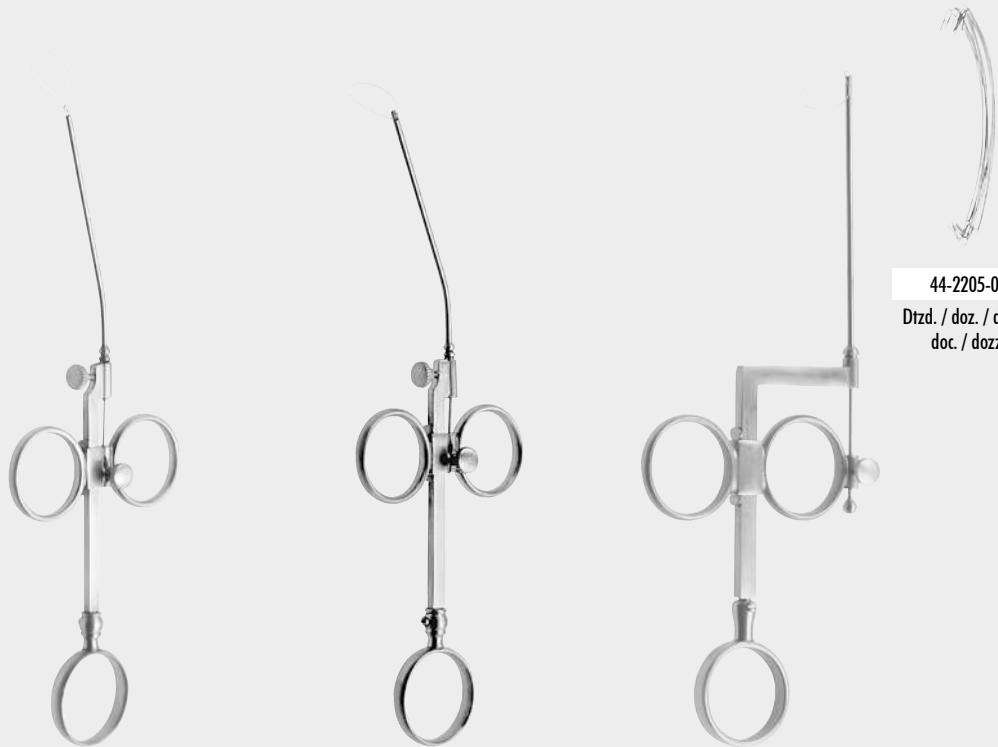

cm KRAUSE
16,0 44-2200-16

cm KRAUSE-VOSS
16,0 44-2201-16

cm WILDE
17,0 44-2202-17

44-2205-02
Dtzd. / doz. / douz /
doc. / dozz.



cm HARTMANN
12,0 44-2401-12



cm HARTMANN
14,0 44-2401-14



cm TILLEY
14,0 44-2403-14

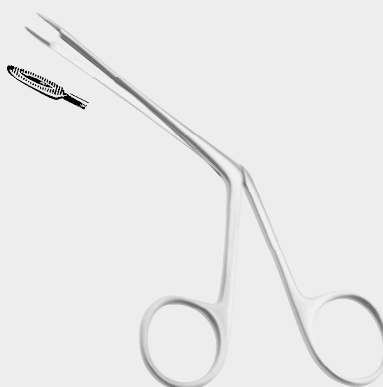

cm LITTAUER
12,0 44-2405-12



cm QUIRE
10,0 44-2501-10



cm BUCK
11,0 44-2503-11

Ohrzängchen
Ear Forceps
Pincès auriculaires
Pinzas auriculares
Pinze auricolari

OTOLOGIE

OTOLOGY

OTOLOGIE

OTOLOGÍA

OTOLOGIA

Fremdkörperhebel
Foreign Body Levers
Leviers pour corps étrangers
Elevadores para cuerpos extranjeros
Leve per corpi estranei

Ohrzängchen
Ear Forceps
Pincès auriculaires
Pinzas auriculares
Pinze auricolari

OTOLOGIE

OTOLOGY

OTOLOGIE

OTOLOGÍA

OTOLOGIA

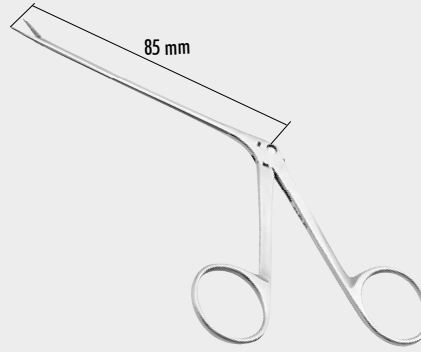

44-2505-08 - 44-2705-08



cm HARTMANN-WULLSTEIN
8,5 44-2505-08

cm HARTMANN-WULLSTEIN
8,5 44-2507-08

cm HARTMANN
8,5 44-2601-08
14,0 44-2601-14
16,0 44-2601-16

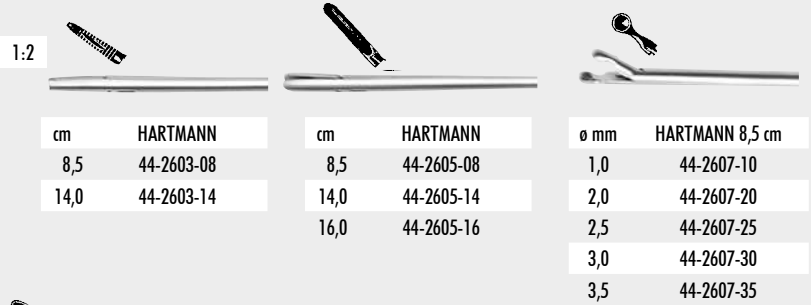

1:2
cm HARTMANN
8,5 44-2603-08
14,0 44-2603-14

cm HARTMANN
8,5 44-2605-08
14,0 44-2605-14
16,0 44-2605-16

ø mm HARTMANN 8,5 cm
1,0 44-2607-10
2,0 44-2607-20
2,5 44-2607-25
3,0 44-2607-30
3,5 44-2607-35

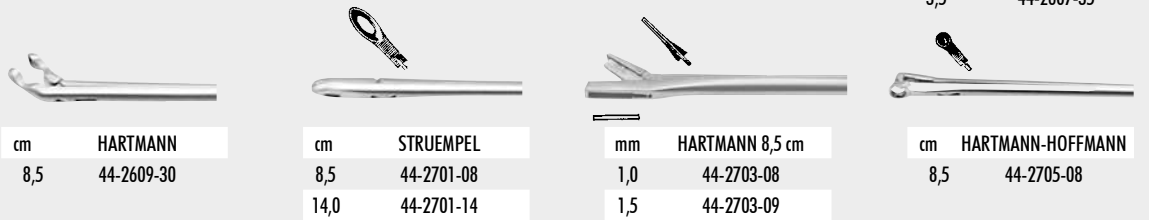

cm HARTMANN
8,5 44-2609-30

cm STRUEMPEL
8,5 44-2701-08
14,0 44-2701-14

mm HARTMANN 8,5 cm
1,0 44-2703-08
1,5 44-2703-09

cm HARTMANN-HOFFMANN
8,5 44-2705-08



cm HENCKEL
8,5 44-2707-08
2,5 mm x 5,0 mm

cm HARTMANN NOYES
8,5 44-2710-08

cm HARTMANN NOYES
8,5 44-2712-08

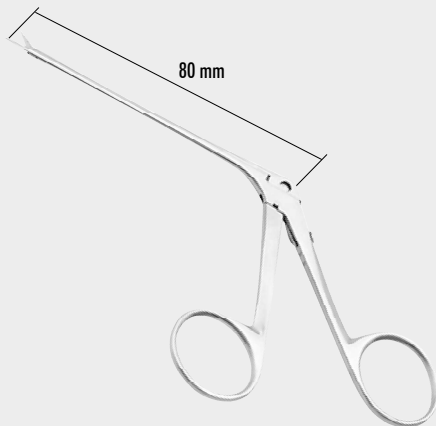

44-3100-40 - 44-3202-70

Mikro-Ohrscherchen
Micro Ear Scissors
Ciseaux auriculaires micro
Tijeras auriculares micro
Forbici auricolari micro



BELLUCCI
44-3100-40
micro mini
4,0 mm



BELLUCCI
44-3102-55
micro standard
5,5 mm



BELLUCCI
44-3103-55
micro standard
5,5 mm



« BELLUCCI
44-3105-55
micro standard
5,5 mm

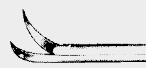

» BELLUCCI
44-3107-55
micro standard
5,5 mm



SHEA
44-3200-70
7,0 mm



« SHEA
44-3201-70
7,0 mm



» SHEA
44-3202-70
7,0 mm

OTOLOGIE

OTOLOGY

OTOLOGIE

OTOLOGÍA

OTOLOGIA



44-3490-40
0,6 mm x 4,0 mm



44-3492-40
0,6 mm x 4,0 mm

Ohrzängchen
Ear Forceps
Pinces auriculaires
Pinzas auriculares
Pinze auricolari

Mikro-Ohrzängchen
 Micro Ear Forceps
 Pincès auriculaires micro
 Pinzas auriculares micro
 Pinze auricolari micro

OTOLOGIE

OTOLOGY

OTOLOGIE

OTOLOGÍA

OTOLOGIA

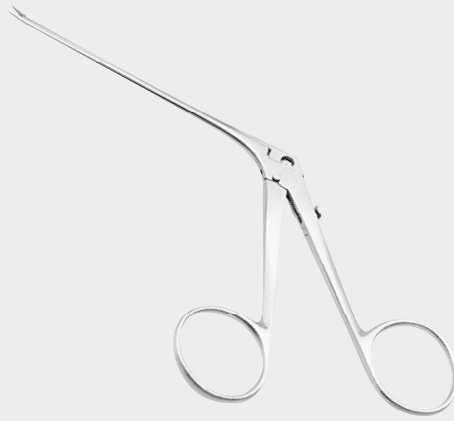

44-3500-40 - 44-3600-35



44-3500-40
4 mm



44-3500-70
7,0 mm



44-3502-40
4,0 mm



44-3503-60
6,0 mm
«

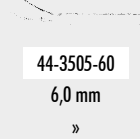

44-3505-60
6,0 mm
»



44-3507-40
4,0 mm



44-3509-40
4,0 mm



44-3600-35
3,5 mm



44-3602-45
4,5 mm



44-3603-45
4,5 mm
«



44-3605-45
4,5 mm
»

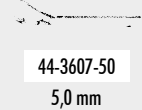

44-3607-50
5,0 mm

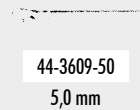

44-3609-50
5,0 mm



GREVEN
44-3700-50
5,0 mm



McGEE
44-3701-40
0,8 x 4,0 mm

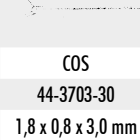

COS
44-3703-30
1,8 x 0,8 x 3,0 mm



« JUERS
44-3705-60
6,0 mm



» JUERS
44-3707-60
6,0 mm



« HAUGH
44-3801-30
45° 3,0 mm



» HAUGH
44-3803-30
45° 3,0 mm



44-3602-45 - 44-3803-30



DIETER
44-3805-01 - 44-3807-02

DIETER

micro
44-3805-01

aufwärts
upward
vers le haut
hacia arriba
in alto

DIETER

micro
44-3805-02

abwärts
downward
vers le bas
hacia abajo
in basso

DIETER

mini
44-3807-01

DIETER

mini
44-3807-02

Hammerkopf-Zwickzängchen
Malleus Nippers
Pinces pour couper la tête du marteau
Pinzas para cortar la cabeza del martillo
Pinze per tagliare la testa del martello

OTOLOGIE

OTOLOGY

OTOLOGIE

OTOLOGÍA

OTOLOGIA

Mikro-Ohrzängchen
 Micro Ear Forceps
 Pinces auriculaires micro
 Pinzas auriculares micro
 Pinze auricolari micro

44-4100-00



44-4102-00



44-4103-00



44-4105-00



44-4107-00



44-4109-00



Modelle mit Ringgriff (RG)
 Ring Handle Style (RG)
 Modèles manches à anneaux (RG)
 Modelos mangos con anillos (RG)
 Modelli manici con anelli (RG)

OTOLOGIE

OTOLOGY

OTOLOGIE

OTOLOGÍA

OTOLOGIA



44-4100-00 - 44-4109-00

micro

RG

44-4200-00



44-4202-00



44-4203-00



44-4205-00



44-4207-00



44-4209-00

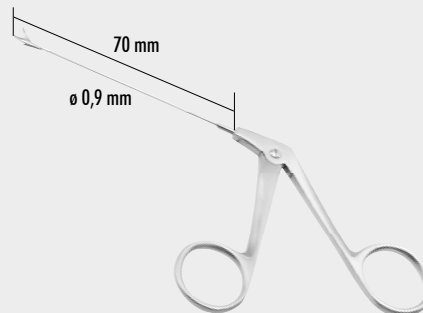
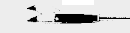

44-4200-00 - 44-4209-00

micro-mini

RG

Modelle mit Ringgriff (RG)
 Ring Handle Style (RG)
 Modèles manches à anneaux (RG)
 Modelos mangos con anillos (RG)
 Modelli manici con anelli (RG)



44-5100-00 - 44-5409-00

micro

RG

Mikro-Ohrzängchen
 Micro Ear Forceps
 Pinces auriculaires micro
 Pinzas auriculares micro
 Pinze auricolari micro

44-5100-00



44-5101-00



»

44-5103-00



«

44-5104-00



44-5105-00

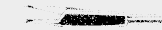

44-5106-00



»

44-5107-00



«

44-5109-00



44-5200-00



44-5201-00



ø 1,0 mm ø 1,5 mm ø 2,0 mm ø 2,5 mm

44-5202-00 44-5208-00 44-5304-00 44-5400-00



44-5203-00 44-5209-00 44-5305-00 44-5401-00



»

44-5205-00 44-5301-00 44-5307-00 44-5403-00



«

44-5207-00 44-5303-00 44-5309-00 44-5405-00



44-5406-00



44-5407-00



»

44-5408-00



«

44-5409-00



OTOLOGIE

OTOLOGY

OTOLOGIE

OTOLOGÍA

OTOLOGIA



Modelle mit Ringgriff (RG)
 Ring Handle Style (RG)
 Modèles manches à anneaux (RG)
 Modelos mangos con anillos (RG)
 Modelli manici con anelli (RG)



44-5500-00 - 44-5809-00
 micro-mini
 RG

Mikro-Ohrzängchen
 Micro Ear Forceps
 Pincès auriculaires micro
 Pinzas auriculares micro
 Pinze auricolari micro





OTOLOGIE

OTOLOGY

OTOLOGIE

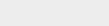
OTOLOGÍA

OTOLOGIA

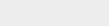
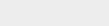
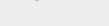
- 44-5500-00 
- 44-5501-00 
- 44-5503-00  »
- 44-5504-00  «
- 44-5505-00 
- 44-5506-00 
- 44-5507-00  »
- 44-5509-00  «
- 44-5600-00 
- 44-5601-00 
- 44-5602-00 
- 44-5603-00 
- 44-5605-00 
- 44-5607-00 
- 44-5806-00 
- 44-5807-00 
- 44-5808-00  »
- 44-5809-00  «

Instrumente für die Ohr-Mikrochirurgie
 Instruments for Ear Micro Surgery
 Instruments pour la microchirurgie de l'ouïe
 Instrumentos para la microcirugía del oído
 Strumenti per la microchirurgia auricolare

SCHUKNECHT 44-7001-01
 SCHUKNECHT 44-7001-02
 cm 15,5 SCHUKNECHT 44-7003-15
 cm 15,5 WULLSTEIN 44-7004-15
 cm 15,5 TABB 44-7005-15
 cm 15,5 PLESTER 44-7006-35
 ø 3,5 mm

OTOLOGIE

44-7009-10 1,0 mm
 44-7009-14 1,4 mm
 44-7009-16 1,6 mm
 44-7009-20 2,0 mm

OTOLOGY

OTOLOGIE

44-7009-26 2,6 mm
 44-7009-28 2,8 mm
 44-7009-30 3,0 mm

OTOLOGÍA

ROSEN
 44-7009-10 - 44-7009-30

BARBARA 44-7100-15
 BARBARA 44-7101-15
 BARBARA 44-7103-15
 ROSEN 44-7105-15

OTOLOGIA

44-7100-15 - 44-7205-10

	25°	45°	90°	
mm	BARBARA	BARBARA	BARBARA	BARBARA
0,3	44-7200-03	44-7202-03	44-7204-03	44-7205-05 = 0,5 mm
0,6	44-7200-06	44-7202-06	44-7204-06	44-7205-10 = 1,0 mm
0,8	44-7200-08	44-7202-08		
1,0	44-7200-10	44-7202-10	44-7204-10	
1,2		44-7202-12	44-7204-12	
1,5		44-7202-15	44-7204-15	
2,0		44-7202-20	44-7204-20	
2,5		44-7202-25	44-7204-25	



Instrumente für die Ohr-Mikrochirurgie
 Instruments for Ear Micro Surgery
 Instruments pour la microchirurgie de l'ouïe
 Instrumentos para la microcirugía del oído
 Strumenti per la microchirurgia auricolare

aufwärts
upward
en haut
hacia arriba
in alto

abwärts
downward
en bas
hacia abajo
in basso

aufwärts
upward
en haut
hacia arriba
in alto

abwärts
downward
en bas
hacia abajo
in basso



mm	90°	90°
0,3	44-7300-03	44-7302-03
0,6	44-7300-06	44-7302-06
1,0	44-7300-10	44-7302-10

mm	McGEE	McGEE
0,5	44-7303-05	44-7305-05
1,0	44-7303-10	44-7305-10

cm	BARBARA
15,5	44-7306-15

aufwärts
upward
en haut
hacia arriba
in alto

abwärts
downward
en bas
hacia abajo
in basso

aufwärts
upward
en haut
hacia arriba
in alto

abwärts
downward
en bas
hacia abajo
in basso



cm	ROSEN
15,5	44-7307-15

mm	25°	25°	45°	45°
0,3	44-7401-03	44-7403-03	44-7405-03	44-7407-03
0,6	44-7401-06	44-7403-06	44-7405-06	44-7407-06
1,0	44-7401-10	44-7403-10	44-7405-10	44-7407-10

OTOLOGIE

OTOLOGY

OTOLOGIE

OTOLOGÍA

OTOLOGIA



mm	SHAMBAUGH 45°
0,4	44-7411-04
0,6	44-7411-06
0,8	44-7411-08
1,0	44-7411-10



mm	SHAMBAUGH 90°
0,4	44-7413-04
0,6	44-7413-06
0,8	44-7413-08
1,0	44-7413-10



FISCH
44-7501-16 - 44-7507-16



44-7501-16 44-7503-16

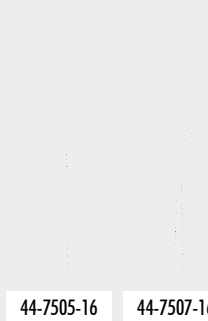

44-7505-16 44-7507-16



cm	SHEA
16,0	44-7508-16





mm SHEA 16,0 cm
1,5 x 2,5 44-7510-16



HOUSE
44-7600-01 - 44-7602-02

mm
1,0 / 1,2 44-7600-01
1,5 / 1,8 44-7600-02

mm
1,0 / 1,2 44-7602-01
1,5 / 1,8 44-7602-02



cm HOUSE
15,0 44-7604-15

ø 1,0 mm

ø 1,2 mm

cm HOUSE 17,0 cm
17,0 44-7604-17



cm ANTOLI CANDELA
15,0 44-7605-15

Instrumente für die Ohr-Mikrochirurgie
Instruments for Ear Micro Surgery
Instruments pour la microchirurgie de l'ouïe
Instrumentos para la microcirugía del oído
Strumenti per la microchirurgia auricolare

OTOLOGIE

OTOLOGY

OTOLOGIE

OTOLOGÍA

OTOLOGIA



HOUSE
44-7606-35 - 44-7606-50

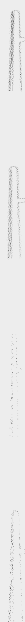

44-7606-35
3,5 mm

44-7606-40
4,0 mm

44-7606-45
4,5 mm

44-7606-50
5,0 mm



LEMPERT
44-8002-16 - 44-8005-16

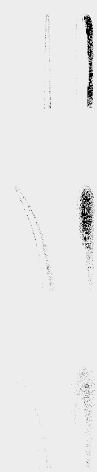

44-8002-16
2,0 mm

44-8003-16
2,0 mm

44-8005-16
3,0 mm

Instrumente für die Ohr-Mikrochirurgie
 Instruments for Ear Micro Surgery
 Instruments pour la microchirurgie de l'ouïe
 Instrumentos para la microcirugía del oído
 Strumenti per la microchirurgia auricolare

OTOLOGIE

OTOLOGY

OTOLOGIE

OTOLOGÍA

OTOLOGIA



cm LEMPERT
20,5 44-8007-20

Raspatorium
 Periosteal Elevator
 Rugine-raspatoire
 Elevador de periostio
 Elevatore di periostio



cm LEMPERT
18,0 44-8009-18



Fig. BEALES
1 44-8011-01
16,0 cm



Fig. BEALES
2 44-8011-02
16,0 cm



mm LEMPERT
3,0 44-8015-03
16,0 cm



mm PASSOW
2 x 2 44-8100-02
3 x 3 44-8100-03

Blutstillungsmeissel
 Hemostat
 Ciseau hémostatique
 Cíncel hemostático
 Scalpello emostatico



cm MUCK
13,0 44-8102-13

Periostmesser
 Periosteal Knife
 Couteau à périoste
 Cuchillo de periostio
 Coltello per periostio

RHINOLOGIE

RHINOLOGY

RHINOLOGIE

RINOLOGÍA

RINOLOGIA



Nasenspekula
 Nasal Specula
 Spéculums nasaux
 Espéculos nasales
 Specoli nasali

RHINOLOGIE

RHINOLOGY

RHINOLOGIE

RINOLOGÍA

RINOLOGIA

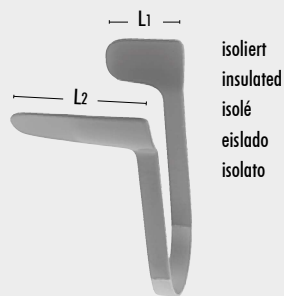
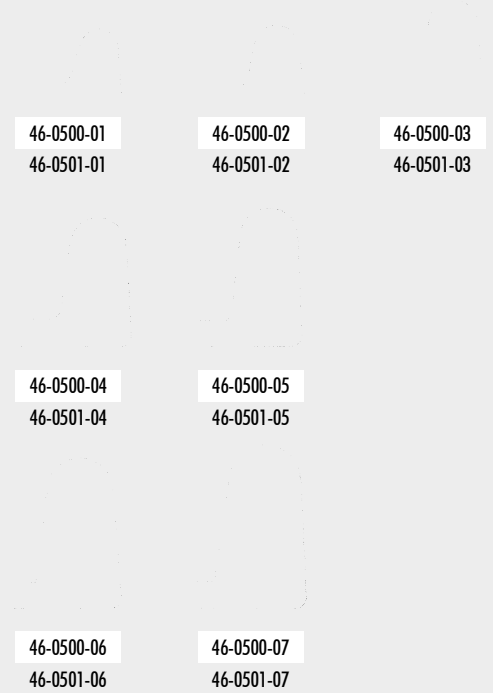
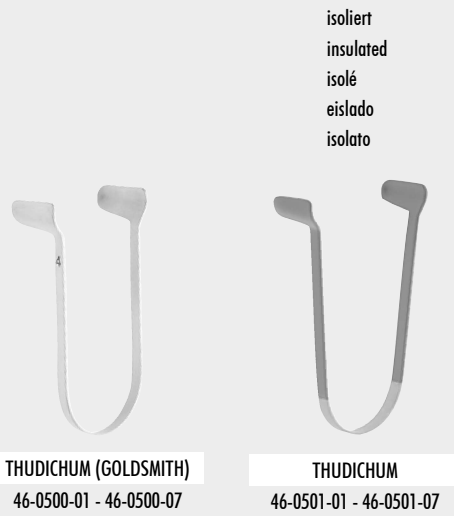

SHAH	
46-0502-01	46-0502-02
L1 50,0 mm	L1 30,0 cm
L2 30,0 mm	L2 50,0 cm



x = mm	ST. CLAIR THOMSON
38,0	46-0506-38
51,0	46-0506-51
64,0	46-0506-64
76,0	46-0506-76

Nasenspekula
 Nasal Specula
 Spéculums nasaux
 Espéculos nasales
 Specoli nasali



VOLTOLINI (DUPLAY)
 46-0600-01 - 46-0600-03



46-0600-01
 Fig. 1



46-0600-02
 Fig. 2



46-0600-03
 Fig. 3

RHINOLOGIE

RHINOLOGY

RHINOLOGIE

RINOLOGÍA

RINOLOGIA



46-1002-01
 Fig. 1

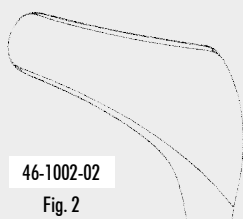

46-1002-02
 Fig. 2

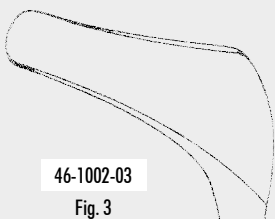

46-1002-03
 Fig. 3



cm **HARTMANN-HALLE**
 15,0 46-1002-01 - 46-1002-03

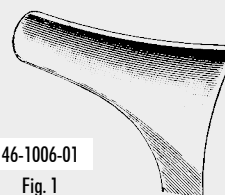

46-1006-01
 Fig. 1

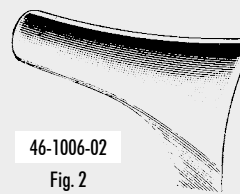

46-1006-02
 Fig. 2

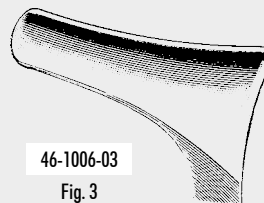

46-1006-03
 Fig. 3



cm **HARTMANN**
 15,0 46-1006-01 - 46-1006-03

Nasenspekula
 Nasal Specula
 Spécule nasaux
 Espéculos nasales
 Specoli nasali

RHINOLOGIE



cm SONNENSCHNEIN
 14,0 46-1008-15



cm MARTIN
 13,0 46-1012-01



cm BECKMANN (MARTIN)
 15,0 46-1013-01

RHINOLOGY

RHINOLOGIE

RINOLOGÍA

RINOLOGIA



BECKMANN
 46-1015-00 - 46-1015-03

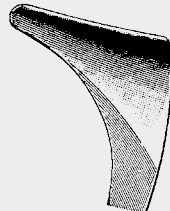

cm
 14,0 46-1015-00

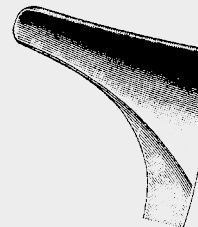

cm
 15,0 46-1015-02



cm
 14,0 46-1015-01

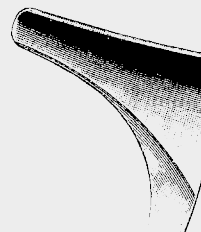

cm
 15,0 46-1015-03



mit Kaltlicht
with fibre light
à lumière froide
con luz fría
con luce fredda

Nasenspekula
Nasal Specula
Spéculums nasaux
Espéculos nasales
Specoli nasali

RHINOLOGIE

RHINOLOGY

RHINOLOGIE

RINOLOGÍA

RINOLOGIA

Mod. Wien Vienna Vienne Viena					
Baby	Bebe				46-1102-01
Kind	child	enf.	niño	bamb	46-1102-02
Erw.	Adult				46-1102-03

cm	Mod. Wien Vienna Vienne Viena	
11,0		46-1102-11
12,0		46-1102-12
13,0		46-1102-13



Mod. Wien Vienna Vienne Viena	
46-1103-03	leichtes Modell light weight modèle léger modelo ligero modello leggero

cm	TIECK-HALLE
13,5	46-1106-13

cm	CARDIFF
13,0	46-1110-13

cm	PILCHER
15,0	46-1120-15

Nasen-, Septumspekula
 Nasal, Septum Specula
 Spéculems nasaux et de cloison
 Espéculos nasales y de tabique
 Specoli nasali e di setto

RHINOLOGIE

RHINOLOGY

RHINOLOGIE

RINOLOGÍA

RINOLOGIA



cm KILLIAN
 13,0 46-1200-35 - 46-1200-90

46-1200-35
 35 mm

46-1200-50
 50 mm

46-1200-75
 75 mm

46-1200-90
 90 mm

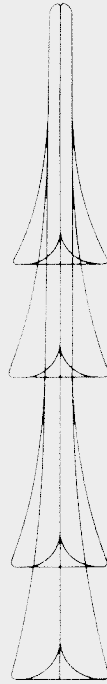

mit Kaltlicht
 with fibre light
 à lumière froide
 con luz fría
 con luce fredda

46-1202-35
 35 mm

46-1202-50
 50 mm

46-1202-75
 75 mm

46-1202-90
 90 mm



cm KILLIAN
 13,0 46-1202-35 - 46-1202-90

mit Kaltlicht - with fibre light -
 à lumière froide - con luz fría - con luce fredda
 STORZ / WOLF / OLYMPUS



cm COTTLE
 14,0 46-1204-35 - 46-1204-90



cm COTTLE
 14,0 46-1206-35 - 46-1206-90
 laser

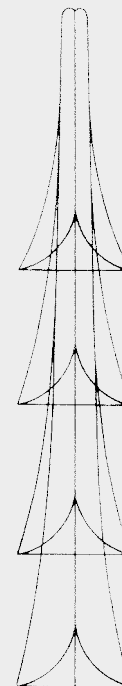

46-1204-35
 46-1206-35
 35 mm

46-1204-50
 46-1206-50
 50 mm

46-1204-75
 46-1206-75
 75 mm

46-1204-90
 46-1206-90
 90 mm



Nasenrachen-Spekulum
 Nasopharyngeal Speculum
 Spéculum nasopharyngien
 Espéculo nasofaringeal
 Specolo nasofaringeale

cm YANKAUER
 19,0 46-1301-19



cm MICHEL
 25,0 46-1309-12 - 46-1309-18



46-1309-12
 12 mm



46-1309-14
 14 mm



46-1309-16
 16 mm



46-1309-18
 18 mm

Postrhinoskopie-Spiegel - Mirror Post-Rhinoscopic
 Miroir postrhinoscopique - Espejo postrinoscópico
 Specchio postrinoscopico



ø mm	St. CLAIRE THOMSON
8,0	46-1311-08
10,0	46-1311-10
12,0	46-1311-12
14,0	46-1311-14
16,0	46-1311-16
18,0 cm	

RHINOLOGIE

RHINOLOGY

RHINOLOGIE

RINOLOGÍA

RINOLOGIA



Mit TC-Einsätzen
 TC Lined
 A mors TC
 Con bocas TC
 Con morso TC

Nasenpinzetten
 Nasal Forceps
 Pincas nasales
 Pinzas nasales
 Pinze nasali

RHINOLOGIE

RHINOLOGY

RHINOLOGIE

RINOLOGÍA

RINOLOGIA

Nasenzangen
 Nasal Forceps
 Pincas nasales
 Pinzas nasales
 Pinze nasali



cm	TROELTSCH
15,0	46-1501-15
18,0	46-1501-18



cm	JANSEN (GRÜNWALD)
18,5	46-1504-18
20,0	46-1504-20



cm	GRÜNWALD
20,0	46-1506-20



cm	HARTMANN
16,0	46-1601-16



cm	HARTMANN
20,0	46-1601-20



cm	TILLEY
17,0	46-1603-17



Nasenzangen
Nasal Forceps
Pinces nasales
Pinzas nasales
Pinze nasali

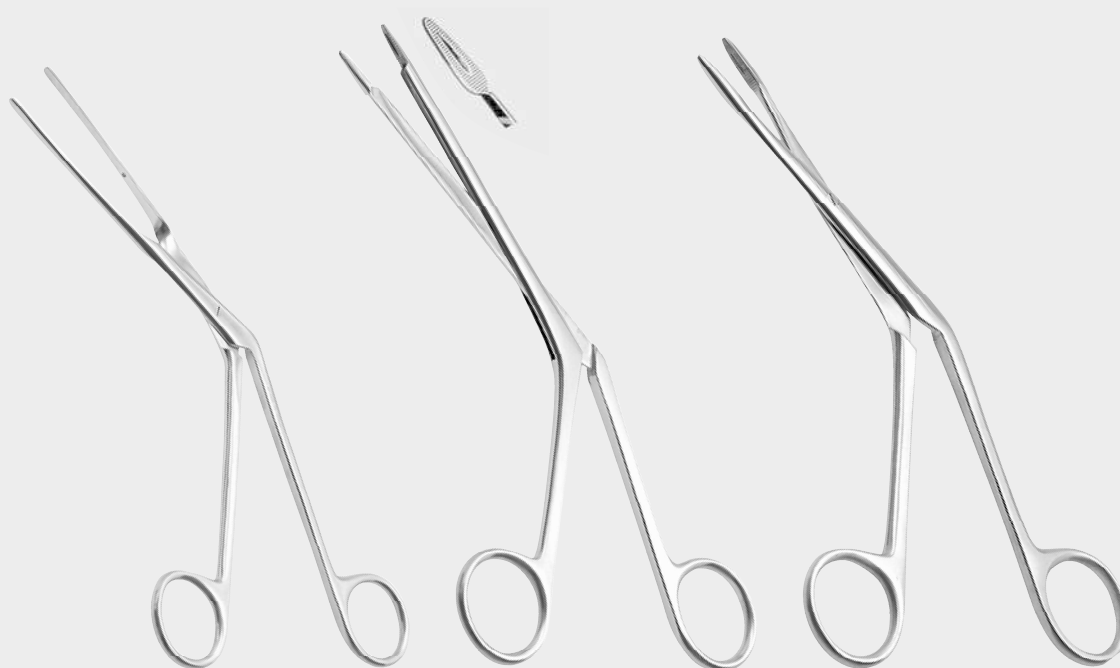

cm LUBET-BARBON
20,0 46-1605-20

cm LITTAUER
18,0 46-1607-18

cm HEYMANN-KNIGHT
18,0 46-1609-18

RHINOLOGIE

RHINOLOGY

RHINOLOGIE

RINOLOGÍA

RINOLOGIA

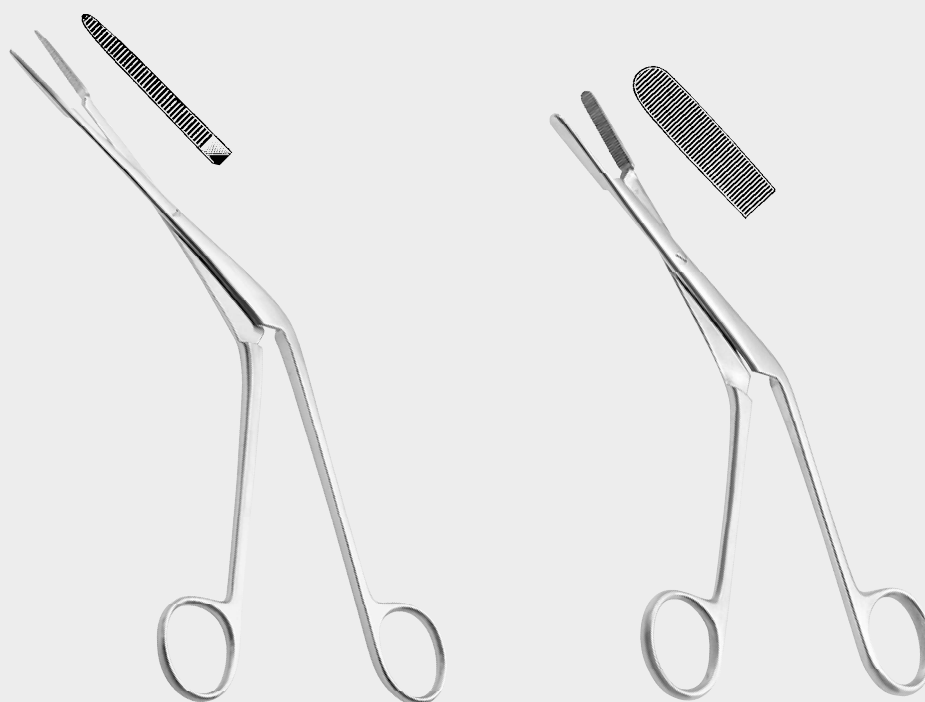

cm WESTMACOTT
20,0 46-1611-20

cm KILLIAN
17,0 46-1613-17

Nasenzangen
Nasal Forceps
Pincas nasales
Pinzas nasales
Pinze nasali



cm CRAIG
18,0 46-1615-18



46-1621-18 46-1623-18

cm
18,0 46-1621-18 - 46-1623-18

RHINOLOGIE

RHINOLOGY

RHINOLOGIE

RINOLOGÍA

RINOLOGIA

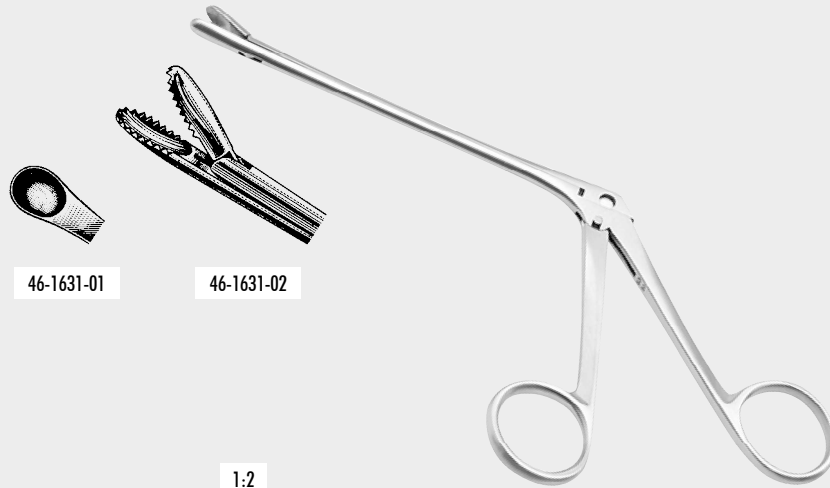

46-1631-01

46-1631-02

WATSON WILLIAMS
46-1631-01 - 46-1631-02



46-1701-14

1:2



46-1703-14



cm NOYES
14,5 46-1701-14 - 46-1703-14

Nasenzangen
Nasal Forceps
Pincas nasales
Pinzas nasales
Pinze nasali



46-1801-01



46-1801-02



46-1801-03



cm HEYMANN
18,0 46-1801-01 - 46-1801-03



cm HARTMANN
19,0 46-1710-19

RHINOLOGIE

RHINOLOGY

RHINOLOGIE

RINOLOGÍA

RINOLOGIA



46-1901-01

46-1901-02

46-1901-03



46-1901-04

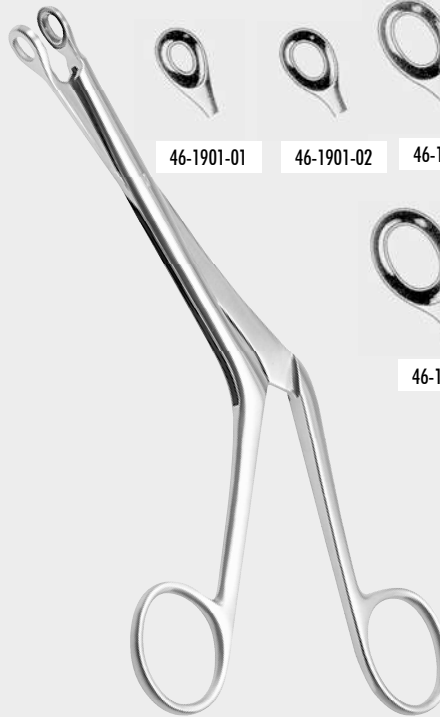

cm BRUENINGS
19,0 46-1901-01 - 46-1901-04



cm KNIGHT
18,0 46-1805-18

Nasenzangen
 Nasal Forceps
 Pincas nasales
 Pinzas nasales
 Pinze nasali

RHINOLOGIE

RHINOLOGY

RHINOLOGIE

RINOLOGÍA

RINOLOGIA



mm	LUC 20,0 cm
6	46-1903-01
7,5	46-1903-02
9	46-1903-03

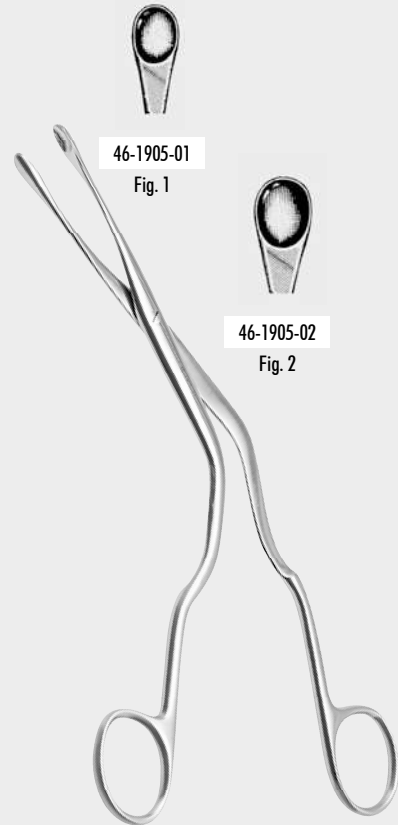

46-1905-01
 Fig. 1

46-1905-02
 Fig. 2

cm	LUC
20,0	46-1905-01 - 46-1905-02

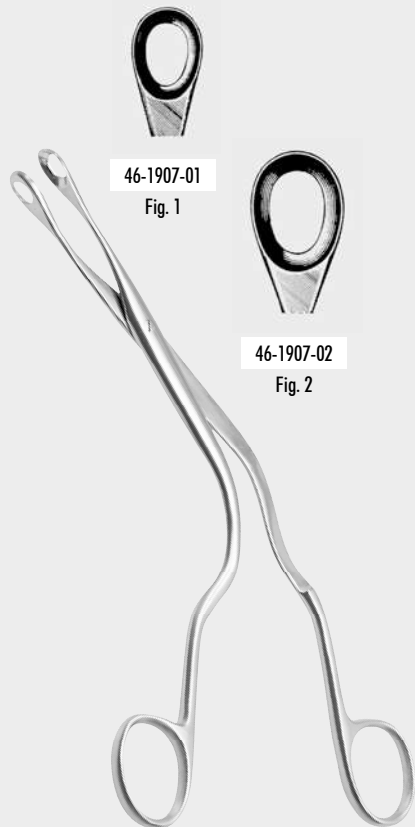

46-1907-01
 Fig. 1

46-1907-02
 Fig. 2

cm	LUC
20,0	46-1907-01 - 46-1907-02



cm	IRWIN-MOORE
19,0	46-1909-19







ohne Hals
without neck
sans cou
sin cuello
senza collo

					
46-2201-01	46-2201-02	46-2201-03	46-2201-04	46-2201-04	46-2201-05
Fig. 1	Fig. 2	Fig. 3	Fig. 4	Fig. 4	Fig. 5
2,5 mm	3,6 mm	4,8 mm	5,3 mm	5,3 mm	6,3 mm

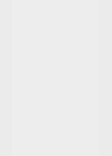

mit Hals
with neck
avec cou
con cuello
con collo

					
46-2203-01	46-2203-02	46-2203-03	46-2203-04	46-2203-04	46-2203-05
Fig. 1	Fig. 2	Fig. 3	Fig. 4	Fig. 4	Fig. 5
2,5 mm	3,6 mm	4,8 mm	5,3 mm	5,3 mm	6,3 mm

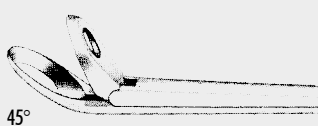

45°

		
46-2209-02	46-2209-03	46-2209-04
Fig. 2	Fig. 3	Fig. 4
3,6 mm	4,8 mm	5,3 mm

aufwärts schneidend
cutting upward
coupant vers le haut
cortante hacia arriba
tagliante verso il alto

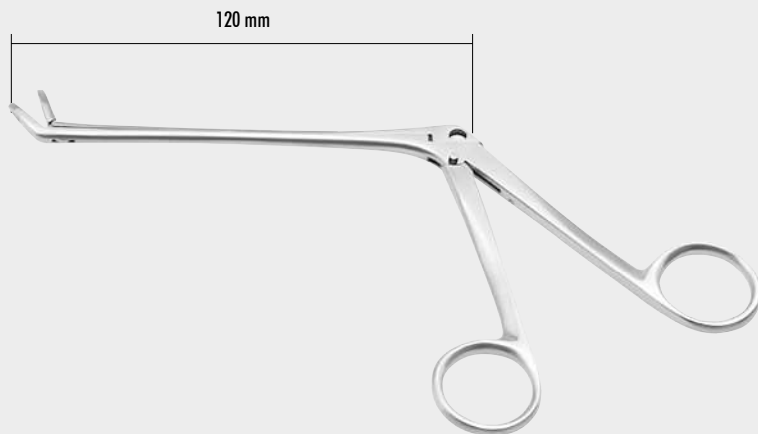

120 mm

Gesamtlänge 19 cm
Overall Length 19 cm
Longueur totale 19 cm
Largo total 19 cm
Lunghezza totale 19 cm

WEIL-BLAKESLEY
46-2201-01 - 46-2209-04



BLAKESLEY WILDE 90°
46-2210-01 2,5 mm
46-2210-02 3,6 mm
46-2210-03 4,8 mm

Scharfe Nasenzangen
Nasal Cutting Forceps
Pincas coupantes pour le nez
Pinzas cortantes para la nariz
Pinze taglianti per il naso

RHINOLOGIE

RHINOLOGY

RHINOLOGIE

RINOLOGÍA

RINOLOGIA



Scharfe Nasenzangen
 Nasal Cutting Forceps
 Pincès coupantes pour le nez
 Pinzas cortantes para la nariz
 Pinze taglienti per il naso

RHINOLOGIE

RHINOLOGY

RHINOLOGIE

RINOLOGÍA

RINOLOGIA

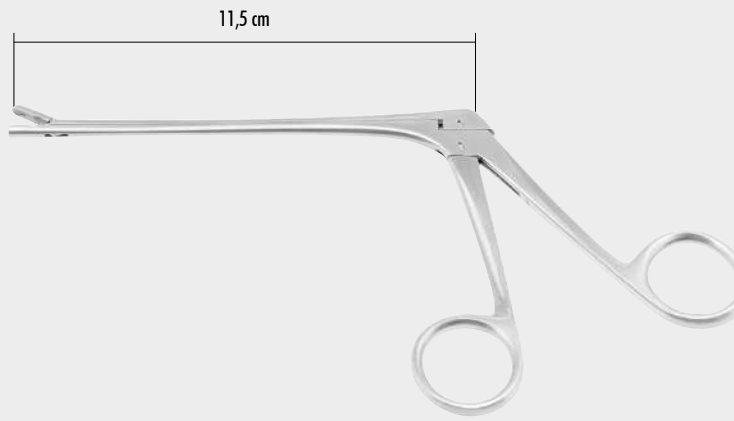

mm	St. BARTHOLOMEW
3,0	46-2211-01
	11,5 cm

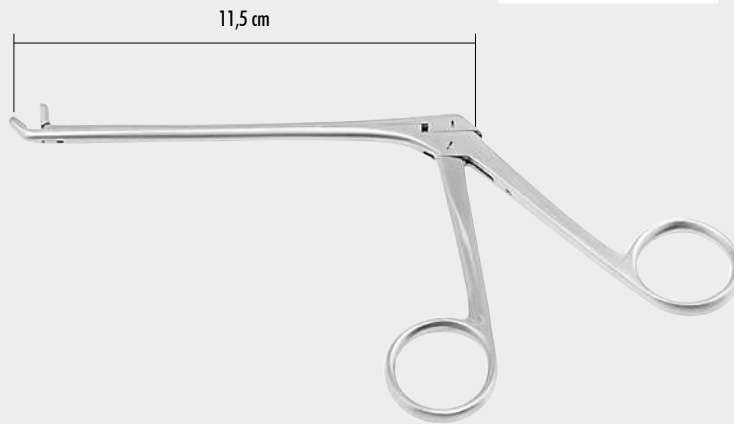

mm	St. BARTHOLOMEW
3,0	46-2211-02
	140° / 11,5 cm

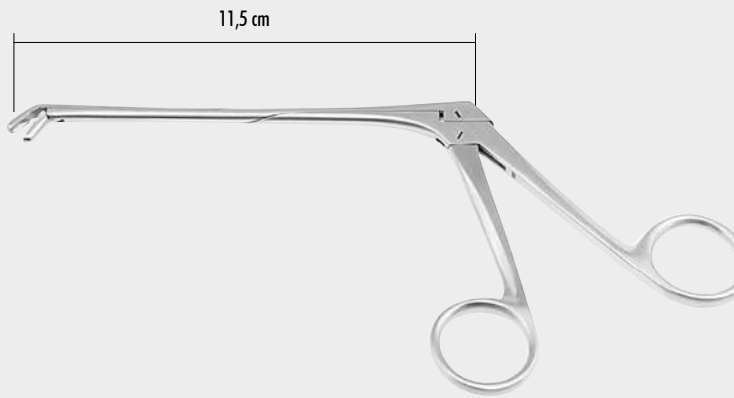

mm	St. BARTHOLOMEW
3,0	46-2211-03
	140° / 11,5 cm

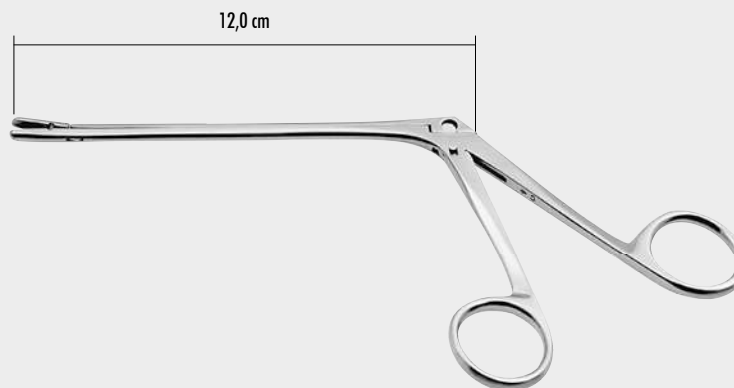

cm	—	TAKAHASHI	—
12,0	46-2218-01		46-2218-02

Scharfe Nasenzangen
 Nasal Cutting Forceps
 Pincès coupantes pour le nez
 Pinzas cortantes para la nariz
 Pinze taglianti per il naso



STRUYCKEN
 46-2301-01
 Fig. 1/0,9 mm



STRUYCKEN
 46-2301-02
 Fig. 2/1,2 mm



46-2307-01
 5 mm



46-2307-02
 7 mm



46-2307-03
 9 mm



46-2305-05



46-2305-07



46-2305-09



46-2305-11



HARTMANN



MYLES
 46-2307-01
 46-2307-02
 46-2307-03



SCHMEDEN
 46-2306-12



cm
 19,0 46-2301-01 - 46-2307-03

RHINOLOGIE

RHINOLOGY

RHINOLOGIE

RINOLOGÍA

RINOLOGIA



Mit TC-Einsätzen
 TC Lined
 A mors TC
 Con bocas TC
 Con morso TC

Septum-Quetschzangen
 Septum Crushing Forceps
 Pincés à écraser la cloison
 Pinzas para magullar tabique
 Pinze per ammaccare il setto

RHINOLOGIE

RHINOLOGY

RHINOLOGIE

RINOLOGÍA

RINOLOGIA



cm
 19,5 46-2484-19



cm RUBIN WRIGHT
 19,5 46-2490-19



cm RUBIN
 21,0 46-2501-21
 21,0 46-2502-21



cm KRESSNER
 20,0 46-2503-20

46-2501-99

Schutzkappe allein
 Protecting Hood only
 Protecteur seul
 Protector suelto
 Protettore solo

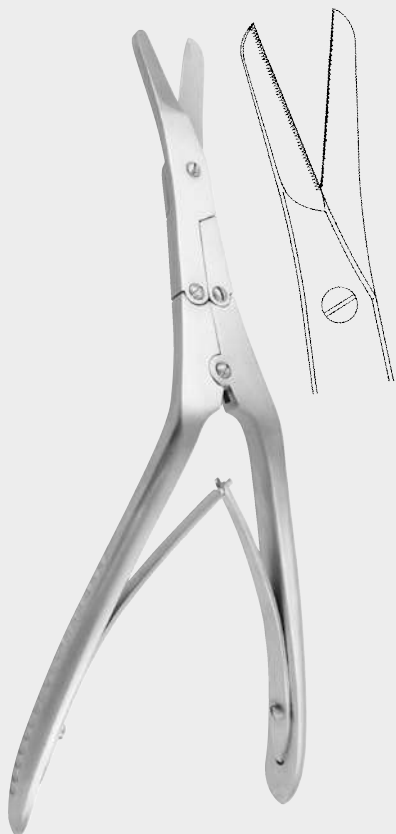

cm CAPLAN
20,0 46-2520-20

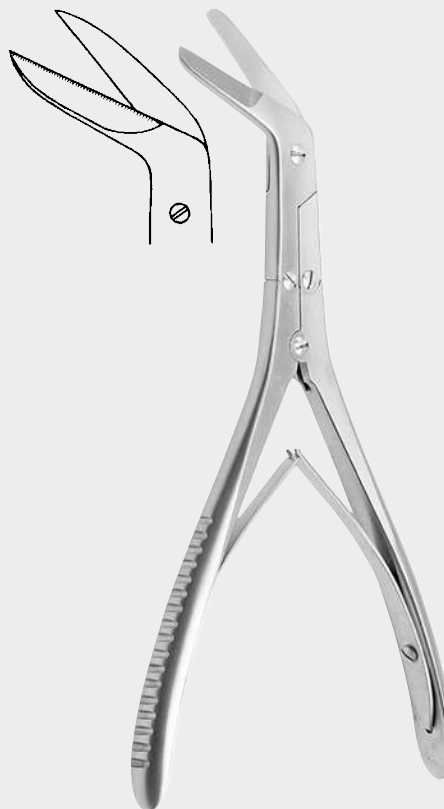

cm KILLIAN
21,0 46-2523-21

Septum-Scheren, Stanzen
Septum Scissors, Punches
Ciseaux à cloison, Pincas emporte-pièces
Tijeras para tabique, pinzas sacabocados
Forbici per setto, pinze taglianti

RHINOLOGIE

RHINOLOGY

RHINOLOGIE

RINOLOGÍA

RINOLOGIA



mm x mm	KERRISON
3 x 3	46-3003-03
4 x 4	46-3003-04
5 x 5	46-3003-05
6 x 6	46-3003-06

17,0 cm

HAJEK-KOFLER
46-3005-01 - 46-3005-02

Septum-Scheren, Stanzen
 Septum Scissors, Punches
 Ciseaux à cloison, Pinces emporte-pièces
 Tijeras para tabique, pinzas sacabocados
 Forbici per setto, pinze taglianti

RHINOLOGIE

RHINOLOGY

RHINOLOGIE

RINOLOGÍA

RINOLOGIA

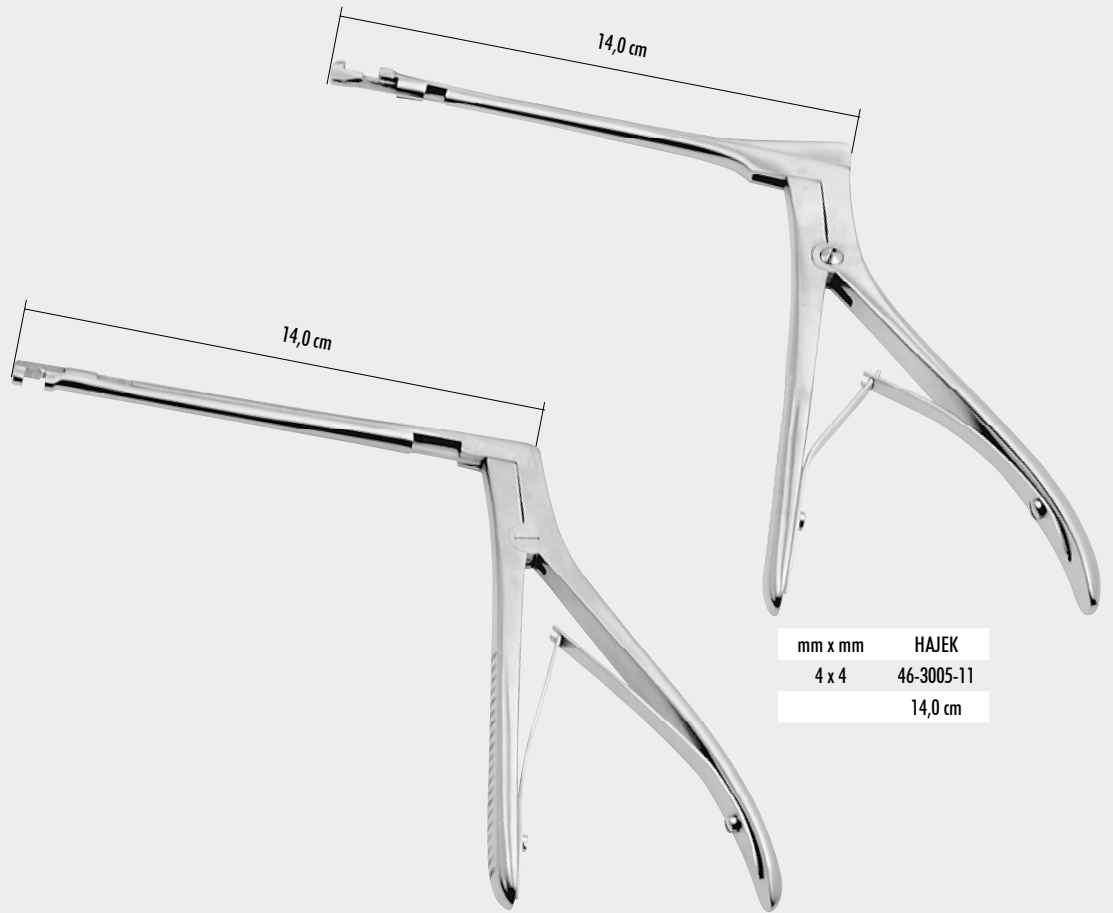

mm x mm	HAJEK
4 x 4	46-3005-11
	14,0 cm



mm x mm	HAJEK
4 x 4	46-3005-12
	14,0 cm



mm	HAJEK-KOFLER
3,5	46-3007-35
	360 rot. / 17,0 cm

ZEPF®
α
 INSTRUMENTS

46-3005-11

46.18

mm	KOFLER
3,0	46-3009-30
	360 rot. / 15,0 cm



mm	HAJEK
4,0	46-3011-40
	14,0 cm



mm	HAJEK
4,0	46-3013-40
	14,0 cm

Septum-Scheren, Stanzen
 Septum Scissors, Punches
 Ciseaux à cloison, Pinces emporte-pièces
 Tijeras para tabique, pinzas sacabocados
 Forbici per setto, pinze taglianti

RHINOLOGIE

RHINOLOGY

RHINOLOGIE

RINOLOGÍA

RINOLOGIA

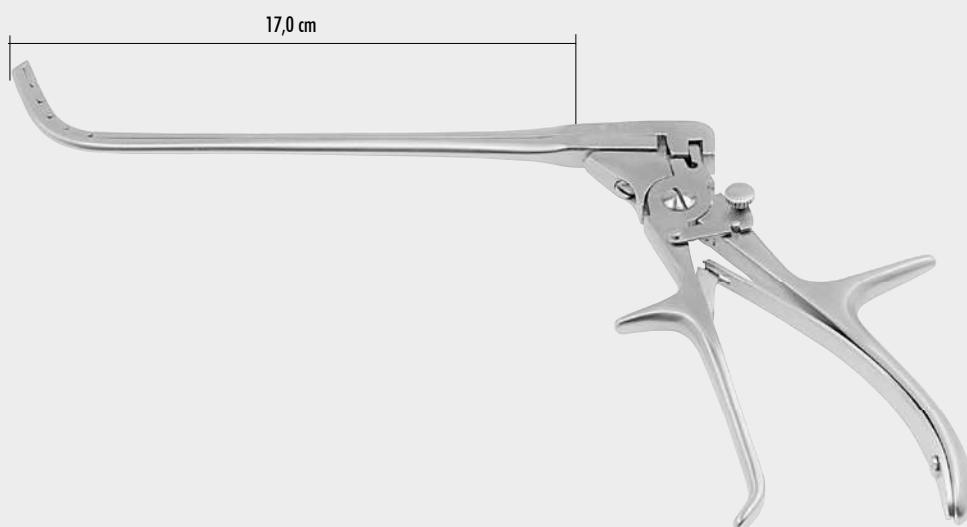

mm	40°
2,0	46-3021-17
	17,0 cm



mm	CITELLI
1,0	46-3101-10
2,5	46-3101-25
4,0	46-3101-40

Stanzen
 Punches
 Pincas emporte-pièces
 Pinzas sacabocados
 Pinze taglianti

RHINOLOGIE

RHINOLOGY

RHINOLOGIE

RINOLOGÍA

RINOLOGIA



mm BEYER
 2,0 46-3105-20



cm HAJEK-CLAUS
 20,0 46-3200-20



cm MIDDLETON-JANSEN
 19,0 46-3203-19



cm MIDDLETON-JANSEN
 19,0 46-3205-19



cm JANSEN STRUYCKEN
 19,0 46-3207-19



mm	LICHTWITZ 10,0 cm
1,0	46-3400-10
1,5	46-3400-15
1,8	46-3400-18
2,0	46-3400-20

Luer Lock



ø mm	KILLIAN
3,0	46-3401-03
	14,0 cm



ø mm	EICKEN KILLIAN
3,0	46-3403-03
	14,0 cm



cm	KRAUSE
26,0	46-3501-26



cm	WILDE
24,0	46-3502-24

RHINOLOGIE

RHINOLOGY

RHINOLOGIE

RINOLOGÍA

RINOLOGIA

12 Stück
12 ea.
12 pcs.
12 pzs.
12 pezzi



46-3505-03
ø 0,3 mm



JOSEPH
46-3700-16 - 3703-16



46-3700-16	46-3701-16
------------	------------



46-3702-16	46-3703-16
------------	------------



Nasenmesser
Nasal Knives
Bistouris nasaux
Bisturías nasales
Coltelli nasali

Nasennmesser
 Nasal Knives
 Bistouris nasaux
 Bisturías nasales
 Coltelli nasali

RHINOLOGIE

RHINOLOGY

RHINOLOGIE

RINOLOGÍA

RINOLOGIA



cm FREER
 15,0 46-3704-15



cm FREER
 19,0 46-3705-19



cm JOSEPH
 16,0 46-3706-16



cm CONVERSE
 16,0 46-3709-16



cm COTTLE
 14,0 46-3798-14



cm COTTLE
 15,0 46-3800-15



cm COTTLE
 15,0 46-3802-15



cm COTTLE
 15,0 46-3804-15



cm COTTLE
 15,0 46-3805-15



46-3900-03
3 mm



46-3900-04
4 mm



46-3900-05
5 mm



46-3902-03
3 mm



46-3902-04
4 mm



46-3902-05
5 mm



Septum-Schwingmesser
Septum Swivel Knives
Couteaux mobiles pour la cloison
Cuchillos para tabique con hojas movibles
Coltelli a lama girevole per il setto

cm **BALLENGER**
20,0 46-3900-03 - 46-3902-05

RHINOLOGIE

RHINOLOGY

RHINOLOGIE

RINOLOGÍA

RINOLOGIA



cm **BRUENINGS**
16,5 46-3908-16



cm **McKENTY**
15,0 46-4100-04 - 46-4100-05



46-4100-04
4 mm

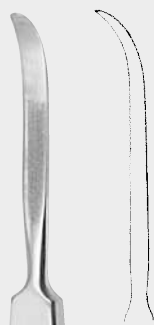

46-4100-05
5 mm

Septum-Elevatorien - Septum Elevators - Éleveurs
pour la cloison nasale- Elevadores para tabique nasal-
Elevatori per setto

cm **Mc KENTY**
22,0 46-4101-22



Septum-Messer - Septum
Knife - Bistouri à cloison -
Bisturí para tabique nasal
Coltello per il setto nasale



Septum-Elevatorien
 Septum Elevators
 Élévateurs pour la cloison nasale
 Elevadores para tabique nasal
 Elevatori per il setto

RHINOLOGIE

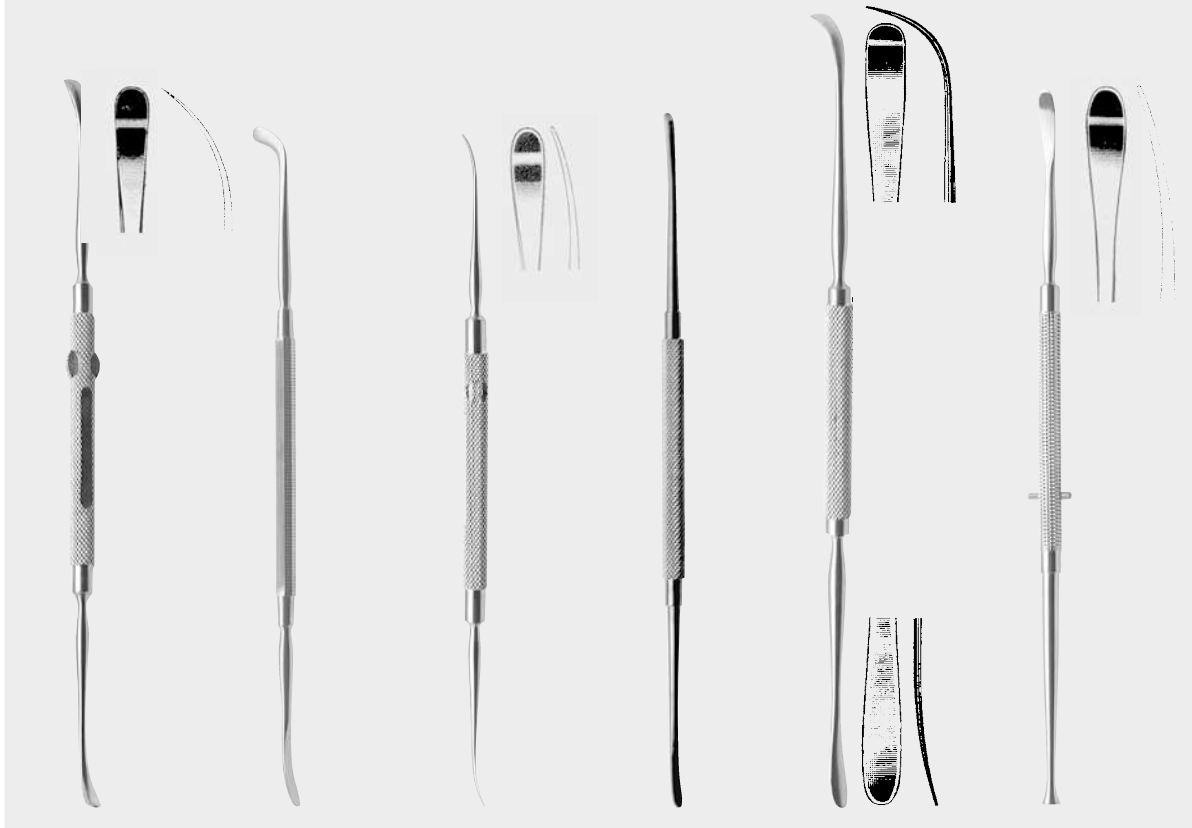

cm	ROGER	cm	FREER	cm	FREER	cm	FREER YASARGIL	cm	FREER	cm	FREER
19,0	46-4103-19	17,5	46-4104-18	18,0	46-4105-18	18,5	46-4106-18	20,0	46-4106-20	19,0	46-4107-19
	4,5 x 4,5 mm			4,5 x 4,5 mm		3,0 x 3,0 mm					

RHINOLOGY

RHINOLOGIE

RINOLOGÍA

RINOLOGIA

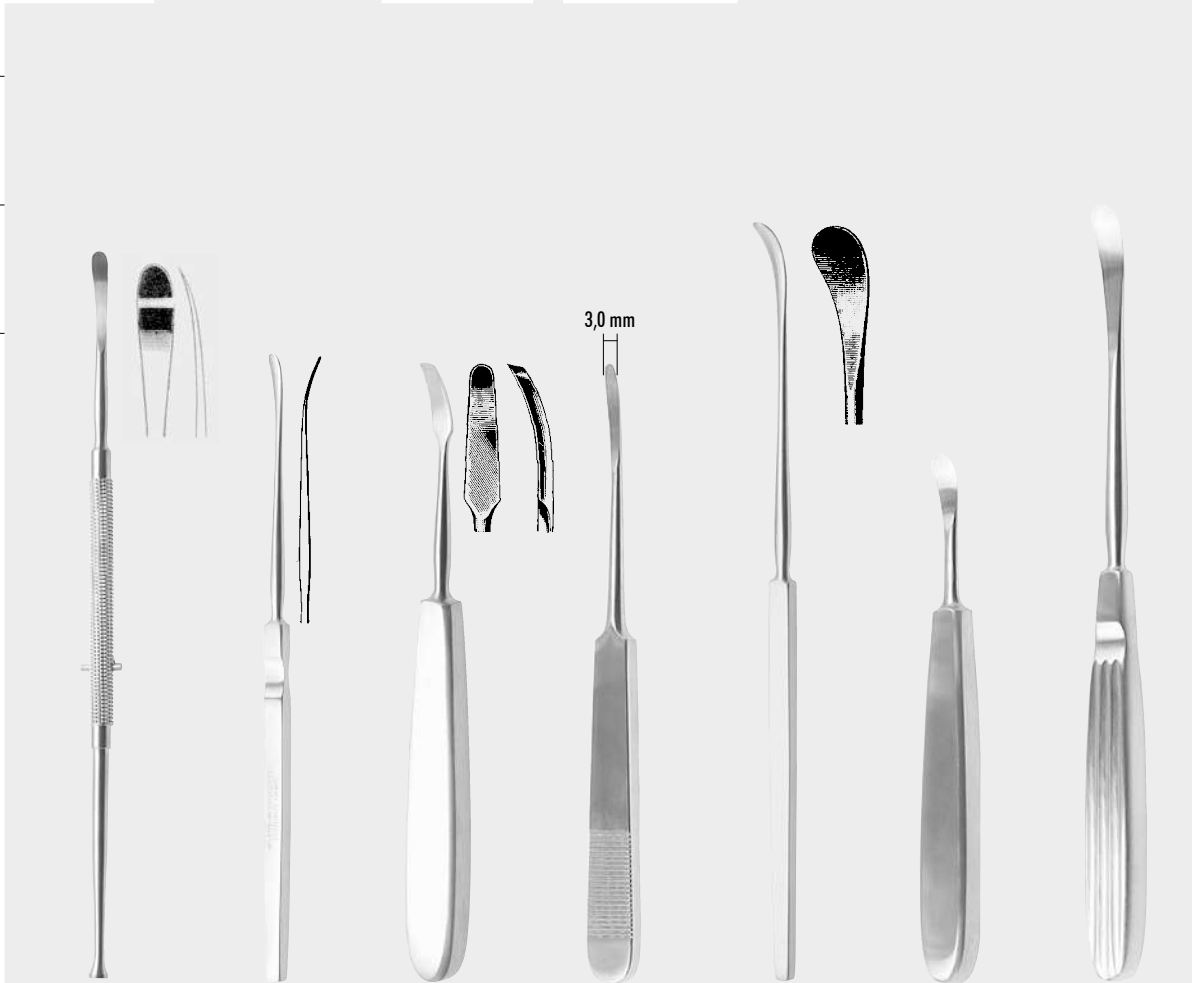

cm	FREER	cm	HALLE	cm	JOSEPH	SEWALL	cm	SEWALL	cm	TRELAT	cm	COTTLE
19,0	46-4109-19	16,5	46-4111-16	16,0	46-4113-16	46-4114-01	20,0	46-4115-20	14,5	46-4117-14	19,5	46-4119-19
		4,0 mm		4,0 x 6,0 mm	46-4114-02	6,0 mm						
					16,0 cm							



Septum-Elevatorien
 Septum Elevators
 Élévateurs pour la cloison nasale
 Elevadores para tabique nasal
 Elevatori per il setto

RHINOLOGIE

RHINOLOGY

RHINOLOGIE

RINOLOGÍA

RINOLOGIA



cm COTTLE
 23,0 46-4201-23
 4,0 x 4,0 mm



cm COTTLE
 22,0 46-4203-22
 3,5 x 4,0 mm



cm COTTLE
 22,0 46-4204-22



cm JOSEPH
 16,0 46-4205-16
 6,0 mm

Elevatorien, Raspatorien, Nasenmeissel
 Elevators, Raspatories, Nasal Chisels
 Élévateurs, rugines, ciseaux nasaux
 Elevadores, periostótomos, cínceles
 Elevatori, periostotomi, cesoie

RHINOLOGIE

RHINOLOGY

RHINOLOGIE

RINOLOGÍA

RINOLOGIA



cm COTTLE
 19,0 46-4205-19

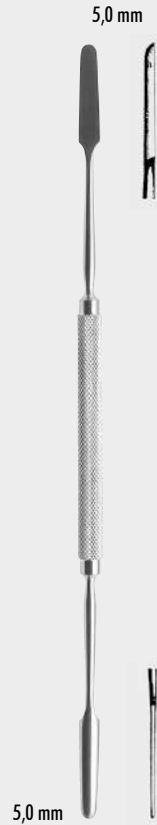

cm KILLIAN
 22,0 46-4206-22

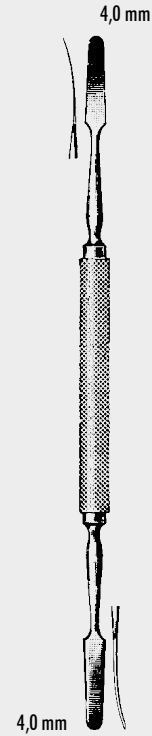

cm KILLIAN
 18,0 46-4207-18



cm HAJEK-BALLENGER
 19,0 46-4208-19
 22,0 46-4208-21



cm PIERCE
 21,5 46-4209-21



cm HILL
 22,0 46-4210-22



cm JOSEPH MASING (COTTLE-MASING)
 22,0 46-4211-22

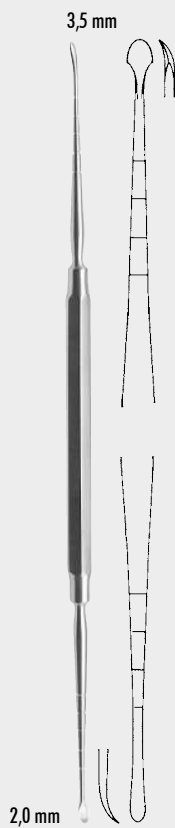

cm MASING
21,0 46-4213-21



cm CARTER
21,0 46-4217-21



cm BALLENGER
22,0 46-4300-22

Elevatori, Raspatorii, Nasenmeissel
Elevators, Raspatories, Nasal Chisels
Élévateurs, rugines, ciseaux nasaux
Elevadores, periostótomos, cinceles
Elevatori, periostotomi, cesoie

RHINOLOGIE

RHINOLOGY

RHINOLOGIE

RINOLOGÍA

RINOLOGIA



mm FREER 19,0 cm
4,0 46-4498-19 46-4499-19



mm FREER
4,0 46-4500-04



mm FREER
4,0 46-4501-04



Elevatorii, Raspatorii, Nasenmeissel
 Elevators, Raspatories, Nasal Chisels
 Élévateurs, rugines, ciseaux nasaux
 Elevadores, periostótomos, cínceles
 Elevatori, periostotomi, cesoie

RHINOLOGIE

RHINOLOGY

RHINOLOGIE

RINOLOGÍA

RINOLOGIA



mm	SHEEHAN
1,0	46-4502-01
2,0	46-4502-02
3,0	46-4502-03
4,0	46-4502-04
5,0	46-4502-05
6,0	46-4502-06
7,0	46-4502-07
8,0	46-4502-08
10,0	46-4502-10
12,0	46-4502-12

cm	COTTLE
18,0	46-4504-04 - 46-5404-12

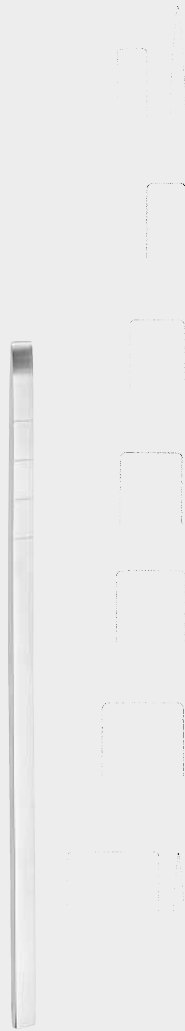

46-4504-04
4,0 mm

46-4504-06
6,0 mm

46-4504-07
7,0 mm

46-4504-08
8,0 mm

46-4504-09
9,0 mm

46-4504-10
10,0 mm

46-4504-12
12,0 mm

cm	COTTLE	mm
18,0	46-4505-04	4,0
18,0	46-4505-06	6,0

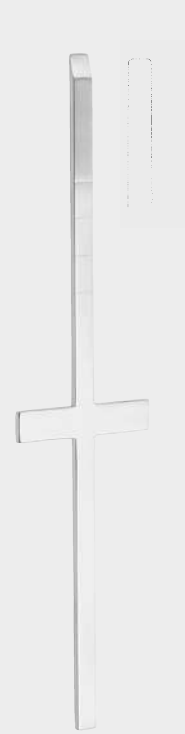

46-4508-04
4,0 mm

46-4508-07
7,0 mm

46-4508-09
9,0 mm

46-4508-12
12,0 mm

cm	COTTLE
46-4508-04 - 46-4508-12	



cm	COTTLE
18,0	46-4600-04 - 46-4600-12

46-4600-04
4,0 mm

46-4600-07
7,0 mm

46-4600-12
12,0 mm



mm	RUBIN
10,0	46-4602-10
12,0	46-4602-12
14,0	46-4602-14
18,5	



mm	WALTER
3,0	46-4610-03
4,0	46-4610-04
7,0	46-4610-07
9,0	46-4610-09
12,0	46-4610-12
19,0	



mm	WALTER
3,0	46-4611-03
4,5	46-4611-04
19,0	



46-4502-01

46.28



cm **PARKES**
16,0 46-4620-01



cm **FOMON**
17,0 46-4700-04 - 46-4700-08



46-4700-04
4,0 mm



46-4700-05
5,0 mm



46-4700-06
6,0 mm



46-4700-07
7,0 mm



46-4700-08
8,0 mm

Elevatori, Raspatorii, Nasenmeissel
Elevators, Raspatories, Nasal Chisels
Élévateurs, rugines, ciseaux nasaux
Elevadores, periostótomos, cinceles
Elevatori, periostotomi, cesoie

RHINOLOGIE

RHINOLOGY

RHINOLOGIE

RINOLOGÍA

RINOLOGIA



CINELLI
46-4702-10 - 46-4702-16



46-4702-10
10,0 mm



46-4702-12
12,0 mm

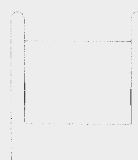

46-4702-14
14,0 mm



46-4702-16
16,0 mm

Nasenplastik-Meissel
Rhinoplastic Chisels
Ciseaux-burins pour la rhinoplastie
Cinceles para la rinoplastia
Cesoie per rinoplastica



gerade
straight
droit
recto
diritto

Nasenplastik-Meissel
Rhinoplastic Chisels
Ciseaux-burins pour la rhinoplastie
Cincales para la rinoplastia
Cesoie per rinoplastica

RHINOLOGIE

RHINOLOGY

RHINOLOGIE

RINOLOGÍA

RINOLOGIA

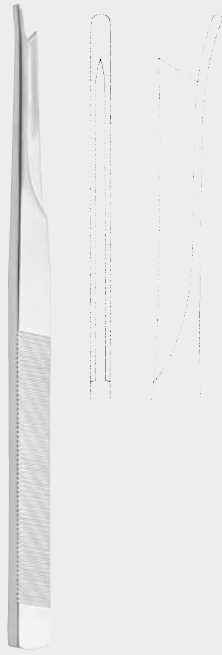

cm SILVER
18,0 46-4703-01



cm SILVER »
18,0 46-4703-02

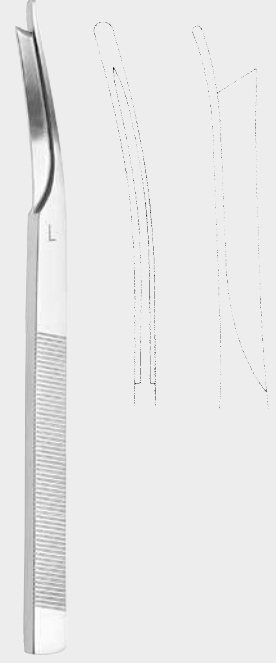

cm SILVER «
18,0 46-4703-03



mm NEIVERT ANDERSON
7,0 46-4705-01
20,0 cm



mm NEIVERT ANDERSON «
7,0 46-4705-02
20,0 cm



mm NEIVERT ANDERSON »
7,0 46-4705-03
20,0 cm



cm CONVERSE
19,0 46-4707-01



cm CONVERSE «
19,0 46-4707-02



cm CONVERSE »
19,0 46-4707-03

Nasenplastik-Meissel
Rhinoplastic Chisels
Ciseaux-burins pour la rhinoplastie
Cinceles para la rinoplastia
Cesoie per rinoplastica

RHINOLOGIE

RHINOLOGY

RHINOLOGIE

RINOLOGÍA

RINOLOGIA



mm GUY
5 46-4801-13
13,0 cm



mm KILLIAN-CLAUS
5 46-4802-05
17,0 cm



KILLIAN
46-4803-05
16,0 cm



mm HAJEK
4 46-4804-04
6 46-4804-06
8 46-4804-08



mm MC INDOE
9 46-4805-09
10 46-4805-10
11 46-4805-11
15 46-4805-15

Nasenmeissel
Nasal Chisels and Gouges
Ciseaux-burins et gouges nasaux
Cinceles y gubias nasales
Cesoie e sgorbie nasali

ZEPF®
INSTRUMENTS

Nasenmeißel
 Nasal Chisels and Gouges
 Ciseaux-burins et gouges nasaux
 Cinceles y gubias nasales
 Česoië e sgorbie nasali

RHINOLOGIE

RHINOLOGY

RHINOLOGIE

RINOLOGÍA

RINOLOGIA

Knochenfeile, Nasenraspeln
 Bone File, Nasal Rasps
 Lime à os, râpes nasales
 Lima para huesos, escofinas nasales
 Lima per ossa, raspe nasali



cm WEST
 16,0 46-4806-16



cm WEST
 16,0 46-4807-16



cm FREER
 16,0 46-4809-16

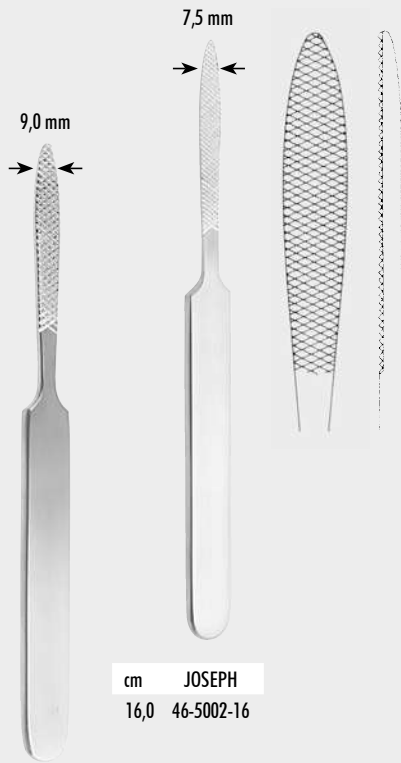

cm JOSEPH
 16,0 46-5002-16

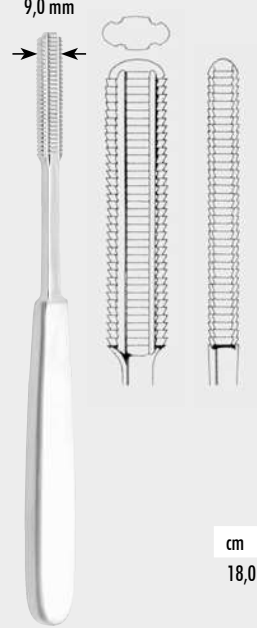

cm MALTZ (AUFRICHT)
 18,0 46-5004-18

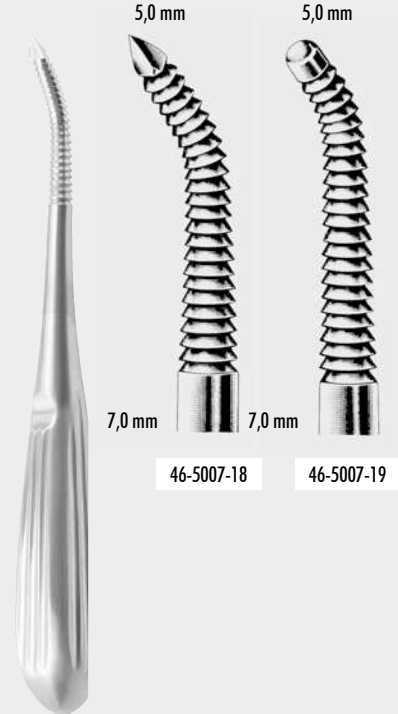

46-5007-18

46-5007-19

cm JOSEPH
 16,5 46-5000-16

cm WIENER (American)
 18,0 46-5007-18 - 46-5007-19



cm AUFRICHT
21,0 46-5101-21 - 46-5103-21



46-5101-21

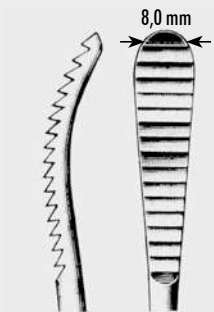

46-5103-21



cm MALTZ (COTTLE)
21,0 46-5108-21

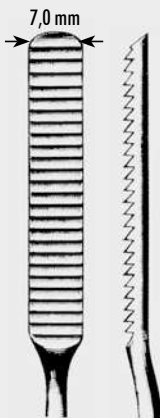

7,0 mm



cm JOSEPH (LEWIS)
18,0 46-5104-16 - 46-5106-16



46-5104-16
fein - fine - fina



46-5106-16
grob - coarse - dentelure grosse
gruesa - dentellatura grossa



cm MALTZ —
18,0 46-5110-18



cm MALTZ —
18,0 46-5111-18



7,0 mm
cm FOMON
21,5 46-5198-21
6,5 mm / 7,5 mm



7,0 mm
cm FOMON
21,0 46-5200-21

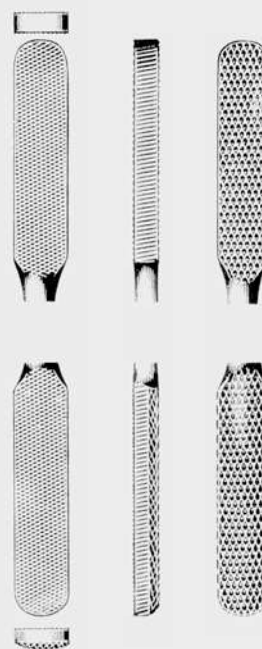

Nasenraspeln
Nasal Rasps
Râpes nasales
Escofinas nasales
Raspe nasali

RHINOLOGIE

RHINOLOGY

RHINOLOGIE

RINOLOGÍA

RINOLOGIA

Nasenraspeln
Nasal Rasps
Râpes nasales
Escofinas nasales
Raspe nasali

RHINOLOGIE

RHINOLOGY

RHINOLOGIE

RINOLOGÍA

RINOLOGIA

Mit TC-Einsätzen
TC Lined
A mors TC
Con bocas TC
Con morso TC

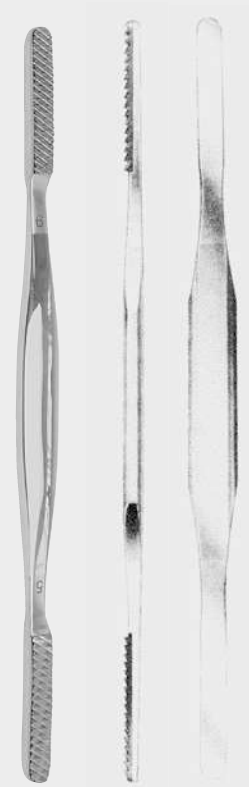

cm FOMON TC
20,0 46-5202-01 - 46-5202-09



46-5202-01
Fig. 1/2



46-5202-03
Fig. 3/4



46-5202-05
Fig. 5/6



46-5202-07
Fig. 7/8



46-5202-09
Fig. 9/10



GALLAHER
46-5206-16 - 46-5209-16



46-5206-16
Fig. 1

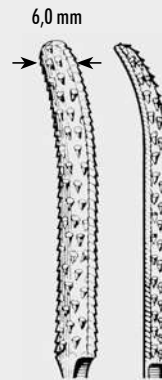

46-5207-16
Fig. 2

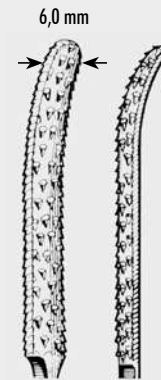

46-5209-16
Fig. 3



46-5301-19

46-5302-19 «

46-5304-19 »

gerade
straight
droite
recta
diritta

cm JOSEPH
19,0 46-5301-19 - 46-5304-19



« JOSEPH »
46-5305-01 17,0 cm 46-5305-02

Nasenraspeln
Nasal Rasps
Râpes nasales
Escofinas nasales
Raspe nasali

RHINOLOGIE

RHINOLOGY

RHINOLOGIE

RINOLOGÍA

RINOLOGIA

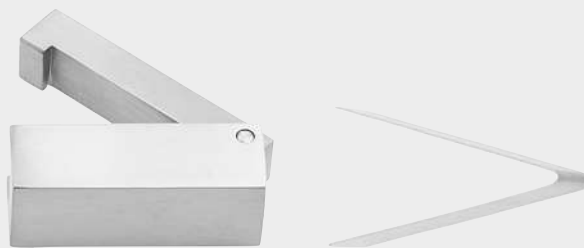

COTTLE
46-5320-00

Quetscher mit Entnahmeklammer
Cartilage Crusher with Clamp
Presse pour matière cartilagineuse avec pince
Instrumento para magullar cartilago con pinza
Prensa tritacartilagine con pinza

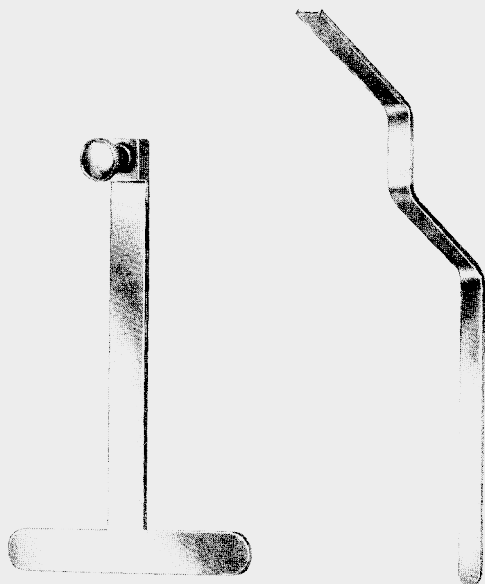

COTTLE
46-5321-00

Einführungsinstrument
Applicator
Introduceur de matière cartilagineuse
Introducor de cartilago
Strumento per applicazione



ø mm KING
20,0 46-5330-13
13,0 cm

mit Kaltlicht
with fibre light
à lumière froide
con luz fría
con luce fredda

Nasenhaken
Nasal Retractors
Écarteurs nasaux
Separadores nasales
Divaricatori nasali

RHINOLOGIE

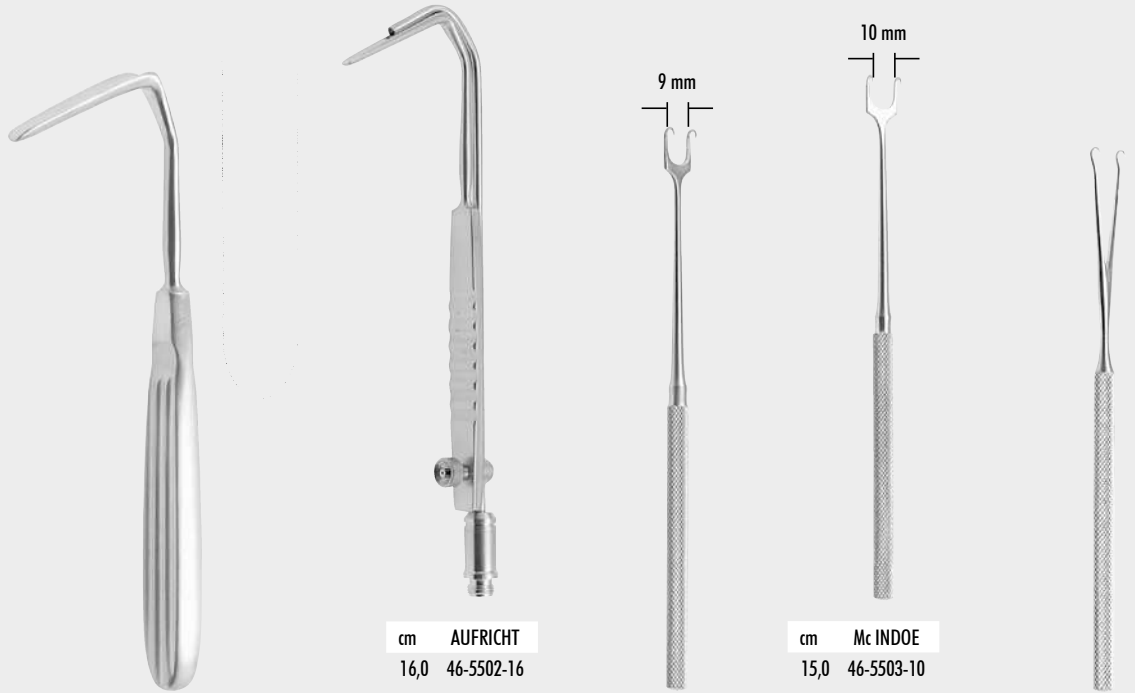

cm AUFRICT
16,0 46-5501-19

cm AUFRICT
16,0 46-5502-16

cm Mc INDOE
15,0 46-5503-09

cm Mc INDOE
15,0 46-5503-10

cm BARSKY
15,0 46-5505-15

RHINOLOGY

RHINOLOGIE

RINOLOGÍA

RINOLOGIA

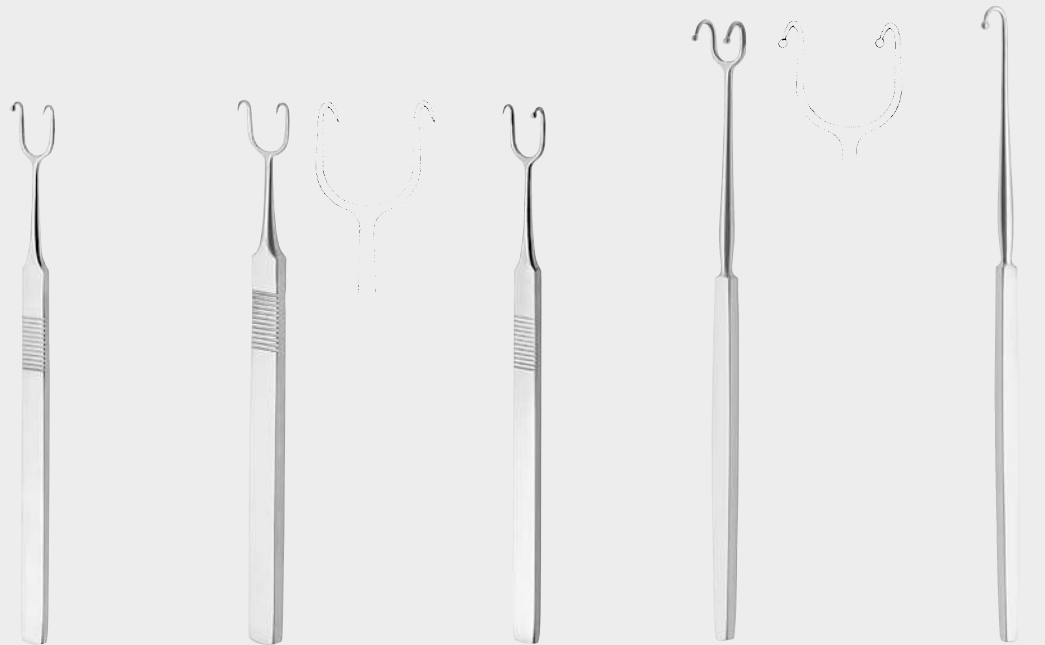

cm COTTLE
14,0 46-5506-13

cm COTTLE
14,0 46-5506-14

cm COTTLE
14,0 46-5506-15

cm FOMON
46-5506-16

cm FOMON
46-5507-17

Nasenhaken
Nasal Retractors
Écarteurs nasaux
Separadores nasales
Divaricatori nasali



cm LANGE
22,0 46-5507-22



cm MÜLLER
15,0 46-5508-01



cm MÜLLER
15,0 46-5508-02

RHINOLOGIE

RHINOLOGY

RHINOLOGIE

RINOLOGÍA

RINOLOGIA



COTTLE-NEIVERT
46-5509-20



cm HUMBY
11,5 46-5510-11



cm FREER
15,0 46-5511-15



mm x mm	CONVERSE
18 x 9,5	46-5512-18
28 x 12,5	46-5512-28
41 x 13,5	46-5512-41
53 x 13,5	46-5512-53
	9,0 cm

Nasenhaken
 Nasal Retractors
 Écarteurs nasaux
 Separadores nasales
 Divaricatori nasali

RHINOLOGIE



mm	CONVERSE
44,0 x 11,0	46-5513-11
	10,5 cm



cm	KILNER
10,0	46-5514-10
12,0	46-5514-12



cm	CONVERSE
12,0	46-5516-12



cm	COTTLE
14,0	46-5517-14

RHINOLOGY

RHINOLOGIE

RINOLOGÍA

RINOLOGIA



cm	NEIVERT
16,0	46-5519-16



cm	COTTLE
15,0	46-5521-15



cm	COTTLE
15,0	46-5523-15



cm	AUFRICHT
13,5	46-5525-14



cm	WALTER
13,5	46-5529-13



Fig. 1



Fig. 2



cm COTTLE
14,5 46-5604-01



cm COTTLE
14,5 46-5604-02



cm COTTLE
17,0 46-5606-17



cm COTTLE
16,0 46-5608-16

Fig.	cm	GILLIES
1	18,0	46-5600-18
1	23,0	46-5600-23
2	18,0	46-5602-18

Septum-Richtzangen
Septum Straightening Forceps
Pincas à redresser la cloison
Pinzas para enderezar tabique
Pinze per raddrizzare il setto

RHINOLOGIE

RHINOLOGY

RHINOLOGIE

RINOLOGÍA

RINOLOGIA



cm ASCH
23,0 46-5701-23



cm WALSHAM
23,0 46-5702-23 - 46-5705-23

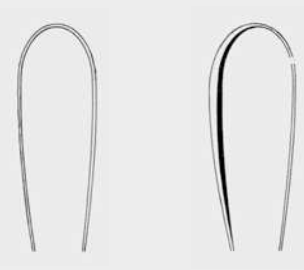

46-5702-23

46-5703-23

«



46-5705-23

»

RHINOLOGIE

RHINOLOGY

RHINOLOGIE

RINOLOGÍA

RINOLOGIA

Küretten, scharf
 Currettes, sharp
 Currettes tranchantes
 Curetas cortantes
 Curette taglienti

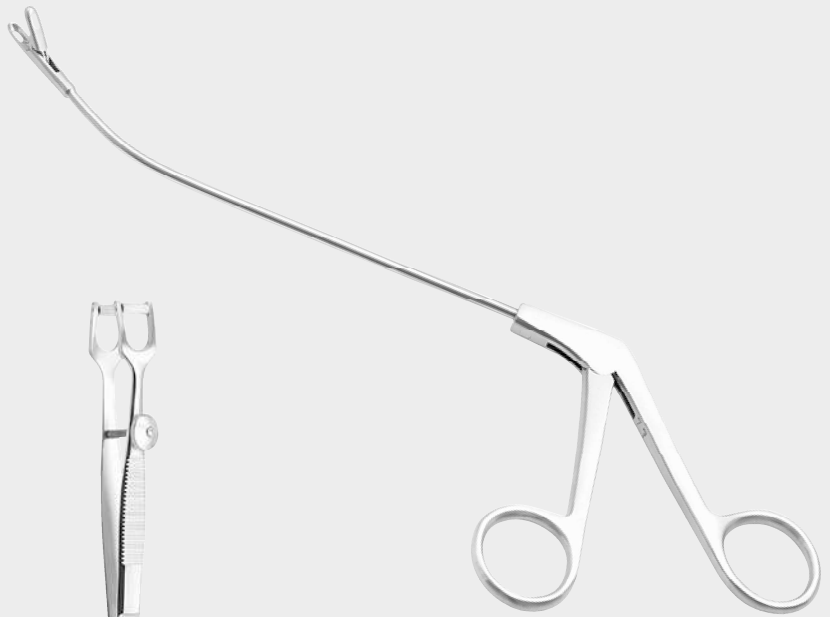

JATHO
 46-5905-15

Nasenrachenzange, scharf
 Nasopharyngeal Forceps, Sharp
 Pince nasopharyngienne, tranchante
 Pinza nasofaringea, cortante
 Pinza nasofaringea, tagliente



cm **COTTLE**
 14,0 46-5802-14

Haut-Fasspinzette
 Skin Grasping Forceps
 Pince à saisir la peau
 Pinza para agarrar la piel
 Pinza per afferrare pelle



cm **COTTLE**
 10,0 46-5804-10

Columella Klemme
 Columella Clamp
 Pince à columelle
 Pinza para columela
 Pinza per columella

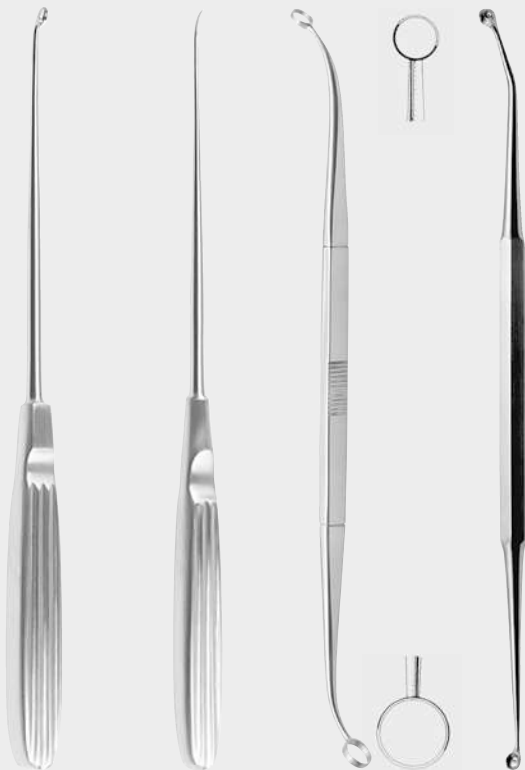

cm	MACKAY	cm	MACKAY	cm	FAULKNER	cm	PRATT	cm	COAKLEY
21,0	46-5990-21	21,0	46-5992-21	21,0	46-6001-21	21,0	46-6003-21	17,0	46-6007-01 - 46-6007-06

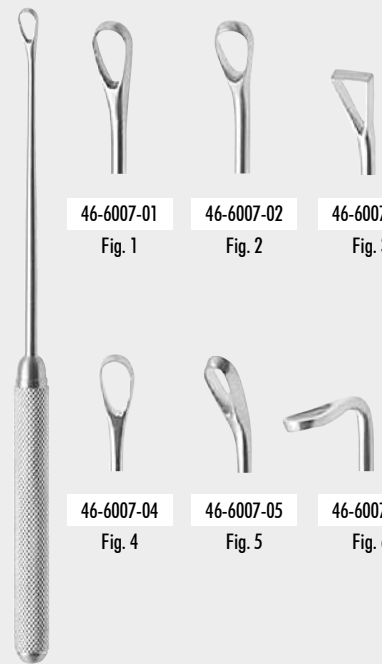

46-6007-01	46-6007-02	46-6007-03
Fig. 1	Fig. 2	Fig. 3
46-6007-04	46-6007-05	46-6007-06
Fig. 4	Fig. 5	Fig. 6



46-6200-01
46-6201-01
Fig. 1



46-6200-02
46-6201-02
Fig. 2



46-6200-03
46-6201-03
Fig. 3



46-6200-04
46-6201-04
Fig. 4



46-6200-05
46-6201-05
Fig. 5



46-6200-06
46-6201-06
Fig. 6

cm BECKMANN
22,0 46-6200-01 - 46-6200-06

cm BECKMANN
22,5 46-6201-01 - 46-6201-06

Ringmesser
Adenoid Currettes
Curettes à végétations adénoïdes
Cuchillos para vegetaciones adenoides
Coltelli per vegetazioni adenoidee

RHINOLOGIE

RHINOLOGY

RHINOLOGIE

RINOLOGÍA

RINOLOGIA

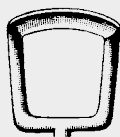

46-6220-01
Fig. 1

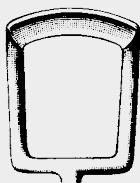

46-6220-04
Fig. 4

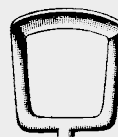

46-6222-01
Fig. 1

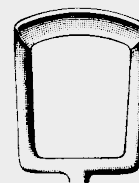

46-6222-04
Fig. 4

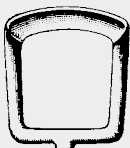

46-6220-02
Fig. 2

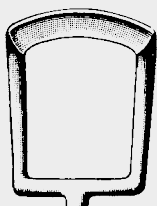

46-6220-05
Fig. 5

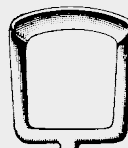

46-6222-02
Fig. 2

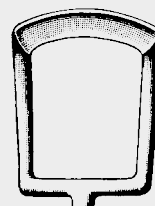

46-6222-05
Fig. 5

cm BECKMANN
22,0 46-6220-01 - 46-6220-05

46-6220-03
Fig. 3

cm BECKMANN
22,0 46-6222-01 - 46-6222-05

46-6222-03
Fig. 3

trapezförmig gefenstert
trapezoidal fenestration
fenêtrées trapézoïdalement
fenestrados trapezoidalmente
fenestrati a forma di trapezio



Ringmesser
Adenoid Currettes
Curettes à végétations adénoïdes
Cuchillos para vegetaciones adenoideas
Coltelli per vegetazioni adenoidee

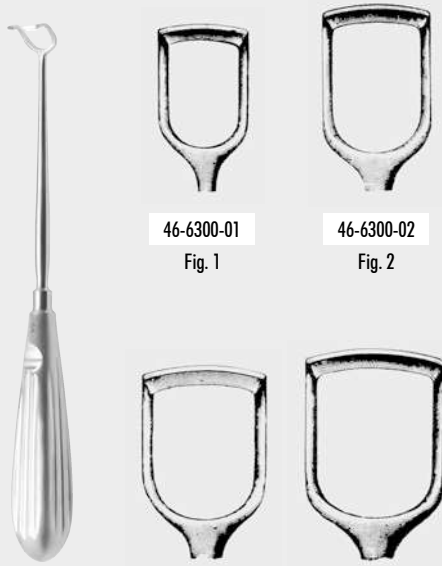

46-6300-01

Fig. 1

46-6300-02

Fig. 2

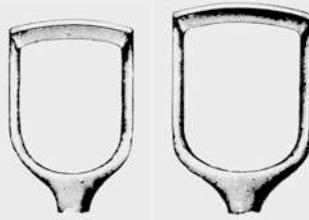

46-6300-03

Fig. 3

46-6300-04

Fig. 4

cm BARNHILL
21,0 46-6300-01 - 46-6300-04

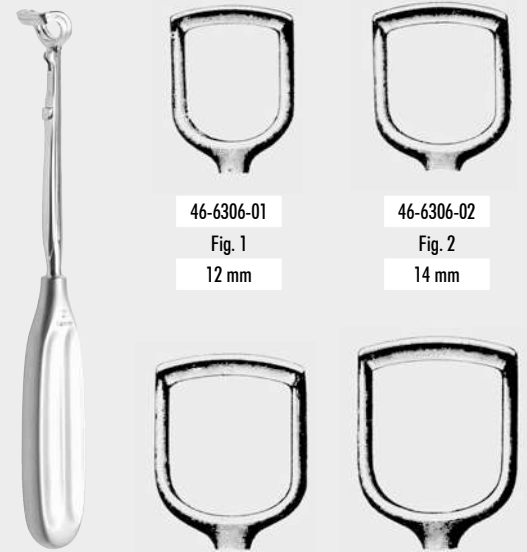

46-6306-01

Fig. 1

12 mm

46-6306-02

Fig. 2

14 mm

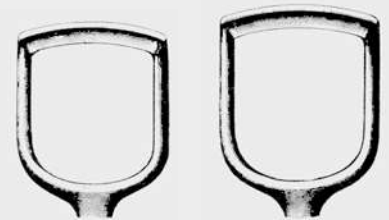

46-6306-03

Fig. 3

16 mm

46-6306-04

Fig. 4

17 mm

cm St. CLAIR-THOMSON
21,0 46-6306-01 - 46-6306-04

RHINOLOGIE

RHINOLOGY

RHINOLOGIE

RINOLOGÍA

RINOLOGIA

Pharynx-Tonsillotome
Adenotomes
Adénotomes
Adenótomos
Adenotomi



cm LA FORCE
25,0 46-6401-01 - 46-6401-03

Mit einer Ersatzklinge
With one spare blade
Avec une lame de rechange
Con una hoja de repuesto
con una lama di ricambio



46-6401-01

Fig. 1

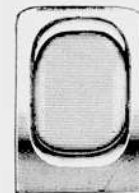

46-6401-02

Fig. 2



46-6401-03

Fig. 3

Fig.	
1	46-6402-01
2	46-6402-02
3	46-6402-03

Ersatzklingen, allein
Spare Blades only
Lames de rechange seules
Hojas de repuesto sueltas
Lame di ricambio sole



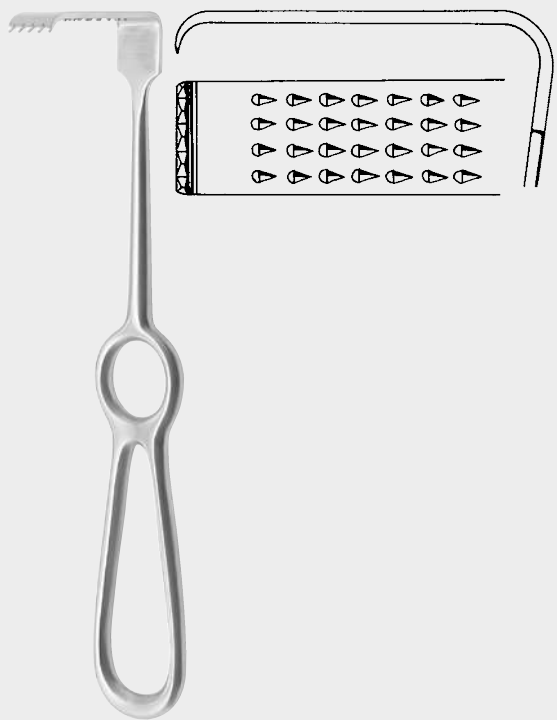

cm BRÜNINGS-BRUNK
19,0 46-6420-19



cm MILES
9,0 46-6502-09
11,5 46-6502-11



cm GUILLEN
20,0 46-6511-20



mm 20,0 cm
4,0 46-6513-04
5,0 46-6513-05

Kieferhöhlen-Haken, Spülkanülen
Antrum Retractor, Irrigating Cannulas
Écarteur pour le sinus maxillaire, Canules à irrigation
Separador de seno maxilar, Cánulas de irrigación
Divaricatore di seno mascellare, Cannule per irrigazione

RHINOLOGIE

RHINOLOGY

RHINOLOGIE

RINOLOGÍA

RINOLOGIA



cm FREER
21,0 46-6515-21



cm GORNEY
18,0 46-6520-18



cm NEGUS
21,0 46-6521-21



ø mm PAULSEN 17,5 cm
1,5 46-6523-15
2,5 46-6523-25



mm RITTER-HALLE
2,5 46-6531-25
3,0 46-6531-30
4,0 46-6531-40
5,0 46-6531-50

Saug-Elevatorium, Stirnhöhlen-Dilatatoren
Aspirating Elevator, Frontal Sinus Dilators
Élévateur aspirant, Dilatateurs pour le sinus frontal
Elevador aspirador, Dilatadores para el seno frontal
Elevatore con aspirazione, Dilatatori per il seno frontale



RHINOLOGIE

RHINOLOGY

RHINOLOGIE

RINOLOGÍA

RINOLOGIA



MUND UND ZUNGE

MOUTH AND TONGUE

BOUCHE ET LANGUE

BOCA Y LENGUA

BOCCA E LINGUA

In packungen zu 100 Stück
 In Packet of 100 ea.
 En boîtes de 100 pièces
 En cajas de 100 c/u
 In scatole di 100 pezzi

Zungenspatel
 Tongue Depressors
 Abaisse-langue
 Abajalengua
 Abbassalingua

MUND UND ZUNGE

MOUTH AND TONGUE

BOUCHE ET LANGUE

BOCA Y LENGUA

BOCCA E LINGUA



cm 16,0 48-1002-16



cm 16,5 FRENZEL 48-1005-16



cm 19,0 BRUENINGS 48-1007-19



cm 14,0 48-1008-14



cm 19,0 BUCHWALD 48-1009-19

Holz
 wood
 bois
 madera
 legno



cm 14,0 Fig. 1 48-1105-01



cm 15,0 Fig. 2 48-1105-02



cm 13,0 DOYEN 48-1011-13
 16,0 48-1011-16

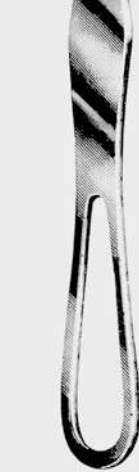

cm 15,0 HARTMANN 48-1101-15



WIEDER
 48-1105-01 - 48-1105-02



cm 11,0 ANDREW 48-1107-11

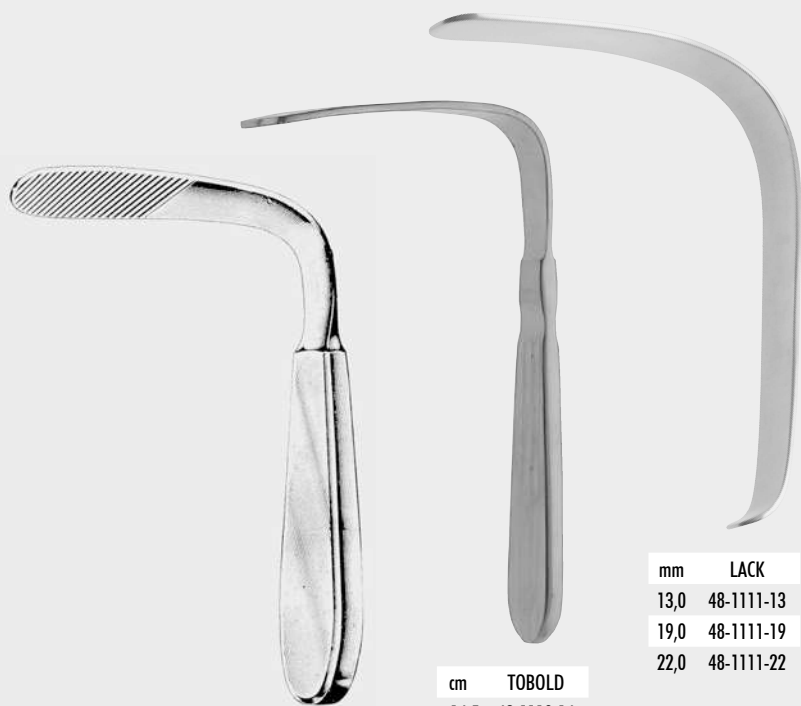

cm TOBOLD
14,5 48-1109-14

cm TOBOLD
14,5 48-1110-14

mm	LACK
13,0	48-1111-13
19,0	48-1111-19
22,0	48-1111-22

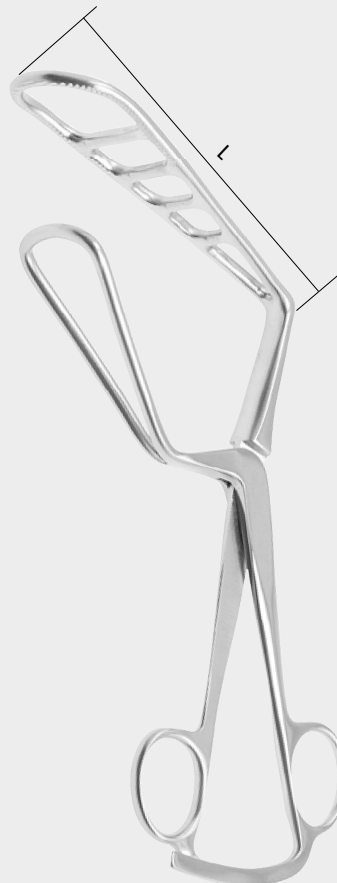

L=cm	STIERLEN
7,0	48-1115-07
9,0	48-1115-09
10,0	48-1115-10

Zungendrucker, Lippenhalter
Tongue Depressors, Lip Retractors
Abaisse-langue, Écarteurs des lèvres
Abajalengua, Separadores de labios
Abbassalingua, Divaricatori di labbra

MUND UND ZUNGE

MOUTH AND TONGUE

BOUCHE ET LANGUE

BOCA Y LENGUA

BOCCA E LINGUA



cm MORTIZ-SCHMIDT
19,0 48-1113-19

cm LE MEE
20,0 48-1119-14

cm	STERNBERG
14,0	48-2207-14
16,0	48-2207-16
18,0	48-2207-18

cm	STERNBERG
12,0	48-2209-12
14,0	48-2209-14
16,0	48-2209-16

cm	
8,0	48-2211-08
9,0	48-2211-09
	21,0 cm

Wangen-, Lippenhalter
 Cheek, Lip Retractors
 Écarteurs des joues et des lèvres
 Separadores de mejillas y de labios
 Divaricatori di guance e di labbra

MUND UND ZUNGE

MOUTH AND TONGUE

BOUCHE ET LANGUE

BOCA Y LENGUA

BOCCA E LINGUA

Zungenzangen
 Tongue Holding Forceps
 Pincers tire-langue
 Pinzas tiralingua
 Pinze tirilingua



cm
11,0 48-2300-11



cm CAWOOD-MINNESOTA
15,0 48-2303-15



cm
19,0 48-2305-19



cm LASTER
10,0 48-2307-10



cm HAJEK
16,5 48-2309-16



cm COLLIN
16,0 48-2500-16
18,0 48-2500-18



cm YOUNG
16,0 48-2505-16

48-2505-99

Mundsperrer
 Mouth Gags
 Ouvre-bouche
 Abrebocas
 Apribocca



cm DOYEN-JANSEN (MOLT)
 12,0 48-2605-12

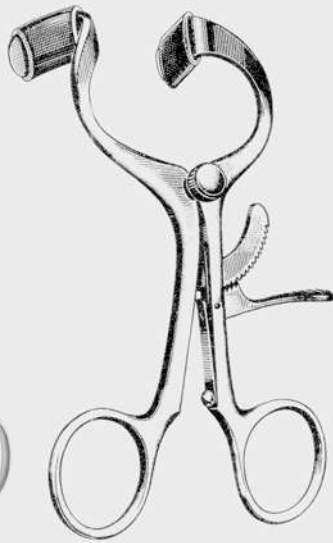

cm DOYEN-JANSEN (MOLT)
 14,0 48-2605-14

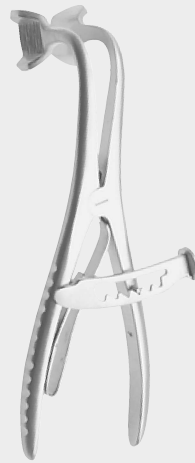

cm DENHART
 12,0 48-2606-12

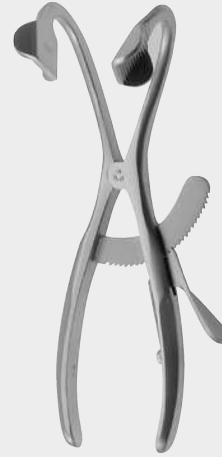

cm DENHART
 12,0 48-2607-12

MUND UND ZUNGE

MOUTH AND TONGUE

BOUCHE ET LANGUE

BOCA Y LENGUA

BOCCA E LINGUA



cm FERGISSON-ACKLAND
 15,5 48-2609-15
 21,0 48-2609-21

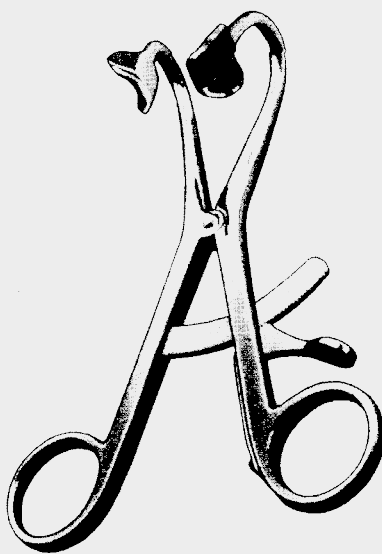

cm FEATHERSTONE
 16,0 48-2615-16



cm ROSER-KOENIG
 16,0 48-2700-16
 19,0 48-2700-19

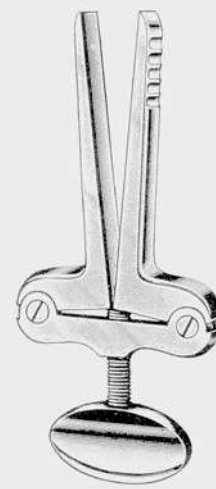

cm HEISTER
 13,0 48-2702-13

Mundsperrer
 Mouth Gags
 Ouvre-bouche
 Abrebocas
 Apribocca

MUND UND ZUNGE

MOUTH AND TONGUE

BOUCHE ET LANGUE

BOCA Y LENGUA

BOCCA E LINGUA



cm	JENNINGS
9,0	48-2704-09
11,0	48-2704-11
13,0	48-2704-13
15,0	48-2704-15

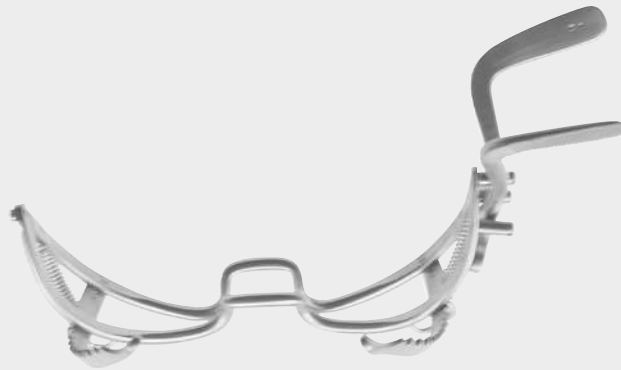

cm	WHITEHEAD
11,0	48-2800-11
13,0	48-2800-13
15,0	48-2800-15

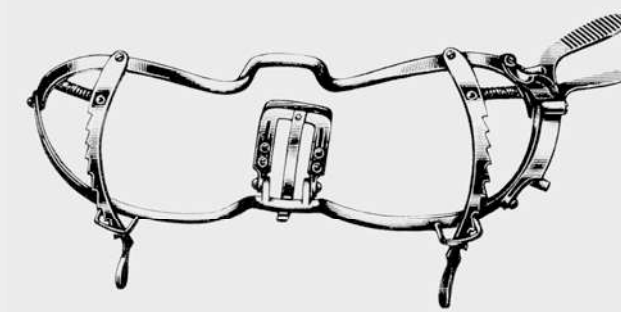

cm	WHITEHEAD
11,0	48-2801-11
13,0	48-2801-13
15,0	48-2801-15

mit Zungendrucker
 with tongue depressor
 avec abaisse-langue
 con abajalengua
 con abbassalingua



48-3100-99
Gummieinlage
Rubber Lining
Caoutchouc seul
Goma suelta
Gomma sola

Rahmen allein
Frame only
Cadre seul
Cuadro suelto
Telaio solo

48-3100-10 für Erwachsene - for adults - pour adultes - para adultos - per adulti
48-3100-12 f. Jugendliche - for adolescents - p. adolescents - p. adolescentes - p. adolescenti

DAVIS-BOYLE compl.
48-3100-00
incl. 48-3100-10, 48-3100-01, -02, -03, -04, -05



48-3100-05
26 x 108 mm Fig. 5

48-3100-04
25 x 93 mm Fig. 4

48-3100-03
24 x 80 mm Fig. 3

48-3100-02
23 x 65 mm Fig. 2



48-3100-01
21 x 30 mm Fig. 1



48-3100-99
Gummieinlage
Rubber Lining
Caoutchouc seul
Goma suelta
Gomma sola

DAVIS-BOYLE
48-3102-10
Rahmen allein
Frame only
Cadre seul
Cuadro suelto
Telaio solo

DAVIS-BOYLE compl. für Kinder - for children - pour enfants - para niños - per bambini
48-3102-00
incl. 48-3102-10, 48-3102-01, -02, -03, -04, -05



48-3102-05
22 x 80 mm Fig. 5



48-3102-04
22 x 71 mm Fig. 4



48-3102-03
20 x 58 mm Fig. 3



48-3102-02
19 x 46 mm Fig. 2



48-3102-01
17 x 26 mm Fig. 1

Mundsperrer für Erwachsene
Mouth Gags Adult Size
Ouvre-bouche pour adultes
Abrebocas para adultos
Apribocca per adulti

MUND UND ZUNGE

MOUTH AND TONGUE

BOUCHE ET LANGUE

BOCA Y LENGUA

BOCCA E LINGUA

Mundsperrer für Kinder
Mouth Gags Child Size
Ouvre-bouche pour enfants
Abrebocas para niños
Apribocca per bambini



Mundsperrer
 Mouth Gags
 Ouvre-bouche
 Abrebocas
 Apribocca

MUND UND ZUNGE

MOUTH AND TONGUE

BOUCHE ET LANGUE

BOCA Y LENGUA

BOCCA E LINGUA



48-3105-10

Rahmen allein
 Frame only
 Cadre seul
 Cuadro suelto
 Telaio solo

KILNER-DOUGHTY compl.

48-3105-00

incl. 48-3105-10, 48-3105-01, -02, -03, 48-3105-99

48-3105-01
 28 x 65 mm Fig. 1

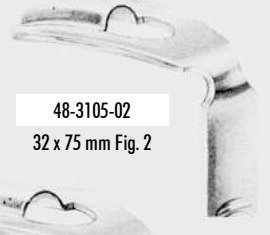

48-3105-02
 32 x 75 mm Fig. 2

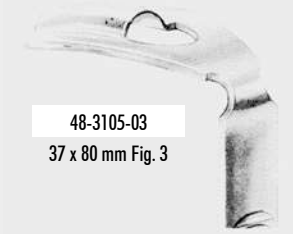

48-3105-03
 37 x 80 mm Fig. 3



48-3105-99



48-3200-10

Rahmen allein
 Frame only
 Cadre seul
 Cuadro suelto
 Telaio solo

McIVOR compl.

48-3200-00

incl. 48-3200-10, 48-3200-01, -02, -03

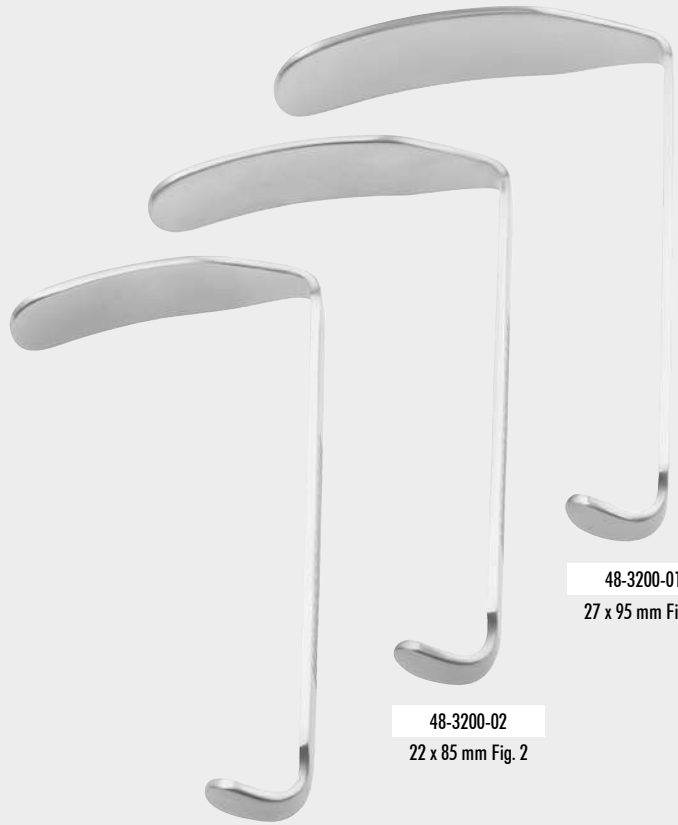

48-3200-01
 27 x 95 mm Fig. 1

48-3200-02
 22 x 85 mm Fig. 2

48-3200-03
 22 x 70 mm Fig. 3

Mundsperrer
 Mouth Gags
 Ouvre-bouche
 Abrebocas
 Apribocca

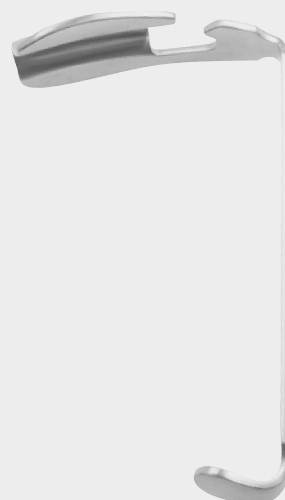
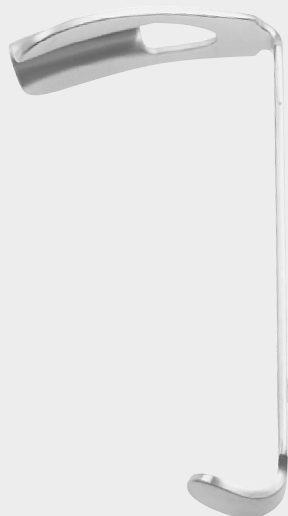

Fig.	mm	RUSSEL-DAVIS
1	28 x 65	48-3202-01
2	32 x 75	48-3202-02
3	37 x 80	48-3202-03
4	40 x 90	48-3202-04
5	45 x 100	48-3202-05

Fig.	mm	RUSSEL-DAVIS
1	18 x 55	48-3204-01
2	22 x 65	48-3204-02
3	25 x 75	48-3204-03

extra schmal - extra narrow - très étroits
 extra estrechos - extrastretti

Fig.	mm	GAST
1	28 x 64	48-3206-01
2	34 x 74	48-3206-02
3	38 x 87	48-3206-03

MUND UND ZUNGE

MOUTH AND TONGUE

BOUCHE ET LANGUE

BOCA Y LENGUA

BOCCA E LINGUA



48-3208-10

Rahmen allein
 Frame only
 Cadre seul
 Cuadro suelto
 Telaio solo

DAVIS-MEYER compl.

48-3208-00

incl. 48-3208-10, 48-3208-01, -02, -03, -04, -05, -06, -07



Fig.	mm	DAVIS-MEYER
1	29,0 x 70	48-3208-01
2	30,5 x 75	48-3208-02
3	31,5 x 80	48-3208-03
4	32,5 x 85	48-3208-04
5	33,5 x 95	48-3208-05
6	33,8 x 100	48-3208-06
7	34,0 x 105	48-3208-07



Mundsperrer
 Mouth Gags
 Ouvre-bouche
 Abrebocas
 Apribocca

MUND UND ZUNGE

MOUTH AND TONGUE

BOUCHE ET LANGUE

BOCA Y LENGUA

BOCCA E LINGUA

Zungendrucker für Mundsperrer
 Tongue Depressors for Mouth Gags
 Abaisse-langue pour ouvre-bouche
 Abajalengua para abrebocas
 Abbassalingua per apribocca



48-3300-10

Rahmen allein
 Frame only
 Cadre seul
 Cuadro suelto
 Telaio solo

DINGMANN compl.

48-3300-00

incl. 48-3300-10, 48-3300-01, -02, -03

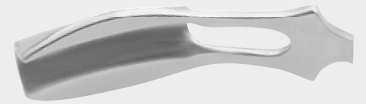

48-3300-03

31 x 75 mm Fig. 3

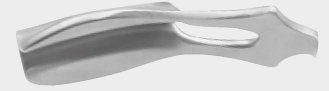

48-3300-02

28 x 65 mm Fig. 2

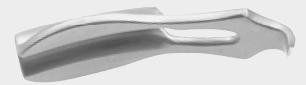

48-3300-01

24 x 63 mm Fig. 1

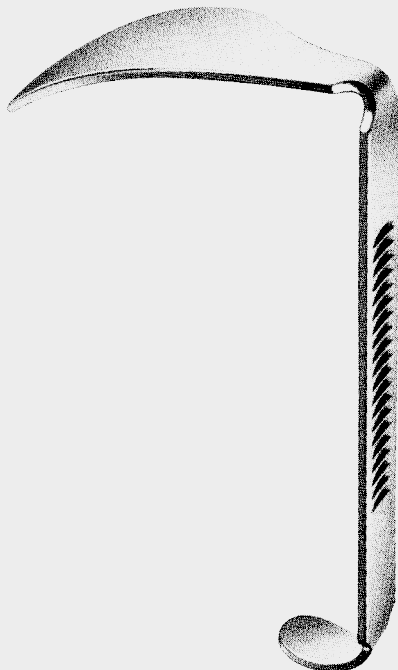

Fig.	mm	HERBERHOLD
1	28 x 63	48-3310-01
2	33 x 73	48-3310-02
3	37 x 82	48-3310-03
4	42 x 90	48-3310-04

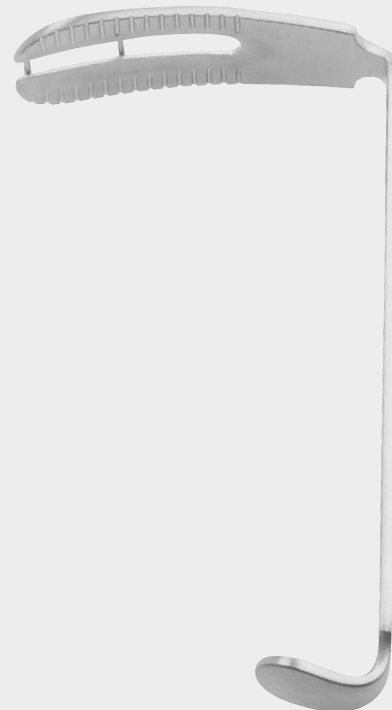
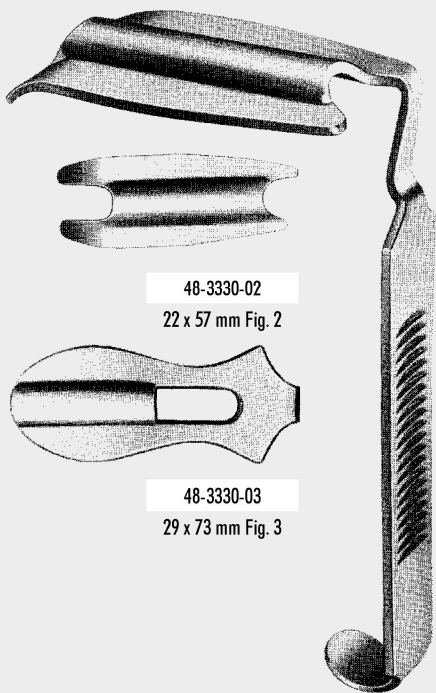
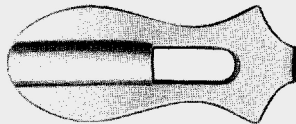

Fig.	mm	WÜRZBURG
1	28 x 66	48-3320-01
2	32 x 75	48-3320-02
3	34 x 83	48-3320-03
4	37 x 93	48-3320-04
5	38 x 100	48-3320-05



48-3330-02
22 x 57 mm Fig. 2



48-3330-03
29 x 73 mm Fig. 3

48-3330-04
32 x 89 mm Fig. 4

48-3330-05
38 x 95 mm Fig. 5

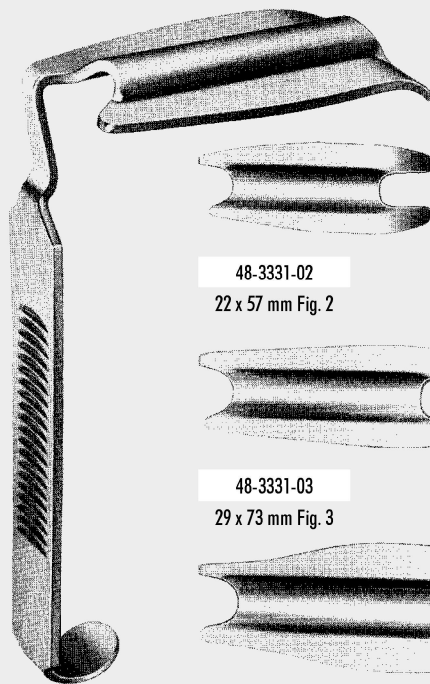

48-3331-02
22 x 57 mm Fig. 2



48-3331-03
29 x 73 mm Fig. 3

48-3331-04
32 x 89 mm Fig. 4

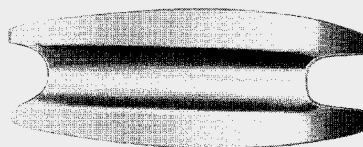

48-3331-05
38 x 95 mm Fig. 5

RING
» 48-3330-02 - 48-3330-05
« 48-3331-02 - 48-3331-05

Zungendrucker für Mundsperrer
Tongue Depressors for Mouth Gags
Abaisse-langue pour ouvre-bouche
Abajalengua para abre bocas
Abbassalingua per apribocca

MUND UND ZUNGE

MOUTH AND TONGUE

BOUCHE ET LANGUE

BOCA Y LENGUA

BOCCA E LINGUA



NEGUS
48-3340-00 für Erwachsene - for adults - pour adultes - para adultos - per adulti
48-3341-00 für Kinder - for children - pour enfants - para niños - per bambini

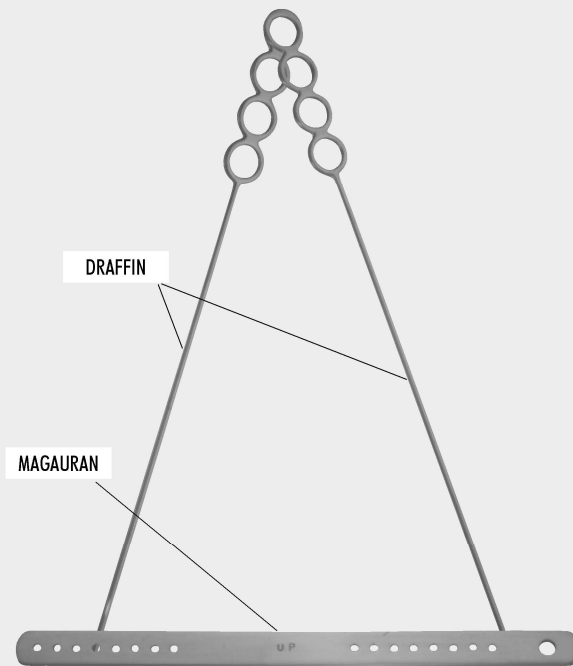

DRAFFIN compl.
48-3345-00

Bruststütze, Bipod
Chest Support, Bipod
Support de poitrine, Bipod
Soporte de pecho, Bipod
Supporto di petto, Bipod

Mundkeil, Fingerschützer
 Oral Screw, Finger Protectors
 Baillon, Doigtiers
 Garrote, Dedales
 Apribocca, Ditali



MAUNDER
 48-3600-10



Fig. **MC KESSON**
 1 48-3610-01
 2 48-3610-02
 3 48-3610-03
 4 48-3610-04
 5 48-3610-05



48-3701-01

Fig. 1



LANGENBECK

48-3701-02

Fig. 2



48-3701-03

Fig. 3

MUND UND ZUNGE

MOUTH AND TONGUE

BOUCHE ET LANGUE

BOCA Y LENGUA

BOCCA E LINGUA

Repositions-Zangen
 Reposition Forceps
 Pinces à redresser
 Pinzas de enderezamiento
 Pinze per radrizzare



ROWE
 48-5002-00

Verbindungsstück für 2 Zangen
 Connector for 2 forceps
 Connecteur pour 2 pinces
 Conector para 2 pinzas
 Connettore per 2 pinze



cm	« ROWE		ROWE »
22,0	48-5001-22	Säugling - baby - bébé - bebe	48-5003-22
23,0	48-5001-23	Kinder- child - enfant - niños - bambino	48-5003-23
24,0	48-5001-24	Erwachsene - adult - adulte - adulto	48-5003-24

TONSILLEN

TONSILS

AMYGDALES

AMÍGDALAS

TONSILLE

TONSILLEN



mm	LOVE
18	50-1003-18
20	50-1003-20
22	50-1003-22



cm	HOFER
24,0	50-1009-24



cm	NAGER
23,0	50-1101-23



cm	MOLLISON
21,0	50-1207-21

TONSILS

AMYGDALES

AMÍGDALAS

TONSILLE



mm	GWYNNE EVANS 20,0 cm
6	50-1209-06
8	50-1209-08



cm	HURD
22,0	50-1301-22
	glatt
	smooth
	lisse
	liso
	liscio

cm	HURD
22,0	50-1303-22
	gezahnt
	serrated
	dentelé
	dentado
	dentellato

10 mm



cm	HENKE
23,0	50-1305-23
	12 mm



cm	LOPEZ REINKE
23,5	50-1307-23



cm CARPENTER
25,0 50-1309-25



cm CARPENTER
24,0 50-1403-24

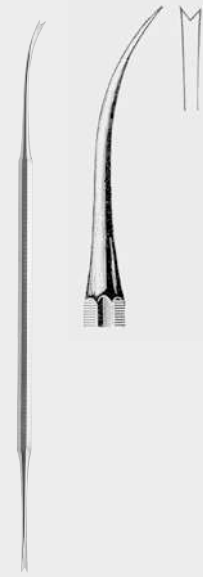

cm LUNIATSCHEK
19,0 50-1501-19

TONSILLEN

TONSILS

AMYGDALES

AMÍGDALAS

TONSILLE



cm » DUPUY-WEISS «
22,0 50-1605-22 50-1607-22



cm HURD
21,0 50-1609-21 50-1611-21
» «



cm NAGER
24,0 50-1613-24



cm ROEDER
26,5 50-1620-26

TONSILLEN



cm FISHER
22,5 50-1631-22



cm ABRAHAM
21,0 50-1633-20



cm CANFIELD
21,0 50-1635-21

TONSILS

AMYGDALES

AMÍGDALAS

TONSILLE

Tonsillen-Fasszangen
Tonsil Seizing Forceps
Pinces à préhension des amygdales
Pinzas para coger las amígdalas
Pinze per tonsille



cm WILSON
19,0 50-2001-19



cm COLVER
19,0 50-2002-19 - 50-2003-19



50-2002-19



50-2003-19



cm WHITE
18,0 50-2005-18
23,0 50-2005-23



cm **BALLENGER**
21,5 50-2007-21



cm **BLOHMKE**
20,0 50-2009-20

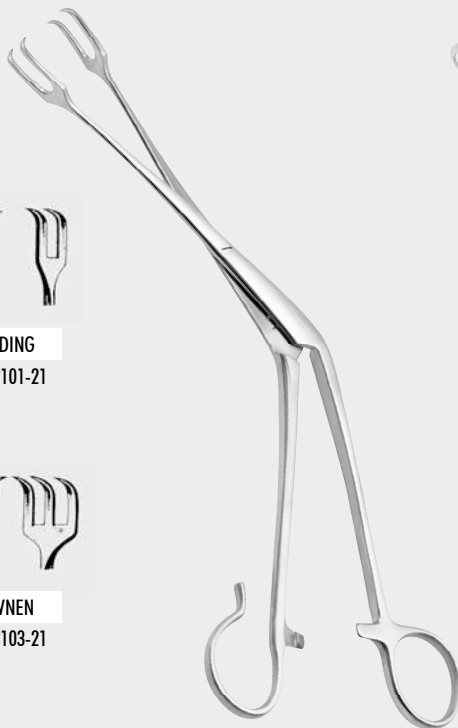

cm **COLVER**
21,0 50-2101-21 - 50-2103-21



cm **DENNIS BROWN**
20,0 50-2105-20



cm **MARSCHIK**
22,0 50-2109-22

Tonsillen-Fasszangen
Tonsil Seizing Forceps
Pinces à préhension des amygdales
Pinzas para coger las amígdalas
Pinze per tonsille

TONSILLEN

TONSILS

AMYGDALES

AMÍGDALAS

TONSILLE

Tonsillenschnürer
Tonsil Snares
Serre-nœud à amygdales
Cierranudos para amígdalas
Serranodi per tonsille

TONSILLEN

TONSILS

AMYGDALES

AMÍGDALAS

TONSILLE



cm EVES
28,0 50-2500-28

für offene Schlingen
for open loops
pour anses ouvertes
para asas abiertas
per anse aperte



cm EVES
28,0 50-2502-28

für offene Schlingen
for open loops
pour anses ouvertes
para asas abiertas
per anse aperte



cm BRUENINGS
28,0 50-2506-28

für geschlossene Schlingen
for soldered loops
pour anses soudées
para asas cerradas
per anse saldate

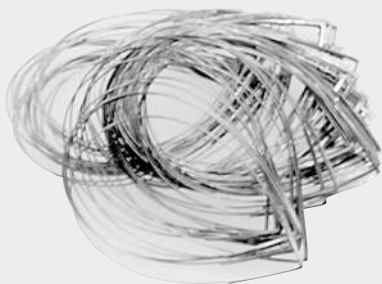

mm	100 x
40	50-2507-40
50	50-2507-50
ø	0,4 mm



ø mm	12 x
0,3	50-2509-03

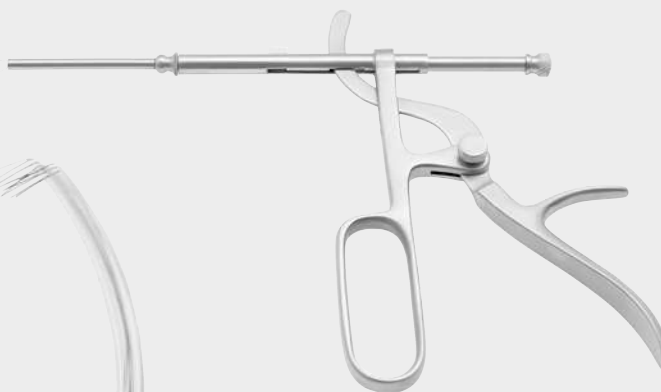

TYDING
50-2600-00

mit 1 geraden Aufsatz
with 1 straight tip
à 1 embout droit
con 1 punta recta
con 1 punta retta

Tonsillenschnürer
Tonsil Snares
Serre-nœud à amygdales
Cierranudos para amígdalas
Serranodi per tonsille

TONSILLEN

TONSILS

AMYGDALES

AMÍGDALAS

TONSILLE

Tonsillotome
Tonsillotomes
Amygdalotomes
Amigdalótomos
Tonsillotomi

ZEPF®
α
INSTRUMENTS

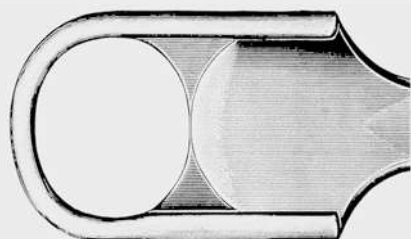
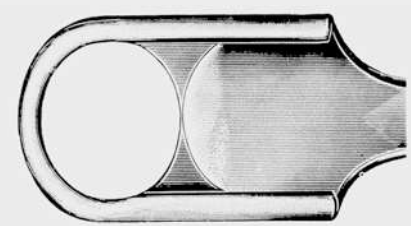
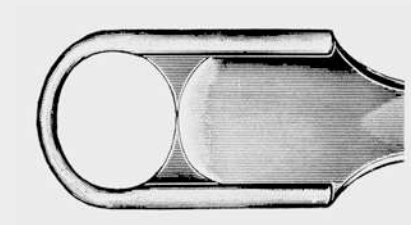

SLUDER-BALLENGER
50-2700-00

mit 3 Aufsätzen
with 3 blades
avec 3 lames
con 3 hojas
con 3 lame

Tonsillotome
Tonsillotomes
Amygdalotomes
Amigdalótomos
Tonsillotomi

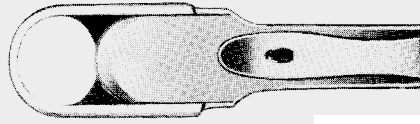

50-2801-16

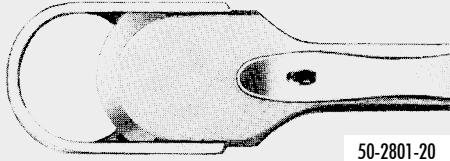

50-2801-20

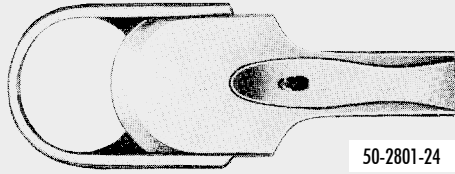

50-2801-24

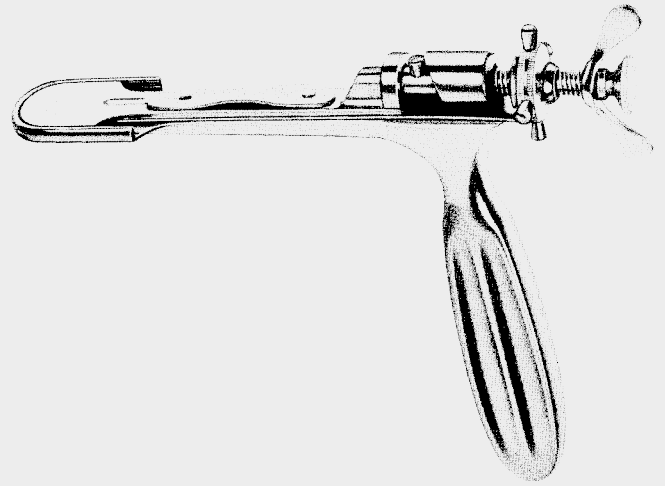

Messer allein - knife only - couteau seul - cuchillo solo - coltello solo	
mm	
16	50-2801-16
20	50-2801-20
24	50-2801-24

mm	DANIELS
16	50-2800-16
20	50-2800-20
24	50-2800-24

TONSILLEN

TONSILS

AMYGDALES

AMÍGDALAS

TONSILLE



ø mm	HARTMANN
13	50-2820-13
15	50-2820-15
17	50-2820-17

Tonsillenstanze
Tonsil Punch
Pince coupante à amygdales
Pinza cortante para amígdalas
Pinza tagliente per tonsille

Tonsillenspritze und -kanülen
Tonsil Syringe and Needles
Seringue à amygdales et aiguilles
Jeringa para amígdalas y agujas
Siringa per tonsille ed aghi

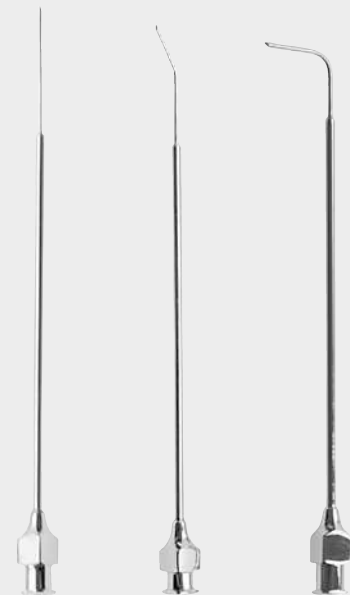

50-2902-00

50-2903-45

50-2903-90

45°

90°

KEHLKOPF

LARYNX

LARYNX

LARINGE

LARINGE

Tamponpinzetten, Kehlkopfpolypenzangen
 Tampon Forceps, Laryngeal Polypus Forceps
 Pincés porte-tampon, Pince à polypes laryngiens
 Pinzas porta taponés, Pinzas para pólipos laríngeos
 Pinze per tamponi, Pinza per polipi laringei

KEHLKOPF

LARYNX

LARYNX

LARINGE

LARINGE

Kehlkopfpolypenzangen, Kehldeckelhalter
 Laryngeal Polypus Forceps, Epiglottis Retractor
 Pincés à polypes laryngiens, Dépresseur d'épiglotte
 Pinzas para pólipos laríngeos, Depresor de epiglotis
 Pinze per polipi laringei, Depressore epiglottico



52-1001-22 52-1003-22

cm JACKSON
 22,0 52-1001-22 - 52-1003-22

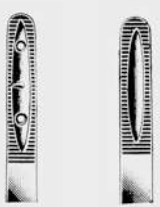

cm FRAENKEL
 18,0 52-1101-18

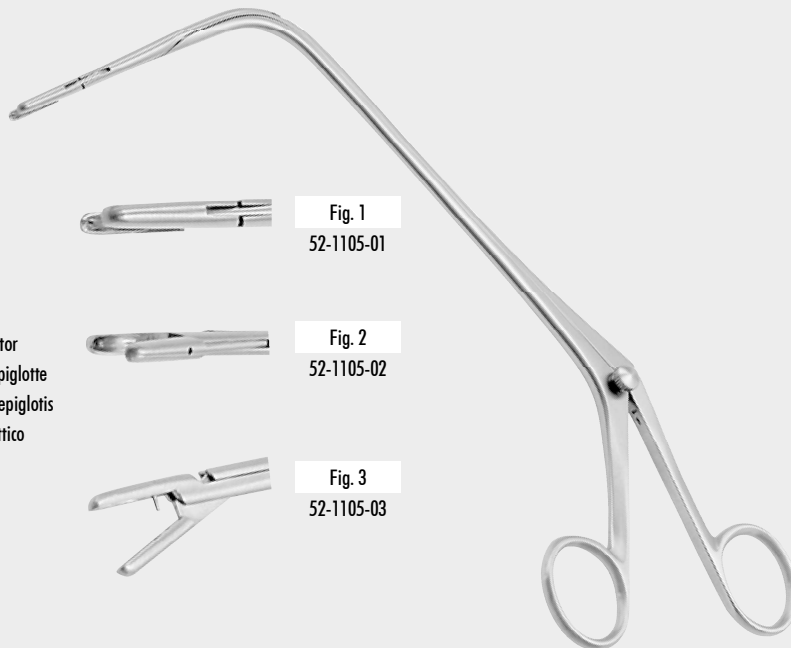

cm JURASZ
 23,0 52-1105-01 - 52-1105-04

Fig. 1
 52-1105-01

Fig. 2
 52-1105-02

Fig. 3
 52-1105-03

Fig. 4
 52-1105-04



cm REICHERT
 24,0 52-1201-24



cm BRUENINGS
20,0 52-1301-20



HUBER
52-1300-00



cm BRUENINGS
20,0 52-1302-20
30,0 52-1302-30
40,0 52-1302-40
50,0 52-1302-50
60,0 52-1302-60

Universalgriff, Verlängerungsrohre
Universal Handle, Extension Tubes
Manche universel, Tubes-rallonges
Mango universal, Tubos alargaderos
Manico universale, Tubi-allunghi



FRAENKEL
52-1500-00



SEIFFERT
52-1502-00



FRAENKEL
52-1504-00

KEHLKOPF



SCHEINMANN
52-1505-00



SCHEINMANN
52-1507-00



BRUENINGS
52-1508-02 - 52-1508-03

52-1508-02

52-1508-03

LARYNX

LARYNX

LARINGE

52-1600-02

52-1600-03

52-1604-01

52-1604-02

LARINGE



BRUENINGS
52-1600-02 - 52-1600-03



LANGE
52-1602-00



KRAUSE
52-1604-01 - 52-1604-02

52-1608-01

52-1608-02

52-1608-03

52-1608-04

Auswechselbare Zangenaufsätze
Cutting and Grasping Forceps Tips
Pincers interchangeable
Pinzas intercambiables
Pinze intercambiabili



KRAUSE
52-1606-00



CORDES
52-1608-01 - 52-1608-04



SCHUMACHER
52-1700-00

52-1702-01

52-1702-02



CORDES
52-1702-01 - 52-1702-02



CORDES
52-1704-00



ROSENBERG
52-1706-00

Laryngoskopie-, Broncho-
Oesophagoskopie-Zangen
Laryngoscopic, Broncho-
Esophageal Forceps
Pinces laryngoscopiques et
broncho-ésophagiennes
Pinzas laringoscópicas y
bronco-esofagoscópicas
Pinze laringoscopiche e
broncho-esofagoscopiche

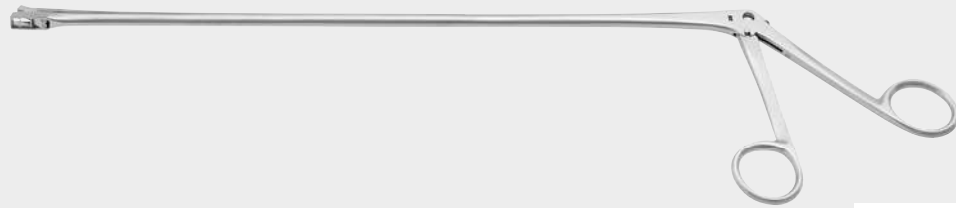

CHEVALIER-JACKSON
52-2300-01 - 52-2600-07



cm	Fig. 1	Fig. 2	Fig. 3	Fig. 4	Fig. 5	Fig. 6	Fig. 7
30,0	52-2300-01	52-2300-02	52-2300-03	52-2300-04	52-2300-05	52-2300-06	52-2300-07
40,0	52-2400-01	52-2400-02	52-2400-03	52-2400-04	52-2400-05	52-2400-06	52-2400-07
50,0	52-2500-01	52-2500-02	52-2500-03	52-2500-04	52-2500-05	52-2500-06	52-2500-07
60,0	52-2600-01	52-2600-02	52-2600-03	52-2600-04	52-2600-05	52-2600-06	52-2600-07

KEHLKOPF

LARYNX

LARYNX

LARINGE

LARINGE

Mikrolaryngoskopie-Zangen und -Scheren
Microlaryngoscopic Forceps and Scissors
Pinces et ciseaux microlaryngoscopiques
Pinzas y tijeras micro-laringoscópicas
Pinze e forbici microlaringoscopiche

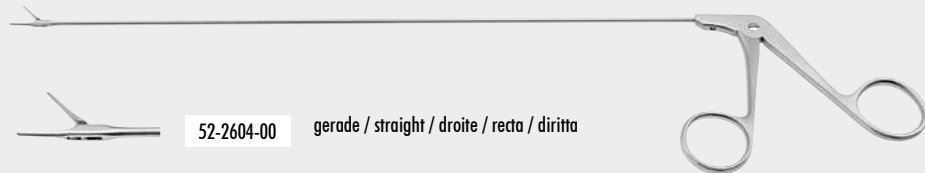

	52-2604-00	gerade / straight / droite / recta / diritta
	52-2604-01	links / left / à gauche / a la izquierda / sinistra
	52-2604-02	rechts / right / à droite / a la derecha / destra
	52-2604-04	gerade / straight / droite / recta / diritta
	52-2604-05	links / left / à gauche / a la izquierda / sinistra
	52-2604-06	rechts / right / à droite / a la derecha / destra
	52-2604-07	aufwärts / upward / courbe vers le haut / curva hacia arriba / curva in alto
	52-2604-10	gerade / staight / droite / recta / diritta
	52-2604-11	links / left / à gauche / a la izquierda / sinistra
	52-2604-12	rechts / right / à droite / a la derecha / destra
	52-2604-13	aufwärts / upward / courbe vers le haut / curva hacia arriba / curva in alto

für Kinder
Child size
pour enfants
para niños
per bambini

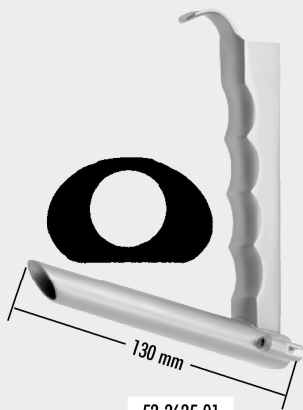

52-2625-01

für die vordere Kommissur
Anterior Commissure
pour la commissure antérieure
para la comisura anterior
per la commisura anteriore

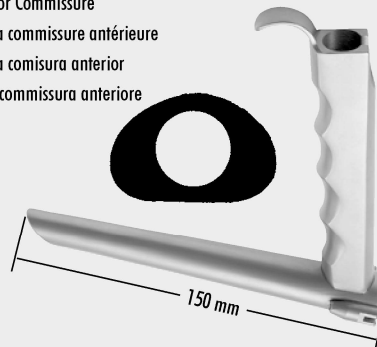

52-2625-02

klein
small
petit
pequeño
piccolo

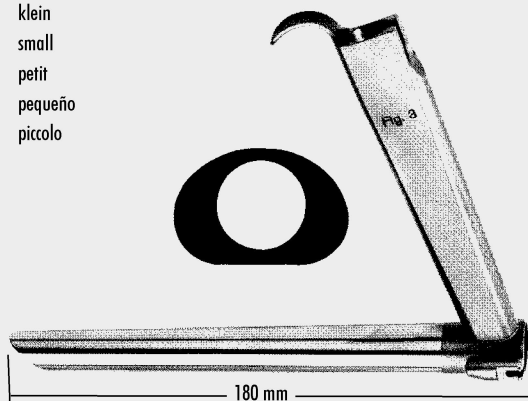

52-2625-03

mittlere Größe
medium size
grandeur moyenne
tamaño mediano
grandezza media

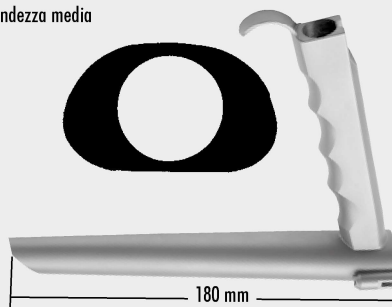

52-2625-04

groß, für Erwachsene
large size, adult
grand modèle, pour adultes
modelo grande, para adultos
modello grande, per adulti

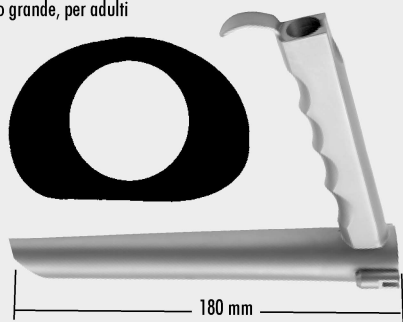

52-2625-05

für die vordere Kommissur
Anterior Commissure
pour la commissure antérieure
para la comisura anterior
per la commisura anteriore

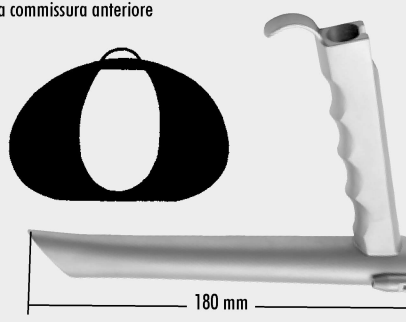

52-2625-06

für die vordere Kommissur, besonders für langen Hals
anterior commissure, especially for long neck
pour la commissure antérieure, spécialement pour cou long
para la comisura anterior, especialmente para cuello largo
per la commisura anteriore, specialmente per collo lungo

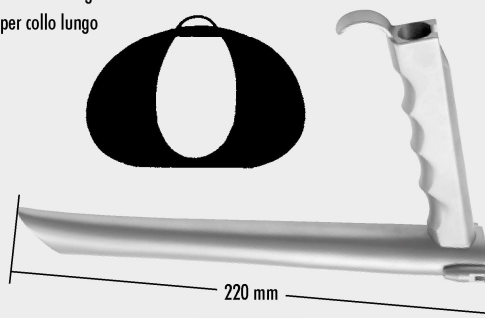

52-2625-07

Operations-Laryngoskope
Operating Laryngoscopes
Laryngoscopes à opération
Laringoscopios para operación
Laringoscopi per operazione

KEHLKOPF

LARYNX

LARYNX

LARINGE

LARINGE

Bruststütze für Operationslaryngoskope
 Chest Support for Operating Laryngoscopes
 Support de poitrine pour laryngoscopes à opération
 Soporte de pecho para laringoscopios de operación
 Supporto di petto per laringoscopi per operazione



52-2630-00

Bruststütze komplett mit Stab 34 cm für Erwachsene

Chest Support complete with rod 34 cm for adults

Support de poitrine complet avec barre de support 34 cm pour adultes

Soporte de pecho completo con barra de soporte 34 cm para adultos

Supporto di petto completo con barra da supporto 34 cm per adulti

52-2630-01

Stützstange für Kinder allein 24 cm

Rod only child size 24 cm

Barre de support seul pour enfants 24 cm

Barra de soporte suelta para niños 24 cm

Barra da supporto per bambini solo 24 cm

KEHLKOPF

LARYNX

LARYNX

LARINGE

LARINGE

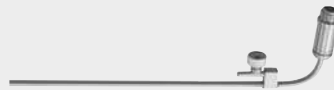

cm Fig. 1-2

13,8 52-2640-01



cm Fig. 3-6

16,5 52-2640-02

ø 3,5 mm

Fiberglas Lichtträger

Fibre Glass Light Carriers

Conducteurs de lumière en fibres de verre

Conductores de luz de fibra de vidrio

Condottieri di luce di fibra di vetro

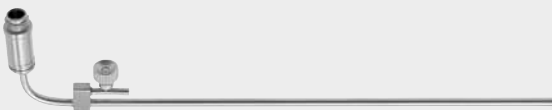

cm Fig. 7

21,0 52-2640-03



52-2650-01

Kanüle für Injektionsbeatmung

Cannula for injection respiration

Canule pour respiration par injection

Cánula para respiración por inyección

Cannula per respirazione per iniezione

Saugrohr für Rauchabsaugung bei Laser-Behandlung

Aspirating Tube for smoke evacuation during Laser treatment

Tube d'aspiration pour l'évacuation des fumées pendant le traitement par Laser

Tubo de aspiración para la evacuación del humo durante el tratamiento por Laser

Tubo di aspirazione per la evacuazione del fumo durante il trattamento con Laser

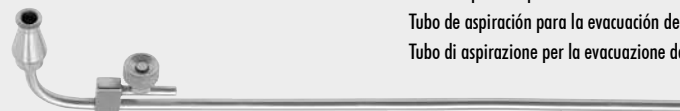

52-2660-01



52-2700-06 - 52-2700-30

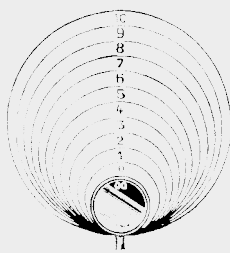

	Fig.	mm	
52-2700-06	000	6	52-2702-06
52-2700-08	00	8	52-2702-08
52-2700-10	0	10	52-2702-10
52-2700-12	1	12	52-2702-12
52-2700-14	2	14	52-2702-14
52-2700-16	3	16	52-2702-16
52-2700-18	4	18	52-2702-18
52-2700-20	5	20	52-2702-20
52-2700-22	6	22	52-2702-22
52-2700-24	7	24	52-2702-24
52-2700-26	8	26	52-2702-26
52-2700-28	9	28	52-2702-28
52-2700-30	10	30	52-2702-30

Ohne Griff
without handle
sans manche
sin mango
senza manico

Mit Griff
with handle
avec manche
con mango
con manico



52-2702-06 - 52-2702-30

Kehlkopfspiegel, Griffe
Laryngeal Mirrors, Handles
Miroirs laryngiens, manches
Espejos laringeos, mangos
Specchi laringei, manici

KEHLKOPF

LARYNX

LARYNX

LARINGE

LARINGE



52-2704-12



52-2706-10

mit Saugunterbecher
with interruptor
avec interrupteur
con interruptor
con interruttore

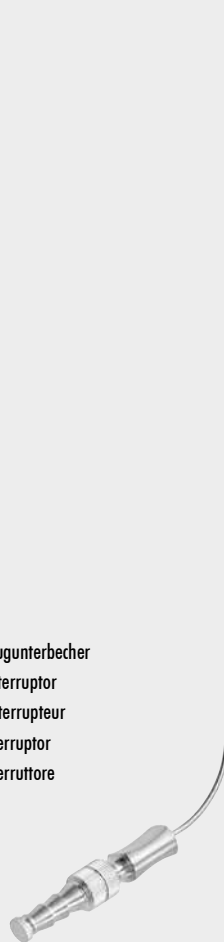

ø mm	
2,0	52-2725-20
2,5	52-2725-25
3,0	52-2725-30
	25,0 cm

Saugrohre
Aspirating Tubes
Tubes d'aspiration
Tubos de aspiración
Tubi di aspirazione



KEHLKOPF

LARYNX

LARYNX

LARINGE

LARINGE

TRACHEOTOMIE, KROPF

TRACHEOTOMY, GOITRE

TRACHEOTOMIE, GOITRE

TRAQUEOTOMIA, BOCIO

TRACHEOTOMIA, GOZZO

Tracheotomie-Trokare, -Dilatatoren
 Tracheotomy Trocars, Dilators
 Trocarts à trachéotomie, Dilateurs
 Trócares para traqueotomía, Diladores
 Trequarti per tracheotomia, Dilatori

**TRACHEOTOMIE,
 KROPF**



cm UCKERMANN
 13,0 54-1001-75 - 54-1001-90

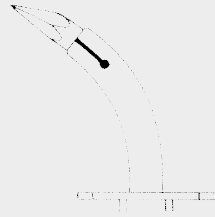

54-1001-75
 7,5 mm

54-1001-90
 9,0 mm



cm TROUSSEAU
 12,0 54-1101-12
 14,0 54-1101-14

cm LABORDE
 12,5 54-1103-12
 14,0 54-1103-14

**TRACHEOTOMY,
 GOITRE**

**TRACHEOTOMIE,
 GOITRE**

**TRAQUEOTOMIA
 BOCIO**

**TRACHEOTOMIA
 GOZZO**

Trachealsperrer, -häkchen
 Tracheal Retractors
 Écarteurs à trachéotomie
 Separadores para traqueotomía
 Divaricatori per tracheotomia



cm BOSE
 7,0 54-1105-07



cm JACKSON
 15,0 54-1106-15



cm JACKSON
 17,0 54-1107-17



cm ITERSON
 16,0 54-1108-16 - 54-1109-16



54-1108-16



54-1109-16



cm BOSE
16,0 54-1202-16



cm BOSE
16,0 54-1204-16

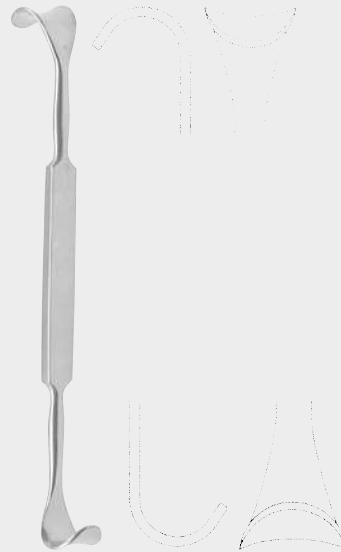

cm ROSE
13,0 54-1300-13

Tracheotomie-Häkchen,
Lebensretter
Tracheotomy Retractors,
Intubation Tubes
Écarteurs à trachéotomie,
tubes à intubation
Separadores para traqueotomía,
tubos de intubación
Divaricatori per tracheotomia,
cannule per intubazione

TRACHEOTOMIE,
KROPF

TRACHEOTOMY,
GOITRE

TRACHEOTOMIE,
GOITRE

TRAQUEOTOMIA
BOCIO

TRACHEOTOMIA
GOZZO

Reinigungsbürste
Cleaning Brush
Brosse à nettoyer
Cepillo de limpieza
Spazzola di pulizia



cm ø 12 mm
26,0 54-2701-26



cm HUPP
15,0 54-1302-15



mm WAGNER-MOSHER
5 54-1501-05
7 54-1501-07
9 54-1501-09

Kropfsonden, Schilddrüsensperrer
 Goitre Directors, Thyroid Retractor
 Spatules à goitre, Écarteur thyroïdien
 Sondas para bocio, Separador de tiroide
 Sonde per gozzo, Divaricatore per tiroide

TRACHEOTOMIE, KROPF

TRACHEOTOMY, GOITRE

TRACHEOTOMIE, GOITRE

TRAQUEOTOMIA BOCIO

TRACHEOTOMIA GOZZO

Schilddrüsenhaken,
 Kropffasszangen, Muskelklemme
 Thyroid Retractor, Goitre Seizing
 Forceps, Muscle Clamp
 Écarteur à thyroïde, Pinces à saisir
 le goitre, Pinces musculaires
 Separador de tiroide, Pinzas para
 sacar bocio, Pinzas musculares
 Divaricatore per tiroide, Pinze per
 afferrare gozzo, Pinze muscolari

11 mm



cm KOCHER
15,0 54-5001-15 - 54-5003-15

54-5001-15

54-5003-15

12 mm



cm KOCHER
17,0 54-5011-17



cm SCHOENBORN
21,0 54-5101-21



cm JOLL
15,0 54-5102-15



cm LAHEY
15,0 54-5200-15
20,0 54-5200-20



cm MASTIN
17,0 54-5203-17

THORAX

THORAX

THORAX

TÓRAX

TORACE



Rippenscheren
Rib Shears
Costotomes
Costótomos
Costotomi

THORAX

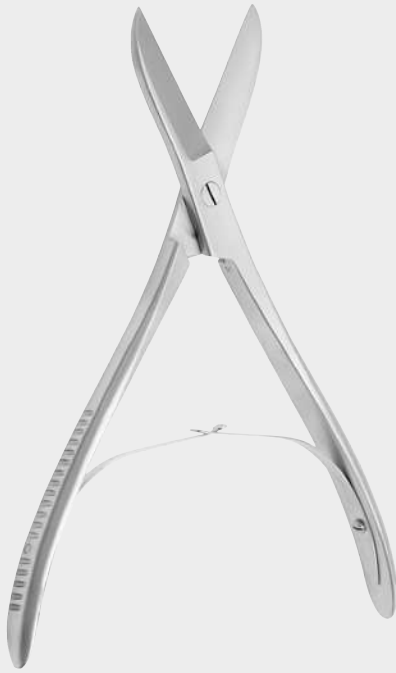

cm
23,0 56-1002-23



cm
22,0 56-1005-22



cm GLUCK
22,0 56-1007-22

THORAX

THORAX

TÓRAX

TORACE



cm COLLIN
19,5 56-1011-19



cm STILLE
21,0 56-1101-21



cm CORYLLOS »
35,0 56-1203-35



cm CORYLLOS «
35,0 56-1205-35



cm BETHUNE
34,0 56-1206-34



cm COOLEY
35,0 56-1208-35



cm SAUERBRUCH BRITSCH
30,0 56-1305-30

mit 2 Schneide Köpfen
with 2 chutter heads
avec 2 têtes de coupe
con 2 cabezales de corte
con 2 teste di taglia



cm SAUERBRUCH
24,0 56-1301-24
26,0 56-1301-26



cm GIERTZ-STILLE
27,0 56-1307-27

Rippenscheren
Rib Shears
Costotomes
Costótomos
Costotomi

THORAX

THORAX

THORAX

TÓRAX

TORACE



cm SAUERBRUCH-FREY
36,0 56-1401-36



cm BRUNNER
32,0 56-1407-32 »
33,0 56-1407-33 «



cm SCHUMACHER
21,0 56-1408-21

für Sternum
for sternum
pour le sternum
para el esternón
per lo sterno

Rippensperrer
Rib Spreaders
Écarteurs des côtes
Separadores costales
Divaricatori costali

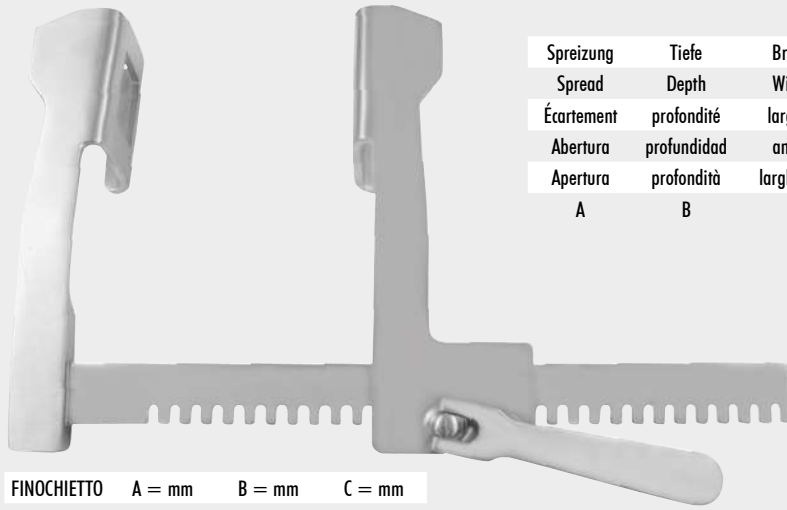

Spreizung	Tiefe	Breite
Spread	Depth	Width
Écartement	profondité	largeur
Abertura	profundidad	ancho
Apertura	profondità	larghezza
A	B	C

FINOCHIETTO	A = mm	B = mm	C = mm
56-2100-16	165	40	40
56-2100-20	200	45	65
56-2100-25	250	70	65
56-2100-30	300	70	65

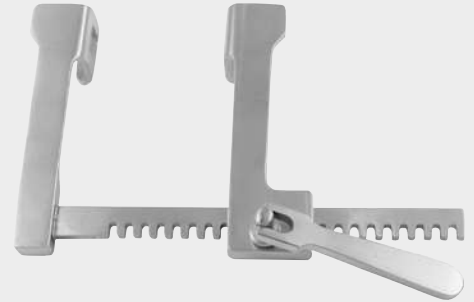

FINOCHIETTO-Baby	A = mm	B = mm	C = mm
56-2104-75	75	18	20

THORAX

THORAX

THORAX

TÓRAX

TORACE

Aus Aluminium - from Aluminium -
en aluminium - de aluminio - in alluminio

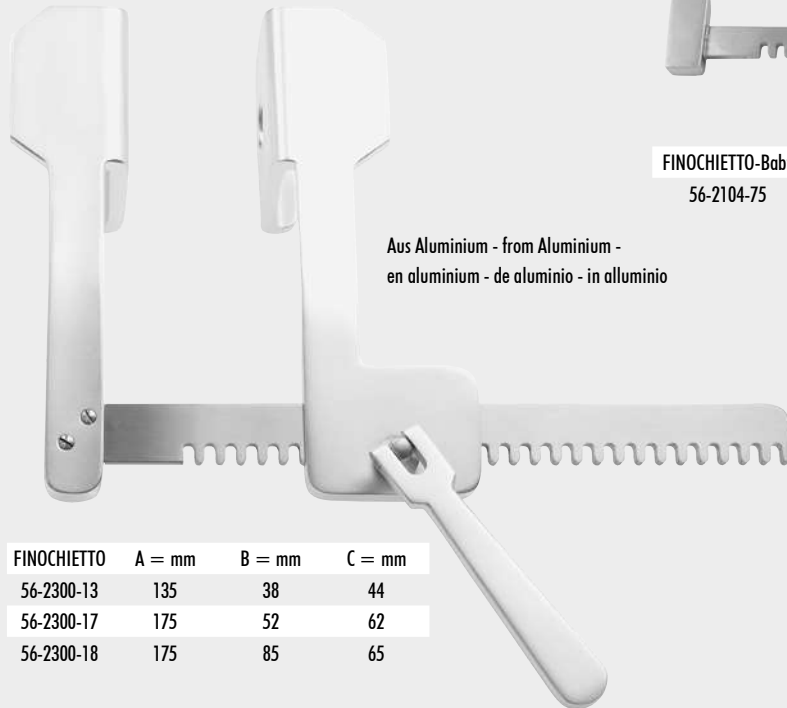

FINOCHIETTO	A = mm	B = mm	C = mm
56-2300-13	135	38	44
56-2300-17	175	52	62
56-2300-18	175	85	65

Aus Aluminium - from Aluminium -
en aluminium - de aluminio - in alluminio

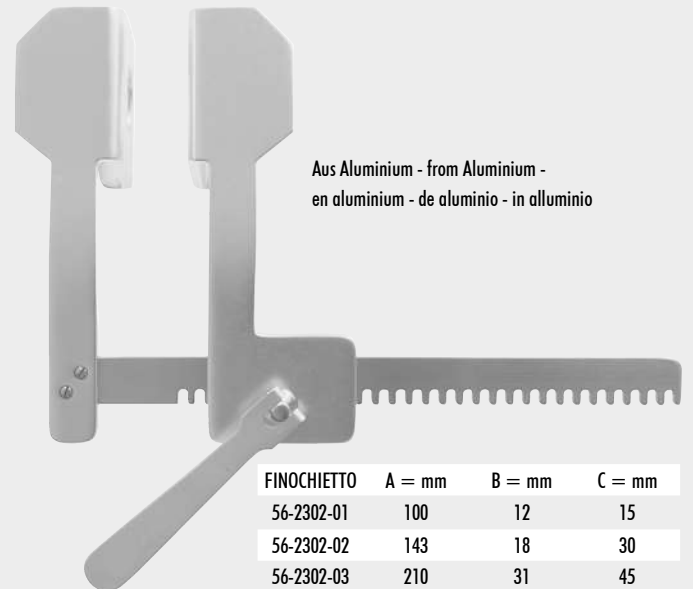

FINOCHIETTO	A = mm	B = mm	C = mm
56-2302-01	100	12	15
56-2302-02	143	18	30
56-2302-03	210	31	45
56-2302-04	245	42	61



Aus Aluminium - from Aluminium -
en aluminium - de aluminio - in alluminio

FINOCHIETTO-Infant	A = mm	B = mm	C = mm
56-2304-75	75	15	15

Spreizung	Tiefe	Breite
Spread	Depth	Width
Écartement	profondité	largeur
Abertura	profundidad	ancho
Apertura	profondità	larghezza
A	B	C

70 x 65 mm

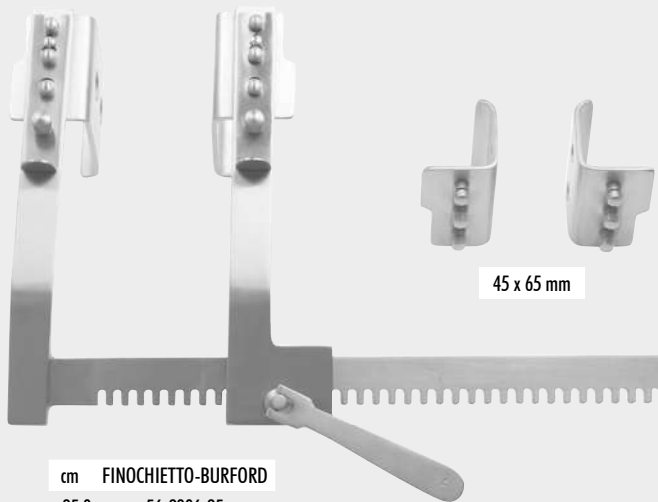

cm FINOCHIETTO-BURFORD
25,0 56-2306-25

45 x 65 mm



FINOCHIETTO-Baby	A = mm	B = mm	C = mm
56-2305-10	100	31	31

Aus Aluminium - from Aluminium -
en aluminium - de aluminio - in alluminio

Aus Aluminium - from Aluminium -
en aluminium - de aluminio - in alluminio

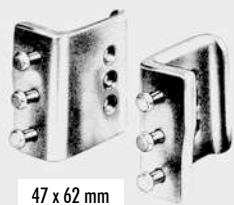

47 x 62 mm

Aus Aluminium - from Aluminium -
en aluminium - de aluminio - in alluminio

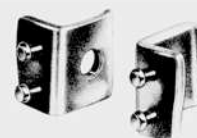

34 x 42 mm

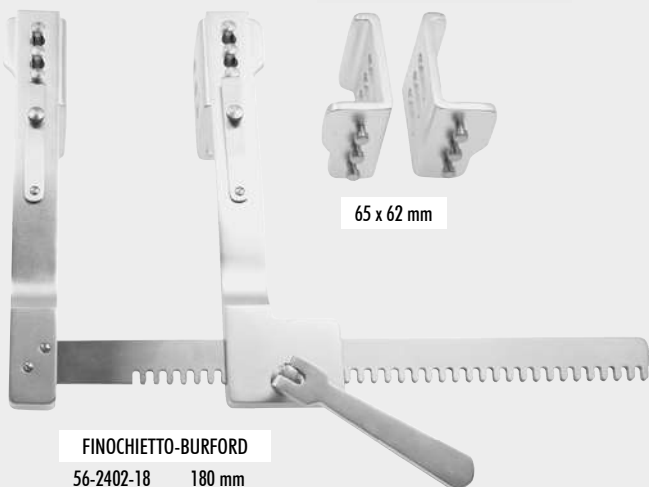

FINOCHIETTO-BURFORD	
56-2402-18	180 mm
56-2402-26	260 mm
56-2402-30	300 mm



65 x 62 mm

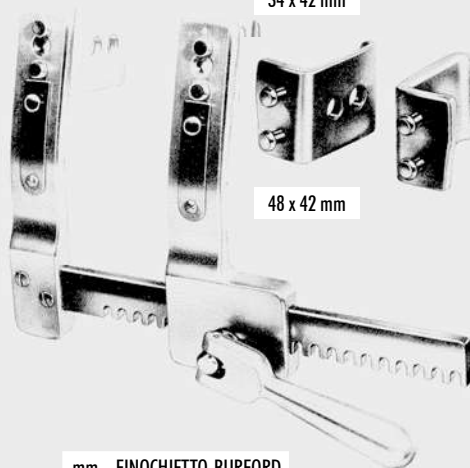

mm FINOCHIETTO-BURFORD
135 56-2404-13

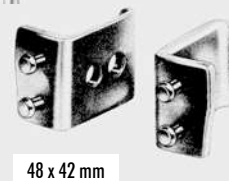

48 x 42 mm

Für Erwachsene - Adult Size - pour adultes -
para adultos - per adulti

Für Kinder - Child Size - pour enfants -
para niños - per bambini

Rippensperrer
Rib Spreaders
Écarteurs des côtes
Separadores costales
Divaricatori costali

THORAX

THORAX

THORAX

TÓRAX

TORACE

Aus Aluminium - from Aluminium -
en aluminium - de aluminio - in alluminio

Spreizung	Tiefe	Breite
Spread	Depth	Width
Écartement	profondité	largeur
Abertura	profundidad	ancho
Apertura	profondità	larghezza
A	B	C

COOLEY	A = mm	B = mm	C = mm
56-2480-01	95	12	16
56-2480-02	140	15	30
56-2480-03	150	21	44
56-2480-04	200	35	50

Rippensperrer
Rib Spreaders
Écarteurs des côtes
Separadores costales
Divaricatori costali

THORAX

THORAX

THORAX

TÓRAX

TORACE



Aus Aluminium - from Aluminium -
en aluminium - de aluminio - in alluminio



Aus Aluminium - from Aluminium -
en aluminium - de aluminio - in alluminio

COOLEY	A = mm	B = mm	C = mm
56-2484-14	145	21	45
56-2484-19	190	32	50

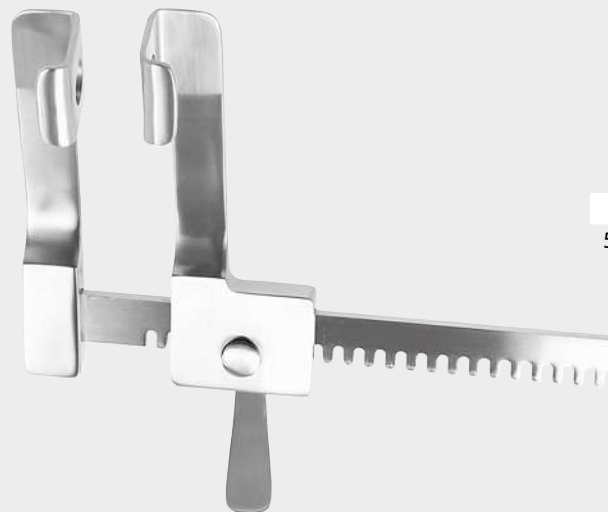

COOLEY	A = mm	B = mm	C = mm
56-2496-12	120	25	32



HARRIS	A = mm	B = mm	C = mm
56-2598-16	160	35	51

CASTAÑEDA	A = mm	B = mm	C = mm
56-2500-06	65	10,5	32
56-2500-07	70	12	45
56-2500-12	120	15	60

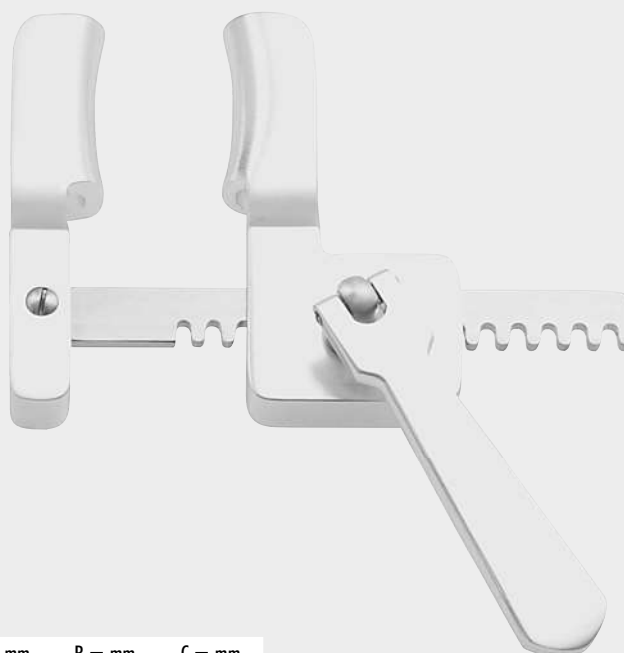

HAIGHT	A = mm	B = mm	C = mm
56-2600-09	90	30	30

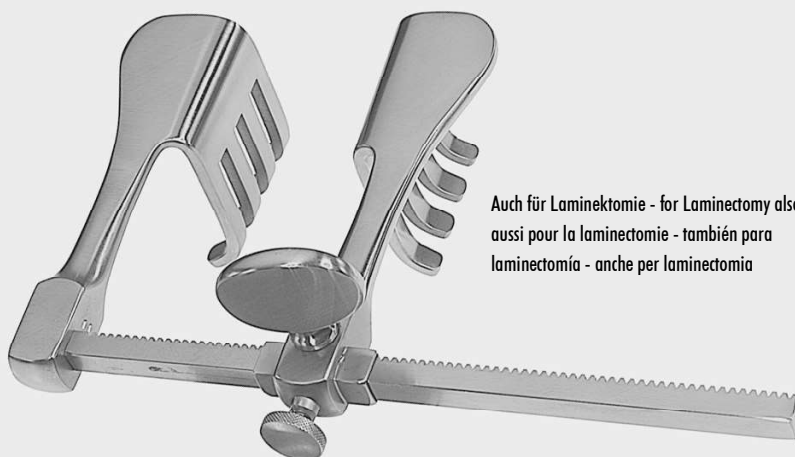

Auch für Laminektomie - for Laminectomy also -
aussi pour la laminectomie - también para
laminectomía - anche per laminectomia

BADGLEY	A = mm	B = mm	C = mm
56-2602-16	162	51	44

Rippensperrer
Rib Spreaders
Écarteurs des côtes
Separadores costales
Divaricatori costali

THORAX

THORAX

THORAX

TÓRAX

TORACE

Rippensperrer
Rib Spreaders
Écarteurs des côtes
Separadores costales
Divaricatori costali



Spreizung	Tiefe	Breite
Spread	Depth	Width
Écartement	profondité	largeur
Abertura	profundidad	ancho
Apertura	profondità	larghezza
A	B	C

TUFFIER	A = mm	B = mm	C = mm
56-2604-16	165	50	45

THORAX

THORAX

THORAX

TÓRAX

TORACE

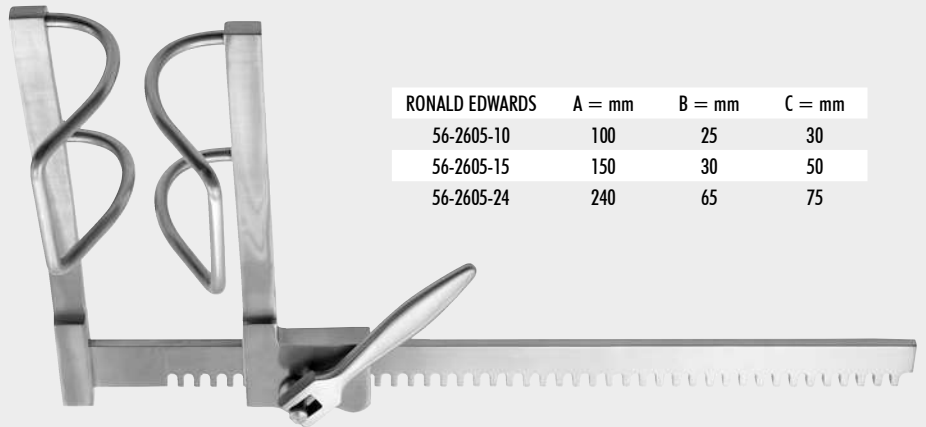

RONALD EDWARDS	A = mm	B = mm	C = mm
56-2605-10	100	25	30
56-2605-15	150	30	50
56-2605-24	240	65	75



Valven allein, Paar:
Blades only, by pairs:
Valves seules, la paire:
Valvas sueltas, la pareja:
Valve sole, la coppia:

56-2606-30	30 mm x 30 mm *	* Tiefe x Breite
56-2606-40	40 mm x 40 mm *	depth x width
56-2606-50	50 mm x 50 mm *	profondeur x largeur
56-2608-40	40 mm x 100 mm *	profundidad x ancho
56-2608-50	50 mm x 80 mm *	profondità x largo
56-2608-60	60 mm x 60 mm *	
56-2608-66	50 mm x 66 mm f. Sternotomie, f. sternotomy, pour la sternotomie, p. esternotomía, p. sternotomia	
56-2608-80	80 mm x 60 mm *	

Sperrer allein, Spreaders only, Ecarteurs seuls,
Separadores sueltos, Divaricatori soli:

56-2606-22	22 cm
56-2608-28	28 cm

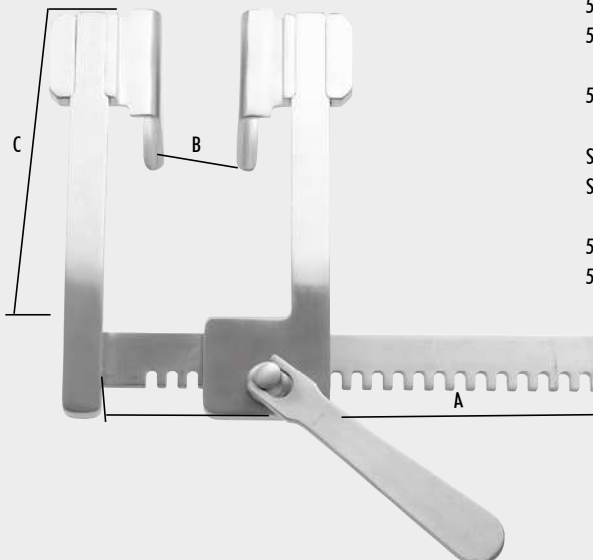

DE BAKEY	A = mm	B = mm	C = mm
56-2606-00	220	150	180
56-2608-00	285	200	225

cm	DE BAKEY, compl.:
22,0	56-2606-00 = incl. 56-2606-22, 56-2606-30, 56-2606-40, 56-2606-50
28,0	56-2608-00 = incl. 56-2608-28, 56-2608-40, 56-2608-50, 56-2608-60

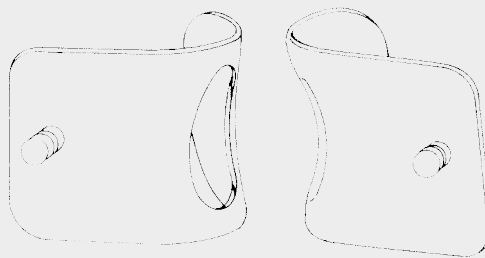

75 x 75 mm

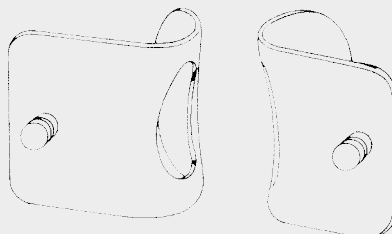

42 x 65 mm

MERCEDES compl. mit 2 Paar Valven - with 2 pairs of blades -
56-2700-00 avec 2 paires de valves - con 2 parejas de valvas -
con 2 paia di valve

Rippensperrer
Rib Spreaders
Écarteurs des côtes
Separadores costales
Divaricatori costali

THORAX

THORAX

THORAX

TÓRAX

TORACE

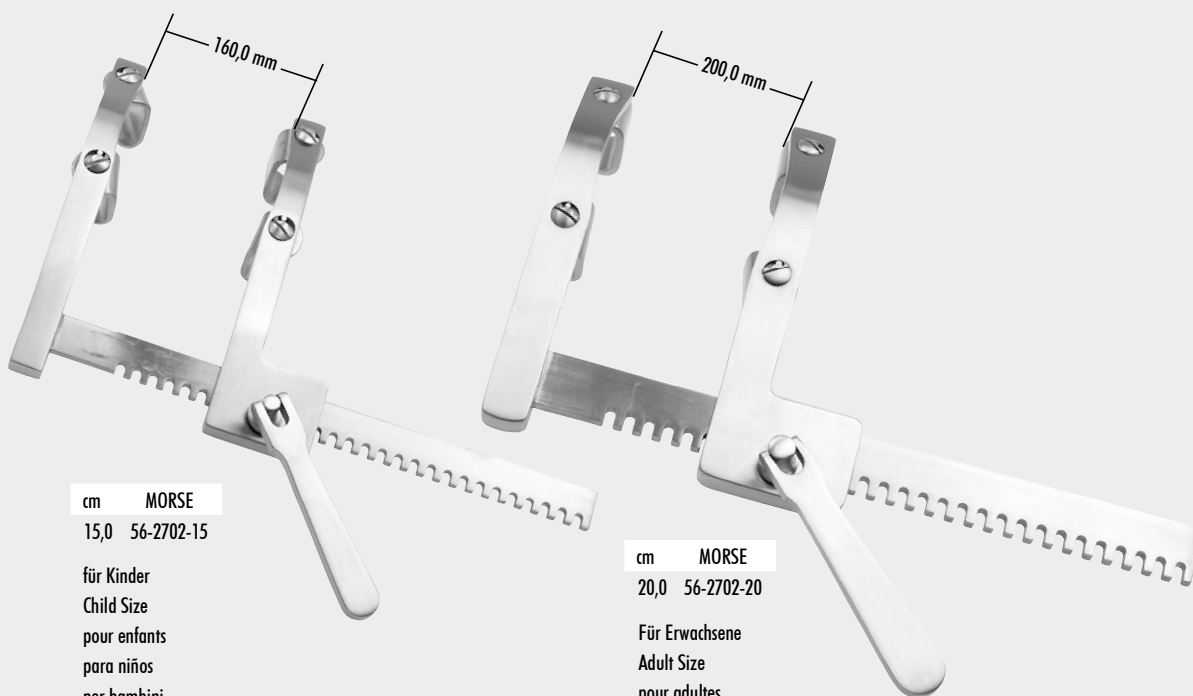

cm MORSE
15,0 56-2702-15

für Kinder
Child Size
pour enfants
para niños
per bambini

cm MORSE
20,0 56-2702-20

Für Erwachsene
Adult Size
pour adultes
para adultos
per adulti

Rippensperrer
Rib Spreaders
Écarteurs des côtes
Separadores costales
Divaricatori costali

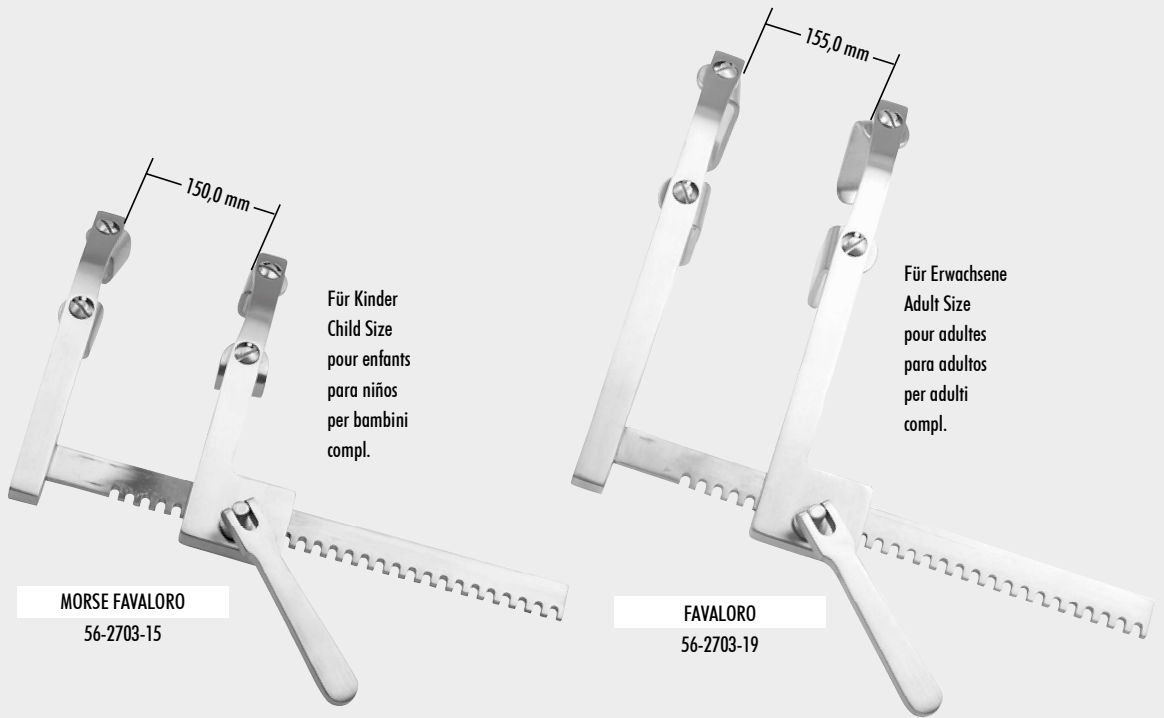

MORSE FAVALORO
56-2703-15

FAVALORO
56-2703-19

THORAX

THORAX

THORAX

TÓRAX

TORACE

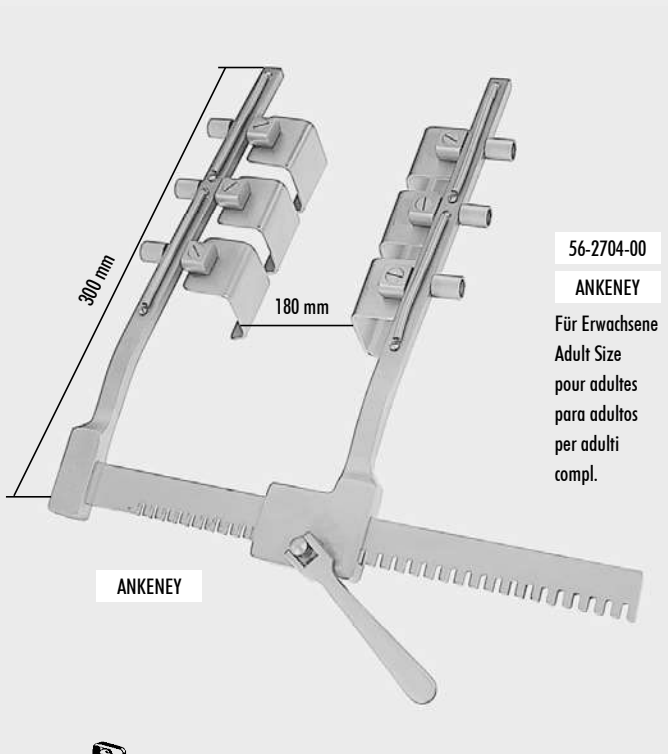

ANKENEY

56-2704-00
ANKENEY

Für Erwachsene
Adult Size
pour adultes
para adultos
per adulti
compl.

mit 6 abnehmbaren Valven
with 6 detachable blades
avec 6 valves démontables
con 6 valvas desmontables
con 6 valve smontabili

56-2704-01

ANKENEY 35 x 32 mm

Satz von 6 Valven allein
Set of 6 blades only
Jeu de 6 valves seules
Juego de 6 valvas sueltas
Set di 6 valve sole

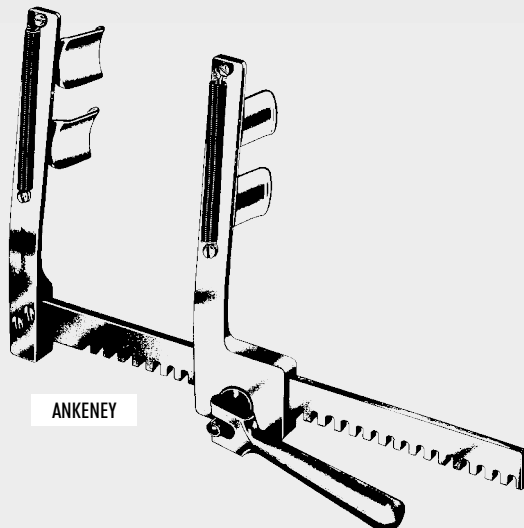

ANKENEY

56-2707-00

Aus Aluminium - from Aluminium -
en aluminium - de aluminio - in alluminio

Für Kinder
Child Size
pour enfants
para niños
per bambini
compl.

mit 4 festen Valven
with 4 fixed blades
avec 4 valves fixes
con 4 valvas fijas
con 4 valve fisse

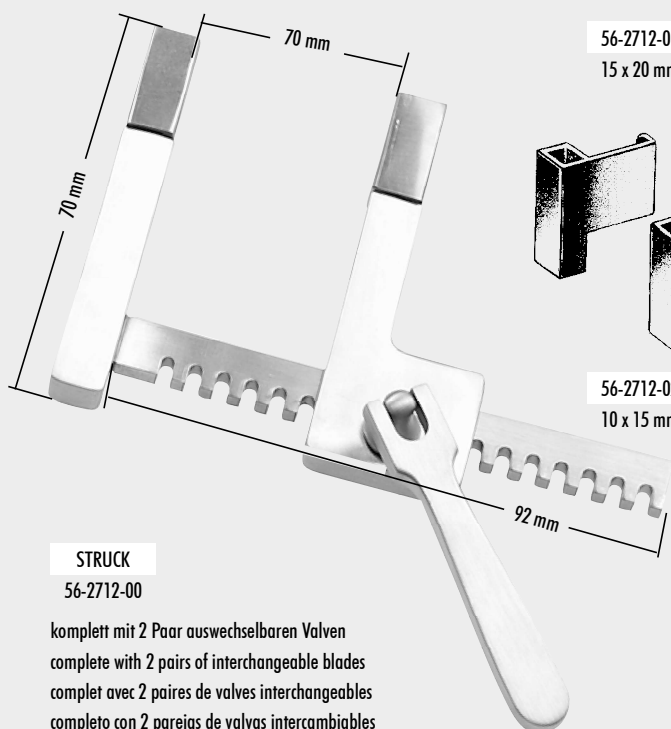

STRUCK
56-2712-00

komplett mit 2 Paar auswechselbaren Valven
complete with 2 pairs of interchangeable blades
complet avec 2 paires de valves interchangeables
completo con 2 parejas de valvas intercambiables
completo di 2 coppie di valve intercambiabili

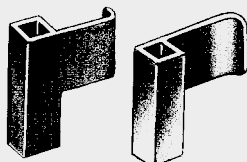

56-2712-01
15 x 20 mm

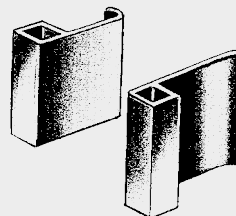

56-2712-03
10 x 20 mm

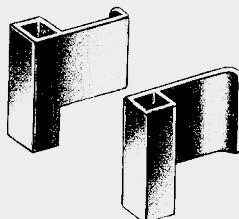

56-2712-02
10 x 15 mm

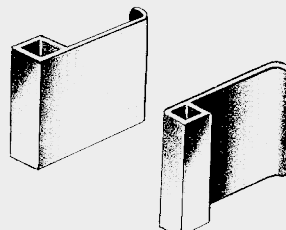

56-2712-04
20 x 20 mm

Rippensperrer
Rib Spreaders
Écarteurs des côtes
Separadores costales
Divaricatori costali

THORAX

THORAX

THORAX

TÓRAX

TORACE

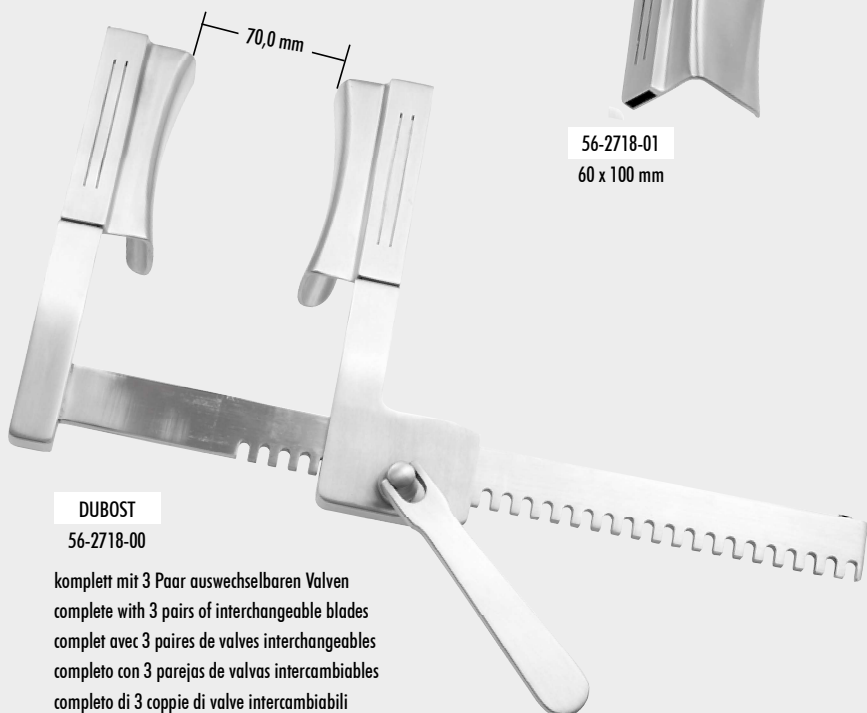

DUBOST
56-2718-00

komplett mit 3 Paar auswechselbaren Valven
complete with 3 pairs of interchangeable blades
complet avec 3 paires de valves interchangeables
completo con 3 parejas de valvas intercambiables
completo di 3 coppie di valve intercambiabili



56-2718-01
60 x 100 mm



56-2718-02
50 x 100 mm



56-2718-03
40 x 100 mm

Rippensperrer
Rib Spreaders
Écarteurs des côtes
Separadores costales
Divaricatori costali

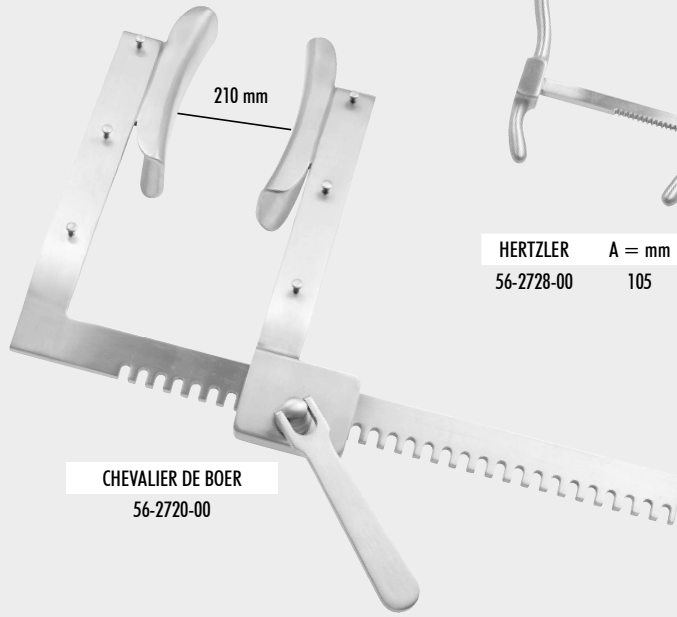

CHEVALIER DE BOER
56-2720-00

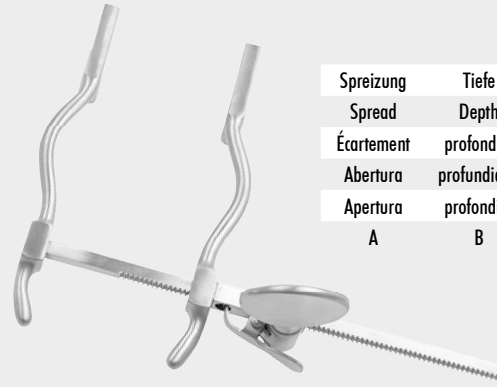

Spreizung	Tiefe	Breite
Spread	Depth	Width
Écartement	profondité	largeur
Abertura	profundidad	ancho
Apertura	profondità	larghezza
A	B	C

HERTZLER	A = mm	B = mm	C = mm
56-2728-00	105	25	25

THORAX

THORAX

THORAX

TÓRAX

TORACE

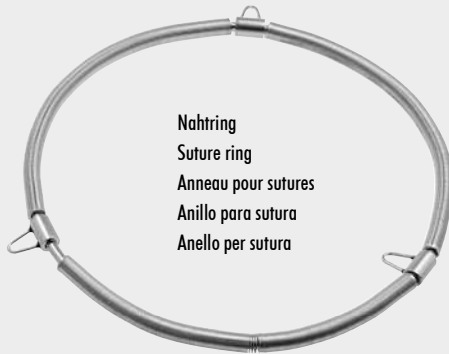

Nahtring
Suture ring
Anneau pour sutures
Anillo para sutura
Anello per sutura

ø mm	CRAWFORD
23,0 cm	56-2740-23



mm x mm	COOLEY 24,0 cm »
45 x 48	56-2760-01



mm x mm	COOLEY 24,5 cm »	~~~~~
45 x 48	56-2760-02	

Atriumhaken
Atrium Retractors
Écarteurs pour l'atrium
Separadores para el atrio
Divaricatori per il atrio



mm x mm	COOLEY 25,5 cm «
25 x 46	56-2760-03



mm x mm	COOLEY STRUCK 24,0 cm
30 x 45	56-2762-01

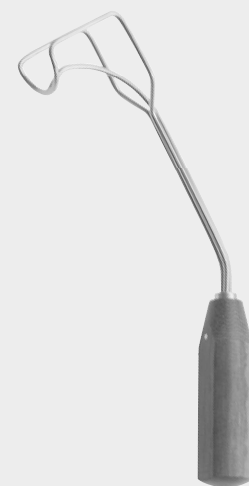

mm x mm	COOLEY STRUCK 24,0 cm	~~~~~
45 x 35	56-2762-02	



mm x mm COOLEY 21,0 cm 
 14 x 17 / 14 x 45 56-2790-01
 14 x 21 / 14 x 45 56-2790-02



mm x mm CRAWFORD 19,0 cm
 15 x 15 56-2792-15
 15 x 23 56-2792-23

Atriumhaken
 Atrium Retractors
 Écarteurs pour l'atrium
 Separadores para el atrio
 Divaricatori per il atrio

THORAX

THORAX

THORAX

TÓRAX

TORACE



cm COOLEY «
 25,5 56-2800-03
 links
 left
 à gauche
 a la izquierda
 sinistro



cm COOLEY »
 24,5 56-2800-02

leicht gezahnt
 slightly serrated
 légèrement dentelé
 ligeramente dentado
 leggermente dentellato



COOLEY
 56-2800-01 - 56-2800-03

cm COOLEY »
 24,5 56-2800-01

Rippen-Konraktoren
 Rib Approximators
 Approximateurs de côtes
 Aproximadores de costillas
 Avvicinatori costali

THORAX



cm SELLORS
 19,0 56-2800-19



cm BAILEY Baby
 14,0 56-2802-14



cm BAILEY
 16,0 56-2804-16



cm BAILEY GIBBON
 16,0 56-2806-16

THORAX

THORAX

TÓRAX

TORACE



cm LEMMON
 14,0 56-2808-14
 18,0 56-2808-18

Sternum-Approximator
 Sternal Approximator
 Approximateur sternal
 Aproximador esternal
 Avvicinatore sternale

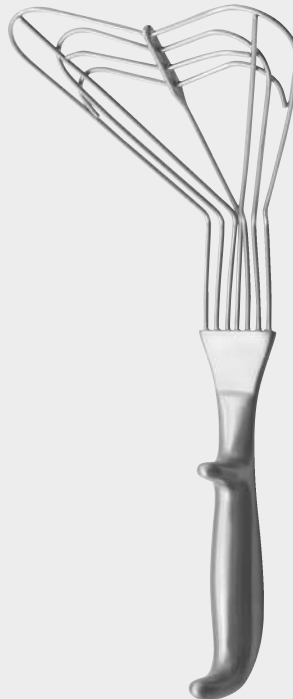

cm
 26,0 56-2809-26

Lungenspatel
 Lung Spatula
 Spatule pulmonaire
 Espátula pulmonar
 Spatola polmonare



cm ALLISON
 30,0 56-2809-30
 32,0 56-2809-32



ROSS Aorta
56-2810-01 - 56-2810-06

flexibler Schaft
flexible shaft
tige flexible
vástago flexible
asta flessibile

mm
12 x 15 56-2810-01



mm
18 x 18 56-2810-02



mm
18 x 22 56-2810-03



mm
25 x 26 56-2810-04



mm
25 x 35 56-2810-05



mm
25 x 20 56-2810-06



Lungen-Fasszangen
Lung Grasping Forceps
Pinces à saisir le poumon
Pinzas para coger el pulmón
Pinze per afferrare il polmone



cm **LOVELACE**
20,0 56-2900-20

cm **LOVELACE**
20,0 56-2901-20



mm x mm	BOROWSKI 27,0 cm
17 x 21	56-2812-01
16 x 23	56-2812-02
20 x 25	56-2812-03
24 x 27	56-2812-04
28 x 20	56-2812-05
28 x 29	56-2812-06



cm **HARRINGTON**
30,5 56-3001-30

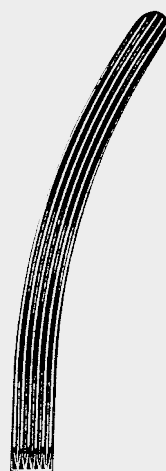

cm **HARRINGTON**
29,5 56-3003-29

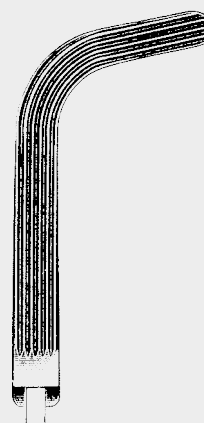

Aorta-Haken
Aortic Retractors
Écarteurs pour l'aorte
Separadores para la aorta
Divaricatori per l'aorta

THORAX

THORAX

THORAX

TÓRAX

TORACE

Bronchus-Klemmen
Bronchus Forceps
Pinces Clamps pour les bronches
Pinzas Clamps bronquiales
Pinze per bronchi

Bronchus-Klemmen
 Bronchus Forceps
 Pinces Clamps pour les bronches
 Pinzas Clamps bronquiales
 Pinze per bronchi

THORAX

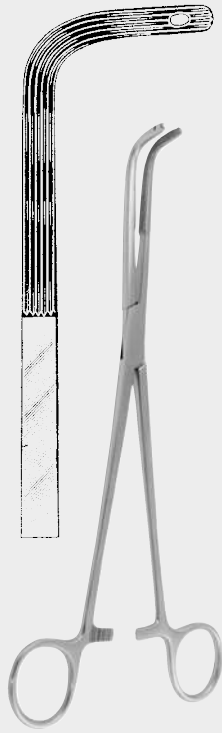

cm FINOCHIETTO
 24,0 56-3007-24



cm PRICE-THOMAS
 22,0 56-3009-22



PRICE-THOMAS
 56-3101-22 22,0 cm 56-3103-22

THORAX

THORAX

Zahn links	Zahn rechts
Tooth left side	Tooth right side
Dents à gauche	Dents à droite
Diente a la izquierda	Diente a la derecha
Dente sinistro	Dente destro

TÓRAX

TORACE



SAROT
 56-3107-23 23,0 cm 56-3109-23

Zahn links	Zahn rechts
Tooth left side	Tooth right side
Dents à gauche	Dents à droite
Diente a la izquierda	Diente a la derecha
Dente sinistro	Dente destro

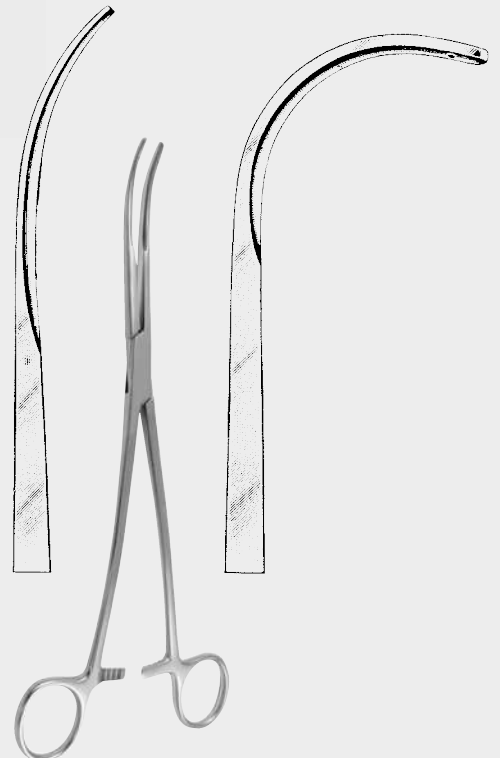

SEMB
 56-3201-23 23,0 cm 56-3203-23

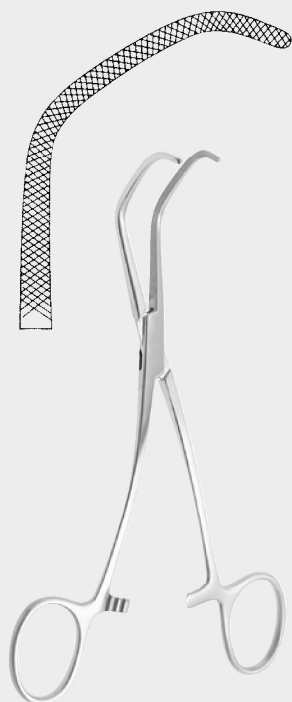

cm SATINSKY
15,0 56-3205-15



cm SATINSKY
26,0 56-3207-26 - 56-3209-26

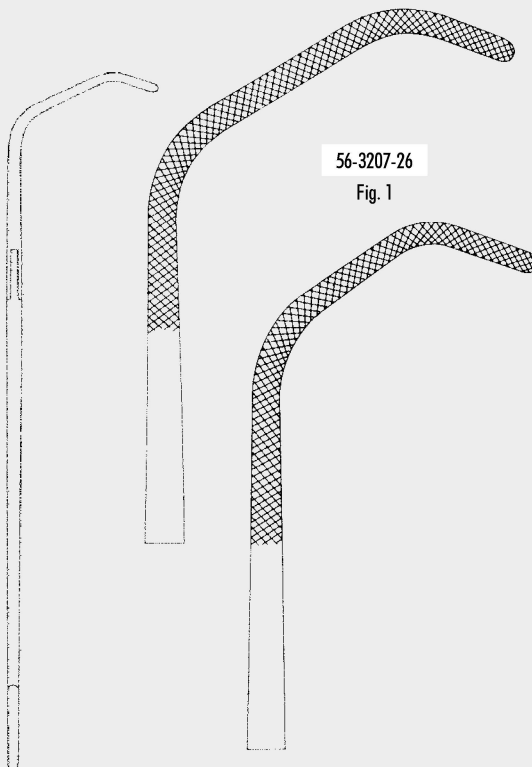

56-3209-26
Fig. 2

56-3207-26
Fig. 1

56-3303-26
Fig. 2

56-3301-26
Fig. 1

Anastomosens-Klemmen
Anastomosis Clamps
Pinces à anastomose
Pinzas para anastomosis
Pinze per anastomosi

THORAX

THORAX

THORAX

TÓRAX

TORACE

Gefäßklemmen
Vascular Forceps
Pincès vasculaires
Pinzas vasculares
Pinze vascolari

THORAX

THORAX

THORAX

TÓRAX

TORACE

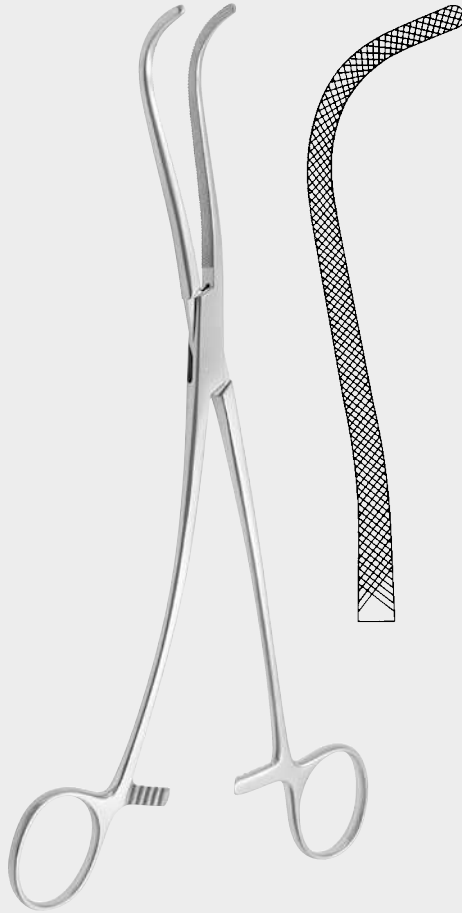

cm HARKEN
24,0 56-3403-24

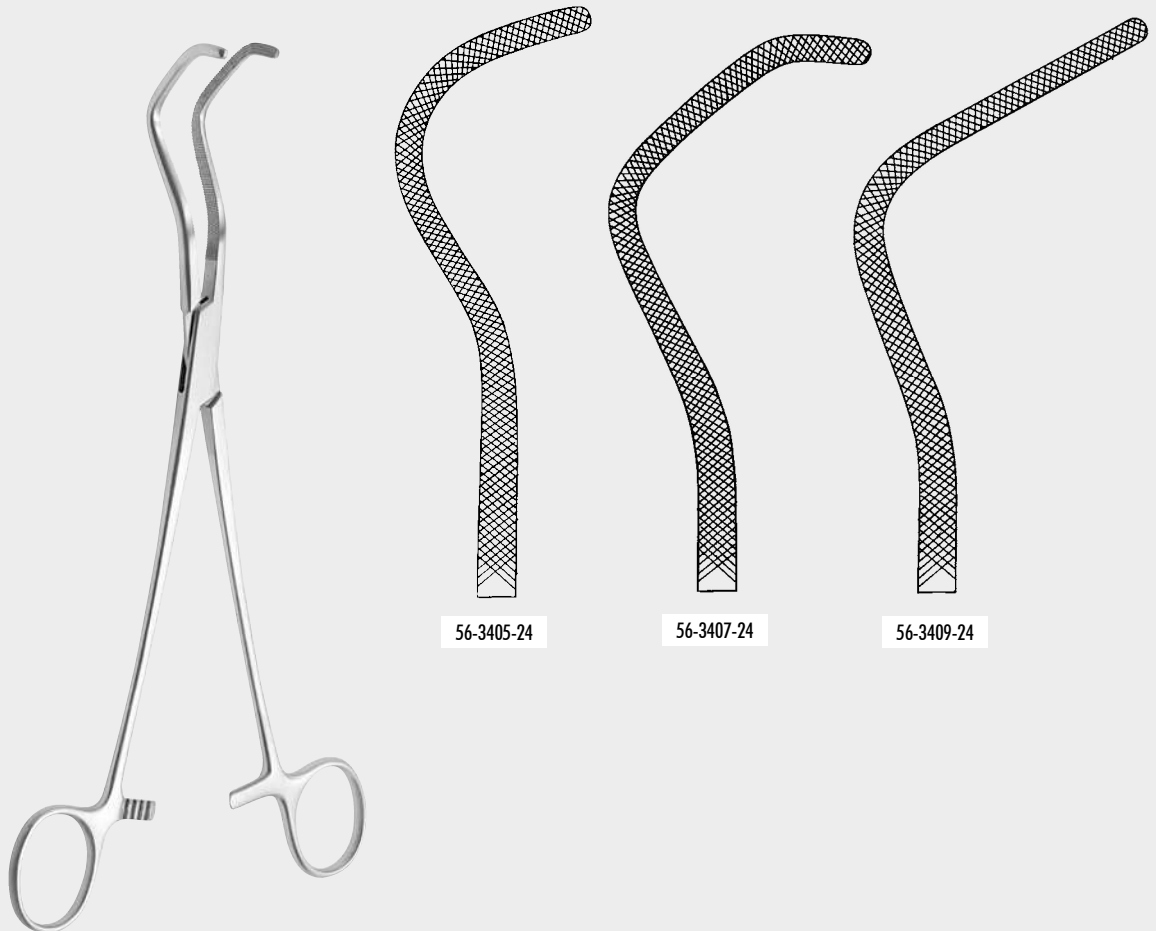

cm HARKEN
24,0 56-3405-24 - 56-3409-24



cm DERRA
18,0 56-3501-18 - 56-3505-18

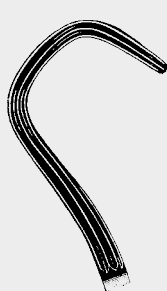

56-3501-18

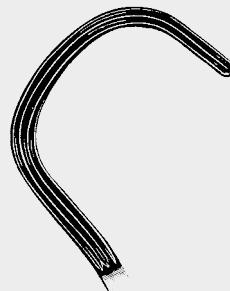

56-3505-18

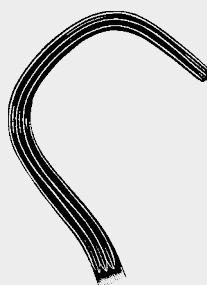

56-3503-18

Gefäßklemmen
Vascular Forceps
Pinces vasculaires
Pinzas vasculares
Pinze vascolari

THORAX

THORAX

THORAX

TÓRAX

TORACE



mm x mm BORST 21,5 cm
15 x 15 56-3510-21



mm RUMMEL BELMONT
3,2 56-4300-32
6,4 56-4300-64



mm
2,0 56-4301-32

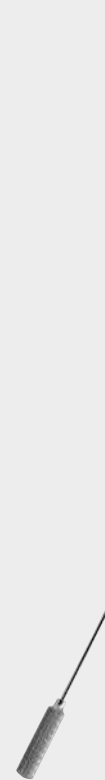

mm
2,5 56-4301-64

Dilatatoren
Dilators
Dilatateurs
Dilatadores
Dilatatori

THORAX

THORAX

THORAX

TÓRAX

TORACE



biegsam
malleable
malléables
maleables
malleabili

cm COOLEY
13,0 56-4700-05 - 56-4700-50



56-4700-05
0,5 mm



56-4700-10
1,0 mm



56-4700-15
1,5 mm



56-4700-20
2,0 mm



56-4700-25
2,5 mm



56-4700-30
3,0 mm



56-4700-40
4,0 mm



56-4700-50
5,0 mm



biegsam
malleable
malléables
maleables
malleabili

cm DE BAKEY
19,0 56-4702-05 - 56-4702-90
35,0 56-4704-05 - 56-4704-90



56-4702-05
56-4704-05
0,5 mm



56-4702-10
56-4704-10
1,0 mm



56-4702-15
56-4704-15
1,5 mm



56-4702-20
56-4704-20
2,0 mm



56-4702-25
56-4704-25
2,5 mm



56-4702-30
56-4704-30
3,0 mm



56-4702-35
56-4704-35
3,5 mm



56-4702-40
56-4704-40
4,0 mm



56-4702-45
56-4704-45
4,5 mm



56-4702-50
56-4704-50
5,0 mm



56-4702-70
56-4704-70
7,0 mm

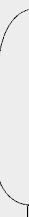

56-4702-90
56-4704-90
9,0 mm



biegsam
malleable
malléables
maleables
malleabili

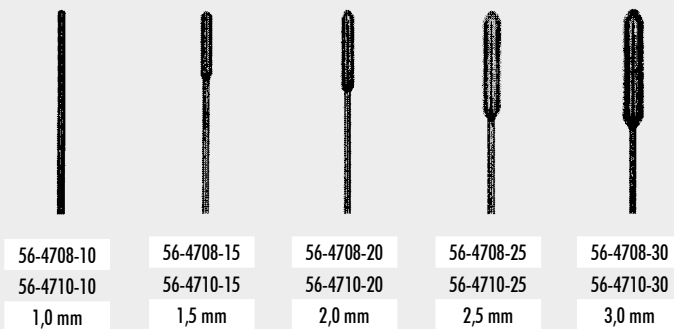

56-4708-10	56-4708-15	56-4708-20	56-4708-25	56-4708-30
56-4710-10	56-4710-15	56-4710-20	56-4710-25	56-4710-30
1,0 mm	1,5 mm	2,0 mm	2,5 mm	3,0 mm

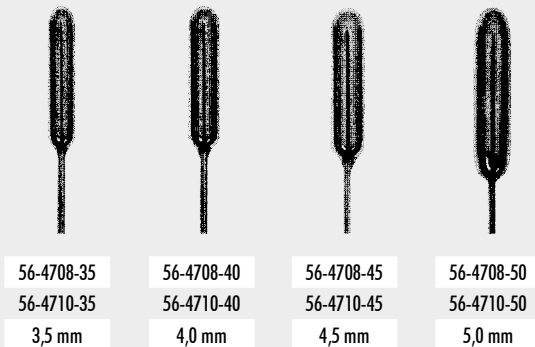

56-4708-35	56-4708-40	56-4708-45	56-4708-50
56-4710-35	56-4710-40	56-4710-45	56-4710-50
3,5 mm	4,0 mm	4,5 mm	5,0 mm

cm	GARRETT
14,0	56-4708-10 - 56-4708-50
22,0	56-4710-10 - 56-4710-50

Dilatatoren
Dilators
Dilateurs
Dilatadores
Dilatatori

THORAX

THORAX

THORAX

TÓRAX

TORACE

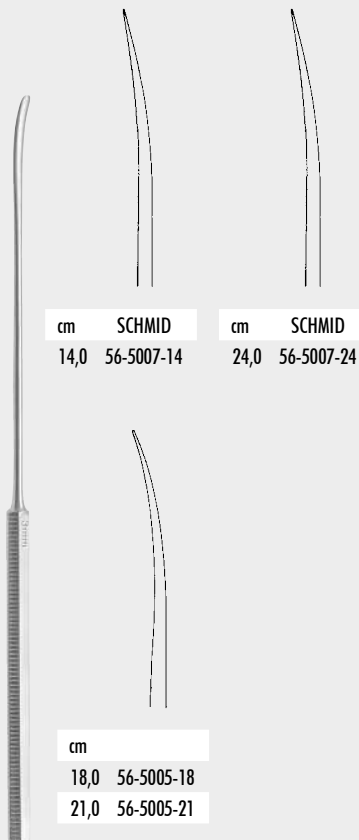

cm	SCHMID	cm	SCHMID
14,0	56-5007-14	24,0	56-5007-24

56-5009-01	56-5009-02	56-5009-03	56-5009-04
2,5 / 5,0 mm	2,0 / 4,0 mm	1,5 / 3,0 mm	1,0 / 2,0 mm

cm	
18,0	56-5005-18
21,0	56-5005-21

56-5005-18 - 56-5007-24

cm	ROBB
24,0	56-5009-01 - 56-5009-04

Spatel, Dissektoren
Spatulas, Dissectors
Spatules, Dissecteurs
Espátulas, Disecadores
Spatole, Dissettori



THORAX

THORAX

THORAX

TÓRAX

TORACE

GALLE, NIERE

GALL BLADDER, KIDNEY

VOIES BILIAIRES, REIN

VESÍCULA BILIAR, RIÑÓN

VEVICOLA BILIARE, RENE

Gallenstein-Sonden
 Gall Stone Probes
 Sondes à calculs biliaires
 Sondas para cálculos biliares
 Sonde per calcoli biliari

GALLE

GALL BLADDER

VOIES BILIAIRES

VESÍCULA BILIAR

VESICOLA BILIARE



cm DESJARDINS FINO
 24,0 62-1000-01



cm DESJARDINS FINO
 22,5 62-1000-02



cm DESJARDINS
 23,0 62-1001-23 - 62-1003-23



62-1001-23
 Fig. 1



62-1003-23
 Fig. 2



cm DESJARDINS
 23,0 62-1005-01
 Fig. 1

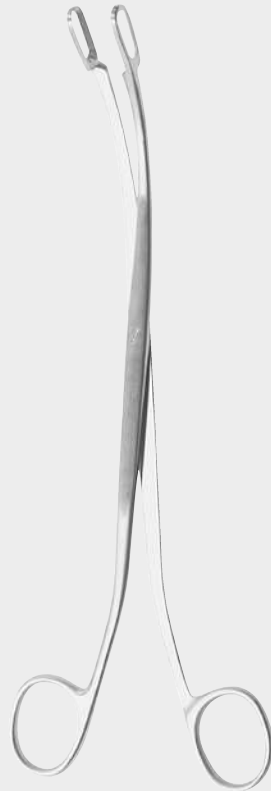

cm DESJARDINS
 23,0 62-1005-02
 Fig. 2



BLAKE
 62-1006-20 20,0 cm 62-1007-20



cm MAYO BLAKE
 20,0 62-1100-20



cm MAYO BLAKE
20,0 62-1101-20



cm MAINGOT
28,0 62-1103-28



cm MAINGOT
28,0 62-1105-28



cm MIXTER
22,0 62-1107-22

Gallensteinzangen
Gall Stone Forceps
Pinces à calculs biliaires
Pinzas para cálculos biliares
Pinze per calcoli biliari

GALLE

GALL BLADDER

VOIES BILIAIRES

VESÍCULA BILIAR

VESICOLA BILIARE



cm TÜBINGEN
25,5 62-1109-25



cm TURNER-WARWICK
18,0 62-1111-18



cm MONAT
21,5 62-1119-21



cm MOORE
62-1205-28

Gallensteinlöffel
Gall Stone Scoop
Cuillère à calculs biliaires
Cuchara para cálculos biliares
Cucchiaio per calcoli biliari

Gallenstein-Sonden
 Gall Stone Probes
 Sondes à calculs biliaires
 Sondas para cálculos biliares
 Sonde per calcoli biliari

GALLE

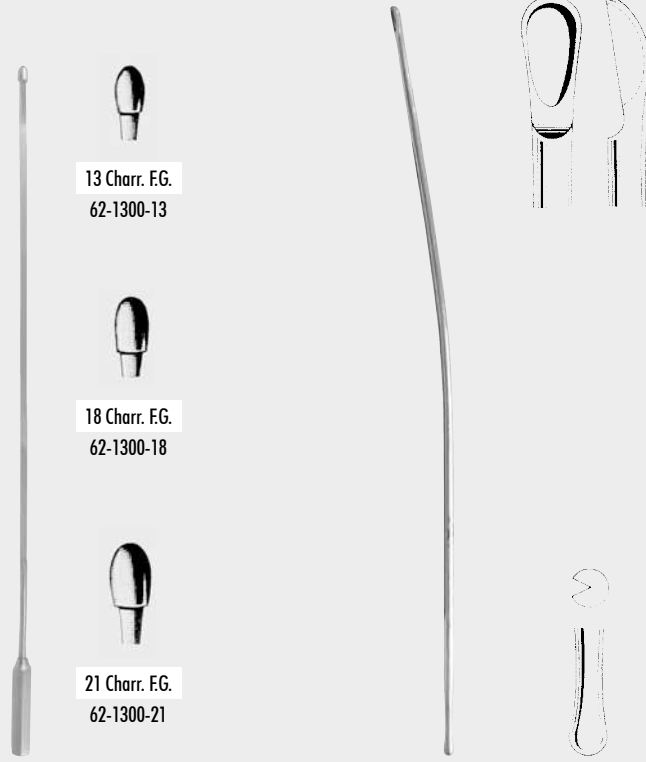

13 Charr. FG.
62-1300-13

18 Charr. FG.
62-1300-18

21 Charr. FG.
62-1300-21

cm MOYNIHAN
34,0 62-1402-34

GALL BLADDER

VOIES BILIAIRES

VESÍCULA BILIAR

VESCICOLA BILIARE

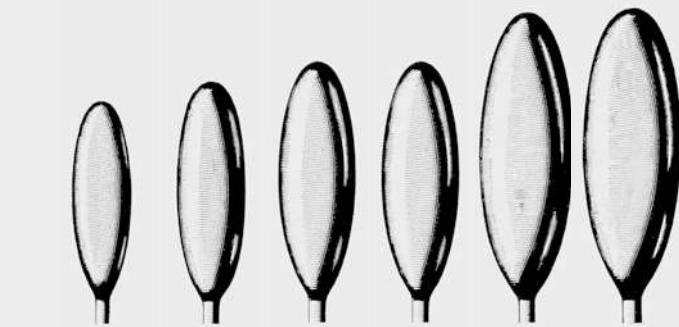
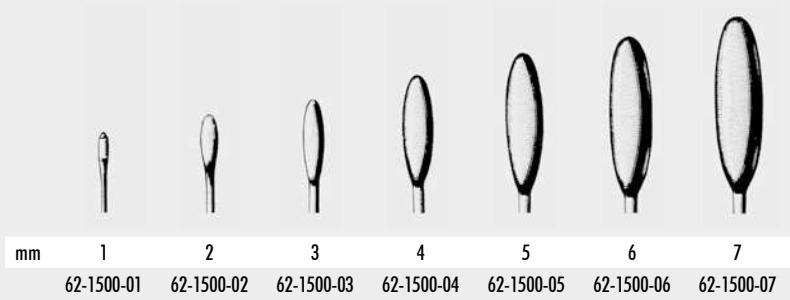
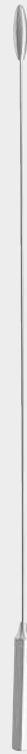

cm BAKES
30,0 62-1500-00 - 62-1500-13

Set compl. / 9
62-1500-00
3 mm - 11 mm



cm FERGUSSON
21,5 62-1700-21



cm
34,0 62-1703-34



cm MAYO
27,0 62-1705-27

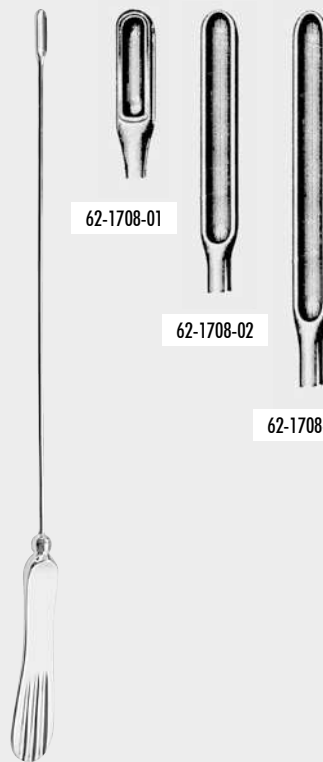

cm MAYO
27,0 62-1708-01 - 62-1708-03

62-1708-01

62-1708-02

62-1708-03

Gallenstein-Löffel
Gall Stone Scoops
Cuillères à calculs biliaires
Cucharillas para cálculos biliares
Cucchiai per calcoli biliari

GALLE

GALL BLADDER

VOIES BILIAIRES

VESÍCULA BILIAR

VESCICOLA BILIARE



DESJARDINS
62-1800-17 - 62-1800-27
elastisch - elastic - élastique
elástico - elastico



17 Charr. FG.
62-1800-17



21 Charr. FG.
62-1800-21



24 Charr. FG.
62-1800-24



27 Charr. FG.
62-1800-27



cm LUER-KOERTE
32,0 62-1810-25 - 62-1811-50

Schaft biegsam
Shaft malleable
Tige malléable
Vástago maleable
Gambo malleabile



62-1810-25
2,5 mm



62-1810-67
6,7 mm



62-1810-32
3,2 mm



62-1810-80
8,0 mm



62-1810-42
4,2 mm



62-1811-10
11,0 cm



62-1810-55
5,5 mm



62-1811-50
15,0 mm



cm MAYO
32,0 62-2100-32
biegsam
malleable
malléable
maleable
malleabile



Nierensteinzangen
Kidney Stone Forceps
Pincès à calculs rénaux
Pinzas para cálculos renales
Pinze per calcoli renali

GALLE

GALL BLADDER

VOIES BILIAIRES

VESÍCULA BILIAR

VESICOLA BILIARE

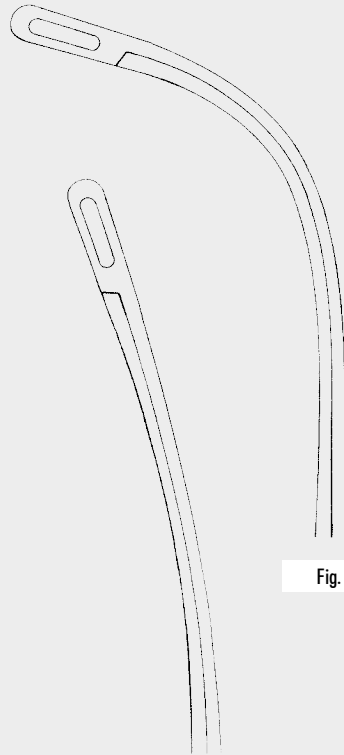

Fig. 1

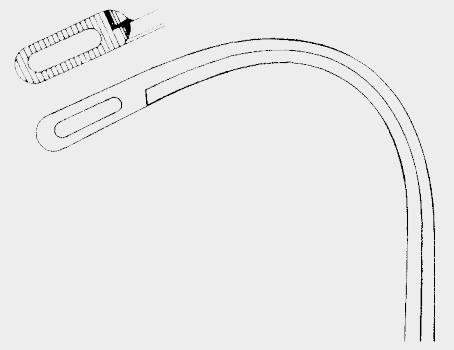

Fig. 2

Fig. 3

cm	RANDALL	Fig.
23,0	62-2301-01	1
22,0	62-2301-02	2
22,0	62-2301-03	3
22,0	62-2301-04	4
19,0	62-2301-05	5
19,0	62-2301-06	6

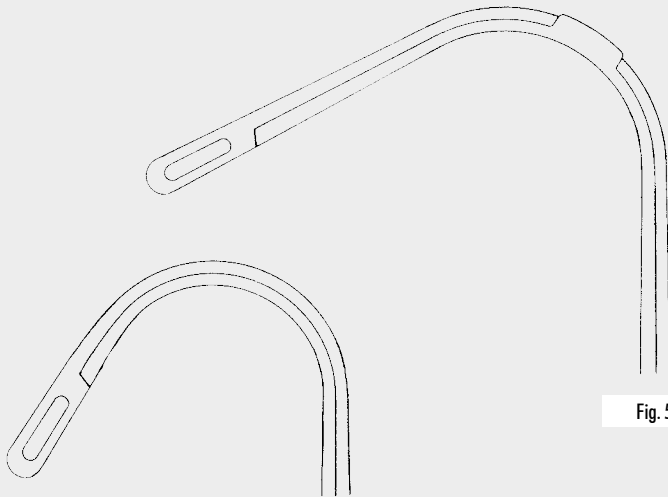

Fig. 5

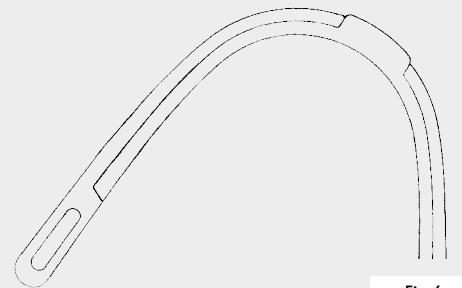

Fig. 6

Fig. 4

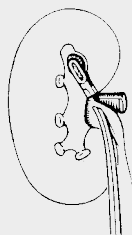

Fig. 1

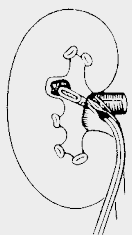

Fig. 2

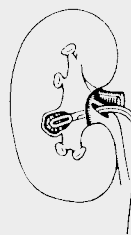

Fig. 3

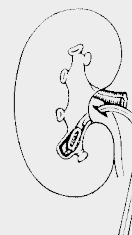

Fig. 4

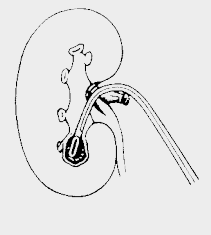

Fig. 5+6

Nierensteinzangen
Kidney Stone Forceps
Pinces à calculs rénaux
Pinzas para cálculos renales
Pinze per calcoli renali



cm Fig. 1
22,0 62-2303-01



cm Fig. 2
20,5 62-2303-02



cm Fig. 3
20,5 62-2303-03



cm Fig. 4
20,5 62-2303-04

NIERE

KIDNEY

REIN

RIÑÓN

RENE



cm Fig. 5
21,0 62-2303-05



cm Fig. 6
18,5 62-2303-06

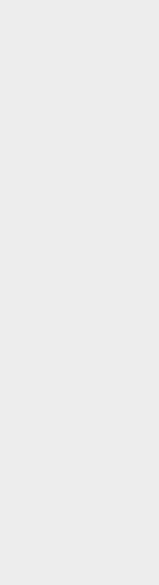

cm Fig. 7
17,5 62-2303-07



cm Fig. 8
20,0 62-2303-08

MIRIZZI							
Fig.	Fig.	Fig.	Fig.	Fig.	Fig.	Fig.	Fig.
1	2	3	4	5	6	7	8
62-2303-01	62-2303-02	62-2303-03	62-2303-04	62-2303-05	62-2303-06	62-2303-07	62-2303-08

Nierensteinzangen
Kidney Stone Forceps
Pincès à calculs rénaux
Pinzas para cálculos renales
Pinze per calcoli renali

NIERE

KIDNEY

REIN

RIÑÓN

RENE



für Kinder
for children
pour enfants
para niños
per bambini



cm
16,0 62-2311-17

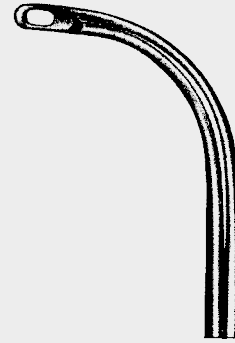

cm
17,0 62-2311-16

HEIMING

62-2311-16 - 62-2311-17



Fig. ELSÄSSER 21,0 cm
1 62-2400-01



Fig. ELSÄSSER 21,0 cm
2 62-2400-02

DARM, MAGEN

INTESTINES, STOMACH

INTESTIN, ESTOMAC

INTESTINOS, ESTÓMAGO

INTESTINI, STOMACO

Darm- und Gewebefasszangen
 Intestinal and Tissue Grasping Forceps
 Pinces à saisir les intestins et les tissus
 Pinzas para coger intestinos y tejidos
 Pinze per afferrare intestini e tessuti

DARM
MAGEN

INTESTINES
STOMACH

INTESTIN
ESTOMAC

INTESTINOS
ESTÓMAGO

INTESTINI
STOMACO

2:3

cm
15,0 64-0998-15

3:4

cm ALLIS
15,0 64-1000-15

4:5

cm ALLIS-Baby
13,0 64-1002-13
14,0 64-1002-14

4:5

5:6

4:5	ALLIS	5:6
64-1100-15	15,0 cm	64-1200-15
	19,0 cm	64-1200-19
	22,0 cm	64-1200-22
	24,0 cm	64-1200-24
	30,0 cm	64-1200-30

6:7



cm ALLIS NIRO
15,0 64-1201-15

5:6



cm ALLIS NIRO
15,0 64-1202-15



atraumatisch
 atraumatic
 atraumatiques
 atraumáticas
 atraumatiche



cm ALLIS
16,0 64-1204-16
20,0 64-1204-20
25,0 64-1204-25
30,0 64-1204-30
35,0 64-1204-35



cm STILE
23,0 64-1208-20

Mit TC-Einsätzen
 TC Lined
 A mors TC
 Con bocas TC
 Con morso TC



Darm- und Gewebefassungen
 Intestinal and Tissue Grasping Forceps
 Pinces à saisir les intestins et les tissus
 Pinzas para coger intestinos y tejidos
 Pinze per afferrare intestini e tessuti

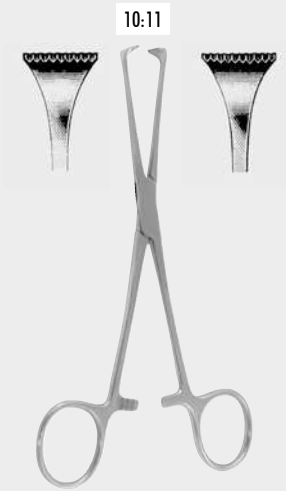

cm ALLIS-ADAIR
 15,5 64-1300-15

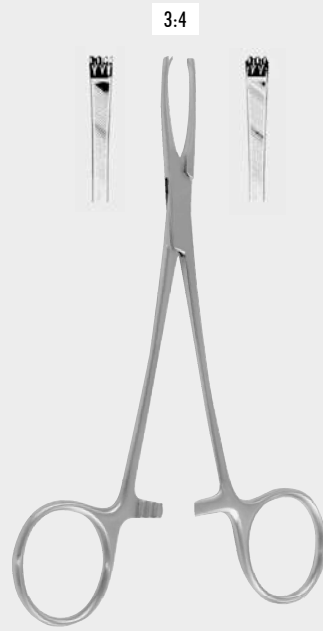

cm JUDD-ALLIS
 15,5 64-1400-15
 19,0 64-1400-19



cm BOYS ALLIS
 15,0 64-1408-15

DARM
 MAGEN

INTESTINES
 STOMACH

INTESTIN
 ESTOMAC

INTESTINOS
 ESTÓMAGO

INTESTINI
 STOMACO



cm THOMS-ALLIS
 20,0 64-1500-20



cm LOCKWOOD ALLIS
 16,0 64-1506-16
 20,0 64-1506-20



cm LOCKWOOD
 20,0 64-1508-20



cm OMBREDANNE (JACKSON)
 13,5 64-1512-13





Mit TC-Einsätzen
TC Lined
A mors TC
Con bocas TC
Con morso TC

Darm- und Gewebefasszangen
Intestinal and Tissue Grasping Forceps
Pinces à saisir les intestins et les tissus
Pinzas para coger intestinos y tejidos
Pinze per afferrare intestini e tessuti



atraumatisch
atraumatic
atraumatiques
atraumáticas
atraumatiche



cm	BABCOCK	TC	Atraum.
16,0	64-1600-16	64-1604-16	64-1608-16
18,0	64-1600-18		
20,0	64-1600-20	64-1604-20	64-1608-20
24,0	64-1600-24	64-1604-24	
30,0	64-1600-30		

cm	BABCOCK ALLIS
16,0	64-1611-16

cm	GREGOIRE
22,0	64-1680-22

DARM
MAGEN

INTESTINES
STOMACH

INTESTIN
ESTOMAC

INTESTINOS
ESTÓMAGO

INTESTINI
STOMACO

atraumatisch
atraumatic
atraumatiques
atraumáticas
atraumatiche



cm	DUVAL
18,0	64-1700-18
20,0	64-1700-20
20,0	64-1704-20
	13 mm

cm	DUVAL
20,0	64-1702-20
23,0	64-1702-23
	25 mm

DUVAL
64-1700-18 - 64-1704-20

cm	DUVAL
23,0	64-1704-23
	25 mm

cm	COLLIN
19,5	64-1706-20
23,0	64-1706-23

ZEPF®
INSTRUMENTS

64-1600-16

64.4



cm LITTLEWOOD
19,0 64-1712-19



cm LITTLEWOOD DIX
19,0 64-1714-19



cm WILLIAMS
16,5 64-1800-16

Darm- und Gewebefassungen
Intestinal and Tissue Grasping Forceps
Pinces à saisir les intestins et les tissus
Pinzas para coger intestinos y tejidos
Pinze per afferrare intestini e tessuti

DARM
MAGEN

INTESTINES
STOMACH

INTESTIN
ESTOMAC

INTESTINOS
ESTÓMAGO

INTESTINI
STOMACO

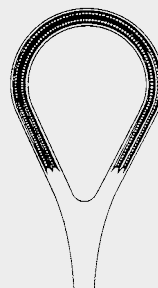

atraumatisch
atraumatic
atraumatiques
atraumáticas
atraumatiche

cm
25,0 64-1810-25



SCHEIBE
64-1810-25 - 64-1810-26

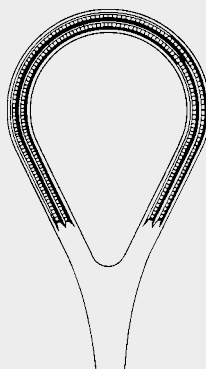

cm
26,0 64-1810-26



cm SCHOENBURG
22,0 64-1802-22

Darmklemmen
 Intestinal Forceps
 Pincas intestinales
 Pinzas intestinales
 Pinze intestinali

DARM
 MAGEN

INTESTINES
 STOMACH

INTESTIN
 ESTOMAC

INTESTINOS
 ESTÓMAGO

INTESTINI
 STOMACO

Darmklemmen
 Intestinal Forceps
 Pincas intestinales
 Pinzas intestinales
 Pinze intestinali

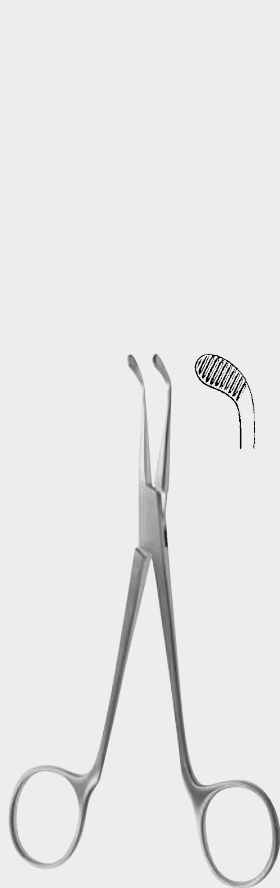

cm BENSON
 15,0 64-1905-15

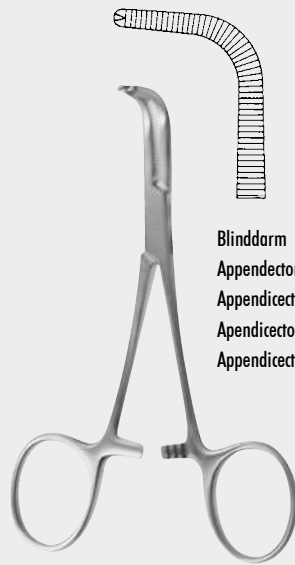

cm KLEINSCHMIDT
 12,0 64-1921-12

Blinddarm
 Appendectomy
 Appendicectomie
 Appendicectomia
 Appendicectomia

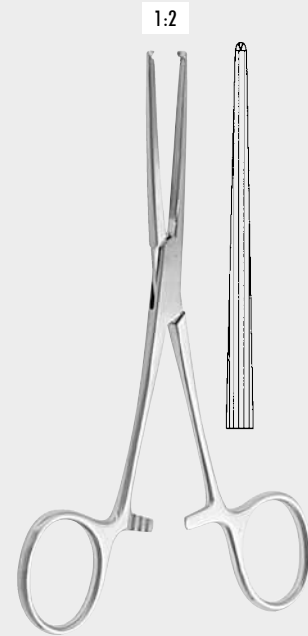

cm ALLEN
 15,5 64-1924-15

Für Kinder
 paediatric
 pédiatrique
 pediátrica
 pediatrica



cm SCHOEMAKER
 17,0 64-2010-17
 21,5 64-2010-21



cm SETON PRINGLE
 17,0 64-2016-17

atraumatich
atraumatic
atraumatiques
atraumáticas
atraumatiche

*atraumatich
*atraumatic
*atraumatiques
*atraumáticas
*atraumatiche

Darmklemmen
Intestinal Forceps
Pinces intestinales
Pinzas intestinales
Pinze intestinali

DARM
MAGEN

INTESTINES
STOMACH

INTESTIN
ESTOMAC

INTESTINOS
ESTÓMAGO

INTESTINI
STOMACO

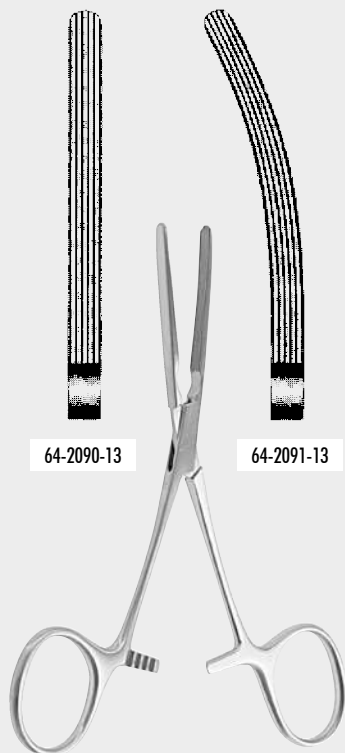

64-2090-13

64-2091-13

cm KOCHER Baby
13,0 64-2090-13 - 64-2091-13

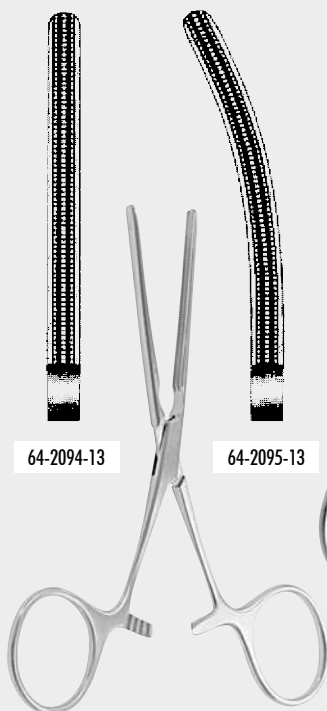

64-2094-13

64-2095-13

cm KOCHER Baby
13,0 64-2094-13 - 64-2095-13

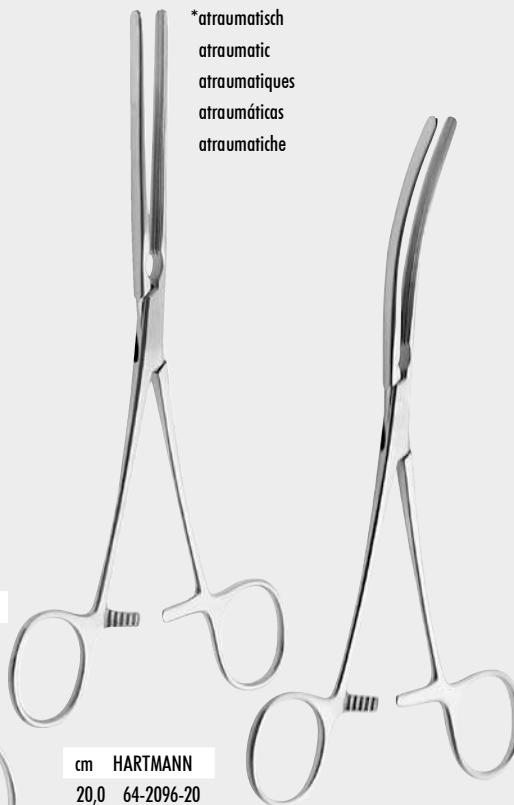

cm HARTMANN
20,0 64-2096-20
20,0 64-2098-20*

cm HARTMANN
20,0 64-2097-20
20,0 64-2099-20*

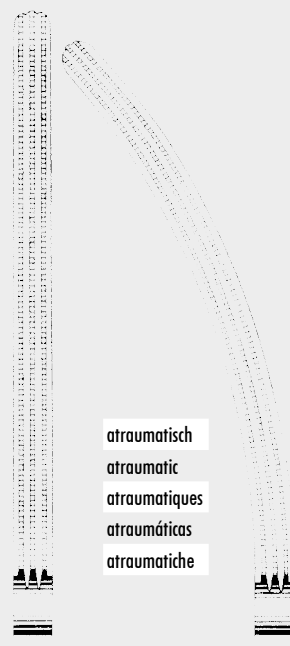
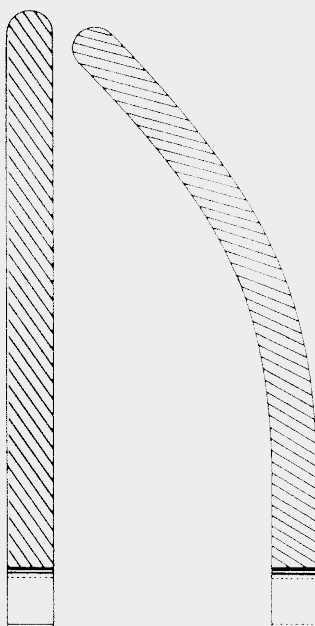
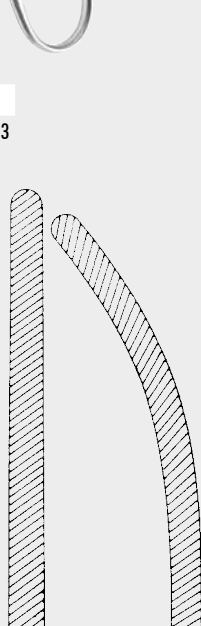

atraumatich
atraumatic
atraumatiques
atraumáticas
atraumatiche

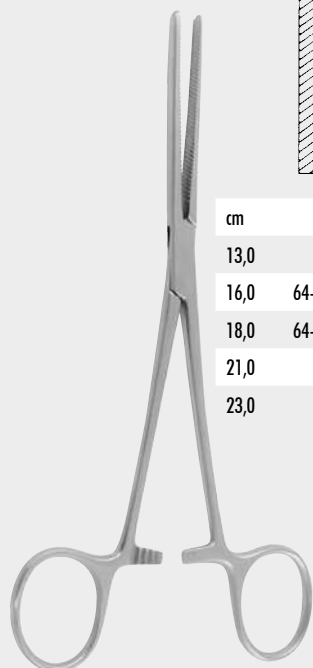

DOYEN-Baby / DOYEN
64-2100-18 - 64-2107-23

cm	DOYEN-Baby		DOYEN	
13,0			64-2106-13	64-2107-13
16,0	64-2100-16	64-2101-16	64-2106-16	64-2107-16
18,0	64-2100-18	64-2101-18	64-2106-18	64-2107-18
21,0		64-2100-21	64-2101-21	64-2106-21
23,0		64-2100-23	64-2101-23	64-2106-23

Darmklemmen
 Intestinal Forceps
 Pinces intestinales
 Pinzas intestinales
 Pinze intestinali

DARM
 MAGEN

INTESTINES
 STOMACH

INTESTIN
 ESTOMAC

INTESTINOS
 ESTÓMAGO

INTESTINI
 STOMACO

atraumatisch
 atraumatic
 atraumatiques
 atraumáticas
 atraumatiche

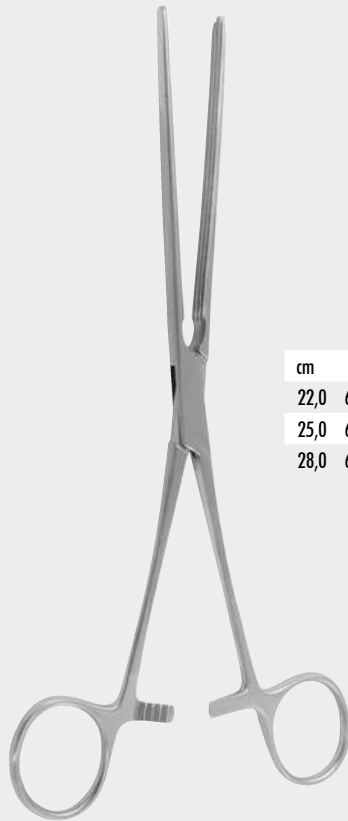

KOCHER
 64-2200-22 - 64-2207-28

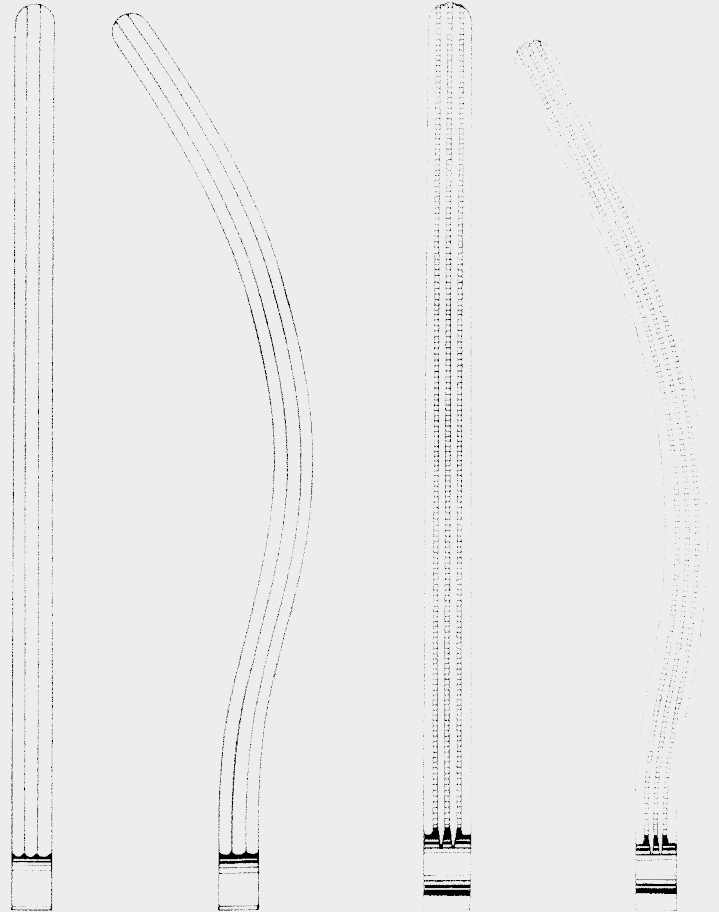

cm	KOCHER			
22,0	64-2200-22	64-2201-22	64-2206-22	64-2207-22
25,0	64-2200-25	64-2201-25	64-2206-25	64-2207-25
28,0	64-2200-28	64-2201-28	64-2206-28	64-2207-28

atraumatisch
 atraumatic
 atraumatiques
 atraumáticas
 atraumatiche

Darmklemmen
 Intestinal Forceps
 Pinces intestinales
 Pinzas intestinales
 Pinze intestinali

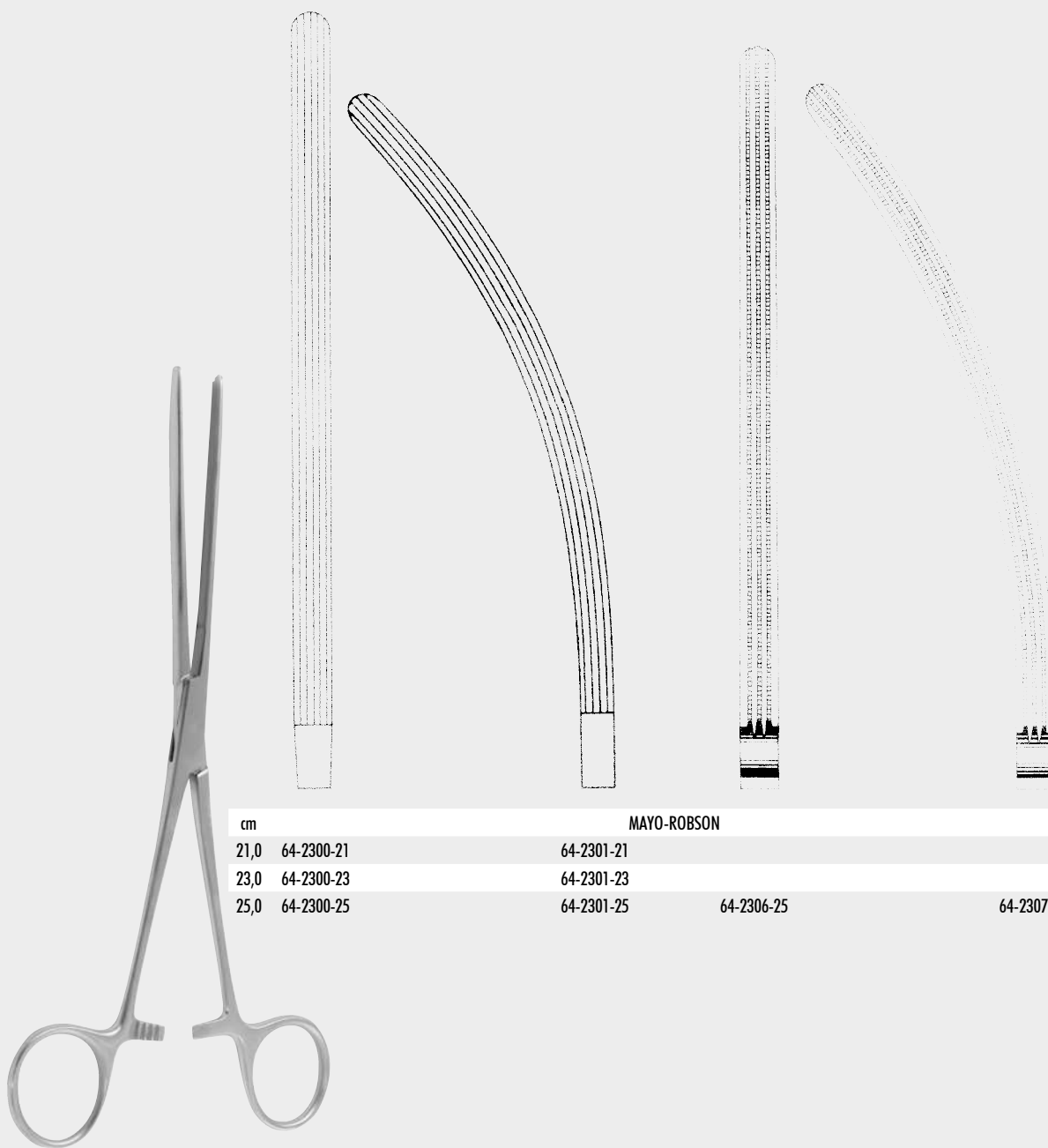

cm	MAYO-ROBSON			
21,0	64-2300-21	64-2301-21		
23,0	64-2300-23	64-2301-23		
25,0	64-2300-25	64-2301-25	64-2306-25	64-2307-25

MAYO-ROBSON
 64-2300-21 - 64-2307-25

DARM
 MAGEN

INTESTINES
 STOMACH

INTESTIN
 ESTOMAC

INTESTINOS
 ESTÓMAGO

INTESTINI
 STOMACO

Darmklemmen
 Intestinal Forceps
 Pincas intestinales
 Pinzas intestinales
 Pinze intestinali

DARM
 MAGEN

INTESTINES
 STOMACH

INTESTIN
 ESTOMAC

INTESTINOS
 ESTÓMAGO

INTESTINI
 STOMACO



cm	SCUDDER
25,0	64-2308-25
33,0	64-2308-33



cm	SCUDDER
33,0	64-2309-33



cm	SCUDDER
33,0	64-2308-34
	64-2309-34

atraumatisch
 atraumatic
 atraumatiques
 atraumáticas
 atraumatiche

Rektum-Anastomosenklemmen
 Sigmoid Anastomosis Forceps
 Pinces à anastomose rectale
 Pinzas para anastomosis rectal
 Pinze per anastomosi rettale

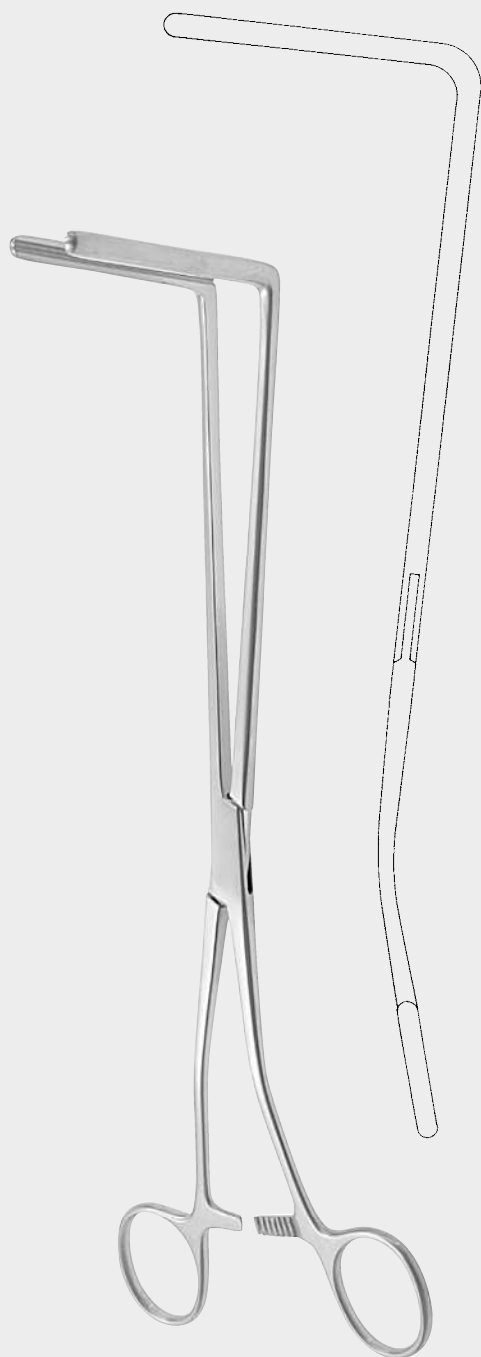

cm RESANO
 30,0 64-2311-30



cm KERSTING
 27,0 64-2313-27

DARM
 MAGEN

INTESTINES
 STOMACH

INTESTIN
 ESTOMAC

INTESTINOS
 ESTÓMAGO

INTESTINI
 STOMACO

Rektum-Anastomosenklemmen
Sigmoid Anastomosis Forceps
Pinces à anastomose rectale
Pinzas para anastomosis rectal
Pinze per anastomosi rettale

DARM
MAGEN

INTESTINES
STOMACH

INTESTIN
ESTOMAC

INTESTINOS
ESTÓMAGO

INTESTINI
STOMACO



cm LLOYD-DAVIS
31,5 64-2315-31



cm HAYES
26,0 64-2321-26
28,0 64-2321-28



L = mm
60 64-2409-60
80 64-2409-80



normal FEHLAND atraum.
64-2401-23 23,5 cm 64-2407-23

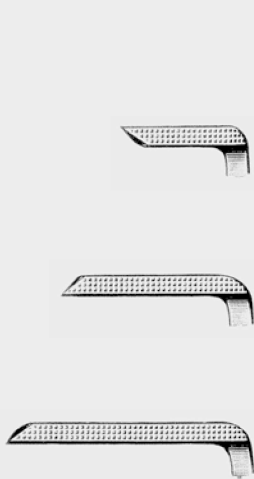

L=mm	BEST
30	64-2501-30
60	64-2501-60
75	64-2501-75

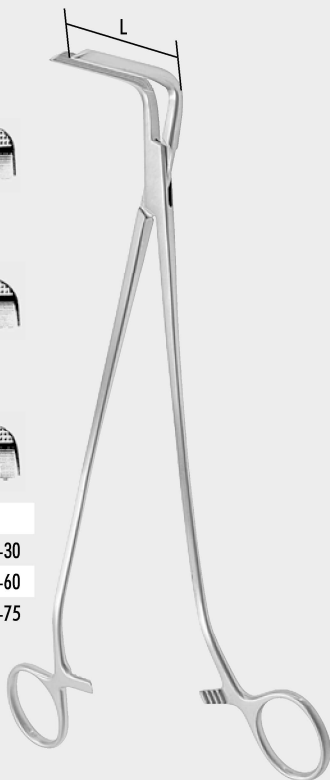

cm BEST
26,5 64-2501-30 - 64-2501-75



cm FINCH
23,0 64-2507-23

Darm- und Magenklappen
Intestinal and Stomach Clamps
Pinces-Clamps intestinales et d'estomac
Pinzas Clamps intestinales y estomacales
Pinze intestinali e stomacali

DARM
MAGEN

INTESTINES
STOMACH

INTESTIN
ESTOMAC

INTESTINOS
ESTÓMAGO

INTESTINI
STOMACO



L=mm	BEST
8	64-2501-30
12	64-2501-60



cm BRUNNER
24,0 64-2600-24 - 64-2606-24

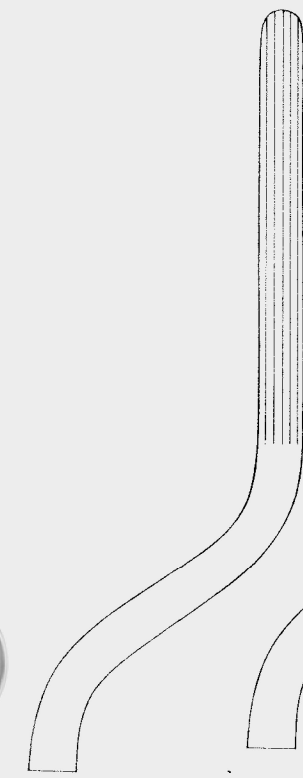

64-2600-24

atraumatisch
atraumatic
atraumatiques
atraumáticas
atraumatiche

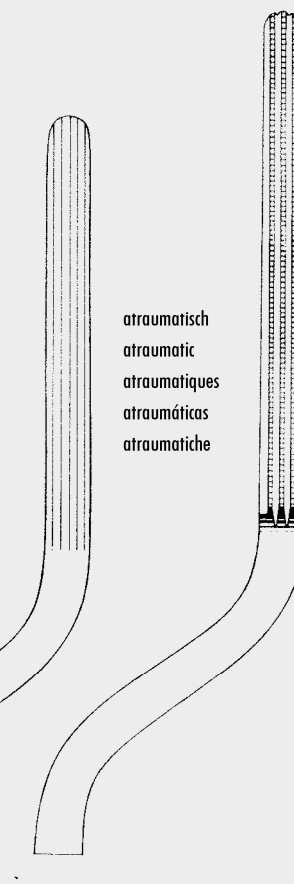

64-2606-24

Anastomosenklemmen und Zubehör
 Anastomosis Clamps and Accessories
 Clamps à anastomose et accessoires
 Clamps para anastomosis y accesorios
 Pinze per anastomosi ed accessori

DARM
 MAGEN

INTESTINES
 STOMACH

INTESTIN
 ESTOMAC

INTESTINOS
 ESTÓMAGO

INTESTINI
 STOMACO



STONE-WATT
 64-2704-00

cm STONE
 15,5 64-2700-15



cm STONE-WATT
 7,5 64-2702-07
 10,0 64-2702-10



atraumatisch
 atraumatic
 atraumatiques
 atraumáticas
 atraumatiche

mm KERSTING
 75 64-2790-70
 85 64-2790-85



cm DE MARTEL-WOLFSON
 5,0 64-2800-05
 7,0 64-2800-07
 10,0 64-2800-10
 Set / 3

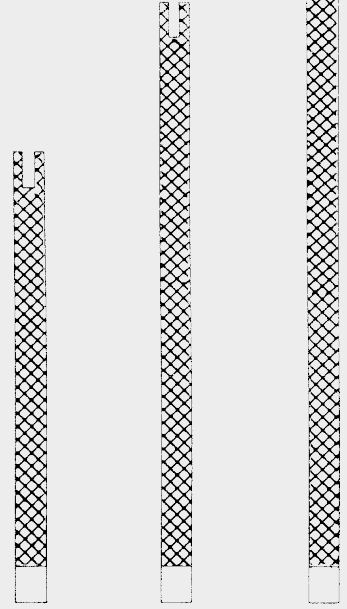

5,0 cm 7,0 cm 10,0 cm



cm DE MARTEL-WOLFSON
 26,0 64-2802-26



cm DE MARTEL-WOLFSON
 8,5 64-2804-08

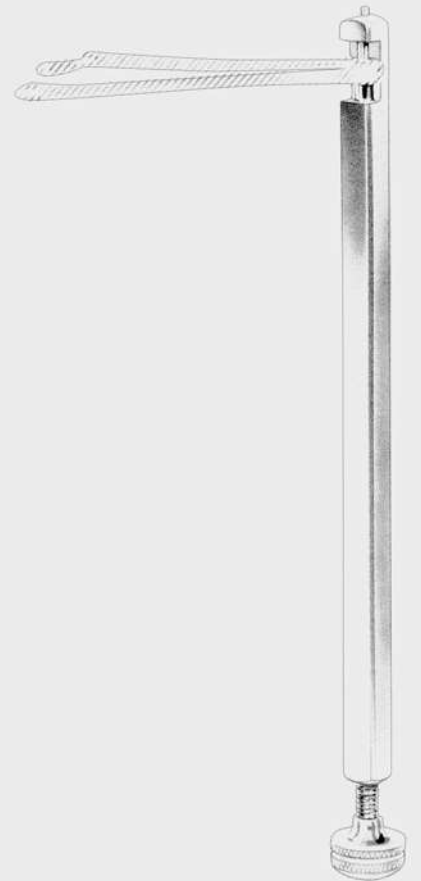

cm DE MARTEL-WOLFSON
 23,0 64-2804-23

Magenklemmen
Stomach Clamps
Pincas-Clamps stomacales
Pinzas-Clamps estomacales
Pinze stomacali

DARM
MAGEN



cm MOYNIHAN
28,0 64-2902-28



cm MOYNIHAN
30,0 64-2902-30 64-2903-30



cm PARKER KERR
23,0 64-2904-23
25,0 64-2904-25

INTESTINES
STOMACH

INTESTIN
ESTOMAC

INTESTINOS
ESTÓMAGO

INTESTINI
STOMACO



cm PARKER KERR
23,0 64-2905-23
25,0 64-2905-25



cm WALTON
33,0 64-2910-33



cm LANG STEVENSON
20,0 64-2916-20

Magenklemmen
Stomach Clamps
Pincas-Clamps stomacales
Pinzas-Clamps estomacales
Pinze stomacali

DARM
MAGEN

INTESTINES
STOMACH

INTESTIN
ESTOMAC

INTESTINOS
ESTÓMAGO

INTESTINI
STOMACO

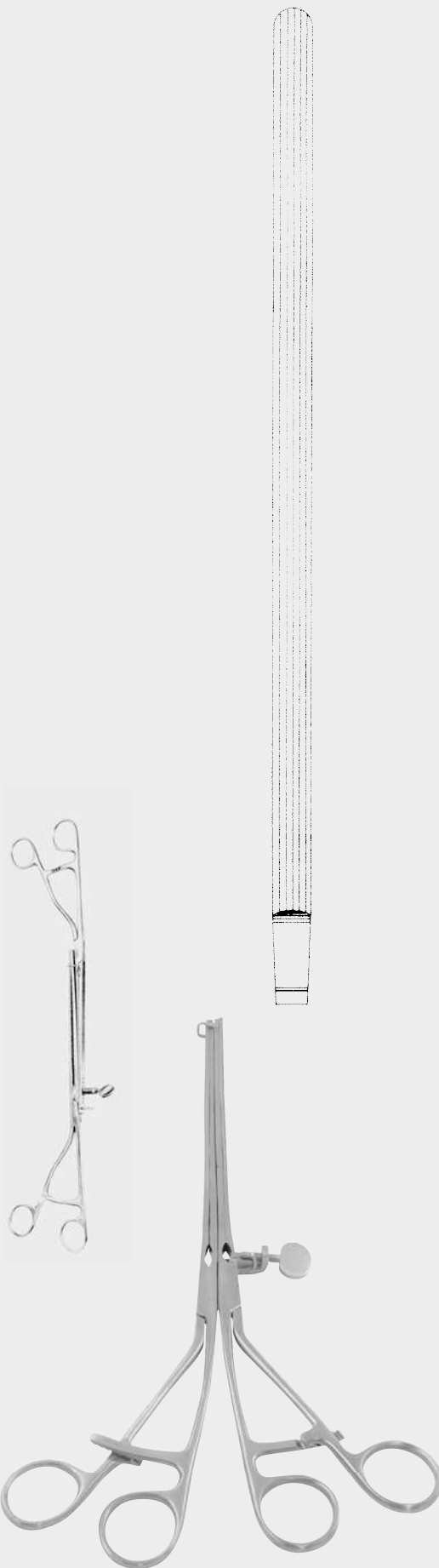

cm	LANE
30,0	64-2900-30

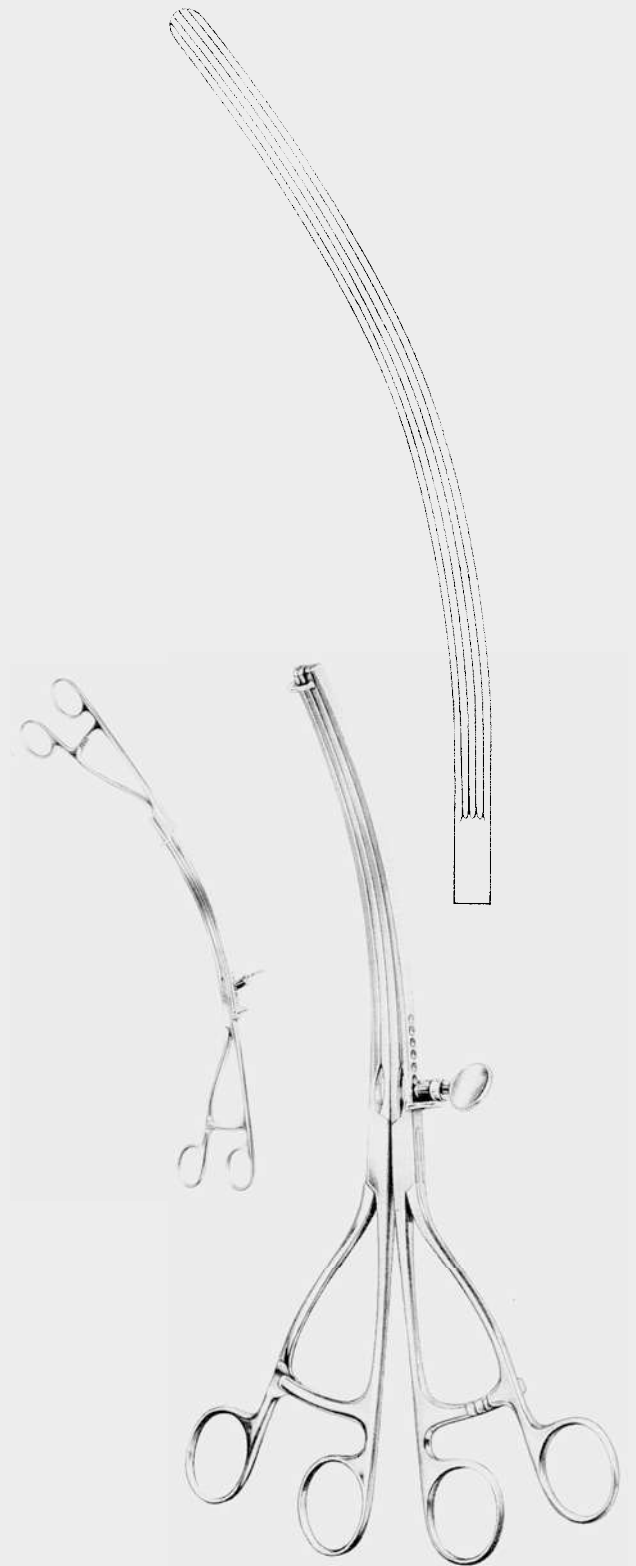

cm	LANE
30,0	64-2901-30

mit Stift
with pin
avec cheville
con espiga
con perno

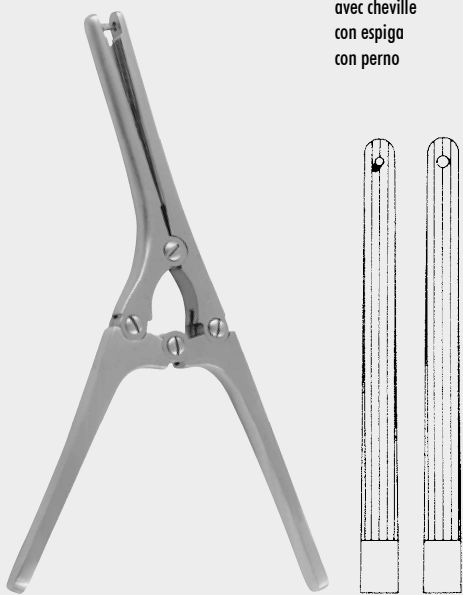

cm PAYR
15,0 64-3100-15

Darm- und Magenquetschklemmen
Intestinal and Pylorus Clamps
Pinces-Clamps stomacales
Pinzas-Clamps estomacales
Pinze stomacali

DARM
MAGEN

INTESTINES
STOMACH

INTESTIN
ESTOMAC

INTESTINOS
ESTÓMAGO

INTESTINI
STOMACO

mit Stift
with pin
avec cheville
con espiga
con perno



PAYR
64-3100-21 - 64-3100-35

PAYR 64-3100-21
20,5 cm

64-3100-29
29,0 cm

64-3100-35
35,0 cm

DARM
MAGEN

INTESTINES
STOMACH

INTESTIN
ESTOMAC

INTESTINOS
ESTÓMAGO

INTESTINI
STOMACO



cm	RANKIN
22,5	64-3120-22



mm	MÜLLER 24,0 cm
26-40	64-3218-24



L= cm	SAVAGE
34,0	64-3220-34
48,0	64-3220-48
	ø 8,0 cm

UROLOGIE

UROLOGY

UROLOGIE

UROLOGÍA

UROLOGIA



Prostata-Instrumente
 Prostata Instruments
 Instruments prostatiques
 Instrumentos prostáticos
 Strumenti prostatici

UROLOGIE

UROLOGY

UROLOGIE

UROLOGÍA

UROLOGIA

Prostata-Haken - Prostatic Retractors - Écarteurs prostatiques - Separadores prostáticos
 Divaricatori prostatici

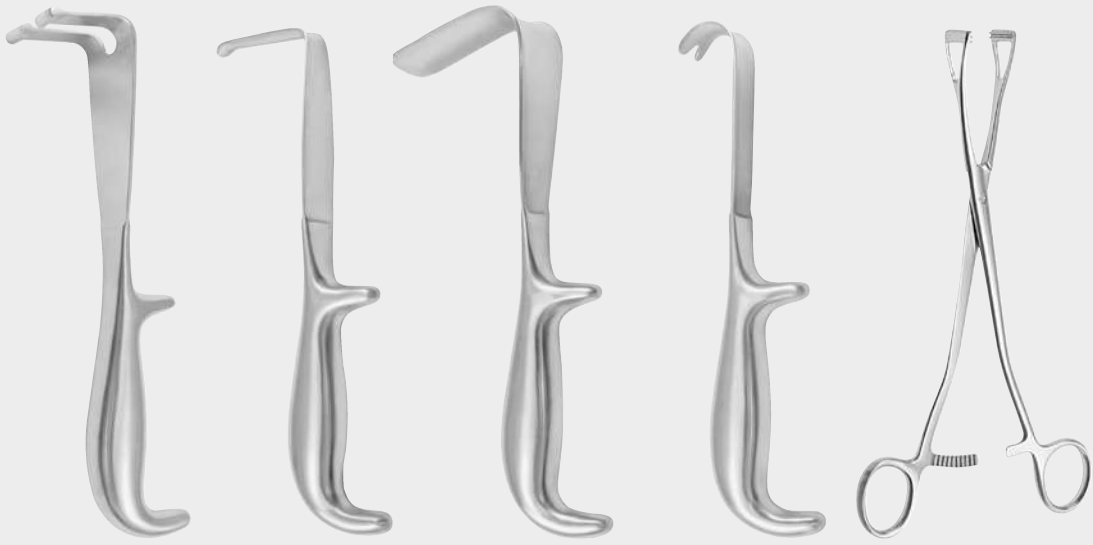

cm YOUNG
 22,0 66-1000-22

cm YOUNG
 21,0 66-1001-21

cm YOUNG
 22,0 66-1003-22

cm YOUNG
 21,0 66-1005-21

cm YOUNG
 20,0 66-1006-20

Prostata-Fasszange - Prostatic Seizing Forceps - Pince à saisir la prostate - Pinza para sacar la próstata - Pinza per afferrare la prostata

Kapsel-Fasszangen - Capsule Seizing Forceps - Pincas capsulaires - Pinzas capsulares - Pinze capsulari

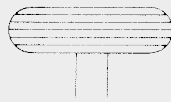

cm
 23,0 66-1101-23



cm
 23,0 66-1107-23

- atraumatisch
- atraumatic
- atraumatiques
- atraumáticas
- atraumatiche



MILLIN
 66-1101-23 - 66-1205-24



cm MILLIN
 23,0 66-1203-23

Fasszange für vordere Lappen
 Lobe Holding Forceps
 Pince pour saisir les lambeaux
 Pinza para lóbulos anteriores
 Pinza per lobuli anteriori

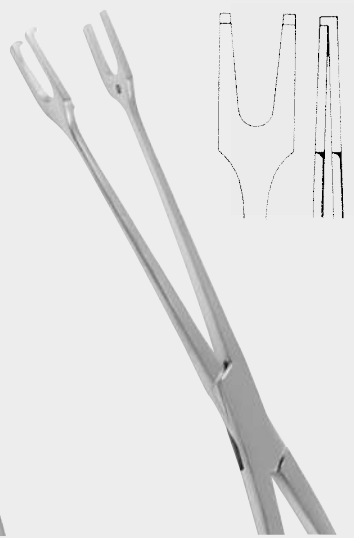

cm MILLIN
 24,0 66-1205-24

Faden-Führungszange
 Ligature Holding Forceps
 Pince à ligatures
 Pinza para ligaduras
 Pinza per legature



LEGUEU
66-1407-27

KOCHER
66-1409-27

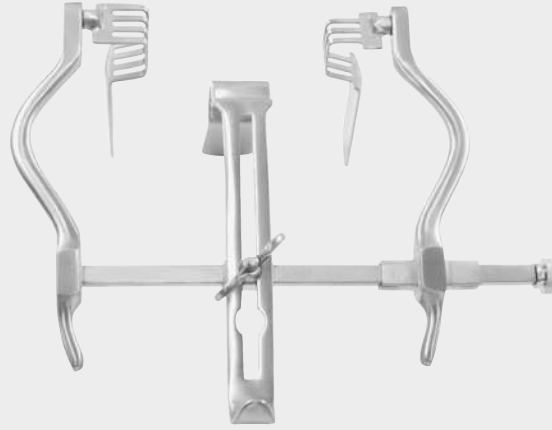

JUDD-MASSON
66-1500-00

Blasen-Wundhaken, -Wundsperrer
Bladder Retractors
Écarteurs vésicaux
Separadores vesicales
Divaricatori vescicali

UROLOGIE

UROLOGY

UROLOGIE

UROLOGÍA

UROLOGIA

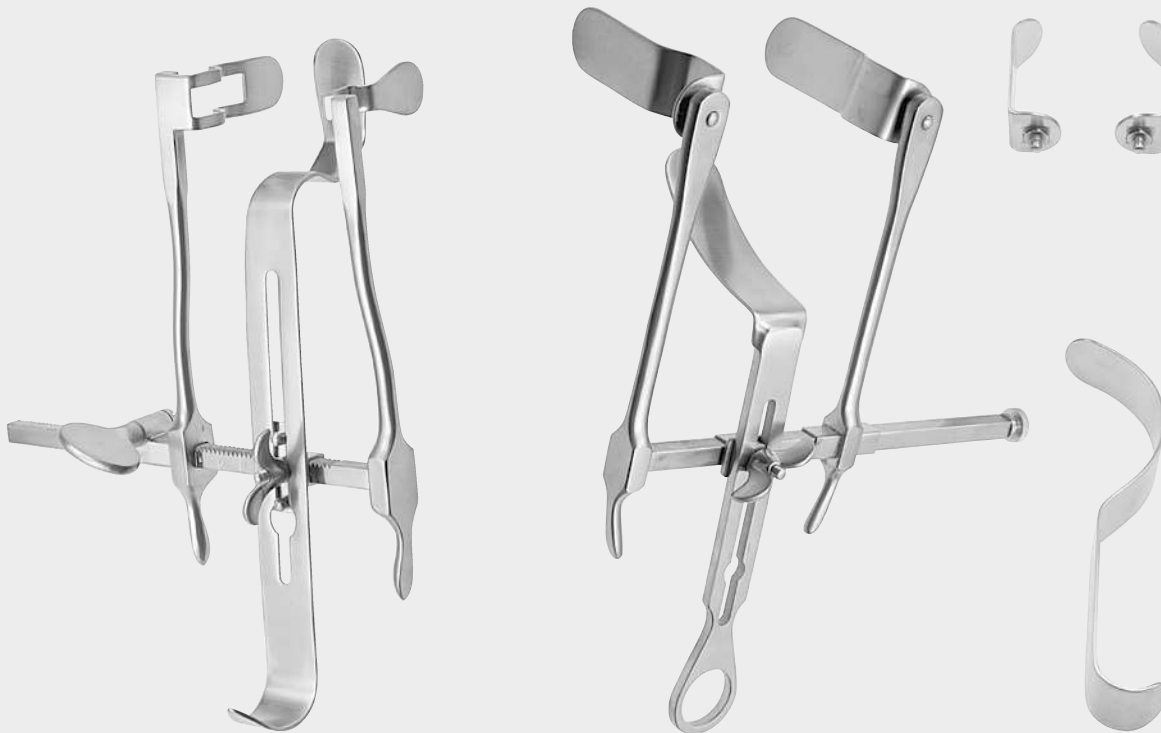

HRYNTSCHAK
66-1502-08 Kinder / Child / Enfant / Niño / Bambini
66-1502-11 Erwachsene / Adult / Adulte / Adulto

THOMSON-WALKER
66-1600-00

Blasen- und Wundspreizer
Bladder and Wound Retractor
Écarteur vésical
Separador vesical
Divaricatore vescicale

UROLOGIE

UROLOGY

UROLOGIE

UROLOGÍA

UROLOGIA

Urethrotome
Urethrotomes
Urétérotomes
Ureterótomos
Uretrotomi

Blasenhals-Sperrer
Bladder Neck Spreader
Écarteur pour le col de la vessie
Separador para el cuello de la vejiga
Divaricatore per il collo della vescica



MILLIN
66-1602-00

LEGUEU
66-1603-00

MILLIN
66-1605-00

cm PITHA
22,0 66-1607-22

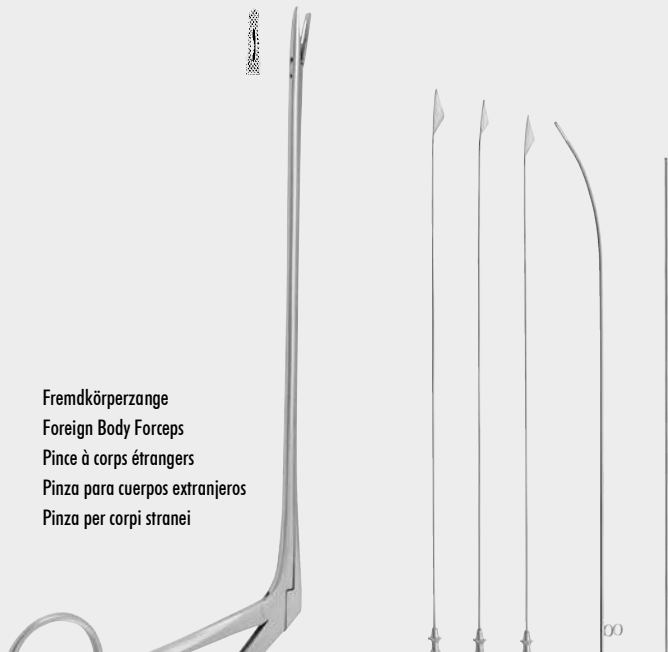

Fremdkörperzange
Foreign Body Forceps
Pince à corps étrangers
Pinza para cuerpos extranjerios
Pinza per corpi strani

cm MATHIEU
20,0 66-1608-20
28,0 66-1608-28

MAISONNEUVE
66-1700-00
compl.

66-1700-01
Holzetui
Box of wood only
Boîte bois seule
Estuche de madera suelto
Astuccio in legno solo

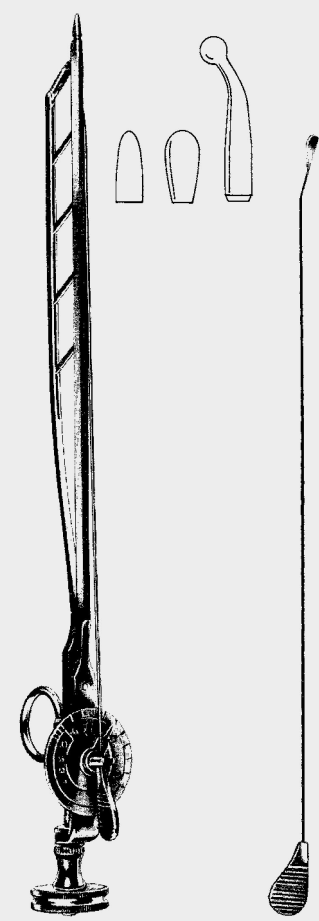

OTIS
66-1702-00

Ersatzmesser
Spare Blade
Lame de rechange
Cuchillo de repuesto
Coltello di ricambio
für / for / pour /
para / per
66-1702-00

66-1702-99

Circumcisions-Instrumente - Circumcision Instruments -
Instruments à circoncision - Instrumentos para circuncisión
Strumenti per circoncisione



mm MOGEN 7,5 mm
2,5 66-1703-00



ø mm WINKELMANN
12 66-1703-12
16 66-1703-16
20 66-1703-20



ø mm
8 66-1704-08
11 66-1704-11
13 66-1704-13
16 66-1704-16
21 66-1704-21
26 66-1704-26
32 66-1704-32

Penis, Urethra
Penis, Urethra
Pénis, Urètre
Penis, Uretra
Pene, Uretra

UROLOGIE



cm STOCKMANN
8,0 66-1705-08

Penisklemmen - Meatus Clamps - Compresseurs de l'urètre
Compresores uretrales - Serrapene

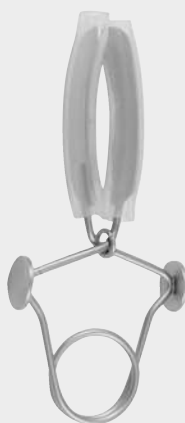

cm STRAUSS
11,0 66-1707-11

Sekretlöffel
Secretion Scoops
Cuiller à sécrétions
Cucharilla para secreciones
Cucchiai per secrezione



cm
12,5 66-1710-12



cm COLLINGWOOD
14,0 66-1714-14



GUTMANN
66-1800-26



ASCH
66-1802-20

UROLOGY

UROLOGIE

UROLOGÍA

UROLOGIA

Penis, Urethra
 Penis, Urethra
 Pénis, Urètre
 Penis, Uretra
 Pene, Uretra

UROLOGIE

UROLOGY

UROLOGIE

UROLOGÍA

UROLOGIA

Harnröhren-Dilatationsbesteck, komplett
 Urethral Dilation Set, complete
 Jeu complet d'instruments pour la dilatation de l'urètre
 Juego de instrumentos completo para la dilatación de la uretra
 Set di strumenti completo per la dilatazione uretrale

ZEPF[®]
α
 INSTRUMENTS

66-1804-35

66.6



cm GUYON
 39,0 66-1804-39



cm GUYON
 35,0 66-1805-35

Katheterspanner
 Catheter Introducers
 Introducteurs de cathéters
 Introducutores de catéteres
 Introduuttori per cateteri



cm
 46,0 66-1807-46



cm DITTEL
 46,0 66-1809-46



cm GUYON
 46,0 66-1811-46

mit 4 Gleitsonden 3, 4, 5 und 6 Charr.
 with 4 filiform guides 3, 4, 5, and 6 Fr.
 avec 4 bougies conductrices 3, 4, 5 et 6 Charr.
 con 4 bujías conductoras 3, 4, 5 y 6 Charr.
 con 4 stiletto di guida 3, 4, 5 e 6 Charr.

	Ch./FG.	No.
* Zwischengrößen:	9	66-2005-09
Intermediate Sizes:	11	66-2005-11
Dimensions intermédiaires:	.	.
Dimensiones intermedias:	.	.
Dimensioni intermedi:	39	66-2005-39



GUYON
 66-2000-00
 compl.

Dilatations-Bougies, Metallkatheter
 Dilating Bougies, Metal Catheters
 Bougies dilatatrices, Cathéters métalliques
 Bujías dilatadoras, Catéteres metálicos
 Candelette dilatatrici, Cateteri metallici



UROLOGIE

UROLOGY

UROLOGIE

UROLOGÍA

UROLOGIA

Charr. / FG.	van BUREN	DITTEL	DITTEL	GUYON	GUYON	LISTER	
0						66-2009-00	
1						66-2009-01	
2						66-2009-02	
5						66-2009-05	
6	66-2001-06			66-2005-06		66-2009-06	
7				66-2005-07		66-2009-07	
8	66-2001-08	66-2003-08	66-2004-08	66-2005-08		66-2009-08	66-2101-08
9		66-2003-09	66-2004-09	66-2005-09		66-2009-09	
10	66-2001-10	66-2003-10	66-2004-10	66-2005-10	66-2007-10	66-2009-10	66-2101-10
11		66-2003-11	66-2004-11	66-2005-11	66-2007-11	66-2009-11	
12	66-2001-12	66-2003-12	66-2004-12	66-2005-12	66-2007-12	66-2009-12	66-2101-12
13		66-2003-13	66-2004-13	66-2005-13	66-2007-13	66-2009-13	
14	66-2001-14	66-2003-14	66-2004-14	66-2005-14	66-2007-14	66-2009-14	66-2101-14
15		66-2003-15	66-2004-15	66-2005-15	66-2007-15	66-2009-15	
16	66-2001-16	66-2003-16	66-2004-16	66-2005-16	66-2007-16	66-2009-16	66-2101-16
17		66-2003-17	66-2004-17	66-2005-17	66-2007-17	66-2009-17	
18	66-2001-18	66-2003-18	66-2004-18	66-2005-18	66-2007-18	66-2009-18	66-2101-18
19		66-2003-19	66-2004-19	66-2005-19	66-2007-19		
20	66-2001-20	66-2003-20	66-2004-20	66-2005-20	66-2007-20		66-2101-20
21		66-2003-21	66-2004-21	66-2005-21	66-2007-21		
22	66-2001-22	66-2003-22	66-2004-22	66-2005-22	66-2007-22		66-2101-22
23		66-2003-23	66-2004-23	66-2005-23	66-2007-23		
24	66-2001-24	66-2003-24	66-2004-24	66-2005-24	66-2007-24		66-2101-24
25		66-2003-25	66-2004-25	66-2005-25	66-2007-25		
26	66-2001-26	66-2003-26	66-2004-26	66-2005-26	66-2007-26		
27		66-2003-27	66-2004-27	66-2005-27	66-2007-27		
28	66-2001-28	66-2003-28	66-2004-28	66-2005-28	66-2007-28		
29		66-2003-29	66-2004-29	66-2005-29	66-2007-29		
30	66-2001-30	66-2003-30	66-2004-30	66-2005-30	66-2007-30		
32	66-2001-32			66-2005-32	mit Innengewinde		
34	66-2001-34			66-2005-34	with inner thread		
36	66-2001-36			66-2005-36	avec filet intérieur		
38	66-2001-38			66-2005-38	con rosca interior		
40	66-2001-40			66-2005-40	con filetto interiore		

66-2001-00

66-2004-00

Set compl. # 8 - 36

Set compl. # 8 - 30

Metallkatheter, Dilatations-Bougies
 Metal Catheters, Dilating Bougies
 Cathéters métalliques, Bougies dilatatrices
 Catéteres metálicos, Bujías dilatadoras
 Cateteri metallici, Candelette dilatatrici

UROLOGIE

UROLOGY

UROLOGIE

UROLOGÍA

UROLOGIA



Charr. / FG.		COXETER	WALTHER	CAMPBELL
6				66-2129-06
8	66-2103-08	66-2109-08		66-2129-08
10	66-2103-10	66-2109-10		66-2129-10
12	66-2103-12	66-2109-12	66-2111-12	66-2129-12
14	66-2103-14	66-2109-14	66-2111-14	66-2129-14
16	66-2103-16	66-2109-16	66-2111-16	66-2129-16
18	66-2103-18	66-2109-18	66-2111-18	66-2129-18
20	66-2103-20	66-2109-20	66-2111-20	66-2129-20
22	66-2103-22	66-2109-22	66-2111-22	66-2129-22
24	66-2103-24	66-2109-24	66-2111-24	
26			66-2111-26	
28			66-2111-28	
30			66-2111-30	
32			66-2111-32	
34			66-2111-34	
36			66-2111-36	
38			66-2111-38	
40				

13,5 cm

28,0 cm

Dilatations-Bougies
 Dilating Bougies
 Bougies dilatatrices
 Bujías dilatadoras
 Candelette dilatatrici

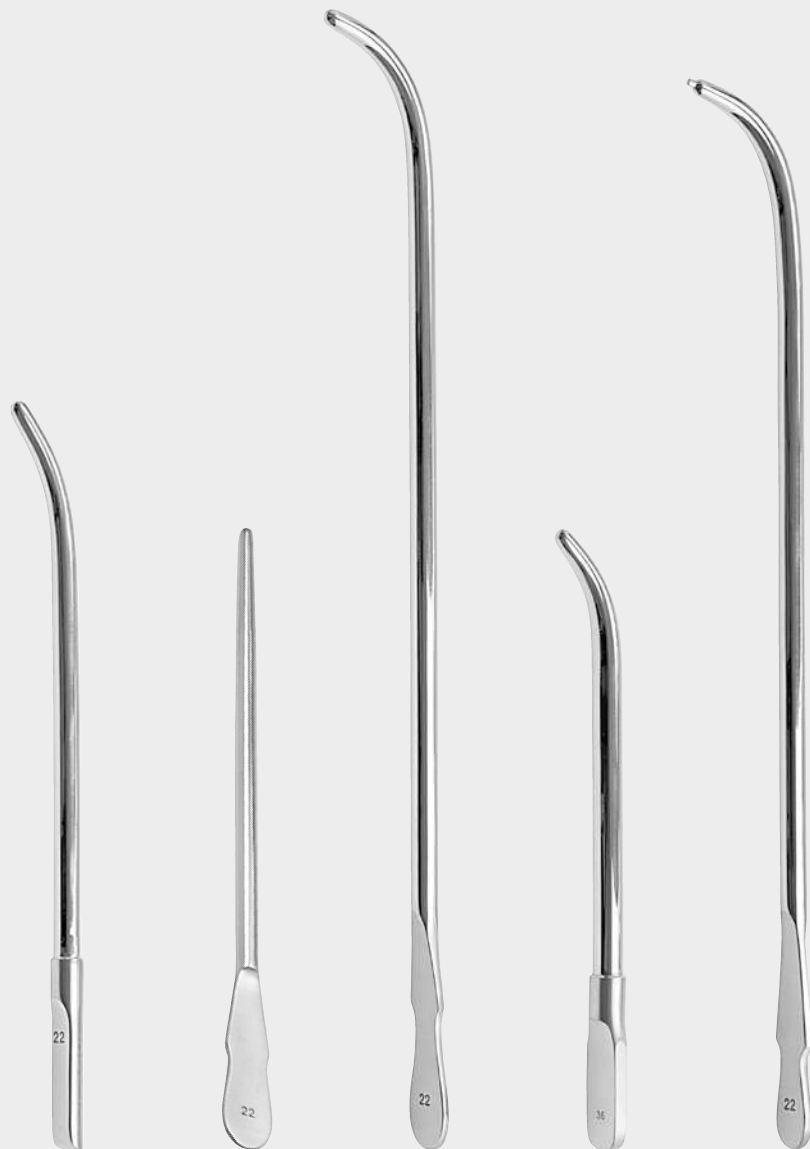

UROLOGIE

UROLOGY

UROLOGIE

UROLOGÍA

UROLOGIA

Charr. / FG.	McCREA	JEWETT	OTIS	WALTHER	LEFORT
6	66-2131-06	66-2132-06	66-2133-06		66-2137-06
8	66-2131-08	66-2132-08	66-2133-08		66-2137-08
10	66-2131-10	66-2132-10	66-2133-10		66-2137-10
12	66-2131-12	66-2132-12	66-2133-12		66-2137-12
14	66-2131-14	66-2132-14	66-2133-14		66-2137-14
16	66-2131-16	66-2132-16	66-2133-16	66-2135-16	66-2137-16
18	66-2131-18	66-2132-18	66-2133-18	66-2135-18	66-2137-18
20	66-2131-20	66-2132-20	66-2133-20	66-2135-20	66-2137-20
22	66-2131-22	66-2132-22	66-2133-22	66-2135-22	66-2137-22
24	66-2131-24	66-2132-24	66-2133-24	66-2135-24	66-2137-24
26	66-2131-26	66-2132-26	66-2133-26	66-2135-26	66-2137-26
28	66-2131-28	66-2132-28	66-2133-28	66-2135-28	66-2137-28
30	66-2131-30	66-2132-30	66-2133-30	66-2135-30	66-2137-30
32	66-2131-32	66-2132-32	66-2133-32	66-2135-32	66-2137-32
34	66-2131-34	66-2132-34	66-2133-34	66-2135-34	66-2137-34
36	66-2131-36		66-2133-36	66-2135-36	66-2137-36
38			66-2133-38		
40			66-2133-40		
	19,5 cm	24,0 cm	30,0 cm	24,0 cm	28,0 cm



UROLOGIE

UROLOGY

UROLOGIE

UROLOGÍA

UROLOGIA



MASTDARM

RECTUM

RECTUM

RECTO

RETTO

Mastdarm-Spekula
Rectal Specula
Spécule rectaux
Espéculos rectales
Specoli rettali

MASTDARM

RECTUM

RECTUM

RECTO

RETTO



cm	CZERNY
22,0	68-1005-22



mm	SAWYER
65 x 22	68-1008-22
76 x 29	68-1008-29
89 x 38	68-1008-38



mm	HILL FERGUSSON 21,5 cm
64 x 24	68-1010-24
72 x 32	68-1010-32
76 x 35	68-1010-35



cm	SIMS
15,0	68-1100-15



cm	BODENHAMMER
15,0	68-1105-15
	68-1107-15

Kaltlicht
Cold Light
Lumière froide
Luz fría
Luce fredda



	PRATT
	68-1201-00



68-1203-99

mm	SCHULZE-BERGMANN (SIMS)
60 x 20	68-1203-06
80 x 20	68-1203-08
120 x 20	68-1203-12



cm BARR
17,0 68-1205-17
70 x 22 mm



cm MATHIEU
19,5 68-1300-19

68-1300-99

Mastdarm-Spekula
Rectal Specula
Spéculums rectaux
Espéculos rectales
Specoli rettali

MASTDARM

RECTUM

RECTUM

RECTO

RETTO

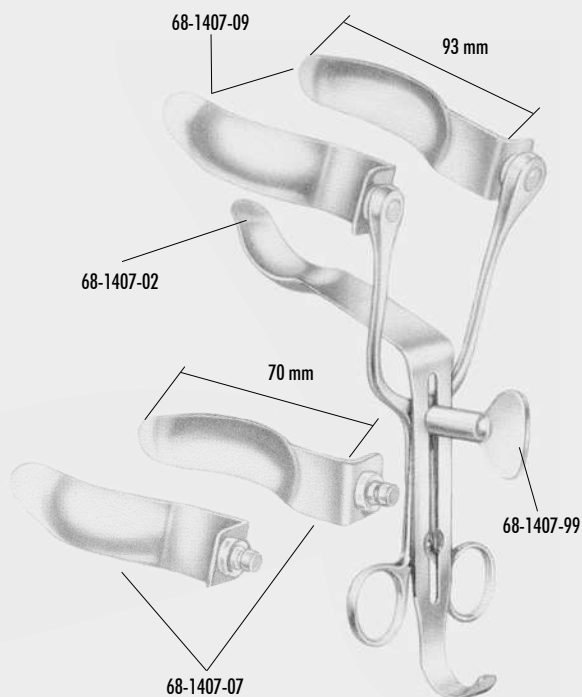

cm ALAN-PARKS compl.
13,5 68-1407-00
13,5 68-1408-00 Kaltlicht
Cold Light
Lumière froide
Luz fría
Luce fredda



cm SMITH-BUIE
15,0 68-1500-15
75 x 23 mm

Mastdarm-Spreizer
Anal Retractors
Dilatateurs pour anus et rectum
Separadores rectales
Dilatatori per l'ano e il retto

Rektoskope, Proktoskope
Rectoscopes, Proctoscopes
Rectoscopes, Proctoscopes
Rectoscopios, Proctoscopios
Rettoscopi, Proctoscopi

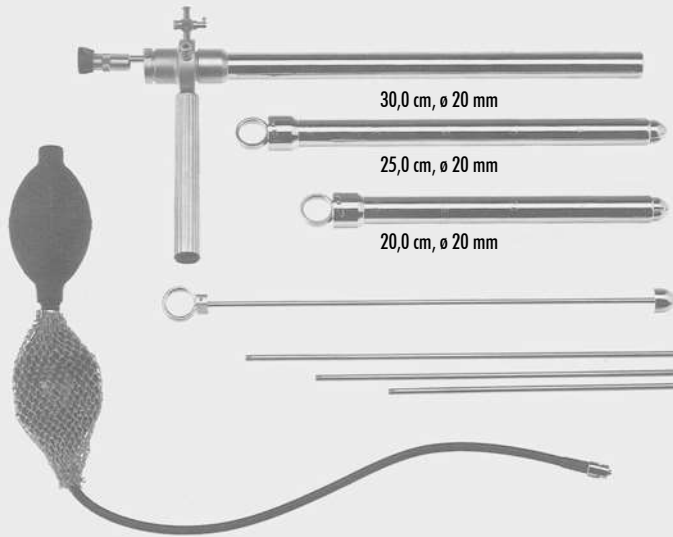

STRAUSS Kaltlicht-Beleuchtung · Fibre Light Illumination
68-1601-00 Illumination par lumière froide · Iluminación por luz fría
compl. Illuminazione con luce fredda

MASTDARM

RECTUM

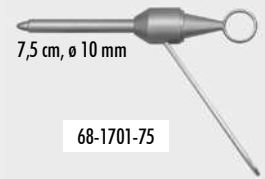

RECTUM



RECTO

RETTO



Kaltlicht-Aufsatz mit Fenster, komplett
Cold Light Chamber with Window, complete
Adaptateur lumière froide complet avec fenêtre
Cabeza de luz fría completa con ventanilla
Adattatore luce fredda completo con finestra



Fenster, allein
Window only
Fenêtre seule
Ventanilla suelta
Finestra sola



Kaltlicht-Aufsatz einzeln
Cold Light Chamber only
Adaptateur lumière froide seul
Cabeza de luz fría suelta
Adattatore luce fredda solo



Kaltlichtleiter allein
Cold Light guide only
Conducteur lumière froide seul
Guía de luz fría suelta
Guida di luce fredda sola

68-1702-99

Ersatzglas für:
spare glass for:
verre de rechange pour:
vidrio de repuesto para:
vetro di ricambio per:

68-1702-01

LLOYD-DAVIS Kaltlicht-Beleuchtung · Fibre Light Illumination
68-1700-00 Illumination par lumière froide · Iluminación por luz fría
compl. Illuminazione con luce fredda

Anoskope
Anoscopes
Anuscospes
Anoscopios
Anoscopi



ø mm IVES-FANSLER
22 68-2100-22
L = 80 mm



ø mm FANSLER
25 68-2101-25
29 68-2101-29
38 68-2101-38
L = 65 mm



ø mm HIRSCHMANN
16 68-2102-16
19 68-2102-19
22 68-2102-22

MASTDARM

RECTUM

RECTUM

RECTO

RETTO



ø mm KELLY
21 68-2204-21
27 68-2204-27
L = 50 mm



ø mm NEWMAN
16 68-2210-16
19 68-2210-19
23 68-2210-23
L = 63 mm

Anoskope
Anoscopes
Anuscopos
Anoscopios
Anoscopi

MASTDARM

RECTUM

RECTUM

RECTO

RETTO



ø mm x L	KELLY
22 x 50	68-2200-05
22 x 100	68-2200-10
22 x 140	68-2200-14
22 x 200	68-2200-20



mm	CHELSEA-EATON
22	68-2212-22
30	68-2212-30
L = 65 mm	



ø mm	BENSAUDE
19	68-2222-19
22	68-2222-22
L = 70 mm	



ø mm	GABRIEL
19 x 49	68-2230-49
25 x 64	68-2230-64



68-2501-01
Fig. 1



68-2501-02
Fig. 2



68-2501-03
Fig. 3

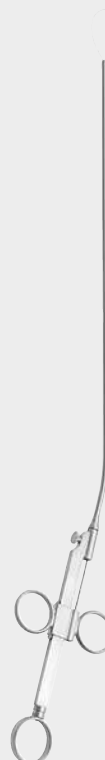
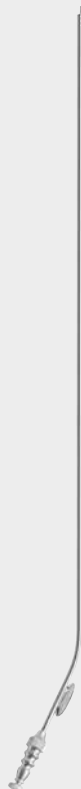

PRATT
68-2501-01 - 68-2501-03

cm
24,0 68-2503-24

cm **BUIE**
41,0 68-2601-41

cm **WESTON**
30,0 68-2603-30

Cystikus-Haken - Krypt Hooks
Écarteurs rectaux - Ganchos rectales
Uncini rettali

Saug-Kanüle
Aspirating Tube
Tube d'aspiration
Tubo de aspiración
Tubo di aspirazione

Rektl-Polypenschnürer
Rectal Polypus Snare
Serre-nœud rectal
Cierranudos rectal
Serranodi rettale

MASTDARM

RECTUM

RECTUM

RECTO

RETTO



Fig. 1

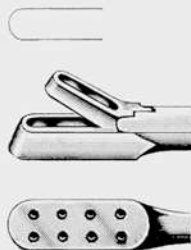

Fig. 2

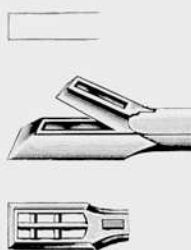

Fig. 3

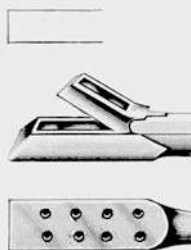
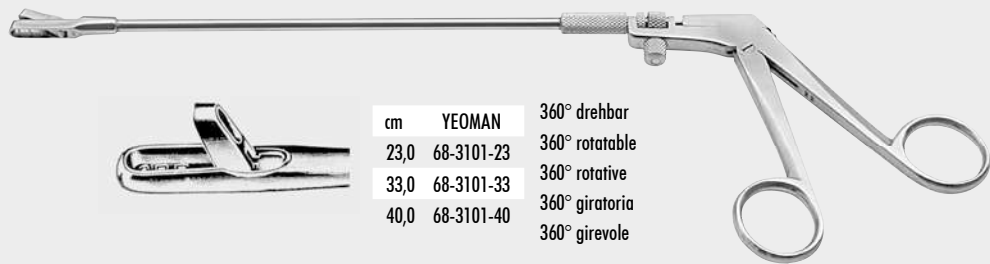

Fig. 4

cm	YEOMAN			
28,0	68-3001-28	68-3002-28	68-3003-28	68-3004-28
35,0	68-3001-35	68-3002-35	68-3003-35	68-3004-35
42,0	68-3001-42	68-3002-42	68-3003-42	68-3004-42

Biopsie-Zangen
Biopsy Specimen Forceps
Pincas emporte-pièce à biopsie
Pinzas sacabocado para biopsia
Pinze per biopsia

Biopsie-Zangen
 Biopsy Specimen Forceps
 Pinces emporte-pièce à biopsie
 Pinzas sacabocado para biopsia
 Pinze per biopsia



MASTDARM

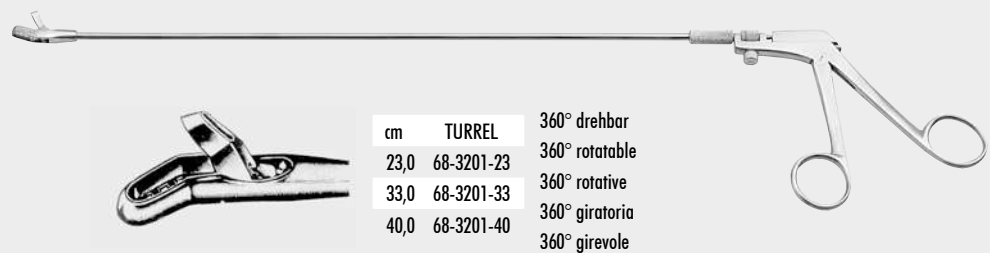

RECTUM

RECTUM

RECTO

RETTO

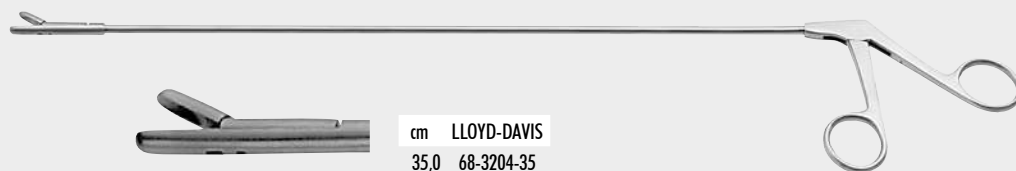

Fasszange bei Biopsie
 Grasping Forceps used for biopsy
 Pince à saisir le tissu pour la biopsie
 Pinza de agarre para biopsia
 Pinza afferrante per biopsia

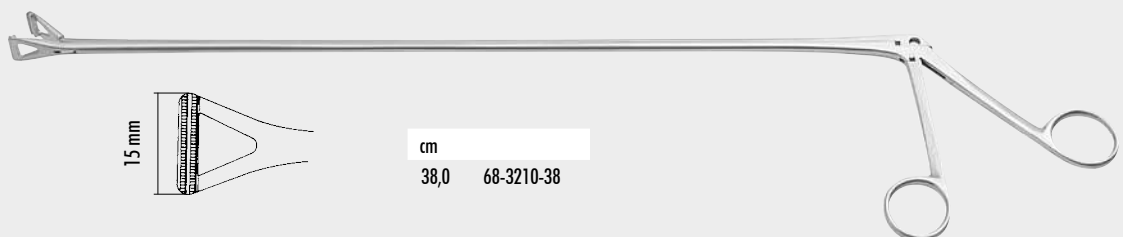

Haemorrhoiden-Zangen
 Pile Forceps
 Pincès à hémorroïdes
 Pinzas para hemorroides
 Pinze per emorroidi



cm HEYWOOD-SMITH
 21,0 68-4000-21

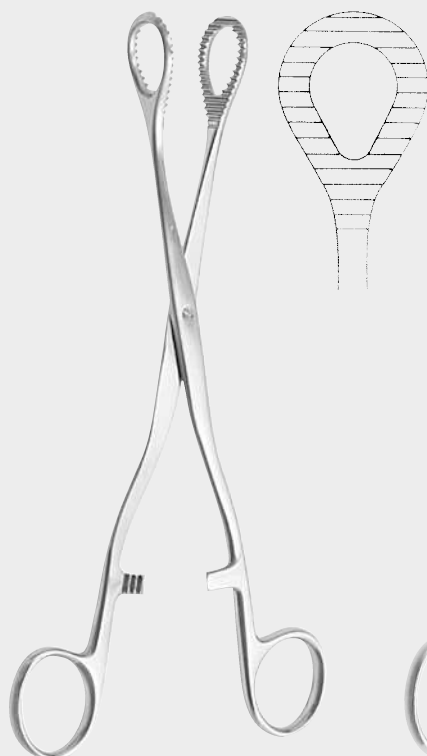

cm HEYWOOD-SMITH
 21,0 68-4002-21



cm HEYWOOD-SMITH modif.
 21,0 68-4002-22



cm HEYWOOD-SMITH
 25,0 68-4002-25



cm LUER
 24,5 68-4006-24

MASTDARM

RECTUM

RECTUM

RECTO

RETTO

Haemorrhoiden-Zangen
 Pile Forceps
 Pinces à hémorroïdes
 Pinzas para hemorroides
 Pinze per emorroidi

MASTDARM

RECTUM

RECTUM

RECTO

RETTO



cm St. GEORGE
20,0 68-4007-20



cm MC GIVNEY
19,0 68-4008-19

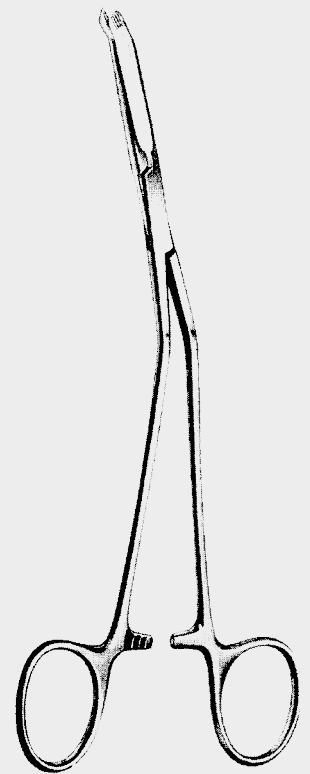

cm McGIVNEY
19,0 68-4009-19



cm BARRON
25,0 68-4010-25



68-4305-99

MC GIVNEY
68-4300-00

Haemorrhoidal Ligatoren
Haemorrhoidal Ligators
Ligateurs hémorroïdaux
Ligadores hemorroidales
Ligatori emorroidali



68-4305-99

ø mm RUDD
12,0 68-4302-00

MASTDARM

RECTUM



68-4305-99

ø mm McGIVNEY (SCHÜTZ)
12,0 68-4305-12

RECTUM

RECTO

RETTO

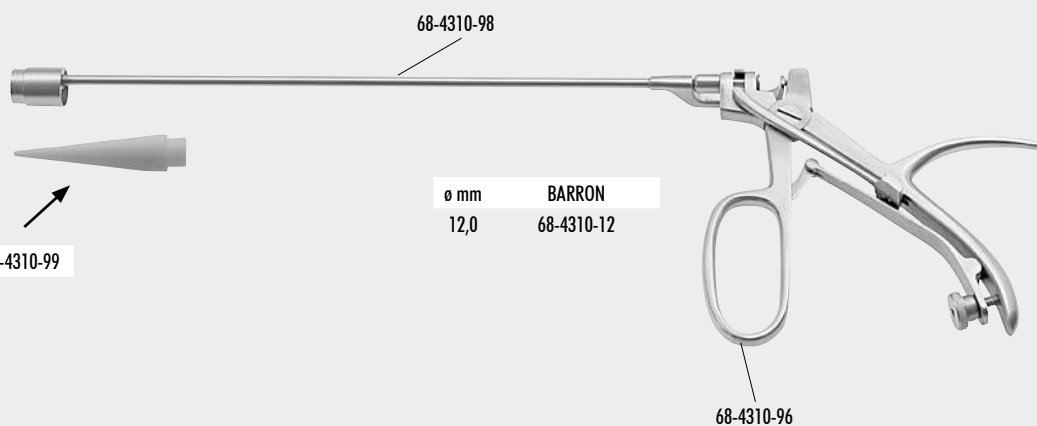

68-4310-99

ø mm BARRON
12,0 68-4310-12

68-4310-96

Haemorrhoidal Saugligatoren
Haemorrhoidal Aspirating Ligators
Ligateurs aspireurs hémorroïdaux
Ligadores aspiradores hemorroidales
Ligatori aspiratori emorroidali

90° abgewinkelt
90° angled
90° coudé
90° acodado
90° angolato

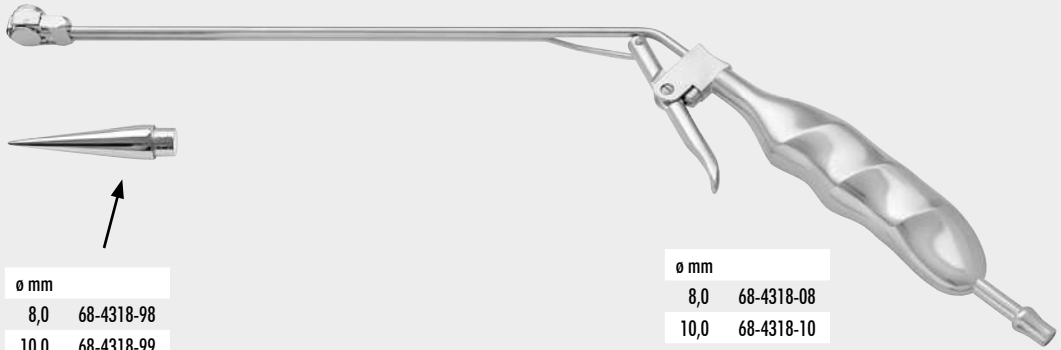

MASTDARM

RECTUM

RECTUM

RECTO

RETTO

30° aufwärts gewinkelt
30° angled up
30° coudé vers le haut
30° acodado hacia arriba
30° angolato in alto

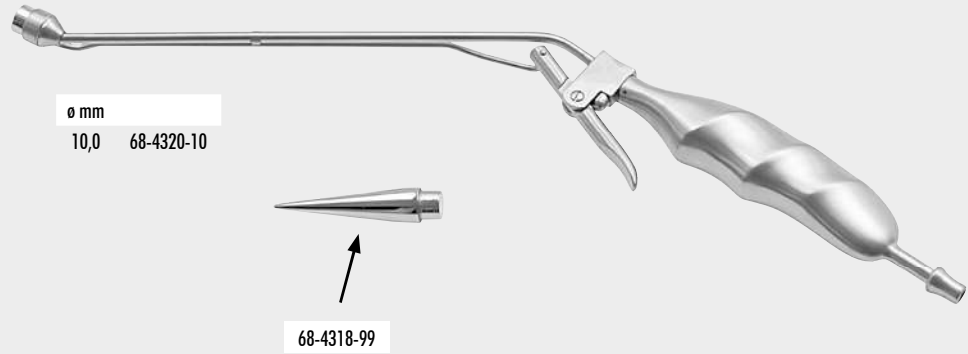

30° abwärts gewinkelt
30° angled down
30° coudé vers le bas
30° acodado hacia abajo
30° angolato in basso



68-4332-00

Ligatur Gummi Ringe 100 Stück, Latex-frei
Ligature Rubber Rings 100 ea., Latex free
Anneaux à ligature en les 100,
Anillos de ligadura de 100 c/u,
Anelli di legatura in 100 pezzi,

GYNÄKOLOGIE

GYNECOLOGY

GYNÉCOLOGIE

GINECOLOGÍA

GINECOLOGIA

Scheiden-Spekula
 Vaginal Specula
 Spéculum vaginaux
 Espéculos vaginales
 Specoli vaginali

GYNÄKOLOGIE

GYNECOLOGY

GYNÉCOLOGIE

GINECOLOGÍA

GINECOLOGIA



Fig.	mm	GRAVE
1	75 x 20	70-1100-01
2	95 x 35	70-1100-02
3	115 x 35	70-1100-03



Fig.	mm	PEDERSON
1	75 x 13	70-1200-01
2	100 x 22	70-1200-02
3	120 x 25	70-1200-03
	100 x 16	70-1202-10

schlank / slender / étroit
 estrecho / stretto

Scheiden-Spekula
Vaginal Specula
Spéculums vaginaux
Espéculos vaginales
Specoli vaginali

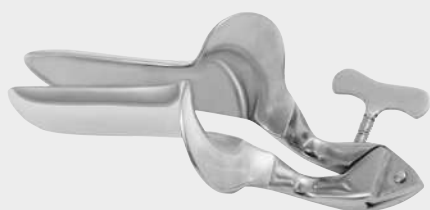

Fig.	mm	COLLIN
1	85 x 30	70-1300-01
2	100 x 35	70-1300-02
3	110 x 40	70-1300-03

GYNÄKOLOGIE

GYNECOLOGY

GINECOLOGIE

GINECOLOGÍA

GINECOLOGIA



COLLIN
70-1301-00
65 x 20 mm



COLLIN
70-1302-00
65 x 10 mm

Für Kinder
Child Size
Pour enfants
para niñas
Per bambine



Fig.	mm	COLLIN LANDAU
1	100 x 35	70-1303-02

Scheiden-Spekula
 Vaginal Specula
 Spéculum vaginaux
 Espéculos vaginales
 Specoli vaginali



Seitliche Schraube - Lateral
 Screw - Vis latérale - Tornillo
 lateral - Vite laterale

Fig.	mm	CUSCO
0	80 x 24	70-1400-00
1	75 x 32	70-1400-01
2	85 x 35	70-1400-02
3	100 x 35	70-1400-03

GYNÄKOLOGIE

GYNECOLOGY

GYNÉCOLOGIE

GINECOLOGÍA

GINECOLOGIA

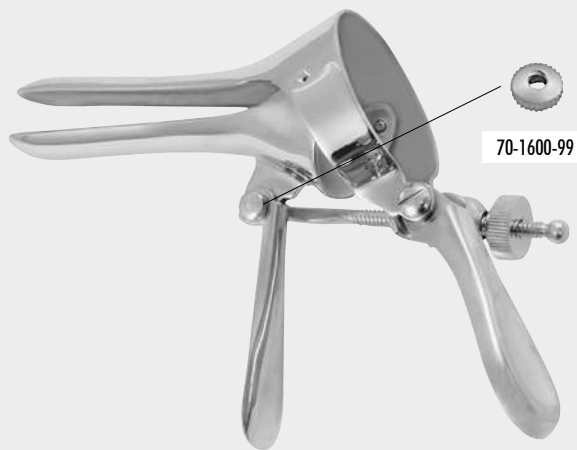

70-1600-99



70-1600-99

Mittelschraube - Central Screw -
Vis centrale - Tornillo central -
Vite centrale

CUSCO
70-1412-00
75 x 17 mm

Seitliche Schraube - Lateral Screw -
Vis latérale - Tornillo lateral -
Vite laterale

Fig.	mm	CUSCO
0	75 x 17	70-1500-00
1	75 x 32	70-1500-01
2	85 x 36	70-1500-02
3	95 x 37	70-1500-03
4	110 x 37	70-1500-04

Scheiden-Spekula
Vaginal Specula
Spéculums vaginaux
Espécules vaginales
Specoli vaginali

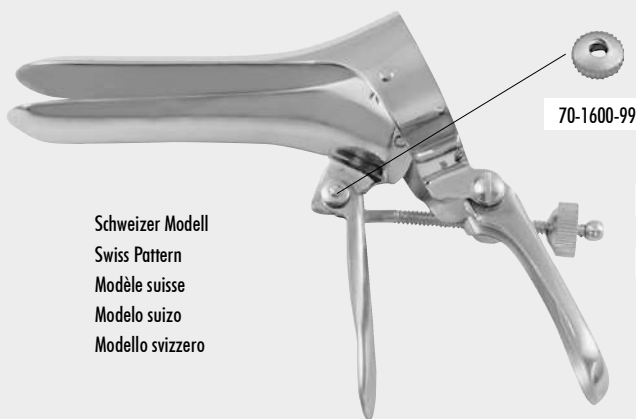

70-1600-99

Schweizer Modell
Swiss Pattern
Modèle suisse
Modelo suizo
Modello svizzero

Fig.	mm	CUSCO
1	90 x 23 - 25	70-1600-01
2	100 x 25 - 27	70-1600-02
3	110 x 27 - 30	70-1600-03

GYNÄKOLOGIE

GYNECOLOGY

GINECOLOGIE



Fig.	mm	SEYFFERT
1	100 x 17	70-1700-01
2	110 x 33	70-1700-02

GINECOLOGÍA

GINECOLOGIA



Fig.	mm	SEYFFERT
2	110 x 33	70-1701-02

eine Seite offen
open sided
un côté ouvert
un lado abierto
un fianco aperto

Scheiden-Spekula
Vaginal Specula
Spéculum vaginaux
Espéculos vaginales
Specoli vaginali

GYNÄKOLOGIE

GYNECOLOGY

GYNÉCOLOGIE

GINECOLOGÍA

GINECOLOGIA



mm	GUTTMANN
90 x 35	70-1710-01



mm	TRELAT
85 x 33	70-1800-01
95 x 35	70-1800-02
115 x 43	70-1800-03



mm	SEMM
90 x 14 - 18	70-1900-00
100 x 17 - 20	70-1900-01
100 x 25 - 30	70-1900-02



Fig.	GRAVE „View More“	mm
2	70-1910-02	95 x 35
3	70-1910-03	115 x 35



cm	70-2002-00
22,5	70-2002-00

Seitensperrerr für Vaginal-Spekula
Lateral Retractor for vaginal specula
Écarteur latéral pour spéculum vaginaux
Separador lateral para espéculos vaginales
Divaricatore laterale per specoli vaginali

Scheiden-Spekula
Vaginal Specula
Spéculums vaginaux
Espéculos vaginales
Specoli vaginali

GYNÄKOLOGIE

GYNECOLOGY

GINECOLOGIE

GINECOLOGÍA

GINECOLOGIA



Satz
Set
Jeu
Juego
Set

Fig.	KRISTELLER
0	70-2100-00
1	70-2100-01
2	70-2100-02
3	70-2100-03



Spekulum
Speculum
Spéculum
Espéculo
Specolo

Fig.	mm	KRISTELLER
0	70 x 15	70-2101-00
1	70 x 27	70-2101-01
2	80 x 30	70-2101-02
3	90 x 36	70-2101-03



Scheidenhalter
Vaginal Retractor
Valve vaginale
Valva vaginal
Valva vaginale

Fig.	mm	KRISTELLER
0	75 x 10	70-2102-00
1	75 x 23	70-2102-01
2	85 x 26	70-2102-02
3	100 x 32	70-2102-03



Mit konischen Blättern, für Jungfrauen
With taper blades, for virgins
A valves coniques, pour vierges
Con hojas cónicas, para vírgenes
Con valve coniche, per vergini

Satz
Set
Jeu
Juego
Set

Fig.	KRISTELLER
1	70-2200-01
2	70-2200-02

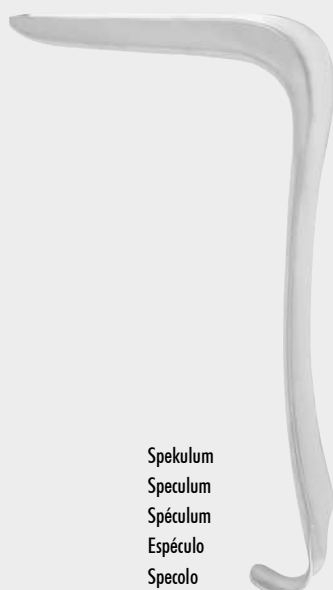

Spekulum
Speculum
Spéculum
Espéculo
Specolo

mm	KRISTELLER
105 x 18	70-2201-01
105 x 21	70-2201-02



Scheidenhalter
Vaginal Retractor
Valve vaginale
Valva vaginal
Valva vaginale

mm	KRISTELLER
110 x 14	70-2202-01
115 x 17	70-2202-02

Scheiden-Spekula
Vaginal Specula
Spécuments vaginaux
Espéculos vaginales
Specoli vaginali

GYNÄKOLOGIE

GYNECOLOGY

GYNÉCOLOGIE

GINECOLOGÍA

GINECOLOGIA



Satz
Set
Jeu
Juego
Set

Fig.	KRISTELLER
1	70-2300-01
2	70-2300-02
3	70-2300-03



Flache Spekula
Specula Flat Hollow
Spécuments plats
Espéculos con huecos planos
Specoli piatti

Spekulum
Speculum
Spéculum
Espéculo
Specolo

Fig.	mm	KRISTELLER
1	105 x 26	70-2301-01
2	105 x 28	70-2301-02
3	105 x 33	70-2301-03



Scheidenhalter
Vaginal Retractor
Valve vaginale
Valva vaginal
Valva vaginale

Fig.	mm	KRISTELLER
1	115 x 22	70-2302-01
2	115 x 24	70-2302-02
3	115 x 29	70-2302-03



Satz
Set
Jeu
Juego
Set

Fig.	KRISTELLER
1	70-2400-01
2	70-2400-02
3	70-2400-03

Tiefe Spekula
Specula Deep Hollow
Spécuments profonds
Espéculos con huecos profundos
Specoli profondi

Spekulum
Speculum
Spéculum
Espéculo
Specolo

Fig.	mm	KRISTELLER
1	110 x 27	70-2401-01
2	110 x 30	70-2401-02
3	110 x 36	70-2401-03



Scheidenhalter
Vaginal Retractor
Valve vaginale
Valva vaginal
Valva vaginale

Fig.	mm	KRISTELLER
1	115 x 23	70-2402-01
2	115 x 26	70-2402-02
3	115 x 32	70-2402-03



Extra großes Modell
Extra large pattern
Modèle extra grand
Modelo extra grande
Modello extra grande

Satz
Set
Jeu
Juego
Set

KRISTELLER
70-2500-00
Set

Spekulum
Speculum
Spéculum
Espéculo
Specolo

KRISTELLER
70-2501-00
135 x 36 mm



Scheidenhalter
Vaginal Retractor
Valve vaginale
Valva vaginal
Valva vaginale

KRISTELLER
70-2502-00
140 x 30 mm

Scheiden-Spekula
Vaginal Specula
Spéculums vaginaux
Espéculos vaginales
Specoli vaginali

GYNÄKOLOGIE

GYNECOLOGY

GYNÉCOLOGIE

GINECOLOGÍA

GINECOLOGIA

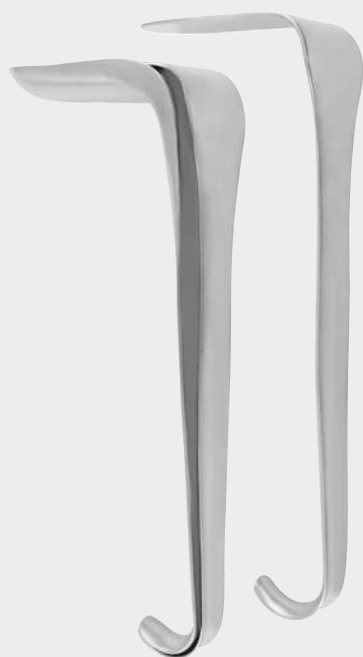

KALLMORGEN
70-2600-01 - 70-2602-02

Spekulum
Speculum
Spéculum
Espéculo
Specolo

Scheidenhalter
Vaginal Retractor
Valve vaginale
Valva vaginal
Valva vaginale

KALLMORGEN	Fig	Set	mm	mm
	1	70-2600-01 70-2601-01	70 x 40	70-2602-01 70 x 33
	2	70-2600-02 70-2601-02	90 x 40	70-2602-02 90 x 33

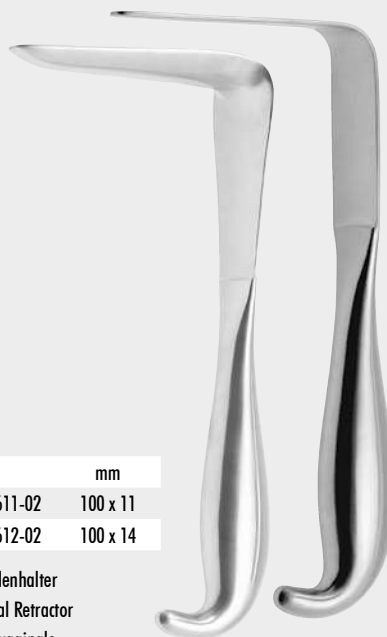

MATHIEU
70-2611-01 - 70-2612-02

MATHIEU	Fig	Set	mm	mm
	1	70-2611-00 70-2611-01	95 x 13	70-2611-02 100 x 11
	2	70-2612-00 70-2612-01	95 x 16	70-2612-02 100 x 14

Spekulum
Speculum
Spéculum
Espéculo
Specolo

Scheidenhalter
Vaginal Retractor
Valve vaginale
Valva vaginal
Valva vaginale

Scheiden-Spekula
Vaginal Specula
Spéculums vaginaux
Espéculos vaginales
Specoli vaginali

GYNÄKOLOGIE

GYNECOLOGY

GYNÉCOLOGIE

GINECOLOGÍA

GINECOLOGIA

Fig. 1 = klein/small/petit/pequeño/piccolo
Fig. 2 = mittel/medium/moyen/mediano/medio
Fig. 3 = groß/large/grand/grande



JACKSON	Fig.	mm
70-2701-01	1	75 x 41
70-2701-02	2	90 x 41
70-2701-03	3	100 x 41

SIMS	Fig.
70-2801-01	1
70-2801-02	2
70-2801-03	3

SIMS	Fig.
70-2901-01	1
70-2901-02	2
70-2901-03	3
70-2901-00 = Set	

BREISKY	cm	mm	mm
70-2907-01	14,0	72 x 25	77 x 30
70-2907-02	17,0	75 x 30	92 x 38

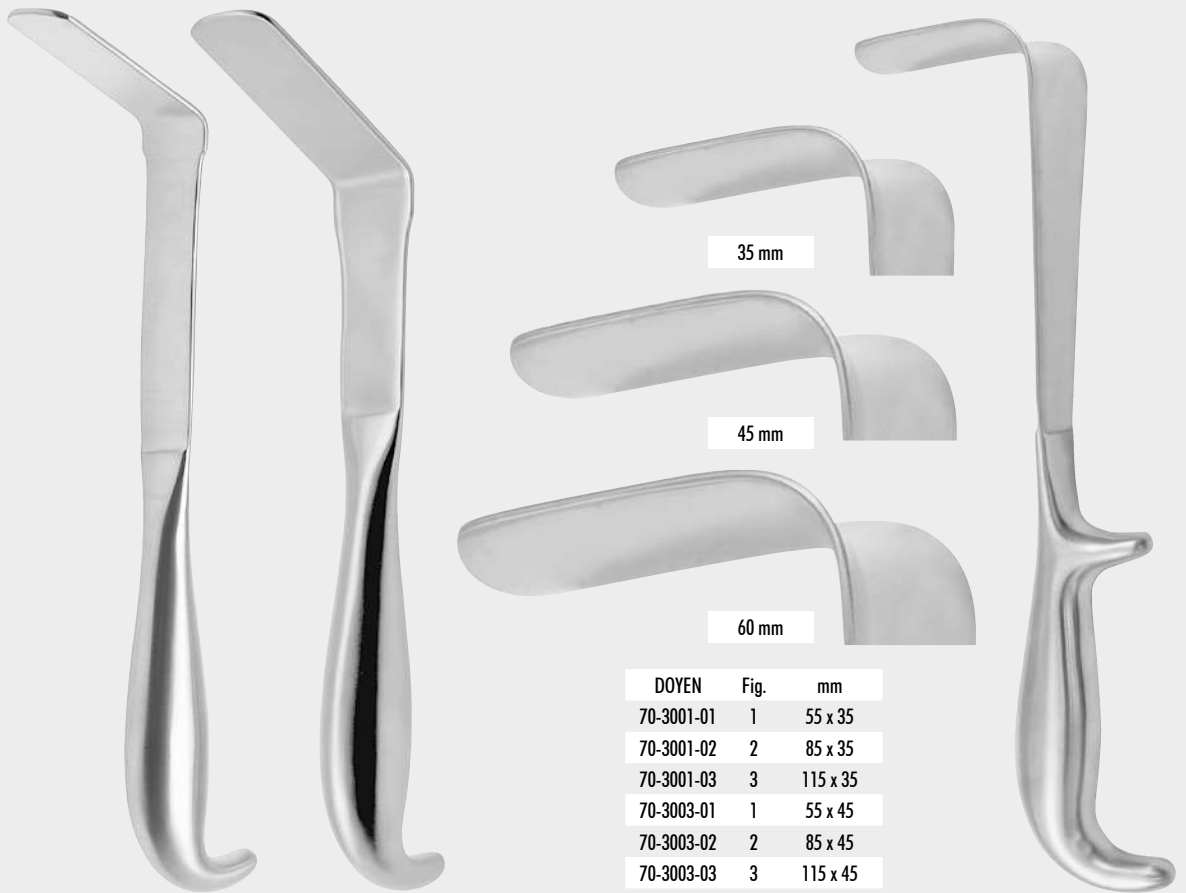

cm	DOYEN LATERAL
23,0	70-2994-30
25,0	70-2996-30
	80 x 30 mm

cm	DOYEN
25,0	70-2998-30
	70 x 30 mm

DOYEN	Fig.	mm
70-3001-01	1	55 x 35
70-3001-02	2	85 x 35
70-3001-03	3	115 x 35
70-3003-01	1	55 x 45
70-3003-02	2	85 x 45
70-3003-03	3	115 x 45
70-3003-04	4	160 x 45
70-3005-01	1	55 x 60
70-3005-02	2	85 x 60
70-3005-03	3	115 x 60
70-3005-04	4	160 x 60

DOYEN
70-3001-01 - 70-3005-04



DOYEN	mm
70-3006-01	75 x 45
70-3006-02	90 x 45
70-3006-03	110 x 45



Loses Gewicht	Festes Gewicht
Detachable Weight	Fixed Weight
Poids démontable	Poids fixe
Pesa desmontable	Pesa fija
Peso smontabile	Peso fisso

AUVARD		
70-3007-00	75 x 40 mm	70-3008-10
70-3007-10	105 x 40 mm	70-3009-00

GYNÄKOLOGIE

GYNECOLOGY

GINECOLOGIE

GINECOLOGÍA

GINECOLOGIA



cm	WEISSBARTH
	70-3010-00
	80 x 42 mm



JAYLE	mm
70-3013-60	60 x 40
70-3013-90	90 x 40

Scheiden-Spekula
Vaginal Specula
Spéculum vaginaux
Espéculos vaginales
Specoli vaginali

für Kinder
child and infant sizes
pour enfants et bébés
para niñas y niñas de corta edad
per bambine e giovanette



mm	SEIDL
80 x 8	70-3018-08
80 x 10	70-3018-10
90 x 14	70-3018-14



cm	BRAUN
18,0	70-3021-01
	56 x 13 mm

cm	BRAUN
18,0	70-3021-02
	60 x 10 mm

GYNÄKOLOGIE

GYNECOLOGY

GYNÉCOLOGIE

GINECOLOGÍA

GINECOLOGIA



Satz komplett
Set complete
Jeu complet
Juego completo
Set completo

KRISTELLER	Mod. Wien - Vienna - Vienne - Viena
70-3024-01	110 x 20 mm
70-3024-02	110 x 30 mm
70-3024-03	110 x 36 mm

Scheiden-Spekula
 Vaginal Specula
 Spéculums vaginaux
 Espécules vaginales
 Specoli vaginali

GYNÄKOLOGIE

GYNECOLOGY

GINECOLOGIE

GINECOLOGÍA

GINECOLOGIA

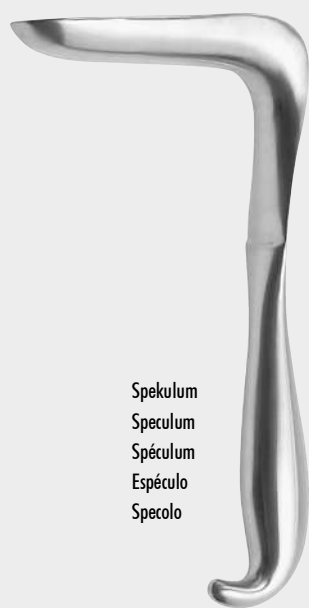

Spekulum
 Speculum
 Spéculum
 Espéculo
 Specolo

mm	
110 x 20	70-3025-01
110 x 30	70-3025-02
110 x 36	70-3025-03

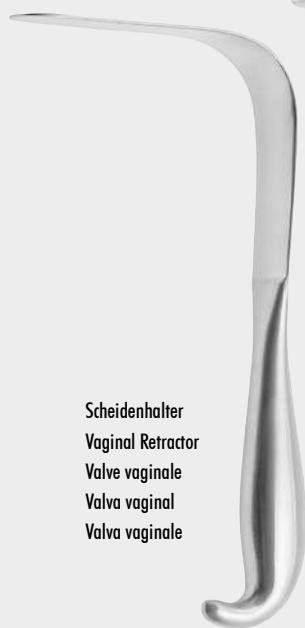

Scheidenhalter
 Vaginal Retractor
 Valve vaginale
 Valva vaginal
 Valva vaginale

mm	
115 x 18	70-3026-01
115 x 26	70-3026-02
115 x 32	70-3026-03



cm	
LANDON	70-3028-25
89 x 25 mm	



cm	
Tuebingen	70-3031-28
28,0	95 x 20 mm

Scheiden-Spekula
Vaginal Specula
Spéculums vaginaux
Espéculos vaginales
Specoli vaginali

GYNÄKOLOGIE

GYNECOLOGY

GYNÉCOLOGIE

GINECOLOGÍA

GINECOLOGIA



mm	BREISKY 27,0 cm
39 x 42	70-3039-42
43 x 48	70-3039-48
48 x 54	70-3039-54
53 x 60	70-3039-60

70-3043-99

Griff allein
Handle only
Manche seul
Mango suelto
Manico solo



g	
400	70-3043-40
800	70-3043-80

Gewicht allein
Weight only
Poids seul
Pesa suelta
Peso solo



70-3041-01*
80 x 30 mm



70-3041-02*
85 x 35 mm



70-3041-03*
90 x 40 mm



70-3041-04*
55 x 40 / 60 mm

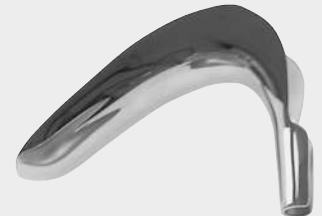

70-3041-05*
70 x 45 / 70 mm

SCHERBAK
70-3040-00
Set compl.*

Scheiden-Spekula
Vaginal Specula
Spéculum vaginaux
Espécules vaginales
Specoli vaginali

GYNÄKOLOGIE

GYNECOLOGY

GINECOLOGIE

GINECOLOGÍA

GINECOLOGIA

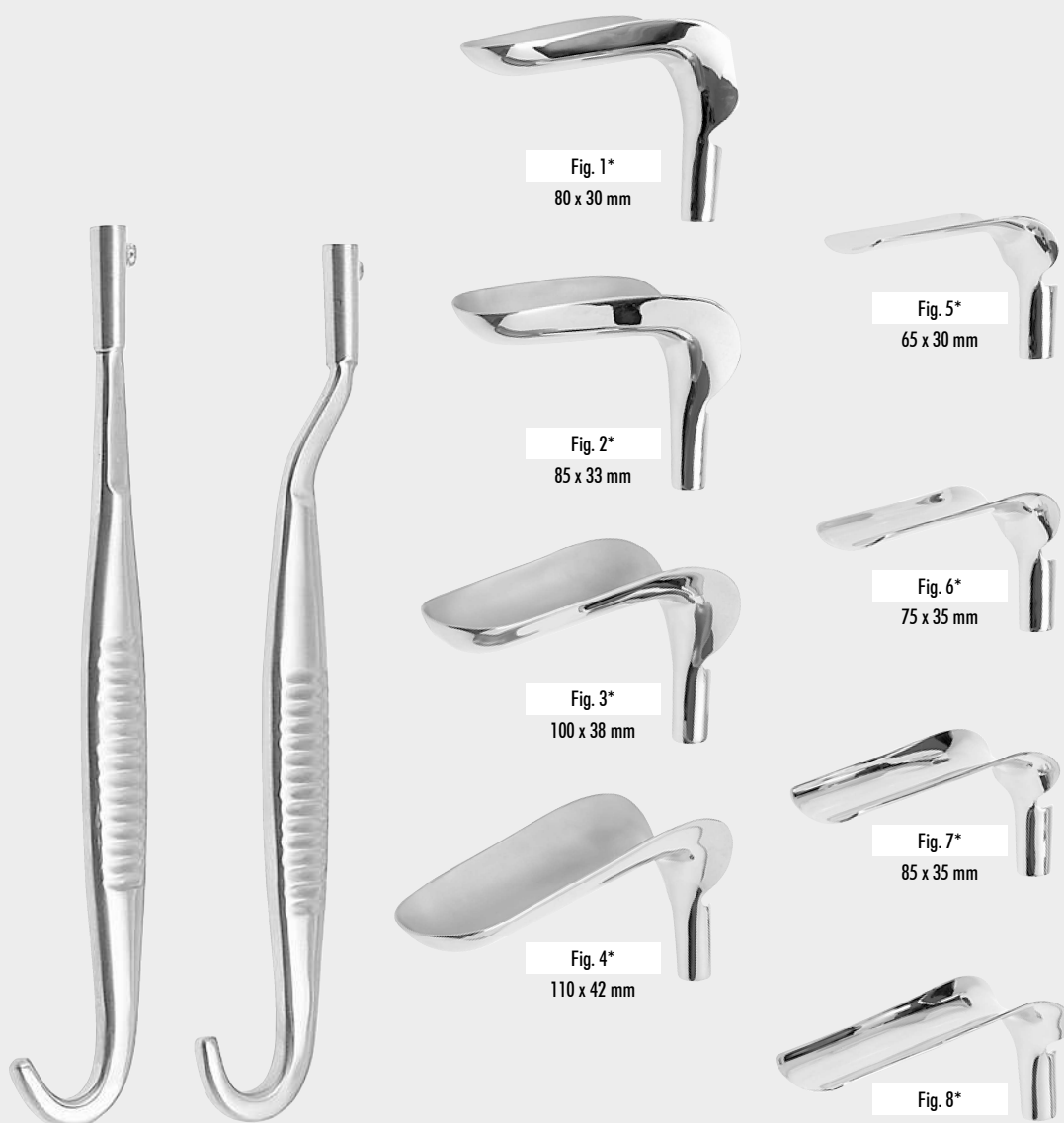

cm	BOZEMANN	cm
23,0	70-3046-98*	70-3046-99* 22,0

	Fig.	mm
70-3046-00	0	Set compl*
70-3046-01	1	80 x 30
70-3046-02	2	85 x 33
70-3046-03	3	100 x 38
70-3046-04	4	110 x 42
70-3046-05	5	65 x 30
70-3046-06	6	75 x 35
70-3046-07	7	85 x 35
70-3046-08	8	95 x 35

Scheiden-Spekula
Vaginal Specula
Spéculums vaginaux
Espéculos vaginales
Specoli vaginali

GYNÄKOLOGIE

GYNECOLOGY

GYNÉCOLOGIE

GINECOLOGÍA

GINECOLOGIA



mm	BREISKY
100 x 20	70-3100-20
100 x 25	70-3100-25
100 x 30	70-3100-30
100 x 35	70-3100-35
100 x 40	70-3100-40
130 x 20	70-3103-20
130 x 25	70-3103-25
130 x 30	70-3103-30
130 x 35	70-3103-35
130 x 40	70-3103-40
70 x 25	70-3105-25
155 x 40	70-3105-40
180 x 40	70-3106-40



mm	LANDAU
100 x 28	70-3109-28
100 x 38	70-3109-38
110 x 38	70-3111-38



cm	FRIEDMANN
10,0	70-3501-10



O'SULLIVAN-O'CONNOR
70-3505-00



	Standard	KOGAN	Laser	KOGAN
3 mm	70-3600-24	24,0 cm	70-3604-24	3 mm 70-3608-22
4 mm	70-3601-24	24,0 cm	70-3605-24	4 mm 70-3608-23
5 mm	70-3602-24	24,0 cm	70-3606-24	5 mm 70-3608-24

Endospekulum - Endo-Speculum - Endospeculum - Endoespéculo - Endospecolo

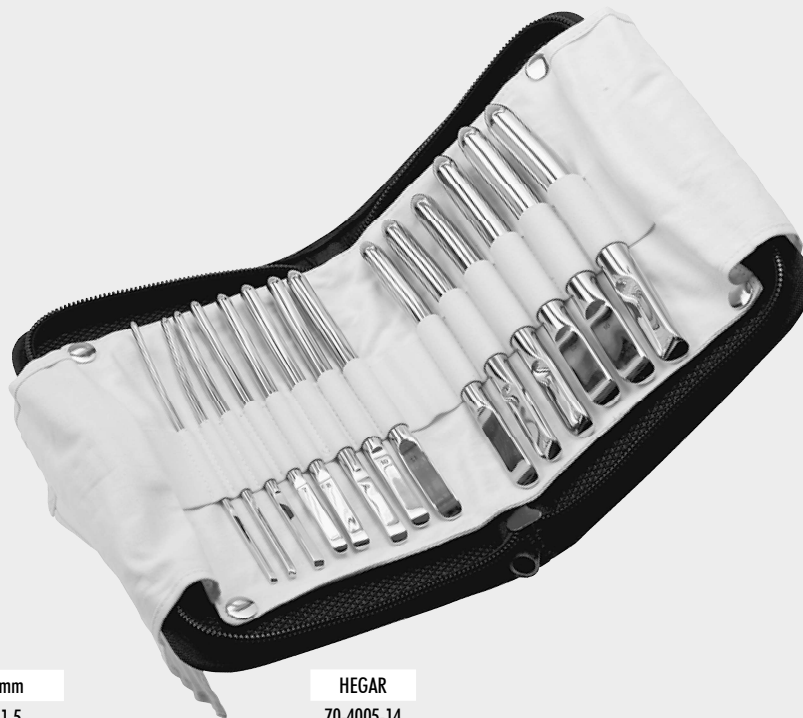

Uterus-Dilatatoren
Uterine Dilators
Dilatateurs utérins
Dilatadores uterinos
Dilatatori uterini

GYNÄKOLOGIE

GYNECOLOGY

GINECOLOGIE

GINECOLOGÍA

GINECOLOGIA

mm	HEGAR		mm
1	70-4100-01	70-4105-01	1,5
2	70-4100-02	70-4105-02	2,5
3	70-4100-03	70-4105-03	3,5
4	70-4100-04	70-4105-04	4,5
5	70-4100-05	70-4105-05	5,5
6	70-4100-06	70-4105-06	6,5
7	70-4100-07	70-4105-07	7,5
8	70-4100-08	70-4105-08	8,5
9	70-4100-09	70-4105-09	9,5
10	70-4100-10	70-4105-10	10,5
11	70-4100-11	70-4105-11	11,5
12	70-4100-12	70-4105-12	12,5
13	70-4100-13	70-4105-13	13,5
14	70-4100-14	70-4105-14	14,5
15	70-4100-15	70-4105-15	15,5
16	70-4100-16	70-4105-16	16,5
17	70-4100-17	70-4105-17	17,5
18	70-4100-18	70-4105-18	18,5
19	70-4100-19	70-4105-19	19,5
20	70-4100-20		
21	70-4100-21		
22	70-4100-22		
23	70-4100-23		
24	70-4100-24		
25	70-4100-25		
26	70-4100-26		
27	70-4100-27		
28	70-4100-28		
29	70-4100-29		
30	70-4100-30		

HEGAR
70-4005-14
4-17 mm
14 Stück /ea./pces/ c./u./ pezzi



70-4004-14 Satz/Set/Jeu/Juego/Set
70-4100-04 - 70-4100-17 = 14 St. / ea. / pces. / c / u. / pezzi

70-4004-26 Satz/Set/Jeu/Juego/Set
70-4100-01 - 70-4100-26 = 26 St. / ea. / pces. / c / u. / pezzi

mm	HEGAR	
4-17	70-4006-14	14 Stück /ea./pces/c/u./pezzi
1-26	70-4006-26	26 Stück /ea./pces/c/u./pezzi

Uterus-Dilatatoren
Uterine Dilators
Dilatateurs utérins
Dilatadores uterinos
Dilatatori uterini

GYNÄKOLOGIE

GYNECOLOGY

GYNÉCOLOGIE

GINECOLOGÍA

GINECOLOGIA



70-4205-99

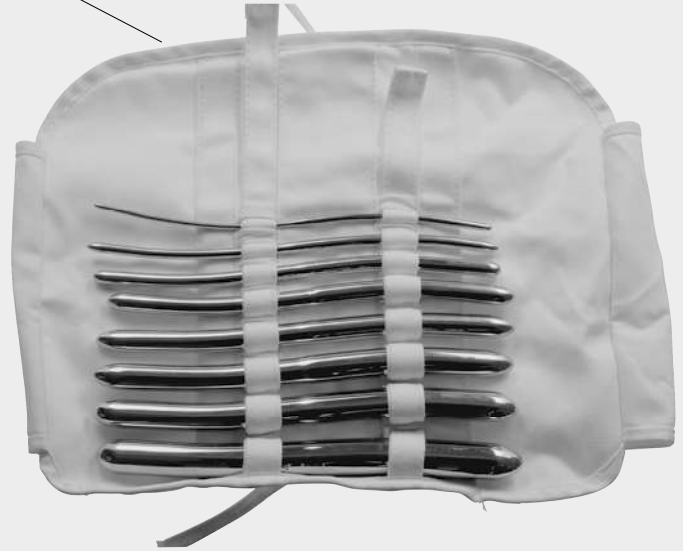

mm	HEGAR
1 / 2	70-4200-01
3 / 4	70-4200-03
5 / 6	70-4200-05
7 / 8	70-4200-07
9 / 10	70-4200-09
11 / 12	70-4200-11
13 / 14	70-4200-13
15 / 16	70-4200-15
17 / 18	70-4200-17
19 / 20	70-4200-19
21 / 22	70-4200-21
23 / 24	70-4200-23
25 / 26	70-4200-25

HEGAR	
70-4205-08	3 / 4 - 17 / 18 mm

8 Stück /ea./pcs/c/u./pezzi

70-4204-08 Satz/Set/Jeu/Juego/Set
70-4200-03 - 70-4200-17 = 8 St. / ea. / pcs. / c / u. / pezzi

70-4204-13 Satz/Set/Jeu/Juego/Set
70-4200-01 - 70-4200-25 = 13 St. / ea. / pcs. / c / u. / pezzi

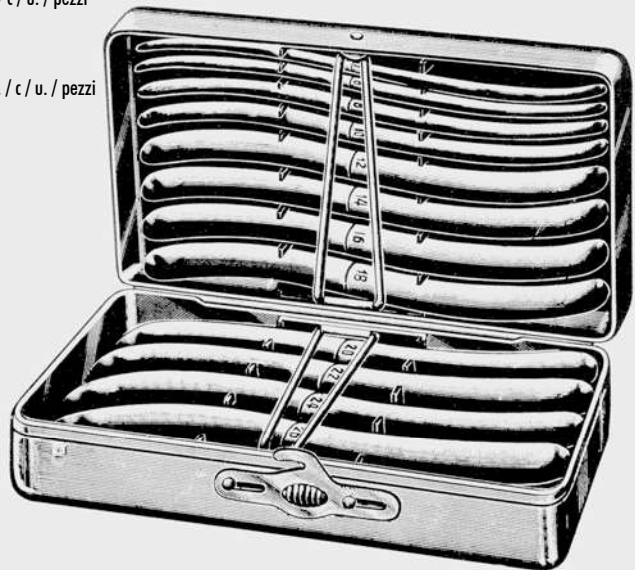

mm	HEGAR	
3/4 - 17/18	70-4206-08	8 Stück /ea./pcs/c/u./pezzi
1/2 - 25/26	70-4206-13	13 Stück /ea./pcs/c/u./pezzi

Uterus-Dilatatoren
 Uterine Dilators
 Dilatateurs utérins
 Dilatadores uterinos
 Dilatatori uterini



HAWKIN AMBLER	
	mm
70-4280-03	3 / 6
70-4280-04	4 / 7
70-4280-05	5 / 8
70-4280-06	6 / 9
70-4280-07	7 / 10
70-4280-08	8 / 11
70-4280-09	9 / 12
70-4280-10	10 / 13
70-4280-11	11 / 14
70-4280-12	12 / 15
70-4280-13	13 / 16
70-4280-14	14 / 17



PRATT	
	Charr. / F.G.
70-4290-13	13 / 15
70-4290-17	17 / 19
70-4290-21	21 / 23
70-4290-25	25 / 27
70-4290-29	29 / 31
70-4290-33	33 / 35
70-4290-37	37 / 39
70-4290-41	41 / 43
70-4290-45	45 / 47
70-4290-49	49 / 51
70-4290-53	53 / 55
70-4290-57	57 / 59



mm	HANK	Fig. U.S.
3,5 / 4	70-4300-08	7 / 8
4,5 / 5	70-4300-10	9 / 10
5,5 / 6	70-4300-12	11 / 12
6,5 / 7	70-4300-14	13 / 14
7,5 / 8	70-4300-16	15 / 16
8,5 / 9	70-4300-18	17 / 18
9,5 / 10	70-4300-20	19 / 20
Set / 6	70-4305-06	

70-4290-00 Set compl. 70-4290-13 - 70-4290-41
 Charr. 13 / 15 - 41 / 43



HANK
 70-4306-08
 Set / 6

GYNÄKOLOGIE

GYNECOLOGY

GINECOLOGIE

GINECOLOGÍA

GINECOLOGIA

Uterus-Dilatatoren
 Uterine Dilators
 Dilatateurs utérins
 Dilatadores uterinos
 Dilatatori uterini

GYNÄKOLOGIE

GYNECOLOGY

GYNÉCOLOGIE

GINECOLOGÍA

GINECOLOGIA

Hakenzangen
 Tenaculum Forceps
 Pincas pour abaissement du col de l'utérus
 Pinzas para coger el cuello del útero
 Pinze per abbassare il collo dell'utero



cm GOODELL
 34,0 70-4401-34



cm WYLIE
 29,0 70-4403-29



cm SIMS
 29,0 70-4405-29



cm MARTIN
 26,5 70-4420-26

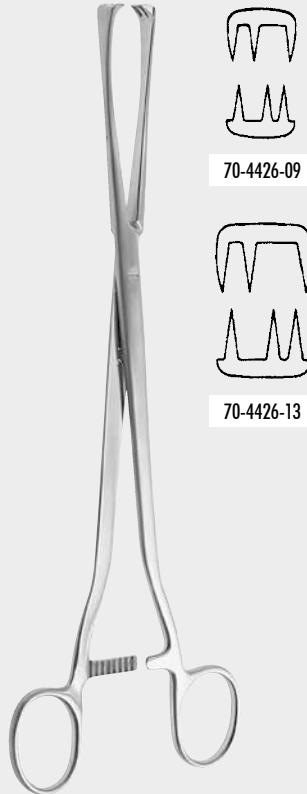

cm MUSEUX
 26,5 70-4426-09 - 70-4426-13



cm MUSEUX
 20,0 70-4430-20



cm WILSON
24,0 70-4996-24



cm COLLIN POZZI
25,0 70-4998-25



cm SCHRÖDER
25,0 70-5003-25

Hakenzangen
Tenaculum Forceps
Pinces pour abaissement du col de l'utérus
Pinzas para coger el cuello del útero
Pinze per abbassare il collo dell'utero

GYNÄKOLOGIE

GYNECOLOGY

GINECOLOGIE

GINECOLOGÍA

GINECOLOGIA



cm SCHROEDER
25,0 70-5002-25



cm BRAUN
25,0 70-5004-25



cm SKENE
24,0 70-5005-24



cm POZZI
17,5 70-5006-17
25,0 70-5006-25

Hakenzangen
 Tenaculum Forceps
 Pincas pour abaissement du col de l'utérus
 Pinzas para coger el cuello del útero
 Pinze per abbassare il collo dell'utero

GYNÄKOLOGIE

GYNECOLOGY

GYNÉCOLOGIE

GINECOLOGÍA

GINECOLOGIA



cm DUPLAY
 28,0 70-5007-28



cm STAUDE-MOORE
 17,0 70-5008-17



cm BARRETT
 18,0 70-5100-18



cm JARCHO
 20,0 70-5102-20

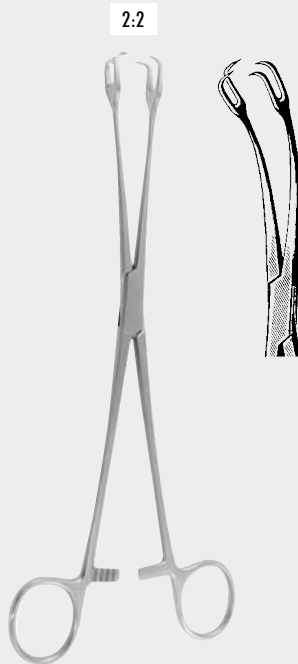

cm SCHROEDER
 20,0 70-5104-20 70-5105-20
 24,0 70-5104-24 70-5105-24

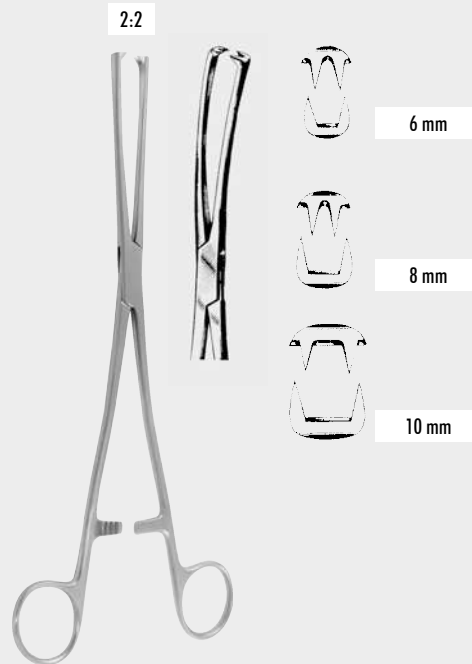

mm MUSEUX 24,0 cm
 6 70-5204-06 70-5205-06
 8 70-5204-08 70-5205-08
 10 70-5204-10 70-5205-10



cm KÜSTNER
 25,0 70-5298-25



cm TEALE
18,0 70-5301-18
23,0 70-5301-23



cm JACOBS
21,0 70-5302-21
70-5303-21



cm PRATT
28,0 70-5306-28



cm IOWA
26,0 70-5309-26

Hakenzangen
Vulsellum Forceps
Pinces pour abaissement du col de l'utérus
Pinzas para coger el cuello del útero
Pinze per abbassare il collo dell'utero

GYNÄKOLOGIE

GYNECOLOGY

GINECOLOGIE

GINECOLOGÍA

GINECOLOGIA



cm HENROTIN
20,5 70-5312-20



cm CZERNY
20,5 70-5314-20



cm BRAUN
15,5 70-5318-15



cm SCHRÖDER
27,0 70-5322-27

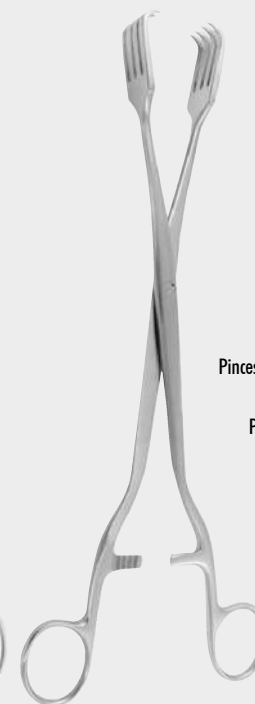

cm PRATT
26,0 70-5324-26

Hakenzangen
Vulsellum Forceps
Pinces pour abaissement du col de l'utérus
Pinzas para coger el cuello del útero
Pinze per abbassare il collo dell'utero

ZEPF®
INSTRUMENTS

Uterus-Faßzangen
 Uterine Elevating Forceps
 Pinces hystérolabes
 Pinzas para el útero
 Pinze per afferrare l'utero

GYNÄKOLOGIE

GYNECOLOGY

GYNÉCOLOGIE

GINECOLOGÍA

GINECOLOGIA



cm GREENHALGH
 24,0 70-5326-24



cm NOTO
 27,0 70-5400-27



cm DOYEN
 20,0 70-5402-20



cm KELLY
 32,0 70-5403-32
 32,0 70-5403-33*



cm COLLIN
 25,0 70-5404-25



cm DARTIGUES
 27,0 70-5405-27



cm SOMER
 23,0 70-5407-23

- * mit Sperre
- * with ratchet
- * avec crémallière
- * con cremallera
- * con cremagliera



cm COLLIN
25,0 70-5409-25



cm MC CLINTOCK
24,0 70-5415-25



cm I.U.D.
24,0 70-5506-30

Flexibles Extraktionsinstrument
Flexible Extraction Instrument
Instrument flexible d'extraction
Instrumento flexible de extracción
Strumento flessibile per estrazione



cm SAUNDERS
32,0 70-5507-32

Extraktionshaken
Extraction Hook
Crochet d'extraction
Gancho de extracción
Uncino per estrazione



70-5508-00

Uterus-Faßzangen
Uterine Elevating Forceps
Pinces hystérolabes
Pinzas para el útero
Pinze per afferrare l'utero

GYNÄKOLOGIE

GYNECOLOGY

GYNÉCOLOGIE

GINECOLOGÍA

GINECOLOGIA



cm BEACHAM
26,0 70-5509-26

Amniotom
Amniotome
Amniótomo
Amniotomo



cm HERFF
25,0 70-5514-25



cm BRAUN
28,0 70-5605-28

Uterus-Depressoren
Uterine Depressors
Dépresseurs utérins
Depressores uterinos
Depressori uterini



cm SIMS
26,0 70-5607-26

* nicht kalibriert
not calibrated
pas calibré
no calibrado
non calibrato

GYNÄKOLOGIE

GYNECOLOGY

GYNÉCOLOGIE

GINECOLOGÍA

GINECOLOGIA

Uterus-Sonden
Uterine Sounds
Hystéromètres
Histerómetros
Isterometri

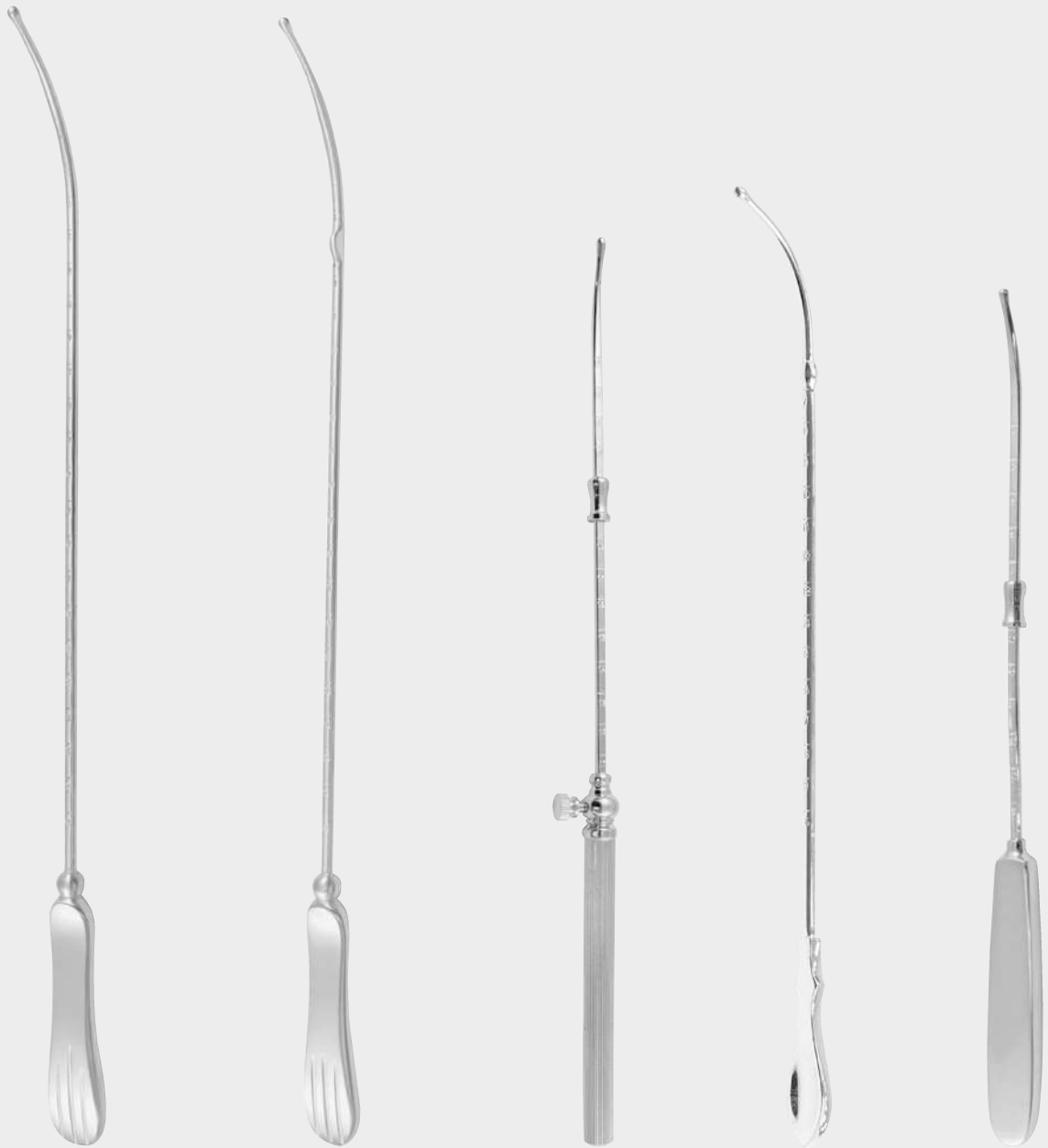

SIMS 33,0 cm
70-5800-32 * 70-5801-32 *

starr	biegsam
rigid	malleable
rigide	malleable
rigido	malleable
rigido	malleabile

MARTIN 30,0 cm
70-5802-32 * 70-5803-32 *

starr	biegsam
rigid	malleable
rigide	malleable
rigido	malleable
rigido	malleabile

cm COLLIN
28,0 70-5804-28 *

cm GALABIN
29,0 70-5805-29 *

biegsam
malleable
malleable
malleable
malleabile

cm VALLEIX
25,0 70-5806-25 *

starr
rigid
rigide
rigido
rigido

Uterus-Biopsieküretten
 Uterine Biopsy Curettes
 Curettes pour la biopsie utérine
 Curetas para la biopsia uterina
 Curette per la biopsia uterina

Uterus-Biopsieküretten
 Uterine Biopsy Curettes

GYNÄKOLOGIE

GYNECOLOGY

GINECOLOGIE

GINECOLOGÍA

GINECOLOGIA

Saug-Küretten - Aspirating Curettes
 Curettes à aspiration - Curetas de aspiración
 Curette per aspirazione



cm MÜNCHEN / 4 mm
 27,0 70-5890-04



cm BERLIN / 3,5 mm
 37,0 70-5892-35



cm RANDALL / 4 mm
 24,0 70-5900-04



mm NOVAK
 1 70-5902-01
 2 70-5902-02
 3 70-5902-03
 4 70-5902-04



KEVORKIAN 30,0 cm
 70-5904-12 1,2 mm
 70-5904-40 4,0 mm 70-5906-40

Mit Korb
 With Basket
 Avec grille
 Con cesto
 Con cestino



mm HEANEY
 7,5 70-5908-24
 24,0 cm



Uterus-Biopsieküretten
 Uterine Biopsy Curettes
 Curettes pour la biopsie utérine
 Curetas para la biopsia uterina
 Curette per la biopsia uterina

GYNÄKOLOGIE

GYNECOLOGY

GINECOLOGIE

GINECOLOGÍA

GINECOLOGIA

Probeexzisionszangen
 Uterine Biopsy Specimen Forceps
 Pinces emporte-pièce pour le col de l'utérus
 Pinzas sacabocado para el cuello del útero
 Pinze taglianti per biopsia uterina



mm Fig. 1
 5,0 70-5910-05



mm Fig. 2
 6,0 70-5910-06



mm Fig. 3
 7,0 70-5910-07



mm Fig. 4
 8,0 70-5910-08

cm KELLY GRAY
 24,0 70-5910-05 - 70-5910-08



cm MILAN
 28,0 70-5914-04 - 70-5914-09



mm Fig. 1
 4,0 70-5914-04



mm Fig. 2
 6,0 70-5914-06



mm Fig. 3
 9,0 70-5914-09



mm HEANEY
 7,5 70-5918-24
 24,0 cm

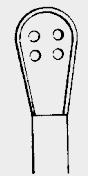

70-5930-08
 70-5931-08

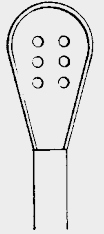

70-5930-11
 70-5931-11

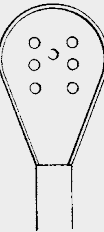

70-5930-14
 70-5931-14

RHEINSTAEDTER

70-5930-08	8,0 mm	70-5931-08
70-5930-11	11,0 mm	70-5931-11
70-5930-14	14,0 mm	70-5931-14

scharf	stumpf
sharp	blunt
trachantes	mousses
cortantes	romas
taglienti	smusse



cm FAURE
 21,0 70-6001-21



cm SCHUBERT
 21,0 70-6004-21
 28,0 70-6004-28

Probeexzisionszangen
 Uterine Biopsy Specimen Forceps
 Pinces emporte-pièce pour le col de l'utérus
 Pinzas sacabocado para el cuello del útero
 Pinze taglianti per biopsia uterina



cm van DOREN mm
 25,0 70-6101-25 4,9

cm THOMS-GAYLOR
 21,0 70-6006-21
 24,0 70-6006-24

cm SCHUBERT
 26,0 70-6005-26

cm GELLHORN
 23,0 70-6009-23

cm van DOREN mm
 27,0 70-6101-27 5,5

GYŃAKOLOGIE

GYNECOLOGY

GINECOLOGIE

GINECOLOGÍA

GINECOLOGIA



cm ALEXANDER
 28,0 70-6103-28

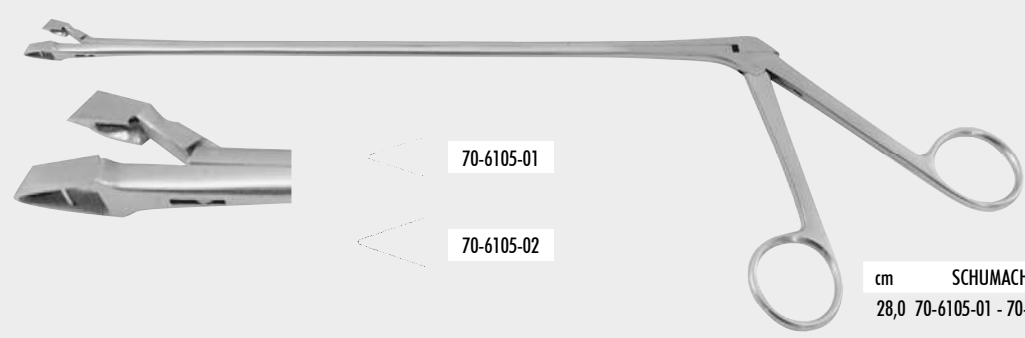

70-6105-01

70-6105-02

cm SCHUMACHER
 28,0 70-6105-01 - 70-6105-02

Probeexzisionszangen
 Uterine Biopsy Specimen Forceps
 Pincas emporte-pièce pour le col de l'utérus
 Pinzas sacabocado para el cuello del útero
 Pinze taglianti per biopsia uterina



3 x 9,7 mm

cm KEVORKIAN (YOUNGE)
 24,5 70-6107-04

GYNÄKOLOGIE



4 x 8 mm

cm WITTNER
 23,0 70-6108-23 70-6109-23

GYNECOLOGY

GYNÉCOLOGIE

GINECOLOGÍA

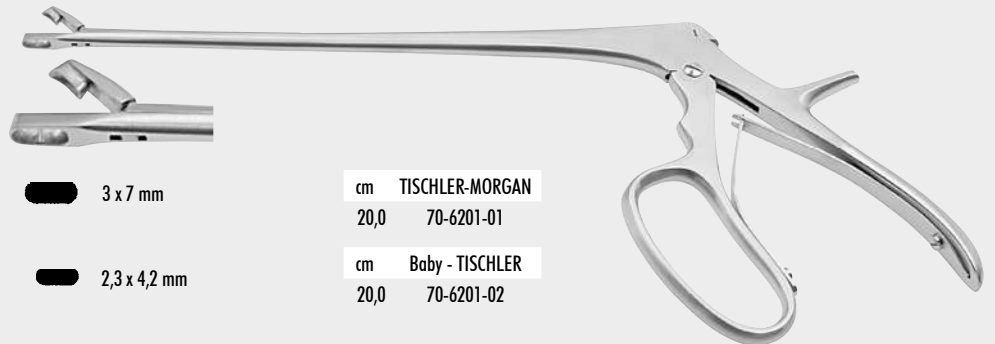

3 x 7 mm

cm TISCHLER-MORGAN
 20,0 70-6201-01

2,3 x 4,2 mm

cm Baby - TISCHLER
 20,0 70-6201-02

GINECOLOGIA

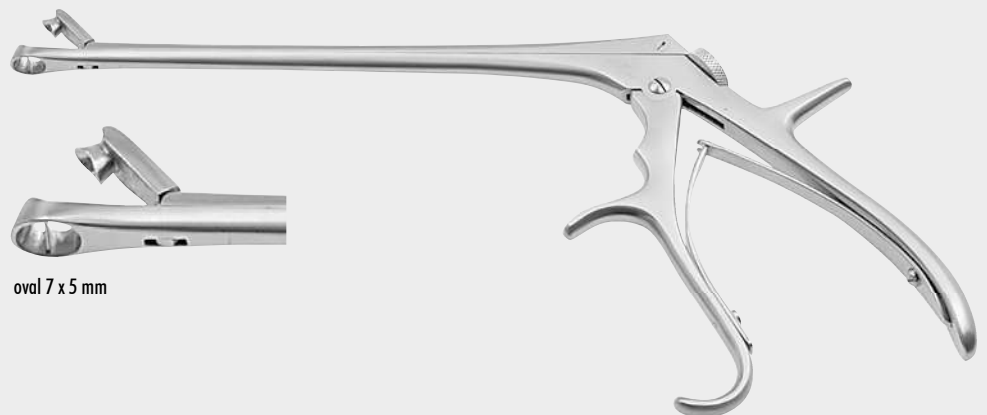

oval 7 x 5 mm

BURKE
 70-6202-00



3 x 7 mm

Fig. 1



2,3 x 4,2 mm

Fig. 2



oval

3,7 x 5 mm

Fig. 3



3 x 8 mm

Fig. 4

70-6204-99

Fig.	TOWNSEND	
1	70-6204-01	70-6204-11
2	70-6204-02	70-6204-12
3	70-6204-03	70-6204-13
4	70-6204-04	70-6204-14

Instr. komplett	Aufsatz allein
Compl. Instr.	Tip only
Instr. complet	Embout seul
Instr. completo	Punta suelta
Strum. compl.	Punta sola

Probeexzisionszangen
 Uterine Biopsy Specimen Forceps
 Pinces emporte-pièce pour le col de l'utérus
 Pinzas sacabocado para el cuello del útero
 Pinze taglianti per biopsia uterina

GYNÄKOLOGIE

GYNECOLOGY

GYNÉCOLOGIE

GINECOLOGÍA

GINECOLOGIA



KEVORKIAN-Pacific
 70-6205-04



2,3 x 4,2 mm

TOWNSEND-Mini (BABY TISCHLER)
 70-6206-00

ZEPF®

 INSTRUMENTS

Probeexzisionszangen
 Uterine Biopsy Specimen Forceps
 Pinces emporte-pièce pour le col de l'utérus
 Pinzas sacabocado para el cuello del útero
 Pinze taglianti per biopsia uterina

GYNÄKOLOGIE

GYNECOLOGY

GYNÉCOLOGIE

GINECOLOGÍA

GINECOLOGIA

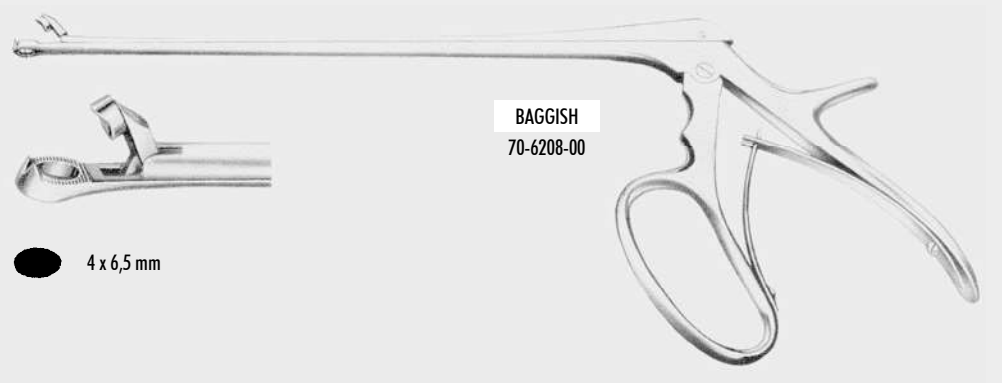

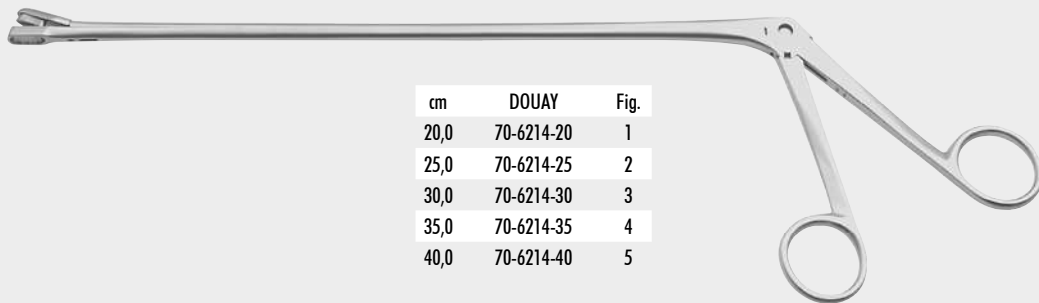

cm	DOUAY	Fig.
20,0	70-6214-20	1
25,0	70-6214-25	2
30,0	70-6214-30	3
35,0	70-6214-35	4
40,0	70-6214-40	5

Probeexzisionszangen
 Uterine Biopsy Specimen Forceps
 Pinces emporte-pièce pour le col de l'utérus
 Pinzas sacabocado para el cuello del útero
 Pinze taglienti per biopsia uterina



EPPENDORFER
 70-6300-00

4,5 x 8 mm

GYNÄKOLOGIE

GYNECOLOGY

GINECOLOGIE

GINECOLOGÍA

GINECOLOGIA

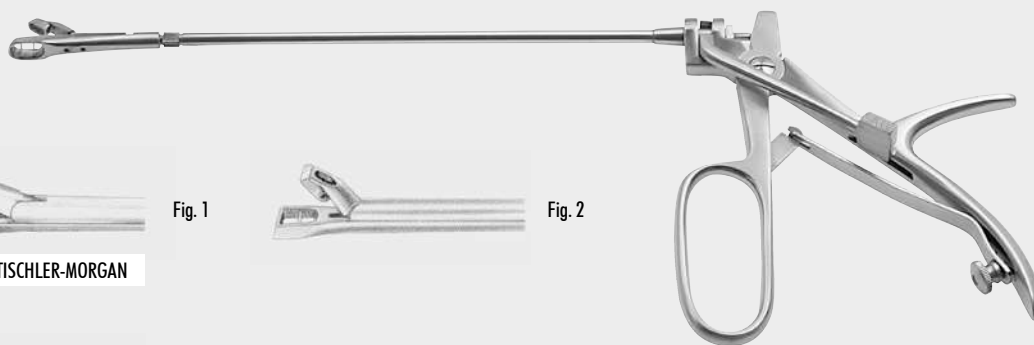

Fig. 1



Fig. 2

TISCHLER-MORGAN



Fig. 3



Fig. 4

Instrument komplett
 Complete Instrument
 Instrument complet
 Instrumento completo
 Strumento completo

	Fig.	
70-6302-01	1	70-6302-11
70-6302-02	2	70-6302-12
70-6302-03	3	70-6302-13
70-6302-04	4	70-6302-14

Aufsatz allein
 Tip only
 Embout seul
 Punta suelta
 Punta sola

Myomheber, Fistelhaken
 Myoma Screws, Fistula Hooks
 Tracteurs de fibromes, Crochets fistulaires
 Tirabuzones para fibromas, Ganchos fistulares
 Tiramiomi, Uncini fistolari

GYNÄKOLOGIE

GYNECOLOGY

GINECOLOGIE

GINECOLOGÍA

GINECOLOGIA

Fistelhaken, Myom-, Konisationsmesser
 Fistula Hooks, Myoma and Conization Knives
 Crochets fistulaires, couteaux à fibromes et à conization
 Ganchos fistulares, Bisturías para fibromas y de conización
 Uncini fistolari, Bisturi per fibromi e per il cono d'attrazione

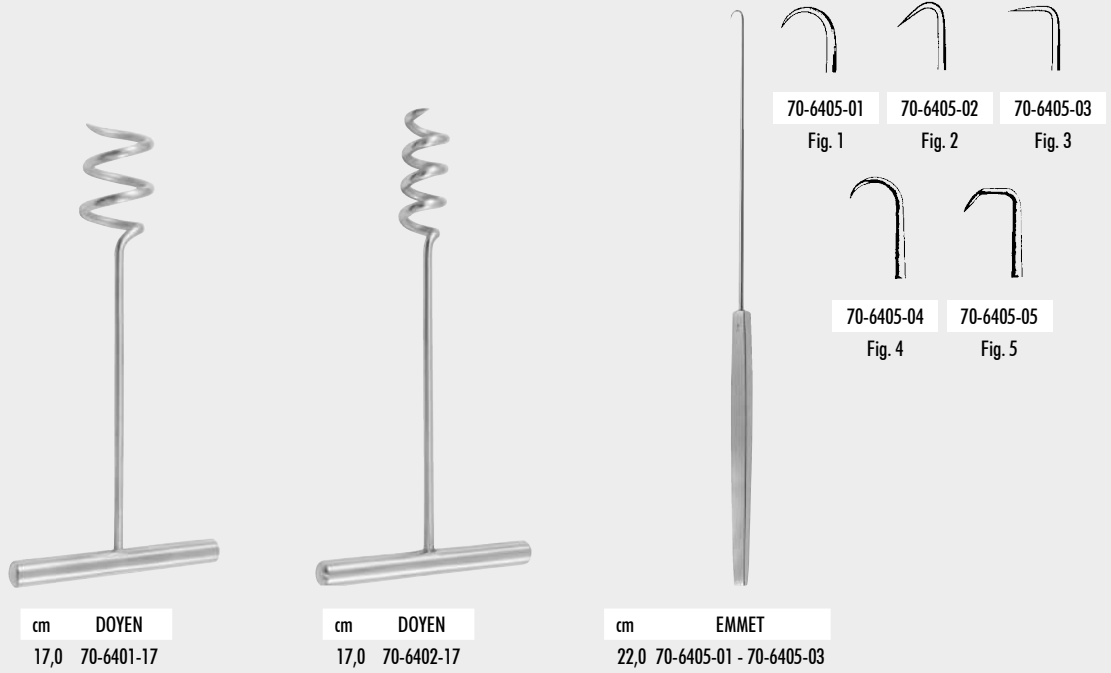

cm DOYEN
 17,0 70-6401-17

cm DOYEN
 17,0 70-6402-17

cm EMMET
 22,0 70-6405-01 - 70-6405-03

Myom-Heber - Myoma Screws - Tracteurs pour fibromes -
 Tirabuzones para fibromas - Tiramiomi

Fistelhaken
 Fistula Hooks
 Crochets à fistules
 Ganchos para fistulas
 Uncini per fistole

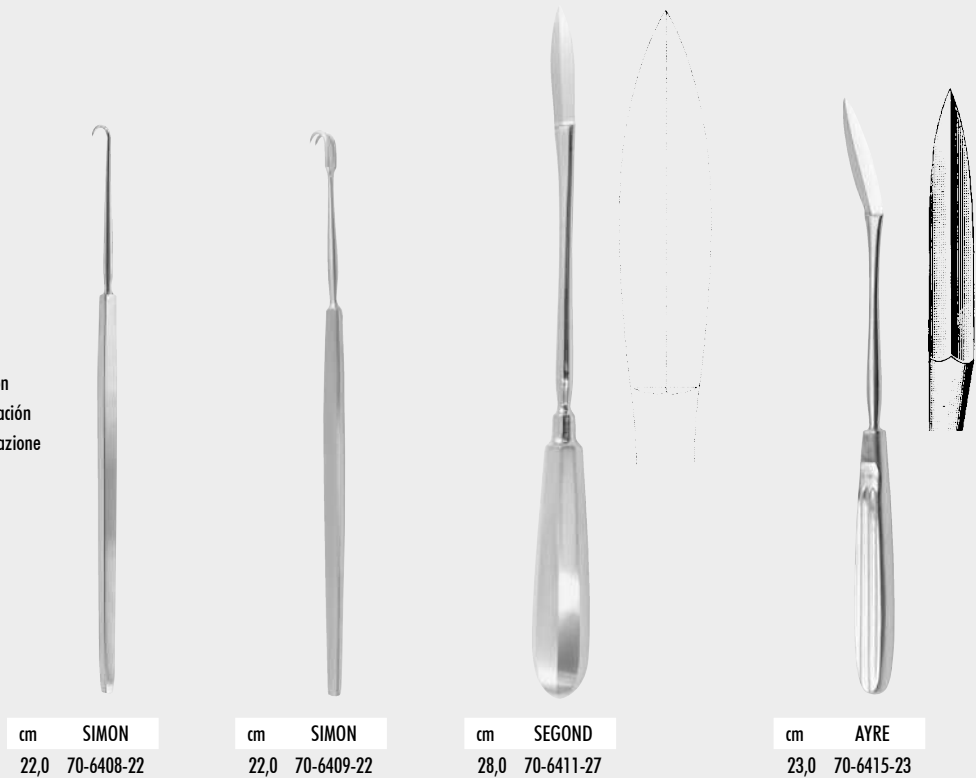

cm SIMON
 22,0 70-6408-22

cm SIMON
 22,0 70-6409-22

cm SEGOND
 28,0 70-6411-27

cm AYRE
 23,0 70-6415-23

Salpingograph
Salpingograph
Salpingographe
Salpingógrafo
Salpingografo

GYŃAKOLOGIE

GYNECOLOGY

GINECOLOGIE

GINECOLOGÍA

GINECOLOGIA

Intrauterin-Kanülen, Schleimhautabsauger
Intra Uterine Cannulas, Mucus Evacuator
Canules intra-utérines, Évacuateur de muqueuse
Cánulas intra uterinas, Evacuador de mucosa
Cannule intrauterine, Evacuatore di mucosa

ZEPF®
α
INSTRUMENTS

70-6600-16

70.35

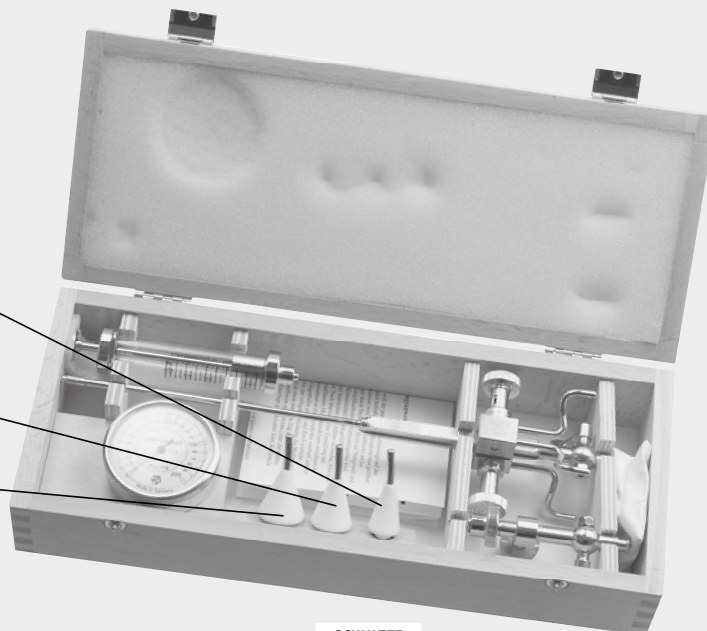

70-6500-11

70-6500-12

70-6500-13

SCHULTZE

70-6500-00

compl.



70-6600-10

10 x 25 mm

ø x L



70-6600-13

13 x 30 mm

ø x L



70-6600-16

16 x 30 mm

ø x L



cm LEECH-WILKINSON

27,0 70-6600-10 - 70-6600-16

Salpingograph
 Salpingograph
 Salpingographe
 Salpingógrafo
 Salpingografo

GYNÄKOLOGIE

GYNECOLOGY

GYNÉCOLOGIE

GINECOLOGÍA

GINECOLOGIA

Intrauterin-Kanülen, Schleimhautabsauger
 Intra Uterine Cannulas, Mucus Evacuator
 Canules intra-utérines, Évacuateur de muqueuse
 Cánulas intra uterinas, Evacuador de mucosa
 Cannule intrauterine, Evacuatore di mucosa



cm PROVIS
 28,0 70-6601-28



cm SPACKMAN
 36,0 70-6602-36



ø mm ROTUNDA 20,0 cm
 5,0 70-6604-20



cm CARTON
 23,0 70-6615-23

Uteruslöffel, -kürette
 Uterine Curettes
 Curettes utérines
 Curetas uterinas
 Curette uterine

GYNÄKOLOGIE

GYNECOLOGY

GINECOLOGIE

GINECOLOGÍA

GINECOLOGIA



Fig. 1
6,0 mm



Fig. 2
8,0 mm



Fig. 3
10,0 mm



Fig. 4
12,0 mm

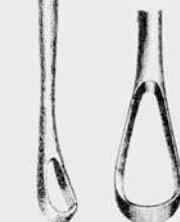
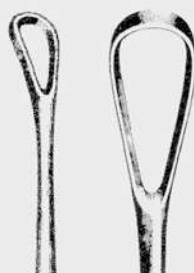

Fig. 5
14,0 mm



stumpf
blunt
mousse
roma
smussa

scharf / stumpf
sharp / blunt
tranchant / mousse
cortante / roma
tagliente / smussa



cm BLAKE
27,0 70-7004-27



Fig. 1



Fig. 2



Fig. 3



Fig. 4



Fig. 5



Fig. 6

Fig. SCHRÖDER 31,0 cm
 1 70-7003-01
 2 70-7003-02
 3 70-7003-03
 4 70-7003-04
 5 70-7003-05
 6 70-7003-06



Fig. SIMON 25,0 cm
 1 70-7002-01
 2 70-7002-02
 3 70-7002-03
 4 70-7002-04
 5 70-7002-05
 6 70-7002-06



scharf
sharp
tranchant
cortante
tagliente

Uterus-Küretten
Uterine Curettes
Curettes utérines
Curetas uterinas
Curette uterine

GYNÄKOLOGIE

GYNECOLOGY

GYNÉCOLOGIE

GINECOLOGÍA

GINECOLOGIA

Ausführung	scharf	stumpf
Features	sharp	blunt
Exécution	tranchante	mousse
Ejecución	cortante	roma
Esecuzione	tagliente	smussa
fest / rig.	A	B
flex. / fless.	C	D

Einkerbung im Schaft
Grooved Shaft
Tige avec entaille
Asta con entalladura
Gambo con intaglio



Biegsame Kürette
Malleable curette
Curette malléable
Cureta maleable
Curetta malleabile

Ohne Einkerbung
Plain Shaft
Tige sans entaille
Asta sin entalladura
Gambo senza intaglio



Starre Kürette
Rigid curette
Curette rigide
Cureta rígida
Curetta rigida



cm SIMS
28,0 70-7100-05 - 70-7107-14

cm RECAMIER
31,0 70-7200-05 - 70-7207-25

cm BUMM
34,0 70-7300-30 - 70-7307-40

Fig.	A	B	C	D	A	B	C	D	A	B	C	D
00	70-7100-05	70-7102-05	70-7105-05	70-7107-05	70-7200-05	70-7202-05	70-7205-05	70-7207-05				
0	70-7100-06	70-7102-06	70-7105-06	70-7107-06	70-7200-06	70-7202-06	70-7205-06	70-7207-06				
1	70-7100-07	70-7102-07	70-7105-07	70-7107-07	70-7200-07	70-7202-07	70-7205-07	70-7207-07				
2	70-7100-08	70-7102-08	70-7105-08	70-7107-08	70-7200-08	70-7202-08	70-7205-08	70-7207-08				
3	70-7100-09	70-7102-09	70-7105-09	70-7107-09	70-7200-09	70-7202-09	70-7205-09	70-7207-09				
4	70-7100-11	70-7102-11	70-7105-11	70-7107-11	70-7200-11	70-7202-11	70-7205-11	70-7207-11				
5	70-7100-12	70-7102-12	70-7105-12	70-7107-12	70-7200-12	70-7202-12	70-7205-12	70-7207-12				
6	70-7100-14	70-7102-14	70-7105-14	70-7107-14	70-7200-14	70-7202-14	70-7205-14	70-7207-14				
7					70-7200-15	70-7202-15	70-7205-15	70-7207-15				
8					70-7200-16	70-7202-16	70-7205-16	70-7207-16				
9					70-7200-19	70-7202-19	70-7205-19	70-7207-19				
10					70-7200-20	70-7202-20	70-7205-20	70-7207-20				
11					70-7200-21	70-7202-21	70-7205-21	70-7207-21				
12					70-7200-23	70-7202-23	70-7205-23	70-7207-23				
13					70-7200-25	70-7202-25	70-7205-25	70-7207-25				
14									70-7300-30	70-7302-30	70-7305-30	70-7307-30
15									70-7300-35	70-7302-35	70-7305-35	70-7307-35
16									70-7300-40	70-7302-40	70-7305-40	70-7307-40

Uterus-Küretten
 Uterine Curettes
 Curettes utérines
 Curetas uterinas
 Curette uterine

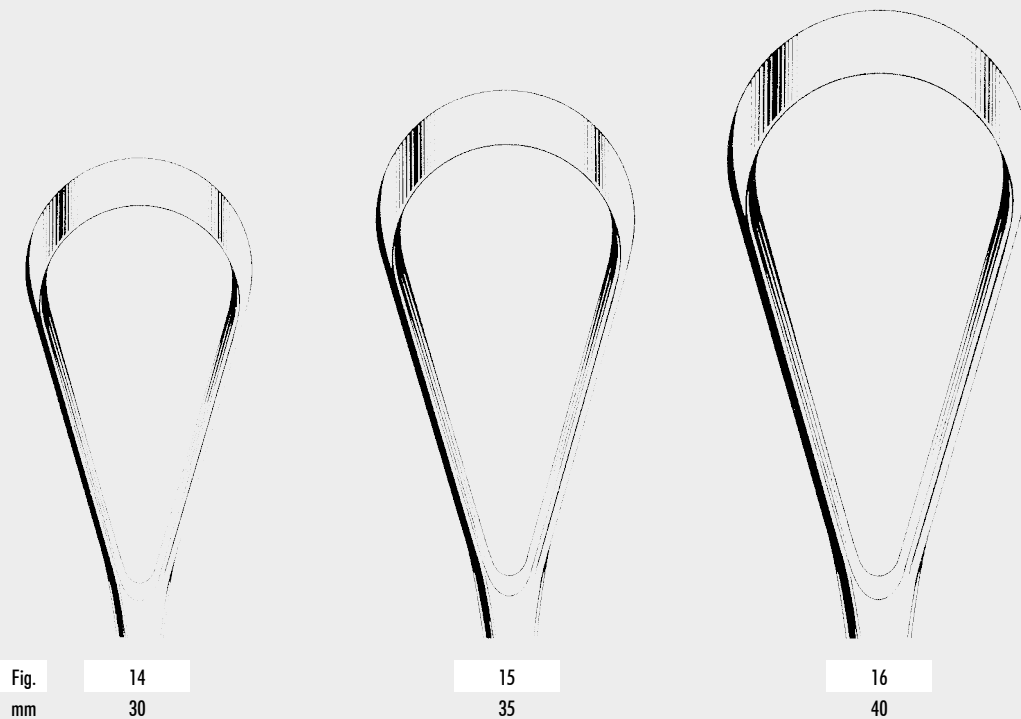
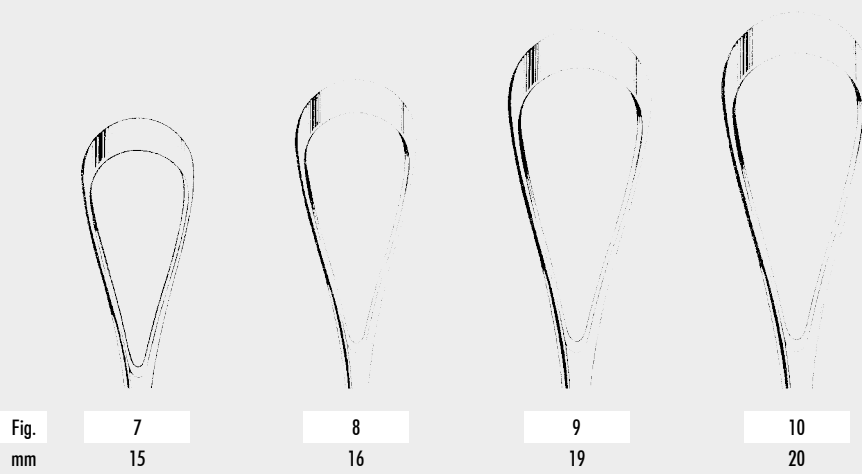
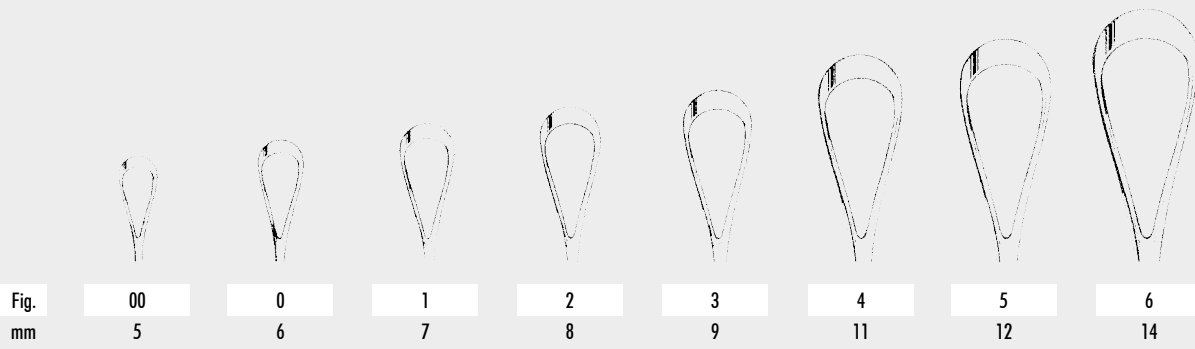

GYŃÄKOLOGIE

GYNECOLOGY

GINECOLOGIE

GINECOLOGÍA

GINECOLOGIA

Uterus-Küretten
 Uterine Curettes
 Curettes utérines
 Curetas uterinas
 Curette utérine

Ausführung	scharf	stumpf
Features	sharp	blunt
Exécution	tranchante	mousse
Ejecución	cortante	roma
Esecuzione	tagliante	smussa
fest / rig.	A	B
flex. / fless.	C	D

GYNÄKOLOGIE

GYNECOLOGY

GYNÉCOLOGIE

GINECOLOGÍA

GINECOLOGIA



cm RECAMIER OLSHAUSEN
 28,0 70-7350-05 - 70-7380-18



cm HORROCK
 26,0 70-7400-26

mm	A	C	B	D
5	70-7350-05	70-7360-05	70-7370-05	70-7380-05
7	70-7350-07	70-7360-07	70-7370-07	70-7380-07
8	70-7350-08	70-7360-08	70-7370-08	70-7380-08
10	70-7350-10	70-7360-10	70-7370-10	70-7380-10
12	70-7350-12	70-7360-12	70-7370-12	70-7380-12
15	70-7350-15	70-7360-15	70-7370-15	70-7380-15
18	70-7350-18	70-7360-18	70-7370-18	70-7380-18

Uterus-Küretten
 Uterine Curettes
 Curettes utérines
 Curetas uterinas
 Curette uterine

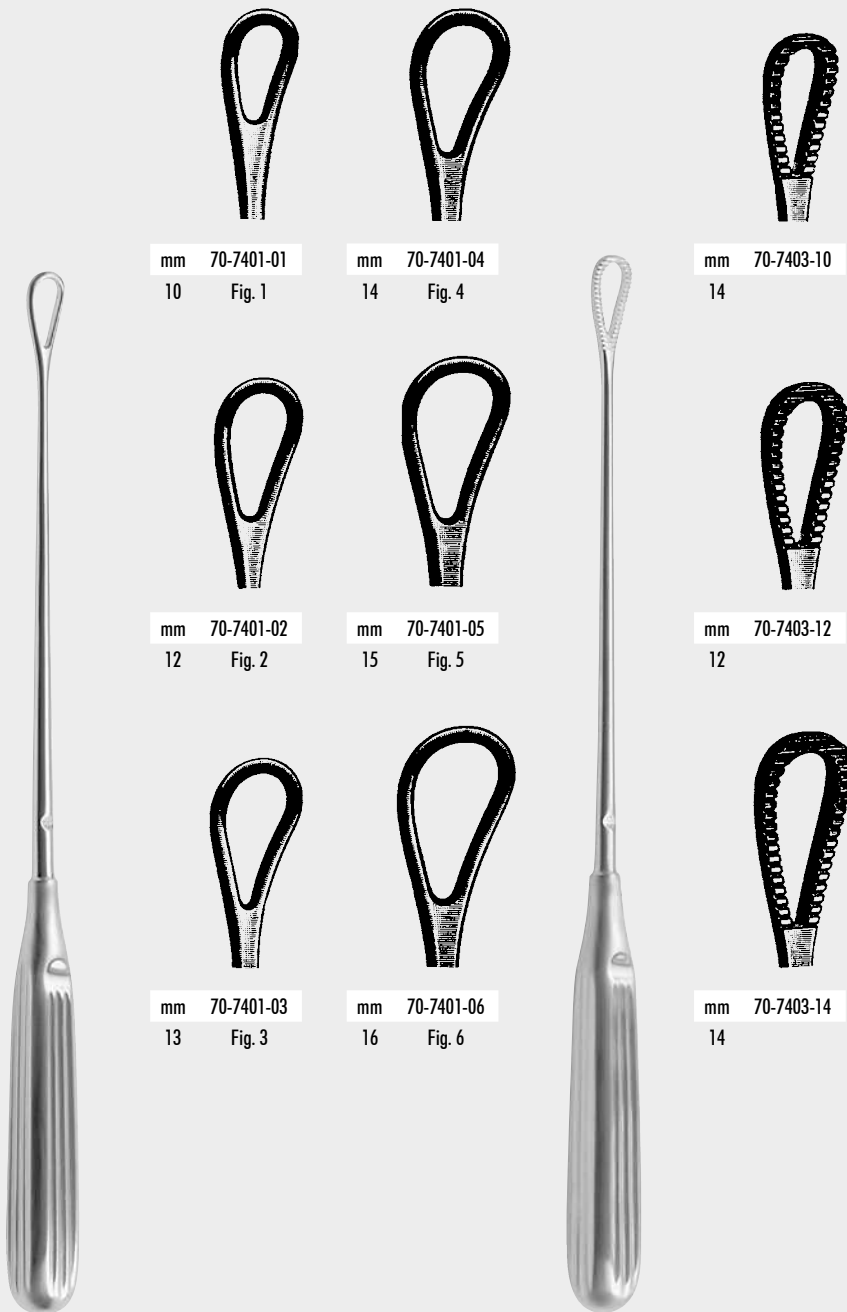

mm 70-7401-01
 10 Fig. 1

mm 70-7401-04
 14 Fig. 4

mm 70-7403-10
 14

mm 70-7401-02
 12 Fig. 2

mm 70-7401-05
 15 Fig. 5

mm 70-7403-12
 12

mm 70-7401-03
 13 Fig. 3

mm 70-7401-06
 16 Fig. 6

mm 70-7403-14
 14

cm THOMAS
 28,0 70-7401-01 - 70-7401-06

cm GREENE
 28,0 70-7403-10 - 70-7403-14

biegsam · malleable · malléables · maleables · malleabili

biegsam · malleable · malléables · maleables · malleabili

GYNÄKOLOGIE

GYNECOLOGY

GINECOLOGIE

GINECOLOGÍA

GINECOLOGIA

Uterus-Küretten
 Uterine Curettes
 Curettes utérines
 Curetas uterinas
 Curette uterine

GYNÄKOLOGIE

GYNECOLOGY

GINECOLOGIE

GINECOLOGÍA

GINECOLOGIA

Uterus-Spülkatheter
 Uterine flushing tube
 Sonde à lavage utérin
 Sonda de lavado uterino
 Sonda di lavaggio uterino



mm 70-7410-08
8



mm 70-7410-12
12



mm 70-7410-10
10



mm 70-7410-14
14

cm COLLIN
28,0 70-7410-08 - 70-7410-14
starr · rigid · rigides · rígidas · rigide



mm BOZEMANN FRITSCH
8 70-7425-08
10 70-7425-10
12 70-7425-12
35,0 cm

Probe- und Absaugküretten
Specimen and Aspirating Curettes
Curettes à épreuves et d'aspiration
Curetas de biopsia y de aspiración
Curette per biopsia e d'aspirazione

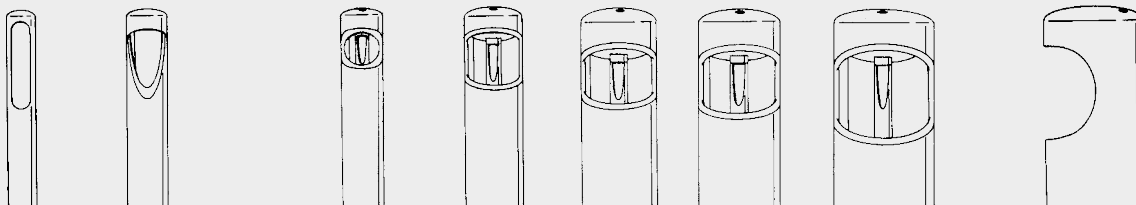

70-7450-03
ø 3 mm
29,0 cm

70-7450-04
ø 4 mm
29,0 cm

70-7450-06
ø 6 mm
29,0 cm

70-7450-08
ø 8 mm
29,0 cm

70-7450-10
ø 10 mm
29,0 cm

70-7450-12
ø 12 mm
29,0 cm

70-7450-14
ø 14 mm
29,0 cm

70-7450-99

Probe- und Absaugküretten
Specimen and Aspirating Curettes
Curettes à épreuves et d'aspiration
Curetas de biopsia y de aspiración
Curette per biopsia e d'aspirazione

Absaugküretten
Aspirating Curettes
Curettes d'aspiration
Curetas de aspiración
Curette d'aspirazione

Kupplungsstück
Hose Connection
Pièce de raccordement
Pieza de conexión
Pezzo di raccordo

GYNÄKOLOGIE

GYNECOLOGY

GYNÉCOLOGIE

GINECOLOGÍA

GINECOLOGIA



GYNÄKOLOGIE

GYNECOLOGY

GYNÉCOLOGIE

GINECOLOGÍA

GINECOLOGIA