

KORN-, TUPFER- UND SCHWAMMZANGEN

SPONGE AND DRESSING FORCEPS

PINCES À PANSEMENT ET À ÉPONGES

PINZAS PARA TAPONES Y ESPONJAS

PINZE PER MEDICATURA, PER TAMPONI E SPUGNE

Tupferzangen
Dressing Forceps
Pincas à pansements
Pinzas para tapones
Pinze per medicatura

KORN-, TUPFER- UND
SCHWAMMZANGEN

SPONGE AND
DRESSING FORCEPS

PINCES À PANSEMENT
ET À ÉPONGES

PINZAS PARA
TAPONES Y ESPONJAS

PINZE PER MEDICATURA,
PER TAMPONI E SPUGNE



cm	—	GROSS MAIER	—
20,0	16-1100-20		16-1101-20
22,0	16-1100-22		16-1101-22
26,5	16-1100-26		16-1101-26
27,5	16-1100-27		16-1101-27



cm	—	GROSS MAIER	—
20,0	16-1106-20		16-1107-20
26,5	16-1106-26		16-1107-26



cm	—	GROSS MAIER	—
13,0	16-1120-13		16-1121-13
15,0	16-1120-14		16-1121-14
18,0	16-1120-18		16-1121-18
20,0	16-1120-20		16-1121-20
25,0	16-1120-25		16-1121-25



cm	GROSS MAIER	—
20,0	16-1124-20	
25,0	16-1124-25	



cm	GROSS MAIER	—
20,0	16-1125-20	
25,0	16-1125-25	



cm	—	GROSS	—
14,0	16-1126-14		16-1127-14

Tupferzangen
Dressing Forceps
Pincès à pansements
Pinzas para tapones
Pinze per medicatura

KORN-, TUPFER- UND
SCHWAMMZANGEN

SPONGE AND
DRESSING FORCEPS

PINCES À PANSEMENT
ET À ÉPONGES

PINZAS PARA
TAPONES Y ESPONJAS

PINZE PER MEDICATURA,
PER TAMPONI E SPUGNE

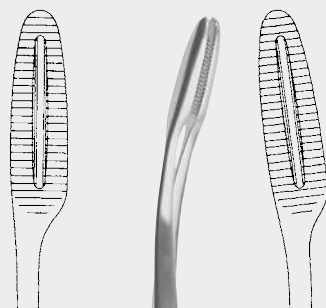

cm		SIMS-MAIER	
28,0	16-1130-28		16-1131-28

cm	MAIER
25,0	16-1134-25



cm		ULRICH	
18,0	16-1600-18		16-1601-18
22,0	16-1600-22		16-1601-22
26,5	16-1600-26		16-1601-26
35,0	16-1600-35		16-1601-35

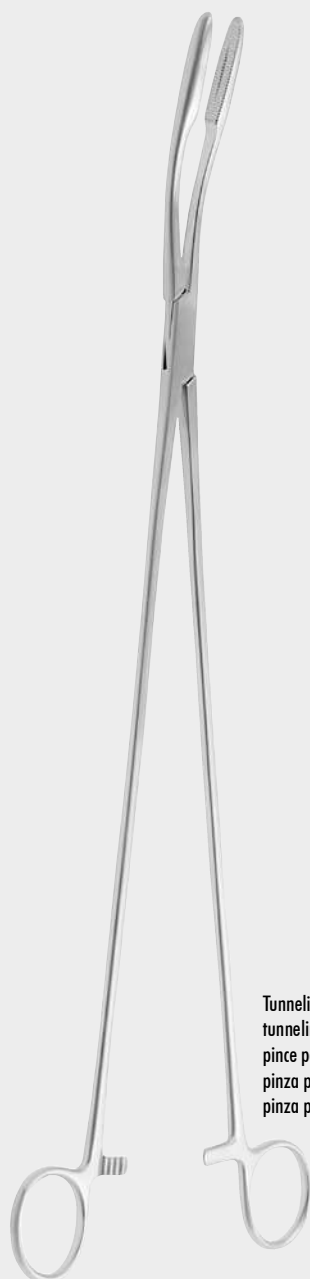

Tunnelier Kornzange
tunneling forceps
pince pour tunnelisation
pinza para tunelar
pinza per tunelare

cm	
39,5	16-1141-39



Schwammzangen
Sponge Holding Forceps
Pincas porte-éponges
Pinzas porta esponjas
Pinze per tamponi e spugne

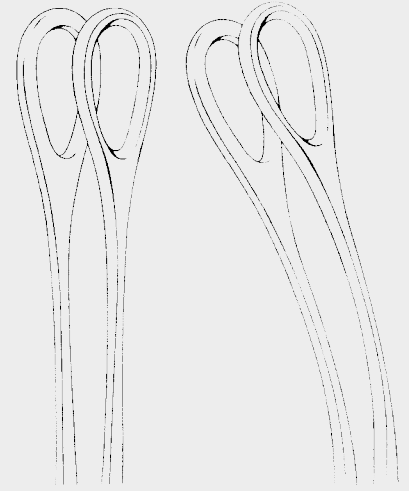
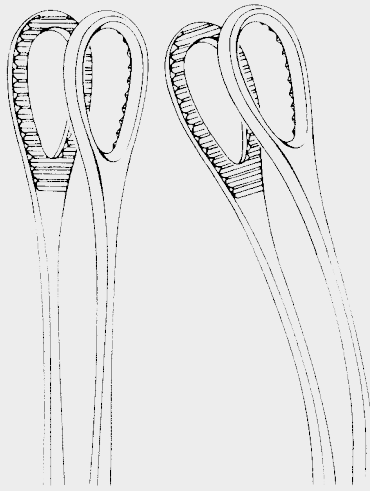
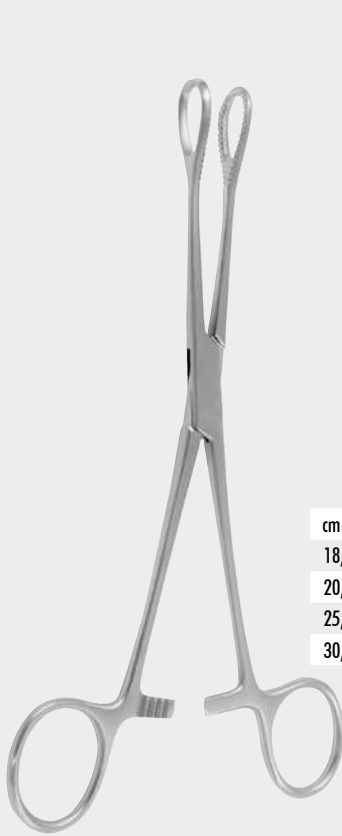

cm	—	BALLENGER (FÖRSTER)	—
18,0	16-1700-18		16-1701-18
20,0	16-1700-20		16-1701-20
25,0	16-1700-25		16-1701-25
30,0	16-1700-30		

cm	—
18,0	16-1702-18
20,0	16-1702-20
25,0	16-1702-25

cm	—
18,0	16-1703-18
20,0	16-1703-20
25,0	16-1703-25

KORN-, TUPFER- UND SCHWAMMZANGEN

SPONGE AND DRESSING FORCEPS

PINCES À PANSEMENT ET À ÉPONGES

PINZAS PARA TAPONES Y ESPONJAS

PINZE PER MEDICATURA, PER TAMPONI E SPUGNE

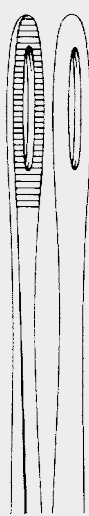

cm —
25,0 16-1704-25

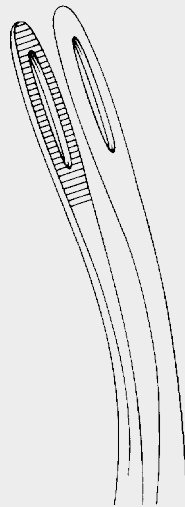

cm —
25,0 16-1705-25



FOERSTER
16-1704-25 - 16-1705-25



cm BONNEY
24,0 16-1706-24

Schwammzangen
Sponge Holding Forceps
Pincas porte-éponges
Pinzas porta esponjas
Pinze per tamponi e spugne

KORN-, TUPFER- UND
SCHWAMMZANGEN

SPONGE AND
DRESSING FORCEPS

PINCES À PANSEMENT
ET À ÉPONGES

PINZAS PARA
TAPONES Y ESPONJAS

PINZE PER MEDICATURA,
PER TAMPONI E SPUGNE



cm	RAMPLEY modif.
18,0	16-1708-18
25,0	16-1708-25



cm	VANT
26,5	16-1711-26



Schwammzangen
Sponge Holding Forceps
Pincès porte-éponges
Pinzas porta esponjas
Pinze per tamponi e spugne

KORN-, TUPFER- UND
SCHWAMMZANGEN

SPONGE AND
DRESSING FORCEPS

PINCES À PANSEMENT
ET À ÉPONGES

PINZAS PARA
TAPONES Y ESPONJAS

PINZE PER MEDICATURA,
PER TAMPONI E SPUGNE



cm RAMPLEY
25,0 16-1800-25



cm FLETCHER (JAVERTS)
25,0 16-1802-25 16-1803-25



cm BRYANT
13,0 16-2007-13



cm LISTER (Sinus)
13,0 16-2100-13
16,0 16-2100-16
18,0 16-2100-18



cm
24,0 16-2150-24 16-2151-24

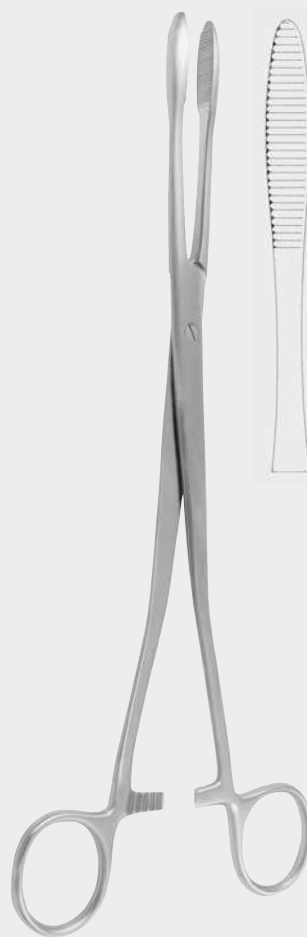

cm COLLIN
25,0 16-2200-25



cm PELKMANN
25,0 16-2206-25 16-2207-25

Korn- und Tupferzangen
 Sponge and Dressing Forceps
 Pincès porte-éponges
 Pinzas para tapones
 Pinze per tamponi

KORN-, TUPFER- UND
 SCHWAMMZANGEN

SPONGE AND
 DRESSING FORCEPS

PINCÈS À PANSEMENT
 ET À ÉPONGES

PINZAS PARA
 TAPONES Y ESPONJAS

PINZE PER MEDICATURA,
 PER TAMPONI E SPUGNE

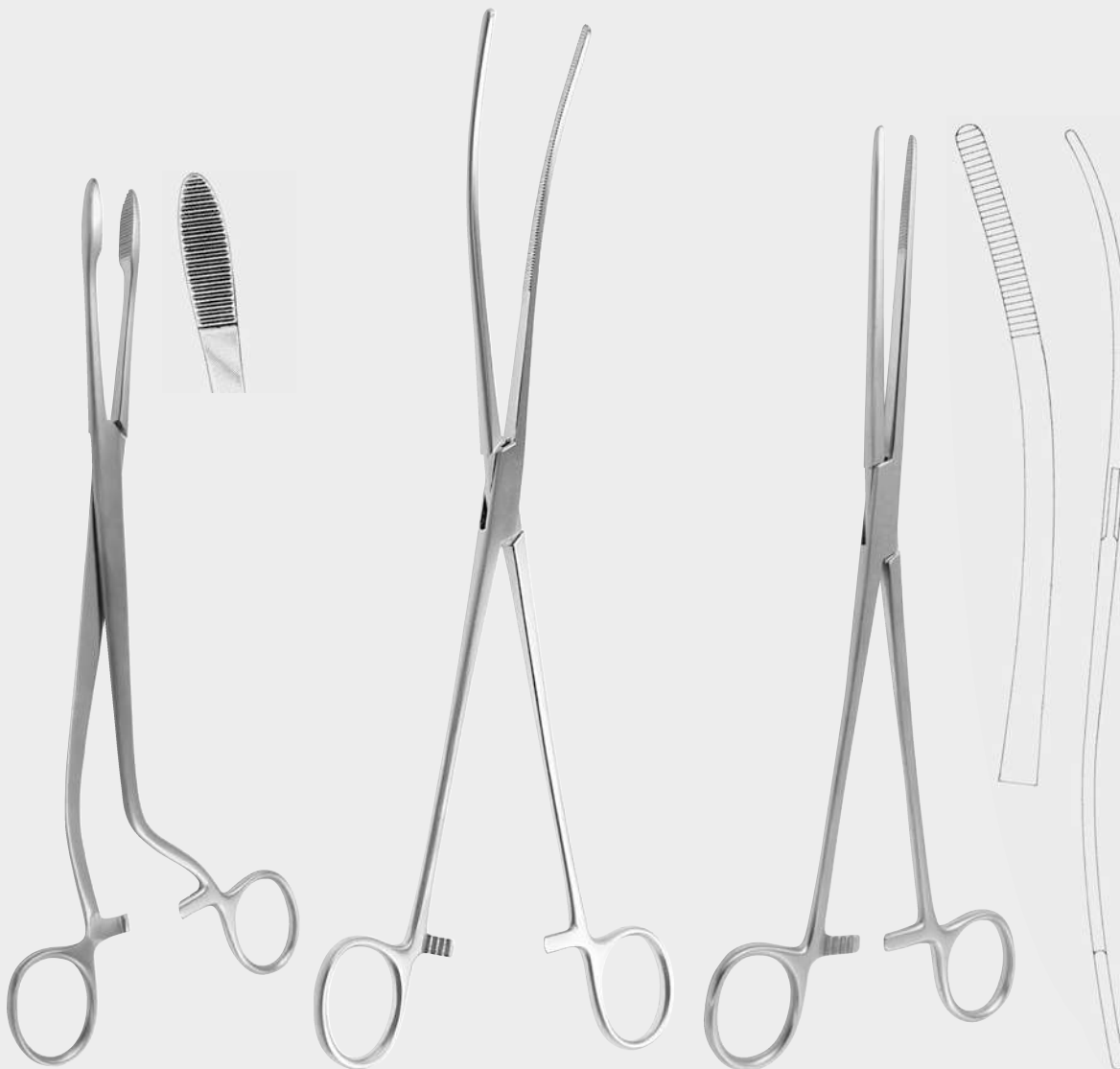

cm **CHERON**
 25,0 16-2209-25

cm **BLUMENTHAL**
 29,0 16-2291-29

cm **BOZEMANN**
 26,0 16-2300-26

16-2301-26
 S-förmig
 S-shape
 forma S
 courbé en S
 curve in forma S

Korn- und Tupferzangen
 Sponge and Dressing Forceps
 Pinces porte-éponges
 Pinzas para tapones
 Pinze per tamponi

KORN-, TUPFER- UND
 SCHWAMMZANGEN

SPONGE AND
 DRESSING FORCEPS

PINCES À PANSEMENT
 ET À ÉPONGES

PINZAS PARA
 TAPONES Y ESPONJAS

PINZE PER MEDICATURA,
 PER TAMPONI E SPUGNE



cm **BOZEMANN-DOUGLAS**
 26,0 16-2303-26

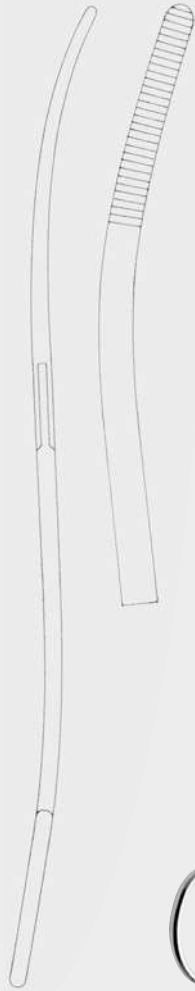

cm **EMMET**
 22,5 16-2310-22



cm **WESTERMARK**
 23,0 16-2320-23



cm **MARTIN**
 17,0 16-2404-17 16-2405-17
 17,0 16-2404-25 16-2405-25



cm **DUPLAY**
 20,0 16-2406-20 16-2407-20

WUNDHAKEN, WUNDSPERRER

RETRACTORS

ÉCARTEURS

SEPARADORES

DIVARICATORI

Wundhaken
Retractors
Écarteurs
Separadores
Divaricatori

WUNDHAKEN
WUNDSPERRER

RETRACTORS

ÉCARTEURS

SEPARADORES

DIVARICATORI

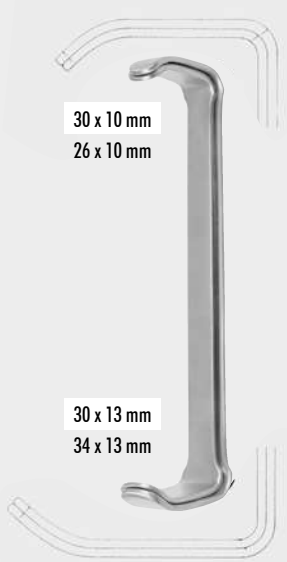

cm FARABEU 12,0
18-1002-12

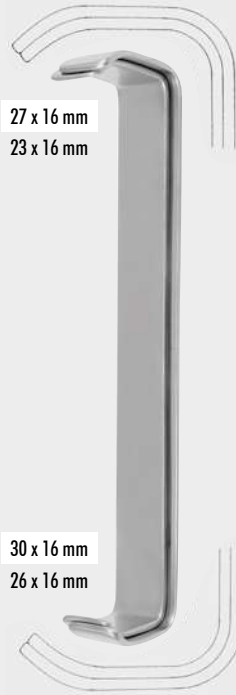

cm FARABEU 15,0
18-1002-15



cm PARKER 13,5
18-1100-13

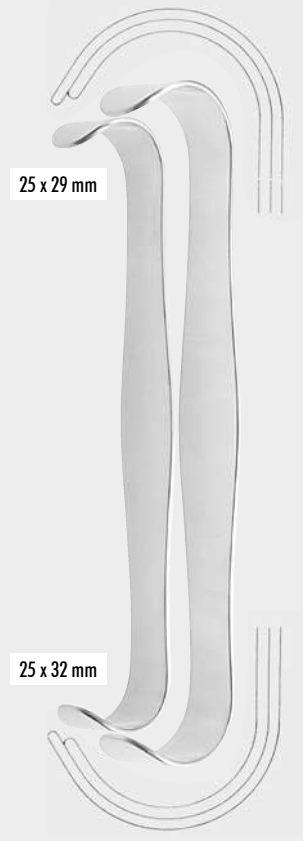

cm PARKER 18,0
18-1100-18

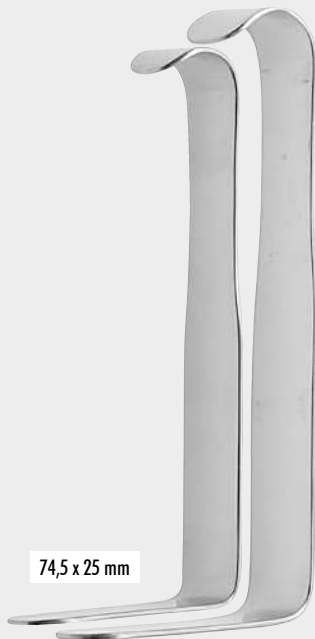

cm PARKER MOTT 16,0
18-1101-18



cm MAYO COLLIN 15,0
18-1102-15



cm COLLIN 16,5
18-1120-16



ROUX compl.
18-1200-00
Set Fig. 1-3

- Fig. 1 24 x 20 mm
- Fig. 2 29 x 26 mm
- Fig. 3 35 x 29 mm
- Fig. 4 27 x 24 mm
- Fig. 1 30 x 28 mm
- Fig. 2 36 x 36 mm
- Fig. 3 38 x 43 mm
- Fig. 4 42 x 28 mm



cm	ROUX	Fig.
14,0	18-1200-14	1
15,0	18-1200-15	2
17,0	18-1200-17	3
18,0	18-1200-18	4



Fig.	mm	ROUX MAGNUS
1	25 x 28/20 x 22	18-1201-01
2	29 x 38/23 x 26	18-1201-02
3	34 x 44/29 x 29	18-1201-03

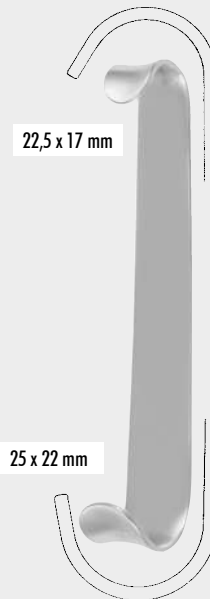

cm	ROUX Baby
13,0	18-1202-13

Wundhaken
Retractors
Écarteurs
Separadores
Divaricatori

WUNDHAKEN
WUNDSPERRER

RETRACTORS

ÉCARTEURS

SEPARADORES

DIVARICATORI



10 x 6 mm
11 x 8 mm
cm ROUX mini
15,0 18-1204-15



Fig.	mm	KILNER 15,0 cm
1	30 x 19/33 x 25	18-1206-01
2	35 x 29/40 x 35	18-1206-02



cm CRILE
11,5 18-1207-11
mm 7 x 7 / 4 x 5

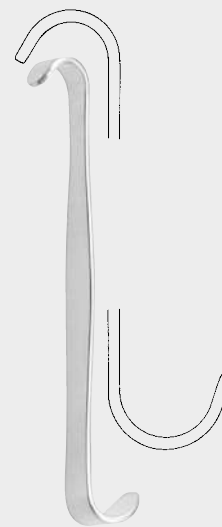

cm LUER
11,5 18-1208-11
mm 8 x 11 / 10 x 12



Wundhaken
Retractors
Écarteurs
Separadores
Divaricatori

WUNDHAKEN
WUNDSPERRER

RETRACTORS

ÉCARTEURS

SEPARADORES

DIVARICATORI



mm	LANE
13 x 19	18-1220-19
25 x 32	18-1220-32
	23,0 cm

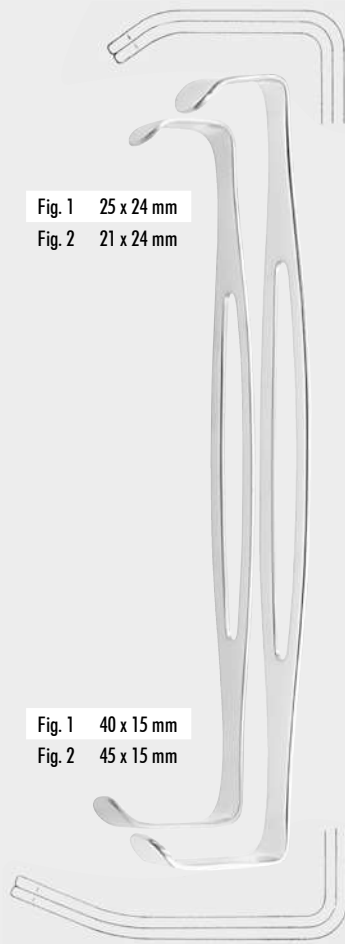

Fig. 1 25 x 24 mm
Fig. 2 21 x 24 mm

Fig. 1 40 x 15 mm
Fig. 2 45 x 15 mm

cm	US Army (PARKER LANGENBECK)
21,0	18-1301-21
	Set

Fig. 1 18-1301-01
Fig. 2 18-1301-02

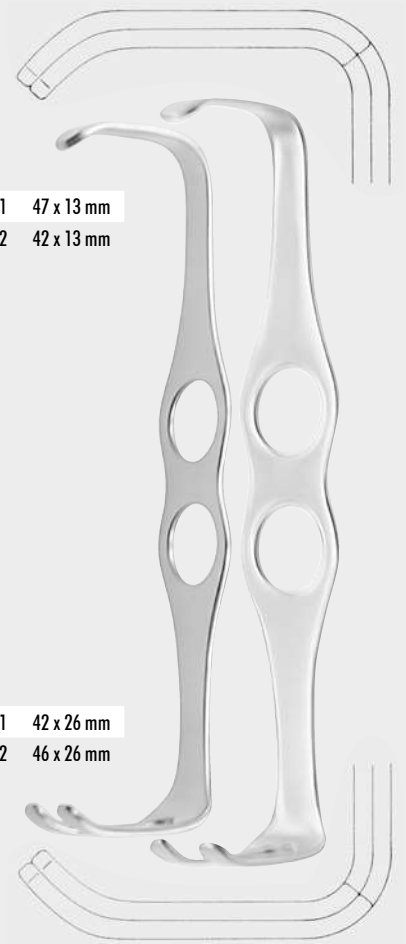
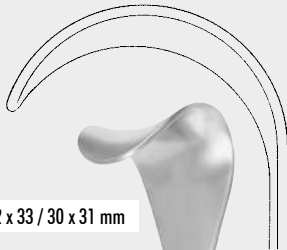

Fig. 1 47 x 13 mm
Fig. 2 42 x 13 mm

Fig. 1 42 x 26 mm
Fig. 2 46 x 26 mm

cm	MATHIEU
20,0	18-1304-20
	Set

Fig. 1 18-1304-01
Fig. 2 18-1304-02



52 x 33 / 30 x 31 mm

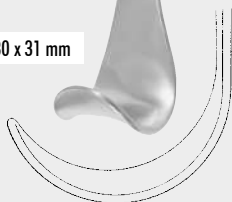

37 x 40 / 30 x 31 mm

cm	GOELET
19,0	18-1305-19

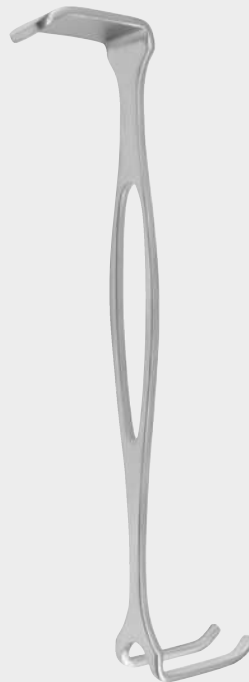

14,0 cm 38 x 28 mm
16,0 cm 52 x 33 mm

mm	CZERNY
32 x 22	18-1306-22



14,0 cm 32 x 21 mm
16,0 cm 36 x 27 mm

cm	COLLIN HARTMANN
14,0	18-1307-14
16,0	18-1307-16

20 x 20 mm



20 x 16 mm

cm	
20,0	18-1312-20



Wundhaken
Retractors
Écarteurs
Separadores
Divaricatori



RICHARDSON EASTMAN		cm
Set	18-1400-00	
Fig. 1	18-1400-01	26,0
Fig. 2	18-1400-02	28,0



RICHARDSON	
18-1500-01 - 18-1500-03	



18-1500-01	28 x 20 mm
18-1500-02	36 x 28 mm
18-1500-03	44 x 38 mm

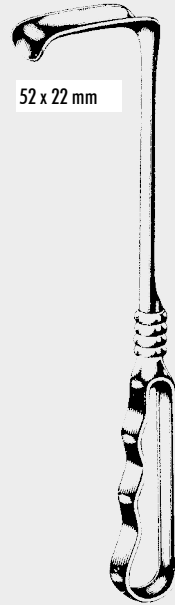

RICHARDSON	
18-1500-04	



RICHARDSON Grip	
18-1502-25	20 x 25 mm
18-1502-31	25 x 31 mm
18-1502-38	38 x 38 mm
18-1502-51	19 x 51 mm
18-1502-64	41 x 64 mm

WUNDHAKEN
WUNDSPERRER

RETRACTORS

ÉCARTEURS

SEPARADORES

DIVARICATORI



KELLY 26,0 cm
18-1506-26 - 18-1506-90

18-1506-26	65 x 50 mm
18-1506-50	50 x 40 mm
18-1506-65	65 x 75 mm
18-1506-70	70 x 65 mm
18-1506-71	70 x 50 mm
18-1506-90	90 x 76 mm



KELLY Grip 26,0 cm
18-1508-51 - 18-1508-82

18-1508-51	38 x 51 mm
18-1508-64	51 x 64 mm
18-1508-76	64 x 76 mm
18-1508-82	70 x 82 mm

Wundhaken
 Retractors
 Écarteurs
 Separadores
 Divaricatori

**WUNDHAKEN
 WUNDSPERRER**

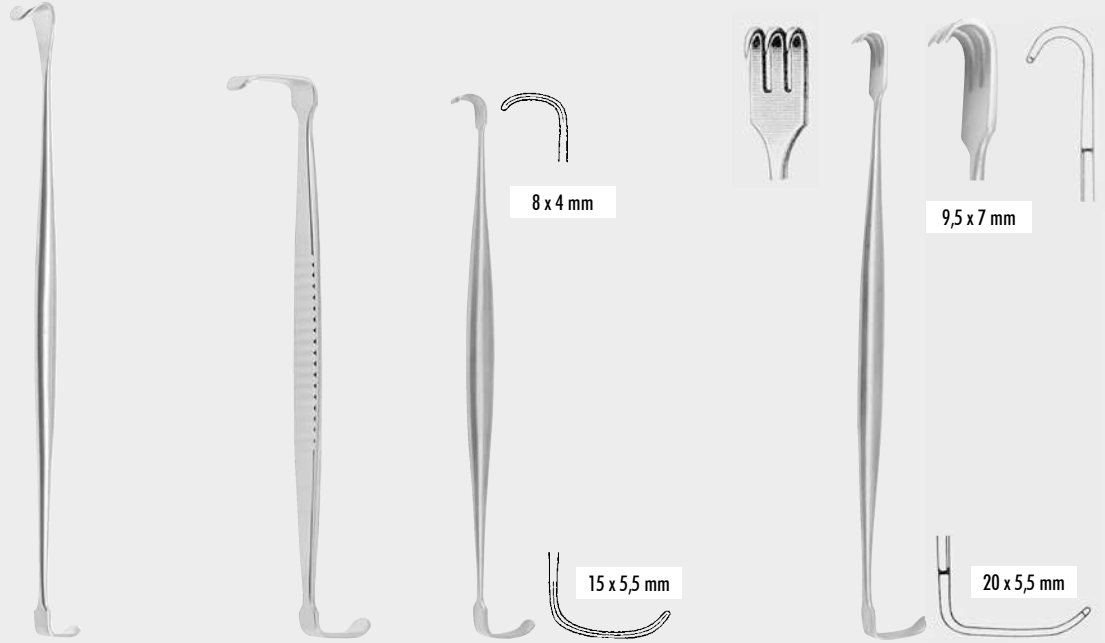

mm	COPE 18,0 cm	mm x mm	HOUSE 15,0 cm	cm	RAGNELL DAVIS	cm	SENN MILLER
8 x 11	18-1590-18	6,5 x 20/9 x 25	18-1592-15	14,0	18-1598-14	17,0	18-1600-17
							18-1601-17

RETRACTORS

ÉCARTEURS

SEPARADORES

DIVARICATORI

Wundhaken, Bauchspatel
 Retractors, Abdominal Spatula
 Écarteurs, Spatules abdominales
 Separadores, valvas abdominales
 Divaricatori, Spatole addominali

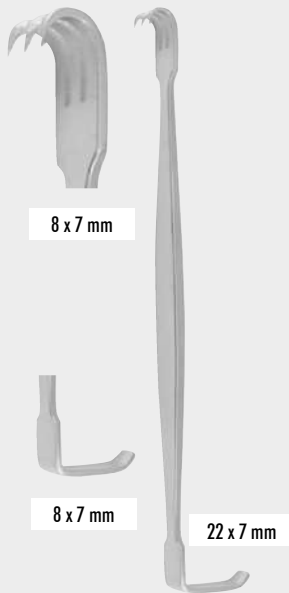

8 x 7 mm	22 x 7 mm
----------	-----------

SENN MILLER Baby
 18-1602-15
 18-1603-15
 15,0 cm



mm CHEVRET
 40 18-1604-40
 60 18-1604-60
 80 18-1604-80
 30,0 cm



RIBBON		
18-1698-06	6 x 200 mm	
18-1698-07	7 x 200 mm	
18-1698-09	9 x 200 mm	
18-1698-95	9,5 x 200 mm	soft
18-1698-12	12 x 200 mm	
18-1698-13	13 x 200 mm	soft
18-1698-17	17 x 200 mm	
18-1698-18	19 x 200 mm	soft
18-1698-19	16 x 200 mm	soft
18-1698-20	20 x 200 mm	
18-1698-24	25 x 200 mm	
18-1698-25	25 x 250 mm	
18-1698-26	25 x 200 mm	soft



konkav
concave
concaða
concave
concava



konvex
convex
convexa
convexe
convessa



mm	CUSHING, 18,0 cm
7/9	18-1670-07
11/13	18-1670-11
15/18	18-1670-15
18/22	18-1670-18

mm	OLIVECRONA, 18,0 cm
7/9	18-1672-07
11/13	18-1672-11
15/18	18-1672-15
18/22	18-1672-18

mm	OLIVECRONA, 18,0 cm
7/9	18-1674-07
11/13	18-1674-11
15/18	18-1674-15
18/22	18-1674-18

mm	HEIFETZ
8	18-1680-08
11	18-1680-11
14	18-1680-14
17	18-1680-17
20	18-1680-20

WUNDHAKEN
WUNDSPERRER

Spatel
Spatulas
Spatules
Espátulas
Spatole

RETRACTORS

ÉCARTEURS

SEPARADORES

DIVARICATORI



mm	cm
9,0	18-1684-20 20,0
12,0	18-1685-20 20,0
12,0	18-1686-25 25,0

mm	SCOVILLE
10/13	18-1690-10
16/19	18-1690-16

RIBBON	
18-1700-13	13 x 330 mm
18-1700-19	19 x 330 mm
18-1700-25	25 x 330 mm
18-1700-30	30 x 330 mm
18-1700-32	32 x 330 mm
18-1700-40	40 x 330 mm
18-1700-50	50 x 330 mm
18-1700-75	75 x 330 mm

mm	CAIRNS
6	18-1702-06
8	18-1702-08
10	18-1702-10
11	18-1702-11
13	18-1702-13
16	18-1702-16
19	18-1702-19
25	18-1702-25

20,0 cm

HABERER	
18-1704-17*	17/25 x 200 mm
18-1704-25	25/30 x 250 mm
18-1704-37	37/45 x 300 mm
18-1704-50	50/40 x 305 mm

* (TUFFIER)



Bauchspatel, Wundhaken
 Abdominal Spatula, Retractors
 Spatule abdominale, Écarteurs
 Espátula abdominal, Separadores
 Spatola addominale, Divaricatori

**WUNDHAKEN
 WUNDSPERRER**

RETRACTORS

ÉCARTEURS

SEPARADORES

DIVARICATORI



cm REVERDIN
 28,0 18-1705-28



DEAVER
 18-1800-19
 19 x 180 mm



DEAVER
 18-1801-22
 22 x 215 mm



DEAVER
 18-1801-25
 25 x 230 mm



DEAVER
 18-1803-25
 25 x 300 mm



DEAVER
 18-1805-25
 25 x 330 mm



DEAVER
 18-1807-25
 25 x 360 mm



DEAVER
 18-1807-38
 38 x 300 mm



DEAVER
 18-1807-50
 50 x 300 mm



DEAVER
 18-1807-75
 75 x 300 mm



DEAVER Grip	
18-1809-25	25 x 310 mm
18-1809-38	38 x 310 mm
18-1809-50	50 x 310 mm
18-1809-75	75 x 310 mm
18-1810-00	100 x 310 mm



THORLAKSON 33,0 cm	
18-1890-40	170 x 45 mm
18-1890-50	170 x 50 mm
18-1890-65	170 x 65 mm



THORLAKSON 25,0 cm	
18-1892-25	125/175 x 25 mm
18-1892-35	125/175 x 35 mm
18-1892-50	125/175 x 50 mm

Wundhaken
Retractors
Écarteurs
Separadores
Divaricatori

WUNDHAKEN
WUNDSPERRER

RETRACTORS

ÉCARTEURS

SEPARADORES

DIVARICATORI



26,0 cm	
18-1894-29	205 x 29 mm



HARRINGTON	
18-1901-25	25 x 230 mm
18-1901-40	40 x 320 mm
18-1901-62	62 x 320 mm



Vagotomie Wundhaken
Vagotomy Retractor
Écarteur à vagotomie
Separador para vagotomía
Divaricatore per vagotomia

cm	WEINBERG
24,0	18-1908-00
	90 x 160 mm

Wundhaken
 Retractors
 Écarteurs
 Separadores
 Divaricatori

WUNDHAKEN
 WUNDSPERRER

RETRACTORS

ÉCARTEURS

SEPARADORES

DIVARICATORI



cm GAEFE
 16,0 18-1998-16



cm GAEFE
 16,0 18-1999-16



GAEFE
 18-2100-12



GAEFE
 18-2101-12



GUTHRIE
 18-2102-01



GUTHRIE
 18-2102-02

16,0 cm 18-2100-01 - 18-2102-02



cm FRAZIER
 13,0 18-2104-13
 18,0 18-2104-18



18-2106-01



18-2106-02
 2 mm



18-2106-05
 5 mm



18-2106-07
 7 mm



18-2106-10
 10 mm

cm JOSEPH
 16,0 18-2106-01 - 18-2106-10



mm KLEINERT KUTZ
 3 18-2150-03
 5 18-2150-05
 7 18-2150-07
 13,0 cm

Wundhaken
Retractors
Écarteurs
Separadores
Divaricatori

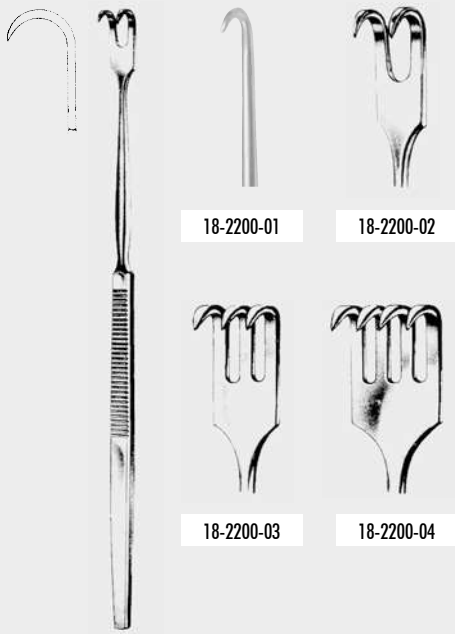

18-2200-01

18-2200-02

18-2200-03

18-2200-04

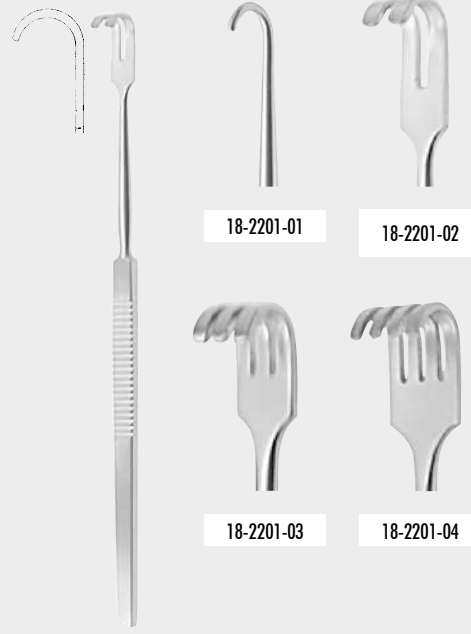

18-2201-01

18-2201-02

18-2201-03

18-2201-04

16,0 cm 18-2200-01 - 18-2200-04

16,0 cm 18-2201-01 - 18-2201-04

WUNDHAKEN
WUNDSPERRER

RETRACTORS

ÉCARTEURS

SEPARADORES

DIVARICATORI



18-2206-02

18-2207-02

18-2206-03

18-2207-03

18-2206-04

18-2207-04

mm
8 18-2300-08

mm
14 18-2300-14

mm
10 18-2300-10

mm
16 18-2300-16

mm
12 18-2300-12

mm
18 18-2300-18

16,0 cm 18-2206-02 - 18-2207-04

flexibel
flexible
flessibile

16,0 cm 18-2210-04 16,0 cm 18-2211-04

cm DESMARRES
16,0 18-2300-08 - 18-2300-18

Auch Lidhalter
Also Eyelid Retractors
Aussi écarteurs de paupières
También separadores de párpados
Anche divaricatori di palpebre



Wundhaken
Retractors
Écarteurs
Separadores
Divaricatori

**WUNDHAKEN
WUNDSPERRER**



CUSHING 25,0 cm	
18-2301-11	11 x 14 mm
18-2301-13	13 x 18 mm
18-2301-15	15 x 22 mm



mm	
8	18-2302-08
8	18-2304-08



mm	
10	18-2302-10
10	18-2304-10



mm	
12	18-2302-12
12	18-2304-12



mm	
14	18-2302-14
14	18-2304-14



mm	
16	18-2302-16
16	18-2304-16



mm	
18	18-2302-18
18	18-2304-18



cm	23,5 cm
20,0	18-2306-23

RETRACTORS

ÉCARTEURS

SEPARADORES

DIVARICATORI

CUSHING	
cm	20,0 18-2302-08 - 18-2302-18
	24,0 18-2304-08 - 18-2304-18

Hilushaken - Hilar Retracto
Écarteurs hilaires - Separadores hilares
Divaricatori ilari



x = mm	16,0 cm
12	18-2308-12
14	18-2308-14
16	18-2308-16
18	18-2308-18



x = mm	KÖNIG 17,0 cm
13	18-2310-13
16	18-2310-16



cm	CUSHING
20,0	18-2314-20



cm	CUSHING
21,5	18-2316-21



mm	KIRKLAND 13,5 cm
5	18-2320-05
7	18-2320-07
10	18-2320-10
12	18-2320-12
15	18-2320-15

biegsam
malleable
malléables
maleables
malleabili



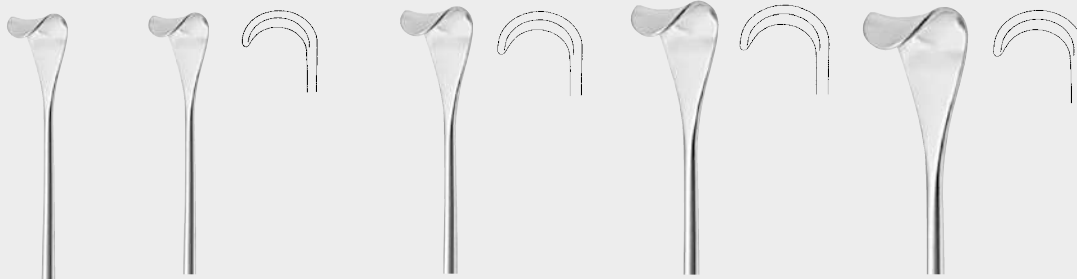

mm
8 18-2322-08

mm
11 18-2322-11

mm
13 18-2322-13

mm
15 18-2322-15

biegsam - malleable - malléables - maleables - malleabili



mm
17 18-2322-17

mm
20 18-2322-20

mm
23 18-2322-23

biegsam - malleable - malléables - maleables - malleabili



cm GIL VERNET
24,0 18-2322-08 - 18-2322-23

Wundhaken
Retractors
Écarteurs
Separadores
Divaricatori

WUNDHAKEN
WUNDSPERRER

RETRACTORS

ÉCARTEURS

SEPARADORES

DIVARICATORI

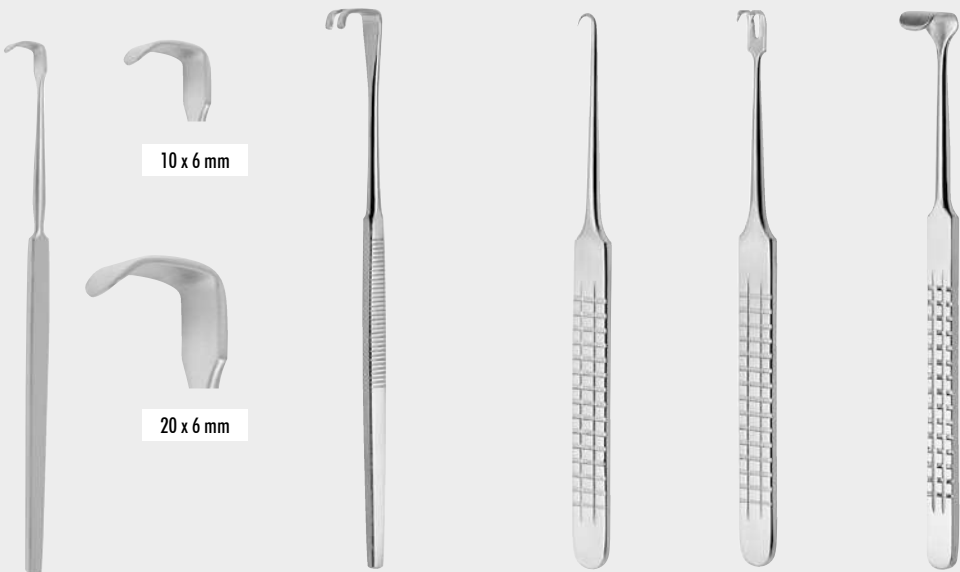

10 x 6 mm

20 x 6 mm

SENN-GREEN 14,0 cm
10 x 6 mm 18-2400-10
20 x 6 mm 18-2400-20

16,0 cm
14 x 8 mm 18-2402-14

16,0 cm
18-2404-01

16,0 cm
18-2404-02

16,0 cm
10 x 13 mm 18-2405-13

Wundhaken
 Retractors
 Écarteurs
 Separadores
 Divaricatori

WUNDHAKEN
 WUNDSPERRER

RETRACTORS

ÉCARTEURS

SEPARADORES

DIVARICATORI



mm	LANGENBECK GREEN 16,0 cm
16 x 6	18-2406-16
24 x 6	18-2406-24



cm	LANGENBECK mini
16,0	18-2407-10 - 18-2407-22



mm	
10 x 6	18-2407-10

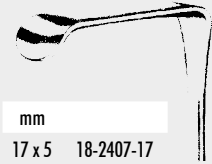

mm	
17 x 5	18-2407-17

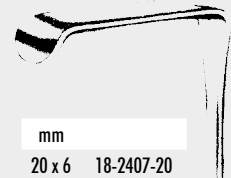

mm	
20 x 6	18-2407-20

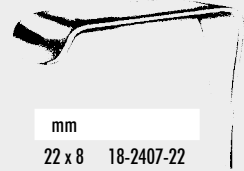

mm	
22 x 8	18-2407-22



mm	MOBERG 17,0 cm
14 x 5	18-2409-14
16 x 5	18-2409-16
25 x 6	18-2409-25



cm	KOENIG
17,0	18-2411-13 - 18-2411-16



mm	18-2411-13
13 x 13	mm



mm	18-2411-16
13 x 16	mm

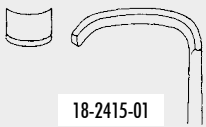

18-2415-01



18-2415-02



cm STRANDELL STILLE
19,0 18-2415-01 - 18-2415-02



Fig. BROM 19,5 cm
1 18-2416-01
2 18-2416-02



12,0 cm
18-2418-12



BERGMANN 14,0 cm
18-2420-14

Wundhaken
Retractors
Écarteurs
Separadores
Divaricatori

WUNDHAKEN
WUNDSPERRER

RETRACTORS

ÉCARTEURS

SEPARADORES

DIVARICATORI



18-2700-02



18-2701-02



18-2700-03



18-2701-03



18-2700-04



18-2701-04



18-2700-06



18-2701-06



cm VOLKMANN
11,5 18-2700-02 - 18-2701-06



WUNDHAKEN
WUNDSPERRER



VOLKMANN 21,5 cm
18-2800-01 - 18-2803-06



18-2800-01



18-2800-02



18-2800-03



18-2800-04



18-2800-06

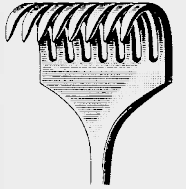

18-2800-08

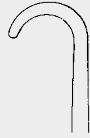

18-2801-01



18-2801-02



18-2801-03



18-2801-04



18-2801-06

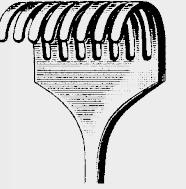

18-2801-08



18-2803-01



18-2803-02



18-2803-03



18-2803-04

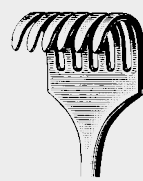

18-2803-06

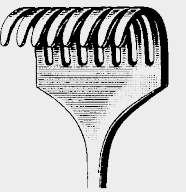

18-2803-08

RETRACTORS

ÉCARTEURS

SEPARADORES

DIVARICATORI



KOCHER 22,0 cm
18-2810-01 - 18-2813-08

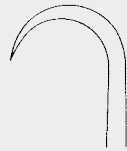

18-2810-01



18-2810-02



18-2810-03



18-2810-04

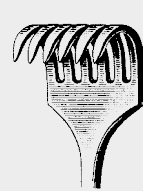

18-2810-06

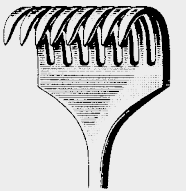

18-2810-08



18-2811-01



18-2811-02



18-2811-03



18-2811-04

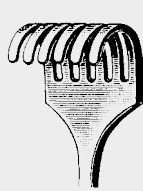

18-2811-06

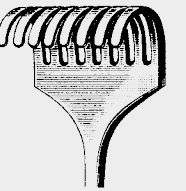

18-2811-08

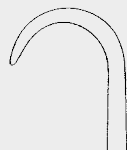

18-2813-01



18-2813-02



18-2813-03



18-2813-04

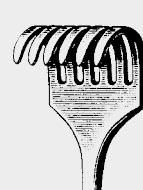

18-2813-06

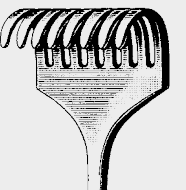

18-2813-08



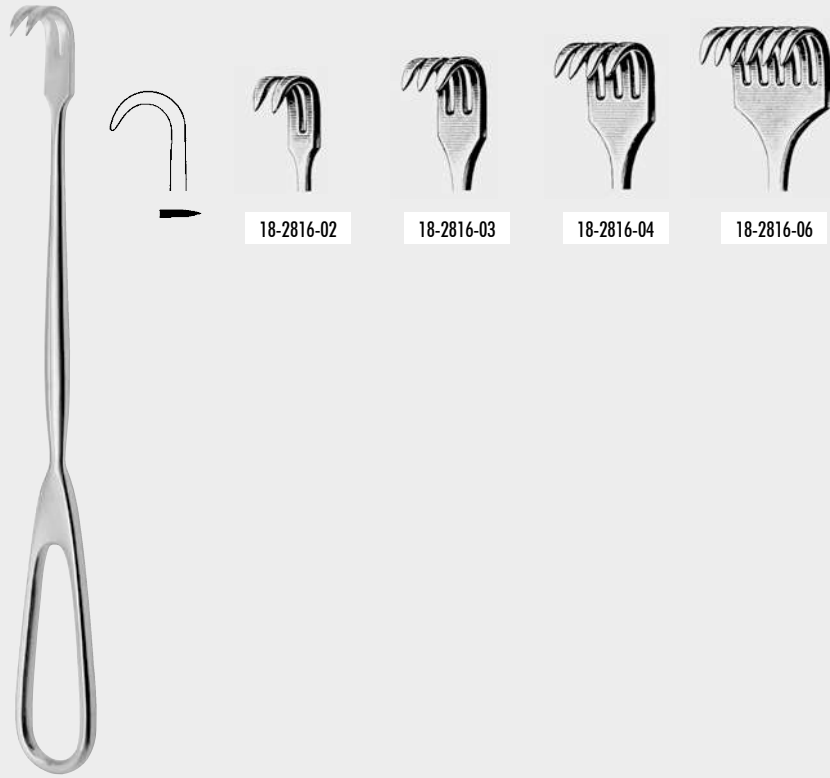

18-2816-02

18-2816-03

18-2816-04

18-2816-06

cm VOLKMANN US
22,5 18-2816-02 - 18-2816-06

WUNDHAKEN
WUNDSPERRER

RETRACTORS

ÉCARTEURS

SEPARADORES

DIVARICATORI

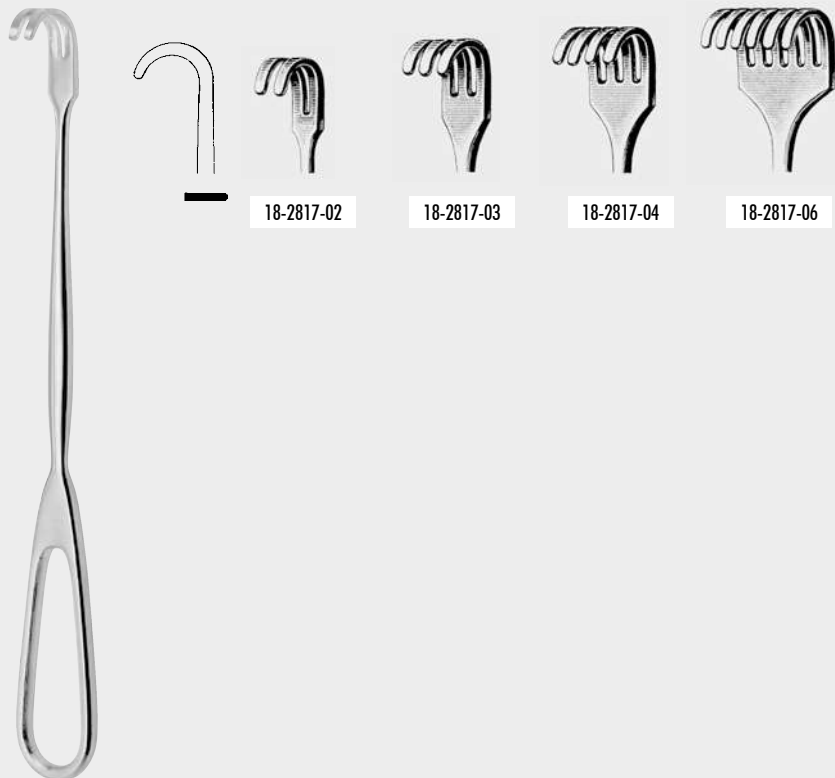

18-2817-02

18-2817-03

18-2817-04

18-2817-06

cm VOLKMANN US
22,5 18-2817-02 - 18-2817-06

WUNDHAKEN
WUNDSPERRER

RETRACTORS

ÉCARTEURS

SEPARADORES

DIVARICATORI

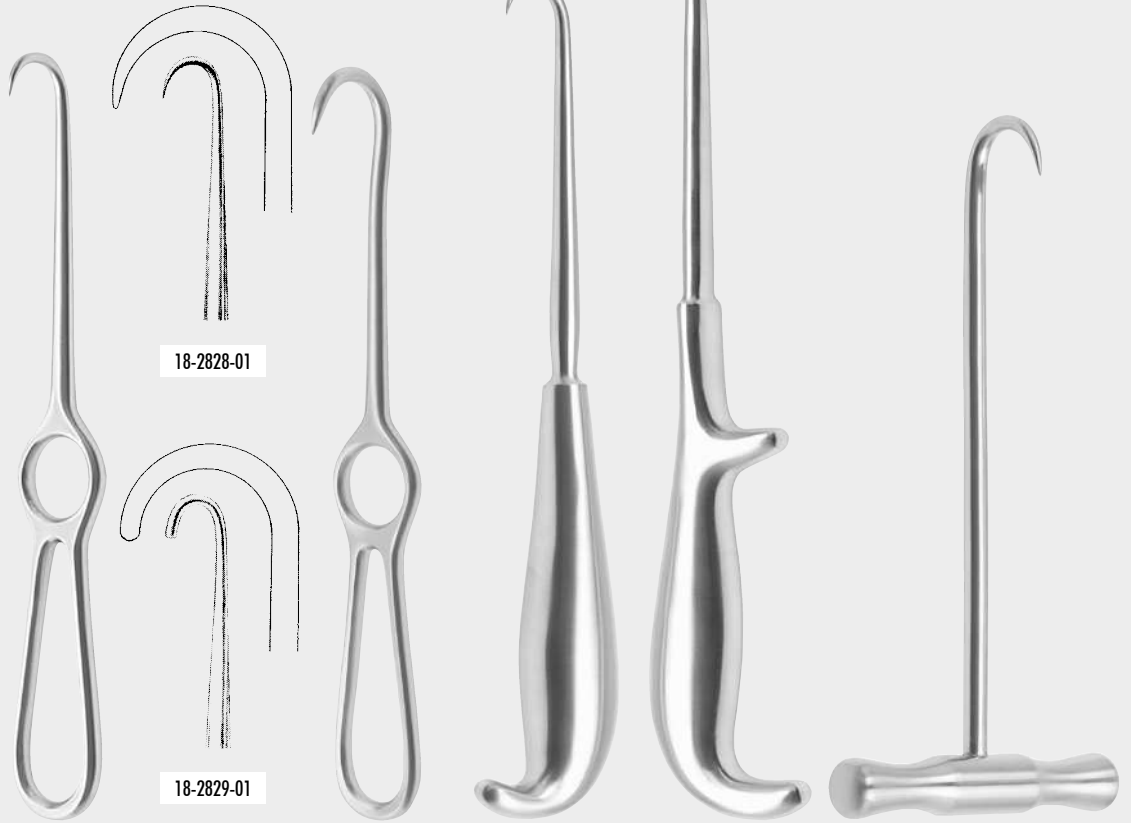

cm	VOLKMANN	20,0 cm	mm	23,0 cm	GINESTET 24,0 cm	18,0 cm
21,5	18-2828-01-18-2829-01	18-2830-01	9,5	18-2832-09	18-2833-01	18-2834-01
		18-2831-01	19,0	18-2832-19		
			25,0	18-2832-25		



cm	LAMBOTTE	cm	PAUL 12,0 cm	cm	MURPHY	18-2904-02	18-2905-02
22,0	18-2836-22	15,0	18-2897-04	11 x 8	18-2899-04	18-2904-03	18-2905-03
25,0	18-2836-25	15 x 12 mm				18-2904-04	18-2905-04
28,0	18-2836-28					18-2904-06	18-2905-06



CAIRNS RAKE 22,0 cm
18-2906-03



CAIRNS RAKE 22,0 cm
18-2906-04



18-2991-02
12 x 6 mm



18-2991-03
12 x 11 mm

KLAPP
18-2991-02 - 18-2991-03



KRASKY 28,0 cm
18-2992-06



18 x 7 mm 18-3002-01



16 x 5 mm 18-3002-02



7 x 4 mm 18-3002-03



7 x 4 mm 18-3002-04



10 x 3 mm 18-3002-05



cm MEYERDING
18,0 18-3002-01- 18-3002-06



10 x 4 mm 18-3002-06

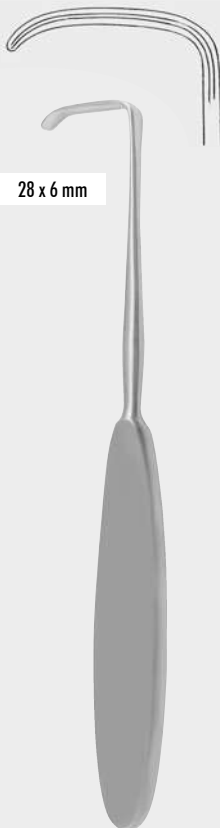

28 x 6 mm

cm LAHEY
19,0 18-3004-19



12 x 14 mm

cm LITTLE
20,0 18-3006-20

WUNDHAKEN
WUNDSPERRER

RETRACTORS

ÉCARTEURS

SEPARADORES

DIVARICATORI



cm LANGENBECK
22,0 18-3100-01 - 18-3100-05



cm LANGENBECK
21,0 18-3102-01 - 18-3102-07

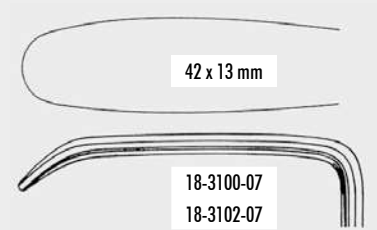
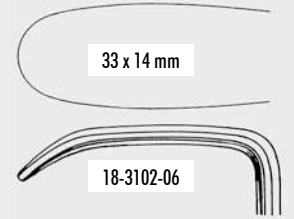
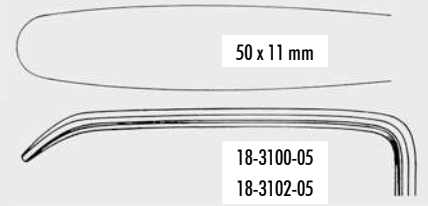
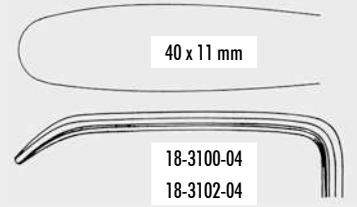
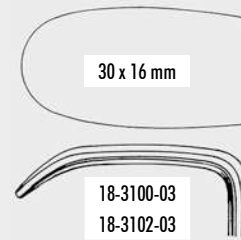
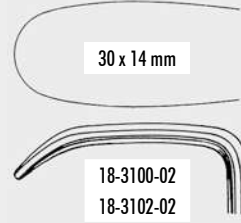
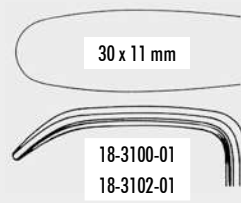

WUNDHAKEN
WUNDSPERRER

RETRACTORS

ÉCARTEURS

SEPARADORES

DIVARICATORI

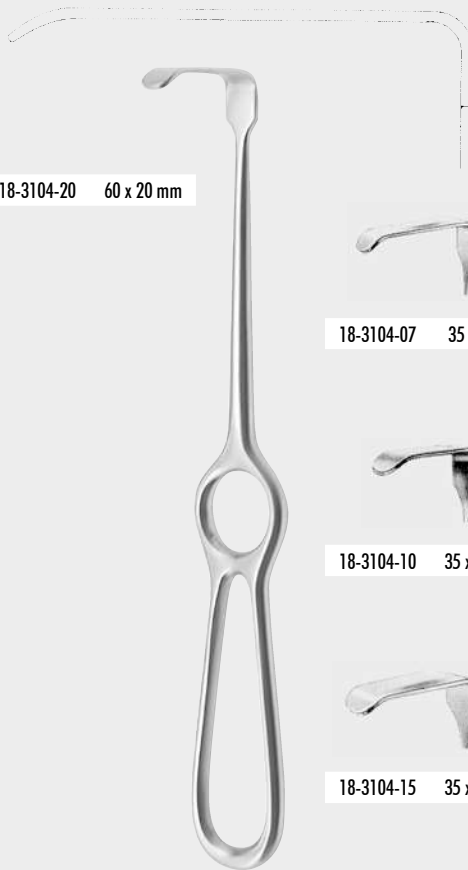

18-3104-20 60 x 20 mm



18-3104-07 35 x 7 mm



18-3104-10 35 x 10 mm



18-3104-15 35 x 15 mm



cm LANGENBECK
21,0 18-3104-07 - 18-3104-20

mm LANGENBECK
60 x 20 18-3105-21
55 x 20 18-3105-22





mm LANGE 21,0 cm
40 x 10 18-3106-10



85 x 15 mm

cm LANGENBECK
21,0 18-3107-21

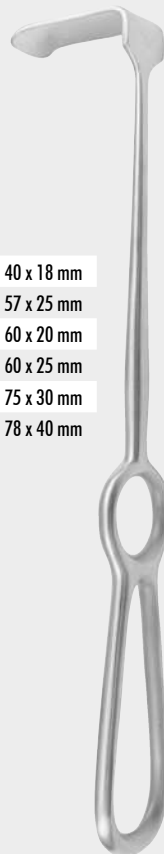

18-3108-40 40 x 18 mm
18-3108-57 57 x 25 mm
18-3108-60 60 x 20 mm
18-3108-61 60 x 25 mm
18-3108-75 75 x 30 mm
18-3108-78 78 x 40 mm

cm KOCHER
23,0 18-3108-40 - 18-3108-78

WUNDHAKEN
WUNDSPERRER

RETRACTORS

ÉCARTEURS

SEPARADORES

DIVARICATORI



mm KOCHER 21,0 cm
23 x 8 18-3110-23



mm KOCHER 23,0 cm
40 x 18 18-3120-18
60 x 20 18-3120-20
60 x 25 18-3120-25
75 x 30 18-3120-30
75 x 40 18-3120-40

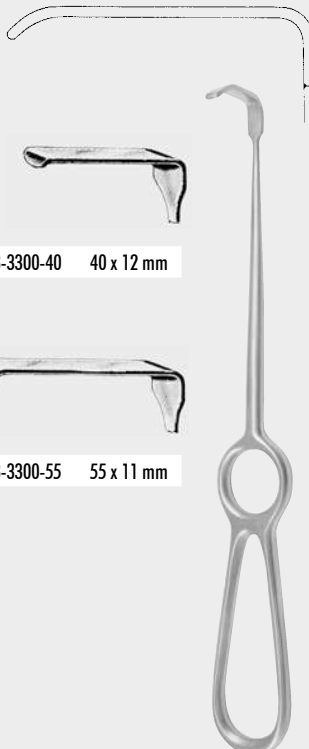

18-3300-40 40 x 12 mm

18-3300-55 55 x 11 mm

cm KOCHER
19,0 18-3300-40 - 18-3300-55

WUNDHAKEN
WUNDSPERRER

RETRACTORS

ÉCARTEURS

SEPARADORES

DIVARICATORI



mm BROMHEAD
70 x 22 18-3301-22



cm KOCHER
19,0 18-3302-19 - 18-3302-21



18-3302-19 19 x 12 mm



18-3302-21 21 x 14 mm



mm KOCHER 22,0 cm
40 x 10 18-3400-10
40 x 15 18-3400-15
40 x 20 18-3400-20

10 x 10 mm



cm CUSHING KOCHER
18,0 18-3401-18



mm LONDON HOSPITAL
32 x 19 18-3401-19
23,0 cm

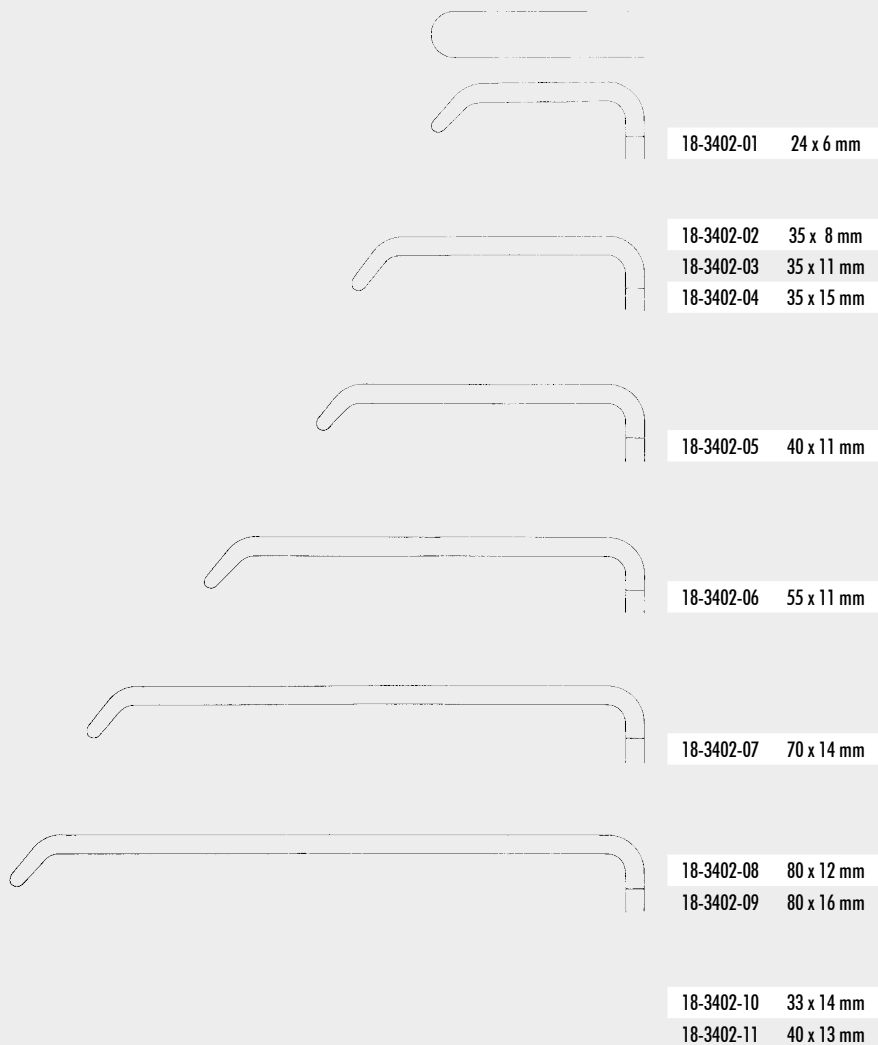

cm KOCHER LANGENBECK
21,5 18-3402-01 - 18-3402-09

WUNDHAKEN
WUNDSPERRER

RETRACTORS

ÉCARTEURS

SEPARADORES

DIVARICATORI



cm 18,0 18-3403-01



cm 18,0 18-3403-02



cm 18,0 18-3403-03



18-3404-14 14 x 17 mm



18-3404-20 20 x 22 mm



18-3404-26 26 x 30 mm



cm GREEN
22,0 18-3408-22



mm OLLIER 22,5 cm
36 x 25 18-3600-02
36 x 30 18-3600-03
36 x 60 18-3600-04

WUNDHAKEN
WUNDSPIERRER

RETRACTORS

ÉCARTEURS

SEPARADORES

DIVARICATORI

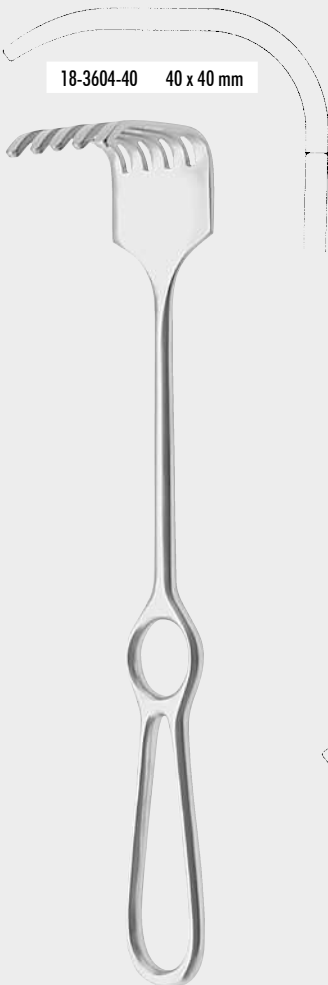

18-3604-40 40 x 40 mm



18-3604-50 45 x 50 mm

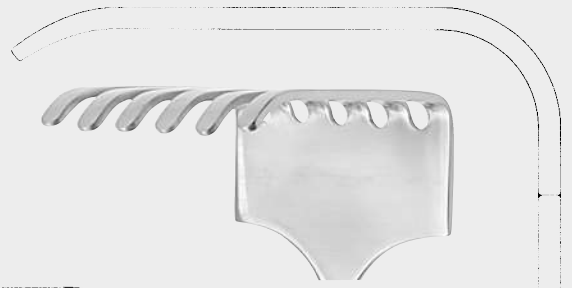

18-3604-70 70 x 70 mm

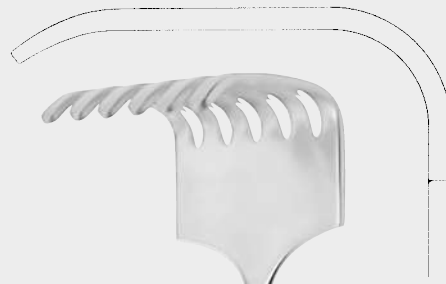

18-3604-60 50 x 60 mm

cm ISRAEL
25,0 18-3604-40 - 18-3604-70



FRITSCH	mm	cm
18-3700-31	37 x 31	23,5
18-3700-35	35 x 40	24,0
18-3700-40	45 x 40	24,0
18-3700-41	38 x 40	24,0
18-3700-50	45 x 50	24,0
18-3700-51	43 x 51	25,0
18-3700-60	45 x 60	24,0
18-3700-61	49 x 61	25,0
18-3700-75	55 x 75	24,0
18-3700-76	48 x 75	25,5
18-3700-85	65 x 85	26,5

cm	mm	KOERTE
23,5	40 x 30	18-3606-08 18-3607-08

cm	mm	KOERTE
23,0	46 x 55	18-3609-04

WUNDHAKEN
WUNDSPERRER

RETRACTORS

ÉCARTEURS

SEPARADORES

DIVARICATORI



cm	mm	KOCHER
22,5	70 x 25	18-3702-22

mm	KOCHER 25,0 cm
80 x 45	18-3704-45
80 x 55	18-3704-55
80 x 65	18-3704-65

mm	HOESEL 25,0 cm
60 x 20	18-3706-01
80 x 30	18-3706-02
100 x 30	18-3706-03
120 x 30	18-3706-04
140 x 30	18-3706-05
140 x 40	18-3706-06
220 x 40	18-3706-07

ZEPF®
INSTRUMENTS



WUNDHAKEN
WUNDSPERRER

RETRACTORS

ÉCARTEURS

SEPARADORES

DIVARICATORI



18-3800-35
95 x 35 mm

90 x 50 mm 18-3802-50
85 x 55 mm 18-3802-55

120 x 50 mm 18-3800-50
85 x 35 mm 18-3801-35
150 x 50 mm 18-3801-50
180 x 50 mm 18-3801-51

mm	KELLY 27,0 cm
160 x 38	18-3805-38
160 x 57	18-3805-57

cm	mm	DOYEN
25,0	50 x 85	18-3708-25
26,0	78 x 82	18-3709-26

cm MIKULICZ
26,0 18-3800-35 - 18-3802-55



cm FOSS
26,0 18-3810-55



cm FOSS
18,0 18-3810-75

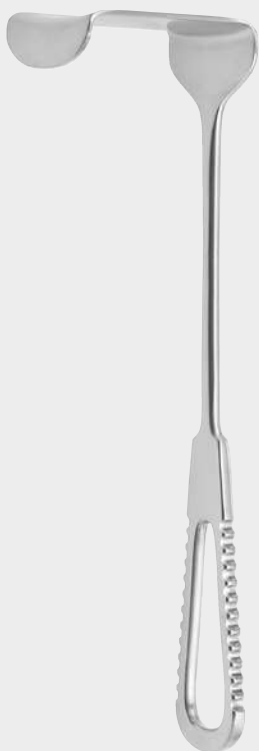

mm x mm	MORRIS 24,5 cm
70 x 40	18-3898-40
70 x 50	18-3898-50
70 x 65	18-3898-65

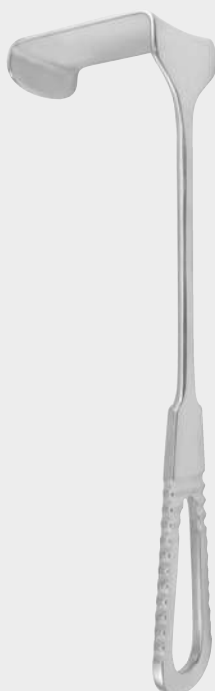

mm	MORRIS 21,0 cm
38 x 51	18-3900-38
51 x 51	18-3900-51
64 x 51	18-3900-64



mm	MORRIS 24,0 cm
32 x 51/38 x 51	18-3902-01
44 x 51/51 x 51	18-3902-02
64 x 51/38 x 51	18-3902-03

WUNDHAKEN
WUNDSPERRER

RETRACTORS

ÉCARTEURS

SEPARADORES

DIVARICATORI



mm x mm	KRÄMER 21,0 cm
60 x 10	18-3904-10

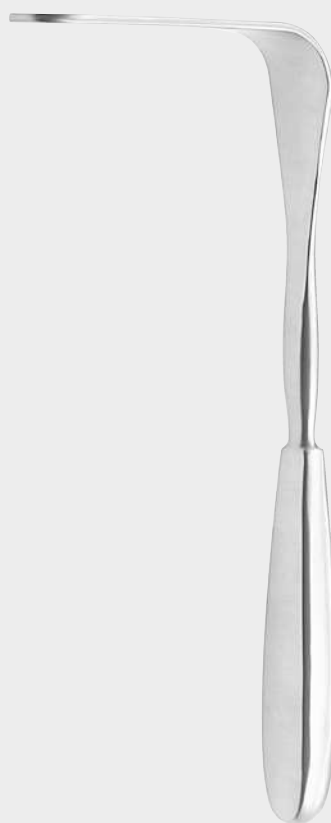

cm	MARTIN
26,0	18-4798-26
110 x 27 mm	

WUNDHAKEN
WUNDSPERRER

RETRACTORS

ÉCARTEURS

SEPARADORES

DIVARICATORI

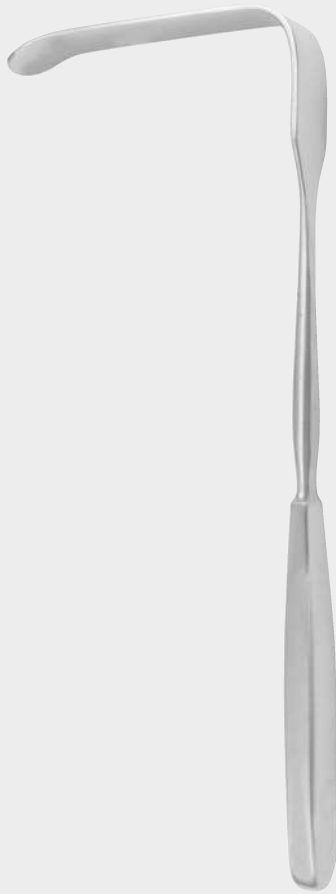

mm	SIMON 28,0 cm
115 x 22	18-4800-22
115 x 27	18-4800-27



mm	HEANEY 28,0 cm
45 x 28	18-4802-45
73 x 28	18-4802-73
82 x 28	18-4802-82



mm	HEANEY 16,0 cm
44 x 25	18-4803-44



mm	HEANEY SIMON 27,5 cm
25 x 115	18-4804-25



cm	ST. MARKS LLOYD-DAVIES	
29,0	18-4810-29	130 x 60 / 35 x 45 mm
32,0	18-4810-32	175 x 60 / 60 x 45 mm
33,0	18-4810-33	180 x 60 / 65 x 45 mm



Kaltlicht Anschluß
Fiber light connection

mm	ST. MARKS LLOYD DAVIES	
180 x 60/60 x 45	18-4811-32	32,0 cm



mm KOERTE 28,0 cm
120 x 47 18-4815-28

mm	LERICHE	cm
45	18-4817-25	31,0
60	18-4817-27	33,0

mm KUEMMEL 28,0 cm
100 x 45 18-4821-28

WUNDHAKEN
WUNDSPERRER

RETRACTORS

ÉCARTEURS

SEPARADORES

DIVARICATORI

ZEPF®
α
INSTRUMENTS

18-4821-28

18.29



125 x 37 mm



cm SAUERBRUCH
25,0 18-4898-25

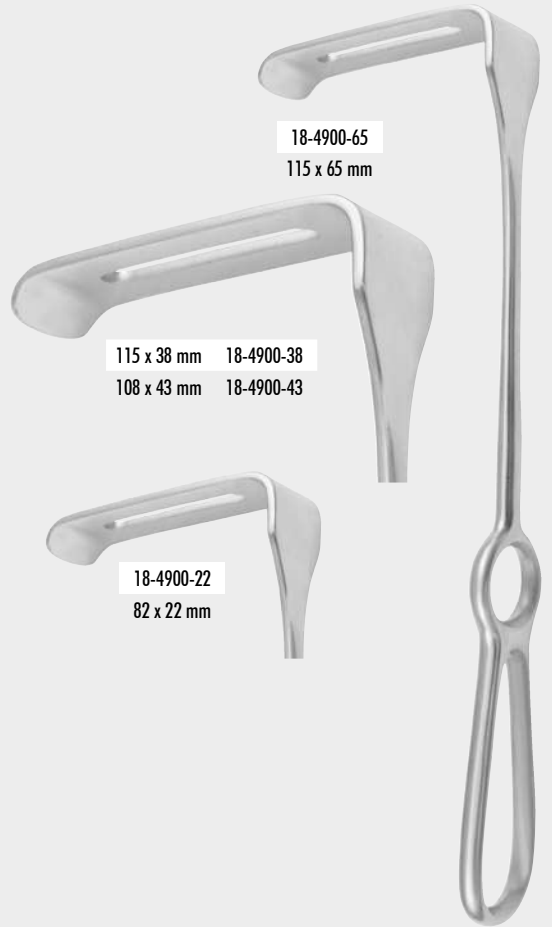

18-4900-65
115 x 65 mm

115 x 38 mm 18-4900-38
108 x 43 mm 18-4900-43

18-4900-22
82 x 22 mm

cm CORYLLOS (Thorax)
24,0 18-4900-22 - 18-4900-65

WUNDHAKEN
WUNDSPERRER

RETRACTORS

mm	KADER 27,0 cm
20	18-4823-20
30	18-4823-30
40	18-4823-40

ÉCARTEURS

SEPARADORES

DIVARICATORI

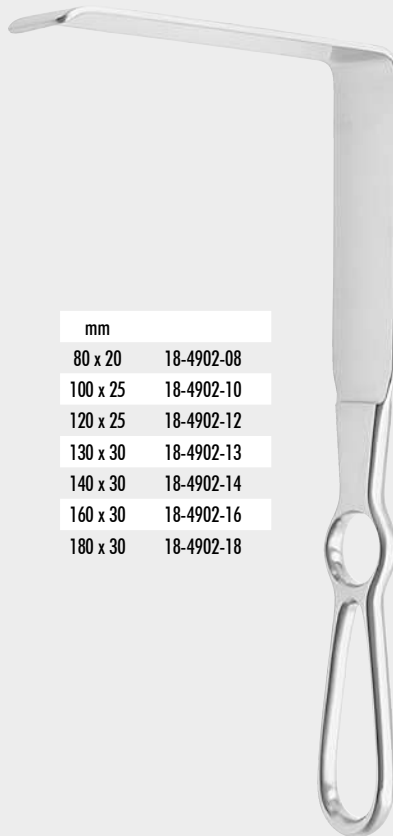

mm	
80 x 20	18-4902-08
100 x 25	18-4902-10
120 x 25	18-4902-12
130 x 30	18-4902-13
140 x 30	18-4902-14
160 x 30	18-4902-16
180 x 30	18-4902-18

cm BRUNNER
25,0 18-4902-08 - 18-4902-18

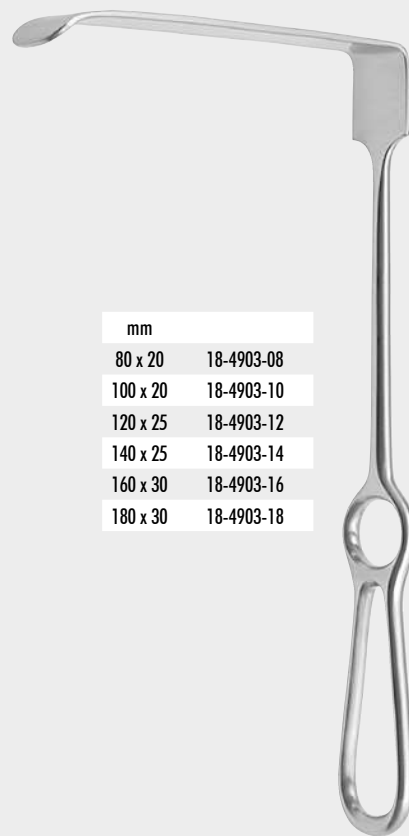

mm	
80 x 20	18-4903-08
100 x 20	18-4903-10
120 x 25	18-4903-12
140 x 25	18-4903-14
160 x 30	18-4903-16
180 x 30	18-4903-18

cm BRUNNER
25,0 18-4903-08 - 18-4903-18

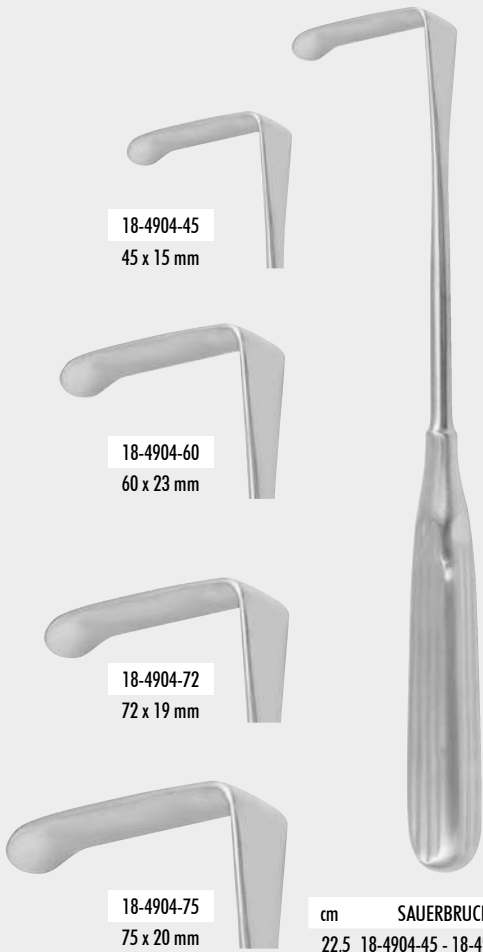

18-4904-45
45 x 15 mm

18-4904-60
60 x 23 mm

18-4904-72
72 x 19 mm

18-4904-75
75 x 20 mm

cm SAUERBRUCH
22,5 18-4904-45 - 18-4904-75

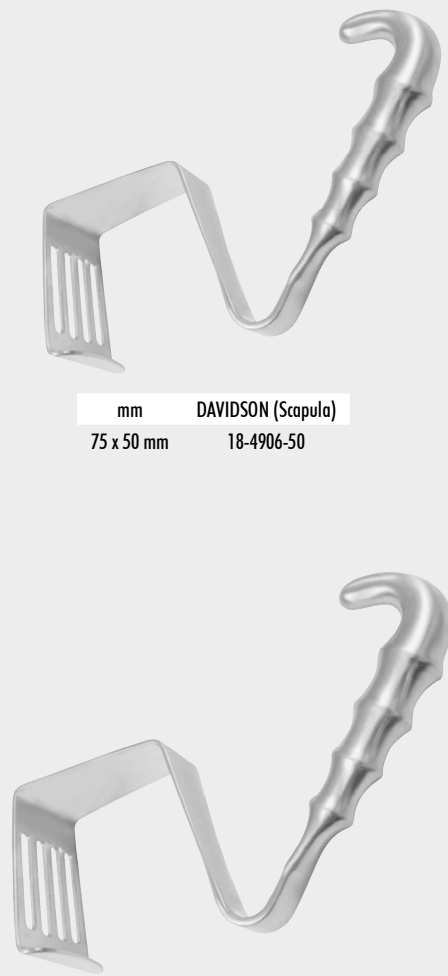

mm DAVIDSON (Scapula)
75 x 50 mm 18-4906-50

mm DAVIDSON (Scapula)
75 x 90 mm 18-4906-90

WUNDHAKEN
WUNDSPERRER

RETRACTORS

ÉCARTEURS

SEPARADORES

DIVARICATORI



cm	mm	MEYERDING
20,0	50 x 16	18-4908-01
22,0	75 x 25	18-4908-02
24,0	90 x 50	18-4908-03



cm	mm	ZENKER
18,0	10 x 3	18-4912-10
25,0	35 x 8	18-4912-35
26,0	60 x 12	18-4912-60
27,5	75 x 12	18-4912-75
26,5	85 x 20	18-4912-85
30,5	100 x 25	18-4913-10
27,5	120 x 12	18-4913-20

WUNDHAKEN
WUNDSPERRER



cm	DOYEN STILLE	mm
24,0	18-4921-20	90 x 28
24,0	18-4921-21	105 x 30
24,0	18-4921-22	120 x 52



mm	TUDOR EDWARDS 20,5 cm
55 x 47	18-4923-20



mm	TUFFIER 23,0 cm
64 x 60	18-4925-23

RETRACTORS

ÉCARTEURS

SEPARADORES

DIVARICATORI



mm	41,0 cm
245 x 30	18-4930-30
245 x 40	18-4930-40
245 x 50	18-4930-50
245 x 60	18-4930-60
245 x 70	18-4930-70



mm	MIDDELDORPF 25,5 cm
45 x 45	18-4933-45
45 x 50	18-4933-50
55 x 70	18-4933-70



mm	DURHAM 21,5 cm
10 x 19	18-4937-19
16 x 25	18-4937-25
22 x 38	18-4937-38



cm	mm	CANNY RYALL
19,0	16 x 25	18-4941-35
19,0	19 x 28	18-4941-60
20,5	25 x 32	18-4941-75



cm POLLOSON
27,0 18-4951-25

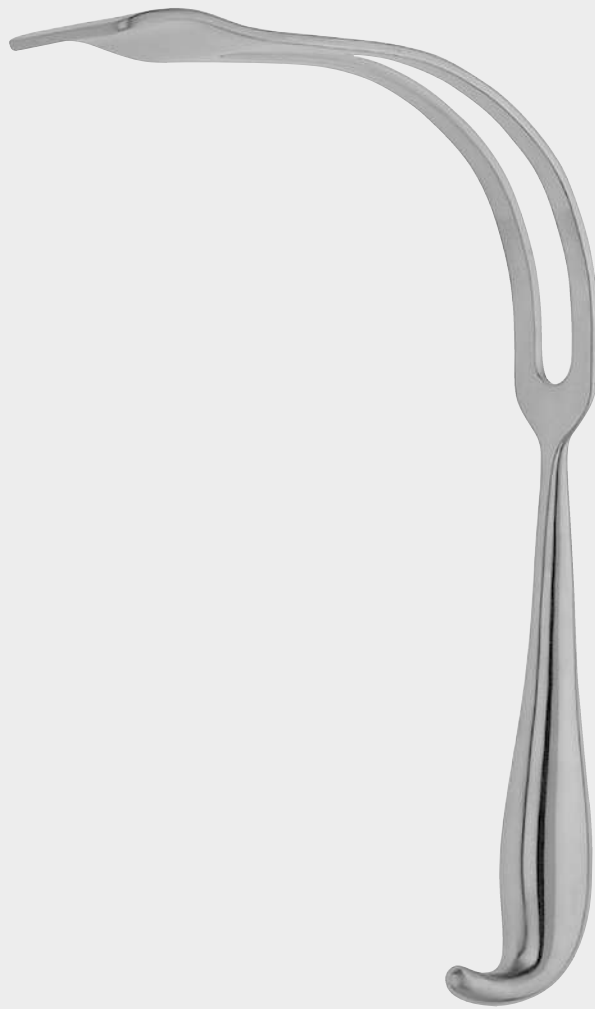

cm POLLOSON
27,0 18-4953-27



cm BÜCHS
20,5 18-4961-20

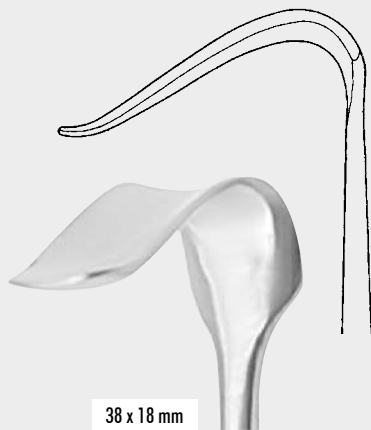

38 x 18 mm



cm WASSMUND
20,0 18-4965-20

WUNDHAKEN
WUNDSPERRER

RETRACTORS

ÉCARTEURS

SEPARADORES

DIVARICATORI

Handchirurgie
Hand Surgery
Chirurgie de la main
Cirugía de la mano
Chirurgia della mano

**WUNDHAKEN
WUNDSPERRER**

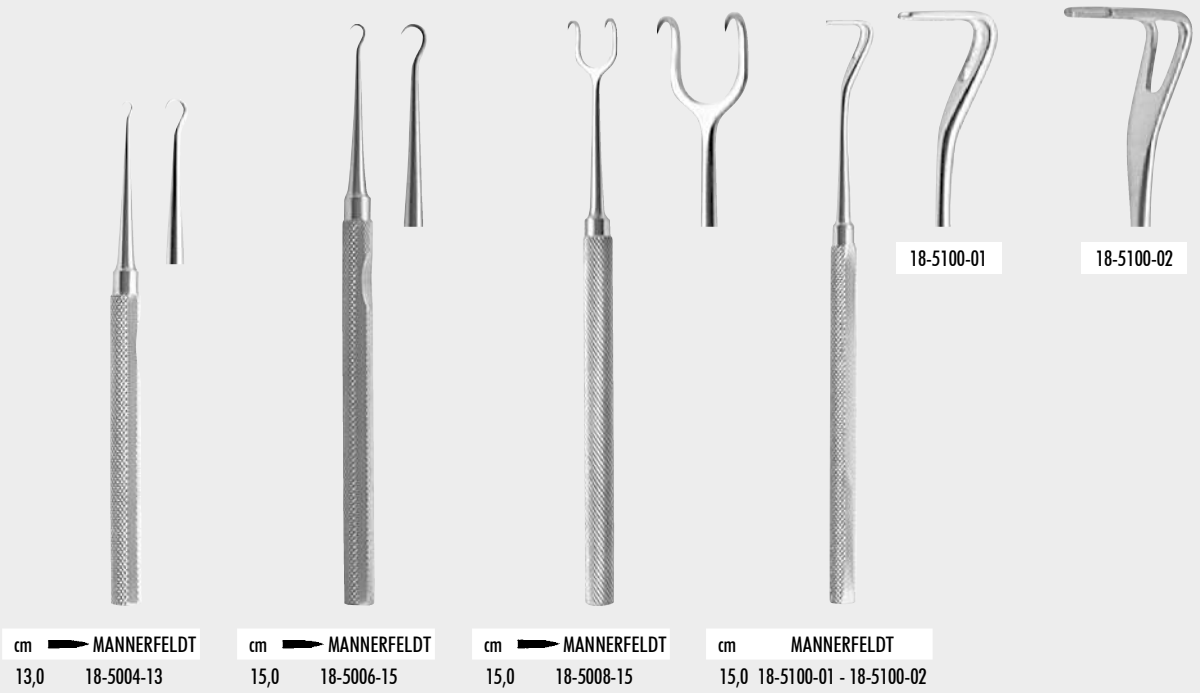

RETRACTORS

ÉCARTEURS

SEPARADORES

DIVARICATORI

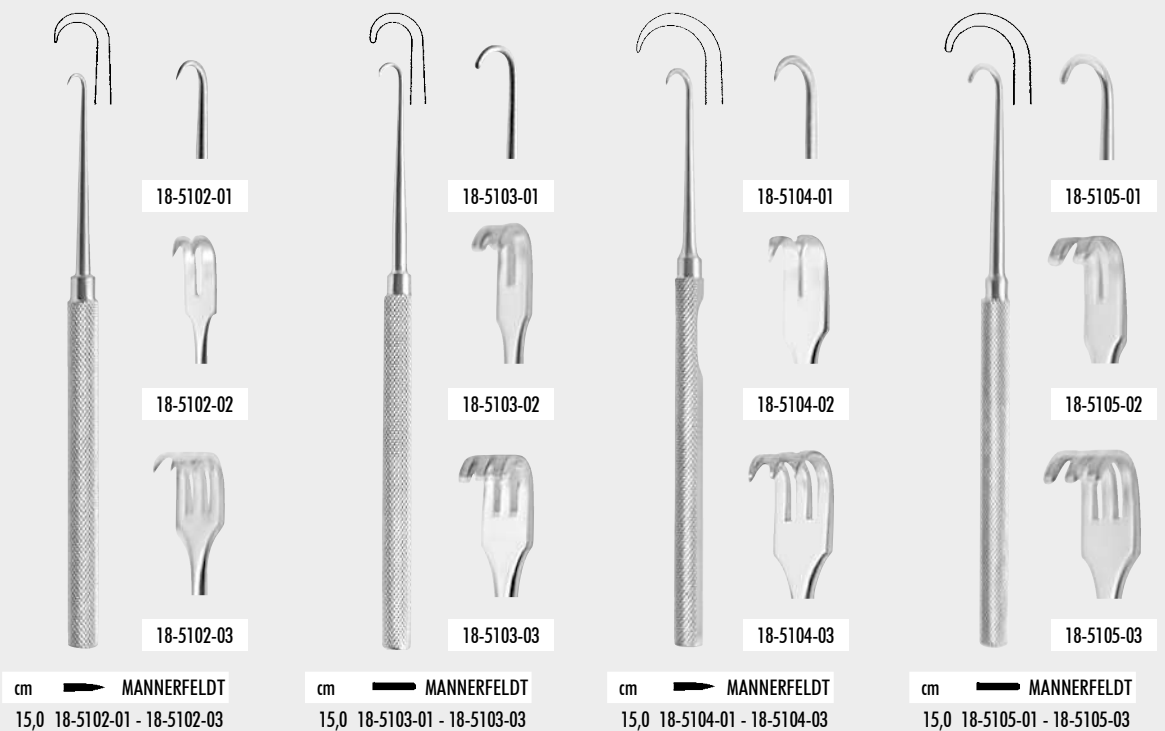

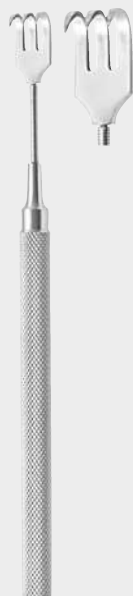

cm  MANNERFELDT
15,0 18-5106-03



cm mm MANNERFELDT
15,0 16 x 6 18-5107-15



cm LANGENBECK MANNERFELDT
15,0 18-5108-15 - 18-5108-30



15 x 6 mm 18-5108-15



20 x 6 mm 18-5108-20



25 x 6 mm 18-5108-25



30 x 6 mm 18-5108-30

Handchirurgie
Hand Surgery
Chirurgie de la main
Cirugía de la mano
Chirurgia della mano

WUNDHAKEN
WUNDSPERRER

RETRACTORS

ÉCARTEURS

SEPARADORES

DIVARICATORI



12 x 12 mm 18-5109-12



cm MANNERFELDT
15,0 18-5109-12 - 18-5109-16



12 x 14 mm 18-5109-14



14 x 16 mm 18-5109-16



cm mm MANNERFELDT
15,0 12 x 12 18-5200-15



cm MANNERFELDT
15,0 18-5201-16

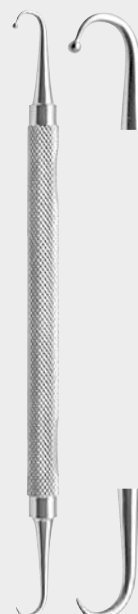

cm MANNERFELDT
15,0 18-5202-16

WUNDHAKEN
WUNDSPERRER

RETRACTORS

ÉCARTEURS

SEPARADORES

DIVARICATORI



cm BERGMANN
14,0 18-5220-14

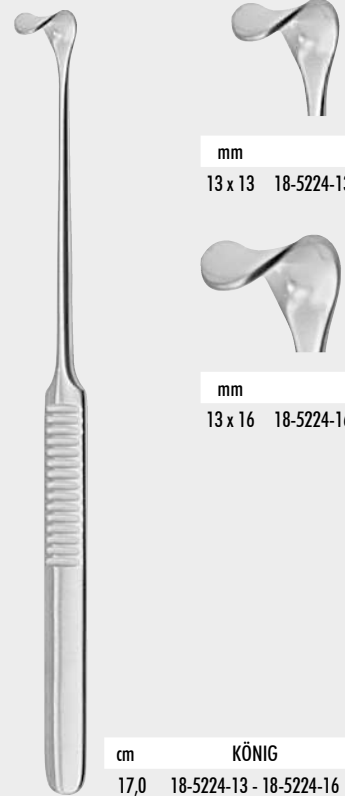

mm
13 x 13 18-5224-13

mm
13 x 16 18-5224-16

cm KÖNIG
17,0 18-5224-13 - 18-5224-16

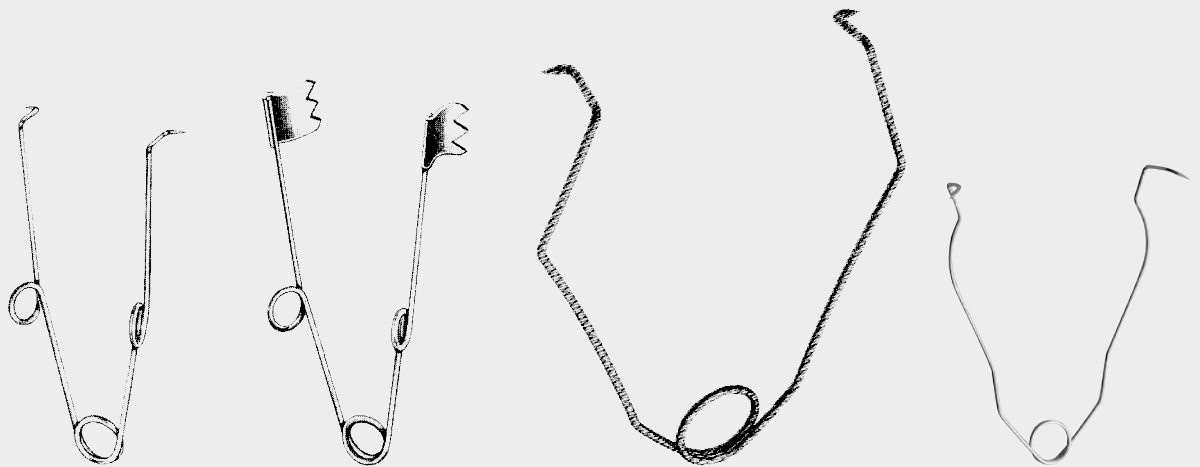

cm
7,5 18-6002-07
11,5 18-6002-11

cm
8,5 18-6003-08
11,5 18-6003-11

cm mm FARR
14,0 19 18-6006-01
14,0 32 18-6006-02
23,0 33 18-6006-03

mm FARR
38 18-6008-38
50 18-6008-50
57 18-6008-57
64 18-6008-64
75 18-6008-75



2x3

cm	FINSEN
5,0	18-6090-05 18-6091-05



3x4

cm	FINSEN modif.
7,0	18-6094-07 18-6095-07

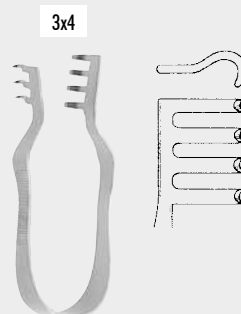

3x4

cm	FINSEN
5,0	18-6100-05 18-6101-05
7,0	18-6100-07 18-6101-07

WUNDHAKEN
WUNDSPERRER

RETRACTORS

ÉCARTEURS

SEPARADORES

DIVARICATORI

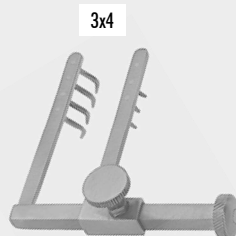

3x4

cm	LOGAN
4,0	18-6102-04

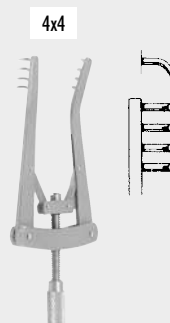

4x4

cm	ALM
7,0	18-6200-07 18-6201-07
10,0	18-6200-10 18-6201-10 *18-6203-10

* halb scharf
semi sharp
demi mousse
semi agudo
semi acuto

ZEPF[®]
α
INSTRUMENTS

WUNDHAKEN
WUNDSPERRER



cm **ALLPORT**
10,0 18-6204-10



cm **JANSEN GIFFORD**
10,0 18-6208-10 18-6209-10



cm **JANSEN**
10,0 18-6300-10



cm **JANSEN**
10,0 18-6301-10

RETRACTORS

ÉCARTEURS

SEPARADORES

DIVARICATORI



cm **WAGNER-JANSEN**
10,0 18-6302-11

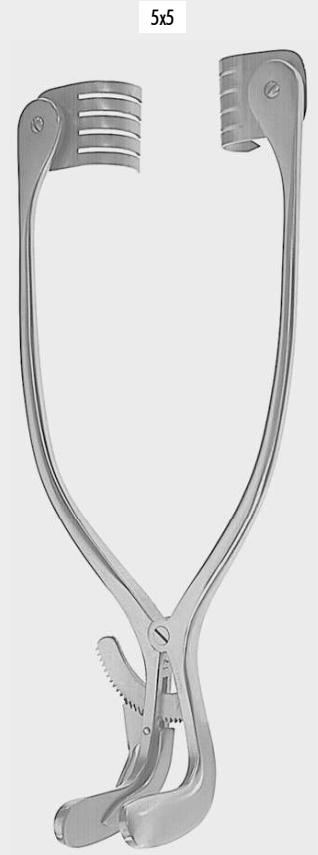

cm **JACKSON**
19,0 18-6324-19
Kropf
Goitre
Bocio
Gozzo



cm **HEISS**
10,0 18-6304-10 18-6305-10



cm **SNITMAN**
10,5 18-6310-10 18-6311-10



cm KOCHER
16,0 18-6400-16

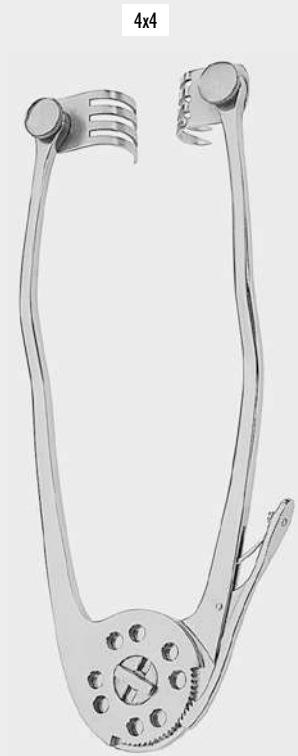

cm CROTTI
18,0 18-6402-18

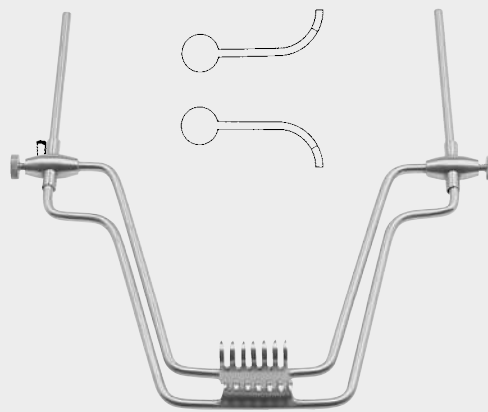

STRUMA
18-6407-00

Kropfsperrer
Goitre Retractors
Écarteurs à goitre
Separadores para bocio
Divaricatori per gozzo

WUNDHAKEN
WUNDSPERRER

RETRACTORS

ÉCARTEURS

SEPARADORES

DIVARICATORI

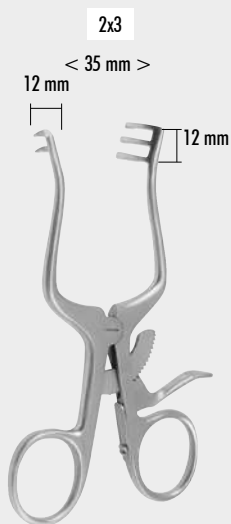

cm WEITLANER
11,5 18-6500-10 18-6501-10

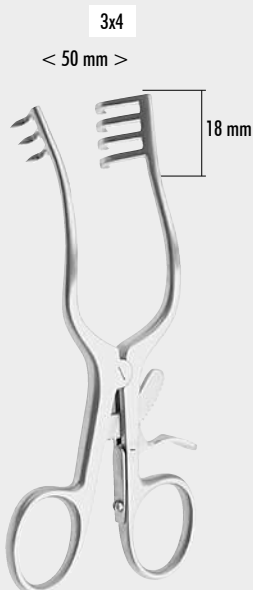

cm WEITLANER-WULLSTEIN
13,0 *18-6503-10 18-6504-13 18-6505-13

* halb scharf
semi sharp
demi mousse
semi agudo
semi acuto



cm « PLESTER
11,0 18-6507-11



cm » PLESTER
11,0 18-6509-11

2x2



cm PLESTER 13,0 18-6510-13 18-6511-13

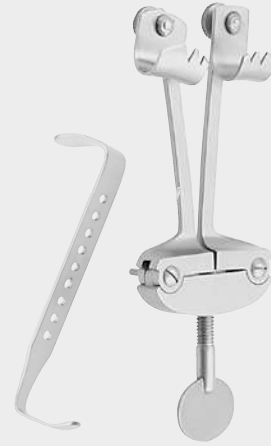

cm HENNER (LEMPERT) 12,0 18-6512-12

WUNDHAKEN
WUNDSPERRER

RETRACTORS

ÉCARTEURS

SEPARADORES

DIVARICATORI

2x2

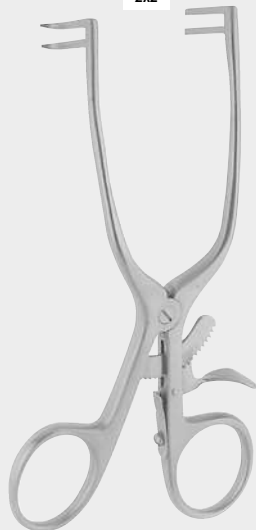

cm MOLLISON 13,0 18-6518-13

2x2



cm SCHUKNECHT 14,0 18-6600-14

3x3



cm MILLIGAN 13,0 18-6680-13



cm WEITLANER
13,0 18-6690-13 18-6691-13

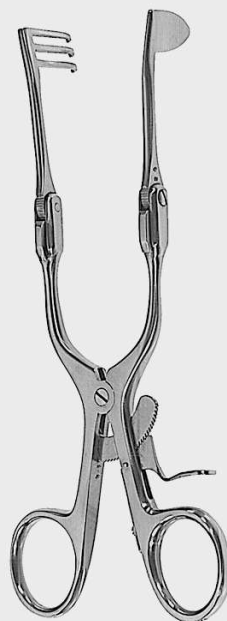

cm « BECKMANN FISH »
16,5 18-6602-16 18-6603-16

WUNDHAKEN
WUNDSPERRER

RETRACTORS

ÉCARTEURS

SEPARADORES



cm WEITLANER BABY
13,0 18-6686-13

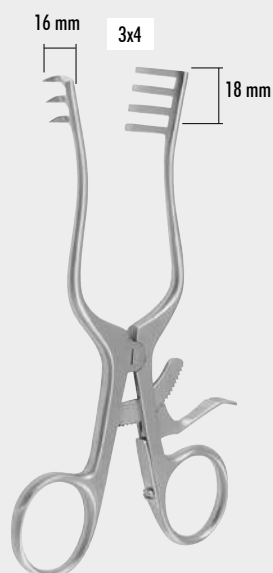

* halb scharf
semi sharp
demi mousse
semi agudo
semi acuto

cm	WEITLANER	
13,0	*18-6698-13	
14,0	18-6700-14	18-6701-14
16,5	*18-6698-16	18-6700-16 18-6701-16
20,0	18-6700-20	18-6701-20
24,0	18-6700-24	18-6701-24

DIVARICATORI

WUNDHAKEN
WUNDSPERRER

RETRACTORS

ÉCARTEURS

SEPARADORES

DIVARICATORI

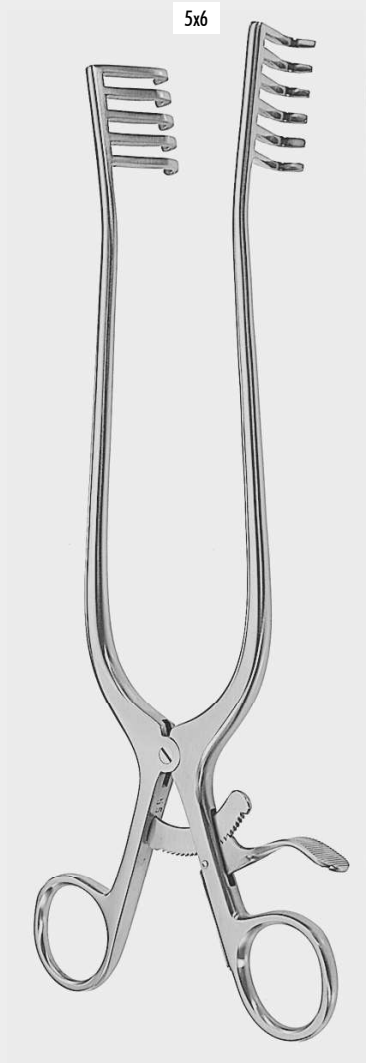

cm	→ WEITLANER ←	→ WEITLANER ←
25,0	18-6700-25	18-6701-25
26,0	18-6700-26	18-6701-26

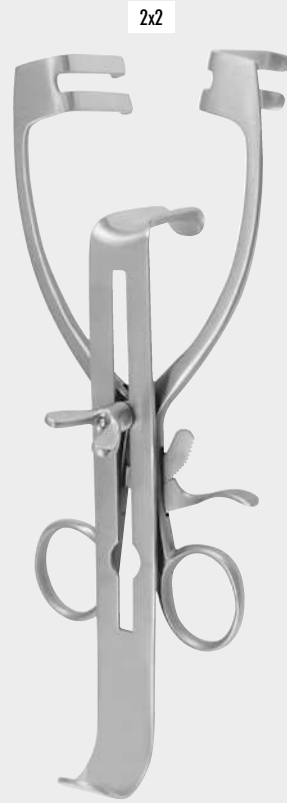

cm	MAYO ADAMS
17,0	18-6702-17
17,0	18-6702-18

mit Mittelblatt
with central blade
avec valve centrale
con valva central
con valva centrale

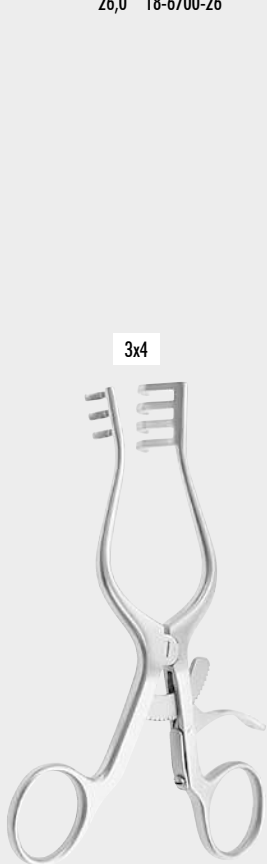

cm	→ CONTOUR SCALP ←	→ CONTOUR SCALP ←
14,0	18-6702-14	18-6703-14



cm	TÜBINGEN
16,5	18-6705-16



cm	MISKIMON CEREBELLUM
22,0	18-6706-22



cm ANDERSON ADSON
 20,0 18-6708-20 18-6709-20

Für Laminektomie - for Laminectomy - pour laminectomie
para laminectomía - per laminectomia



cm WANE
 25,5 18-6709-25

WUNDHAKEN
WUNDSPERRER

RETRACTORS

ÉCARTEURS

SEPARADORES

DIVARICATORI

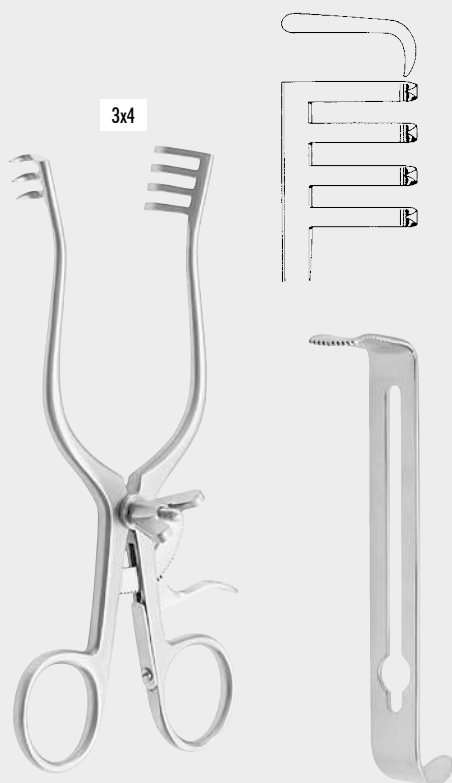

cm HENLY
 16,5 18-6712-16 18-6713-16

Sperrer allein ohne Mittelblatt
Spreader only, without Centre Blade
Écarteur seul, sans valve centrale
Separador suelto, sin valva central
Divaricatore solo, senza valva centrale

mm
 16 x 19 18-6714-19

mm
 16 x 25 18-6714-25

mm
 16 x 32 18-6714-32

Mittelblatt allein - Centre Blade only - Valve centrale seule -
Valva central suelta - Valva centrale sola

WUNDHAKEN
WUNDSPERRER



cm JACKSON BURROWS
18,5 18-6717-18



cm RNTNE HOSPITAL
16,5 18-6790-16

Für Knieweichteile - for Knee Soft Parts - pour parties molles du genou
- para partes blandos de la rodilla - per parti molli del ginocchio

RETRACTORS

ÉCARTEURS

SEPARADORES

DIVARICATORI



cm HENDERSON
17,0 18-6792-17



cm IRWIN
17,0 18-6794-17



cm ADSON
19,0 18-6800-19 18-6801-19

Für Laminektomie - For Laminectomy - pour laminectomie -
para laminectomía - per laminectomia



cm **ADSON**
 26,5 18-6802-26 18-6803-26 3 x 4
 27,0 18-6802-27 18-6803-27 5 x 6

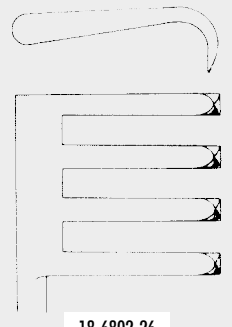

18-6802-26

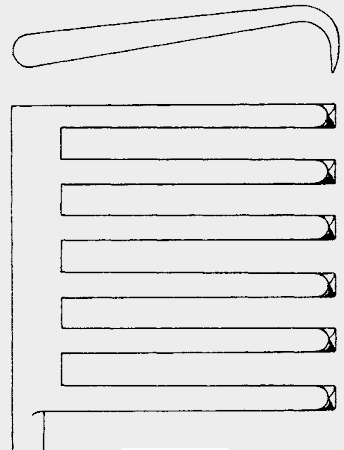

18-6802-27

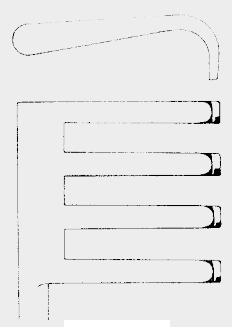

18-6803-26

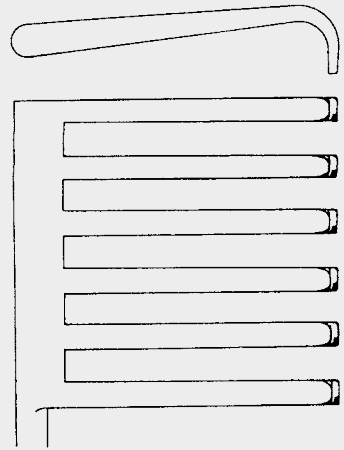

18-6803-27



cm **BECKMANN-ADSON**
 32,0 18-6805-32



cm **TRAVERS**
 21,5 18-6804-21



cm **ADSON**
 27,0 18-6806-27 18-6807-27

Für Hemilaminectomie
 Hemilaminectomy
 Pour hémi laminectomie
 Para hemilaminectomía
 Per emilaminectomia

Laminectomie-Wundspreizer
 Laminectomy Spreaders
 Écarteurs pour laminectomie
 Separadores para laminectomía
 Divaricatori per laminectomia

WUNDHAKEN
 WUNDSPERRER

RETRACTORS

ÉCARTEURS

SEPARADORES

DIVARICATORI

Hemilaminectomie-Wundspreizer
 Hemilaminectomy Spreaders
 Écarteurs pour hémilaminectomie
 Separadores para hemilaminectomía
 Divaricatori per emilaminectomia

WUNDHAKEN
 WUNDSPERRER

RETRACTORS

ÉCARTEURS

SEPARADORES

DIVARICATORI

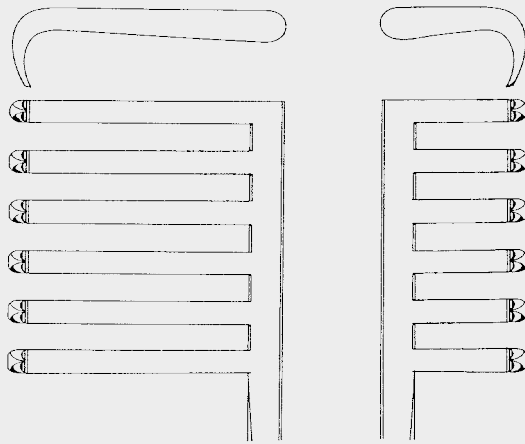

» 18-6808-27

Kurzer Zahn 13 mm rechts
 Short tooth 13 mm right hand side
 Dent courte 13 mm à droite
 Diente corto 13 mm a la derecha
 Dente corto 13 mm a destra

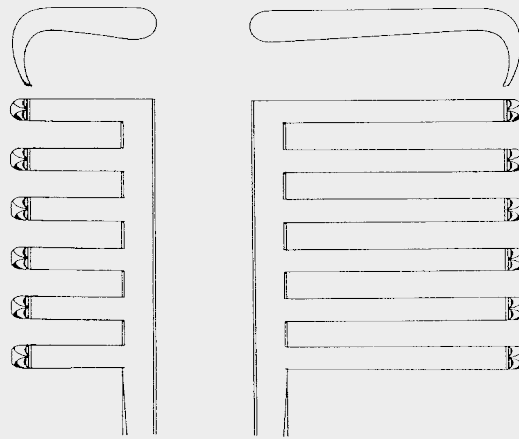

« 18-6809-27

Kurzer Zahn 13 mm links
 Short tooth 13 mm left hand side
 Dent courte 13 mm à gauche
 Diente corto 13 mm a la izquierda
 Dente corto 13 mm a sinistra



cm » «
 27,0 18-6808-27 18-6809-27



4x1

cm	CONE
16,5	18-6880-16
25,5	18-6880-25



1x4

cm	CONE
16,5	18-6882-16
25,5	18-6882-25



3x3

cm	HARVEY JACKSON
28,0	18-6884-28

Laminektomie-Wundspreizer
Laminectomy Spreaders
Écarteurs pour laminectomie
Separadores para laminectomía
Divaricatori per laminectomia

WUNDHAKEN
WUNDSPERRER

RETRACTORS

ÉCARTEURS

SEPARADORES

DIVARICATORI

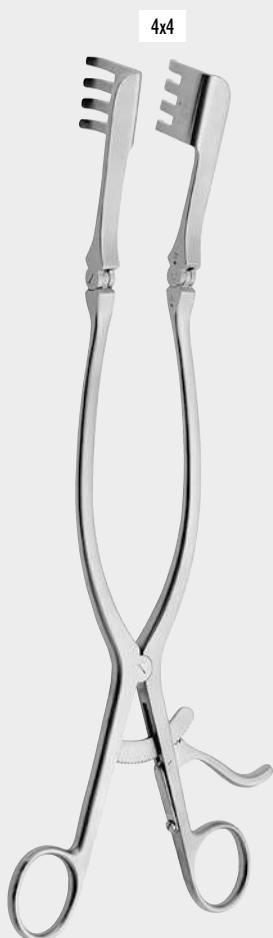

4x4

cm	BECKMANN ADSON
30,5	18-6886-01 - 18-6887-01 25 x 25 mm
30,5	18-6886-02 - 18-6887-02 45 x 25 mm



17 mm < 150 mm >

4x4

26 mm

cm	BECKMANN
31,0	18-6900-31 - 18-6901-31



47 mm

7x7

< 140 mm >

51 mm

cm	BECKMANN-EATON
32,0	18-6902-32



4x4

cm MOLLISON
15,0 18-6903-15

halb scharf
semi sharp
demi-mousse
semi agudo
semi acuto



3x4

cm ADSON BABY
14,0 18-6904-14



WUNDHAKEN
WUNDSPERRER

RETRACTORS

ÉCARTEURS

SEPARADORES

3x4		cm	▶	■	
18 x 13 mm	18 x 18 mm	13,0	18-6904-13	18-6905-13	CONE
18 x 13 mm	18 x 18 mm	16,0	18-6904-16	18-6905-16	CONE (ADSON Baby)
22 x 16 mm	21 x 22 mm	20,0	18-6904-20	18-6905-20	CONE (BECKMANN)
28 x 16 mm	28 x 22 mm	25,0	18-6904-25	18-6905-25	CONE

DIVARICATORI

Poplitea-Spreizer
Spreaders popliteal
Écarteurs poplités
Separadores para poplitea
Divaricatori popliteali

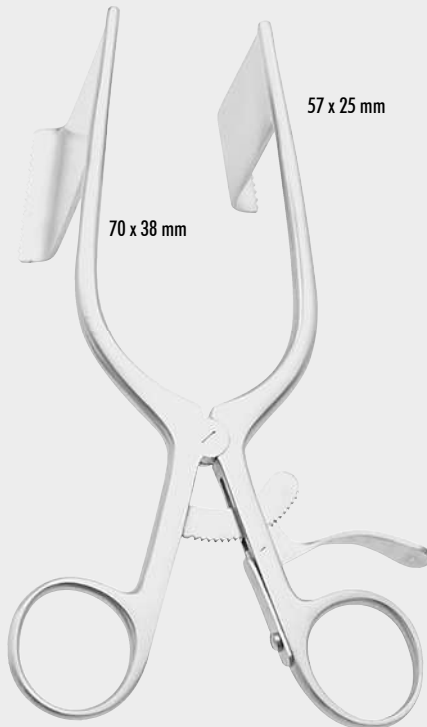

70 x 38 mm

57 x 25 mm

cm DARLING
18,0 18-6906-18

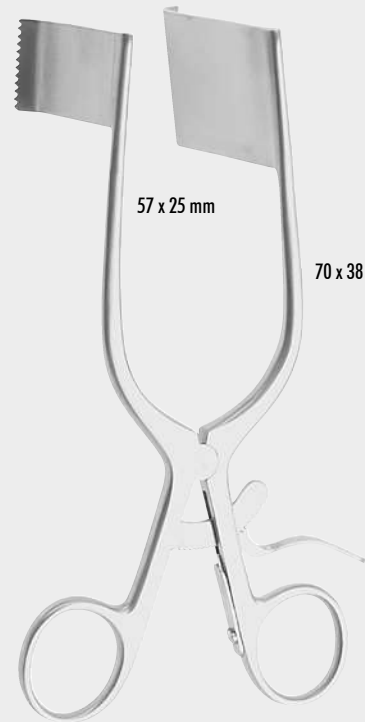

57 x 25 mm

70 x 38 mm

cm DARLING
18,0 18-6908-18



cm NORTHFIELD
29,0 18-7002-29



cm CHARNLEY
28,0 18-7003-28

Horizontal-Spreizer
Horizontal Spreader
Écarteur horizontal
Separador horizontal
Divaricatore orizzontale

WUNDHAKEN
WUNDSPERRER

RETRACTORS

ÉCARTEURS

SEPARADORES

DIVARICATORI



cm » WALTON «
18,0 18-7007-01 18-7007-02

Für Hemilaminektomie - for Hemilaminectomy - pour hénilaminectomie
- para hemilaminectomía - per emilaminectomia



cm » KNIGHTON «
18,0 18-7008-01 18-7008-02

Für Laminektomie - for Laminectomy - pour laminectomie
para laminectomía - per laminectomia

Sperrer für die cervicale Wirbelsäule
 Retractor for Cervical Spine
 Écarteur pour la colonne cervicale
 Separador para la columna cervica
 Divaricatore per la colonna cervicale

WUNDHAKEN
 WUNDSPERRER

RETRACTORS

ÉCARTEURS

SEPARADORES

DIVARICATORI

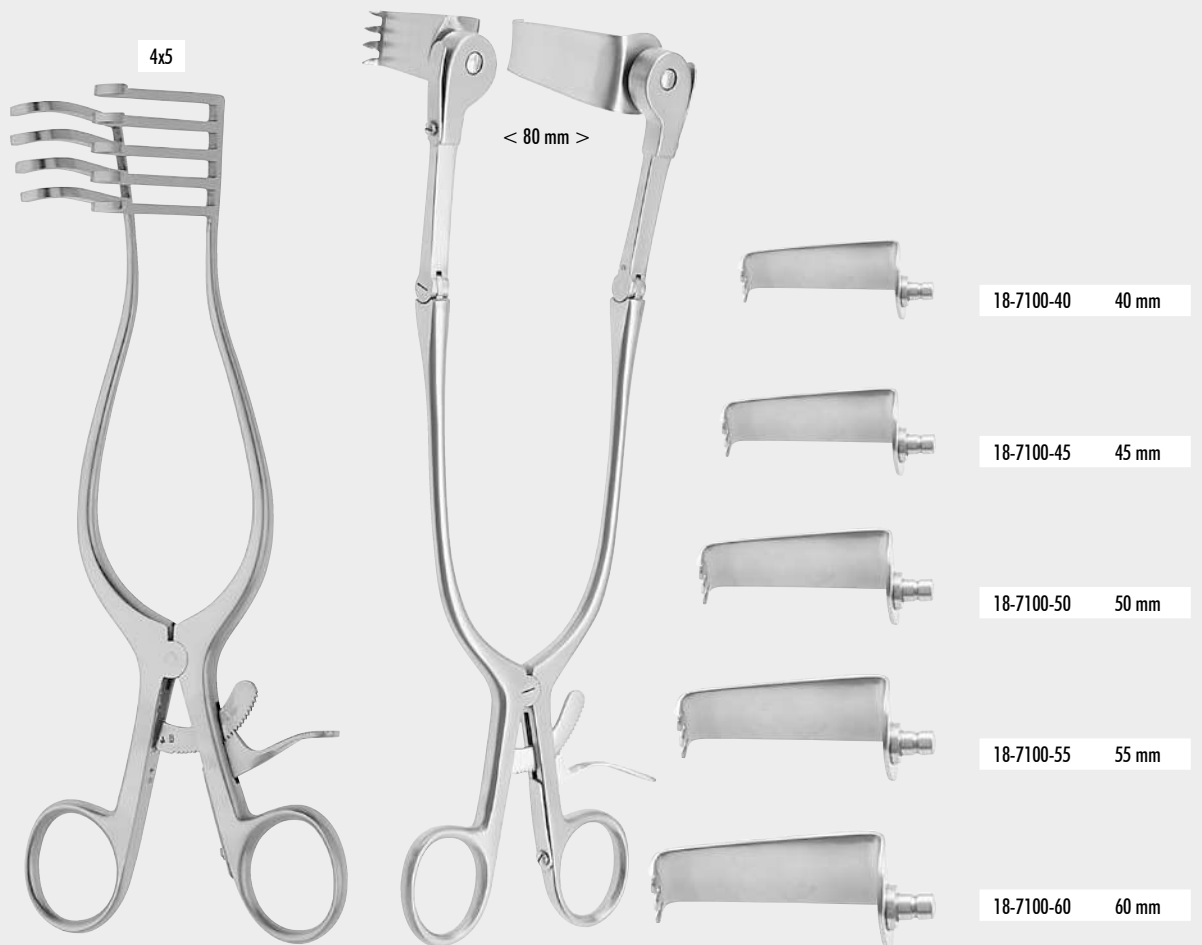

cm NORFOLK AND NORWICH
 22,0 18-7020-21

CLOWARD
 18-7100-00

komplett mit 5 Valven (18-7100-40, 18-7100-45 18-7100-50, 18-7100-55, 18-7100-60)
 Complete with 5 Blades (18-7100-40, 18-7100-45 18-7100-50, 18-7100-55, 18-7100-60)
 Complet avec 5 valves (18-7100-40, 18-7100-45 18-7100-50, 18-7100-55, 18-7100-60)
 Completo con 5 valvas (18-7100-40, 18-7100-45 18-7100-50, 18-7100-55, 18-7100-60)
 Completo di 5 valve (18-7100-40, 18-7100-45 18-7100-50, 18-7100-55, 18-7100-60)

CLOWARD
 18-7100-01

Sperrer allein ohne Valven
 Spreader only without blades
 Écarteur seul sans valves
 Separador suelto sin valvas
 Divaricatore solo senza valve

Sperrer für die cervicale Wirbelsäule
 Retractor for Cervical Spine
 Écarteur pour la colonne cervicale
 Separador para la columna cervical
 Divaricatore per la colonna cervicale

WUNDHAKEN
 WUNDSPERRER

RETRACTORS

ÉCARTEURS

SEPARADORES

DIVARICATORI



CLOWARD
 18-7101-00

CLOWARD
 18-7101-01

komplett mit 5 Valven (18-7101-40, 18-7101-45 18-7101-50, 18-7101-55, 18-7101-60)
 Complete with 5 Blades (18-7101-40, 18-7101-45 18-7101-50, 18-7101-55, 18-7101-60)
 Complet avec 5 valves (18-7101-40, 18-7101-45 18-7101-50, 18-7101-55, 18-7101-60)
 Completo con 5 valvas (18-7101-40, 18-7101-45 18-7101-50, 18-7101-55, 18-7101-60)
 Completo di 5 valve (18-7101-40, 18-7101-45 18-7101-50, 18-7101-55, 18-7101-60)

Sperrer allein ohne Valven
 Spreader only without blades
 Écarteur seul sans valves
 Separador suelto sin valvas
 Divaricatore solo senza valve

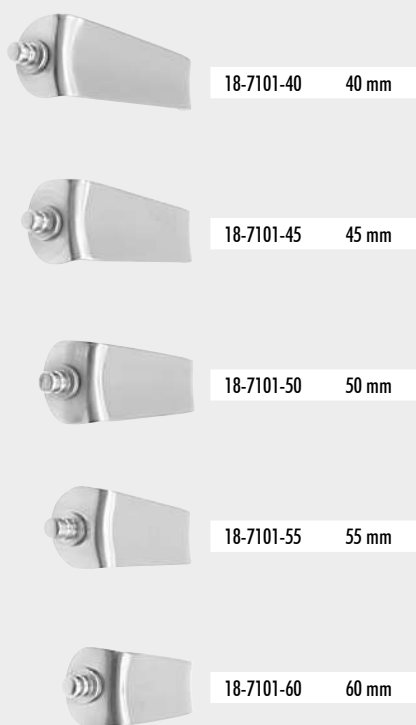

Hemilaminectomie-Sperrer
Hemilaminectomy Retractors
Écarteurs à hémilaminectomie
Separadores para hemilaminectomía
Divaricatori per emilaminectomia

WUNDHAKEN
WUNDSPERRER

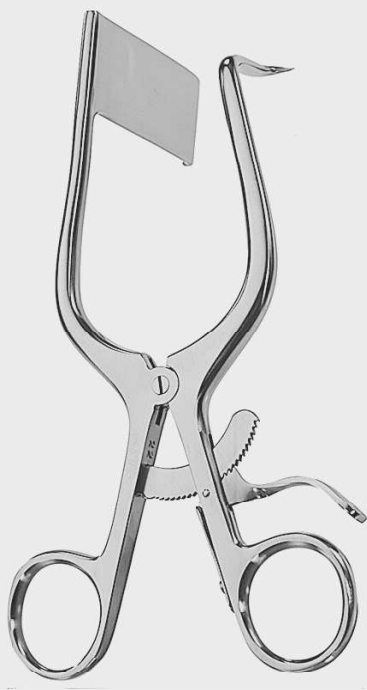

cm » MARKHAM MEYERDING «
18,0 18-7102-18 18-7103-18

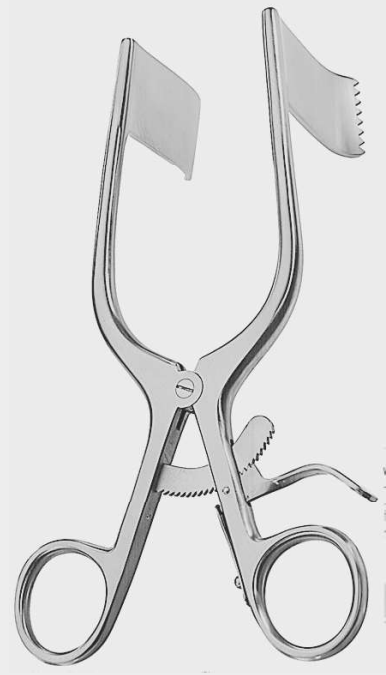

mm MEYERDING 18,0 cm
32 x 25 18-7104-32
54 x 25 18-7104-54
60 x 25 18-7104-60
60 x 19 18-7104-61

RETRACTORS

ÉCARTEURS

SEPARADORES

DIVARICATORI



CASPAR



	CASPAR
18-7200-40	40 x 23 mm
18-7200-45	45 x 23 mm
18-7200-50	50 x 23 mm
18-7200-55	55 x 23 mm
18-7200-60	60 x 23 mm
18-7200-65	65 x 23 mm
18-7200-75	72 x 23 mm

	CASPAR
18-7203-45	45 x 25 mm
18-7203-50	50 x 25 mm
18-7203-55	55 x 25 mm
18-7203-60	60 x 25 mm
18-7203-65	65 x 25 mm

	CASPAR medial
18-7204-40	40 x 23 mm
18-7204-45	45 x 23 mm
18-7204-50	50 x 23 mm
18-7204-55	55 x 23 mm
18-7204-60	60 x 23 mm

	CASPAR medial
18-7207-40	40 x 25 mm
18-7207-45	45 x 25 mm
18-7207-50	50 x 25 mm
18-7207-55	55 x 25 mm
18-7207-60	60 x 25 mm

	CASPAR lateral
18-7205-40	40 x 23 mm
18-7205-45	45 x 23 mm
18-7205-50	50 x 23 mm
18-7205-55	55 x 23 mm
18-7205-60	60 x 23 mm

	CASPAR lateral
18-7208-40	40 x 25 mm
18-7208-45	45 x 25 mm
18-7208-50	50 x 25 mm
18-7208-55	55 x 25 mm
18-7208-60	60 x 25 mm

	CASPAR
18-7206-50	50 x 25 mm
18-7206-60	60 x 25 mm

	CASPAR
18-7209-50	50 x 25 mm
18-7209-60	60 x 25 mm

18-7191-00 compl. 18-7191-15 / 18-7200-45 / 18-7200-50 / 18-7200-55 / 18-7200-60 / 18-7200-65
mit 5 Valven - with 5 blades - avec 5 valves - con 5 valvas - con 5 valve

18-7191-15 Gegensperrer allein - Counter-Retractor only - Contre-écarteur seul - Contra-separador suelto - Contra-divaricatore solo



CASPAR medial	
18-7204-40	40 x 23 mm
18-7204-45	45 x 23 mm
18-7204-50	50 x 23 mm
18-7204-55	55 x 23 mm
18-7204-60	60 x 23 mm



CASPAR lateral	
18-7205-40	40 x 23 mm
18-7205-45	45 x 23 mm
18-7205-50	50 x 23 mm
18-7205-55	55 x 23 mm
18-7205-60	60 x 23 mm

CASPAR medial	
18-7207-40	40 x 25 mm
18-7207-45	45 x 25 mm
18-7207-50	50 x 25 mm
18-7207-55	55 x 25 mm
18-7207-60	60 x 25 mm

CASPAR lateral	
18-7208-40	40 x 25 mm
18-7208-45	45 x 25 mm
18-7208-50	50 x 25 mm
18-7208-55	55 x 25 mm
18-7208-60	60 x 25 mm

Wundspreizer für die cervicale Wirbelsäule
Retractors for Cervical Spine
Écarteurs pour la colonne cervicale
Separadores para la columna cervical
Divaricatori per la colonna cervicale

WUNDHAKEN
WUNDSPERRER

RETRACTORS

ÉCARTEURS

SEPARADORES

DIVARICATORI



CASPAR	
18-7193-00	compl.
18-7193-12	allein

mit 2 x 5 Valven - with 2 x 5 blades - avec 2 x 5 valves - con 2 x 5 valvas - con 2 x 5 valve
- only - seul - suelto - solo

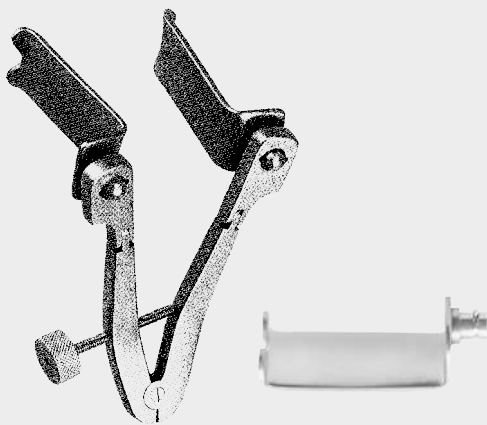
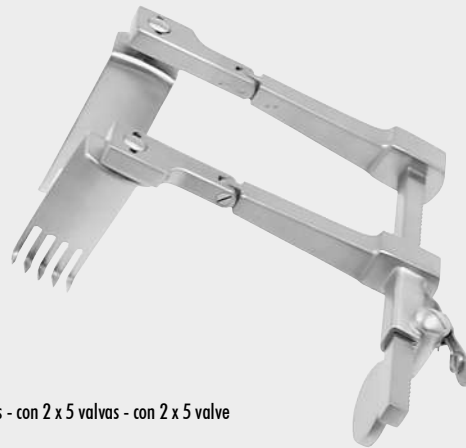

CASPAR	
18-7200-45	45 x 23 mm
18-7200-50	50 x 23 mm
18-7200-55	55 x 23 mm
18-7200-60	60 x 23 mm
18-7200-65	65 x 23 mm

CASPAR	
18-7203-45	45 x 25 mm
18-7203-50	50 x 25 mm
18-7203-55	55 x 25 mm
18-7203-60	60 x 25 mm
18-7203-65	65 x 25 mm

CASPAR
18-7195-00 compl. mit 5 Valven - compl. with 5 blades - complet avec 5 valves - completo con 5 valvas - completo di 5 valve
18-7195-11 Sperrer (Spekulumauführung) allein - Retractor (Speculum pattern) only - Écarteur (modèle spéculum) seul
Separador (modelo espéculo) suelto - Divaricatore (modello specolo) solo



cm	
11,0	18-7198-11

Pinzette zum Blattwechsel
Forceps to exchange blades
Pince pour changer les valves
Pinza para cambiar valvas
Pinza per cambiare valve

Sperrer für die Laminectomie
 Spreaders for Laminectomy
 Écarteurs par la laminectomie
 Separadores para laminectomía
 Divaricatori per laminectomia

WUNDHAKEN WUNDSPERRER

RETRACTORS

ÉCARTEURS

SEPARADORES

DIVARICATORI

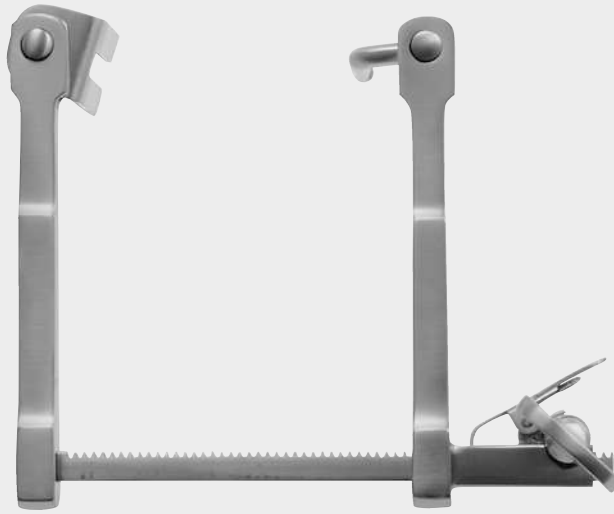

CASPAR

18-7300-00 compl.

mit je 1 - with 1 ea. - avec 1 chacun - con 1 c/u - con 1 ciascuno:
 18-7301-50, 18-7302-40, 18-7302-45, 18-7302-50, 18-7302-55, 18-7302-60



CASPAR

18-7301-50 50 mm



CASPAR

18-7301-70 70 mm



CASPAR

18-7302-35 35 x 22 mm

18-7302-40 40 x 22 mm

18-7302-45 45 x 22 mm

18-7302-50 50 x 22 mm

18-7302-55 55 x 22 mm

18-7302-60 60 x 22 mm

18-7302-65 65 x 22 mm

18-7302-70 70 x 22 mm



CASPAR

18-7300-15

Sperrer allein - Spreader only - Écarteur seul
 Separador suelto - Divaricatore solo



CASPAR

18-7303-35 35 x 37 mm

18-7303-40 40 x 37 mm

18-7303-45 45 x 37 mm

18-7303-50 50 x 37 mm

18-7303-55 55 x 37 mm

18-7303-60 60 x 37 mm

18-7303-65 65 x 37 mm

18-7303-70 70 x 37 mm



CASPAR

18-7304-35 35 x 52 mm

18-7304-40 40 x 52 mm

18-7304-45 45 x 52 mm

18-7304-50 50 x 52 mm

18-7304-55 55 x 52 mm

18-7304-60 60 x 52 mm

18-7304-65 65 x 52 mm

18-7304-70 70 x 52 mm

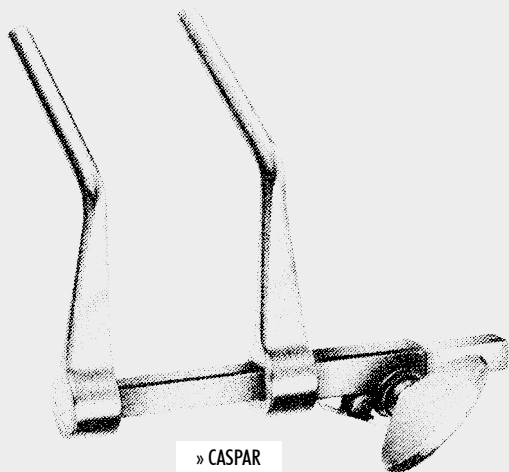

» CASPAR
18-7306-01

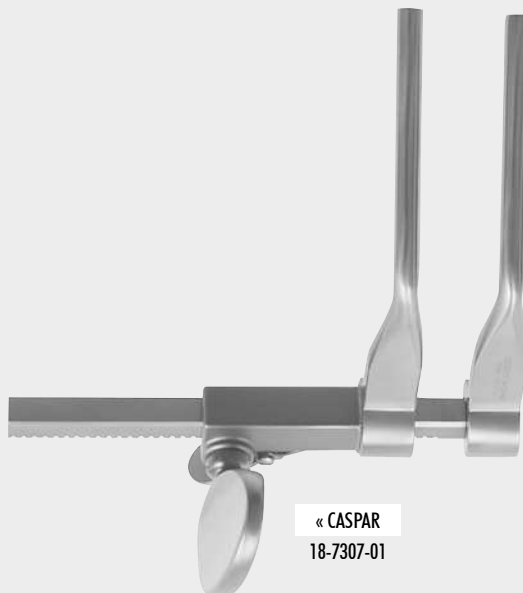

« CASPAR
18-7307-01

18-7306-00 CASPAR Wirbelkörperdistraktor für Op an unterer und mittlerer Halswirbelsäule von rechts, bestehend aus:
 CASPAR vertebral body distractor for use in surgical procedures of the cervical spine from the right, consisting of:
 CASPAR distracteur des corps vertébraux pour la chirurgie de la colonne cervicale, accès du côté droit, composé de:
 CASPAR distractor de los cuerpos vertebrales para la cirugía de la columna cervical, acceso del lado derecho, compuesto de:
 CASPAR distrattore dei corpi vertebrali per la chirurgia della colonna cervicale, acceso del lato destro, composto da:
 18-7306-01, 18-7306-02, 18-7306-10, 18-7306-16 (2x), 18-7306-20

18-7307-00 dito, von links - idem, from the left - idem, du côté gauche - idem, del lado izquierdo - detto, del lato sinistro:
 18-7307-01, 18-7307-02, 18-7306-10, 18-7306-16 (2x), 18-7306-20

CASPAR Distraktoren
 CASPAR Distactors
 CASPAR Distracteurs
 CASPAR Distractores
 CASPAR Distrattori

WUNDHAKEN
 WUNDSPERRER

RETRACTORS

ÉCARTEURS

SEPARADORES

DIVARICATORI

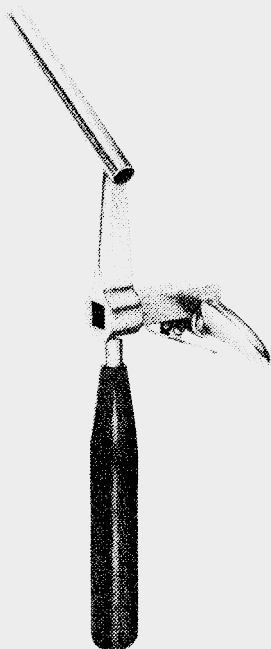

» CASPAR
18-7306-02

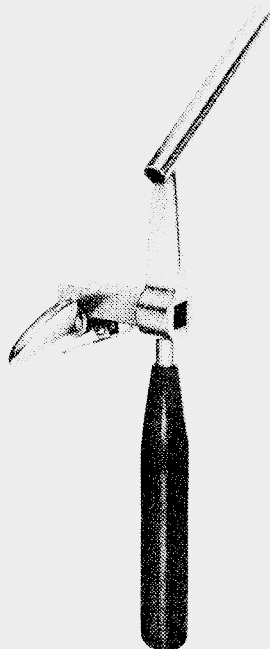

« CASPAR
18-7307-02



cm CASPAR
14,5 18-7306-10



mm CASPAR
14,0 18-7306-14
16,0 18-7306-16
18,0 18-7306-18



cm CASPAR
20,0 18-7306-20

Bohrerführungen allein, rechts - links
 Drill Guides only, right - left side
 Guides de forets, à droite - à gauche
 Guías de perforadores, a la derecha - a la izquierda
 Guide di perforatori, destra - sinistra

Spiralbohrer
 Twist Drill
 Foret
 Perforador
 Perforatore

Distraktions-Schrauben
 Distraction Screws
 Vis de distraction
 Tornillos de distracción
 Viti di distrazione

Schraubendreher
 ScrewDriver
 Tournevis
 Destornillador
 Giravite



Wundspreizer zur Mikrodiskektomie
 Retractors for Micro-Lumbar Discectomy
 Écarteurs pour la micro-disquectomie lombaire
 Separadores para la microdissectomía lumbar
 Divaricatori per la micro dissectomia lombare

WUNDHAKEN WUNDSPERRER

RETRACTORS

ÉCARTEURS

SEPARADORES

DIVARICATORI



18-7308-35*	35 mm
18-7308-40*	40 mm
18-7308-45*	45 mm
18-7308-50*	50 mm
18-7308-55*	55 mm
18-7308-60*	60 mm
18-7308-65	65 mm
18-7308-75	75 mm
18-7308-85	85 mm

CASPAR

18-7308-00 compl.* mit 6 Valven - with 6 blades - avec 6 valves - con 6 valvas - con 6 valve

18-7308-01 Gegensperrerr allein

Counter-Retractor only

Contre-écarteur seul

Contra-separador suelto

Contra-divaricatore solo

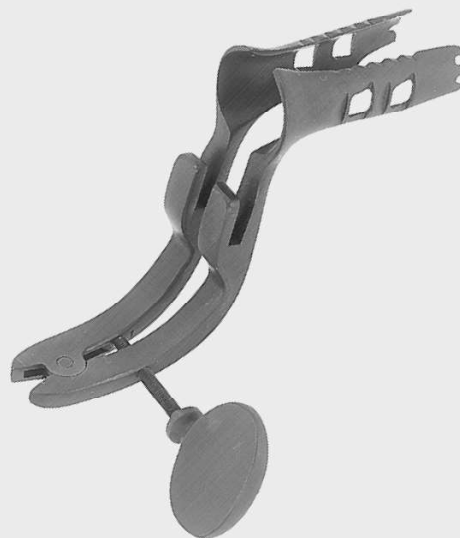

Blattlänge
 Length of Blade
 Longueur de la valve
 Largo de la valva
 Lunghezza della valva

18-7310-40	40 mm
18-7310-45	45 mm
18-7310-50	50 mm
18-7310-55	55 mm
18-7310-60	60 mm
18-7310-65	65 mm
18-7310-75	75 mm
18-7310-85	85 mm

CASPAR

18-7310-40 - 18-7310-85

3x3



cm CAIRNS
14,5 18-7490-14

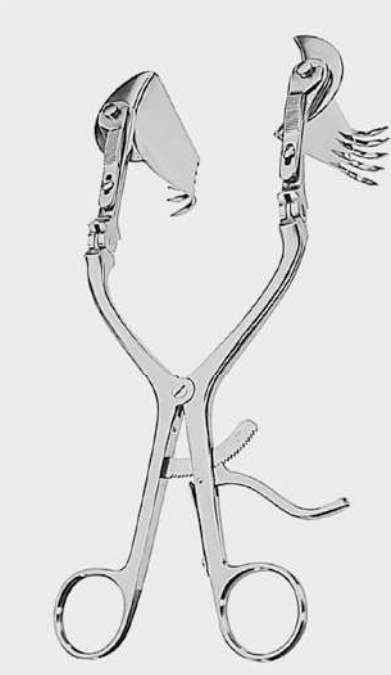

cm CLOWARD HOEN
31,0 18-7501-25



2x2



cm HOEN
27,0 18-7503-27

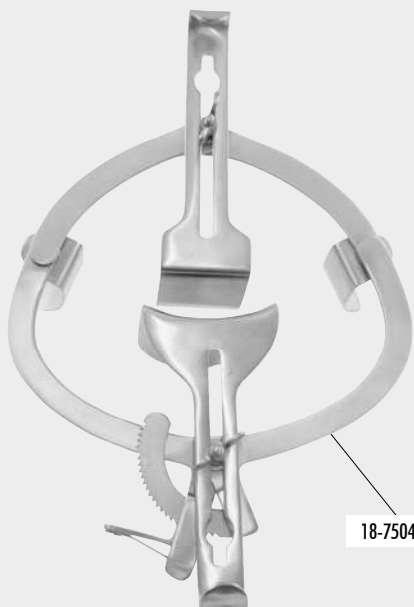

18-7504-10

O'SULLIVAN-O'CONNOR
18-7504-00 - 18-7504-10



1 18-7504-01 110 x 70 mm

2 18-7504-02 80 x 45 mm

3 18-7504-03 80 x 45 mm

Cervical-Sperrer
Cervical Spreaders
Écarteurs cervicaux
Separadores cervicales
Divaricatori cervicali

WUNDHAKEN
WUNDSPERRER

RETRACTORS

ÉCARTEURS

SEPARADORES

DIVARICATORI

Bauchdeckenhalter
Abdominal Retractors
Écarteurs abdominaux
Separadores abdominales
Divaricatori addominali

Bauchdeckenhalter
 Abdominal Retractor
 Écarteur abdominal
 Separador abdominal
 Divaricatore addominale

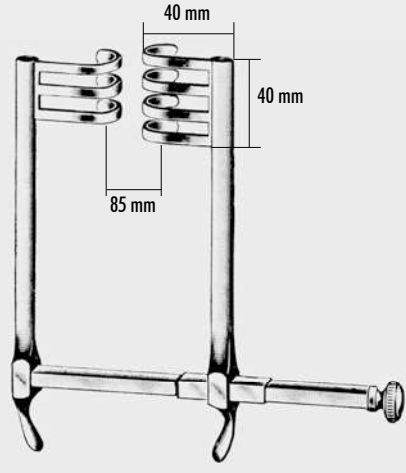

cm FRAZIER
 8,5 18-7508-85

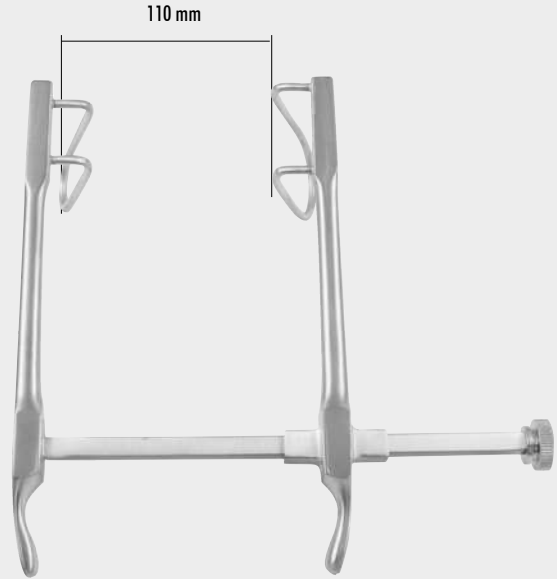

cm GOSSET
 11,0 18-7600-10

WUNDHAKEN
 WUNDSPERRER

RETRACTORS

ÉCARTEURS

SEPARADORES

DIVARICATORI

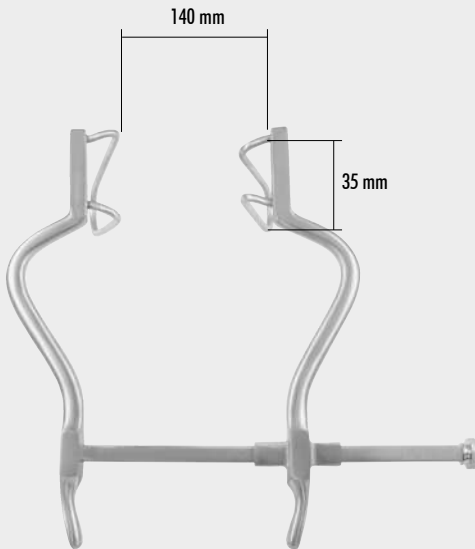

GOSSET
 18-7600-14

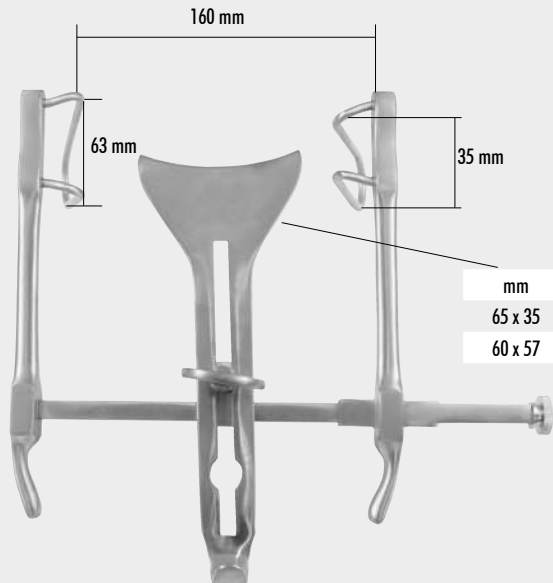

cm GOSSET
 16,0 18-7602-16

mm
 65 x 35 18-7602-21
 60 x 57 18-7602-22

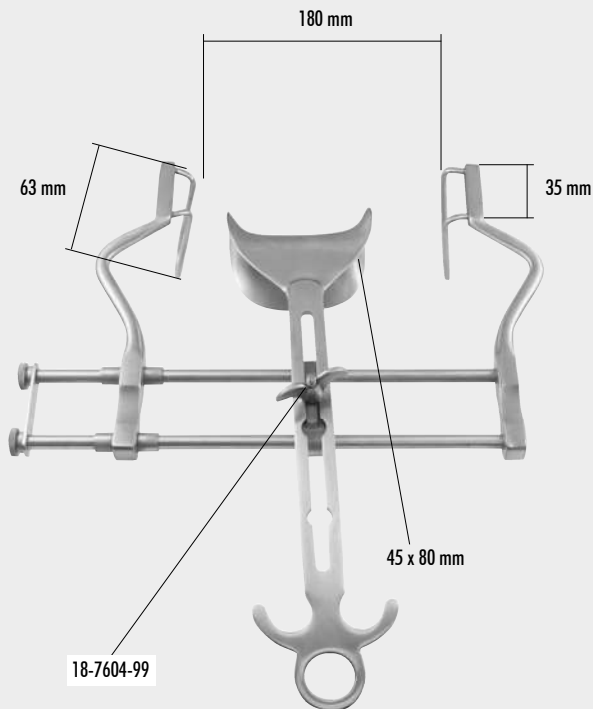

cm BALFOUR
18,0 18-7604-18

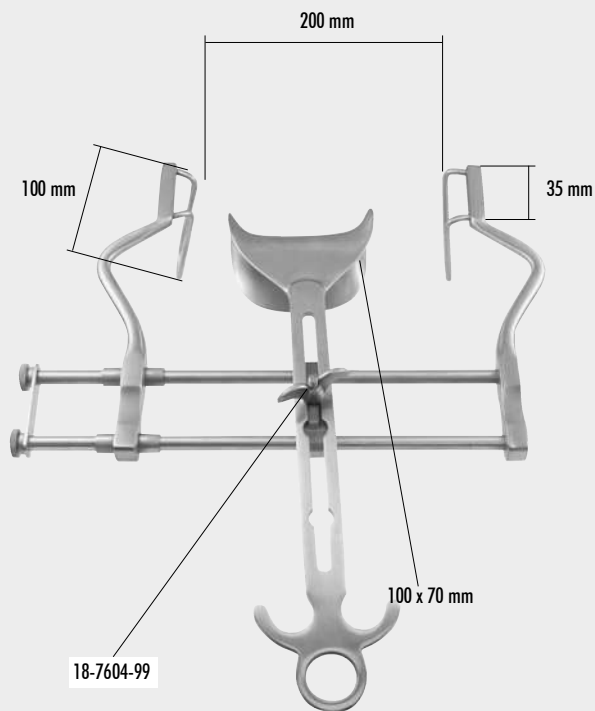

cm BALFOUR
20,0 18-7604-20

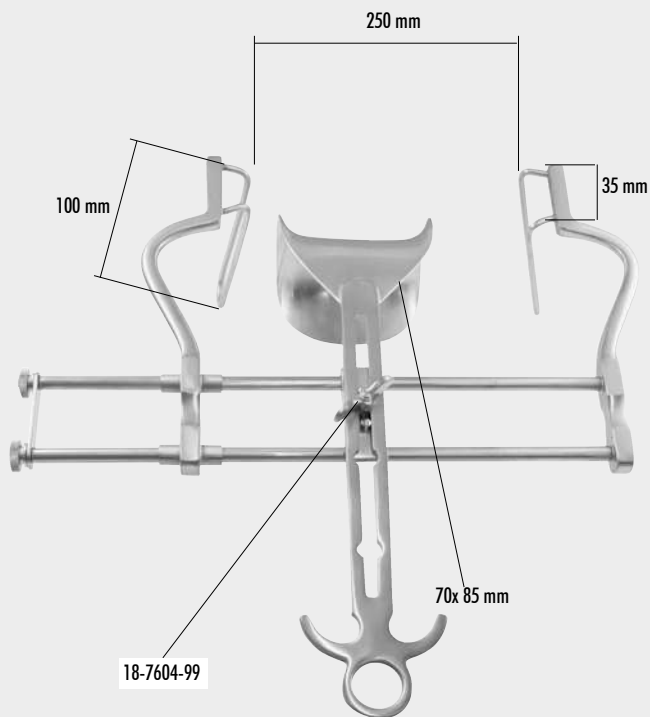

cm BALFOUR
25,0 18-7604-25



mm HORGAN
125 x 54 18-7607-12

mm	BALFOUR
40 x 68	18-7605-40
45 x 80	18-7605-45
68 x 85	18-7605-68
70 x 85	18-7605-70
80 x 90	18-7605-80
100 x 70	18-7605-90

Bauchdeckenhalter
Abdominal Retractors
Écarteurs abdominaux
Separadores abdominales
Divaricatori addominali

WUNDHAKEN
WUNDSPERRER

RETRACTORS

ÉCARTEURS

SEPARADORES

DIVARICATORI

Bauchdeckenhalter
Abdominal Retractors
Écarteurs abdominaux
Separadores abdominales
Divaricatori addominali

WUNDHAKEN
WUNDSPERRER

RETRACTORS

ÉCARTEURS

SEPARADORES

DIVARICATORI

Bauchdeckenhalter, Draht-Valven
Abdominal Retractors, Wire Blades
Écarteurs abdominaux, Valves en fil métallique
Separadores abdominales, vlvavas de hilo metálico
Divaricatori addominali, Valve in filo metallico

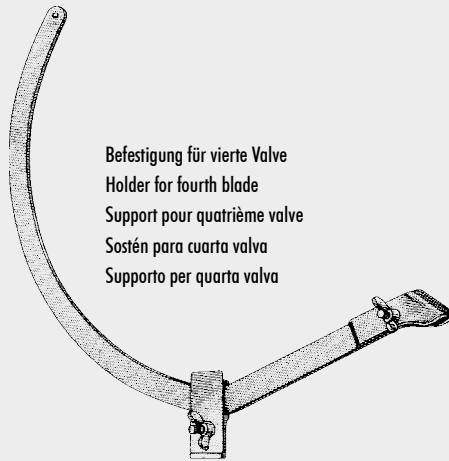

Befestigung für vierte Valve
Holder for fourth blade
Support pour quatrième valve
Sostén para cuarta valva
Supporto per quarta valva

» BALFOUR «
18-7608-02 18-7608-03



cm BALFOUR
18,0 18-7610-18

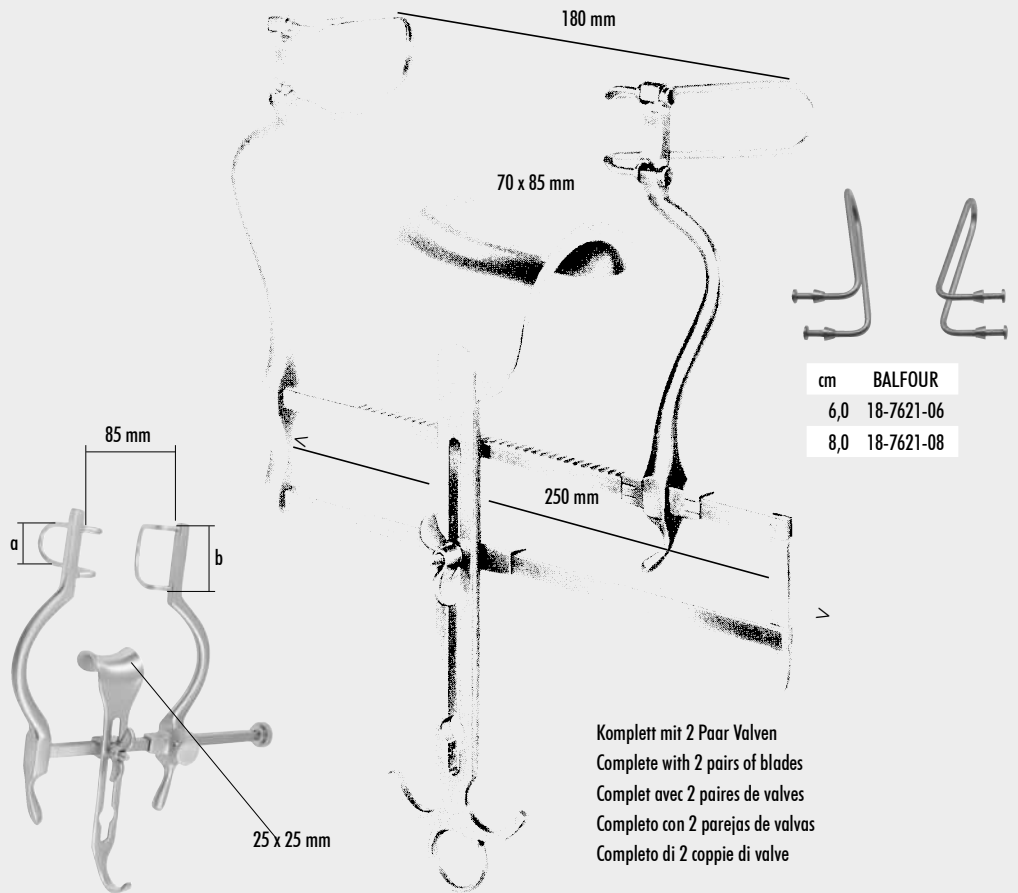

cm BALFOUR
6,0 18-7621-06
8,0 18-7621-08

Komplett mit 2 Paar Valven
Complete with 2 pairs of blades
Complet avec 2 paires de valves
Completo con 2 parejas de valvas
Completo di 2 coppie di valve

cm BALFOUR Baby
9,0 18-7610-90
a 27 x 28
b 20 x 28

cm BALFOUR US
25,0 18-7620-25

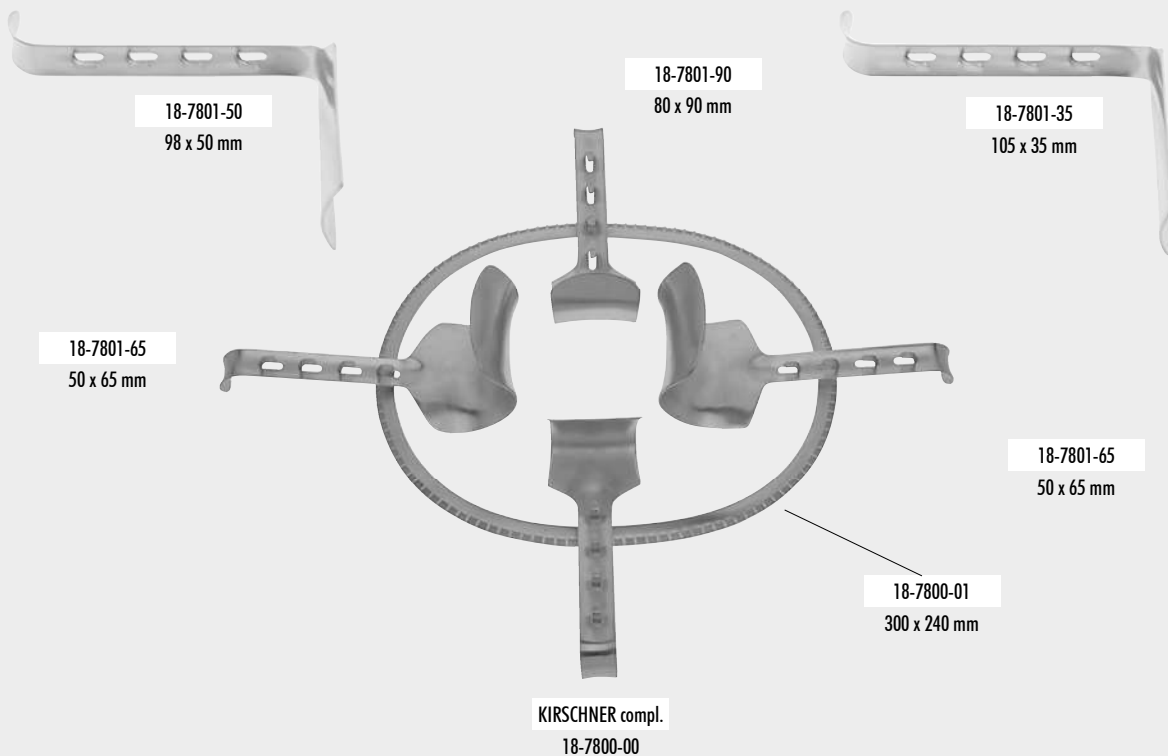

Bauchdeckenhalter
Abdominal Retractors
Écarteurs abdominaux
Separadores abdominales
Divaricatori addominali

WUNDHAKEN
WUNDSPERRER

RETRACTORS

ÉCARTEURS

SEPARADORES

DIVARICATORI

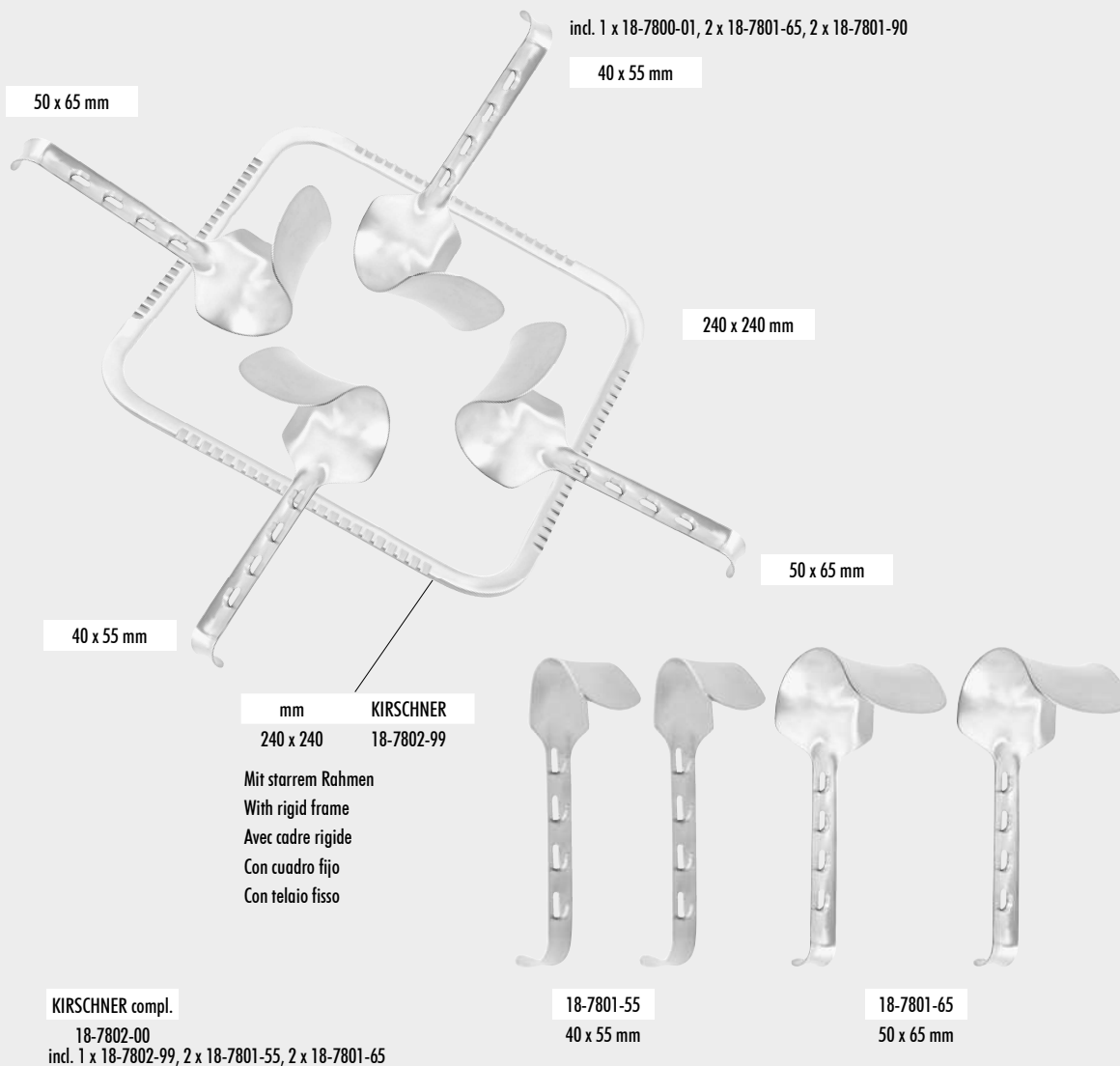



Bauchdeckenhalter
Abdominal Retractors
Écarteurs abdominaux
Separadores abdominales
Divaricatori addominali

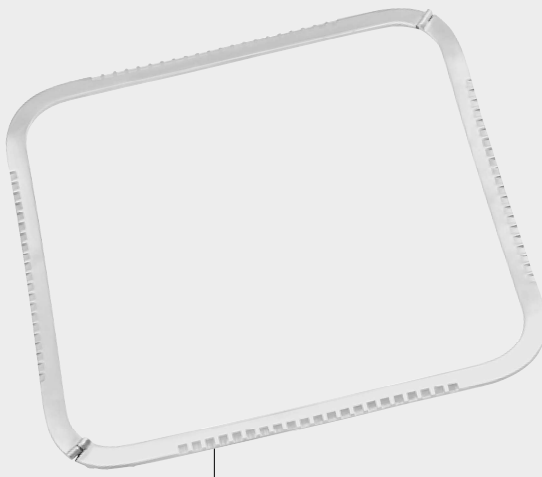

mm	KIRSCHNER
250 x 250	18-7804-01

Mit zusammenlegbarem Rahmen
With folding frame
Avec cadre pliant
Con quadro piegabile
Con telaio pieghevole



18-7801-55
40 x 55 mm

18-7801-65
50 x 65 mm

KIRSCHNER compl.
18-7804-00
incl. 1 x 18-7804-01, 2 x 18-7801-55, 2 x 18-7801-65

**WUNDHAKEN
WUNDSPERRER**

RETRACTORS

ÉCARTEURS

SEPARADORES

DIVARICATORI

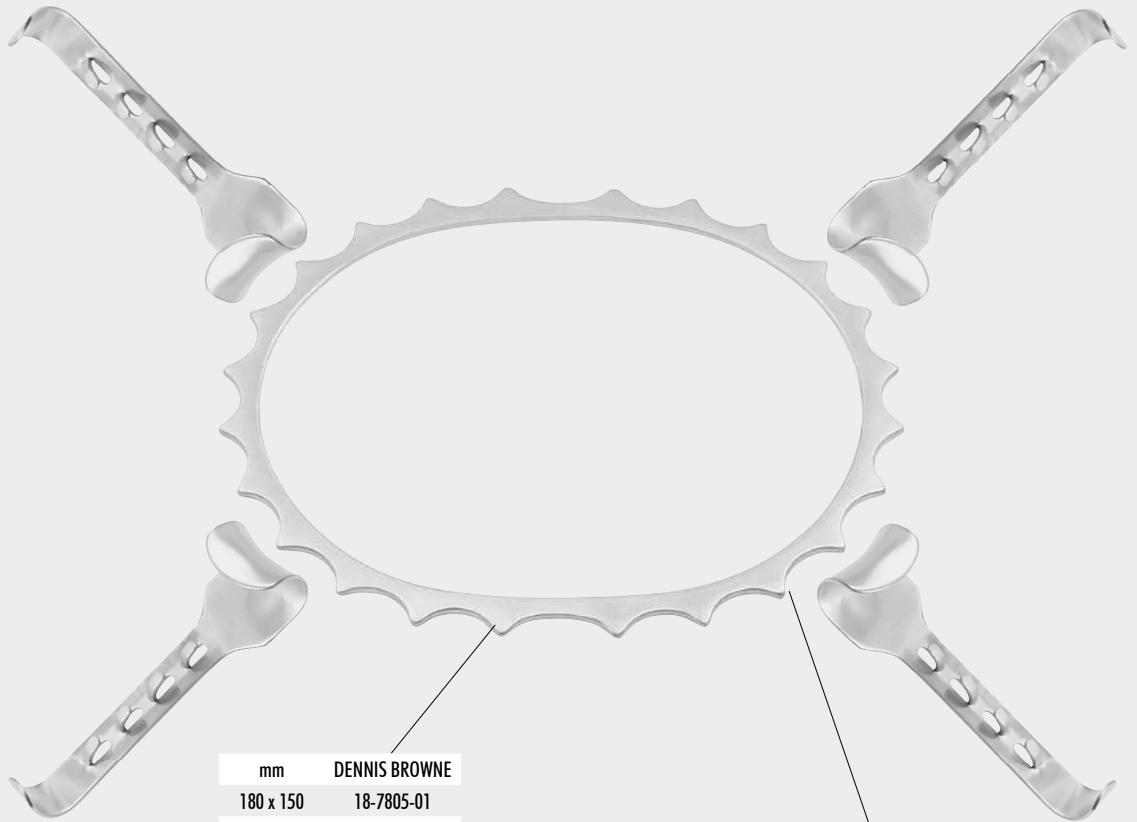

mm	DENNIS BROWNE
180 x 150	18-7805-01
255 x 180	18-7805-02

mm	
13 x 13	18-7805-13
40 x 30	18-7805-30
20 x 30	18-7805-31
38 x 38	18-7805-38
40 x 40	18-7805-40
20 x 40	18-7805-41
64 x 19	18-7805-64

DENNIS BROWNE compl.
18-7805-00
incl. 1 x 18-7805-01, 2 x 18-7805-30, 2 x 18-7805-40



Bauchdeckenhalter, Rahmen allein
 Abdominal Retractors, Frames only
 Écarteurs abdominaux, cadres seuls
 Separadores abdominales cuadros sueltos
 Divaricatori addominali, telai soli

WUNDHAKEN WUNDSPERRER

RETRACTORS

ÉCARTEURS

SEPARADORES

DIVARICATORI

ZEPF®

 INSTRUMENTS

18-7808-05

18.63

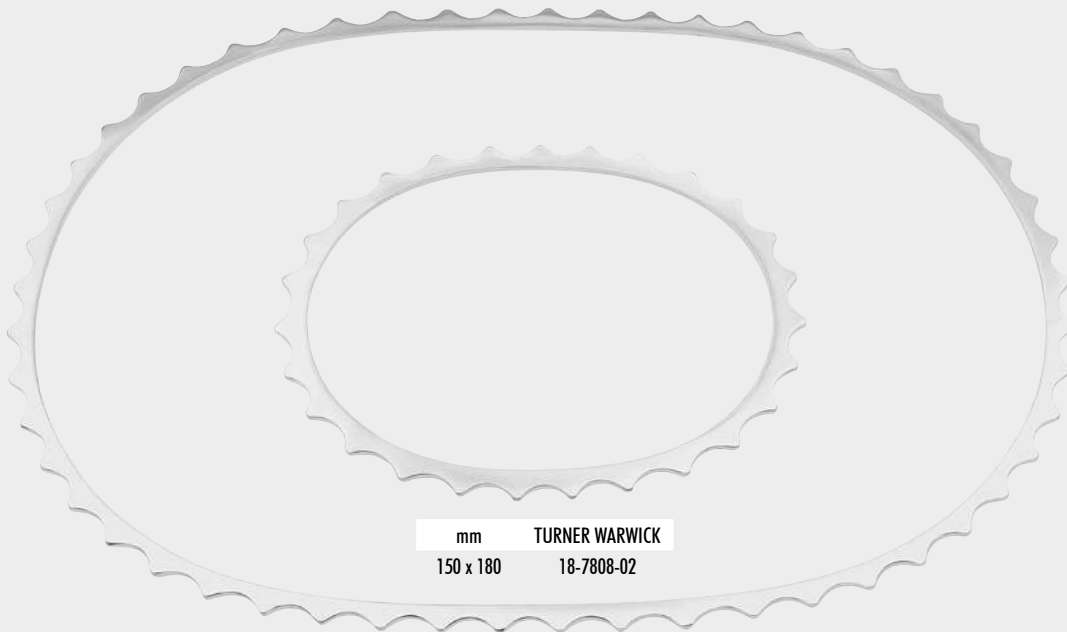

mm	TURNER WARWICK
150 x 180	18-7808-02

mm	TURNER WARWICK
300 x 400	18-7808-01

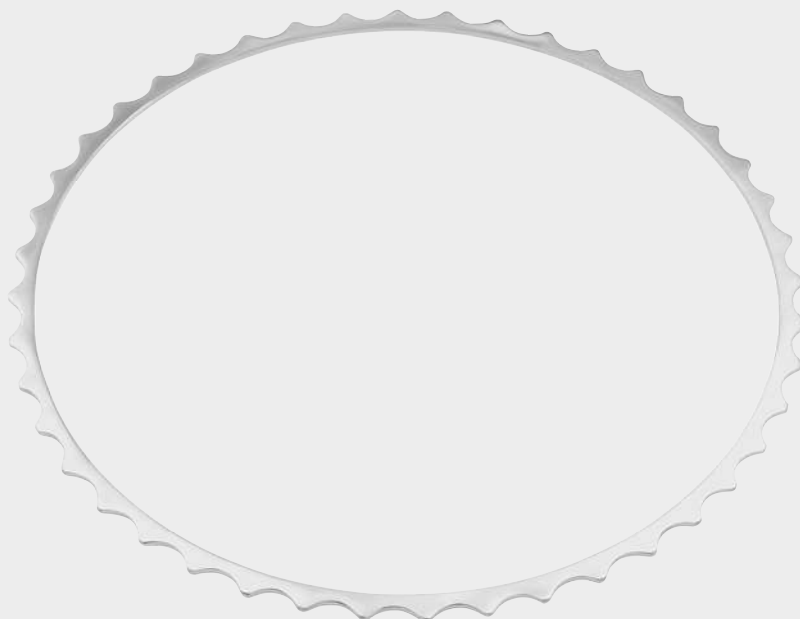

mm	TURNER WARWICK
300	18-7808-03
100	18-7808-04
250	18-7808-05



Bauchdeckenhalter, Valven allein
 Abdominal Retractors, Blades only
 Écarteurs abdominaux, valves seules
 Separadores abdominales valvas sueltas
 Divaricatori addominali, valve sole

**WUNDHAKEN
 WUNDSPERRER**



Hochglanz
 Mirror Finish
 Polie brillante
 Pulida brillante
 Pulita brillante

Biegsam
 Malleable
 Malléable
 Maleable
 Malleabile

mm TURNER WARWICK
 20 x 60 18-7808-10

mm TURNER WARWICK
 55 x 105 18-7808-11

mm TURNER WARWICK
 30 x 32 18-7808-12

mm TURNER WARWICK
 40 x 47 18-7808-13

RETRACTORS

ÉCARTEURS

SEPARADORES

DIVARICATORI



mm TURNER WARWICK
 60 x 75 18-7808-14



mm TURNER WARWICK
 70 x 120 18-7808-15





mm TURNER WARWICK
70 x 90 18-7808-16



mm TURNER WARWICK
20 x 90 18-7808-22

Hochglanz
Mirror Finish
Polie brillante
Pulida brillante
Pulita brillante

Biegsam
Malleable
Malléable
Maleable
Malleabile



mm TURNER WARWICK
13 x 13 18-7808-33

Bauchdeckenhalter, Valven allein
Abdominal Retractors, Blades only
Écarteurs abdominaux, valves seules
Separadores abdominales valvas sueltas
Divaricatori addominali, valve sole

WUNDHAKEN
WUNDSPERRER

RETRACTORS

ÉCARTEURS

SEPARADORES

DIVARICATORI



mm TURNER WARWICK
13 x 13 18-7808-34



mm TURNER WARWICK
13 x 13 18-7808-35



mm TURNER WARWICK
64 x 19 18-7808-36

Bauchdeckenhalter, komplette Sets
Abdominal Retractors, complete Sets
Écarteurs abdominaux, jeux complets
Separadores abdominales, juegos completos
Divaricatori addominali, set completi

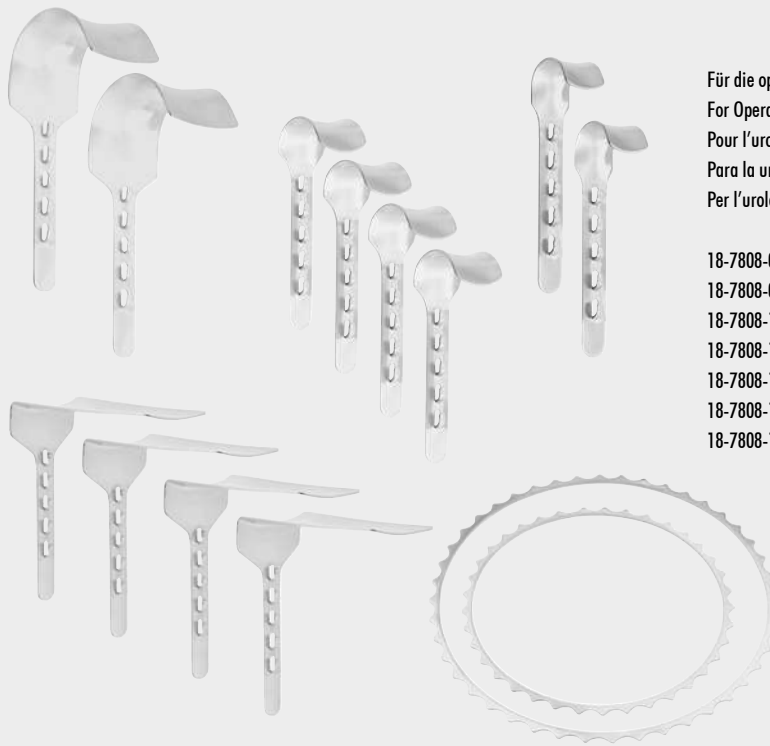

TURNER WARWICK compl.
18-7808-90

Für die operative Urologie, für Erwachsene, bestehend aus:
For Operative Urology, for Adults, Consisting of:
Pour l'urologie opérative, pour adultes, composé de:
Para la urología operativa en adultos, compuesto de:
Per l'urologia operativa di adulti, composto da:

18-7808-03	1 Stück
18-7808-05	1 Stück
18-7808-12	2 Stück
18-7808-13	4 Stück
18-7808-14	2 Stück
18-7808-16	2 Stück
18-7808-15	2 Stück

WUNDHAKEN WUNDSPERRER

RETRACTORS

ÉCARTEURS

SEPARADORES

DIVARICATORI



Für die operative Urologie, für Kinder, bestehend aus:
For Operative Urology, for Children, Consisting of:
Pour l'urologie opérative, pour enfants, composé de:
Para la urología operativa en niños, compuesto de:
Per l'urologia operativa di bambini, composto da:

18-7808-02	1 Stück
18-7808-33	6 Stück
18-7808-12	2 Stück
18-7808-10	1 Stück



TURNER WARWICK compl.
18-7808-91



TURNER WARWICK compl.
18-7808-92

Für Urethroplastik, bestehend aus:
For Urethroplasties, consisting of:
Pour l'urétéroplastie, composé de:
Para ureteroplastia, compuesto de:
Per ureteroplastia, composto da:

18-7808-02	1 Stück
18-7808-33	4 Stück

Bauchdeckenhalter, Rahmen allein
 Abdominal Retractors, Frames only
 Écarteurs abdominaux, cadres seuls
 Separadores abdominales cuadros sueltos
 Divaricatori addominali, telai soli

**WUNDHAKEN
 WUNDSPERRER**

RETRACTORS

ÉCARTEURS

SEPARADORES

DIVARICATORI

Bauchdeckenhalter, Valven allein
 Abdominal Retractors, Blades only
 Écarteurs abdominaux, valves seules
 Separadores abdominales valvas sueltas
 Divaricatori addominali, valve sole



ø mm	TURNER WARWICK
180	18-7812-18
230	18-7812-23
305	18-7812-30

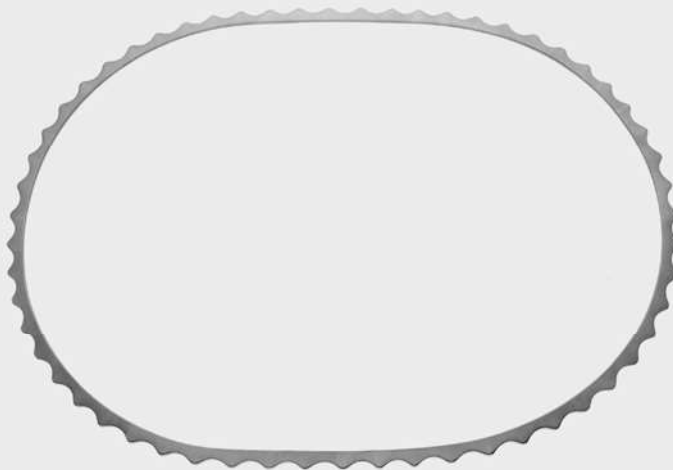

mm	TURNER WARWICK
457 x 330	18-7812-45

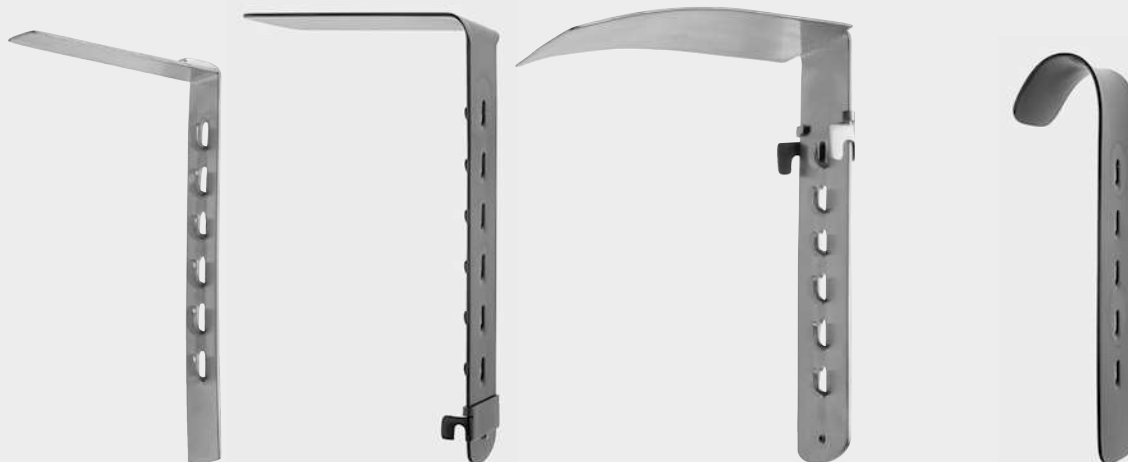

mm	TURNER WARWICK
76 x 19	18-7813-01

mm	TURNER WARWICK
102 x 38	18-7813-02
89 x 57	18-7813-03

mm	TURNER WARWICK
114 x 57	18-7813-04

mm	TURNER WARWICK
51 x 38	18-7815-01

Bauchdeckenhalter, Valven allein
Abdominal Retractors, Blades only
Écarteurs abdominaux, valves seules
Separadores abdominales, valvas sueltas
Divaricatori addominali, valve sole

WUNDHAKEN WUNDSPERRER

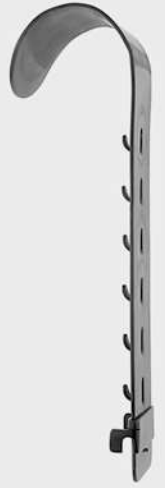

mm TURNER WARWICK
76 x 60 18-7815-02



mm TURNER WARWICK
89 x 60 18-7815-03
114 x 60 18-7815-04



mm TURNER WARWICK
13 18-7815-05

RETRACTORS

ÉCARTEURS

SEPARADORES

DIVARICATORI

Bauchdeckenhalter, komplett
Abdominal Retractor, Complete
Écarteur abdominal, complet
Separador abdominal, completo
Divaricatore addominale, completo

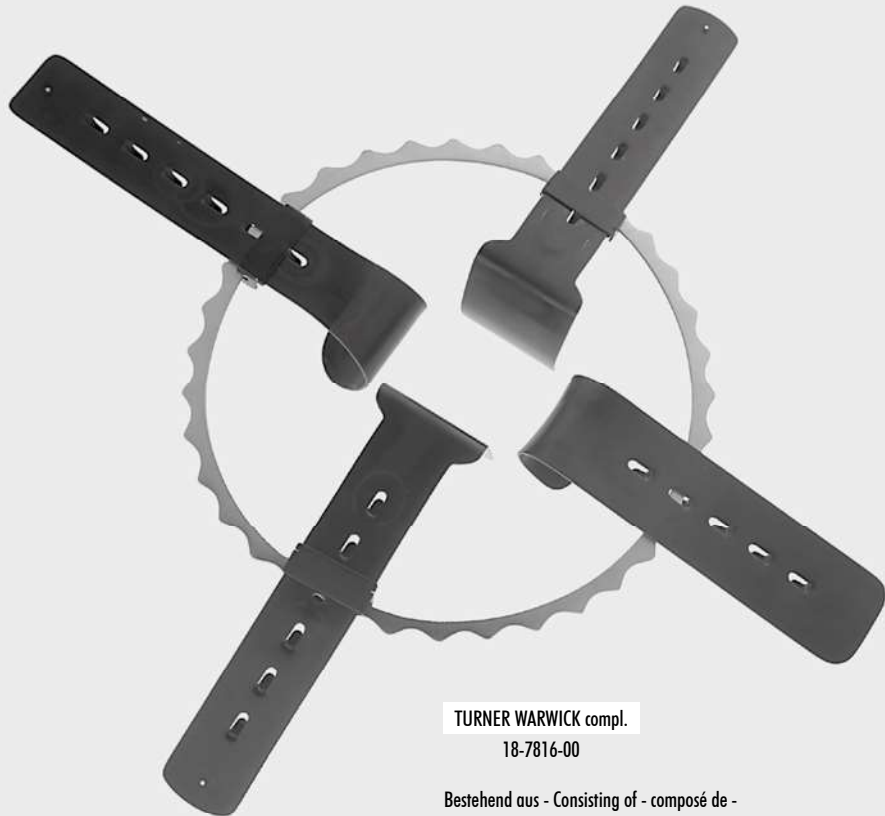

TURNER WARWICK compl.
18-7816-00

Bestehend aus - Consisting of - composé de -
compuesto de - composto da:

18-7812-18	1	18-7813-04	2
18-7812-23	1	18-7815-01	2
18-7812-30	1	18-7815-02	2
18-7813-01	2	18-7815-03	2
18-7813-02	2	18-7815-04	2
18-7813-03	2	18-7815-05	2



cm HUSTINX
23,0 18-8001-23



cm GELPI
9,0 18-8002-09
11,0 18-8002-11
14,0 18-8002-14
16,0 18-8002-16
18,0 18-8002-18



cm GELPI
18,0 18-8004-18

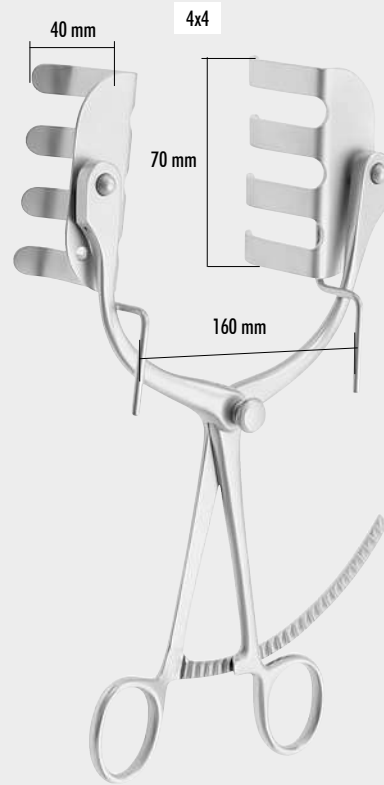

cm Sr. MARKS
22,0 18-8005-22

WUNDHAKEN
WUNDSPERRER

RETRACTORS

ÉCARTEURS

SEPARADORES

DIVARICATORI



mm RIGBY 18,0 cm
35 x 20 18-8006-35
60 x 20 18-8006-60



cm DE BAKEY Femur
10,0 18-8007-10

für Kinder - child size - pour enfants - para niños - per bambini

cm DE BAKEY Femur
14,0 18-8007-14

für Erwachsene - adult size - pour adultes - para adultos - per adulti



cm RICHTER
16,0 18-8008-16

Bauchdeckenhalter
Abdominal Retractors
Écarteurs abdominaux
Separadores abdominales
Divaricatori addominali

WUNDHAKEN
WUNDSPERRER

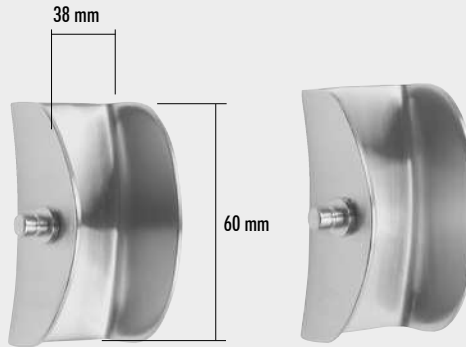

RETRACTORS

ÉCARTEURS

SEPARADORES

DIVARICATORI



COLLIN
18-8100-22

Bestehend aus: Sperrer, 1 Paar Valven
Consisting of: Spreader, 1 pair of blades
Consistant de: Écarteur, 1 paire de valves
Compuesto de: Separador, 1 pareja de valvas
Composto da: Divaricatore, 1 paia di valve



Central / mm	COLLIN	Lateral a x b mm
38 x 55	18-8102-60	60 x 38
50 x 75	18-8102-80	80 x 38

Bestehend aus: Sperrer, 1 Paar Valven, 1 Mittelvalve
Consisting of: Spreader, 1 pair of blades, 1 central blade
Consistant de: Écarteur, 1 paire de valves, 1 valve centrale
Compuesto de: Separador, 1 pareja de valvas, 1 valva central
Composto da: Divaricatore, 1 paia di valve, 1 valva centrale

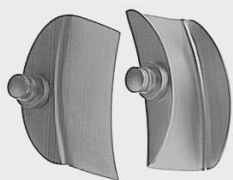

18-8104-11

18 x 42 mm

18-8104-12

28 x 42 mm



cm COLLIN Baby

18,0 18-8104-18

- Bestehend aus: Sperrer und 2 Paar Valven
- Consisting of: Spreader and 2 pairs of blades
- Consistant de: Écarteur et 2 paires de valves
- Compuesto de: Separador y 2 pares de valvas
- Composto da: Divaricatore e 2 paia di valve

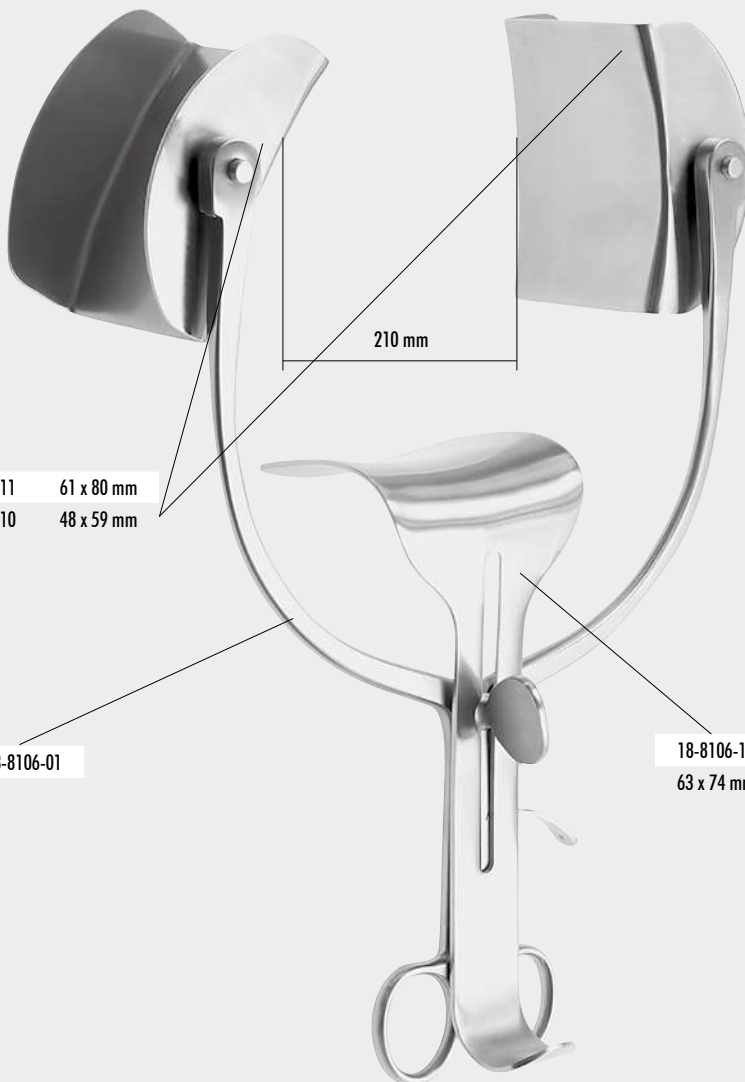

210 mm

18-8106-11 61 x 80 mm

18-8106-10 48 x 59 mm

18-8106-01

18-8106-12

63 x 74 mm

COLLIN Loktite compl.

18-8106-00 (+ 18-8106-01 / 2x 18-8106-11 / 18-8106-12)

18-8106-02 (+ 18-8106-01 / 2x 18-8106-10 / 18-8106-12)

- Bestehend aus: Sperrer, 1 Paar Valven, 1 Mittelvalve
- Consisting of: Spreader, 1 pair of blades, 1 central blade
- Consistant de: Écarteur, 1 paire de valves, 1 valve centrale
- Compuesto de: Separador, 1 pareja de valvas, 1 valva central
- Composto da: Divaricatore, 1 paia di valve, 1 valva centrale

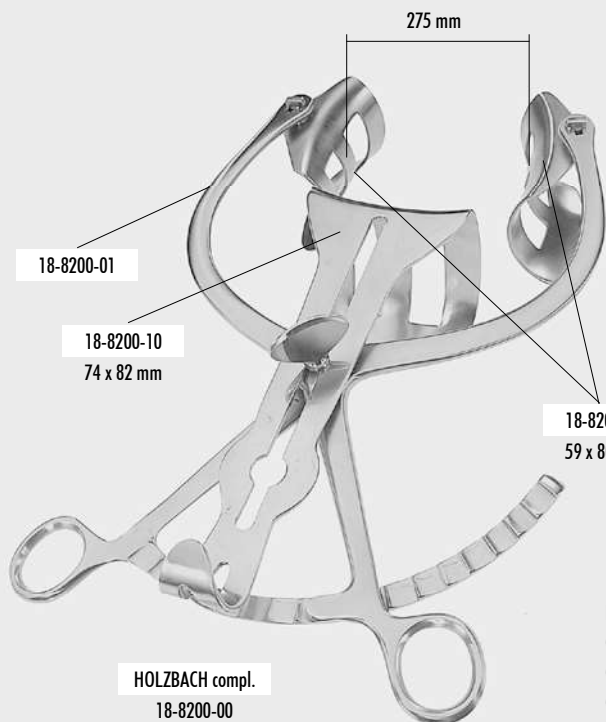

275 mm

18-8200-01

18-8200-10

74 x 82 mm

18-8200-20

59 x 80 mm

HOLZBACH compl.

18-8200-00

- Bestehend aus: Sperrer, 1 Paar Valven, 1 Mittelvalve
- Consisting of: Spreader, 1 pair of blades, 1 central blade
- Consistant de: Écarteur, 1 paire de valves, 1 valve centrale
- Compuesto de: Separador, 1 pareja de valvas, 1 valva central
- Composto da: Divaricatore, 1 paia di valve, 1 valva centrale

Bauchdeckenhalter
Abdominal Retractors
Écarteurs abdominaux
Separadores abdominales
Divaricatori addominali

WUNDHAKEN
WUNDSPERRER

RETRACTORS

ÉCARTEURS

SEPARADORES

DIVARICATORI

Bauchdeckenhalter
Abdominal Retractors
Écarteurs abdominaux
Separadores abdominales
Divaricatori addominali

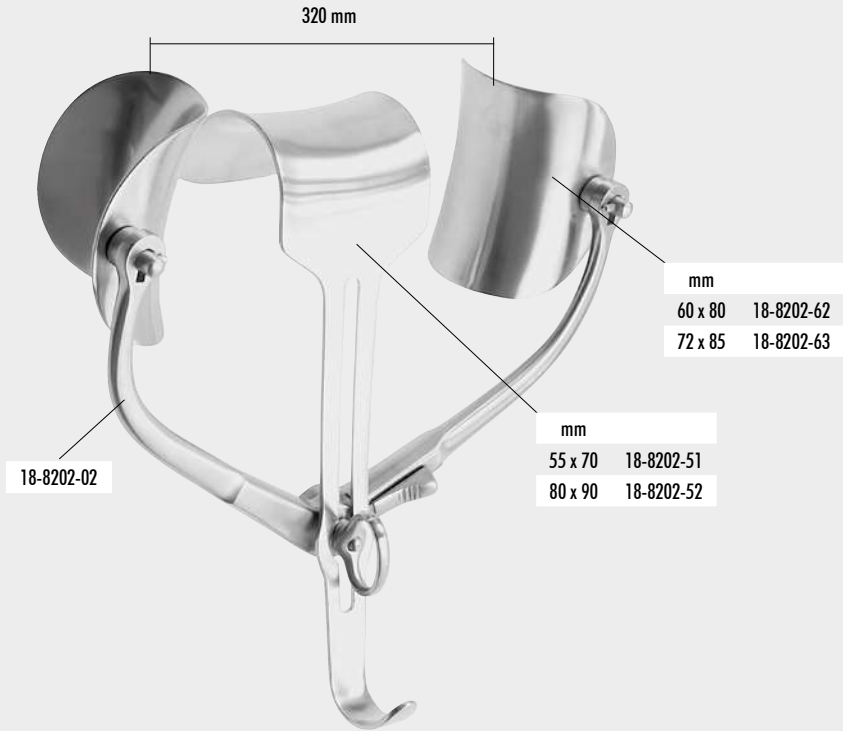

WUNDHAKEN
WUNDSPERRER

RETRACTORS

ÉCARTEURS

SEPARADORES

DIVARICATORI

cm	RICARD
28,0	18-8202-28 (+18-8202-02 / 18-8202-51 / 2x 18-8202-62)
30,0	18-8202-30 (+18-8202-02 / 18-8202-52 / 2x 18-8202-63)

Bestehend aus: Sperrer, 1 Paar Valven, 1 Mittelvalve
 Consisting of: Spreader, 1 pair of blades, 1 central blade
 Consistant de: Écarteur, 1 paire de valves, 1 valve centrale
 Compuesto de: Separador, 1 pareja de valvas, 1 valva central
 Composto da: Divaricatore, 1 paia di valve, 1 valva centrale



mm	DOYEN
55 x 95	18-8220-95
55 x 105	18-8221-05
55 x 115	18-8221-12
55 x 125	18-8221-25



DOYEN CHILD
18-8222-00



*Gewicht allein weight only poids seule pesa sola peso solo	g
	*250 18-8224-25
	*400 18-8224-40
	645 18-8224-64



Bestehend aus: Sperrer, 1 Paar Valven, 1 Mittelvalve
 Consisting of: Spreader, 1 pair of blades, 1 central blade
 Consistant de: Écarteur, 1 paire de valves, 1 valve centrale
 Compuesto de: Separador, 1 pareja de valvas, 1 valva central
 Composto da: Divaricatore, 1 paia di valve, 1 valva centrale

18-8254-99

mm
85 x 70 18-8254-65

18-8254-01

OETTINGEN compl.
18-8254-00

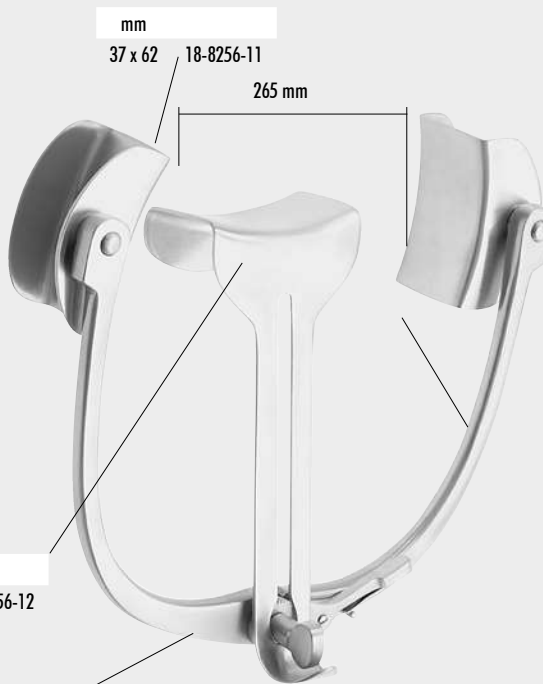

mm
38 x 68 18-8256-12

18-8256-01

ROBIN MASSE
18-8256-00

Bestehend aus: Sperrer, 1 Paar Valven, 1 Mittelvalve
 Consisting of: Spreader, 1 pair of blades, 1 central blade
 Consistant de: Écarteur, 1 paire de valves, 1 valve centrale
 Compuesto de: Separador, 1 pareja de valvas, 1 valva central
 Composto da: Divaricatore, 1 paia di valve, 1 valva centrale

Bauchdeckenhalter
 Abdominal Retractors
 Écarteurs abdominaux
 Separadores abdominales
 Divaricatori addominali

WUNDHAKEN
 WUNDSPERRER

RETRACTORS

ÉCARTEURS

SEPARADORES

DIVARICATORI



Wundhakensystem, selbsthaltend
 Retractor System, Self Retaining
 Système d'écarteurs, autostatique
 Sistema de separadores autorretentivo
 Sistema di divaricatori automatico

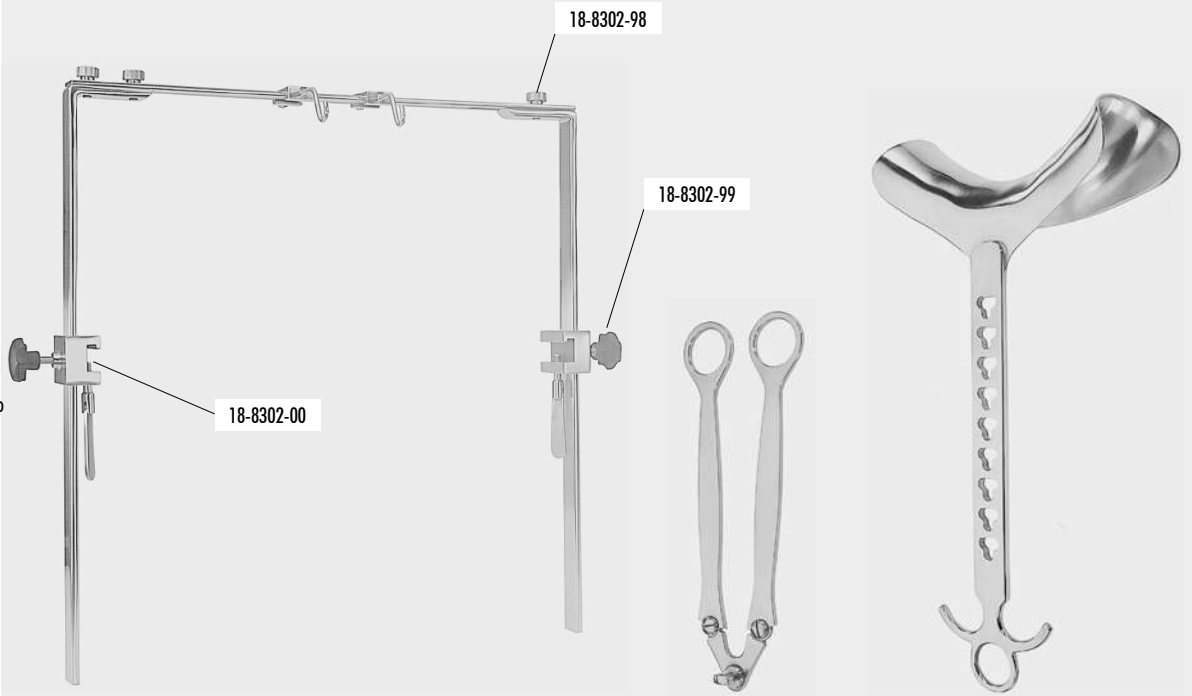

**WUNDHAKEN
 WUNDSPERRER**

RETRACTORS

ÉCARTEURS

SEPARADORES

DIVARICATORI

ROCHARD
 18-8300-01
 18-8300-02

18-8300-01 **ROCHARD**
 Rahmen einseitig
 Frame, one-sided
 Cadre un côté
 Cuadro un lado
 Telaio un lato

18-8300-02 **ROCHARD**
 Rahmen doppelt
 Frame, double
 Cadre double
 Cuadro doble
 Telaio doppio

18-8301-19

mm	
50 x 95	18-8305-09
50 x 105	18-8305-10
60 x 120	18-8306-12
60 x 135	18-8306-13
60 x 155	18-8306-15



mm	» WILLIAMS «	
10 x 50	18-8801-50	18-8803-50
10 x 70	18-8801-70	18-8803-70
20 x 50	18-8802-50	18-8804-50
20 x 70	18-8802-70	18-8804-70

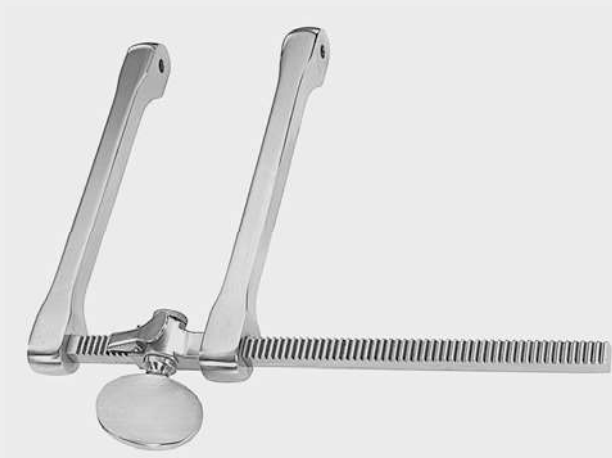

cm SCOVILLE
15,0 18-9004-00

Mikro-Bandscheibensperrer
Microlumbar Dissectomy Retractor
Écarteur microlombaire
Separador, discectomía lumbar
Divaricatore, asportazione disco

WUNDHAKEN
WUNDSPERRER

RETRACTORS

ÉCARTEURS

SEPARADORES

DIVARICATORI

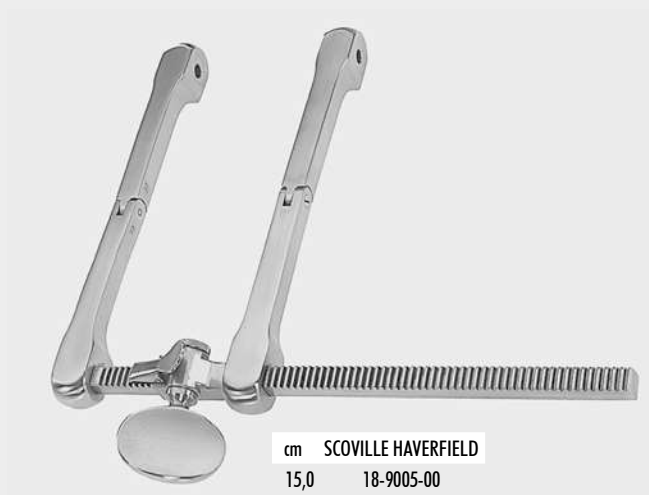

cm SCOVILLE HAVERFIELD
15,0 18-9005-00

Hemilaminectomie-Retraktoren
Hemilaminectomy Retractors
Écarteurs pour hénilaminectomie
Separadores para hemilaminectomía
Divaricatori per emilaminectomia

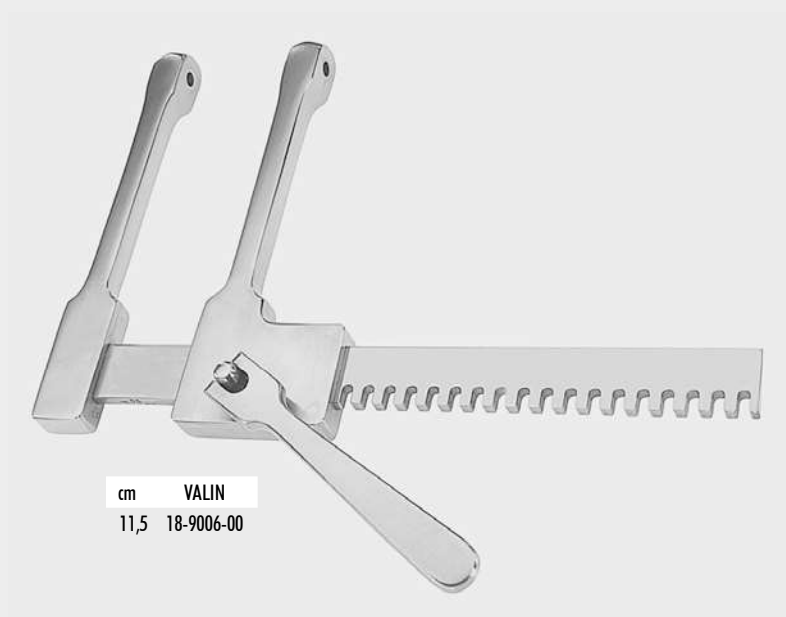

cm VALIN
11,5 18-9006-00

ZEPF[®]
α
INSTRUMENTS

18-9004-00

18.75



Haken und Valven, einzeln
Hooks and Blades, single
Crochets et valves, seuls
Ganchos y valvas, sueltos
Uncini e valve, soli

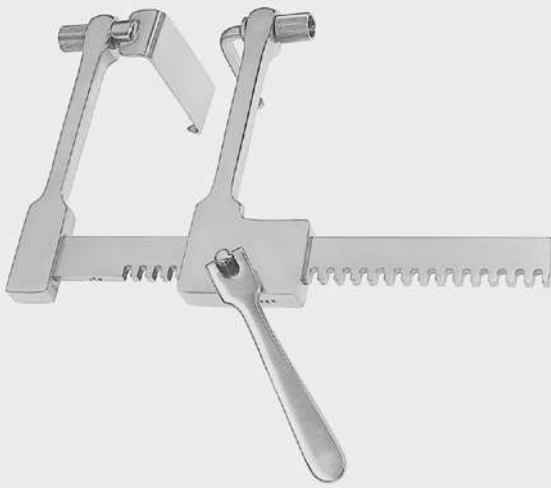

Montage-Beispiel
Example of Assembly
Exemple de montage
Ejemplo de un conjunto
Esempio di combinazione

WUNDHAKEN
WUNDSPERRER

RETRACTORS

ÉCARTEURS

SEPARADORES

DIVARICATORI



mm	SCOVILLE
50	18-9006-01
70	18-9006-02
75	18-9006-03



mm	SCOVILLE
50	18-9006-06
70	18-9006-07
75	18-9006-08



mm	TAYLOR
48 x 50	18-9006-41
64 x 60	18-9006-42
64 x 64	18-9006-43
80 x 57	18-9006-44
41 x 38	18-9006-46
67 x 14	18-9006-47



mm	SCOVILLE
50 x 25	18-9007-01
50 x 50	18-9007-02
57 x 25	18-9007-03
57 x 38	18-9007-04
64 x 25	18-9007-05
64 x 29	18-9007-06
64 x 50	18-9007-07
67 x 28	18-9007-08
67 x 30	18-9007-09
75 x 25	18-9007-10
75 x 50	18-9007-11
88 x 25	18-9007-12
100 x 50	18-9007-13



mm	MEYERDING
44 x 25	18-9009-44
50 x 25	18-9009-50
57 x 25	18-9009-57
70 x 25	18-9009-70
75 x 25	18-9009-75
83 x 25	18-9009-83
88 x 50	18-9009-88



mm	HIBBS
50 x 19	18-9100-01
50 x 25	18-9100-02
50 x 50	18-9100-03
64 x 25	18-9100-04
64 x 38	18-9100-05
75 x 25	18-9100-06
75 x 38	18-9100-07
75 x 50	18-9100-08
75 x 64	18-9100-09
88 x 25	18-9100-10
88 x 38	18-9100-11
100 x 25	18-9100-12
100 x 50	18-9100-13



mm	TAYLOR
75 x 32	18-9102-01
75 x 100	18-9102-02



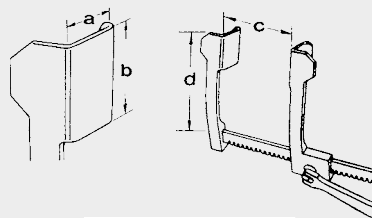
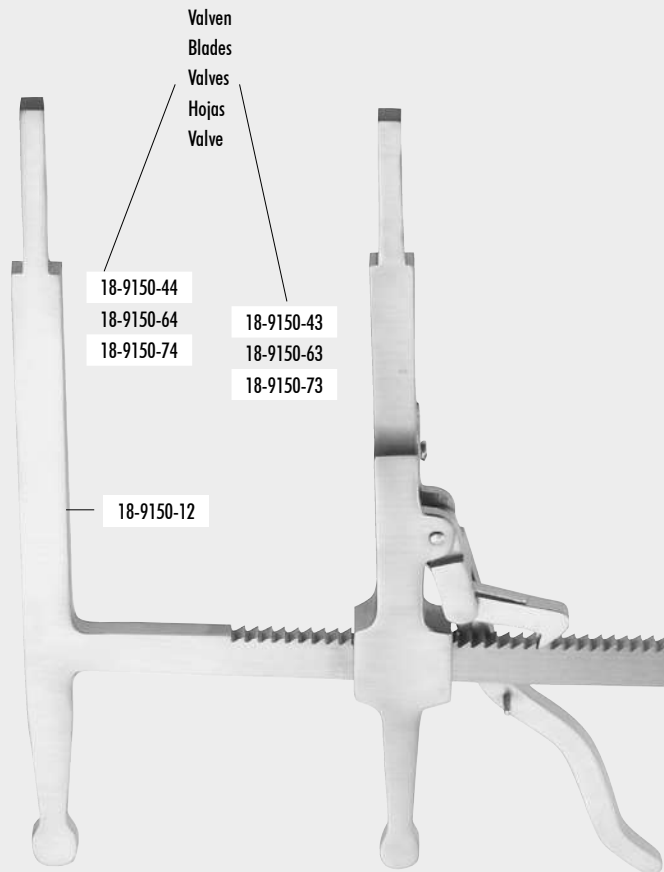

a x b mm	
38 x 32	18-9150-43
38 x 42	18-9150-44
51 x 32	18-9150-63
51 x 42	18-9150-64
66 x 32	18-9150-73
66 x 42	18-9150-74

Valven
Blades
Valves
Hojas
Valve

Laminektomie-Spreizer
Laminectomy Spreader
Écarteur à laminectomie
Separador para laminectomía
Divaricatore per laminectomia

WUNDHAKEN
WUNDSPERRER

RETRACTORS

ÉCARTEURS

SEPARADORES

DIVARICATORI

GLASER
18-9150-00

komplett mit 3 Paar ineinander greifenden Valven
complete with 3 sets of intermeshing blades
complet avec 3 paires de valves
completo con 3 parejas de valvas
completo di 3 paia di valve

18-9150-12 Sperrer allein · spreader only · écarteur seul · separador suelto · divaricatore solo

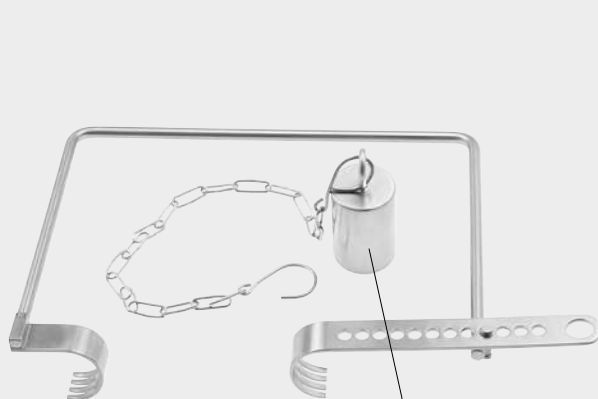

CHARNLEY compl.
18-9200-00

1,5 kg

Wundspreizer 31 cm Sperrweite
Retractor 31 cm spread
Écarteur, 31 cm d'écartement
Separador, abertura 31 cm
Divaricatore, apertura 31 cm



cm
10,0 18-9902-10



18-9903-00

Muskelhaken
Muscle Hooks
Crochets musculaires
Ganchos musculares
Uncini muscolari



18-9150-00 - 18-9903-00

WUNDHAKEN
WUNDSPERRER

RETRACTORS

ÉCARTEURS

SEPARADORES

DIVARICATORI

SONDEN

PROBES, DIRECTORS

STYLETS, SONDES

SONDAS, ESTILETES

SONDE, SPECILLI

SONDEN



cm	2 mm ø
11,5	20-1002-11
13,0	20-1002-13
14,5	20-1002-14
16,0	20-1002-16
18,0	20-1002-18
20,0	20-1002-20
25,0	20-1002-25

PROBES, DIRECTORS

STYLETS, SONDES

SONDAS, ESTILETES

SONDE, SPECILLI



cm	1,0 mm ø	1,5 mm ø	2,0 mm ø
10,0	20-1004-10	20-1005-10	
11,5	20-1004-11	20-1005-11	20-1006-11
13,0	20-1004-13	20-1005-13	20-1006-13
14,5	20-1004-14	20-1005-14	20-1006-14
16,0	20-1004-16	20-1005-16	20-1006-16
18,0	20-1004-18	20-1005-18	20-1006-18
20,0	20-1004-20	20-1005-20	20-1006-20
25,0	20-1004-25	20-1005-25	20-1006-25
30,0			20-1006-30



cm	
10,5	20-1008-10
13,0	20-1008-13
14,5	20-1008-14
16,0	20-1008-16
20,0	20-1008-20



cm	
14,0	20-1010-14
16,0	20-1010-16



cm	BRODIE
16,5	20-1012-16



cm	FLUHRER
25,0	20-1030-25
40,0	20-1030-40



cm
 11,0 20-1100-11
 13,0 20-1100-13
 14,5 20-1100-14
 16,0 20-1100-16
 18,0 20-1100-18
 20,0 20-1100-20



cm DOYEN
 14,0 20-1101-14



cm DOYEN
 13,0 20-1102-13
 14,5 20-1102-14
 16,0 20-1102-16
 18,0 20-1102-18



cm NELATON
 16,0 20-1103-16

SONDEN

PROBES, DIRECTORS

STYLETS, SONDES

SONDAS, ESTILETES

SONDE, SPECILLI



cm STACKE
 10,5 20-1105-10



cm FISH
 14,5 20-1108-14
 18,0 20-1108-18



cm WATSON CHEYNE
 12,5 20-1114-12
 19,0 20-1114-19



ø mm NELATON 19,0 cm
 3,0 20-1200-19

Venenstripper Sets
 Vein Stripper Sets
 Jeux à phlébotomie
 Sets de flebotomía
 Set di flebotomia

SONDEN



NABATOFF compl.
 135 x 100 x 25 mm 20-1500-00

PROBES, DIRECTORS

STYLETS, SONDES

SONDAS, ESTILETES

SONDE, SPECILLI

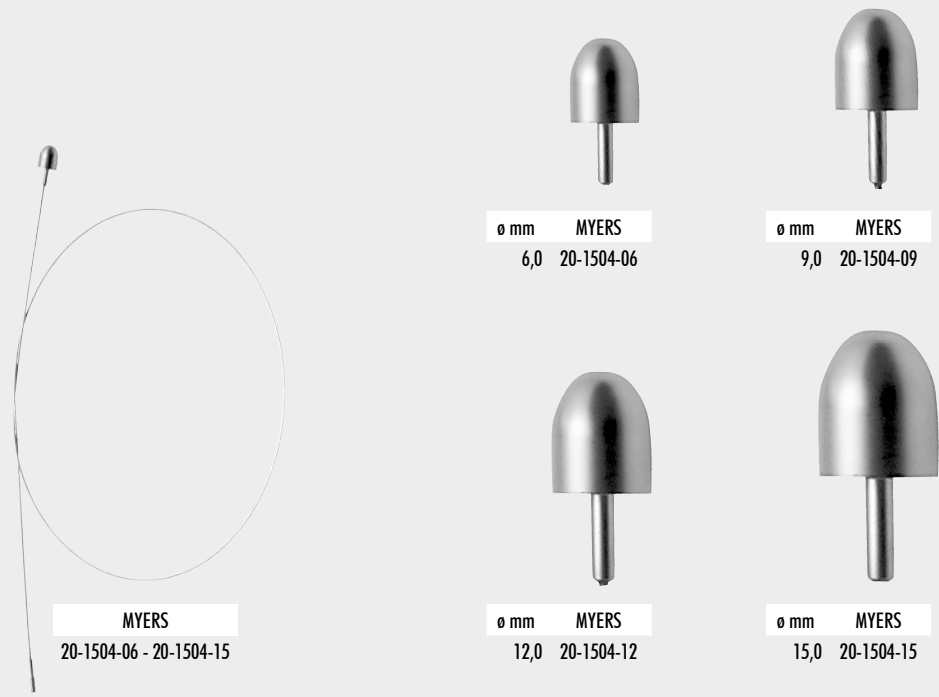

MYERS
 20-1504-06 - 20-1504-15

ø mm MYERS
 6,0 20-1504-06

ø mm MYERS
 9,0 20-1504-09

ø mm MYERS
 12,0 20-1504-12

ø mm MYERS
 15,0 20-1504-15

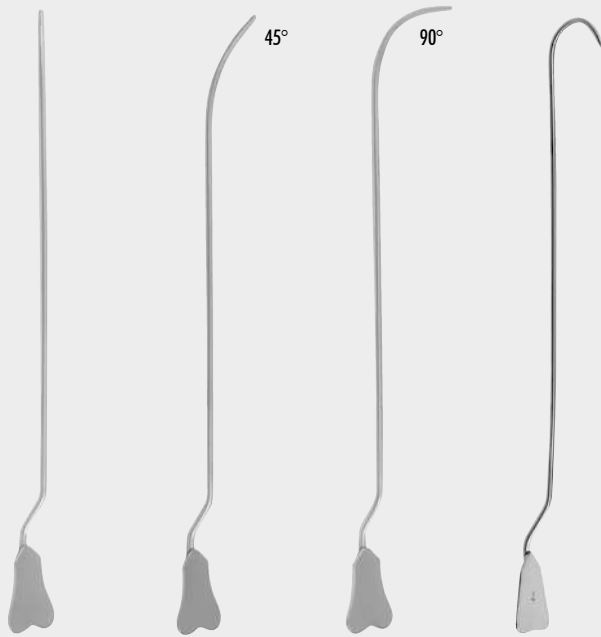

LOCKHART-MUMMERY

Fig. 1	Fig. 2	Fig. 3	Fig. 4
20-1520-01	20-1521-02	20-1521-03	20-1521-04

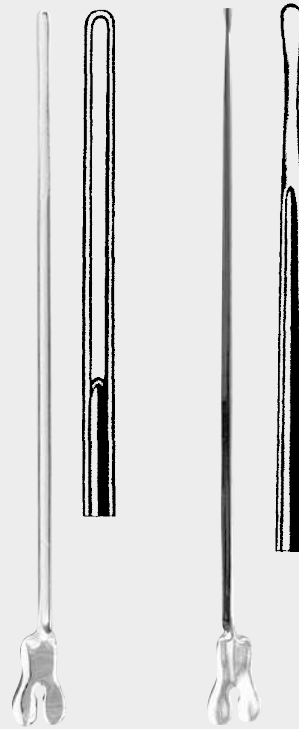

cm	BRODIE
19,0 20-1524-19	20,0 20-1526-20

Hohlsonden
Grooved Directors
Sondes cannelées
Sondas acanaladas
Sonde scannelate

SONDEN

PROBES, DIRECTORS

STYLETS, SONDES

SONDAS, ESTILETES

SONDE, SPECILLI



VARADY compl.
20-1560-00



ø mm
3,0 20-1560-03



ø mm
4,0 20-1560-04



ø mm
5,0 20-1560-05



cm
45,0 20-1560-45

Mini Venenstripper-Set
Mini Vein Stripper Set
Jeu mini à phlébotomie
Set mini de flebotomia
Set mini di flebotomia

Varizeninstrumente
 Varix Instruments
 Instruments pour varices
 Instrumentos para várices
 Strumenti per varici

SONDEN

PROBES, DIRECTORS

STYLETS, SONDES

SONDAS, ESTILETES

SONDE, SPECILLI

Venenstripper, Pflasterspatel
 Vein Strippers, Spatula
 Tire-veines, spatule
 Desobliterador de vena, espátula
 Tiravene, spatola

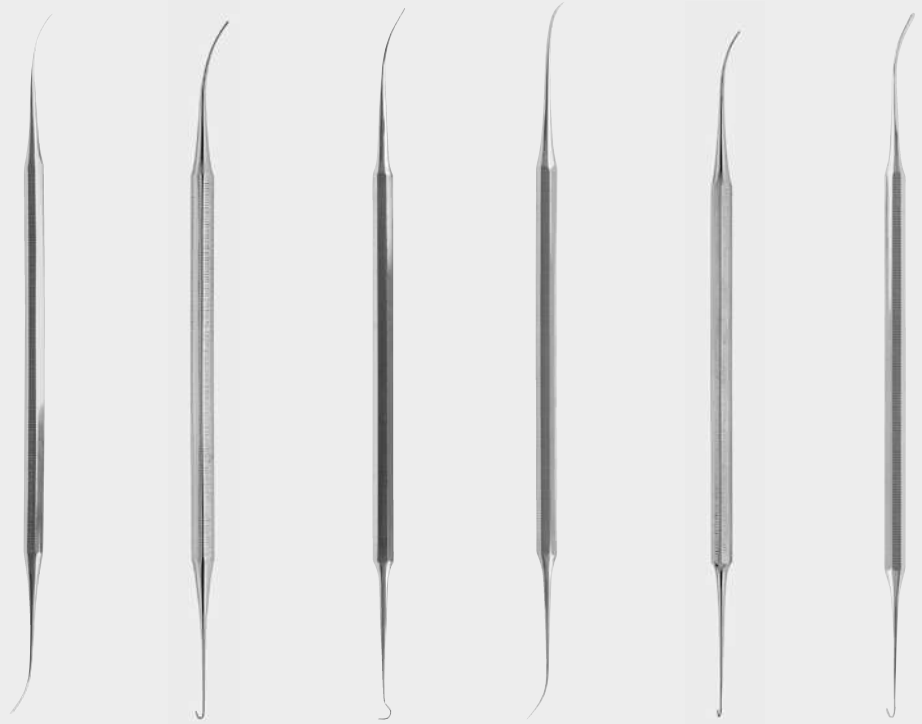

VARADY					
Fig. 1	Fig. 2	Fig. 3	Fig. 4	Fig. 5	Fig. 6
20-1564-01	20-1564-02	20-1564-03	20-1564-04	20-1564-05	20-1564-06
18,0 cm	18,0 cm	18,0 cm	17,5 cm	17,0 cm	17,0 cm
Phlebodissektor	Phlebextraktor	Phlebextraktor	Mikro -Doppelspatel	Mikro-Phlebextraktor	Mini-Phlebextraktor



20-1600-02
2 mm ø



20-1600-08
8 mm ø



20-1600-03
3 mm ø



20-1600-10
10 mm ø



20-1600-04
4 mm ø



20-1600-12
12 mm ø



20-1600-06
6 mm ø

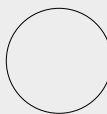

20-1600-14
14 mm ø



20-1600-07
7 mm ø



cm
12,0 20-1602-12



cm BABCOCK
40,0 20-1604-40



cm
13,0 20-1900-13
14,5 20-1900-14

Watteträger
Cotton Applicators
Porte-coton
Porta-algodón
Portacotone



cm	ø mm	FARREL (LATHBURY UEBE)
12,0	0,9	20-2700-12
14,0	0,9	20-2700-14
16,5	1,1	20-2700-16
18,0	1,2	20-2700-18
23,0	1,3	20-2700-23

cm	ø mm	FARREL
12,0	0,9	20-2702-12
14,0	0,9	20-2702-14
16,5	1,1	20-2702-16
18,0	1,2	20-2702-18
23,0	1,3	20-2702-23

cm	ø 1,2 mm
12,0	20-2704-12
14,0	20-2704-14
16,0	20-2704-16
18,0	20-2704-18

cm	ø 1,5 mm
12,0	20-2900-12
14,0	20-2900-14
16,0	20-2900-16
18,0	20-2900-18

cm	ø 1,5 mm
12,0	20-2902-12
14,0	20-2902-14
16,0	20-2902-16
18,0	20-2902-18

SONDEN

PROBES, DIRECTORS

STYLETS, SONDES

SONDAS, ESTILETES

SONDE, SPECILLI

Venenstripper, Pflasterspatel
Vein Strippers, Spatula
Tire-veines, spatule
Desobliterador de vena, espátula
Tiravene, spatola

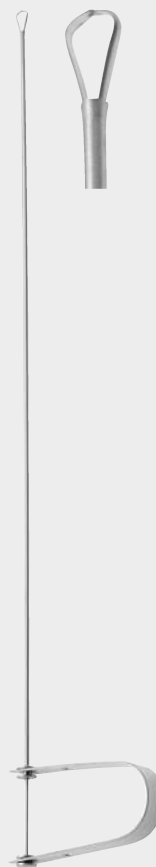
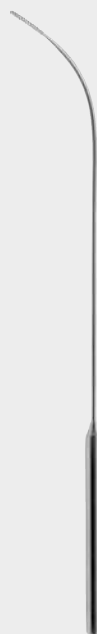
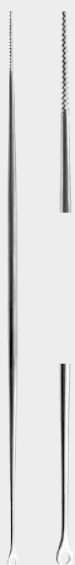

cm	UCKERMANN
15,0	20-3100-15

cm	JOBSON-HORNE
12,0	20-3200-12
18,0	20-3200-18

cm	TOBOLD
25,0	20-3301-25

cm	FEIN
28,0	20-3303-28

cm	
45,0	20-3400-45



20-2700-12 - 20-3400-45

SONDEN

PROBES, DIRECTORS

STYLETS, SONDES

SONDAS, ESTILETES

SONDE, SPECILLI

TROKARE, KANÜLEN

TROCARS, CANNULAS, NEEDLES

TROCARTS, CANULES ET AIGUILLES

TROCARES, CÁNULAS, AGUJAS

TREQUARTI, CANNULE, AGHI



Trokare
Trocars and Cannula
Trocarts
Trócares
Trequarti

TROKARE,
KANÜLEN

TROCARS, CANNULAS,
NEEDLES

TROCARTS, CANULES
ET AIGUILLES

TRÓCARES, CÁNULAS,
AGUJAS

TREQUARTI,
CANNULE, AGHI

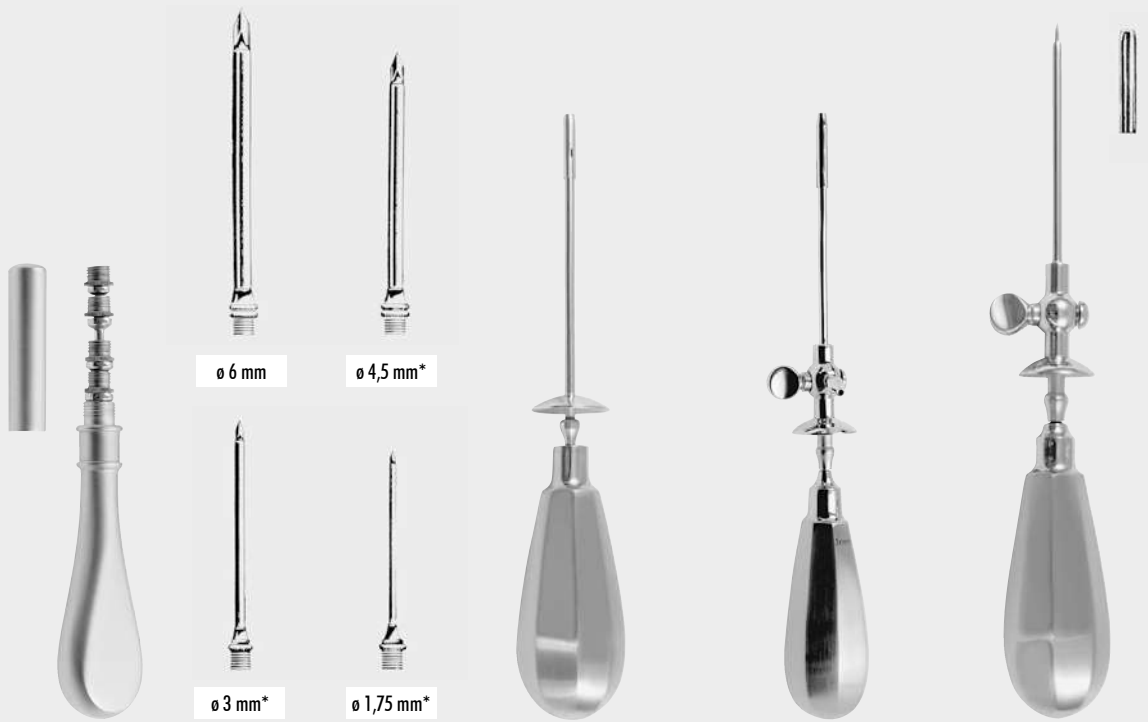

Set	UNIVERSAL compl.
3*	22-1003-00
4	22-1004-00

ø mm	Standard
3,0	22-1100-30
3,5	22-1100-35
4,0	22-1100-40
4,5	22-1100-45
5,0	22-1100-50
5,5	22-1100-55
6,0	22-1100-60

ø mm	
3,0	22-1110-03
4,0	22-1110-04
5,0	22-1110-05
6,0	22-1110-06

ø mm	Standard
3,0	22-1200-30
3,5	22-1200-35
4,0	22-1200-40
4,5	22-1200-45
5,0	22-1200-50
5,5	22-1200-55
6,0	22-1200-60

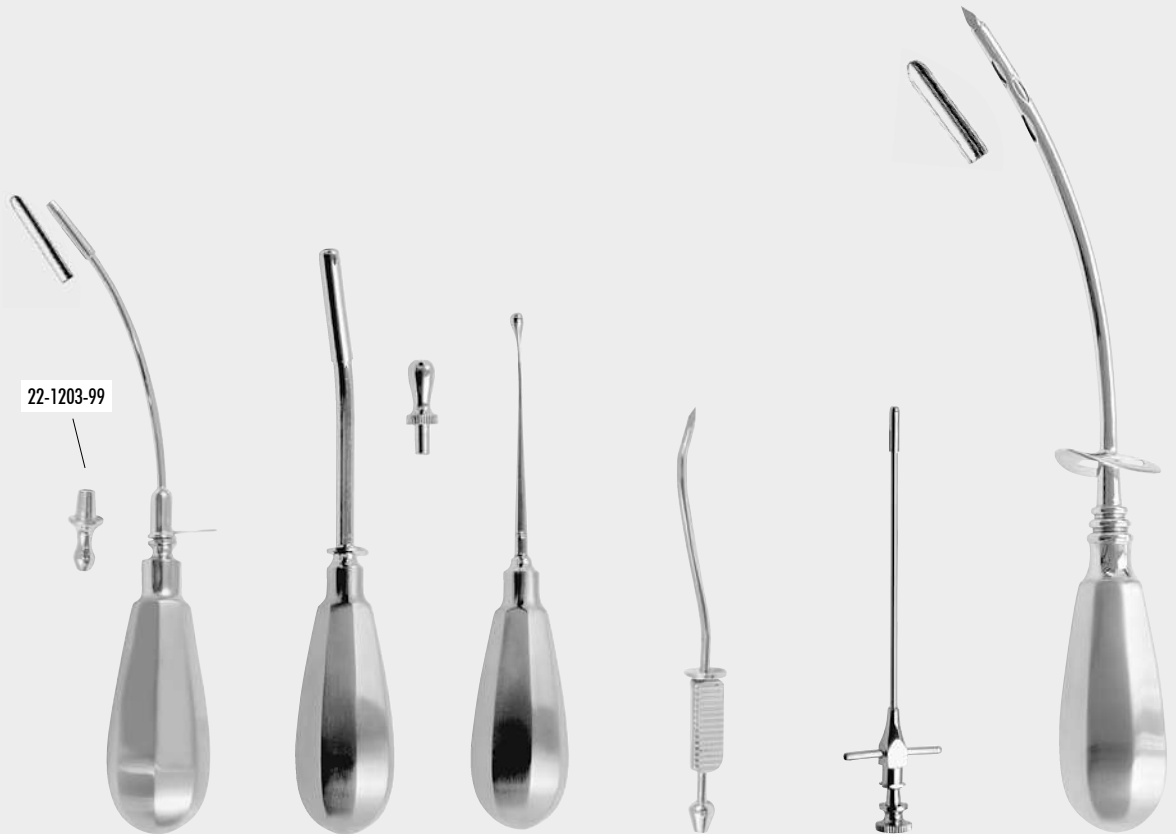

22-1203-99

ø mm	PIERCE
3,0	22-1203-30
4,0	22-1203-40
5,0	22-1203-50

ø mm	KRAUSE 16,0 cm
5,5	22-1204-55

ø mm	DOUGLAS
3,0	22-1205-11

cm	
11,0	22-1206-11

ø mm	FLEURANT 23,0 cm
5,0	22-1207-23





ø mm LICHTWITZ
1,75 22-1208-19



ø mm COAKLEY
2,5 22-1400-02



Charr. / FG.	OCHSNER
10	22-1500-10
12	22-1500-12
14	22-1500-14
16	22-1500-16
18	22-1500-18
20	22-1500-20
22	22-1500-22
24	22-1500-24

Trokare
Trocars and Cannulas
Trocarts
Trócares
Trequarti

TROKARE,
KANÜLEN

TROCARS, CANNULAS,
NEEDLES

TROCARTS, CANULES
ET AIGUILLES

TRÓCARES, CÁNULAS,
AGUJAS

TREQUARTI,
CANNULE, AGHI



Charr. / FG. BUELAU
24 22-1600-24



ø mm BILLROTH
5,0 22-1640-05
6,0 22-1640-06



ø mm CAMPBELL
6,0 22-1650-06
8,0 22-1650-08

Kanülen
Needles
Aiguilles
Aguijas
Aghi

TROKARE, KANÜLEN

TROCARS, CANNULAS, NEEDLES

TROCARTS, CANULES ET AIGUILLES

TRÓCARES, CÁNULAS, AGUJAS

TREQUARTI, CANNULE, AGHI



Charr. / F.G.	NELSON
25	22-1700-25
30	22-1700-30
33	22-1700-33
35	22-1700-35

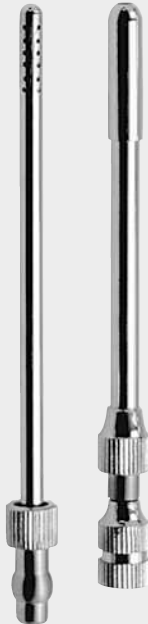

ø mm	11,0 cm
5,5	22-1800-55

Pudendus Anaesthesia
Pudendus Anesthesia



22-2100-00
compl.

22-2100-01

Kanüle allein - Needle only - Aiguille seule
aguja suelta - ago solo - 1,00 x 165 mm

Lumbalpunktion
Lumbar Puncture
Ponction lombaire
Punción lumbar
Puntura lombare



mm	QUINKE
1,2 x 76	22-2300-12
1,2 x 89	22-2302-12
1,0 x 76	22-2300-10
1,0 x 89	22-2302-10
0,7 x 76	22-2300-07
0,7 x 89	22-2302-07
0,7 x 50	22-2304-07

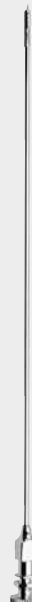

ø mm	LANDAU
2,0	22-2550-02



ø mm	LANDAU
2,0	22-2560-02

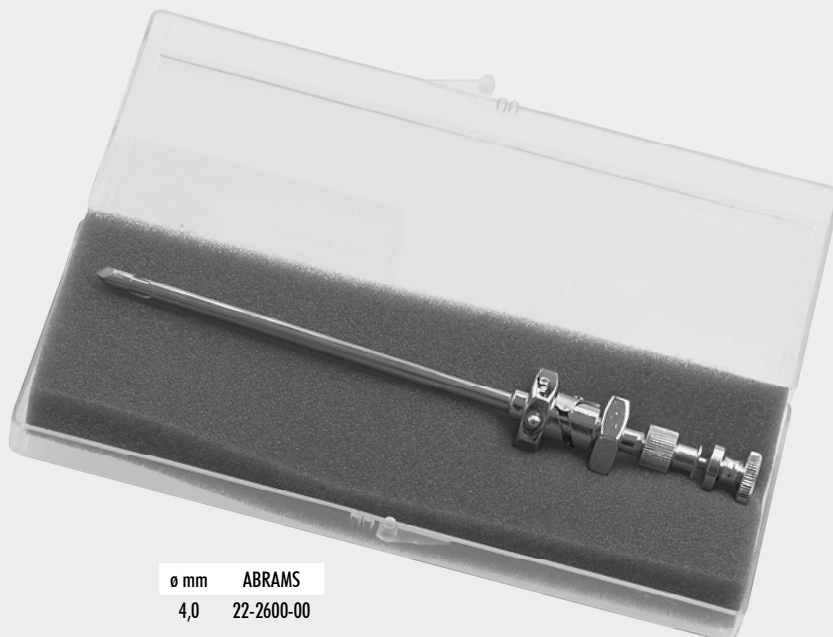

ø mm	ABRAMS
4,0	22-2600-00

Pleura-Punktion - Pleura Puncture - Ponction de la plèvre
 Punción de la pleura - Puntura della pleura

Biopsie-Kanülen
 Biopsy Specimen
 Cannulas
 Canules à biopsie
 Cánulas para biopsia
 Cannule per biopsia

TROKARE,
 KANÜLEN

TROCARS, CANNULAS,
 NEEDLES

TROCARTS, CANULES
 ET AIGUILLES

TRÓCARES, CÁNULAS,
 AGUJAS

TREQUARTI,
 CANNULE, AGHI

Knochen-Punktion
 Bone Puncture
 Ponction des os
 Punción de huesos
 Puntura di ossa

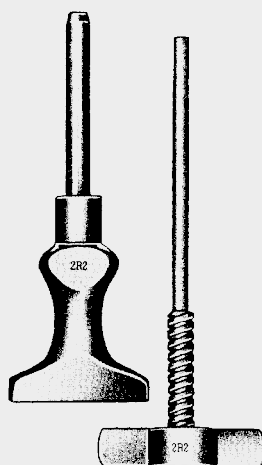

L mm	BARTELHEIMER
30	22-2702-30
40	22-2702-40
50	22-2702-50

Biopsie-Kanülen
Biopsy Specimen Cannulas
Canules à biopsie
Cánulas para biopsia
Cannule per biopsia

TROKARE,
KANÜLEN

TROCARS, CANNULAS,
NEEDLES

TROCARTS, CANULES
ET AIGUILLES

TRÓCARES, CÁNULAS,
AGUJAS

TREQUARTI,
CANNULE, AGHI

Radiometrie
Radiometry
Radiométrie
Radiometria
Radiometria

ZEPF[®]
α
INSTRUMENTS

22-2712-12 - 22-4002-18

22.6



L x ø mm	BIER
80 x 1,0	22-2712-10
80 x 1,2	22-2712-12



L x ø mm	
80 x 1,2	22-2720-12
80 x 1,5	22-2720-15



cm	MOCK Heparin
6,0	22-2730-06



cm	SCHMID 15,0 cm
22-2736-03 - 22-2736-06	

Gefäß-Kanülen - Vascular Cannulae -
Canules vasculaires - Cánulas vasculares
Cannule vascolari



ø mm	
3,0	22-2736-03

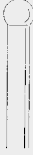

ø mm	
4,0	22-2736-04



ø mm	
5,0	22-2736-05



ø mm	
6,0	22-2736-06



ø mm	CHAMPEAU
1,3	22-4002-13
1,8	22-4002-18



ø mm	CHAMPEAU
1,3	22-4003-13
1,8	22-4003-18

NADELHALTER

NEEDLE HOLDERS

PORTE-AIGUILLES

PORTA-AGUJAS

PORT'AGHI

Mit TC-Einsätzen
TC Lined
A mors TC
Con bocas TC
Con morso TC

NADELHALTER

NEEDLE HOLDERS

PORTE-AIGUILLES

PORTA-AGUJAS

PORT'AGHI

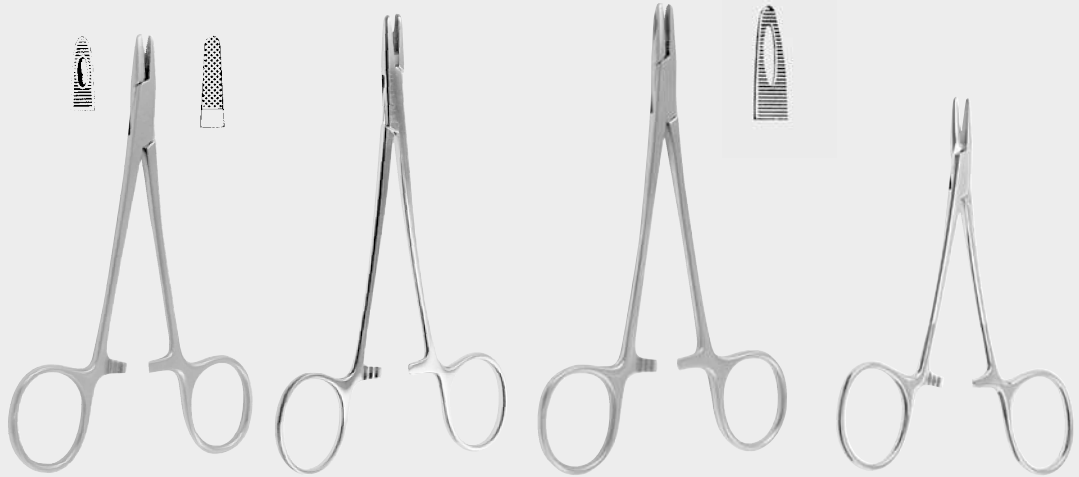

cm DERF
12,0 24-1100-12 24-1104-12

cm DERF (WRIGHT)
12,5 24-1200-12

cm COLLIER
12,5 24-1202-12

cm CONVERSE
10,5 24-1204-10

längsgerieft
longitudinal serration
à rainures longitudinales
con estrias longitudinales
con strie longitudinali

mit Längskehlen im Maul
with grooved jaws
à mors strié
con bocca accanalata
con morso scanalato

Maul fein gerieft
jaws fine serrated
à mors striés fines
con bocas estriadas finas
con morso zigrinato fino

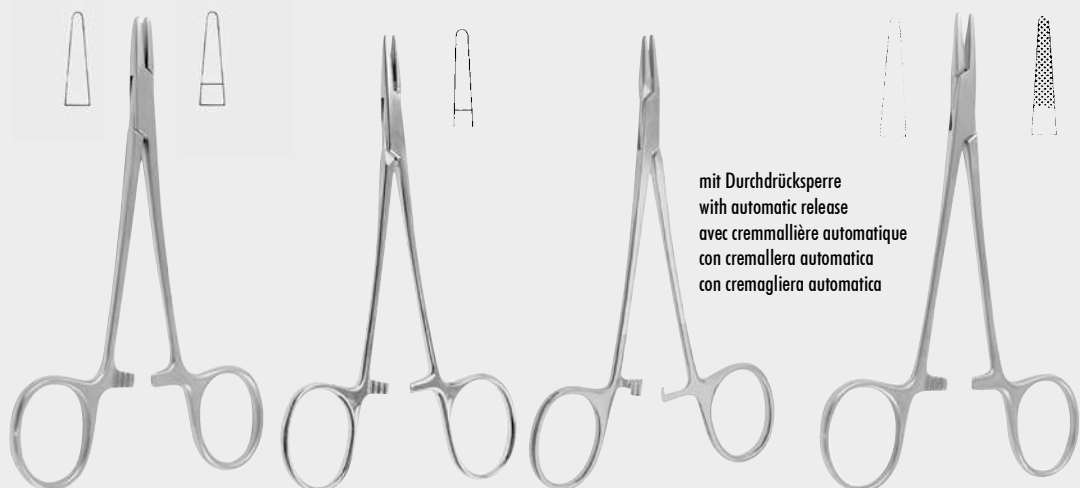

mit Durchdrücksperr
with automatic release
avec cremmallière automatique
con cremallera automatica
con cremagliera automatica

cm WEBSTER
13,0 24-1210-13 24-1214-13

cm WEBSTER
12,0 24-1224-12

cm WEBSTER
13,0 24-1234-13

cm HALSEY
13,0 24-1300-13 24-1400-13
13,0 24-1304-13 24-1404-13

glatt
smooth
mors lisse
boca lisa
morso liscio

glatt
smooth
mors lisse
boca lisa
morso liscio

13,0 24-1404-13L für Linkshänder -
for left handers - pour gauchers -
para zurdos - per mancini



cm	NEIVERT	
13,0	24-1420-13	24-1424-13

Maul glatt, mit Kehlung
jaw smooth, with groove
mors lisse, avec gorge
boca lisa con roza
morso liscio con scannatura



cm	BAUMGARTNER	
12,5	24-1500-12	24-1504-12
14,0	24-1500-14	24-1504-14



cm	BROWN	
13,0	24-1510-13	
18,0	24-1510-18	

Maul diagonal gerieft
jaws diagonally serrated
mors strié transversalement
a boca estriada transversalement
boca a strie diagonali

cm	DOYEN	
12,0	24-1520-12	



cm	CRILE WOOD fino	
15,0	24-1600-15	24-1604-15
18,0	24-1600-18	24-1604-18
20,0	24-1600-20	24-1604-20
23,0	24-1600-23	24-1604-23
27,0		24-1604-27
30,0		24-1604-30



cm	CRILE WOOD	
15,0	24-1614-15	

mit Durchdrücksperr
with automatic release
avec crémaillère automatique
con cremallera automatica
con cremagliera automatica

15,0	24-1604-15L für Linkshänder - for left handers - pour gauchers - para zurdos - per mancini
------	--

NADELHALTER

NEEDLE HOLDERS

PORTE-AIGUILLES

PORTA-AGUJAS

PORT'AGHI



Mit TC-Einsätzen
 TC Lined
 A mors TC
 Con bocas TC
 Con morso TC

NADELHALTER



cm CRILE MURRAY
 15,0 24-1700-15 24-1704-15

cm LAWRENCE
 15,0 24-1708-15

cm KILNER
 13,5 24-1710-13 24-1714-13
 16,5 24-1710-16

cm NEW ORLEANS
 18,0 24-1720-18 24-1724-18

NEEDLE HOLDERS

schlankes Modell
 slender pattern
 modèle gracile
 modelo delgado
 modello delicato

13,5 24-1714-13L
 für Linkshänder - for left handers -
 pour gauchers - para zurdos -
 per mancini

PORTE-AIGUILLES

PORTA-AGUJAS

PORT'AGHI



cm MAYO HEGAR
 14,0 24-1800-14 24-1804-14
 16,0 24-1800-16 24-1804-16
 18,0 24-1800-18 24-1804-18
 20,0 24-1800-20 24-1804-20
 24,0 24-1800-24 24-1804-24
 26,0 24-1800-26 24-1804-26
 30,0 24-1800-30 24-1804-30
 35,0 24-1804-35

cm MAYO HEGAR
 16,0 24-1811-16
 18,0 24-1811-18
 20,0 24-1811-20 24-1815-20
 24,0 24-1815-24
 26,0 24-1815-26

cm MAYO HEGAR fino
 16,0 24-1900-16 24-1904-16
 18,0 24-1900-18 24-1904-18
 20,0 24-1900-20 24-1904-20

14,0 24-1804-14L für Linkshänder - for left handers
 24,0 24-1804-24L pour gauchers - para zurdos - per mancini



Mit TC-Einsätzen
 TC Lined
 A mors TC
 Con bocas TC
 Con morso TC



cm	HEGAR	
20,0	24-1910-20	24-1914-20

cm	HEGAR	
17,0	24-1916-17	
20,0	24-1916-20	

cm	HEGAR	
20,0	24-1920-20	24-1924-20
24,0	24-1920-24	24-1924-24

cm	SENNING	
17,0	24-1930-17	

NADELHALTER

NEEDLE HOLDERS

PORTE-AIGUILLES

PORTA-AGUJAS

PORT'AGHI

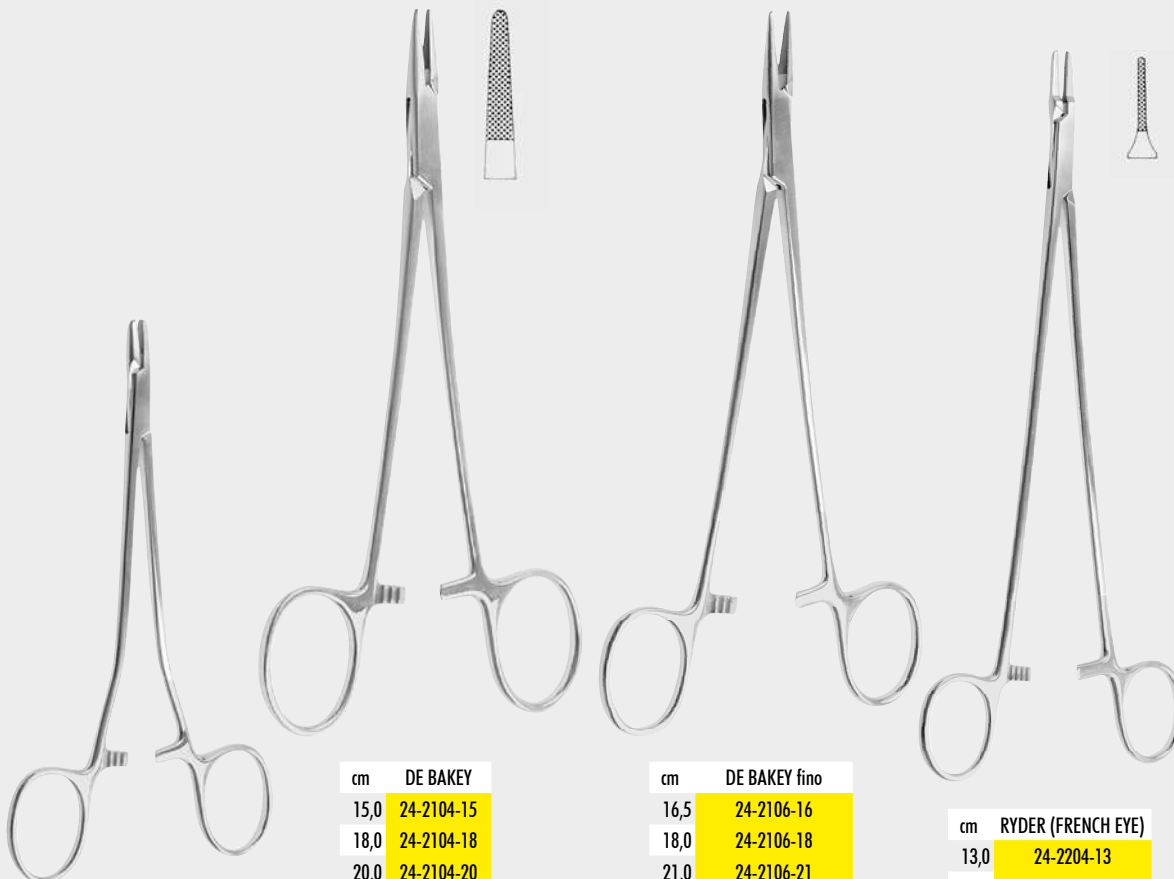

cm	SENNING	
15,0	24-1934-15	
17,0	24-1934-17	
20,0	24-1934-20	

cm	DE BAKEY	
15,0	24-2104-15	
18,0	24-2104-18	
20,0	24-2104-20	
23,0	24-2104-23	
26,0	24-2104-26	
31,0	24-2104-31	
37,0	24-2104-37	

cm	DE BAKEY fino	
16,5	24-2106-16	
18,0	24-2106-18	
21,0	24-2106-21	
23,0	24-2106-23	
31,0	24-2106-31	

cm	RYDER (FRENCH EYE)	
13,0	24-2204-13	
15,0	24-2204-15	
18,0	24-2204-18	
20,0	24-2204-20	
23,0	24-2204-23	
26,0	24-2204-26	

15,0	24-2104-15L	für Linkshänder - for left handers
20,0	24-2104-20L	pour gauchers - para zurdos - per mancini



Mit TC-Einsätzen
 TC Lined
 A mors TC
 Con bocas TC
 Con morso TC

NADELHALTER



cm	RYDER VASCULAR
13,0	24-2214-13
15,0	24-2214-15
18,0	24-2214-18
20,0	24-2214-20
23,0	24-2214-23
26,0	24-2214-26



cm	HEGAR VASCULAR
14,0	24-2224-14
18,0	24-2224-18
20,0	24-2224-20
23,0	24-2224-23



cm	MICROVASCULAR
14,0	24-2234-14
18,0	24-2234-18
20,0	24-2234-20
23,0	24-2234-23

NEEDLE HOLDERS

PORTE-AIGUILLES

PORTA-AGUJAS

PORT'AGHI



glatt
 smooth
 lisse
 lisa
 liscio

cm	MARTINI
14,0	24-2244-14
18,0	24-2244-18
20,0	24-2244-20



gerieft
 serrated
 strié
 estriado
 striato

cm	MARTINI
14,0	24-2254-14
15,0	24-2254-15
18,0	24-2254-18
20,0	24-2254-20



cm	JAMISON
23,5	24-2300-23
	24-2304-23

Mit TC-Einsätzen
 TC Lined
 A mors TC
 Con bocas TC
 Con morso TC



cm	HEANEY (HEGAR)	
21,0	24-2401-21	24-2405-21
26,0		24-2405-26



cm	MASSON	
27,0	24-2500-27	24-2504-27



cm	MASSON LUETHY	
25,5	24-2508-26	

NADELHALTER

NEEDLE HOLDERS

PORTE-AIGUILLES

PORTA-AGUJAS

PORT'AGHI



cm	JULIAN	
21,0	24-2515-21	
23,0	24-2515-23	

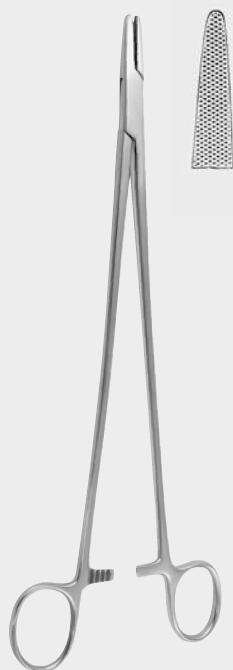

cm	WANGENSTEEN	
27,0	24-2600-27	24-2604-27



cm	WANGENSTEEN	
27,0	24-2610-27	24-2614-27





Mit TC-Einsätzen
 TC Lined
 A mors TC
 Con bocas TC
 Con morso TC

NADELHALTER



cm	BOZEMANN (WERTHEIM)	
20,0	24-2801-20	24-2805-20
24,0	24-2801-24	24-2805-24
26,0	24-2801-26	24-2805-26

glatt
 smooth
 mors lisse
 boca lisa
 morso liscio

NEEDLE HOLDERS

PORTE-AIGUILLES

PORTA-AGUJAS

PORT'AGHI

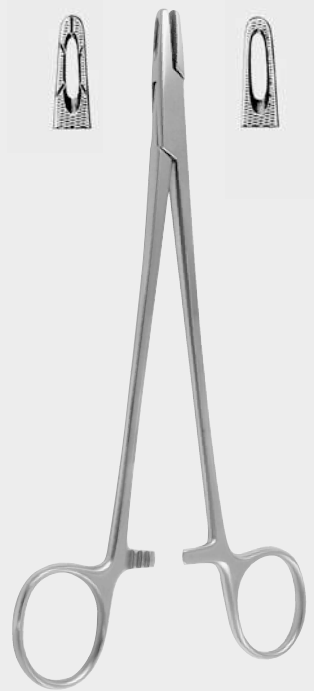

cm	METZENBAUM	
18,0	24-2900-18	

ein Maul gekehlt, ein Maulteil gefenstert
 one grooved jaw, one fenestrated jaw
 un mors strié, un mors fenêtré
 una voca acanalado, un a boca fenestrado
 un morso scanellata, un morso finestrata

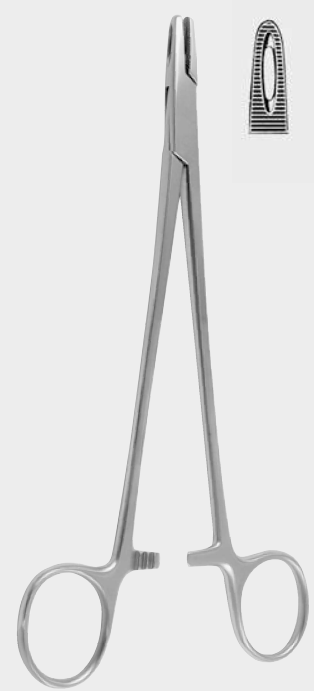

cm	ADSON	
16,0	24-2902-16	
18,0	24-2902-18	

ein Maulteil gefenstert
 one fenestrated jaw
 un mors fenêtré
 un a boca fenestrado
 un morso finestrata



cm	Mass. Gen. Hosp.	
17,0	24-2910-17	

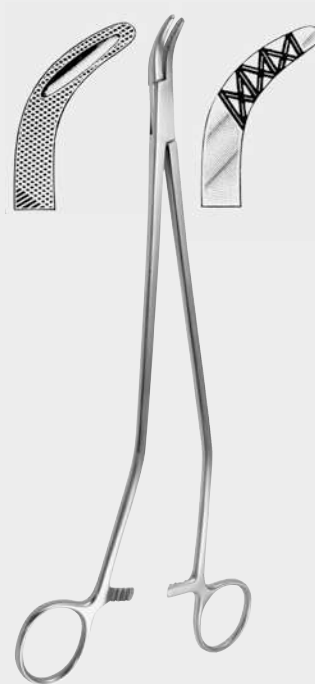

cm	JOHNSON	
27,0	24-2933-27	



cm	FINOCHIETTO	
20,0	24-3101-20	24-3105-20
27,0	24-3101-27	24-3105-27

Mit TC-Einsätzen
 TC Lined
 A mors TC
 Con bocas TC
 Con morso TC



cm	SAROT	
18,0	24-3200-18	24-3204-18
20,0		24-3204-20
26,0	24-3200-26	24-3204-26



cm	SAROT
26,0	24-3324-26

NADELHALTER

NEEDLE HOLDERS

PORTE-AIGUILLES

PORTA-AGUJAS

PORT'AGHI



cm	STRATTE	
22,0		24-3304-22
23,0	24-3300-23	24-3304-23



cm	NAUNTON MORGAN	
18,5	24-3312-18	
25,5	24-3312-25	24-3314-25





Mit TC-Einsätzen
 TC Lined
 A mors TC
 Con bocas TC
 Con morso TC

NADELHALTER

NEEDLE HOLDERS

PORTE-AIGUILLES

PORTA-AGUJAS

PORT'AGHI

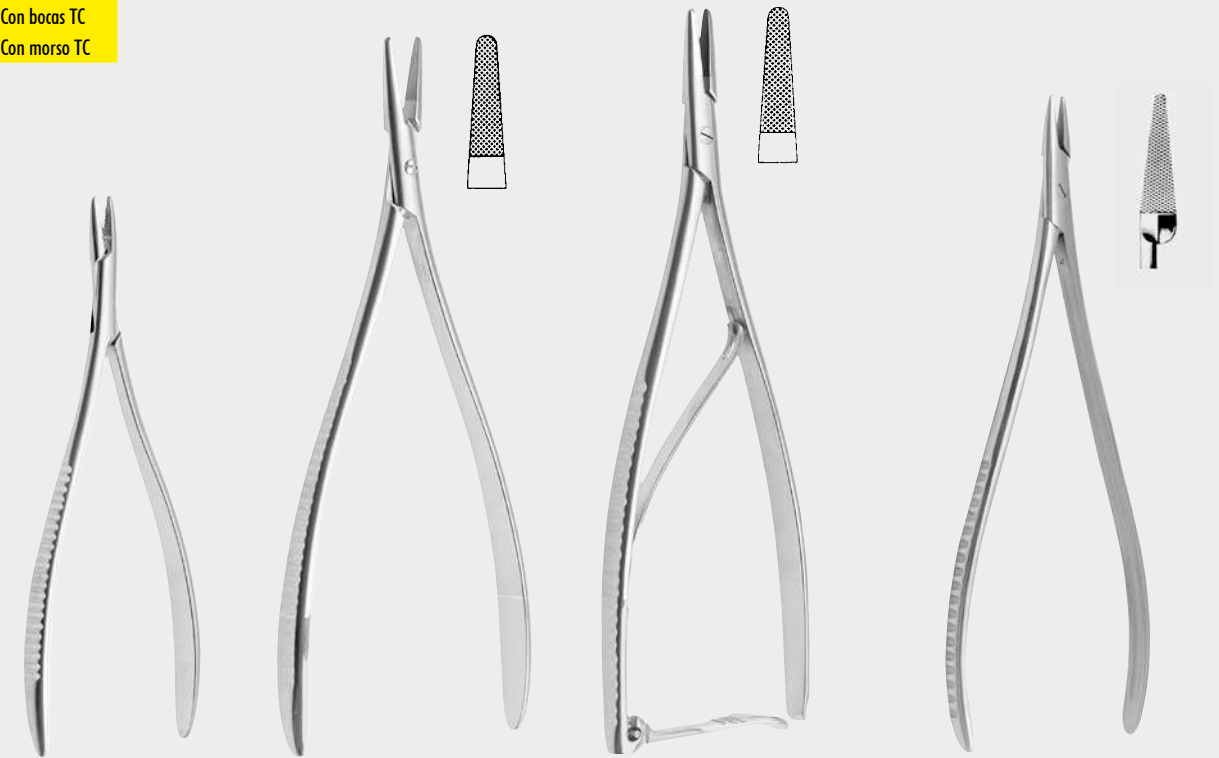

cm CRILE
 15,0 24-3500-15

cm LANGENBECK
 18,0 24-3554-18
 20,0 24-3554-20
 23,0 24-3554-23

cm ZWEIFEL
 20,0 24-3564-20
 23,0 24-3564-23

cm TOENNIS
 18,0 24-3600-18 24-3604-18

mit Klappsperr
 with hinged ratchet
 avec crémaillère
 con cremalliera abatibile
 con cremagliera a scatto

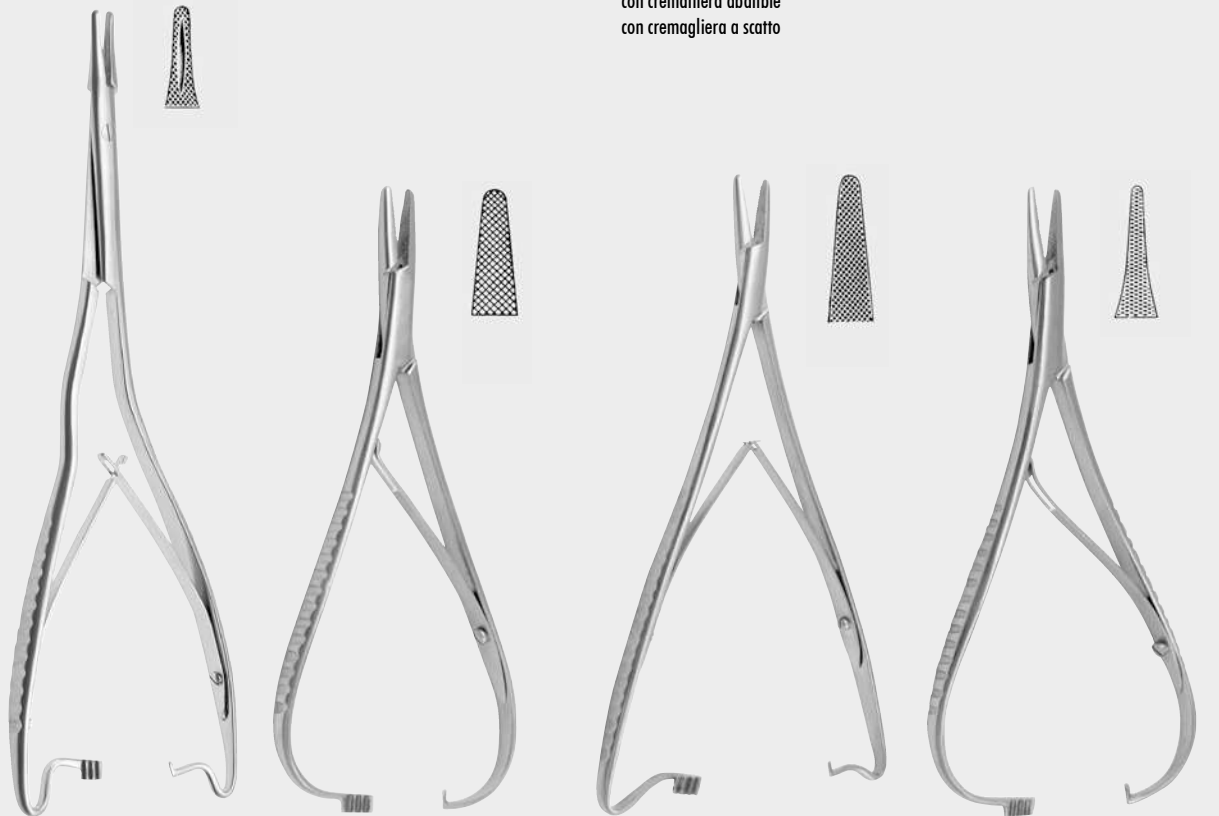

cm HOESEL
 25,0 24-3607-25

cm MATHIEU
 14,0 24-3700-14 24-3704-14
 17,0 24-3700-17 24-3704-17
 20,0 24-3700-20 24-3704-20
 24,0 24-3700-24 24-3704-24

cm MATHIEU
 17,0 24-3800-17 24-3804-17
 20,0 24-3800-20 24-3804-20

cm MATHIEU FINO
 14,0 24-3900-14 24-3904-14
 17,0 24-3900-17 24-3904-17

Mit TC-Einsätzen
 TC Lined
 A mors TC
 Con bocas TC
 Con morso TC



cm EISELSBERG MATHIEU
 18,0 24-3910-18 24-3914-18



cm LICHTENBERG
 20,0 24-3924-20

NADELHALTER

NEEDLE HOLDERS

PORTE-AIGUILLES

PORTA-AGUJAS

PORT'AGHI



cm OLSEN HEGAR
 14,0 24-4100-14 24-4104-14
 18,0 24-4100-18 24-4104-18



cm OLSEN HEGAR
 17,0 24-4200-17 24-4204-17



cm OLSEN HEGAR BABY
 12,0 24-4214-12



Mit TC-Einsätzen
 TC Lined
 A mors TC
 Con bocas TC
 Con morso TC

NADELHALTER

NEEDLE HOLDERS

PORTE-AIGUILLES

PORTA-AGUJAS

PORT'AGHI

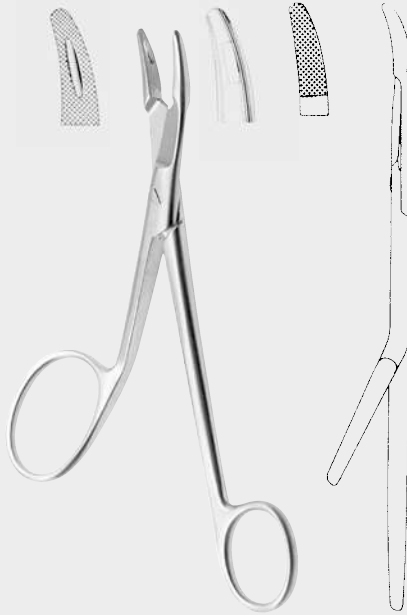

cm GILLIES
 16,0 24-4300-16 24-4304-16



cm GILLIES mini
 13,0 24-4310-13 24-4314-13



cm GILLIES mini
 15,0 24-4314-15

cm FOSTER GILLIES
 11,0 24-4324-11

cm HARRISON
 12,5 24-4326-12

cm DIETRICH
 16,0 24-4404-16
 18,0 24-4404-18
 20,0 24-4404-20
 23,0 24-4404-23
 26,0 24-4404-26

Mit TC-Einsätzen
 TC Lined
 A mors TC
 Con bocas TC
 Con morso TC



Augen-Nadelhalter
 Ophthalmic Needle Holders
 Porte-aiguilles pour ophtalmologie
 Porta-agujas para oftalmología
 Port'aghi per oftalmologia

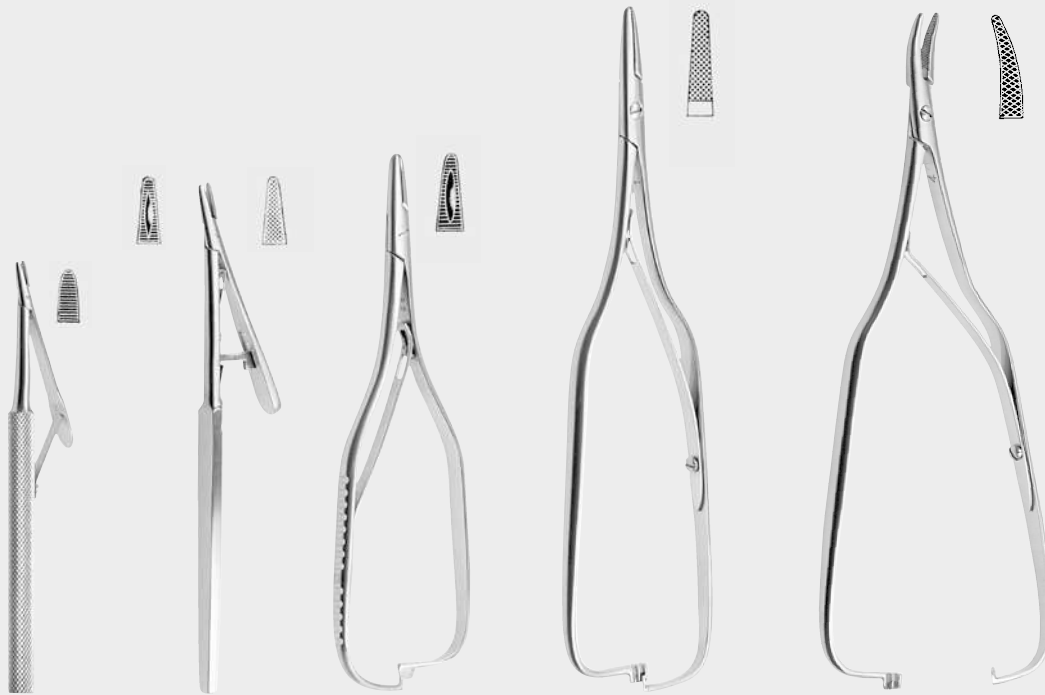

cm STEVENS
 11,0 24-6100-11

cm STEVENS
 13,0 24-6102-13
 15,0 24-6102-15

cm BOYNTON
 12,0 24-6104-12

cm ARRUGA
 16,0 24-6200-16 24-6204-16

cm ARRUGA
 16,0 24-6201-16 24-6205-16

NADELHALTER

NEEDLE HOLDERS

PORTE-AIGUILLES

PORTA-AGUJAS

PORT'AGHI

Augen-, Mikronadelhalter
 Ophthalmic, Micro Needle Holders
 Porte-aiguilles pour ophtalmologie et micro
 Porta-agujas para oftalmología y micro
 Port'aghi per oftalmologia e micro

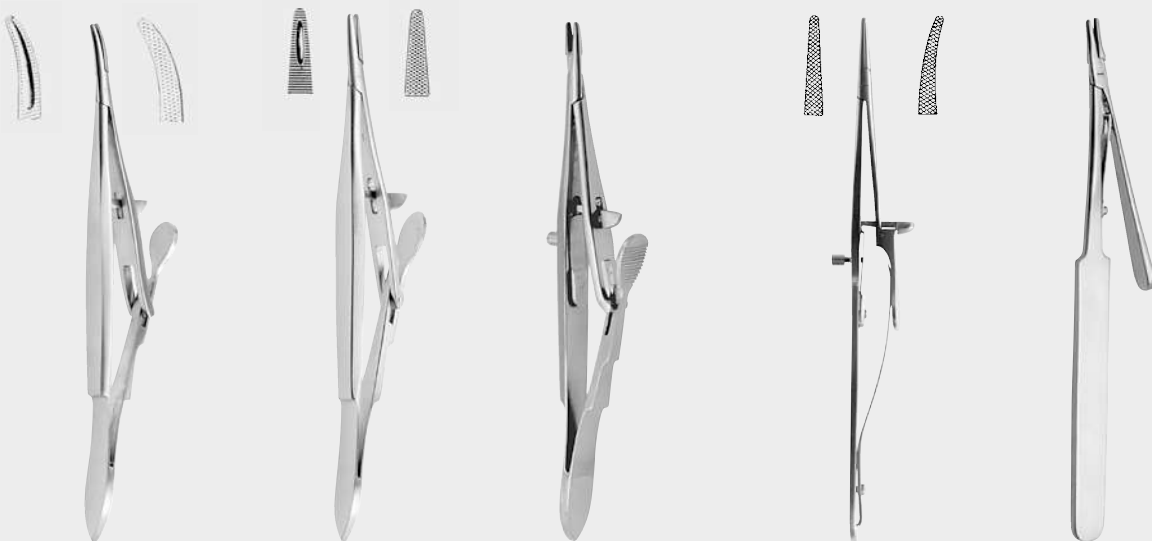

cm KALT-ARRUGA
 14,0 24-6207-14

cm KALT
 14,0 24-6208-14

cm CASTROVIEJO-KALT
 14,0 24-6214-14

cm ARRUGA
 14,0 24-6220-14 24-6221-14

cm BARRAQUER
 14,0 24-6230-14





Mit TC-Einsätzen
 TC Lined
 A mors TC
 Con bocas TC
 Con morso TC

Augen-, Mikronadelhalter
 Ophthalmic, Micro Needle Holders
 Porte-aiguilles pour ophtalmologie et micro
 Porta-agujas para oftalmologia y micro
 Port'aghi per oftalmologia e micro

NADELHALTER

NEEDLE HOLDERS

PORTE-AIGUILLES

PORTA-AGUJAS

PORT'AGHI



cm BARRAQUER 10,0 24-6500-10



cm BARRAQUER 10,0 24-6501-10



cm REILL 15,0 24-6504-15 24-6505-15



cm BARRAQUER 13,5 24-6521-13



cm BARRAQUER 11,0 24-6601-11
 13,0 24-6601-13 24-6605-13



cm BARRAQUER 12,0 24-6611-12



cm BARRAQUER 12,0 24-6612-12
 15,0 24-6612-15 24-6613-15
 18,0 24-6612-18 24-6613-18
 23,0 24-6613-23



cm BARRAQUER 14,0 24-6619-14



Mit TC-Einsätzen
 TC Lined
 A mors TC
 Con bocas TC
 Con morso TC



Augen-, Mikronadelhalter
 Ophthalmic, Micro Needle Holders
 Porte-aiguilles pour ophtalmologie et micro
 Porta-agujas para microcirugía y micro
 Port'aghi per oftalmologia e micro



cm CASTROVIEJO
 14,0 24-6690-14 24-6691-14

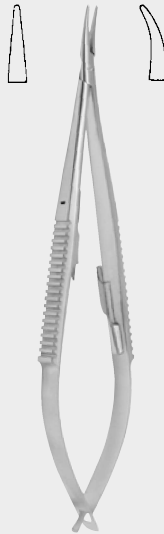

cm CASTROVIEJO
 14,0 24-6700-14 24-6701-14
 14,0 24-6704-14 24-6705-14



cm CASTROVIEJO
 14,0 24-6708-14 24-6709-14
 18,0 24-6708-18

NADELHALTER

NEEDLE HOLDERS

PORTE-AIGUILLES

PORTA-AGUJAS

PORT'AGHI



cm CASTROVIEJO
 18,0 24-6714-18



cm CASTROVIEJO
 18,0 24-6715-18
 21,0 24-6715-21



24-6720-14 24-6721-14



24-6730-09 24-6731-09



24-6734-09 24-6735-09

cm CASTROVIEJO
 9,0 24-6730-09 - 24-6731-09

cm CASTROVIEJO
 9,0 24-6734-09 - 24-6735-09





Mit TC-Einsätzen
 TC Lined
 A mors TC
 Con bocas TC
 Con morso TC

Mikro-Nadelhalter
 Micro Needle Holders
 Porte-aiguilles micro
 Porta-agujas micro
 Port'aghi micro

NADELHALTER

NEEDLE HOLDERS

PORTE-AIGUILLES

PORTA-AGUJAS

PORT'AGHI



cm POTTS-SMITH
 22,0 24-6790-22



cm CASTROVIEJO
 13,0 24-6800-13 24-6804-13



cm WACHTEL
 17,0 24-6814-17



cm	—	—
16,0	24-6900-16	24-6901-16
18,5	24-6900-18	24-6901-18

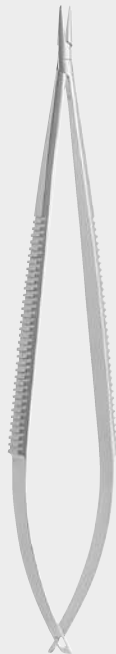

cm JACOBSON
 18,0 24-6920-18



cm JACOBSON
 18,0 24-6922-18



cm	—	—
16,5	24-7101-16	24-7101-16
20,0	24-7100-20	24-7101-20
22,5	24-7100-22	24-7101-22
24,5	24-7101-24	24-7101-24



cm	—	BROCK	—
15,0	24-7400-15		24-7401-15
18,0	24-7400-18		24-7401-18

NAHT-INSTRUMENTE

SUTURING INSTRUMENTS

INSTRUMENTS À SUTURE

INSTRUMENTOS PARA SUTURA

STRUMENTI PER SUTURA



Unterbindungsnadeln
 Ligature Needles
 Aiguilles à ligature
 Agujas para ligadura
 Aghi per legatura

NAHT-INSTRUMENTE

SUTURING INSTRUMENTS

INSTRUMENTS À SUTURE

INSTRUMENTOS PARA SUTURA

STRUMENTI PER SUTURA

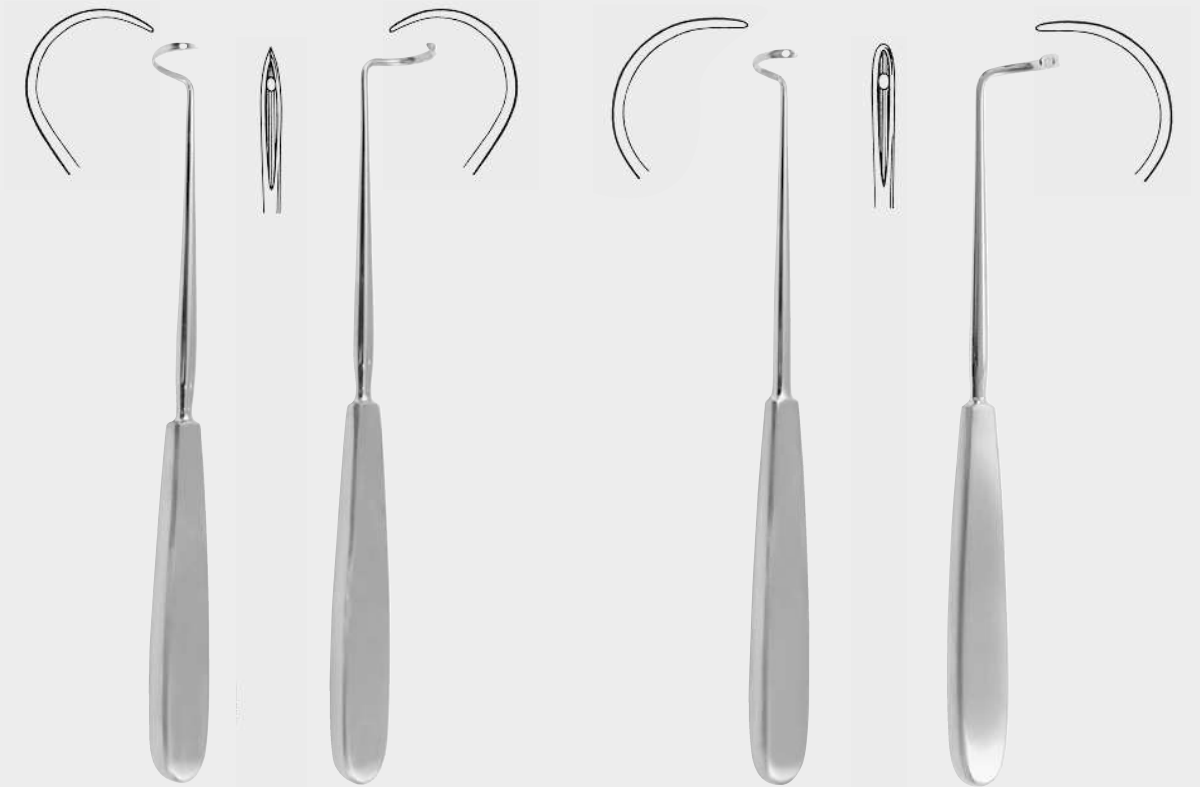

»	DESCHAMPS	«
26-1100-21	21,0 cm	26-1101-21
26-1100-24	24,0 cm	26-1101-24
26-1100-27	27,0 cm	26-1101-27

»	DESCHAMPS	«
26-1200-21	21,0 cm	26-1201-21
26-1200-24	24,0 cm	26-1201-24
26-1200-27	27,0 cm	26-1201-27

» = für rechte Hand - for right hand - pour la main droite
 para la mano derecha - per la mano destra
 « = für linke Hand - for left hand - pour la main gauche
 para la mano izquierda - per la mano sinistra



»	KRONECKER	«
26-1300-13	13,0 cm	26-1301-13

cm	COOPER
19,0	26-1309-19

»	NELSON	«
26-1303-24	24,5 cm	26-1305-24

cm	SYME
16,5	26-1315-16

cm	JONESCO
18,5	26-1311-18



Unterbindungsnadeln
Ligature Needles
Aiguilles à ligature
Agujas para ligadura
Aghi per legatura



REVERDIN (ALBARRAN)
26-2001-15 - 26-2004-23



cm	Fig. 1
15,0	26-2001-15
19,0	26-2001-19
21,0	26-2001-21
23,0	26-2001-23

cm	Fig. 2
15,0	26-2002-15
19,0	26-2002-19
21,0	26-2002-21
23,0	26-2002-23

cm	Fig. 3
15,0	26-2003-15
19,0	26-2003-19
21,0	26-2003-21
23,0	26-2003-23

cm	Fig. 4
15,0	26-2004-15
19,0	26-2004-19
21,0	26-2004-21
23,0	26-2004-23

NAHT-INSTRUMENTE

SUTURING INSTRUMENTS

INSTRUMENTS À SUTURE

INSTRUMENTOS PARA SUTURA

STRUMENTI PER SUTURA



Fig. 1
26-2400-01

Fig. 2
26-2400-02

Fig. 3
26-2400-03

cm	YOUNG BOOMERANG
25,0	26-2400-00

incl. 1 x 26-2400-01 Fig. 1
incl. 1 x 26-2400-02 Fig. 2
incl. 1 x 26-2400-03 Fig. 3



cm	BRUNNER
24,0	26-2410-24



cm	SCHMIEDEN
19,0	26-2701-19



cm	SCHMIEDEN-PAYR
19,0	26-2703-19

Nadelhalter, Führungs-Hohlsonden
Needle Holder, Ligature Conductors
Porte-aiguilles, Sondes conductrices
Porta-aguja, Sondas conductoras
Port'aghi, Sonde conduttrici

Führungs-Hohlsonden
 Ligature Conductors
 Sondes conductrices
 Sondas conductoras
 Sonde conduttrici

NAHT-INSTRUMENTE

SUTURING
 INSTRUMENTS

INSTRUMENTS
 À SUTURE

INSTRUMENTOS
 PARA SUTURA

STRUMENTI
 PER SUTURA

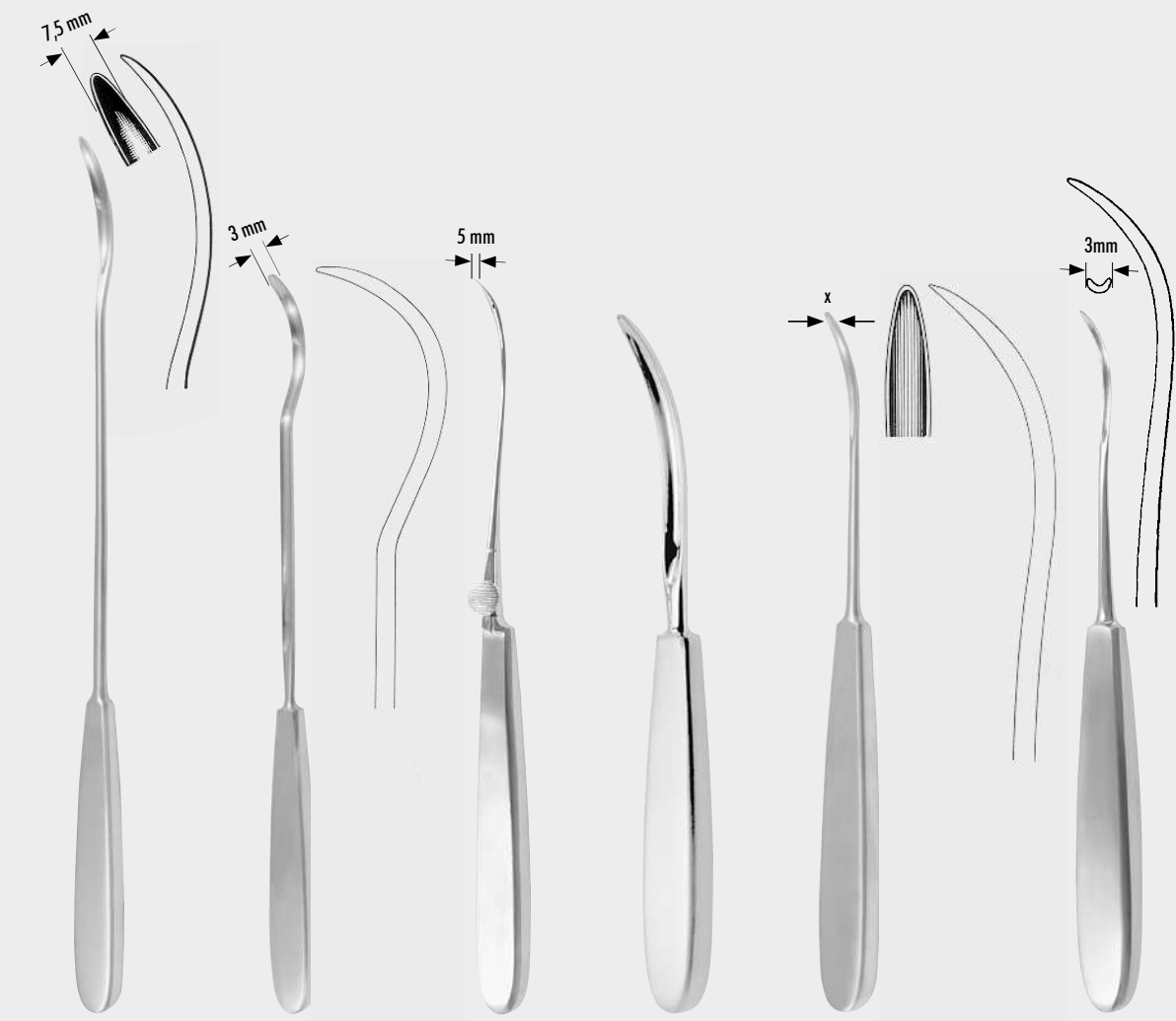

cm	BRUNNER	cm	KIRSCHNER	cm	PAYR	cm	MARTIN	cm	KOENIG	x = mm	cm	KOENIG
30,0	26-2705-30	25,5	26-2707-25	20,0	26-2711-20	19,5	26-2801-19	19,5	26-2803-19	5,0	19,5	26-2807-19
								20,0	26-2805-20	7,0		

Kunststoff, sterilisierbar
 Plastic material, autoclavable
 Matière plastique, stérilisable
 Materia plástica, esterilizabile
 In plastica, sterilizzabile

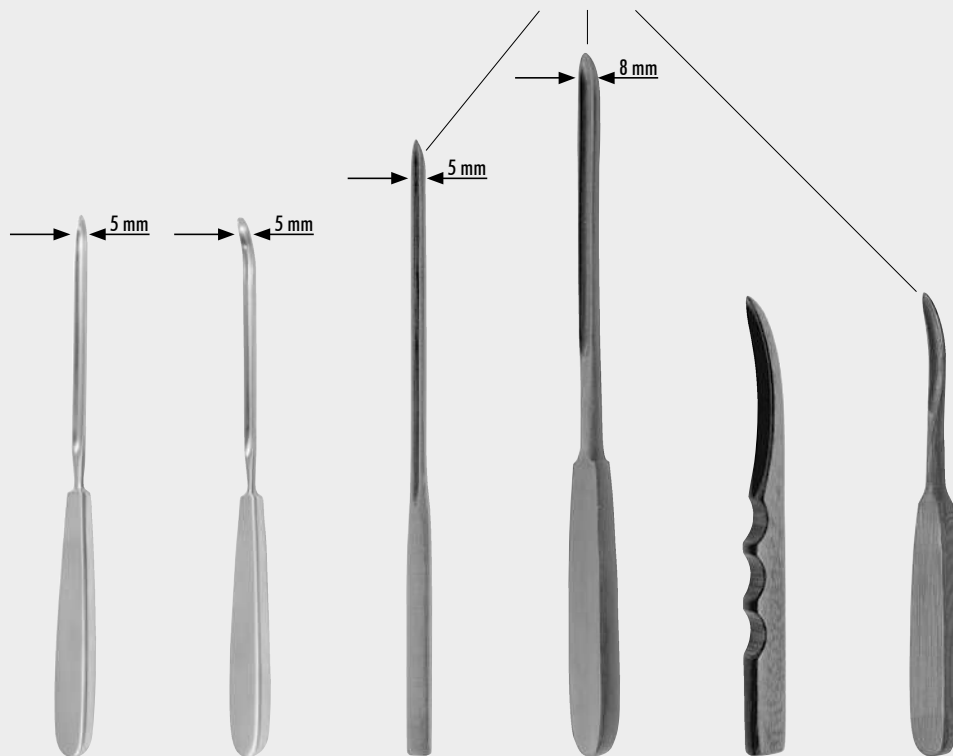

cm PAYR
22,0 26-2808-22

cm PAYR
22,0 26-2809-22

cm
24,0 26-2812-24

cm KIRSCHNER
27,0 26-2815-27

cm
19,0 26-2817-19

cm BRUNNER
18,0 26-2901-18
27,0 26-2901-27

Führungs-Hohlsonden
 Ligature Conductors
 Sondes conductrices
 Sondas conductoras
 Sonde conduttrici

NAHT-INSTRUMENTE

SUTURING INSTRUMENTS

INSTRUMENTS À SUTURE

INSTRUMENTOS PARA SUTURA

STRUMENTI PER SUTURA



cm
23,0 26-2904-23



cm NEGUS
22,0 26-2906-22



cm Mod. WIEN
23,5 26-2910-23

Fadengabel
 Knot Tier and Ligature Adjuster
 Instrument pour ligature dans la profondeur
 Instrumento para ligaduras profundas
 Strumento per legatura profonda

Nähnadeln
Suturing Needles
Aiguilles à suture
Agujas para sutura
Aghi per sutura

NAHT-INSTRUMENTE

SUTURING INSTRUMENTS

INSTRUMENTS À SUTURE

INSTRUMENTOS PARA SUTURA

STRUMENTI PER SUTURA

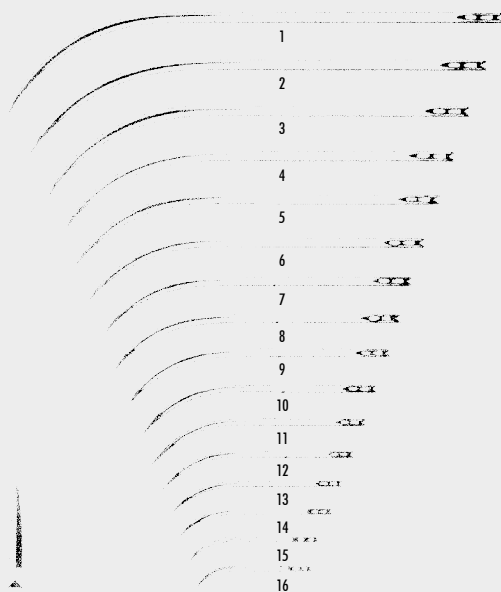

26-4003-01 - 26-4003-16

A

In Packungen zu 1 Dutzend
In packages of 1 dozen
En paquets de 1 douzaine
En sobres de 1 dozena
In bustine di 1 dozzina

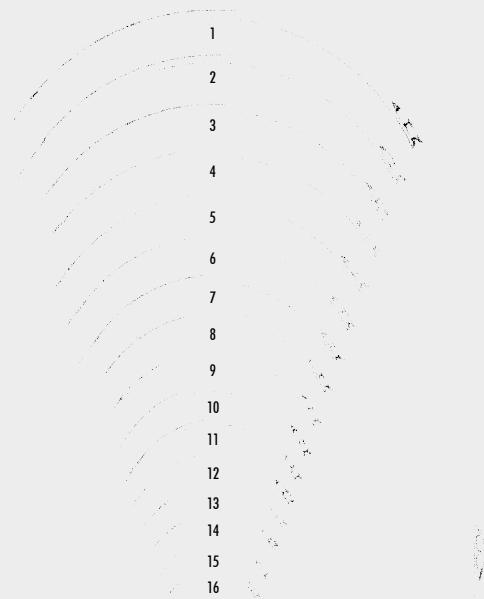

26-4103-01 - 26-4103-16

B

Alle Nadeln mit Federöhr
All needles with spring eye
Toutes les aiguilles à chas à ressort
Todas las agujas con ojo de resorte
Tutti gli aghi con cruna aperta

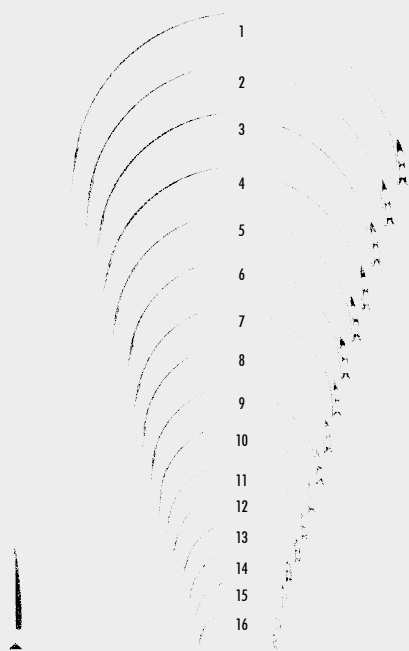

26-4203-01 - 26-4203-16

G

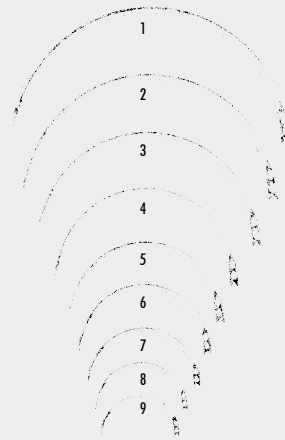

26-4303-01 - 26-4303-09

Gα

Fig. 1	1	2	3	4	5	6	7	8	9	10	11	12	13	14	15	16
A	26-4003-01	26-4003-02	26-4003-03	26-4003-04	26-4003-05	26-4003-06	26-4003-07	26-4003-08	26-4003-09	26-4003-10	26-4003-11	26-4003-12	26-4003-13	26-4003-14	26-4003-15	26-4003-16
B	26-4103-01	26-4103-02	26-4103-03	26-4103-04	26-4103-05	26-4103-06	26-4103-07	26-4103-08	26-4103-09	26-4103-10	26-4103-11	26-4103-12	26-4103-13	26-4103-14	26-4103-15	26-4103-16
G	26-4203-01	26-4203-02	26-4203-03	26-4203-04	26-4203-05	26-4203-06	26-4203-07	26-4203-08	26-4203-09	26-4203-10	26-4203-11	26-4203-12	26-4203-13	26-4203-14	26-4203-15	26-4203-16
Gα	26-4303-01	26-4303-02	26-4303-03	26-4303-04	26-4303-05	26-4303-06	26-4303-07	26-4303-08	26-4303-09							

Nähnadeln
Suturing Needles
Aiguilles à suture
Agujas para sutura
Aghi per sutura

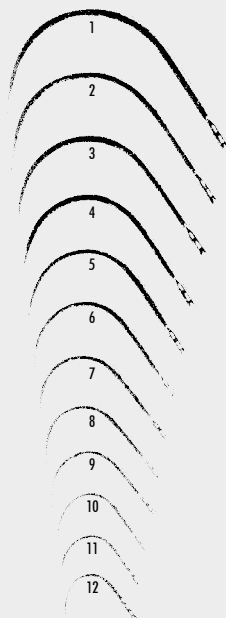

KOENIG
26-4401-01 - 26-4401-12

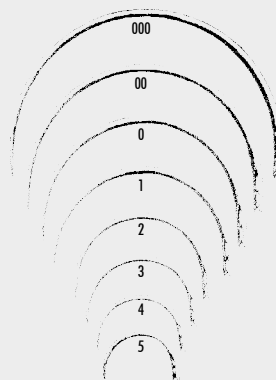

26-4403-30 - 26-4403-05
E

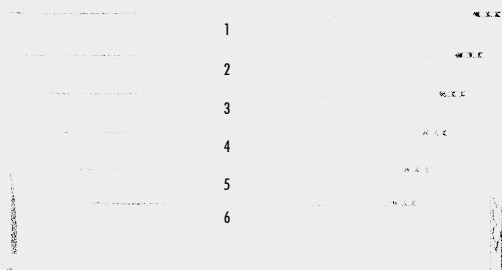

KEITH
26-4500-01 - 26-4500-06

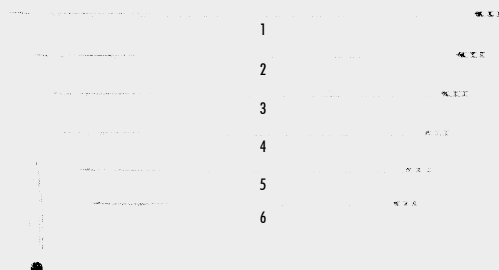

KEITH R
26-4502-01 - 26-4502-06

In Packungen zu 1 Dutzend
In packages of 1 dozen
En paquets de 1 douzaine
En sobres de 1 docena
In bustine di 1 dozzina

Alle Nadeln mit Federöhr
All needles with spring eye
Toutes les aiguilles à chas à ressort
Todas las agujas con ojo de resorte
Tutti gli aghi con cruna aperta

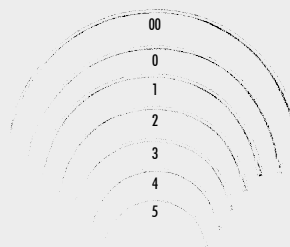

26-4605-20 - 26-4607-05
Pb

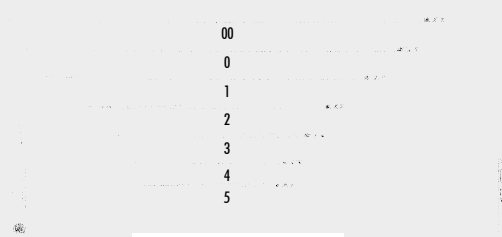

26-4705-20 - 26-4707-05
Pc

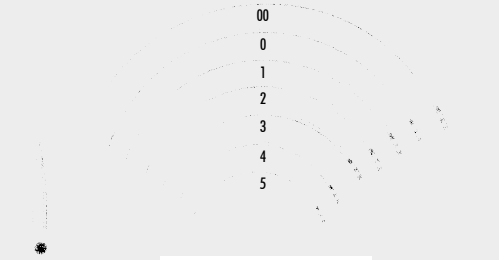

26-4805-20 - 26-4807-05
Pd

NAHT-INSTRUMENTE

SUTURING INSTRUMENTS

INSTRUMENTS À SUTURE

INSTRUMENTOS PARA SUTURA

STRUMENTI PER SUTURA

Fig.	000	00	0	1	2	3	4	5	6	7	8	9	10	11	12
KOENIG				26-4401-01	26-4401-02	26-4401-03	26-4401-04	26-4401-05	26-4401-06	26-4401-07	26-4401-08	26-4401-09	26-4401-10	26-4401-11	26-4401-12
E	26-4403-30	26-4403-20	26-4403-10	26-4403-01	26-4403-02	26-4403-03	26-4403-04	26-4403-05							
KEITH				26-4500-01	26-4500-02	26-4500-03	26-4500-04	26-4500-05	26-4500-06						
KEITH				26-4502-01	26-4502-02	26-4502-03	26-4502-04	26-4502-05	26-4502-06						
Pb		26-4605-20	26-4605-10	26-4607-01	26-4607-02	26-4607-03	26-4607-04	26-4607-05	26-4607-06	26-4607-07	26-4607-08				
Pc		26-4705-20	26-4705-10	26-4707-01	26-4707-02	26-4707-03	26-4707-04	26-4707-05							
Pd		26-4805-20	26-4805-10	26-4807-01	26-4807-02	26-4807-03	26-4807-04	26-4807-05							



Leichennadeln, Wundklammerinstrumente
 Post Mortem Needles, Instruments for Clips
 Aiguilles à autopsie, Instruments à agrafes
 Agujas para autopsia, instrumentos p. agrafes
 Aghi per autopsia, strumenti per agrafe

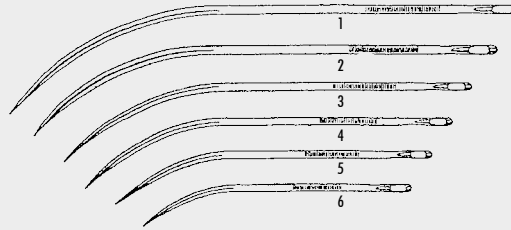

In Packungen zu 1 Dutzend
 In packages of 1 dozen
 En paquets de 1 douzaine
 En sobres de 1 docena
 In bustine di 1 dozzina

Fig.

1	26-4891-01
2	26-4891-02
3	26-4891-03
4	26-4891-04
5	26-4891-05
6	26-4891-06

NAHT-INSTRUMENTE

SUTURING INSTRUMENTS

INSTRUMENTS À SUTURE

INSTRUMENTOS PARA SUTURA

STRUMENTI PER SUTURA



cm LAUGE
10,0 26-5988-10



cm OCHSNER
14,0 26-5990-14



cm FRICKE
13,0 26-5996-13



cm MICHEL
12,0 26-6100-12

Leichennadeln, Wundklammerinstrumente
 Post Mortem Needles, Instruments for Clips
 Aiguilles à autopsie, Instruments à agrafes
 Aguijas para autopsia, instrumentos p. agrafes
 Aghi per autopsia, strumenti per agrafe



cm WACHENFELDT
 12,5 26-6102-12



cm WACHENFELDT
 12,5 26-6104-12



cm HEGENBARTH
 12,5 26-6106-12

NAHT-INSTRUMENTE

SUTURING
 INSTRUMENTS

INSTRUMENTS
 À SUTURE

INSTRUMENTOS
 PARA SUTURA

STRUMENTI
 PER SUTURA



cm CHILDE
 18,0 26-6200-18



x = mm	16,0 cm
7,5	26-6204-07
12,0	26-6204-12
14,0	26-6204-14
16,0	26-6204-16
18,0	26-6204-18
20,0	26-6204-20



cm MICHEL
 12,0 26-6300-12



cm MICHEL
 13,0 26-6301-13

Wundklammerzängchen,
Wundklammern
Clip Forceps, Clips
Pinces à agrafes, Agrafes
Pinzas para agrafes, Agrafes
Pinze per agrafe, Agrafe

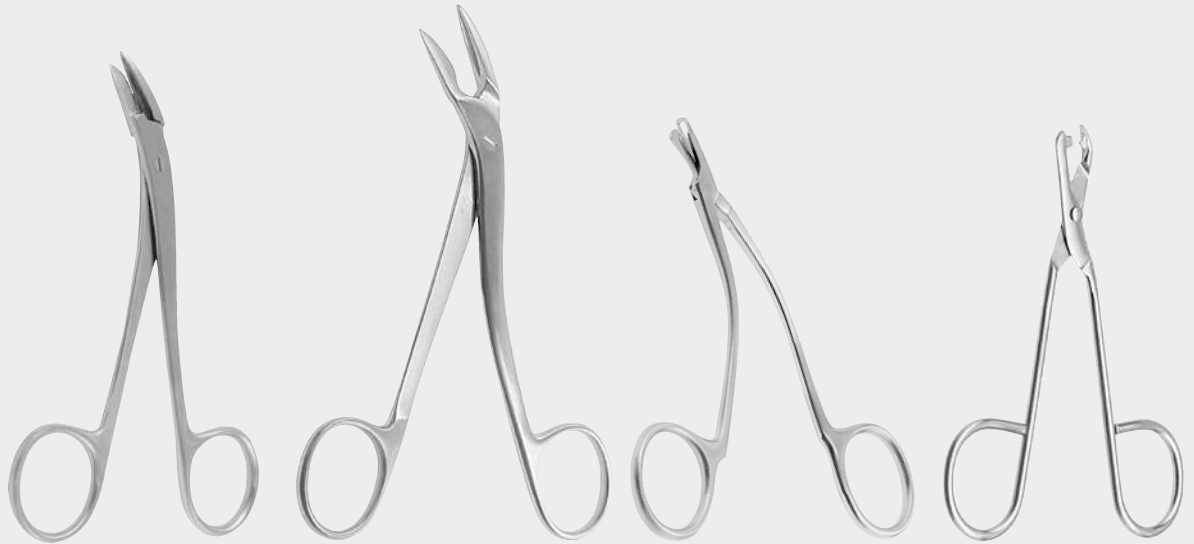

cm COLLIN
13,0 26-6400-13

cm RICHTER-HEATH
14,0 26-6402-14

cm
11,0 26-6500-11

cm
10,5 26-6502-10

NAHT-INSTRUMENTE

SUTURING INSTRUMENTS

INSTRUMENTS À SUTURE

INSTRUMENTOS PARA SUTURA

STRUMENTI PER SUTURA

Wundklammerbesteck, Taschenbesteck
Suturing Kit, Pocket Kit
Trousse de poche et à agrafes
Estuche de agrafes y de bolsillo
Astucci tascabili e per sutura



cm GUY'S
15,0 26-6550-15

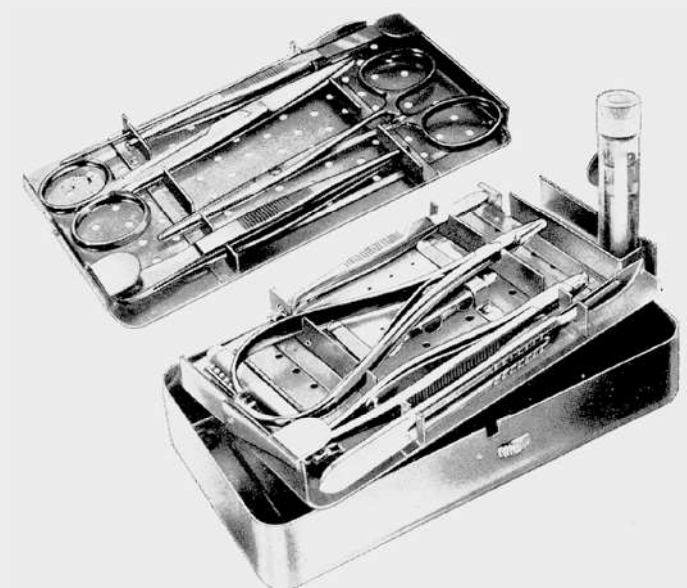

STANDARD
26-6800-00
165 x 90 x 28 mm

HILFSINSTRUMENTE FÜR DIE STERILISATION

AUXILIARY INSTRUMENTS FOR STERILIZATION

INSTRUMENTS AUXILIAIRES POUR LA STÉRILISATION

INSTRUMENTOS AUXILIARES PARA LA ESTERILIZACIÓN

STRUMENTI AUSILIARI PER LA STERILIZZAZIONE

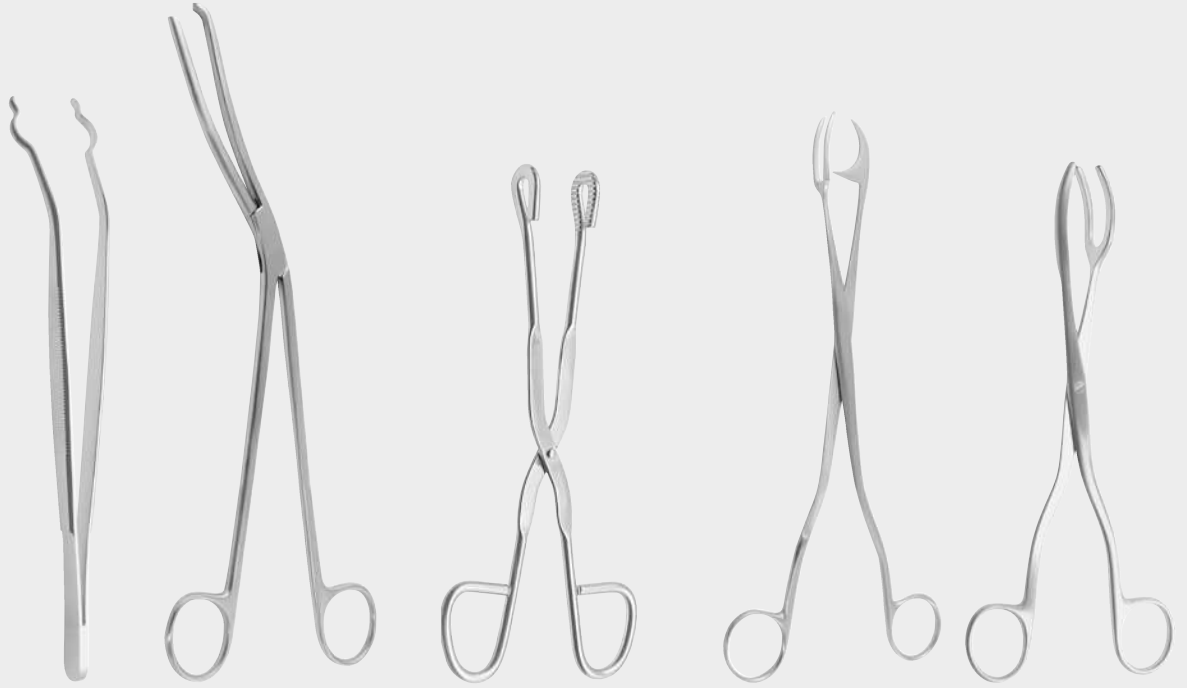

HILFSINSTRUMENTE
FÜR DIE STERILISATION

AUXILIARY INSTRUMENTS
FOR STERILIZATION

INSTRUMENTS AUXILIAIRES
POUR LA STÉRILISATION

INSTRUMENTOS AUXILIARES
PARA LA ESTERILIZACIÓN

STRUMENTI AUSILIARI
PER LA STERILIZZAZIONE

cm	DAVIS	cm	CHEATLE	cm	UNIVERSAL	cm	ROGGE	cm
16,0	28-1002-16	27,0	28-1100-27	20,0	28-1200-20	23,0	28-1300-23	20,0
20,0	28-1002-20			28,0	28-1200-28			30,0
24,0	28-1002-24							28-1400-30



cm PYE-SMITH (HARRISON)
30,0 28-1405-30



cm HARRISON
36,0 28-1407-36
46,0 28-1407-46



cm BUNT
12,0 28-1500-12



cm MAYO
14,0 28-1502-14



cm MAYO
12,5 28-1510-12



cm	WEINSTEIN
15,0	28-1550-15
20,0	28-1550-20
25,0	28-1550-25
30,0	28-1550-30



cm	WEISENBACH
15,0	28-1552-15
30,0	28-1552-30

Abfallzange
 Waste Collecting Forceps
 Pince à déchets
 Pinza para desperdicios
 Pinza per rifiuti

72 mm



cm	SAUERBRUCH
55,0	28-1610-55

HILFSINSTRUMENTE
 FÜR DIE STERILISATION

AUXILIARY INSTRUMENTS
 FOR STERILIZATION

INSTRUMENTS AUXILIAIRES
 POUR LA STÉRILISATION

INSTRUMENTOS AUXILIARES
 PARA LA ESTERILIZACIÓN

STRUMENTI AUSILIARI
 PER LA STERILIZZAZIONE

HILFSINSTRUMENTE
FÜR DIE STERILISATION

AUXILIARY INSTRUMENTS
FOR STERILIZATION

INSTRUMENTS AUXILIAIRES
POUR LA STÉRILISATION

INSTRUMENTOS AUXILIARES
PARA LA ESTERILIZACIÓN

STRUMENTI AUSILIARI
PER LA STERILIZZAZIONE

GIPS

PLASTER

PLÂTRE

YESOS

GESSI

Gipsscheren
Plaster Cast Shears
Ciseaux à plâtre
Cizallas para yesos
Forbici per gessi

GIPS

PLASTER

PLÂTRE

YESOS

GESSI

Gipssägen
Plaster Cast Saws
Scies à plâtre
Sierras para yesos
Seghe per gessi



cm STILLE
24,0 30-1001-24

cm STILLE
26,0 30-1002-26
36,0 30-1002-36

cm STILLE
18,0 30-1003-18
20,0 30-1003-20
23,0 30-1003-23
26,0 30-1003-26
37,0 30-1003-37

cm SEUTIN
23,0 30-1004-23



cm WIGMORE
19,0 30-1200-19



cm ENGEL
30-1300-14



cm BERGMANN
30-1304-18



VOLT	compl.
110	30-2100-21
220	30-2100-22



Volt	
220	30-2200-22



ø mm		Typ
50	30-2100-50	normal
50	30-2101-50	hart / hard / dure / dura
65	30-2100-65	normal
65	30-2101-65	hart / hard / dure / dura

Elektrische Gipssäge
 Electrical Plaster Cast Cutter
 Scie à appareils plâtrés électrique
 Sierra para yesos eléctrica
 Sega per gessi elettrica

Elektrische Gipssäge mit Staubabsaugung
 Electrical Plaster Cast Cutter with Dust Evacuation
 Scie à plâtrés électrique avec aspiration de la poussière
 Sierra para yeso eléctrica con aspiración de polvo
 Sega elettrica per gessi con aspirazione di polvo



30-2102-02

GIPS

PLASTER

PLÂTRE

YESOS

GESSI



VOLT	compl.
110	30-2110-21
220	30-2110-22



30-2120-17

Akkumulator allein 1700 mAh
 Battery rechargeable only 1700 mAh
 Accumulateur seul 1700 mAh
 Acumulador suelto 1700 mAh
 Accumolatore solo 1700 mAh

Elektrische Gipssäge mit Akkumulator
 Electrical Plaster Cast Cutter with rechargeable battery
 Scie à plâtrés électrique avec accumulateur
 Sierra para yeso eléctrica con acumulador
 Sega elettrica per gessi con accumulatore



VOLT	
110	30-2130-11
220	30-2130-22

Schnell-Ladegerät für Akkumulator
 Battery Charger Unit
 Charge-accumulateur
 Unidad de carga para acumulador
 Apparechio di carica per accumulatore

Gipsspreizer
Plaster Cast Spreaders
Écarteurs à plâtre
separadores para yesos
Divaricatori per gessi

GIPS

PLASTER

PLÂTRE

YESOS

GESSI

Gipsmesser, Gipsabreisszangen
Plaster Cast Knives, Plaster Breakers
Couteaux à plâtre,
Pincas à enlever les plâtres
Cuchillos para yesos, Pinzas para
quitar yesos
Coltelli e pinze per gessi, Pinze per
rompere gessi



cm HENNING
28,0 30-3500-28



cm BEESON
30,0 30-3600-30



cm HAGLUND-STILLE
28,0 30-3602-28



23,0 30-3606-23

Einhandbedienung
Single hand operated
Utilisation par une seule main
Usò por una mano sólo
Usò da una mano sola



cm HOPKINS
20,0 30-3700-20



cm ESMARCH
18,0 30-3800-18



cm REINER
18,0 30-3900-18

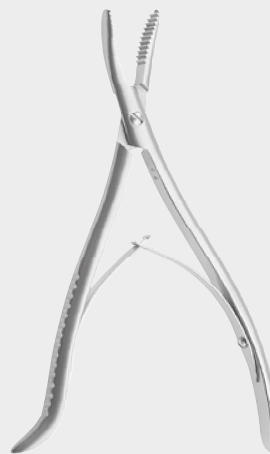

cm
18,0 30-3903-18

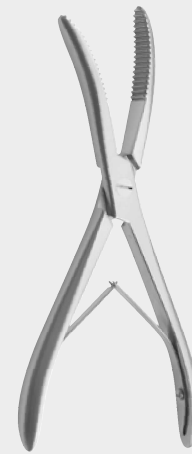

cm WOLFF
18,0 30-3905-18

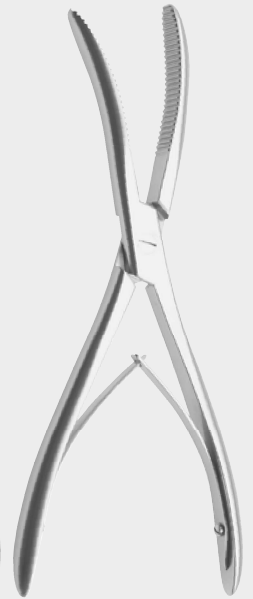

cm WOLFF
24,0 30-3907-24

ZEPF®
α

INSTRUMENTS

30-3500-28 - 30-3907-24

KNOCHENCHIRURGIE

BONE SURGERY

CHIRURGIE OSSEUSE

CIRUGÍA ÓSEA

CHIRURGIA OSSEA

Hohlmeisselzangen
 Bone Rongeurs
 Pincés-gouges
 Pinzas gubias
 Pinze sgorbie

KNOCHENCHIRURGIE

BONE SURGERY

CHIRURGIE OSSEUSE

CIRUGÍA ÓSEA

CHIRURGIA OSSEA



cm FRIEDMANN VICKERS
 14,0 32-1000-14

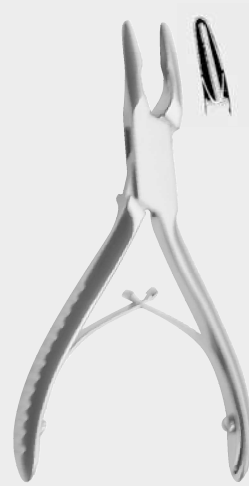

cm FRIEDMANN mini
 12,0 32-1001-12



cm FRIEDMANN
 14,0 32-1001-14



cm FRIEDMANN
 14,0 32-1002-14

cm FRIEDMANN
 15,0 32-1002-15

Hohlmeisselzangen
 Bone Rongeurs
 Pincés-gouges
 Pinzas gubias
 Pinze sgorbie



cm CLEVELAND Fig. 4
 14,0 32-1003-14



cm CLEVELAND Fig. 4A
 17,0 32-1005-17

KNOCHENCHIRURGIE

BONE SURGERY

CHIRURGIE OSSEUSE

CIRUGÍA ÓSEA

CHIRURGIA OSSEA



cm MEAD Fig. 1A
 16,5 32-1007-16



cm MEAD Fig. 2A
 16,5 32-1009-16



cm GLASGOW
 14,5 32-1011-14

Hohlmeisselzangen
 Bone Rongeurs
 Pincés-gouges
 Pinzas gubias
 Pinze sgorbie

KNOCHENCHIRURGIE

BONE SURGERY

CHIRURGIE OSSEUSE

CIRUGÍA ÓSEA

CHIRURGIA OSSEA



cm COHEN
 14,0 32-1013-14



cm BLUMENTHAL
 15,5 32-1105-15



cm BLUMENTHAL
 15,5 32-1107-15



cm BLUMENTHAL
 15,5 32-1109-15



cm LUER
15,0 32-1301-15



cm LUER
15,0 32-1303-15



cm LUER
15,0 32-1305-15



cm LUER
17,0 32-1306-17 32-1307-17

Hohlmeisselzangen
Bone Rongeurs
Pinces-gouges
Pinzas gubias
Pinze sgorbie

KNOCHENCHIRURGIE

BONE SURGERY

CHIRURGIE OSSEUSE

CIRUGÍA ÓSEA

CHIRURGIA OSSEA

Hohlmeisselzangen
 Bone Rongeurs
 Pincés-gouges
 Pinzas gubias
 Pinze sgorbie

KNOCHENCHIRURGIE

BONE SURGERY

CHIRURGIE OSSEUSE

CIRUGÍA ÓSEA

CHIRURGIA OSSEA



cm BANE 4,0 mm
 18,0 32-1315-18



cm CLOVIS VINCENT
 21,0 32-1381-21
 26,0 32-1381-26



cm CLOVIS VINCENT
 21,0 32-1383-21
 26,0 32-1383-26



cm ADSON
 20,0 32-1402-20 32-1403-20



cm OLIVECRONA
20,0 32-1407-20



cm LEMPERT JUERS 3,0 mm
20,0 32-1499-20

Hohlmeisselzangen
Bone Rongeurs
Pinces-gouges
Pinzas gubias
Pinze sgorbie

KNOCHENCHIRURGIE

BONE SURGERY

CHIRURGIE OSSEUSE

CIRUGÍA ÓSEA

CHIRURGIA OSSEA



cm LEMPERT
16,0 32-1500-16 32-1501-16



cm LEMPERT
18,5 32-1504-18 32-1505-18



cm HAKANSSON
17,0 32-1507-17

Hohlmeisselzangen
Bone Rongeurs
Pinces-gouges
Pinzas gubias
Pinze sgorbie

KNOCHENCHIRURGIE

BONE SURGERY

CHIRURGIE OSSEUSE

CIRUGÍA ÓSEA

CHIRURGIA OSSEA



cm	BEYER
18,0	32-1509-18



cm	BEYER	mm
17,0	32-1601-02	2,0
17,0	32-1601-03	3,0



cm	BACON
20,0	32-1605-20

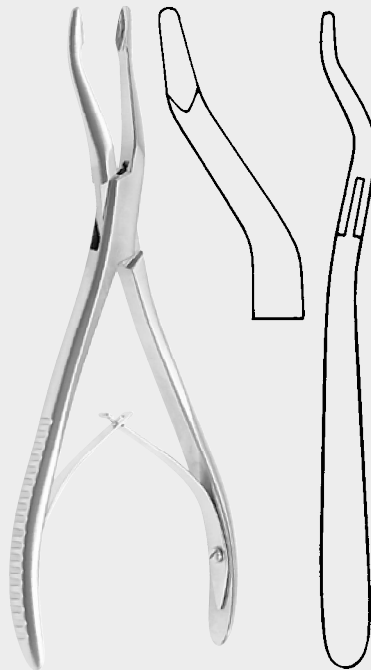

cm	JANSEN
19,0	32-1607-19



cm	GULEKE
20,5	32-1609-20



cm ST. GEORG
22,0 32-1611-22



STELLBRINK
32-1615-17 - 32-1617-17

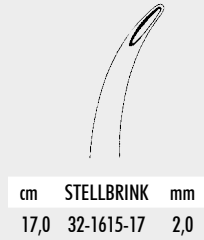

cm STELLBRINK mm
17,0 32-1615-17 2,0

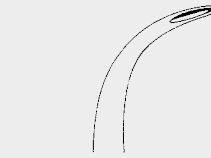

cm STELLBRINK mm
17,0 32-1617-17 2,0

Hohlmeisselzangen
Bone Rongeurs
Pinces-gouges
Pinzas gubias
Pinze sgorbie

KNOCHENCHIRURGIE

BONE SURGERY

CHIRURGIE OSSEUSE

CIRUGÍA ÓSEA

CHIRURGIA OSSEA



cm SICARD
24,0 32-1612-24



cm SICARD 3,0 mm
19,0 32-1619-19

Hohlmeisselzangen
 Bone Rongeurs
 Pincés-gouges
 Pinzas gubias
 Pinze sgorbie



cm JANSEN
 18,0 32-1620-18

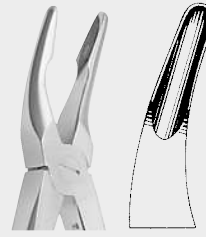

cm JANSEN
 18,0 32-1621-18

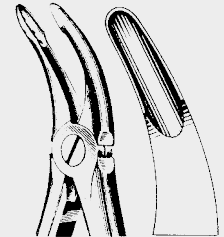

cm JANSEN
 18,0 32-1623-18

KNOCHENCHIRURGIE

JANSEN
 32-1620-18 - 32-1623-18

BONE SURGERY

CHIRURGIE OSSEUSE

CIRUGÍA ÓSEA

CHIRURGIA OSSEA



cm HARTMANN
 18,5 32-1631-18



cm UNIVERSAL
 13,5 32-1635-13

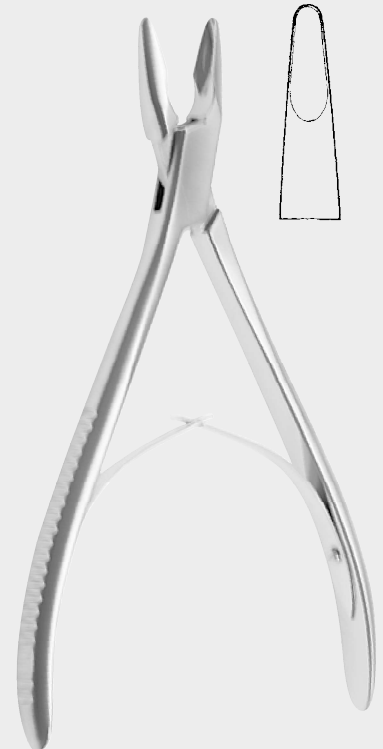

cm PENNYBACKER mm
 20,5 32-1638-20 4,0



cm FALCONER mm
20,5 32-1641-20 6,0



cm TROTTER mm
20,5 32-1643-20 10,0



cm WILMS
20,5 32-1645-20

Hohlmeisselzangen
Bone Rongeurs
Pincés-gouges
Pinzas gubias
Pinze sgorbie

KNOCHENCHIRURGIE

BONE SURGERY

CHIRURGIE OSSEUSE

CIRUGÍA ÓSEA

CHIRURGIA OSSEA

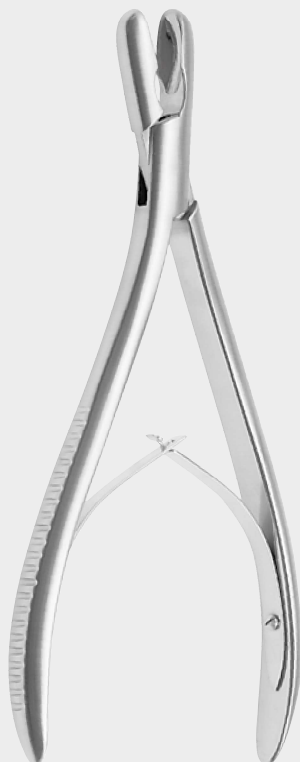

cm NORTHFIELD
20,5 32-1647-20



cm KLEINERT KUTZ
15,0 32-1689-15



cm BEYER
18,0 32-2001-18

Hohlmeisselzangen
 Bone Rongeurs
 Pincès-gouges
 Pinzas gubias
 Pinze sgorbie

KNOCHENCHIRURGIE

BONE SURGERY

CHIRURGIE OSSEUSE

CIRUGÍA ÓSEA

CHIRURGIA OSSEA



cm GEIGER 3,0 mm
 15,0 32-2003-15



cm ZAUFAL-JANSEN
 18,0 32-2005-18



cm	mm	BÖHLER (RUSKIN MINI)	
15,0	2	32-2100-15	32-2101-15
15,0	3	32-2102-15	32-2103-15



cm	RUSKIN		
18,0	32-2106-18	32-2107-18	32-2111-18



cm	RUSKIN	
23,0	32-2108-23	32-2109-23

Hohlmeißelzangen
 Bone Rongeurs
 Pincés-gouges
 Pinzas gubias
 Pinze sgorbie

KNOCHENCHIRURGIE

BONE SURGERY

CHIRURGIE OSSEUSE

CIRUGÍA ÓSEA

CHIRURGIA OSSEA



cm RÖTTGEN-RUSKIN 
 24,0 32-2121-24



nn FULTON 
 15,0 x 16,0 32-2123-24
 24,0 cm

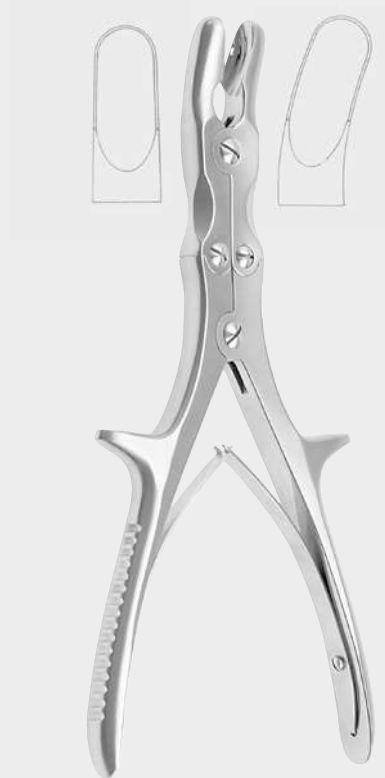

cm  STILLE-LUER 
 22,0 32-2300-22 32-2301-22
 26,0 32-2300-26 32-2301-26

seitwärts
 side curved
 courbe latéralement
 curvo lateralmente
 curvo laterale



cm STILLE LUER 
 23,0 32-2302-23
 27,0 32-2302-27



cm STILLE LUER 
 23,0 32-2303-23
 27,0 32-2303-27



cm STILLE-LUER (DUCKBILL)
 23,0 32-2305-23

Hohlmeisselzangen
 Bone Rongeurs
 Pincés-gouges
 Pinzas gubias
 Pinze sgorbie

KNOCHENCHIRURGIE

BONE SURGERY

CHIRURGIE OSSEUSE

CIRUGÍA ÓSEA

CHIRURGIA OSSEA



cm	STILLE-RUSKIN
23,0	32-2307-23

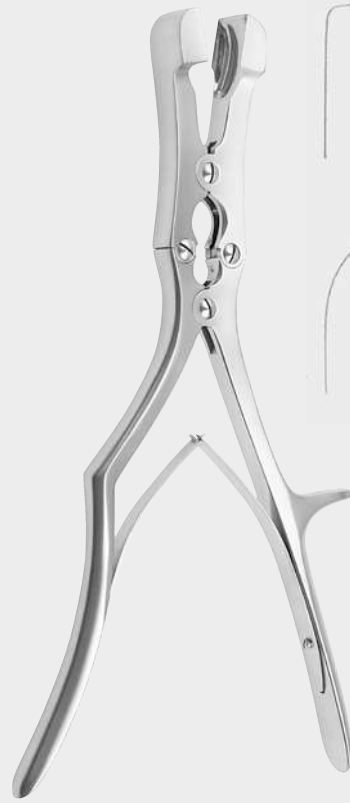

Fig.	SAUERBRUCH 30,0 cm
1	32-2401-30
2	32-2403-30

seitwärts
 side curved
 courbe latéralement
 curvo lateralmente
 curvo laterale



mm	LEKSELL (STILLE)
5,0	32-2407-23



mm	LEKSELL (STILLE)
8,0	32-2405-23



mm	LEKSELL (STILLE)
5,0	32-2409-05



mm	LEKSELL (STILLE)
8,0	32-2409-08

mm	LEKSELL (STILLE), 23,0 cm
8,0	32-2405-23
5,0	32-2407-23

mm	LEKSELL (STILLE), 23,0 cm
5,0	32-2409-05
8,0	32-2409-08

Hohlmeisselzangen
 Bone Rongeurs
 Pincés-gouges
 Pinzas gubias
 Pinze sgorbie



» SCAGLIETTI «
 32-2501-26 26,0 cm 32-2503-26



cm FRYKHOLM
 24,0 32-2505-24

KNOCHENCHIRURGIE

BONE SURGERY

CHIRURGIE OSSEUSE

CIRUGÍA ÓSEA

CHIRURGIA OSSEA



2,0 mm 32-2509-02



3,0 mm 32-2509-03



4,0 mm 32-2509-04



mm ECHLIN 23,0 cm
 2,0 32-2509-02
 3,0 32-2509-03
 4,0 32-2509-04



cm SEMB
 22,5 32-2601-22
 27,0 32-2601-27

Hohlmeisselzangen
 Bone Rongeurs
 Pincés-gouges
 Pinzas gubias
 Pinze sgorbie

KNOCHENCHIRURGIE

BONE SURGERY

CHIRURGIE OSSEUSE

CIRUGÍA ÓSEA

CHIRURGIA OSSEA



3,0 mm 32-2602-24

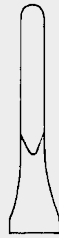

3,0 mm 32-2603-24



3,0 mm 32-2605-24



SMITH PETERSEN 24,0 cm
 3,0 mm 32-2602-24 - 32-2605-24



cm MARQUARDT
 20,0 32-2611-20



cm MAYFIELD
 17,0 32-2613-17

Hohlmeisselzangen
 Bone Rongeurs
 Pincés-gouges
 Pinzas gubias
 Pinze sgorbie

KNOCHENCHIRURGIE

BONE SURGERY

CHIRURGIE OSSEUSE

CIRUGÍA ÓSEA

CHIRURGIA OSSEA



cm SYPERT
 35,0 32-2623-03 - 32-2623-08



3,0 mm 32-2623-03



5,0 mm 32-2623-05



8,0 mm 32-2623-08

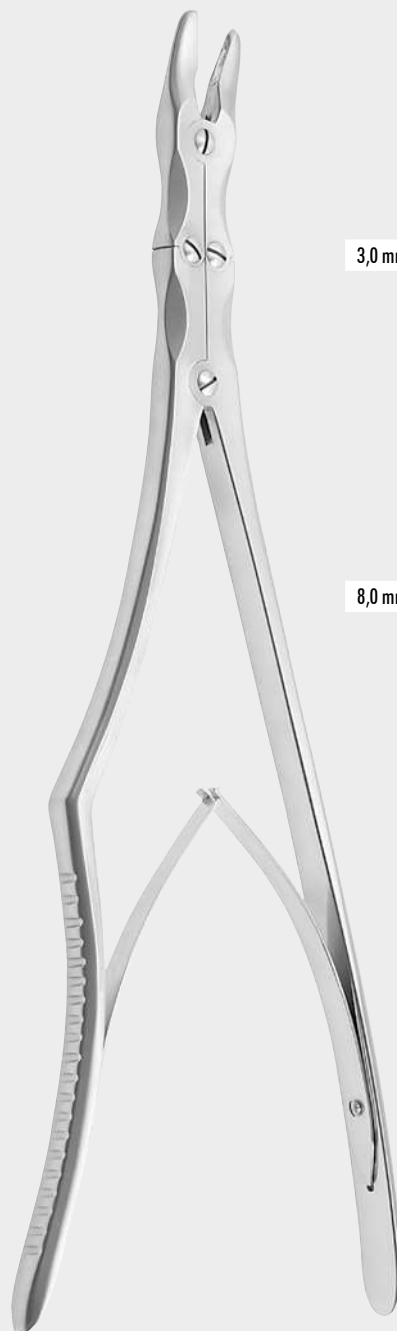

cm DALE
 35,0 32-2625-03 - 32-2625-08



3,0 mm 32-2625-03



8,0 mm 32-2625-08

Knochensplitterzangen
 Bone Cutting Forceps
 Pinces coupantes à os
 Pinzas cortantes para huesos
 Cesioie per ossa

KNOCHENCHIRURGIE

BONE SURGERY

CHIRURGIE OSSEUSE

CIRUGÍA ÓSEA

CHIRURGIA OSSEA



cm	STAMM
15,0	32-2701-15



cm	
12,0	32-2703-12



cm	—	LISTON	—
14,0	32-2704-14		32-2705-14
17,0	32-2704-17		32-2705-17
19,0	32-2704-19		32-2705-19
22,0	32-2704-22		32-2705-22

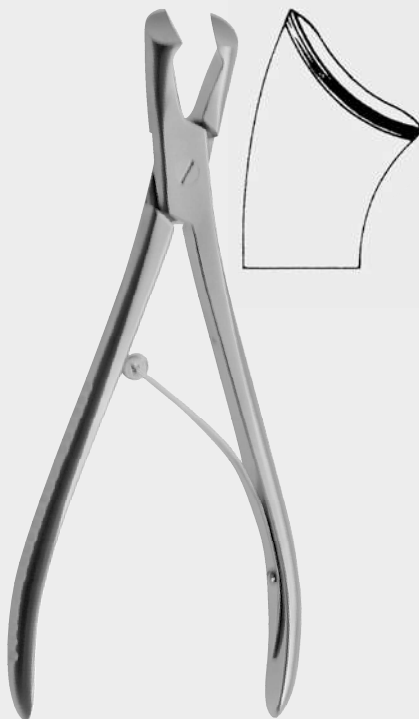

cm	MARKWALDER
20,0	32-2710-20



cm	CLEVELAND Fig. 5
17,0	32-2721-17



cm	CLEVELAND Fig. 5S
15,0	32-2723-15



cm CLEVELAND (GARDNER) Fig. 6
16,0 32-2727-16



cm COTTLE-KAZANJIAN
19,0 32-2782-19



cm CLEVELAND Fig. 6A
16,0 32-2725-16

Knochensplitterzangen
Bone Cutting Forceps
Pinces coupantes à os
Pinzas cortantes para huesos
Cesoie per ossa

KNOCHENCHIRURGIE

BONE SURGERY

CHIRURGIE OSSEUSE

CIRUGÍA ÓSEA

CHIRURGIA OSSEA

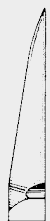

32-2802-15



32-2803-15



cm KLEINERT-KUTZ
15,0 32-2802-15 - 32-2803-15

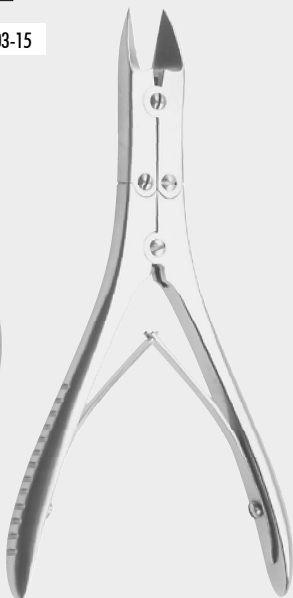

cm BÖHLER (WALTON LISTON)
15,0 32-2804-15 32-2805-15



cm McINDOE
17,5 32-2807-17



cm RUSKIN-LISTON
18,5 32-2808-18



32-2809-18



Knochensplitterzangen
 Bone Cutting Forceps
 Pinces coupantes à os
 Pinzas cortantes para huesos
 Cesoie per ossa

KNOCHENCHIRURGIE

BONE SURGERY

CHIRURGIE OSSEUSE

CIRUGÍA ÓSEA

CHIRURGIA OSSEA



cm RUSKIN-ROWLAND
 18,0 32-2820-18



cm RUSKIN-ROWLAND
 18,0 32-2821-18



cm
 17,0 32-2833-17

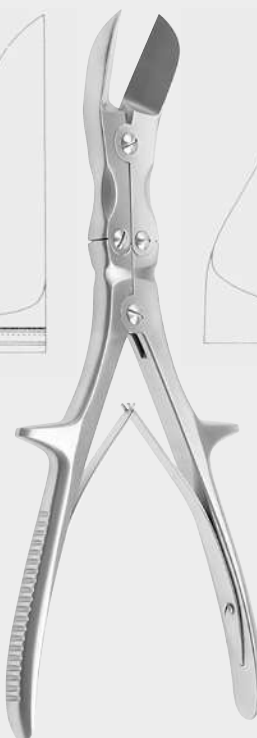
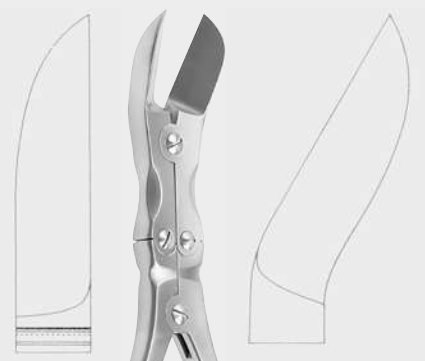

cm STILLE-LISTON
 23,5 32-2901-23
 27,0 32-2900-27 32-2901-27

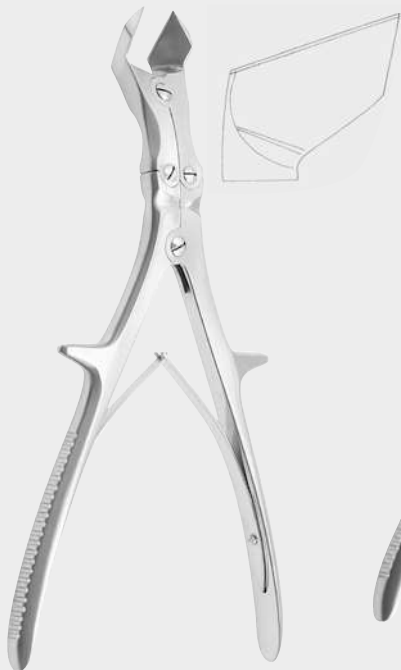

cm STILLE-HORSLEY
 27,0 32-2903-27

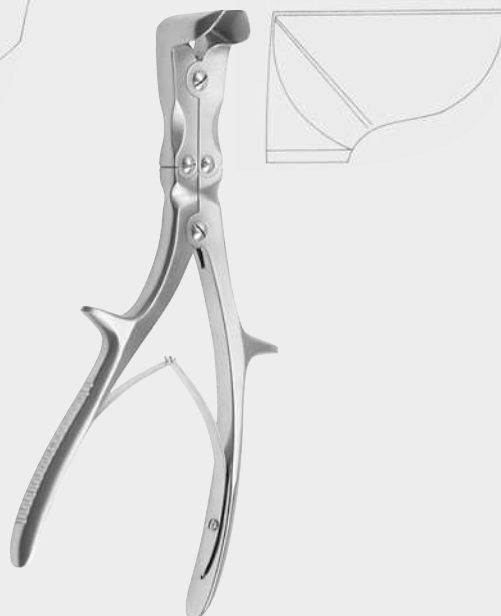

cm SEMB
 24,0 32-2905-24



cm STILLE LISTON
 27,0 32-2917-27

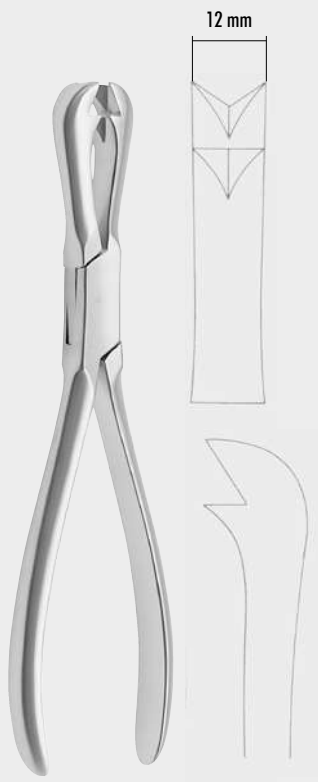

cm FERGUSSON
21,0 32-3600-21



cm LANGENBECK
21,0 32-3602-21

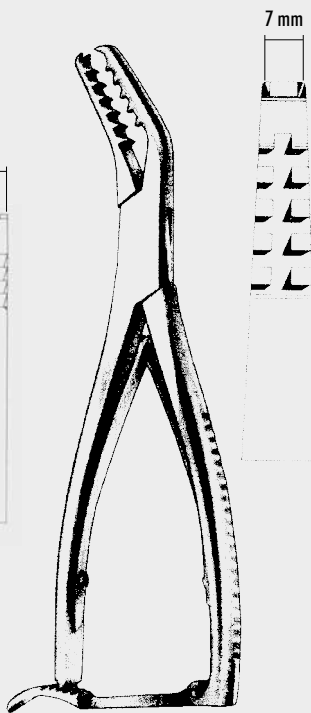

cm SEMB
19,0 32-3603-19



cm SEMB
19,0 32-3605-19

Knochenhalte­zangen
Bone Holding Forceps
Daviers porte-os
Pinzas para huesos
Tenaglie per ossa

KNOCHENCHIRURGIE

BONE SURGERY

CHIRURGIE OSSEUSE

CIRUGÍA ÓSEA

CHIRURGIA OSSEA



cm FARABEUF
23,0 32-3606-23
26,0 32-3606-26



cm FARABEUF-LAMBOTTE
26,0 32-3608-26



cm FARABEUF-LAMBOTTE
22,0 32-3700-22
27,0 32-3700-27
30,0 32-3700-30

Knochenhalte­zangen
Bone Holding Forceps
Daviers porte-os
Pinzas para huesos
Tenaglie per ossa



cm	LAMBOTTE
19,0	32-3703-19
23,0	32-3703-23
26,0	32-3703-26



cm	BISHOP
23,0	32-3704-23

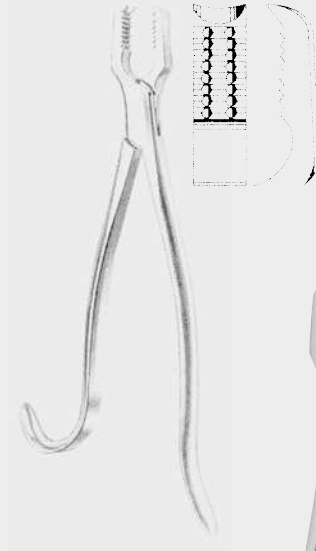

cm	KERN
15,0	32-3708-15
17,0	32-3708-17
21,0	32-3708-21



KNOCHENCHIRURGIE

cm	LAMBOTTE
22,0	32-3702-22
26,0	32-3702-26
33,0	32-3702-33

BONE SURGERY

cm	KERN
15,0	32-3800-15
17,0	32-3800-17
21,0	32-3800-21

CHIRURGIE OSSEUSE

CIRUGÍA ÓSEA

CHIRURGIA OSSEA



cm	LANE KERN
24,0	32-3802-24

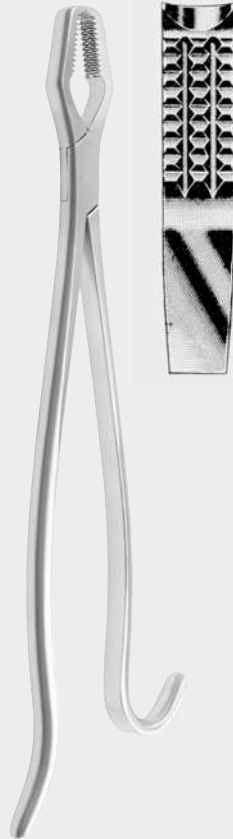

cm	LANE
33,0	32-3802-33
45,0	32-3802-45



cm	LANE
33,0	32-3804-33
45,0	32-3804-45

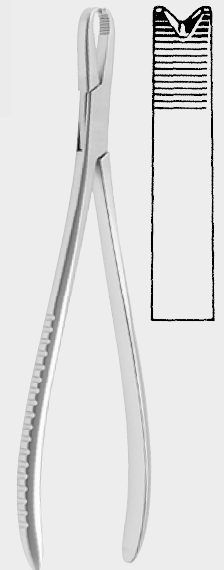

cm	LANE
20,0	32-3806-20



cm FROSCH
18,0 32-3810-18

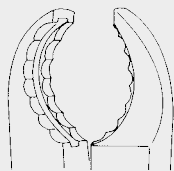

cm ULRICH
23,0 32-3812-23 32-3813-23

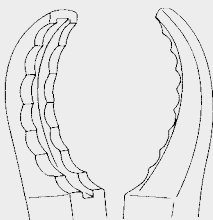

cm ULRICH
25,0 32-3812-25 32-3813-25

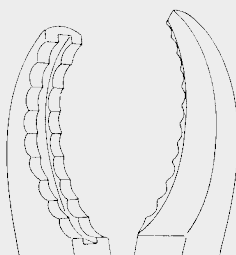

cm ULRICH
28,0 32-3812-28 32-3813-28



ULRICH
32-3812-23 - 32-3812-28



ULRICH
32-3813-23 - 32-3813-28



cm HEY GROVES
20,0 32-3820-20
25,0 32-3820-25
30,0 32-3820-30

Knochenhalte­zangen
Bone Holding Forceps
Pinces porte-os
Pinzas para huesos
Tenaglie per ossa

KNOCHENCHIRURGIE

BONE SURGERY

CHIRURGIE OSSEUSE

CIRUGÍA ÓSEA

CHIRURGIA OSSEA

Knochenhalte­zangen, selbst­zentrierend
 Bone Holding Forceps, Self-centering
 Daviers porte-os, auto­centrants
 Pinzas para huesos, auto­centrantes
 Tenaglie per ossa, auto­centranti

KNOCHENCHIRURGIE

BONE SURGERY

CHIRURGIE OSSEUSE

CIRUGÍA ÓSEA

CHIRURGIA OSSEA

Knochenhalte­zangen
 Bone Holding Forceps
 Daviers porte-os
 Pinzas para huesos
 Tenaglie per ossa



32-3901-15 - 32-3901-28

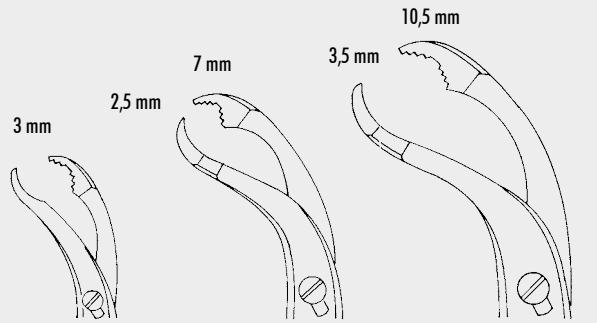

cm
15,0 32-3901-15

cm
19,0 32-3901-19

cm
24,0 32-3901-24

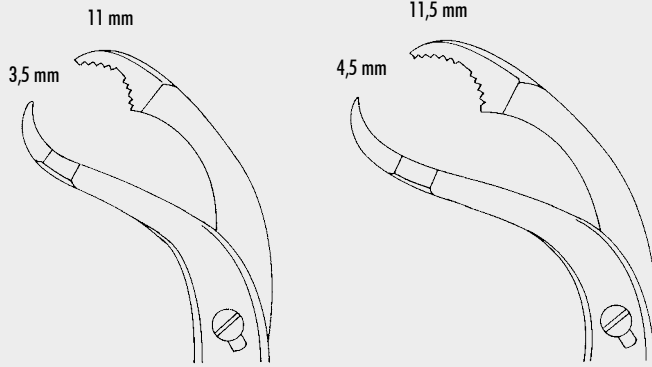

cm
26,0 32-3901-26

cm
28,0 32-3901-28



VERBRUGGE
32-3905-17 - 32-3905-27

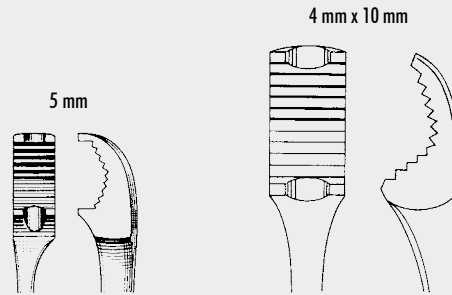

cm
17,5 32-3905-17

cm
25,0 32-3905-25

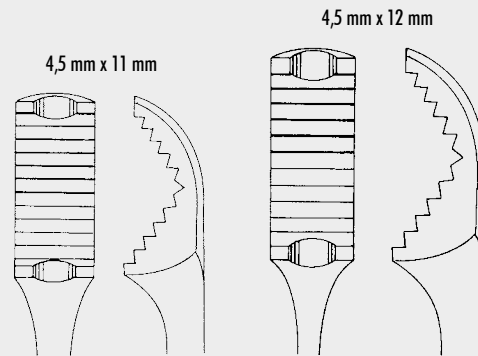

cm
26,0 32-3905-26

cm
27,0 32-3905-27



cm WELLER
20,0 32-3991-20



3:4

cm BIRCHER
20,0 32-4000-20



3:4

cm BIRCHER
20,0 32-4001-20



cm LEWIN
17,5 32-4002-17

Knochenhalte-, Repositionszangen
Bone Holding, Reposition Forceps
Daviers porte-os
Pinzas para huesos
Tenaglie per ossa

KNOCHENCHIRURGIE

BONE SURGERY

CHIRURGIE OSSEUSE

CIRUGÍA ÓSEA

CHIRURGIA OSSEA



cm BIRCHER-GANSKE
20,0 32-4004-20 32-4005-20 32-4006-20



2:2

cm DINGMANN
19,0 32-4007-19



2:2

cm DINGMANN modif.
19,0 32-4008-19

Repositions-, Knorpelasszangen
 Reposition, Cartilage Grasping Forceps
 Daviers à os et à cartilage
 Pinzas para huesos y cartilagos
 Pinze per ossa e cartilagini

KNOCHENCHIRURGIE

BONE SURGERY

CHIRURGIE OSSEUSE

CIRUGÍA ÓSEA

CHIRURGIA OSSEA



cm
 9,5 32-4009-09



cm
 13,5 32-4009-13



cm
 13,5 32-4011-13



cm HAASE
 16,5 32-4013-16



cm
 16,0 32-4014-16

Repositions-, Knorpelfasszangen
 Reposition, Cartilage Grasping Forceps
 Daviers à os et à cartilage
 Pinzas para huesos y cartilagos
 Pinze per osso e cartilagini



cm TUCKER
 19,0 32-4015-19



cm TUCKER
 16,0 32-4016-16



cm
 14,0 32-4021-14

KNOCHENCHIRURGIE

BONE SURGERY

CHIRURGIE OSSEUSE

CIRUGÍA ÓSEA

CHIRURGIA OSSEA



cm
 12,0 32-4023-12



cm MC LEARIE
 18,5 32-4025-18



cm
 16,0 32-4030-16
 22,0 32-4030-22
 24,0 32-4030-24

Repositions-, Knorpelasszangen
 Reposition, Cartilage Grasping Forceps
 Daviers à os et à cartilage
 Pinzas para huesos y cartilagos
 Pinze per ossa e cartilagini

KNOCHENCHIRURGIE

BONE SURGERY

CHIRURGIE OSSEUSE

CIRUGÍA ÓSEA

CHIRURGIA OSSEA

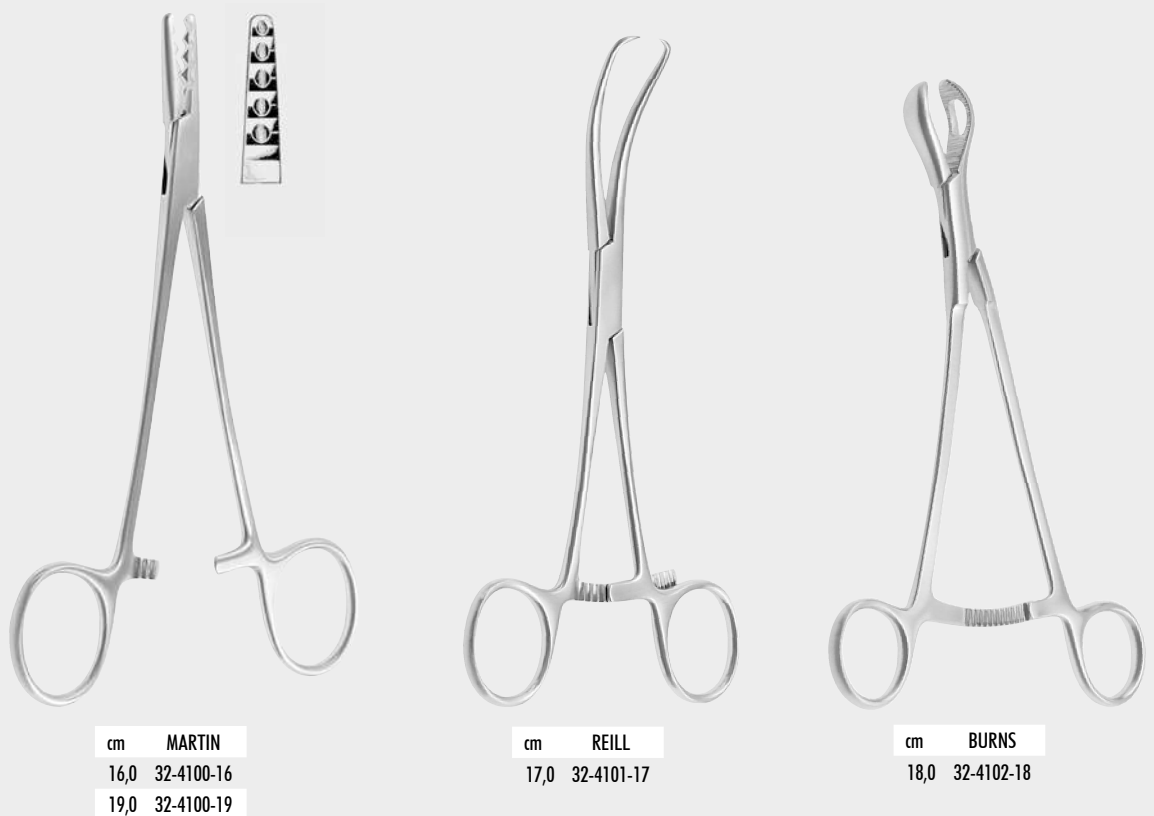
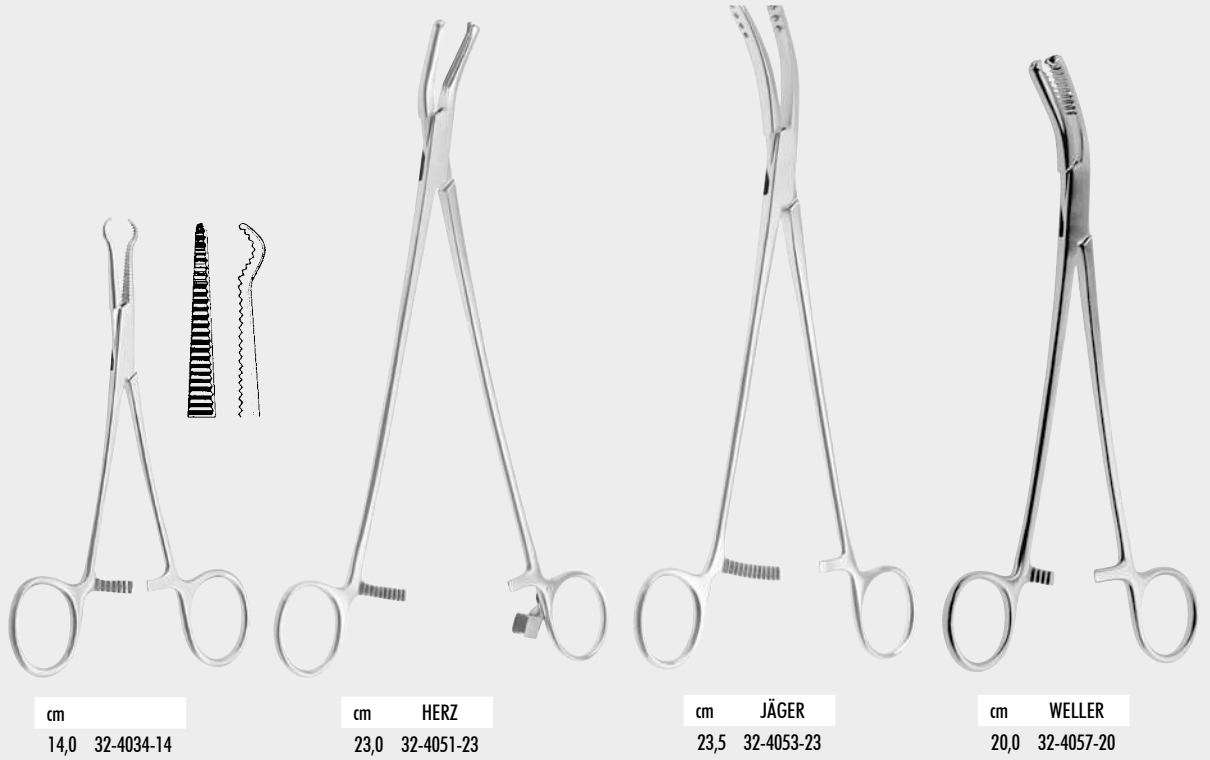



cm
20,0 32-4103-20



cm REILL
17,0 32-4104-17

Repositionszange, Sequesterzangen
Resposition Forceps, Sequestrum Forceps
Daviers à os et à séquestres
Pinzas para huesos y para sequestros
Pinze per ossa e per sequestri

KNOCHENCHIRURGIE

BONE SURGERY

CHIRURGIE OSSEUSE

CIRUGÍA ÓSEA

CHIRURGIA OSSEA

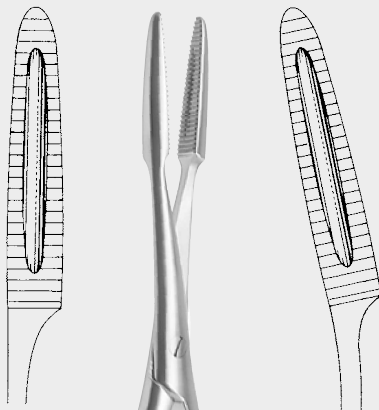

cm
20,0 32-4200-20 32-4201-20

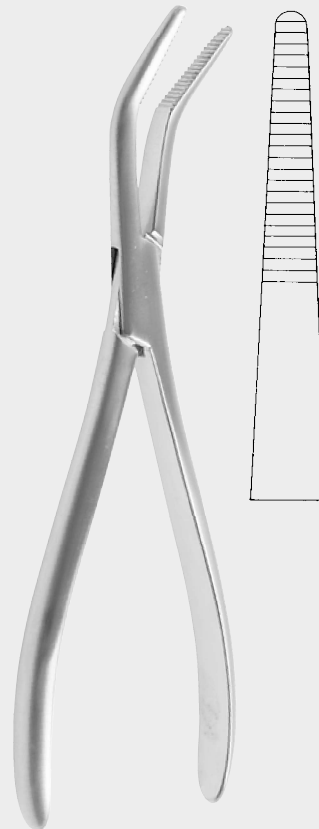

cm VAN BUREN
23,0 32-4203-23

Repositionszange, Sequesterzangen
 Reposition Forceps, Sequestrum Forceps
 Daviers à os et à séquestres
 Pinzas para huesos y para sequestrós
 Pinze per ossa e per sequestrí

KNOCHENCHIRURGIE

BONE SURGERY

CHIRURGIE OSSEUSE

CIRUGÍA ÓSEA

CHIRURGIA OSSEA



cm	OLLIER
16,0	32-4250-16
18,0	32-4250-18
23,0	32-4250-23

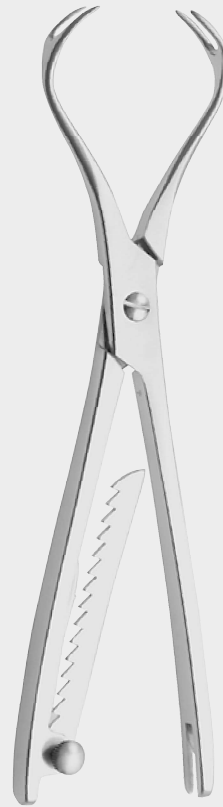

cm	OLLIER
19,0	32-4252-19
23,0	32-4252-23
27,0	32-4252-27



cm	
24,0	32-4260-24



cm	
19,0	32-4261-19



cm	
19,0	32-4261-24

Repositionszange, Sequesterzangen
 Reposition Forceps, Sequestrum Forceps
 Daviers à os et à séquestres
 Pinzas para huesos y para sequestros
 Pinze per ossa e per sequestri

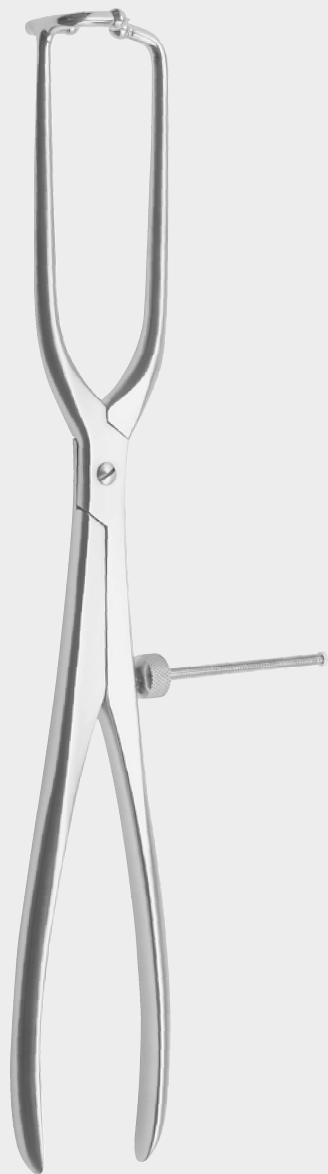

cm
40,0 32-4264-40

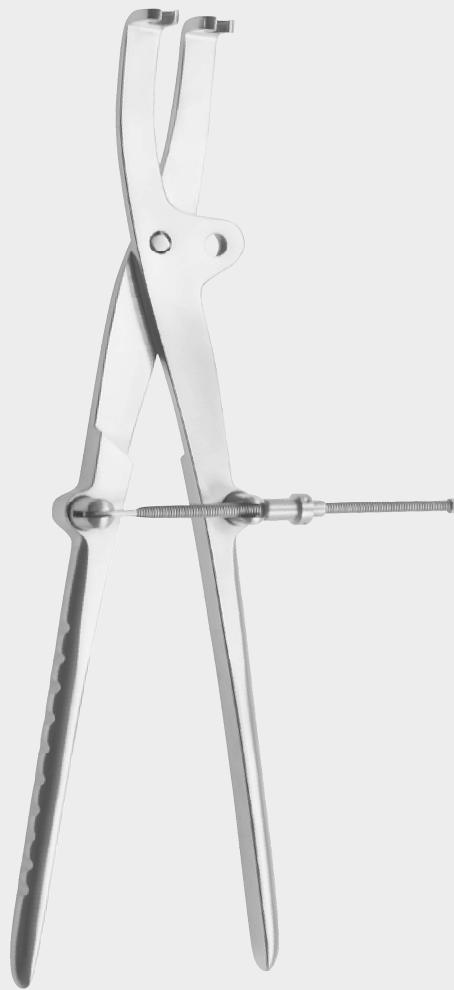

cm
34,5 32-4266-34

KNOCHENCHIRURGIE

BONE SURGERY

CHIRURGIE OSSEUSE

CIRUGÍA ÓSEA

CHIRURGIA OSSEA

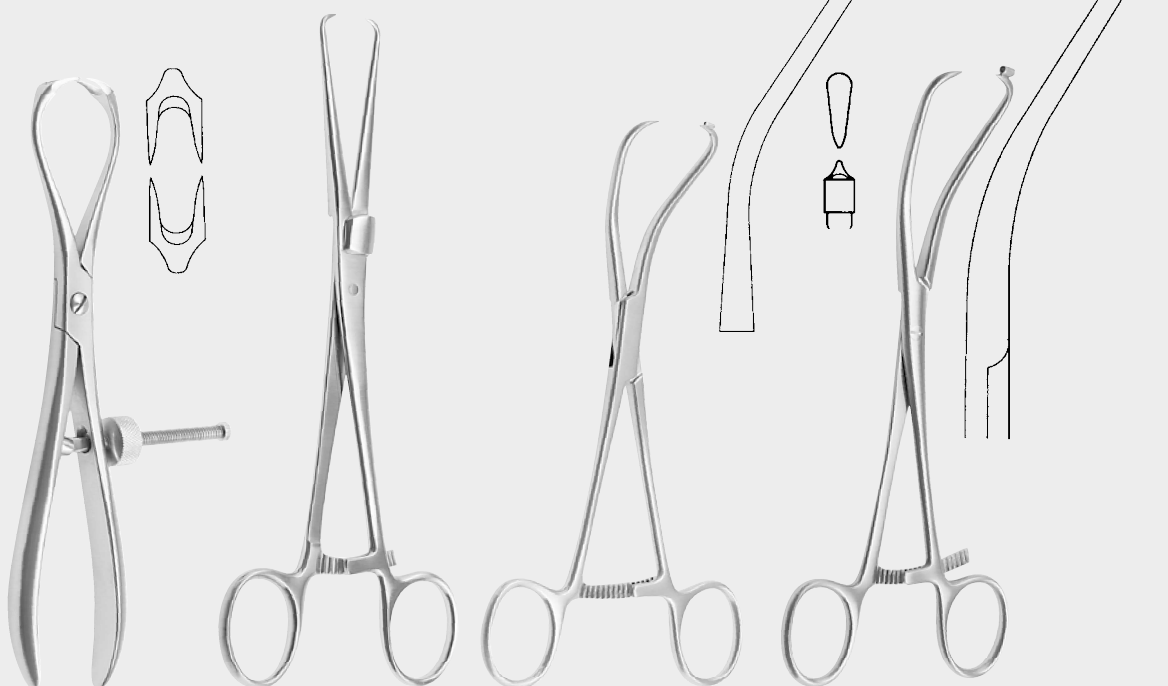

cm
18,0 32-4302-18

cm **CODIVILLA**
20,0 32-4310-20 32-4311-20

cm **MEYER**
17,0 32-4321-17

cm **MEYER**
20,5 32-4321-20

max. ø 2,0 mm

max. ø 1,0 mm

Patellazange, Repositionszangen
 mit Bohrbüchse
 Patella Forceps, Reposition Forceps
 with drill guide
 Pince à saisir la patella, daviers
 avec douille guide-foret
 Pinza de patella, pinza
 con guías de brocas
 Pinza per la patella, pinze
 con guida-trapano



Knochenhalteklammern
Bone Holding Clamps
Daviers à os
Clamps para huesos
Tenaglie per ossa

KNOCHENCHIRURGIE

BONE SURGERY

CHIRURGIE OSSEUSE

CIRUGÍA ÓSEA

CHIRURGIA OSSEA



cm	LOWMAN
13,0	32-4401-13
18,5	32-4401-18
20,0	32-4401-20
22,0	32-4401-22



cm	LOWMAN HOGLUND
18,0	32-4402-18



GERSTER
32-4404-15



PARHAM
32-4406-24



cm	PARHAM
18,0	32-4408-18
30,0	32-4408-30



32-4500-01	f. Erwachsene
	adult size
	p. adultes
	p. adultos
	p. adulti



32-4500-02	f. Kinder
	child size
	p. enfants
	p. niños
	p. bambini

Bleihand - Lead Hand Splint - Main en plomb
Manopla de plomo - Manopola in piombo

32-4502-00	Stahl
	Stainless Steel
	acier inox
	acero inox
	acciaio inox

Instrumente für Sehnen
Tendon Instruments
Instruments à tendons
Instrumentos para tendones
Strumenti per tendini



ø mm	cm
1,5	10,0



ø mm	cm
2,5	10,0



ø mm	cm
4,5	10,0

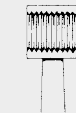

ø mm	cm
5,5	10,0

LARSEN

32-4510-15 - 32-4510-55

KNOCHENCHIRURGIE

BONE SURGERY

CHIRURGIE OSSEUSE

CIRUGÍA ÓSEA

CHIRURGIA OSSEA



cm STEINMANN
16,0 32-4512-16

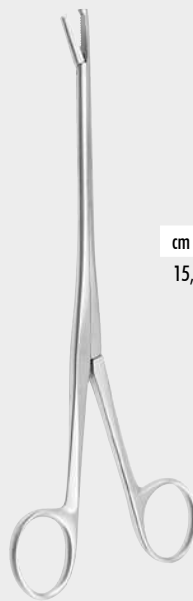

1:2



cm
15,0 32-4514-15

1:2



cm
19,0 32-4514-19

1:2

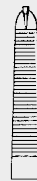

cm
24,0 32-4514-24

BRAND

32-4514-15 - 32-4514-24

ZEPF®
INSTRUMENTS

32-4514-24

32.33

Sehnen-Instrumente
Tendon Instruments
Instruments à tendons
Instrumentos para tendones
Strumenti per tendini

KNOCHENCHIRURGIE

BONE SURGERY

CHIRURGIE OSSEUSE

CIRUGÍA ÓSEA

CHIRURGIA OSSEA

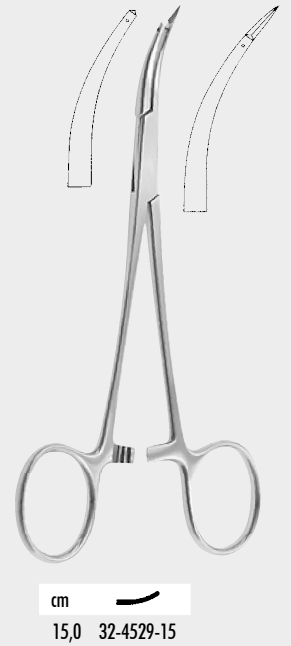
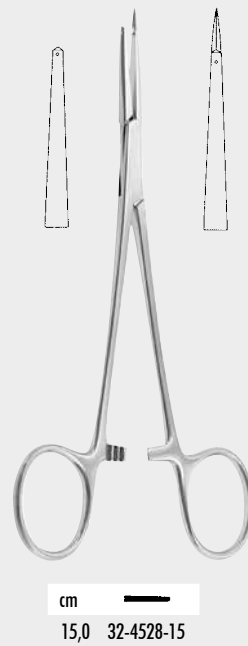
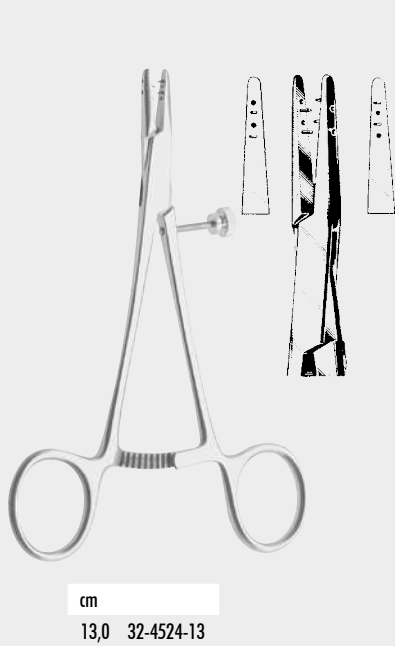
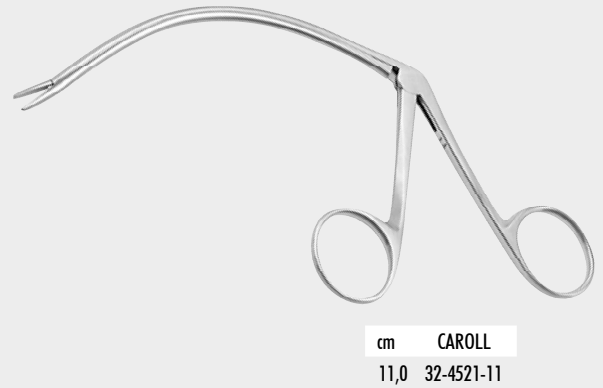
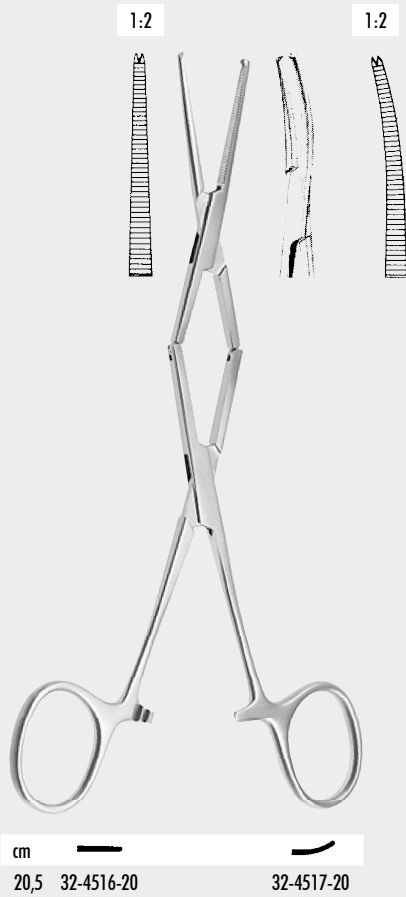

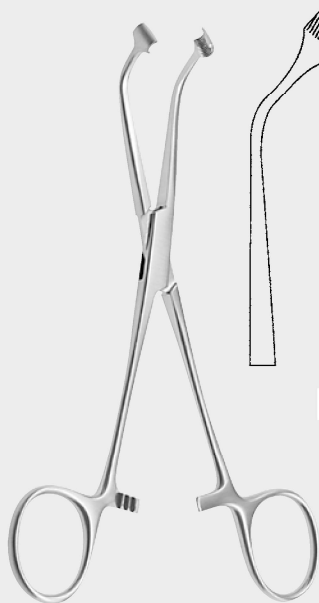

32-4541-15

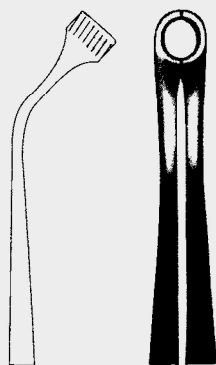

32-4543-15

cm HERZ
15,5 32-4541-15 - 32-4543-15

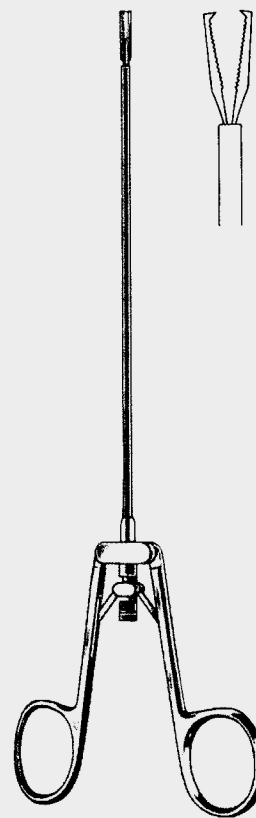

cm KLEINERT-KUTZ
20,0 32-4552-20

Sehnen-Fasszangen
Tendon Seizing Forceps
Pinces à saisir les tendons
Pinzas para agarrar tendones
Pinze afferratendini

KNOCHENCHIRURGIE

BONE SURGERY

CHIRURGIE OSSEUSE

CIRUGÍA ÓSEA

CHIRURGIA OSSEA



rund
round
rond
redonda
rotondo

Fig. 1
32-4602-02 - 32-4602-14

Fig. 1	ø mm	Fig. 2
32-4602-02	2,0	32-4603-02
32-4602-04	4,0	32-4603-04
32-4602-06	6,0	32-4603-06
32-4602-08	8,0	32-4603-08
32-4602-10	10,0	32-4603-10
32-4602-12	12,0	32-4603-12
32-4602-14	14,0	32-4603-14



oval
ovale

Fig. 2
32-4603-02 - 32-4603-14

Scharfe Löffel
Bone Curettes
Cuillères tranchantes
Cucharillas cortantes
Curette taglienti



Scharfe Löffel
Bone Curettes
Cuillères tranchantes
Cucharillas cortantes
Curette taglianti

KNOCHENCHIRURGIE

BONE SURGERY

CHIRURGIE OSSEUSE

CIRUGÍA ÓSEA

CHIRURGIA OSSEA

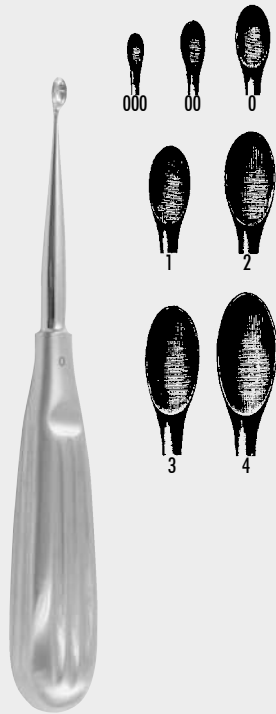

SCHEDÉ 17,0 cm
32-4607-97 - 32-4608-04

SCHEDÉ	Fig.	VOLKMANN
	0000	32-4609-96
32-4607-97	000	32-4609-97
32-4607-98	00	32-4609-98
32-4608-00	0	32-4700-00
32-4608-01	1	32-4700-01
32-4608-02	2	32-4700-02
32-4608-03	3	32-4700-03
32-4608-04	4	32-4700-04
	5	32-4700-05
	6	32-4700-06

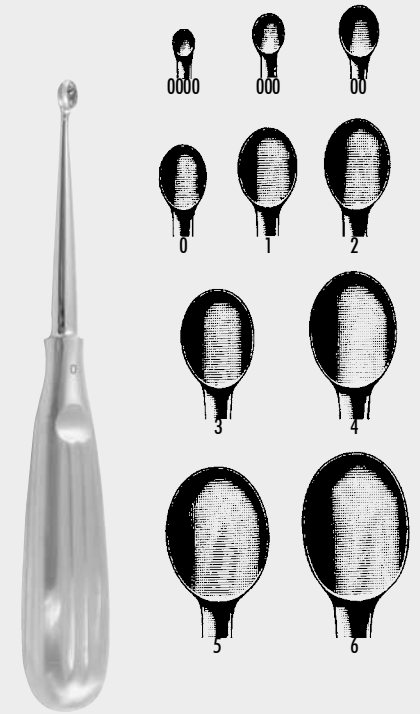

VOLKMANN 17,0 cm
32-4609-96 - 32-4700-06

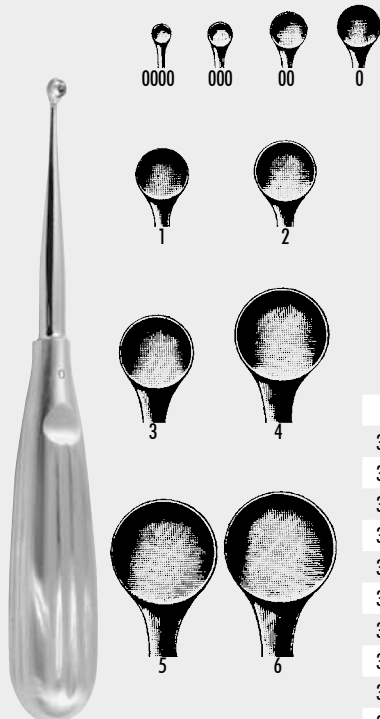

BRUNS 17,0 cm
32-4701-96 - 32-4702-06

BRUNS	Fig.	SPRATT
32-4701-96	0000	32-4704-96
32-4701-97	000	32-4704-97
32-4701-98	00	32-4704-98
32-4702-00	0	32-4705-00
32-4702-01	1	32-4705-01
32-4702-02	2	32-4705-02
32-4702-03	3	32-4705-03
32-4702-04	4	32-4705-04
32-4702-05	5	32-4705-05
32-4702-06	6	

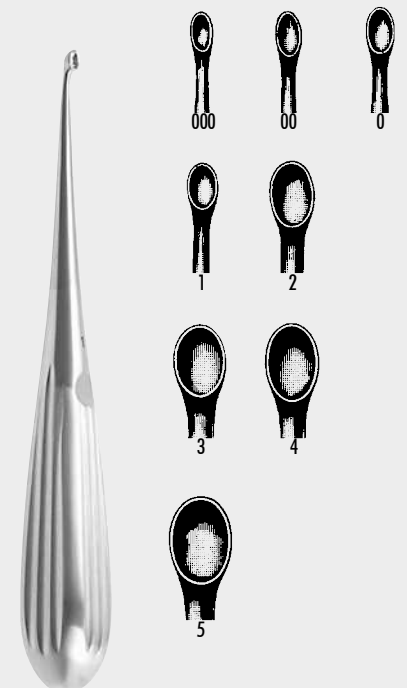

SPRATT 17,0 cm
32-4704-97 - 32-4705-05



Fig. 0000



Fig. 000



Fig. 00



Fig. 0

Fig. DAUBENSPECK 20,0 cm	
0000	32-4719-96
000	32-4719-97
00	32-4719-98
0	32-4720-00



cm	« UFFENORDE »	
17,0	32-4723-17	32-4725-17

Scharfe Löffel
Bone Curettes
Cuillères tranchantes
Cucharillas cortantes
Curette taglianti

KNOCHENCHIRURGIE

BONE SURGERY

CHIRURGIE OSSEUSE

CIRUGÍA ÓSEA

CHIRURGIA OSSEA



mm	KERPEL 14,5 cm		
2,0	32-4731-02	32-4732-02	32-4733-02
3,0	32-4731-03	32-4732-03	32-4733-03

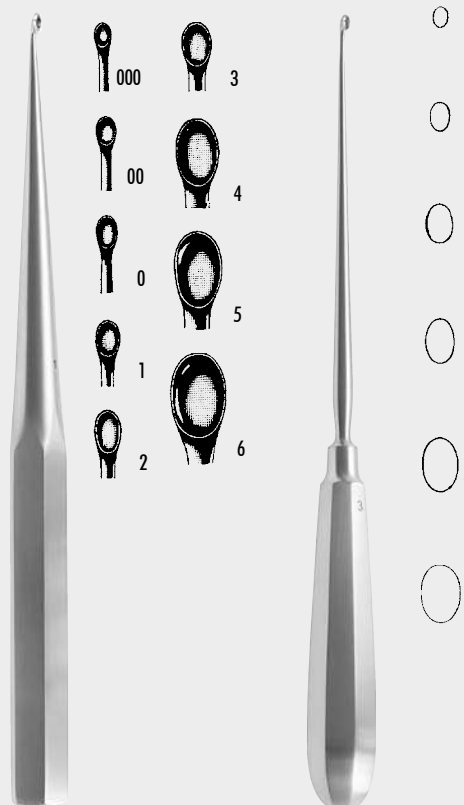

BRUNS 23,0 cm	Fig.	SIMON 24,0 cm
32-4800-97	000	
32-4800-98	00	
32-4801-00	0	
32-4801-01	1	32-4805-01
32-4801-02	2	32-4805-02
32-4801-03	3	32-4805-03
32-4801-04	4	32-4805-04
32-4801-05	5	32-4805-05
32-4801-06	6	32-4805-06





Scharfe Löffel
 Bone Curettes
 Cuillères tranchantes
 Cucharillas cortantes
 Curette taglienti

KNOCHENCHIRURGIE

BONE SURGERY

CHIRURGIE OSSEUSE

CIRUGÍA ÓSEA

CHIRURGIA OSSEA



32-4816-96 - 32-4819-06

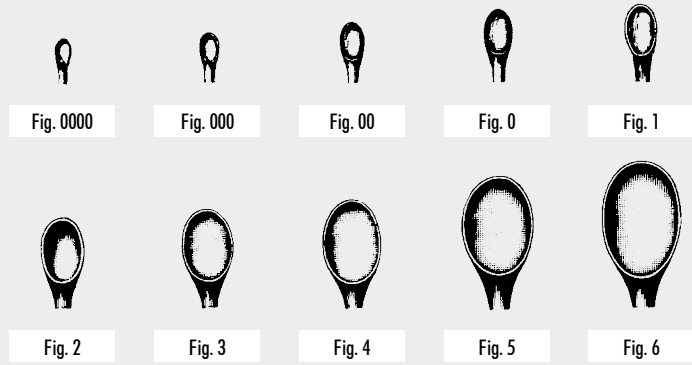

BRUNS (VOLKMANN) 23,0 cm		
	Fig.	
32-4816-96	0000	32-4818-96
32-4816-97	000	32-4818-97
32-4816-98	00	32-4818-98
32-4817-00	0	32-4819-00
32-4817-01	1	32-4819-01
32-4817-02	2	32-4819-02
32-4817-03	3	32-4819-03
32-4817-04	4	32-4819-04
32-4817-05	5	32-4819-05
32-4817-06	6	32-4819-06

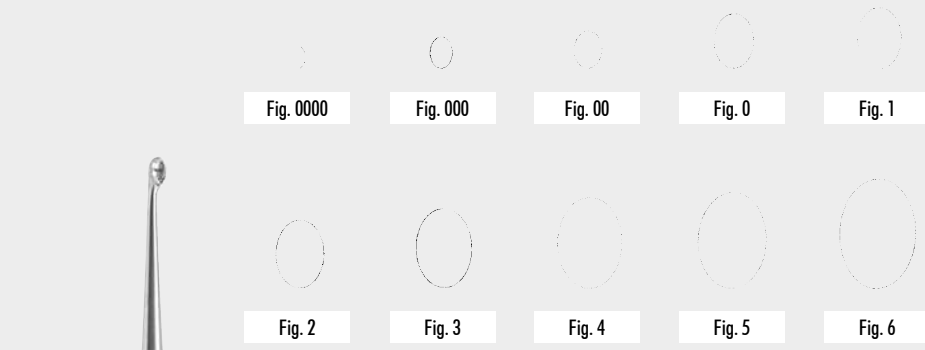

cm VOLKMANN
 17,0 32-4823-96 - 32-4824-06

VOLKMANN		
	Fig.	
32-4823-96	0000	
32-4823-97	000	
32-4823-98	00	
32-4824-00	0	32-4826-00
32-4824-01	1	32-4826-01
32-4824-02	2	32-4826-02
32-4824-03	3	32-4826-03
32-4824-04	4	32-4826-04
32-4824-05	5	
32-4824-06	6	



cm VOLKMANN
 27,0 32-4826-00 - 32-4826-04





Fig.	mm	CASPAR 22,0 cm
000	3,6	32-4828-36
00	4,4	32-4828-44
0	5,2	32-4828-52



Fig.	mm	CASPAR 22,0 cm
000	3,6	32-4829-36
00	4,4	32-4829-44
0	5,2	32-4829-52

Scharfe Löffel
Bone Curettes
Cuillères tranchantes
Cucharillas cortantes
Curette taglienti

KNOCHENCHIRURGIE

BONE SURGERY

CHIRURGIE OSSEUSE

CIRUGÍA ÓSEA

CHIRURGIA OSSEA



mm	SEMMEs 23,0 cm
4 x 7	32-4830-23



mm	SEMMEs 23,0 cm
4 x 7	32-4831-23



mm	SEMMEs 23,0 cm
4 x 7	32-4833-23

Scharfe Löffel
 Bone Curettes
 Cuillères tranchantes
 Cucharillas cortantes
 Curette taglienti

KNOCHENCHIRURGIE

BONE SURGERY

CHIRURGIE OSSEUSE

CIRUGÍA ÓSEA

CHIRURGIA OSSEA



Fig. 1



Fig. 2



Fig. 3



Fig.	EPSTEIN 20,0 cm
000	32-4848-97
00	32-4848-98
0	32-4849-00

Fig.	SCOVILLE 25,0 cm
1	32-4836-25
2	32-4837-25
3	32-4839-25



mm	CASPAR 25,0 cm
4,0	32-4852-04
5,0	32-4852-05



Fig.	LEMPERT 17,5 cm
0	32-4900-10
00	32-4900-20
000	32-4900-30
0000	32-4900-40
00000	32-4900-50



Fig.	HALLE 21,0 cm
1	32-4901-01
2	32-4901-02
3	32-4901-03



32-5001-00
Fig. 000



32-5002-00
Fig. 00



32-5003-00
Fig. 0



32-5003-01
Fig. 1



32-5003-02
Fig. 2



32-5003-03
Fig. 3



32-5003-04
Fig. 4



32-5003-05
Fig. 5



32-5003-06
Fig. 6



cm COBB
28,0 32-5001-00 - 32-5003-07



32-5005-97
32-5007-97



32-5005-98
32-5007-98



32-5006-00
32-5008-00



32-5006-01
32-5008-01



32-5006-02
32-5008-02



32-5006-03
32-5008-03



32-5006-04
32-5008-04

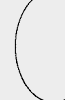

32-5006-05
32-5008-05



32-5006-06
32-5008-06



cm HATFIELD
23,0 32-5005-97 - 32-5006-06



cm HATFIELD
28,0 32-5007-97 - 32-5008-06

Spinal-Löffel
Spinal Fusion Curettes
Curettes tranchantes pour la fusion spinale
Curetas cortantes para la fusión espinal
Curette taglienti per la fusione spinale

KNOCHENCHIRURGIE

BONE SURGERY

CHIRURGIE OSSEUSE

CIRUGÍA ÓSEA

CHIRURGIA OSSEA





Spinal-Löffel
 Spinal Fusion Curettes
 Curettes tranchantes pour la fusion spinale
 Curetas cortantes para la fusión espinal
 Curette taglianti per la fusione spinale

KNOCHENCHIRURGIE

BONE SURGERY

CHIRURGIE OSSEUSE

CIRUGÍA ÓSEA

CHIRURGIA OSSEA

Scharfe Löffel
 Bone Curettes
 Cuillères tranchantes
 Cucharillas cortantes
 Curette taglianti



32-5100-36
 32-5101-36



32-5100-44
 32-5101-44



32-5100-52
 32-5101-52



32-5100-60
 32-5101-60



cm	
25,0	32-5100-36 - 32-5100-60

cm	
25,0	32-5101-36 - 32-5101-60

mm	BUSHE 25,0 cm
3,0	32-5103-03
4,0	32-5103-04
5,0	32-5103-05



32-5120-01
 Fig. 1



32-5120-02
 Fig. 2



32-5120-03
 Fig. 3

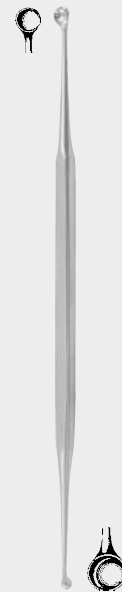

cm	VOLKMANN
22,0	32-5120-01 - 32-5120-03

cm	JANSEN
15,0	32-5130-15

mm	STANLEY BOYD
13,0	32-5140-13
16,0	32-5140-16
20,0	32-5140-20





cm	VOLKMANN
13,0	32-5302-13
14,0	32-5302-14
17,0	32-5302-17



cm	VOLKMANN
13,0	32-5304-13
14,0	32-5304-14
17,0	32-5304-17
20,0	32-5304-20

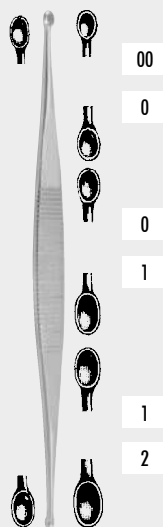

Fig.	WILLIGER 13,5 cm
00/0	32-5306-00
0/1	32-5306-01
1/2	32-5306-12

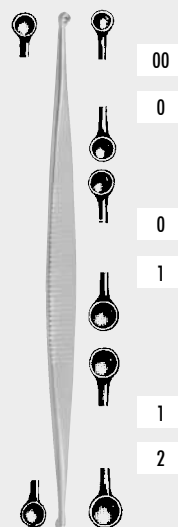

Fig.	MARTINI 13,5 cm
00/0	32-5308-00
0/1	32-5308-01
1/2	32-5308-12

Scharfe Löffel
Bone Curettes
Cuillères tranchantes
Cucharillas cortantes
Curette taglianti

KNOCHENCHIRURGIE

BONE SURGERY

CHIRURGIE OSSEUSE

CIRUGÍA ÓSEA

CHIRURGIA OSSEA



cm	
21,0	32-5310-21



cm	JACOBSON
14,0	32-5312-14



cm	BARTH
18,0	32-5314-18

Meissel
Chisels and Gouges
Ciseaux-burins et gouges
Cincales y gubias
Scalpelli e sgorbie

KNOCHENCHIRURGIE

BONE SURGERY

CHIRURGIE OSSEUSE

CIRUGÍA ÓSEA

CHIRURGIA OSSEA



mm KRÄMER 17,0 cm
2,5 32-5401-25



32-5800-00



mm	
5 / 45	32-5800-05
10 / 45	32-5800-10
16 / 45	32-5800-16
25 / 45	32-5800-25



mm	
25 / 78	32-5800-78



32-5800-99



mm	MANNERFELDT 16,0 cm
3,0	32-5998-03



mm	MANNERFELDT 16,0 cm
4,0	32-6000-04
6,0	32-6000-06
8,0	32-6000-08



mm	13,5 cm
2,0	32-6002-02
4,0	32-6002-04
6,0	32-6002-06
8,0	32-6002-08
10,0	32-6002-10
12,0	32-6002-12
14,0	32-6002-14
16,0	32-6002-16



mm	13,5 cm
4,0	32-6004-04
6,0	32-6004-06
8,0	32-6004-08
10,0	32-6004-10
12,0	32-6004-12
14,0	32-6004-14
16,0	32-6004-16



mm	13,5 cm
4,0	32-6005-04
6,0	32-6005-06
8,0	32-6005-08
10,0	32-6005-10
12,0	32-6005-12
14,0	32-6005-14
16,0	32-6005-16

Meissel
Chisels and Gouges
Ciseaux-burins et gouges
Cinceles y gubias
Scalpelli e sgorbie

KNOCHENCHIRURGIE

BONE SURGERY

CHIRURGIE OSSEUSE

CIRUGÍA ÓSEA

CHIRURGIA OSSEA



mm	EAST GRINSTEAD (WARD) 18,0 cm
3,0	32-6010-03
5,0	32-6010-05



mm	EAST GRINSTEAD (WARD) 18,0 cm
3,0	32-6012-03
5,0	32-6012-05



mm	EASTMAN 19,0 cm
3,0	32-6020-03
5,0	32-6020-05

ZEPF®
INSTRUMENTS

Meissel
 Chisels and Gouges
 Ciseaux-burins et gouges
 Circeles y gubias
 Scalpelli e sgorbie

KNOCHENCHIRURGIE

BONE SURGERY

CHIRURGIE OSSEUSE

CIRUGÍA ÓSEA

CHIRURGIA OSSEA

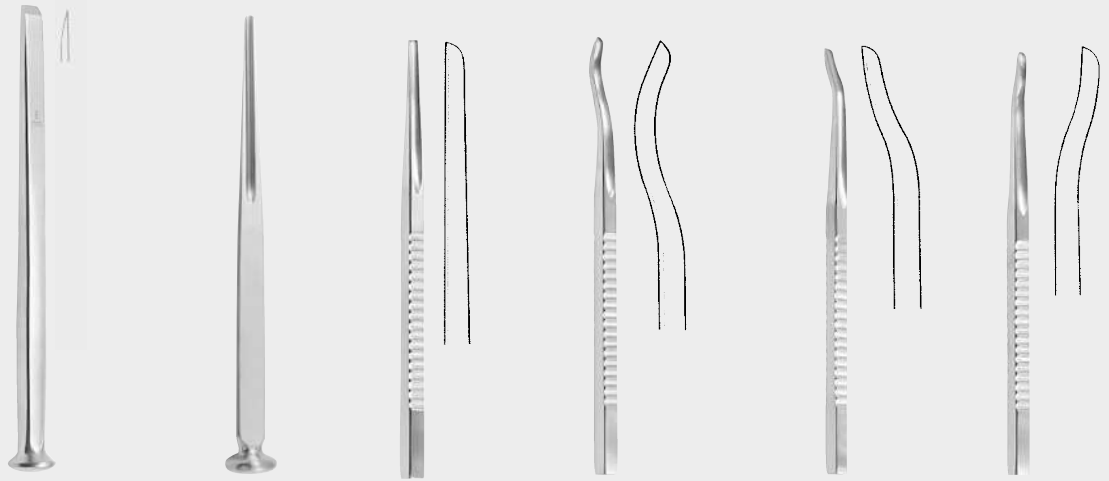

mm	ALEXANDER 17,0 cm	mm	ALEXANDER 17,0 cm	Fig.	BUCK GRAMCKO	Fig.	BUCK GRAMCKO	Fig.	BUCK GRAMCKO	Fig.	BUCK GRAMCKO
4,0	32-6100-04	4,0	32-6101-04	1	32-6110-01	2	32-6111-02	3	32-6111-03	4	32-6111-04
6,0	32-6100-06	6,0	32-6101-06		13,5 cm		13,5 cm		13,5 cm		13,5 cm
8,0	32-6100-08	8,0	32-6101-08		3,4 mm		3,4 mm		3,4 mm		3,4 mm
10,0	32-6100-10	10,0	32-6101-10								
12,0	32-6100-12	12,0	32-6101-12								
14,0	32-6100-14	14,0	32-6101-14								



mm	GILLIES (FRENCH) (CARROLL) 14,0 cm	mm	PARTSCH 13,5 cm	PARTSCH 17,5 cm	mm	PARTSCH 13,5 cm	PARTSCH 17,5 cm
5,0	32-6114-05	2,0	32-6200-02	32-6202-02	2,0	32-6203-02	32-6205-02
7,0	32-6114-07	3,0	32-6200-03	32-6202-03	3,0	32-6203-03	32-6205-03
9,0	32-6114-09	4,0	32-6200-04	32-6202-04	4,0	32-6203-04	32-6205-04
11,0	32-6114-11	5,0	32-6200-05	32-6202-05	5,0	32-6203-05	32-6205-05
		6,0	32-6200-06	32-6202-06	6,0	32-6203-06	32-6205-06
		7,0	32-6200-07	32-6202-07	7,0	32-6203-07	32-6205-07
		8,0	32-6200-08	32-6202-08	8,0	32-6203-08	32-6205-08
		10,0	32-6200-10	32-6202-10	10,0	32-6203-10	
		12,0	32-6200-12	32-6202-12			

Meissel
Chisels and Gouges
Ciseaux-burins et gouges
Cinceles y gubias
Scalpelli e sgorbie



mm	STILLE 20,0 cm
6,0	32-6300-06
8,0	32-6300-08
10,0	32-6300-10
12,0	32-6300-12
15,0	32-6300-15
20,0	32-6300-20
25,0	32-6300-25
30,0	32-6300-30

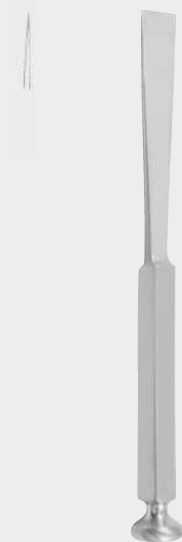

mm	STILLE 20,0 cm	
6,0	32-6302-06	32-6303-06
8,0	32-6302-08	32-6303-08
10,0	32-6302-10	32-6303-10
12,0	32-6302-12	32-6303-12
15,0	32-6302-15	32-6303-15
20,0	32-6302-20	32-6303-20
25,0	32-6302-25	32-6303-25
30,0	32-6302-30	



mm	STILLE 20,0 cm
6,0	32-6305-06
8,0	32-6305-08
10,0	32-6305-10
12,0	32-6305-12
15,0	32-6305-15
20,0	32-6305-20
25,0	32-6305-25
30,0	32-6305-30

KNOCHENCHIRURGIE

BONE SURGERY

CHIRURGIE OSSEUSE

CIRUGÍA ÓSEA

CHIRURGIA OSSEA



mm	SMITH-PETERSEN 20,0 cm
6,0	32-6404-06
9,0	32-6404-09
13,0	32-6404-13
16,0	32-6404-16
19,0	32-6404-19
25,0	32-6404-25
32,0	32-6404-32



mm	SMITH-PETERSEN 20,0 cm
6,0	32-6405-06
9,0	32-6405-09
13,0	32-6405-13
16,0	32-6405-16
19,0	32-6405-19
25,0	32-6405-25
32,0	32-6405-32



mm	SMITH-PETERSEN 20,0 cm
6,0	32-6407-06
9,0	32-6407-09
13,0	32-6407-13
16,0	32-6407-16
19,0	32-6407-19
25,0	32-6407-25
32,0	32-6407-32



mm	SMITH-PETERSEN 20,0 cm
6,0	32-6409-06
9,0	32-6409-09
13,0	32-6409-13
16,0	32-6409-16
19,0	32-6409-19
25,0	32-6409-25
32,0	32-6409-32



Meissel
Chisels and Gouges
Ciseaux-burins et gouges
Cincales y gubias
Scalpelli e sgorbie



mm	LAMBOTTE 25,0 cm	mm	LAMBOTTE 25,0 cm	mm	LAMBOTTE mini 17,0 cm	mm	LAMBOTTE mini 12,5 cm
4,0	32-6500-04	4,0	32-6501-04	2,0	32-6502-02	2,0	32-6504-02
6,5	32-6500-06	6,5	32-6501-06	3,0	32-6502-03	3,0	32-6504-03
8,0	32-6500-08	8,0	32-6501-08	4,0	32-6502-04	4,0	32-6504-04
10,0	32-6500-10	10,0	32-6501-10	6,0	32-6502-06	6,0	32-6504-06
13,0	32-6500-13	13,0	32-6501-13	8,0	32-6502-08	8,0	32-6504-08
15,0	32-6500-15	15,0	32-6501-15	10,0	32-6502-10	10,0	32-6504-10
18,0	32-6500-18	18,0	32-6501-18	12,0	32-6502-12	12,0	32-6504-12
20,0	32-6500-20	20,0	32-6501-20	15,0	32-6502-15	15,0	32-6504-15
25,0	32-6500-25	25,0	32-6501-25				
30,0	32-6500-30	30,0	32-6501-30				
38,0	32-6500-38	38,0	32-6501-38				
44,0	32-6500-44	44,0	32-6501-44				
50,0	32-6500-50	50,0	32-6501-50				

KNOCHENCHIRURGIE

BONE SURGERY

CHIRURGIE OSSEUSE

CIRUGÍA ÓSEA

CHIRURGIA OSSEA

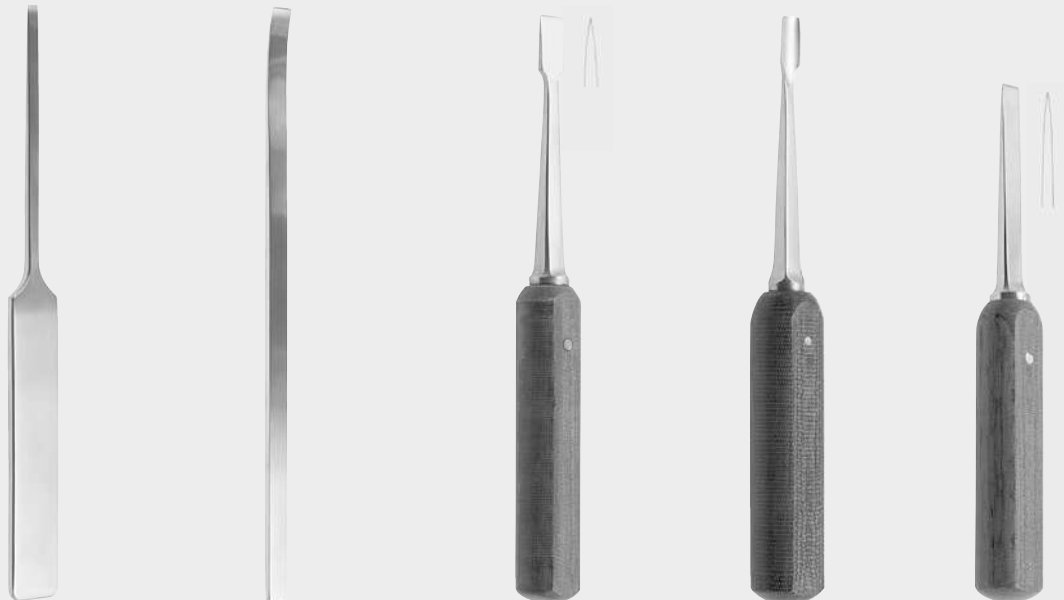

mm	LAMBOTTE 25,0 cm	mm	NIEDERDELLMANN 25,0 cm	mm	LEXER 22,0 cm	mm	LEXER 22,0 cm	mm	LEXER mini 18,0 cm
4,0	32-6510-04	8,0	32-6521-08	5,0	32-6600-05	5,0	32-6601-05	4,0	32-6604-04
6,0	32-6510-06	10,0	32-6521-10	7,0	32-6600-07	7,0	32-6601-07	6,0	32-6604-06
8,0	32-6510-08			10,0	32-6600-10	10,0	32-6601-10	8,0	32-6604-08
10,0	32-6510-10			15,0	32-6600-15	15,0	32-6601-15	10,0	32-6604-10
				20,0	32-6600-20	20,0	32-6601-20	12,0	32-6604-12
				25,0	32-6600-25	25,0	32-6601-25		
				30,0	32-6600-30	30,0	32-6601-30		

Meissel
Chisels and Gouges
Ciseaux-burins et gouges
Cinceles y gubias
Scalpelli e sgorbie



mm LEXER mini 18,0 cm		mm LEXER 28,0 cm		mm LEXER 28,0 cm		mm LEXER Spongiosa 25,0 cm		mm LEXER Spongiosa 25,0 cm	
4,0	32-6605-04	10,0	32-6607-10	10,0	32-6609-10	5,0	32-6610-05	5,0	32-6611-05
6,0	32-6605-06	15,0	32-6607-15	15,0	32-6609-15	10,0	32-6610-10	10,0	32-6611-10
8,0	32-6605-08					15,0	32-6610-15	15,0	32-6611-15
10,0	32-6605-10								
12,0	32-6605-12								

KNOCHENCHIRURGIE

BONE SURGERY

CHIRURGIE OSSEUSE

CIRUGÍA ÓSEA

CHIRURGIA OSSEA

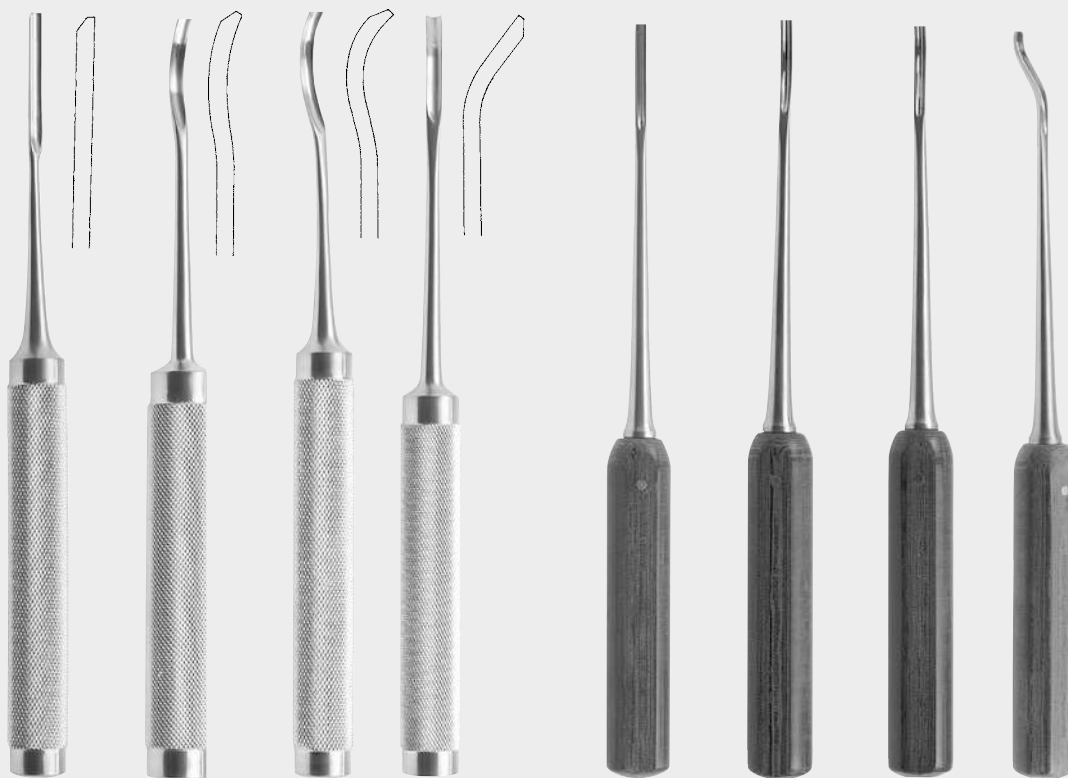

COBB Spinal 28,0 cm 6,0 mm
32-6620-01 32-6621-02 32-6621-03 32-6621-04

COBB Spinal 28,0 cm
32-6622-01 32-6623-02 32-6623-03 32-6623-04

Meissel
Chisels and Gouges
Ciseaux-burins et gouges
Cincales y gubias
Scalpelli e sgorbie

KNOCHENCHIRURGIE

BONE SURGERY

CHIRURGIE OSSEUSE

CIRUGÍA ÓSEA

CHIRURGIA OSSEA



mm	ZIELKE 23,0 cm	
5,5	32-6631-05	
9,0	32-6631-09	



mm	23,0 cm
9,0	32-6689-09



mm	HOKE 17,0 cm
3,0	32-6698-03
5,0	32-6698-05
6,0	32-6698-06
8,0	32-6698-08
9,0	32-6698-09



mm	HIBBS 24,0 cm		mm	HIBBS 24,0 cm		mm	HIBBS 24,0 cm		mm	HIBBS 24,0 cm		mm	HIBBS 24,0 cm	
6,0	32-6700-06		6,0	32-6701-06		6,0	32-6702-06		6,0	32-6703-06		6,0	32-6705-06	
13,0	32-6700-13		13,0	32-6701-13		13,0	32-6702-13		13,0	32-6703-13		13,0	32-6705-13	
19,0	32-6700-19		19,0	32-6701-19		19,0	32-6702-19		19,0	32-6703-19		19,0	32-6705-19	
25,0	32-6700-25		25,0	32-6701-25		25,0	32-6702-25		25,0	32-6703-25		25,0	32-6705-25	
32,0	32-6700-32		32,0	32-6701-32		32,0	32-6702-32		32,0	32-6703-32		32,0	32-6705-32	

Meissel
Chisels and Gouges
Ciseaux-burins et gouges
Cinceles y gubias
Scalpelli e sgorbie



mm	20,0 cm	20,0 cm
10,0	32-6710-10	32-6711-10
15,0	32-6710-15	32-6711-15
20,0	32-6710-20	32-6711-20



cm	mm	mm
24,0	20,0	32-6712-20
26,0	16,0	32-6714-16



ø mm	15,5 cm
2,0	32-6752-02
3,0	32-6752-03
4,0	32-6752-04
5,0	32-6752-05
6,0	32-6752-06
8,0	32-6752-08
10,0	32-6752-10



ø mm	CASPAR 20,0 cm
3,0	32-6760-03
5,0	32-6760-05
8,0	32-6760-08

KNOCHENCHIRURGIE

BONE SURGERY

CHIRURGIE OSSEUSE

CIRUGÍA ÓSEA

CHIRURGIA OSSEA



ø mm	20,0 cm
12,0	32-6762-12
14,0	32-6762-14
16,0	32-6762-16



ø mm	21,0 cm
6 x 8	32-6764-01
10 x 12	32-6764-02



mm	18,0 cm
6 x 13	32-6766-13
10 x 15	32-6766-15
11 x 20	32-6766-20



ø mm	17,0 cm
10 x 16	32-6768-10



mm	DEMOISELLE 18,0 cm
8 x 5	32-6770-05
12 x 8	32-6770-08
20 x 12	32-6770-12

Siößel
Tamper
Pylone
Pisón
Battitori



Meissel
Chisels and Gouges
Ciseaux-burins et gouges
Cincales y gubias
Scalpelli e sgorbie

KNOCHENCHIRURGIE

BONE SURGERY

CHIRURGIE OSSEUSE

CIRUGÍA ÓSEA

CHIRURGIA OSSEA



mm HAASE 10,0 cm
5,7 32-6772-10



cm LEBSCHKE
24,5 32-6788-24



cm
22,0 32-6791-22



cm VIRCHOW
12,0 32-6794-12



« BRUNETTI 28,0 cm »
32-6801-28 32-6803-28



32-6804-00



32-6805-01



32-6805-04



cm
14,0 32-6805-90



cm mm
13,0 32-6805-99 23

Autopsie-Besteck, Präparier-Bestecke
Post Mortem Set, Dissecting Kits
Set à autopsie, Sets à dissection
Juego de autopsia, Sets de disección
Set per autopsia, Set per dissezione

KNOCHENCHIRURGIE

BONE SURGERY

CHIRURGIE OSSEUSE

CIRUGÍA ÓSEA

CHIRURGIA OSSEA

Schädelspalter, Osteotom
Skull Breaker, Osteotome
Casse-crâne, ostéotome
Rompecráneo, osteótomo
Spacca cranio, osteotomo

ZEPF[®]
α
INSTRUMENTS

32-6805-99

32.53

Hämmer
Hammers and Mallets
Maillets et Masses
Martillos y mazos
Martelli

KNOCHENCHIRURGIE

BONE SURGERY

CHIRURGIE OSSEUSE

CIRUGÍA ÓSEA

CHIRURGIA OSSEA



g	GERZOG	g	KIRK	g	COTTLE	ø mm	g	OMBREDANNE	ø mm	g	ø mm	
250	32-6806-25	750	32-6808-75	240	32-6809-24	30,0	550	32-6812-55	40,0	480	32-6820-48	30,0
	18,0 cm		19,0 cm		19,0 cm			24,0 cm			24,0 cm	



32-6822-00	24,0 cm	g	32-6824-51	g	32-6826-00	g	32-6900-45	g	32-6902-22	ø mm
		510	26,5 cm	510	26,0 cm	450	26,5 cm	900	20,0 cm	30,0



g		ø mm
300	32-6903-30	30,0
500	32-6903-50	35,0
700	32-6903-70	40,0

g	WILLIGER	ø mm
300	32-6904-30	26,0
340	32-6904-34	28,0
400	32-6904-40	30,0

g	BERGMANN	ø mm
300	32-6905-30	30,0

g	BERGMANN	ø mm
300	32-6905-45	45,0

Hämmer
Hammers and Mallets
Maillets et Masses
Martillos y mazos
Martelli

KNOCHENCHIRURGIE

BONE SURGERY

CHIRURGIE OSSEUSE

CIRUGÍA ÓSEA

CHIRURGIA OSSEA



g	LUCAE	ø mm
230	32-6906-23	19,0 cm
260	32-6906-26	19,0 cm

g	DOYEN	ø mm
120	32-6910-12	25,0
180	32-6910-18	30,0
260	32-6910-26	35,0
		21,0 cm

g		ø mm
140	32-6912-14	16,5 cm

g	PARTSCH	ø mm
200	32-6914-20	18,0 cm

g	HAJEK	ø mm
140	32-6916-20	27,0
		22,0 cm

Hämmer
Hammers and Mallets
Maillets et Masses
Martillos y mazos
Martelli

KNOCHENCHIRURGIE

BONE SURGERY

CHIRURGIE OSSEUSE

CIRUGÍA ÓSEA

CHIRURGIA OSSEA



WAGNER compl.	ø mm
32-6968-00	35,0
23,5 cm	



g	Metall / metal	ø mm
230	32-6968-23	35

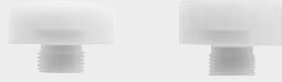

g	Plastic	ø mm
32	32-6968-32	35



32-6968-99



32-6970-99

g	ø mm
370	32-6970-37
22,5 cm	

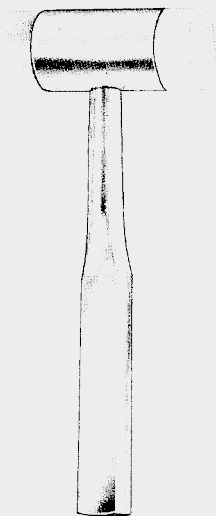

g	ø mm
140	32-6974-14
18,5 cm	



32-6974-99



32-6976-99

g	MEAD
200	32-6976-32
17,0 cm	



g	ø mm
250	32-6978-25
400	32-6978-40
26,0 cm	

Hämmer und Schlägel
Hammers and Mallets
Maillets et Masses
Martillos y mazos
Martelli

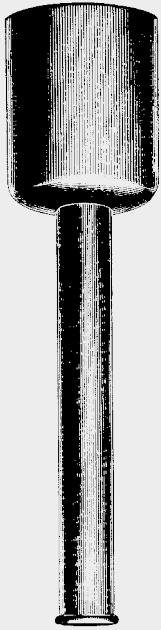

g	STEINBACH	ø mm
400	32-6980-40	80x60
24,0 cm		



g		ø mm
400	32-6982-40	42,0
26,0 cm		



g		ø mm
125	32-6984-13	30,0
18,0 cm		

KNOCHENCHIRURGIE

BONE SURGERY

CHIRURGIE OSSEUSE

CIRUGÍA ÓSEA

CHIRURGIA OSSEA

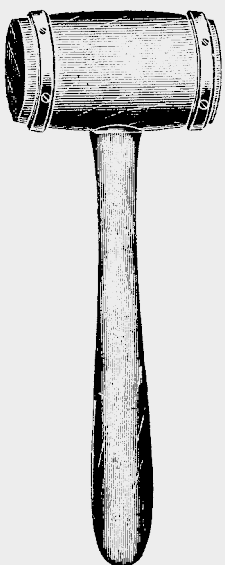

g		ø mm
290	32-6986-29	45,0
23,0 cm		

ø mm
42,0



ø mm
30,0

g		
530	32-6988-53	
26,5 cm		



g	HEATH	ø mm
700	32-6990-70	40,0
18,5 cm		

Hämmer
Hammers and Mallets
Maillets et Masses
Martillos y mazos
Martelli

KNOCHENCHIRURGIE

BONE SURGERY

CHIRURGIE OSSEUSE

CIRUGÍA ÓSEA

CHIRURGIA OSSEA



g	JUDET
800	32-6992-08
1000	32-6992-10
1200	32-6992-12



g	HEATH ø 45,0 mm
1000	32-6994-10



g / mm	Mc EVEN
250 / 25	32-6996-25
350 / 30	32-6996-35
500 / 35	32-6996-50
750 / 40	32-6996-75
	22,0 cm



g / mm	Mc EVEN
250 / 25	32-6997-25
350 / 30	32-6997-35
500 / 35	32-6997-50
600 / 40	32-6997-60
750 / 45	32-6997-75
	22,0 cm



QUISLING
32-6998-75



cm
23,5 32-6999-00

für Autopsie
Post-mortem
pour autopsie
para autopsia
per autopsia

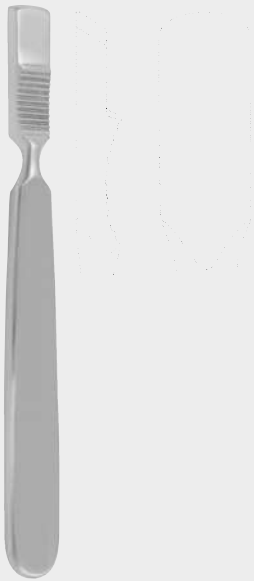

cm FARABEUFF —
15,0 32-7002-15



cm FARABEUFF —
15,0 32-7003-15



cm FARABEUFF COLLIN —
16,0 32-7004-16



cm FARABEUFF COLLIN —
16,0 32-7005-16

Raspatorien
Raspatories, Periosteal Elevators
Rugines-raspatoirs
Legras
Periostotomi

KNOCHENCHIRURGIE

BONE SURGERY

CHIRURGIE OSSEUSE

CIRUGÍA ÓSEA

CHIRURGIA OSSEA



mm LAMBOTTE 21,0 cm —
5,0 32-7007-05
10,0 32-7007-10
15,0 32-7007-15
20,0 32-7007-20
25,0 32-7007-25

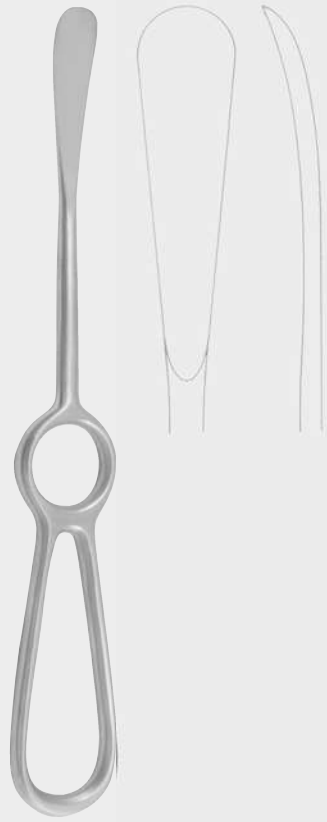

cm SEDILLOT —
21,0 32-7009-21



cm SEDILLOT —
18,5 32-7011-18

Raspatorien
Raspatories, Periosteal Elevators
Rugines-raspatoires
Periotótomos
Periostotomi

KNOCHENCHIRURGIE

BONE SURGERY

CHIRURGIE OSSEUSE

CIRUGÍA ÓSEA

CHIRURGIA OSSEA



cm BRISTOW
18,0 32-7013-18



DEWARE (COBB) 20,0 cm
32-7021-20



mm MATTHIEU 17,0 cm
6,0 32-7100-06
9,0 32-7100-09



cm LANGENBECK
19,0 32-7102-19



cm LANGENBECK
18,0 32-7103-18



cm JANSEN
16,5 32-7105-16

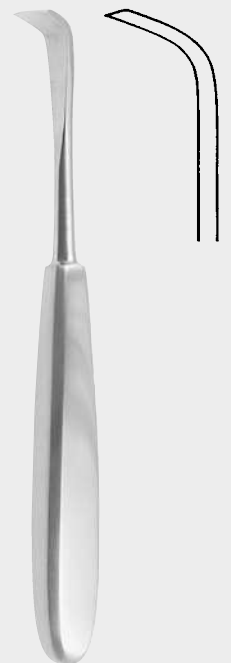

cm SCHNEIDER
17,5 32-7107-17



cm SCHNEIDER SAUERBRUCH
19,0 32-7109-19



cm CUSHING Little Joker
15,0 32-7111-15



cm CUSHING Little Joker
19,0 32-7113-19

Raspororien
Raspatories, Periosteal Elevators
Rugines-raspatoires
Legras
Periostotomi

KNOCHENCHIRURGIE

BONE SURGERY

CHIRURGIE OSSEUSE

CIRUGÍA ÓSEA

CHIRURGIA OSSEA



Fig.	mm	WIBERG 17,0 cm
1	4,0	32-7118-04
2	7,0	32-7118-07
3	9,0	32-7118-09
4	12,0	32-7118-12



mm KÖNIG 15,5 cm
15 32-7177-15



cm
17,0 32-7179-06 - 32-7179-08

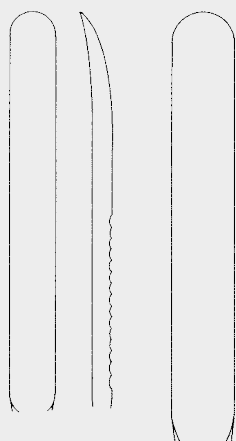

mm	mm
6,0	8,0
32-7179-06	32-7179-08

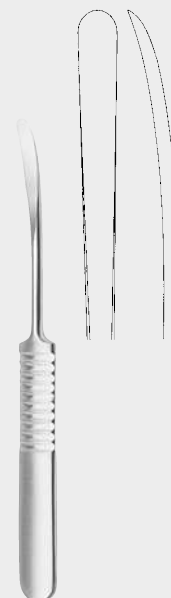

cm WILLIGER
13,0 32-7181-13

Raspatorien
 Raspatories, Periosteal Elevators
 Rugines-raspatoires
 Periotómos
 Periototomi

KNOCHENCHIRURGIE

BONE SURGERY

CHIRURGIE OSSEUSE

CIRUGÍA ÓSEA

CHIRURGIA OSSEA



mm	16,0 cm
5,0	32-7182-05
6,0	32-7182-06
7,0	32-7182-07

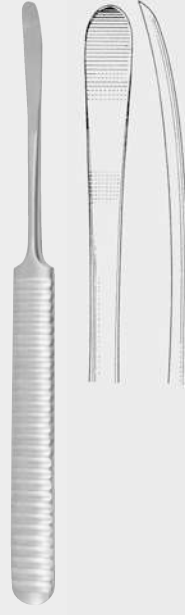

cm	WILLIGER	mm
16,0	32-7183-16	6,0
16,0	32-7183-17	7,0



mm	WILLIGER KAHRE 16,5 cm
4,0	32-7184-04
5,0	32-7184-05



cm	ALEXANDER
16,0	32-7185-16
20,0	32-7185-20



cm	»	DOYEN	«
17,0	32-7201-17		32-7203-17
24,0	32-7201-24		32-7203-24
17,0	32-7205-17		32-7207-17



»
32-7201-17
32-7201-24

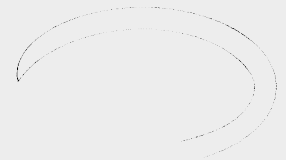

«
32-7203-17
32-7203-24

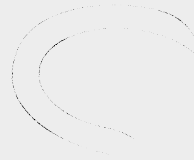

»
32-7205-17

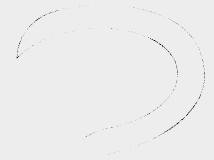

«
32-7207-17



cm	cm	cm	cm	cm	cm	cm
17,5	21,0	17,5	21,0	20,5	20,5	20,5
32-7209-01	32-7209-02	32-7209-03	32-7209-04	32-7209-05	32-7209-06	32-7209-07



SEMB
32-7209-01 - 32-7209-07

Raspatorien
Raspatories, Periosteal Elevators
Rugines-raspatoires
Legras
Periostotomi

KNOCHENCHIRURGIE

BONE SURGERY

CHIRURGIE OSSEUSE

CIRUGÍA ÓSEA

CHIRURGIA OSSEA



MATSON-ALEXANDER
32-7301-22



cm **MATSON**
22,0 32-7303-22



cm **OVERHOLT**
29,5 32-7305-29



cm **OVERHOLT**
29,5 32-7307-29



cm **OVERHOLT**
29,5 32-7309-28

Raspatorien
 Raspatories, Periosteal Elevators
 Rugines-raspatoires
 Periotótomos
 Periostotomi

KNOCHENCHIRURGIE

BONE SURGERY

CHIRURGIE OSSEUSE

CIRUGÍA ÓSEA

CHIRURGIA OSSEA



mm LANDOLT 17,5 cm
 4,7 32-7400-47



mm CASPAR 18,0 cm
 6,2 32-7401-62



mm CASPAR 18,0 cm
 6,2 32-7402-62



mm CASPAR 17,0 cm
 3,0 32-7403-03
 6,0 32-7403-06



cm CASPAR
 20,5 32-7404-01



cm CASPAR
 20,5 32-7404-02



cm SEBILEAU
 17,5 32-7451-17
 5,0 mm



cm QUERVAIN
 19,5 32-7453-19
 6,0 mm



cm KÖNIG
 15,5 32-7457-15
 4,5 mm

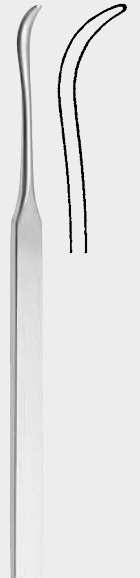

cm KÖNIG
 15,5 32-7459-15
 4,5 mm





cm	WILLIGER
16,5	32-7461-16
	5,0 mm



cm	WILLIGER
17,0	32-7461-17
	5,5 mm



cm	MARTIN LANGENBECK	mm
17,0	32-7490-05	5,0
17,0	32-7490-07	7,0
19,5	32-7490-08	8,0
19,5	32-7490-10	10,0



	SAYRE 17,0 cm
	32-7494-01
	32-7494-02
	9,0 mm



cm	CAIRNS
18,0	32-7495-18

Elevatorii
Elevators
Elévateurs
Elevadores
Elevatori

KNOCHENCHIRURGIE

BONE SURGERY

CHIRURGIE OSSEUSE

CIRUGÍA ÓSEA

CHIRURGIA OSSEA



cm	OHL
18,0	32-7496-18



cm	LANGENBECK	mm
20,0	32-7501-08	8,0
20,0	32-7501-10	10,0



cm	JONES
18,5	32-7503-18



cm	ADSON
17,0	32-7504-17 - 32-7507-17



32-7504-17



32-7505-17



32-7506-17



32-7507-17

Raspatorien
 Raspatories, Periosteal Elevators
 Rugines-raspatoires
 Periotótomos
 Periostotomi

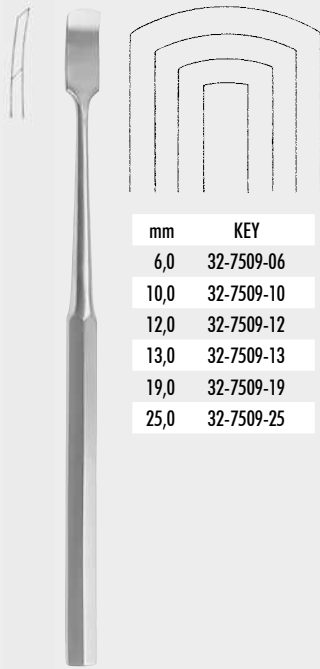

cm KEY
 19,0 32-7509-06 - 32-7509-25



mm CUSHING 19,5 cm
 5,0 32-7602-19



mm CUSHING 18,0 cm
 16,0 32-7603-18



mm CUSHING 18,0 cm
 16,0 32-7604-18

KNOCHENCHIRURGIE

BONE SURGERY

CHIRURGIE OSSEUSE

CIRUGÍA ÓSEA

CHIRURGIA OSSEA



cm WATSON CHEYNE
 17,5 32-7605-17



cm McDONALD
 19,0 32-7607-19



cm
 17,5 32-7609-17

sehr leicht
 light weight
 très léger
 muy ligero
 molto leggero



cm HOWARTH
 21,5 32-7611-21



cm SYME
 18,5 32-7613-18



mm MÜHLING 17,0 cm
4,0 32-7615-01



mm MÜHLING 17,0 cm
4,0 32-7615-02



mm MÜHLING 17,0 cm
4,0 32-7615-03



mm MÜHLING 17,0 cm
4,0 32-7615-04

Raspatorien
Raspatories, Periosteal Elevators
Rugines-raspatoires
Legras
Periostotomi

KNOCHENCHIRURGIE

BONE SURGERY

CHIRURGIE OSSEUSE

CIRUGÍA ÓSEA

CHIRURGIA OSSEA



cm mm
19,0 32-7621-01 6,0



cm mm
18,5 32-7621-02 3,0



cm mm
19,0 32-7621-03 6,0



cm mm
19,0 32-7621-04 6,0

Raspatorien
Raspatories, Periosteal Elevators
Rugines-raspatoires
Periotótomos
Periostotomi

KNOCHENCHIRURGIE

BONE SURGERY

CHIRURGIE OSSEUSE

CIRUGÍA ÓSEA

CHIRURGIA OSSEA



cm		mm
18,5	32-7623-01	13,0

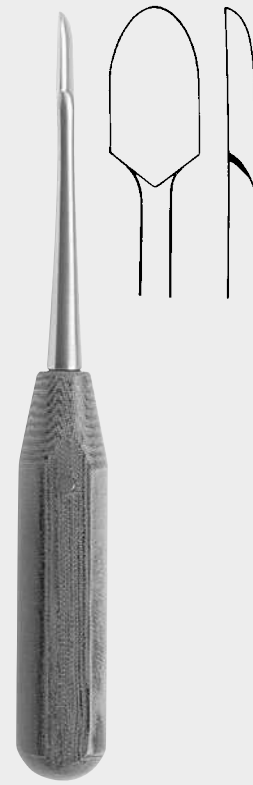

cm		mm
19,5	32-7623-02	14,0

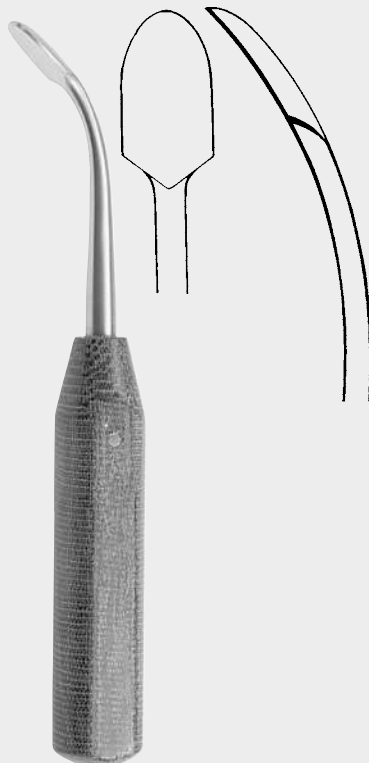

cm		mm
19,0	32-7623-03	14,0

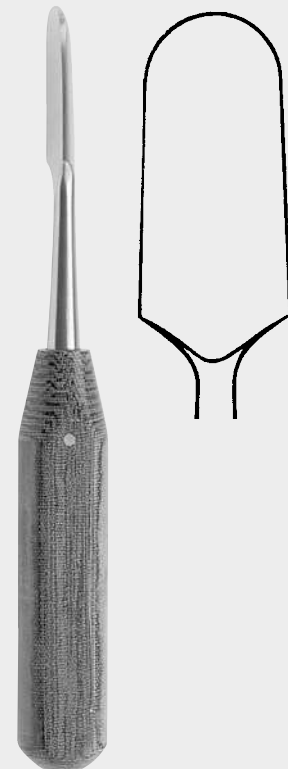

cm		mm
20,0	32-7623-04	20,0

ZEPF[®]
α
INSTRUMENTS

32-7623-01

32.68

Raspatorien
 Raspatories, Periosteal Elevators
 Rugines-raspatoirs
 Periotómos
 Periostotomi

KNOCHENCHIRURGIE

BONE SURGERY

CHIRURGIE OSSEUSE

CIRUGÍA ÓSEA

CHIRURGIA OSSEA



mm	COBB
10,0	32-7631-10
13,0	32-7631-13
19,0	32-7631-19
28,0 cm	



HOEN (GUTSCH)
 32-7633-07 - 32-7637-20



cm	mm
16,0	7,0



cm	mm
18,5	15,0

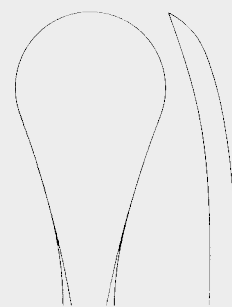

cm	mm
19,0	20,0



Knochenhebel
Bone Levers
Leviers à os
Elevadores para huesos
Elevatori per ossa

KNOCHENCHIRURGIE

BONE SURGERY

CHIRURGIE OSSEUSE

CIRUGÍA ÓSEA

CHIRURGIA OSSEA



mm	D'AUBIGNE 23,0 cm	
10,0	32-7638-10	32-7639-10
12,0	32-7638-12	32-7639-12



mm	Mc GLAMRY 16,5 cm
11	32-7641-11
13	32-7641-13
15	32-7641-15
17	32-7641-17



mm x mm	FUKUDA 18,0 cm
32,0 x 81,0	32-7681-32
38,0 x 81,0	32-7681-38



cm	MEYERDING
33,0	32-7687-33



cm	MURPHY LANE	mm
30,0	32-7689-30	25,0

ZEPF[®]
α
INSTRUMENTS

32-7638-10

32.70

Knochenhebel
Bone Levers
Leviers à os
Elevadores para huesos
Elevatori per ossa



BENNETT
32-7701-71
65 x 240 mm

BENNETT
32-7701-73
45 x 240 mm

mm x mm	MERLE D'AUBIGNE
40 x 20	32-7703-20
40 x 30	32-7703-30

mm **WAGNER 22,0 cm**
17 32-7910-22

mm **HOHMANN 22,0 cm**
17 32-7916-17

mm **SCHUHMACHER WAGNER 34,5 cm**
37 32-7920-37



mm 29,0 cm
40 32-7924-29

mm 30,0 cm
22 32-7826-30

mm **HOHMANN ALDINGER 27,0 cm**
24 32-7930-24

24,0 cm
32-7936-22
32-7936-28
32-7936-40

24,0 cm
32-7940-28
32-7940-40

KNOCHENCHIRURGIE

BONE SURGERY

CHIRURGIE OSSEUSE

CIRUGÍA ÓSEA

CHIRURGIA OSSEA

Knochenhebel
Bone Levers
Leviers à os
Elevadores para huesos
Elevatori per ossa

KNOCHENCHIRURGIE

BONE SURGERY

CHIRURGIE OSSEUSE

CIRUGÍA ÓSEA

CHIRURGIA OSSEA

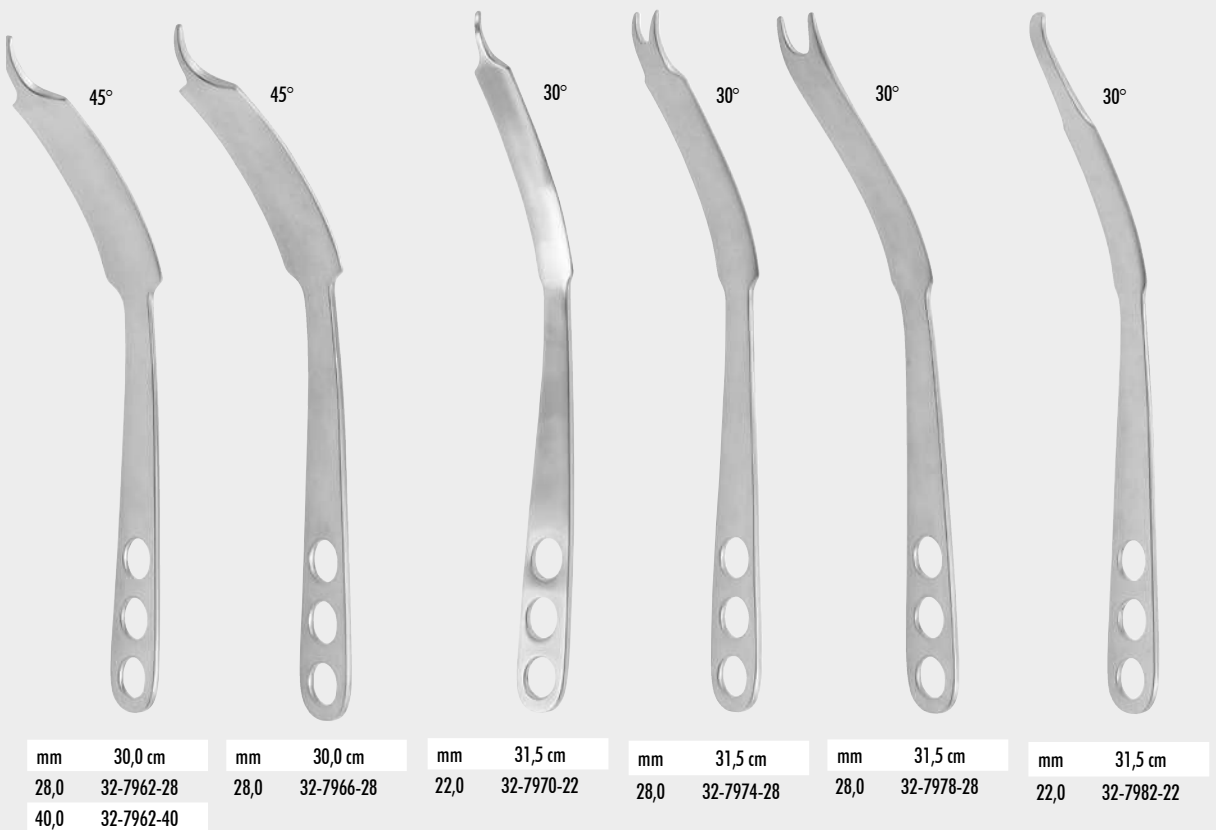
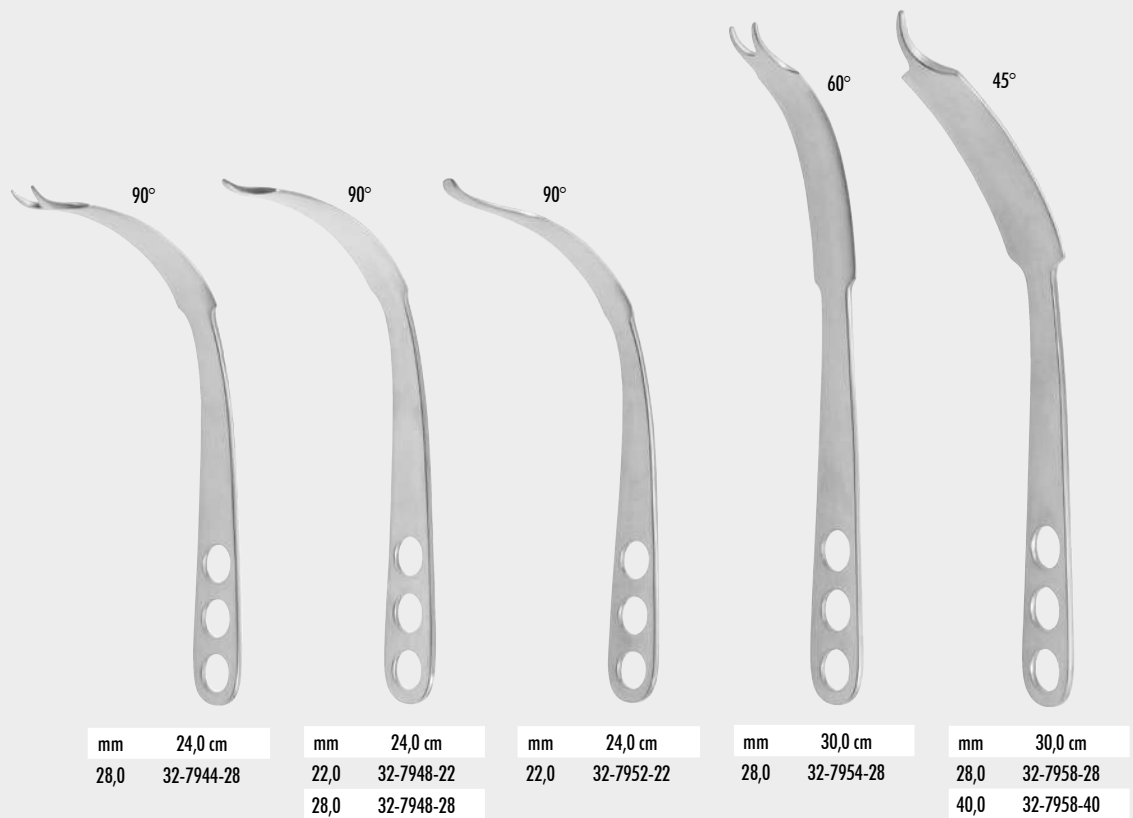



8 mm

mm HOHMANN
8,0 32-8001-08



18 mm

mm HOHMANN
18,0 32-8001-17 - 32-8001-18



32-8001-17

32-8001-18



43 mm

mm VERBRUEGGE HOHMANN (MÜLLER)
43,0 32-8001-43

Knochenhebel
Bone Levers
Leviers à os
Elevadores para huesos
Elevatori per ossa

KNOCHENCHIRURGIE

BONE SURGERY

CHIRURGIE OSSEUSE

CIRUGÍA ÓSEA

CHIRURGIA OSSEA



70 mm

mm HOHMANN
70,0 32-8001-70



43 mm

mm HOHMANN
43,0 32-8003-43

Knochenhebel
 Bone Levers
 Leviers à os
 Elevadores para huesos
 Elevatori per ossa

KNOCHENCHIRURGIE

BONE SURGERY

CHIRURGIE OSSEUSE

CIRUGÍA ÓSEA

CHIRURGIA OSSEA



mm HOHMANN
 22,0 32-8005-22

mm HOHMANN
 33,0 32-8005-33

mm HOHMANN
 24,0 32-8007-24

mm LANGE HOHMANN
 22,0 32-8009-22



mm LANGE HOHMANN modif cm
 30,0 32-8011-27 26,5
 33,0 32-8011-28 28,0

mm HOHMANN ACETABULUM cm
 40,0 32-8013-40 33,0

mm cm
 27,5 32-8015-24 24,0

mm cm
 18,0 32-8017-18 22,0