



CARDIOVASCULAR
INSTRUMENTE

CARDIOVASCULAR
INSTRUMENTS

INSTRUMENTS
CARDIOVASCULAIRES

INSTRUMENTOS
CARDIOVASCULARES

STRUMENTI
CARDIOVASCOLARI



CARDIOVASCULAR
INSTRUMENTE

CARDIOVASCULAR
INSTRUMENTS

INSTRUMENTS
CARDIOVASCULAIRES

INSTRUMENTOS
CARDIOVASCULARES

STRUMENTI
CARDIOVASCOLARI



DEBAKEY HALSTEAD MOSQUITO

13-0800-12 - 13-0801-15



13-0800-12
12 cm



13-0801-12
12 cm



13-0800-15
15 cm



13-0801-15
15 cm



13-0802-14
14 cm



13-0802-16
16 cm



13-0802-18
18 cm



13-0802-20
20 cm



PEAN

13-0802-14 - 13-0803-20



13-0803-14
14 cm



13-0803-16
16 cm



13-0803-18
18 cm



13-0803-20
20 cm

CARDIOVASCULAR
INSTRUMENTE

CARDIOVASCULAR
INSTRUMENTS

INSTRUMENTS
CARDIOVASCULAIRES

PINZAS VASCULARES
ATRAUMÁTICAS

INSTRUMENTOS
CARDIOVASCULARES



ATRAUMA



DEBAKEY



13-0804-16



13-0805-16

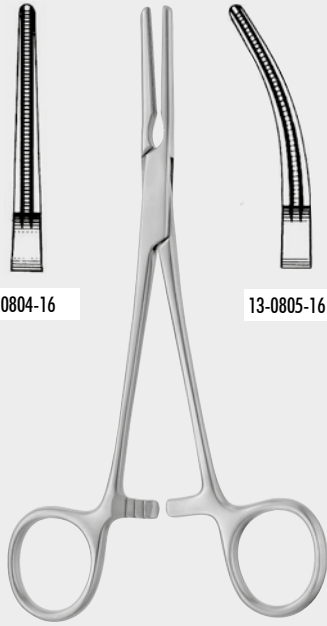

DEBAKEY RANKIN
13-0804-16 - 13-0805-16
16,0 cm



13-1002-12



13-1003-12

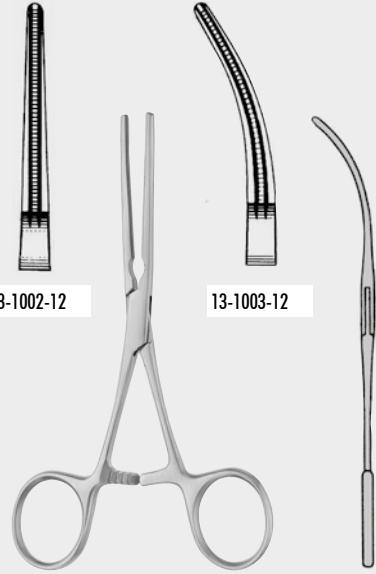

DEBAKEY
13-1002-12 - 13-1003-12
12,0 cm

CARDIOVASCULAR
INSTRUMENTE

CARDIOVASCULAR
INSTRUMENTS

INSTRUMENTS
CARDIOVASCULAIRES

INSTRUMENTOS
CARDIOVASCULARES

STRUMENTI
CARDIOVASCOLARI



DEBAKEY
13-1103-12
11 cm



DEBAKEY
13-1101-12
12 cm



DEBAKEY
13-1201-12
12 cm

ATRAUMA



DEBAKEY



Bronchusklemmen
Bronchus Clamps
Pinces pour les bronches
Pinzas bronquiales
Pinze per bronchi



LEES
13-1301-23 - 13-1303-25
23 cm

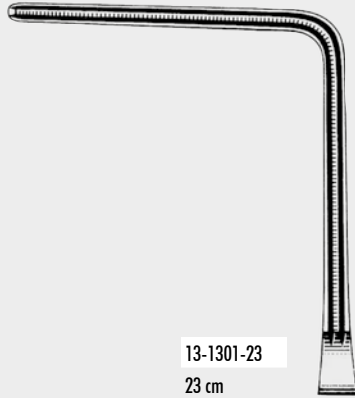

13-1301-23
23 cm

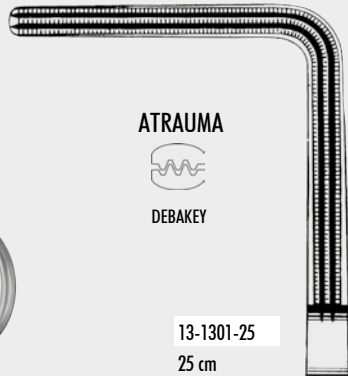

ATRAUMA



DEBAKEY

13-1301-25
25 cm



LEES
13-1303-25
25 cm

CARDIOVASCULAR
INSTRUMENTE

CARDIOVASCULAR
INSTRUMENTS

INSTRUMENTS
CARDIOVASCULAIRES

PINZAS VASCULARES
ATRAUMÁTICAS

INSTRUMENTOS
CARDIOVASCULARES



13-1303-25



ATRAUMA



DEBAKEY

Coarctationsklemmen
Coarctation Clamps
Pinces à coarctation
Pinzas para coarctación
Pinze per coarctazione

CARDIOVASCULAR
INSTRUMENTE

CARDIOVASCULAR
INSTRUMENTS

INSTRUMENTS
CARDIOVASCULAIRES

INSTRUMENTOS
CARDIOVASCULARES

STRUMENTI
CARDIOVASCOLARI



POTTS
13-1400-20 - 13-1400-26

13-1400-20
20 cm



13-1400-21
21 cm



13-1400-22
22 cm



13-1400-26
26 cm

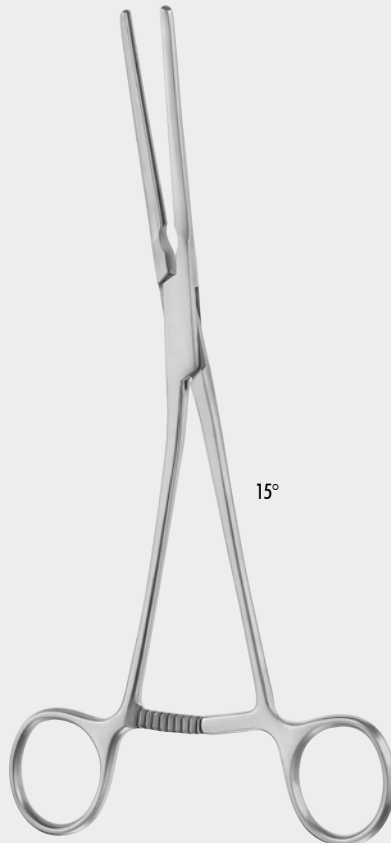

GLOVER
13-1401-20 - 13-1401-26

15°

13-1401-20
20 cm



13-1401-22
22 cm



13-1401-26
26 cm

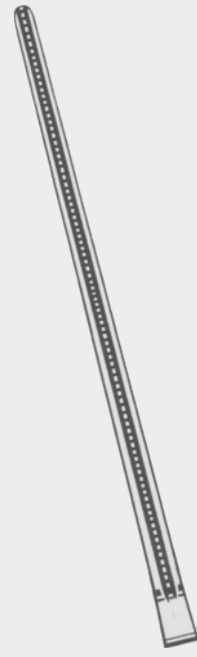

ZEPF®
INSTRUMENTS

13-1400-20

ATRAUMA



DEBAKEY



Coarctationsklemmen
Coarctation Clamps
Pinces à coarctation
Pinzas para coarctación
Pinze per coarctazione



POTTS
13-1403-21 - 13-1403-22



13-1403-21
21 cm

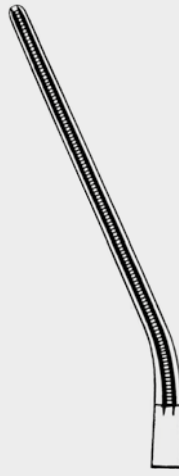

13-1403-22
22 cm



CARDIOVASCULAR
INSTRUMENTE

CARDIOVASCULAR
INSTRUMENTS

INSTRUMENTS
CARDIOVASCULAIRES

PINZAS VASCULARES
ATRAUMÁTICAS

INSTRUMENTOS
CARDIOVASCULARES



POTTS
13-1405-21 - 13-1405-22

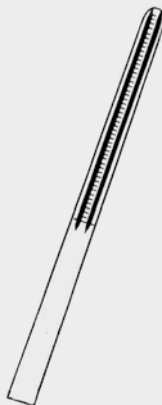

13-1405-21
21 cm



13-1405-22
22 cm



ZEPF[®]
INSTRUMENTS

13-1405-22



ATRAUMA



DEBAKEY

Anastomosenklemmen
Anastomosis Clamps
Pinces à anastomose
Pinzas para anastomosis
Pinze per anastomosi

CARDIOVASCULAR
INSTRUMENTE

CARDIOVASCULAR
INSTRUMENTS

INSTRUMENTS
CARDIOVASCULAIRES

INSTRUMENTOS
CARDIOVASCULARES

STRUMENTI
CARDIOVASCOLARI



GLOVER

13-1501-21 - 13-1501-24

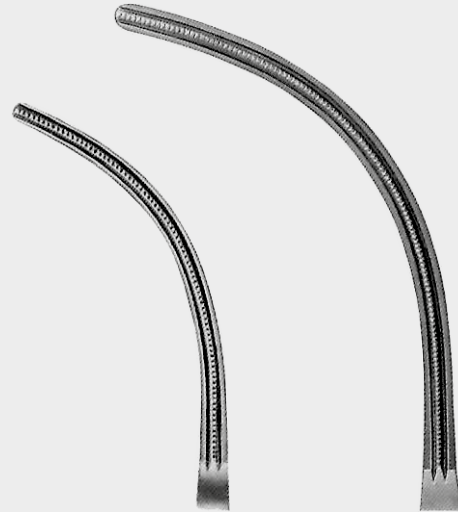

13-1501-21

21 cm

13-1501-24

24 cm



GLOVER

13-1503-18 - 13-1503-22

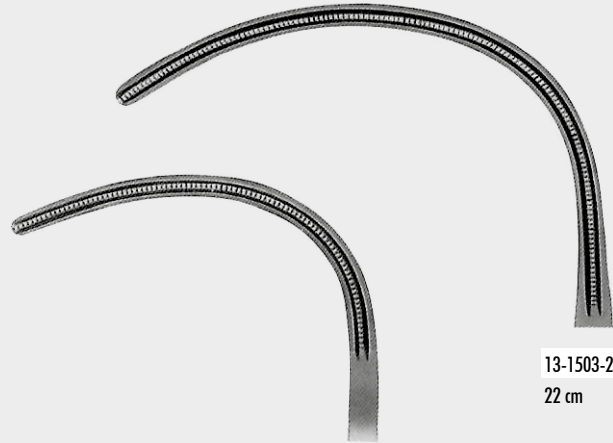

13-1503-18

18 cm

13-1503-22

22 cm

ZEPF®
INSTRUMENTS

13-1501-21



Anastomosenklemmen
Anastomosis Clamps
Pinces à anastomose
Pinzas para anastomosis
Pinze per anastomosi



GLOVER
13-1601-21
21 cm

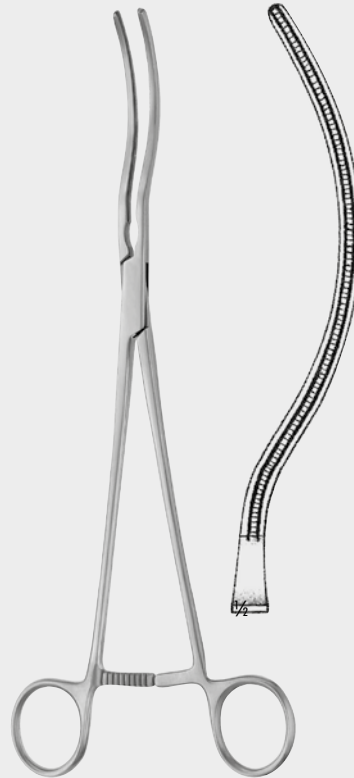

GLOVER
13-1601-26
26 cm



CARDIOVASCULAR
INSTRUMENTE

CARDIOVASCULAR
INSTRUMENTS

INSTRUMENTS
CARDIOVASCULAIRES

PINZAS VASCULARES
ATRAUMÁTICAS

INSTRUMENTOS
CARDIOVASCULARES

Peripheal-Gefäßklemmen
Peripheal Vascular Forceps
Pince vasculaires périphériques
Pinzas vasculares periféricas
Pinze vascolari periferali



13-1700-19
19 cm



13-1700-22
22 cm

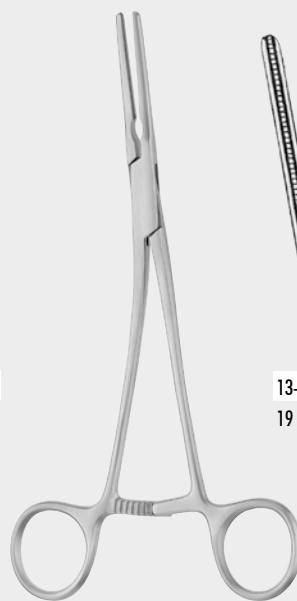

13-1701-19
19 cm



13-1701-22
22 cm

DEBAKEY
13-1700-19 - 13-1700-22

DEBAKEY
13-1701-19 - 13-1701-22



ATRAUMA



DEBAKEY

Atraumatische Mehrzweckklemmen
Atraumatic Multi-Purpose Clamps
Pinces-clamps polyvalentes
Pinzas clamps para usos varios
Pinze atraumatiche per diversi usi



DARDIK
13-1702-00 - 13-1704-90



13-1702-00
15 cm



15°
13-1702-15
15 cm



30°
13-1702-30
15 cm



45°
13-1702-45
15 cm



90°
13-1702-90
14 cm

CARDIOVASCULAR INSTRUMENTE

CARDIOVASCULAR INSTRUMENTS

INSTRUMENTS CARDIOVASCULAIRES

INSTRUMENTOS CARDIOVASCULARES

STRUMENTI CARDIOVASCOLARI



13-1704-00
17 cm

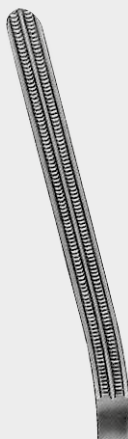

15°
13-1704-15
17 cm

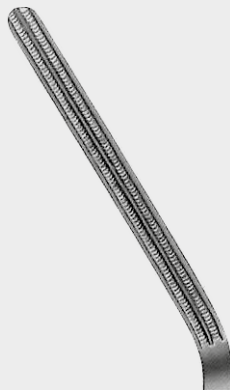

30°
13-1704-30
17 cm



45°
13-1704-45
17 cm



90°
13-1704-90
16 cm

ATRAUMA



DEBAKEY



Peripheal-Gefäßklemmen
Peripheal Vascular Clamps
Pinces vasculaires périphériques
Pinzas vasculares periféricas
Pinze vascolari periferali

CARDIOVASCULAR
INSTRUMENTE

CARDIOVASCULAR
INSTRUMENTS

INSTRUMENTS
CARDIOVASCULAIRES

PINZAS VASCULARES
ATRAUMÁTICAS

INSTRUMENTOS
CARDIOVASCULARES

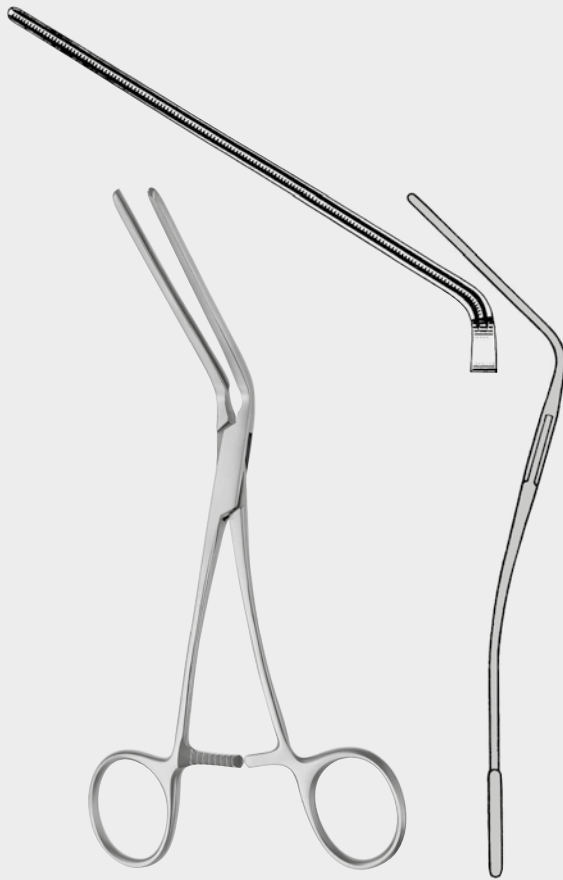

LELAND JONES
13-1801-19
19 cm

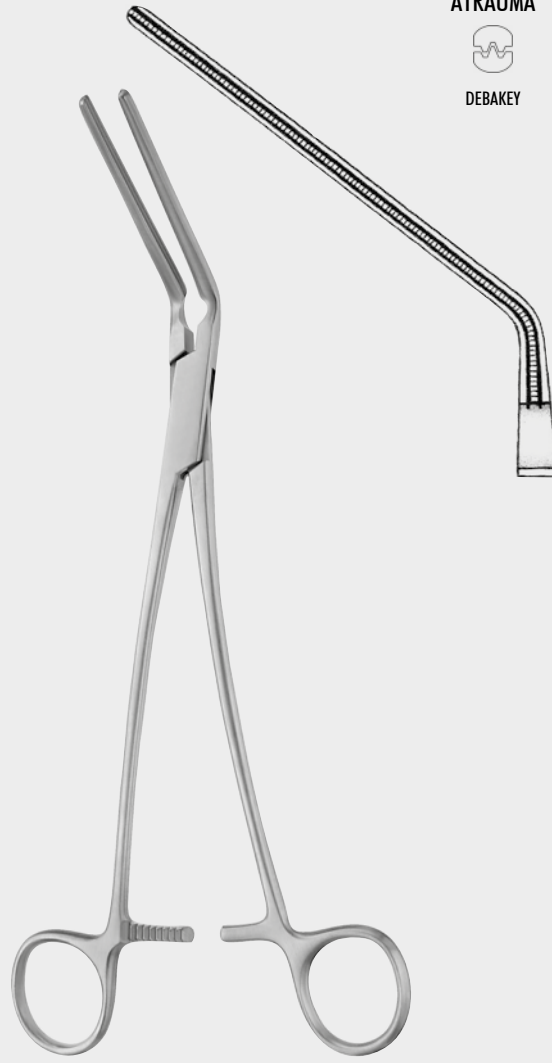

DEBAKEY
13-1801-26
26 cm



DEBAKEY
13-1803-19 - 13-1901-16

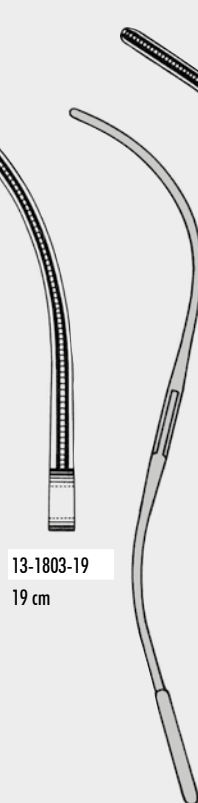

13-1803-19
19 cm

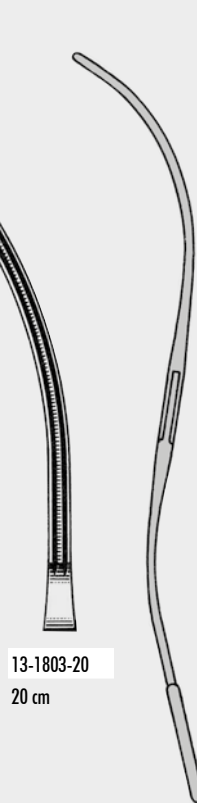

13-1803-20
20 cm

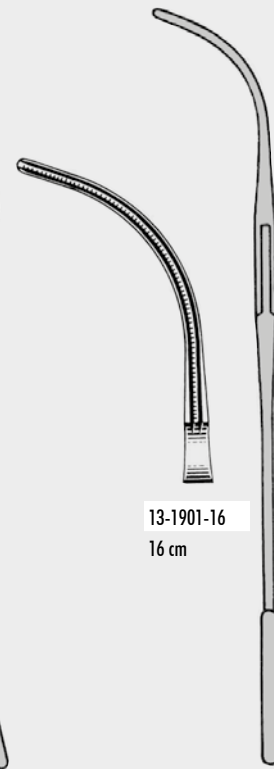

13-1901-16
16 cm

ZEPF[®]
INSTRUMENTS

13-1901-16



ATRAUMA



DEBAKEY

Atraumatische Mehrzweckklemmen
Atraumatic Multi-Purpose Clamps
Pinces-clamps polyvalentes
Pinzas clamps para usos varios
Pinze atraumatiche per diversi usi

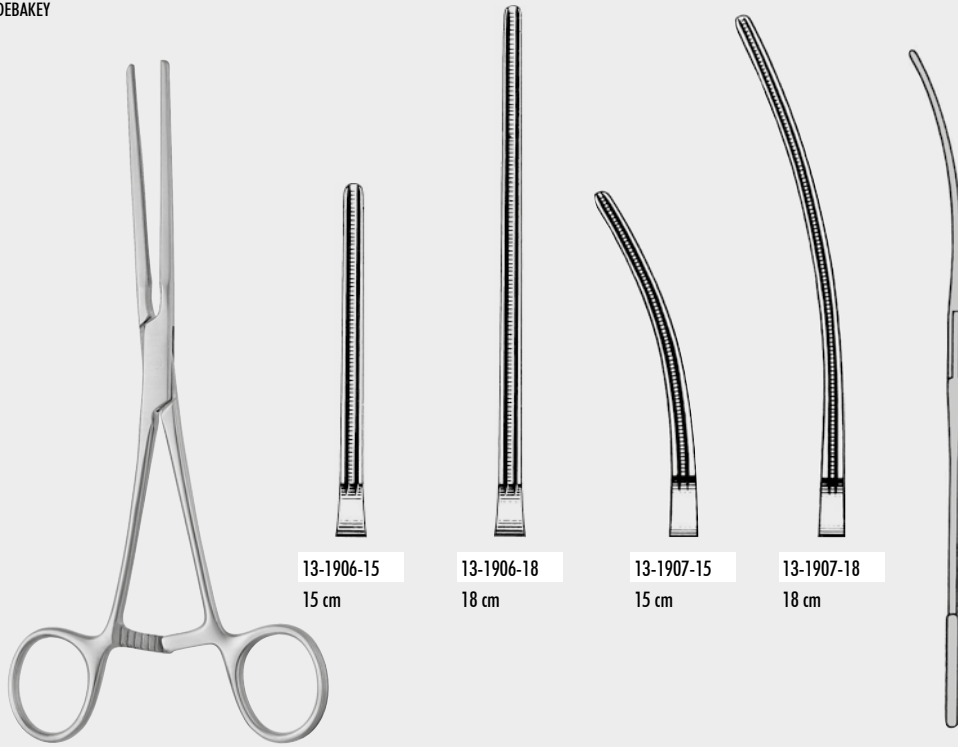

13-1906-15
15 cm

13-1906-18
18 cm

13-1907-15
15 cm

13-1907-18
18 cm

CARDIOVASCULAR INSTRUMENTE

CARDIOVASCULAR INSTRUMENTS

INSTRUMENTS CARDIOVASCULAIRES

INSTRUMENTOS CARDIOVASCULARES

STRUMENTI CARDIOVASCOLARI

Peripheal-Gefäßklemmen
Peripheal Vascular Clamps
Pinces vasculaires périphériques
Pinzas vasculares periféricos
Pinze vascolari periferali



13-2002-19
19 cm

13-2003-19
19 cm

13-2005-19
19 cm

LELAND JONES
13-2002-19 - 13-2005-19



13-1906-15

ATRAUMA



DEBAKEY



Peripheal-Gefäßklemmen
Peripheal Vascular Clamps
Pinces-clamps, vasculaires périphériques
Pinzas para vasos periféricos
Pinze vascolari periferali



13-2007-16
16 cm

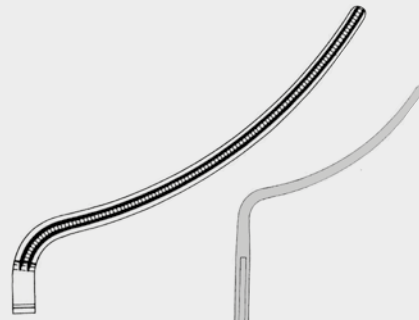

13-2007-17
17 cm

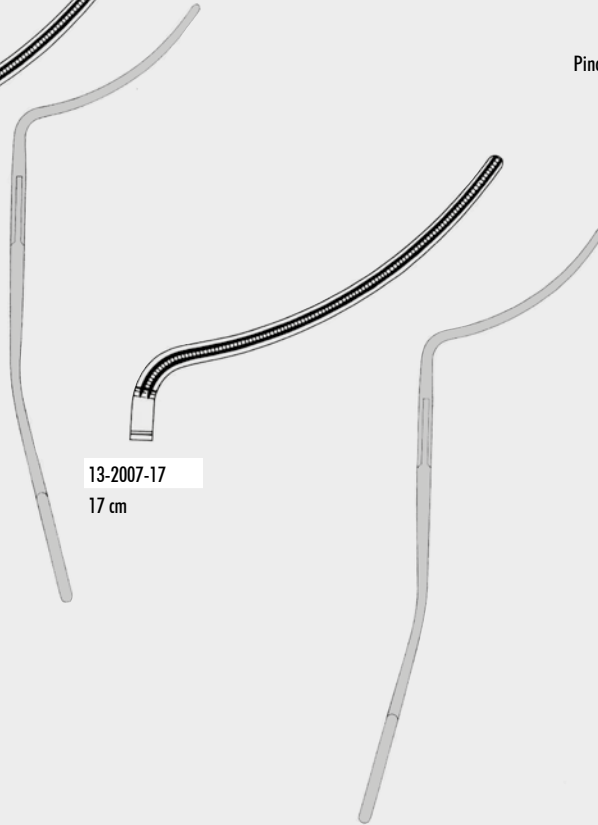

MARTIN

13-2007-16 - 13-2007-20

CARDIOVASCULAR
INSTRUMENTE

CARDIOVASCULAR
INSTRUMENTS

INSTRUMENTS
CARDIOVASCULAIRES

PINZAS VASCULARES
ATRAUMÁTICAS

INSTRUMENTOS
CARDIOVASCULARES

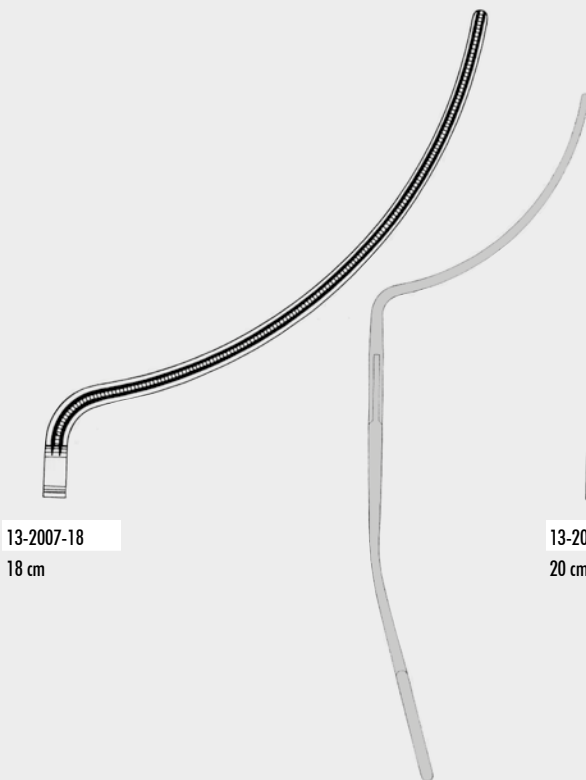

13-2007-18
18 cm

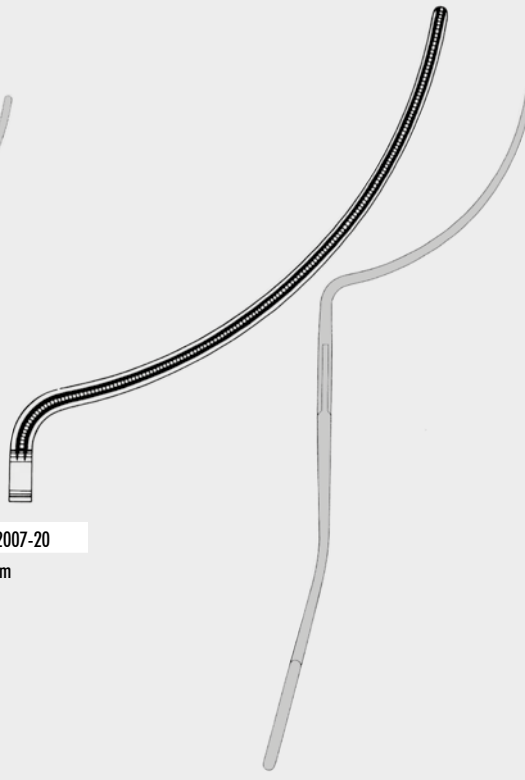

13-2007-20
20 cm

ZEPF[®]
α
INSTRUMENTS

13-2007-20



ATRAUMA



DEBAKEY

Aortaklemmen
Aortic Clamp
Pince-clamp à aorte
Pinza clamp para aorta
Pinza per aorta

CARDIOVASCULAR
INSTRUMENTE

CARDIOVASCULAR
INSTRUMENTS

INSTRUMENTS
CARDIOVASCULAIRES

INSTRUMENTOS
CARDIOVASCULARES

STRUMENTI
CARDIOVASCOLARI

Aorta-Anastomosenklemmen
Aorta-Anastomosis Clamps
Pinces-clamps pour anastomoses d'aorte
Pinzas clamps para anastomosis de aorta
Pinze aortiche

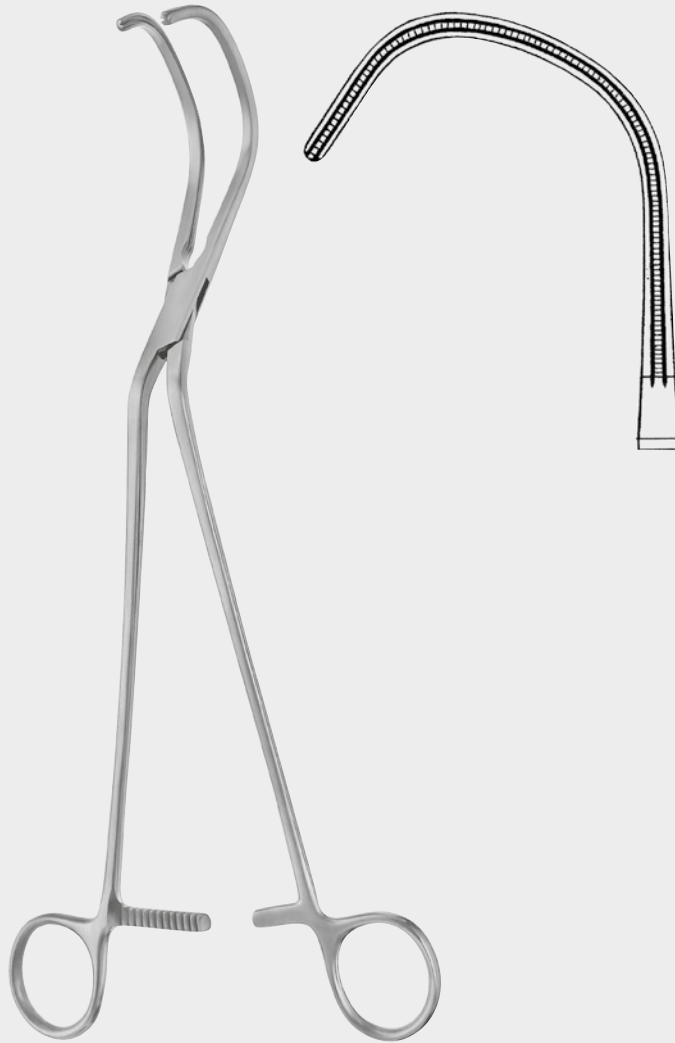

LIDDLE
13-2009-27
27 cm



13-2101-20

13-2103-20

LAMBERT KAY
13-2101-20 - 13-2103-20
20 cm

ZEPF®
INSTRUMENTS

13-2009-27

ATRAUMA



DEBAKEY



DEBAKEY
13-2105-20
20 cm

Iliaca-Klemme
Iliac Clamp
Pince-clamp à iliaque
Pinza clamp para iliaca
Pinza per iliaca

CARDIOVASCULAR
INSTRUMENTE

CARDIOVASCULAR
INSTRUMENTS

INSTRUMENTS
CARDIOVASCULAIRES

PINZAS VASCULARES
ATRAUMÁTICAS

INSTRUMENTOS
CARDIOVASCULARES

Aortaklemmen
Aortic Clamp
Pince-clamp à aorte
Pinza clamp para aorta
Pinza per aorta



WEBER
13-2107-26
26 cm



WEBER
13-2109-26
26 cm

ZEPF[®]
INSTRUMENTS

13-2109-26



ATRAUMA



DEBAKEY

Aorta-Aneurysma-Klemmen
Aorta-Aneurysm Clamps
Pinces-clamps pour aneurysme d'aorte
Pinzas clamps para aneurisma de aorta
Pinze per aneurisma di aorta

CARDIOVASCULAR
INSTRUMENTE

CARDIOVASCULAR
INSTRUMENTS

INSTRUMENTS
CARDIOVASCULAIRES

INSTRUMENTOS
CARDIOVASCULARES

STRUMENTI
CARDIOVASCOLARI

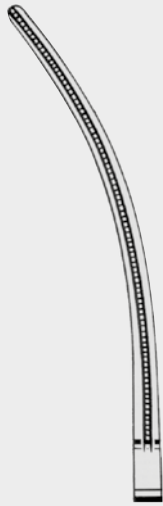

13-2201-24
24 cm



13-2201-27
27 cm



13-2201-30
30 cm



13-2201-31
31 cm

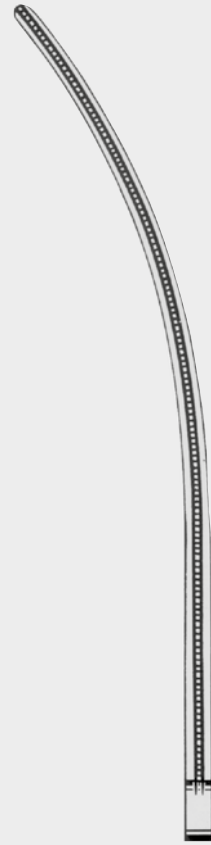

13-2201-35
33 cm

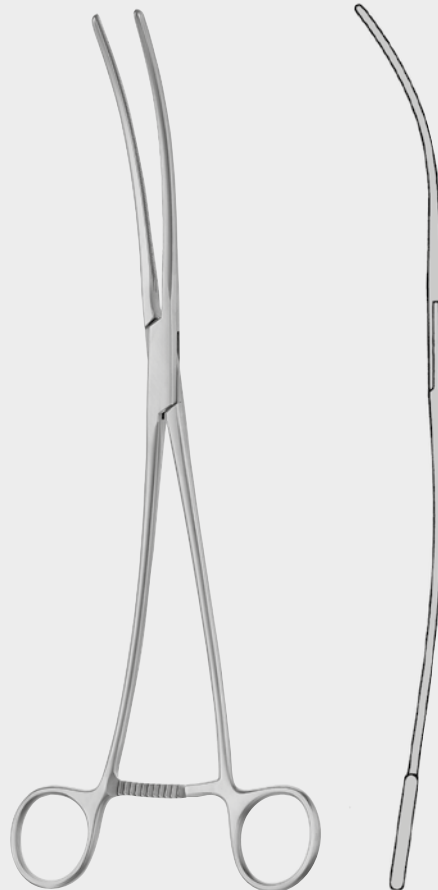

DEBAKEY
13-2201-24 - 13-2201-35

ATRAUMA



DEBAKEY



DEBAKEY BAHNSON
13-2203-24 - 13-2203-26



13-2203-24
24 cm



13-2203-25
25 cm



13-2203-26
26 cm



CARDIOVASCULAR
INSTRUMENTE

CARDIOVASCULAR
INSTRUMENTS

INSTRUMENTS
CARDIOVASCULAIRES

PINZAS VASCULARES
ATRAUMÁTICAS

INSTRUMENTOS
CARDIOVASCULARES

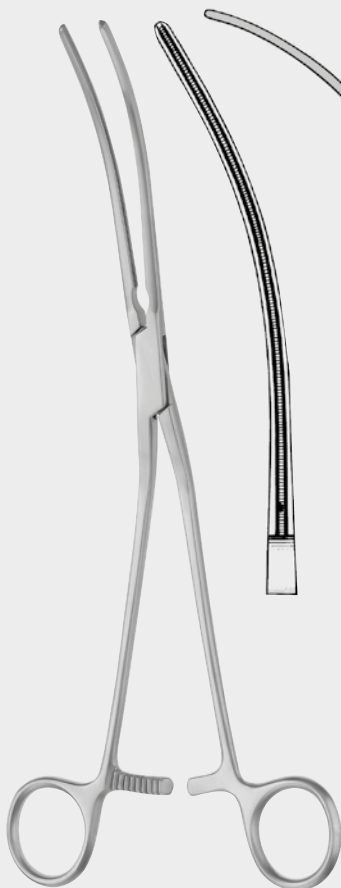

DEBAKEY
13-2205-28
28 cm

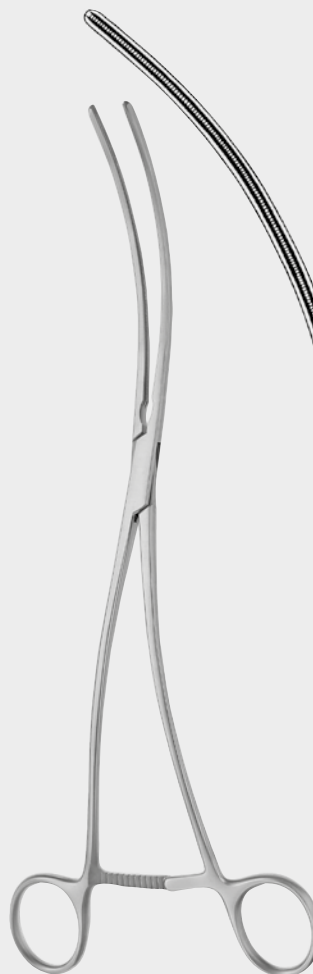

DEBAKEY
13-2207-28
28 cm

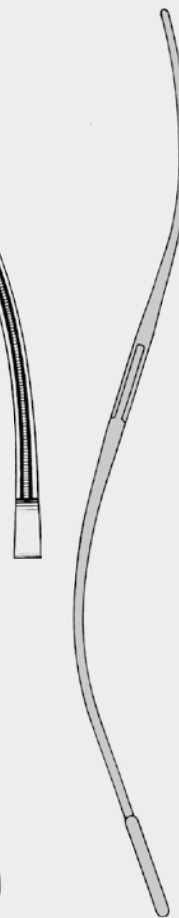

ZEPF[®]
Q
INSTRUMENTS

13-2207-28



ATRAUMA



DEBAKEY

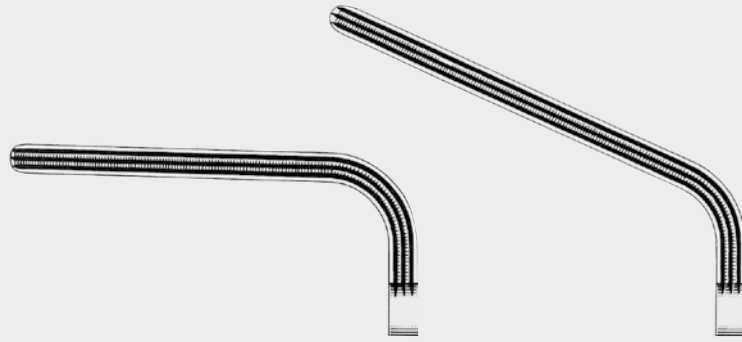

13-2209-18
18 cm

13-2209-20
20 cm

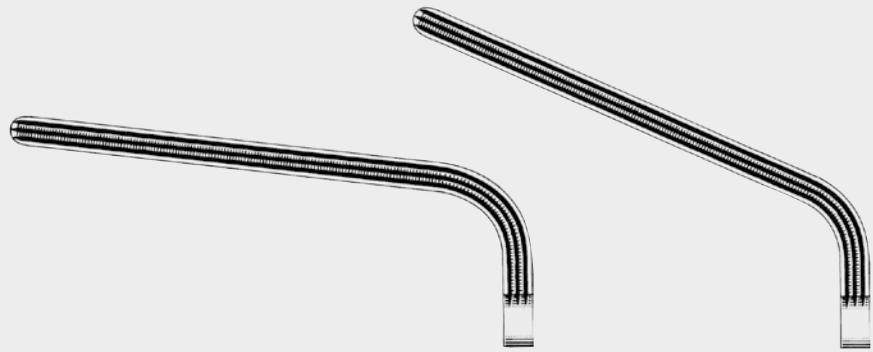

13-2209-23
23 cm

13-2209-25
25 cm

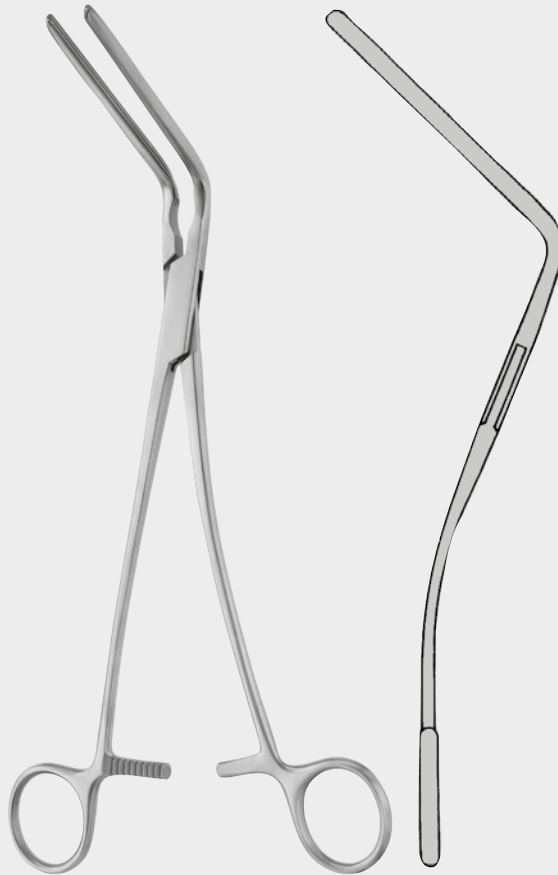

DEBAKEY MORRIS
13-2209-18 - 13-2209-25

CARDIOVASCULAR
INSTRUMENTE

CARDIOVASCULAR
INSTRUMENTS

INSTRUMENTS
CARDIOVASCULAIRES

INSTRUMENTOS
CARDIOVASCULARES

STRUMENTI
CARDIOVASCOLARI

ZEPF[®]
α
INSTRUMENTS

13-2209-18

ATRAUMA



DEBAKEY



13-2301-27

27 cm



DEBAKEY

13-2301-18 - 13-2301-27

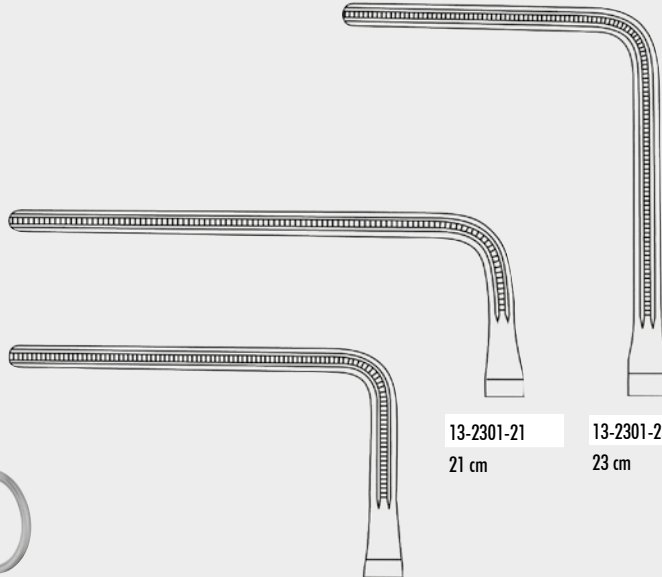

13-2301-21

21 cm

13-2301-23

23 cm

13-2301-18

18 cm



Atraumatische Mehrzweckklemmen
Atraumatic Multi-Purpose Clamps
Pinces-clamps polyvalentes
Pinzas clamps para usos varios
Pinze atraumatiche per diversi usi

CARDIOVASCULAR
INSTRUMENTE

CARDIOVASCULAR
INSTRUMENTS

INSTRUMENTS
CARDIOVASCULAIRES

PINZAS VASCULARES
ATRAUMÁTICAS

INSTRUMENTOS
CARDIOVASCULARES

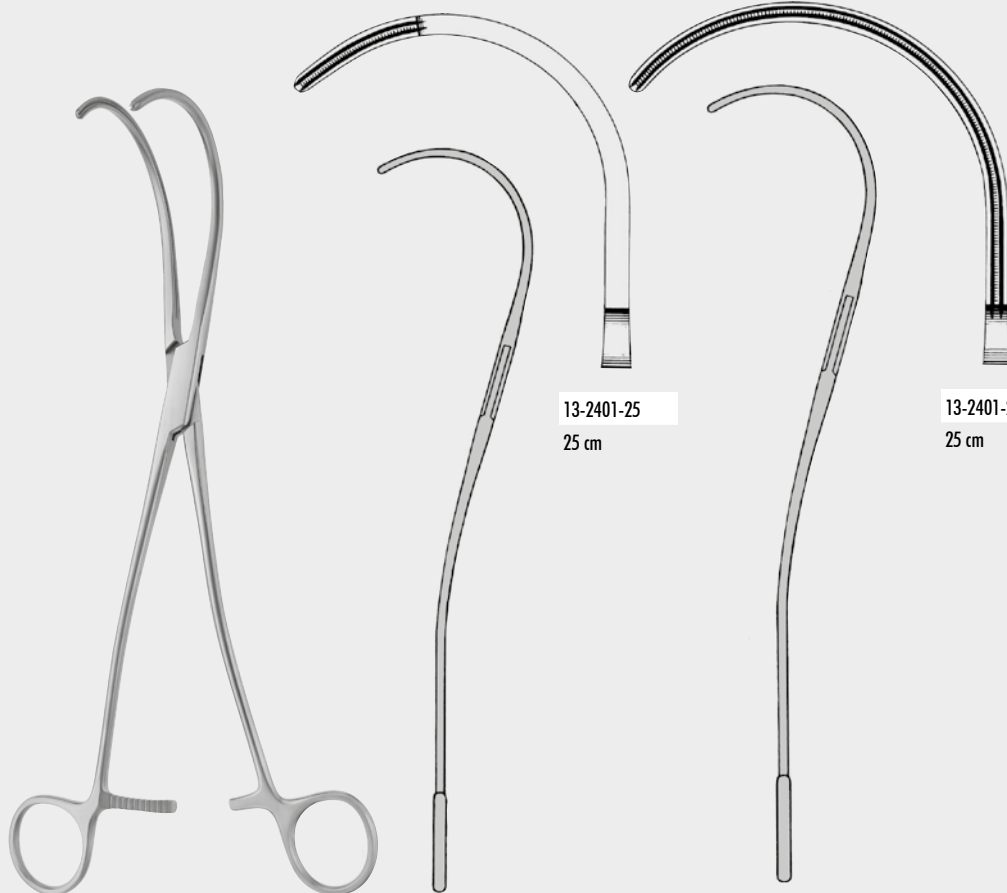

13-2401-25

25 cm

13-2401-26

25 cm

DEBAKEY

13-2401-25 - 13-2401-26

Aorta-Aneurysma-Klemmen
Aorta-Aneurysm Clamps
Pinces-clamps pour aneurysme d'aorte
Pinzas clamps para aneurisma de aorta
Pinze per aneurisma di aorta

ZEPF[®]
INSTRUMENTS

13-2401-26



ATRAUMA



DEBAKEY

Aorta-Aneurysma-Klemmen
Aorta-Aneurysm Clamps
Pinces-clamps pour aneurysme d'aorte
Pinzas clamps para aneurisma de aorta
Pinze per aneurisma di aorta

CARDIOVASCULAR
INSTRUMENTE

CARDIOVASCULAR
INSTRUMENTS

INSTRUMENTS
CARDIOVASCULAIRES

INSTRUMENTOS
CARDIOVASCULARES

STRUMENTI
CARDIOVASCOLARI

Atraumatische Mehrweckklemmen
Atraumatic Multi-Purpose Clamps
Pinces-clamps polyvalentes
Pinzas clamps para usos varios
Pinze atraumatiche per diversi usi



DEBAKEY
13-2407-27
27 cm

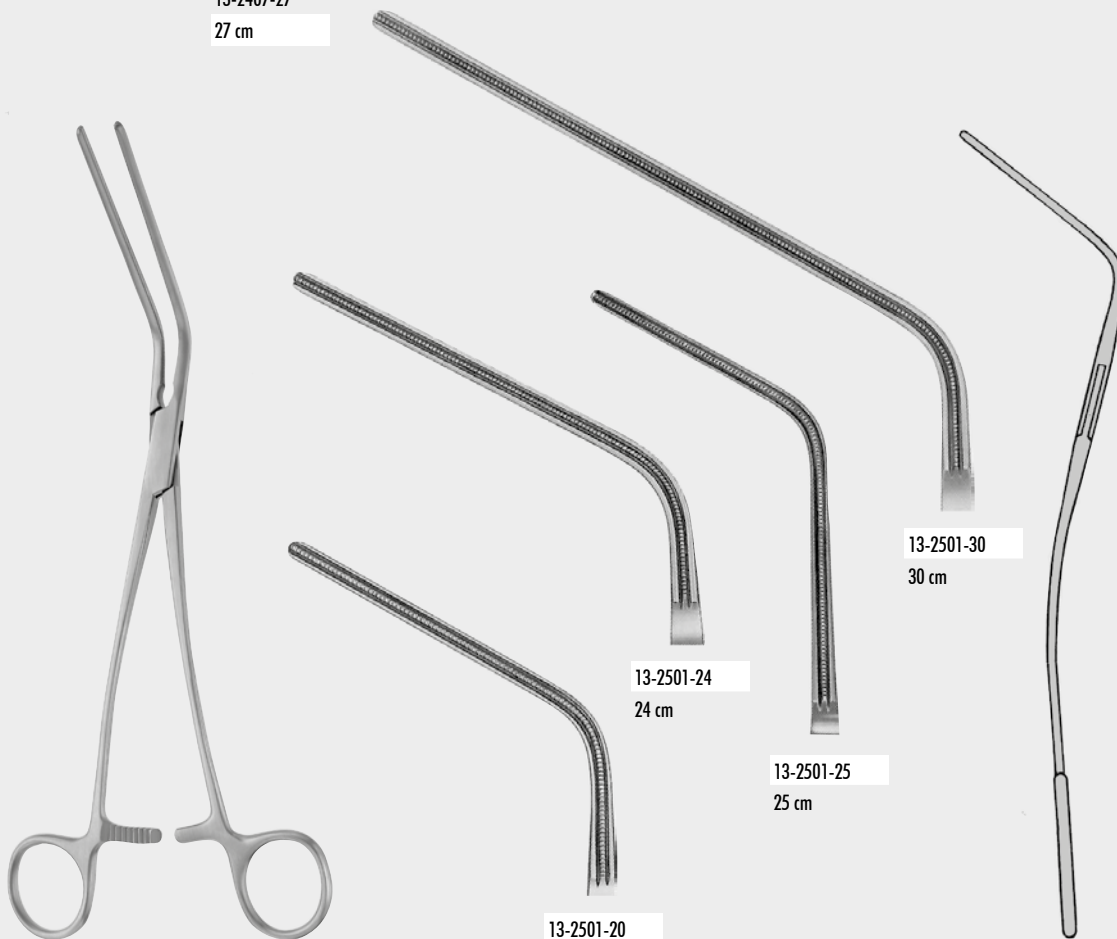

DEBAKEY
13-2501-20 - 13-2501-30

13-2501-24
24 cm

13-2501-30
30 cm

13-2501-25
25 cm

13-2501-20
20 cm



13-2407-27



Tangentialklemmen
Tangential Occlusion Clamps
Pinces-clamps pour occlusion tangentielle
Pinzas para oclusión tangencial
Pinze per occlusione tangenziale

CARDIOVASCULAR
INSTRUMENTE

CARDIOVASCULAR
INSTRUMENTS

INSTRUMENTS
CARDIOVASCULAIRES

PINZAS VASCULARES
ATRAUMÁTICAS

INSTRUMENTOS
CARDIOVASCULARES

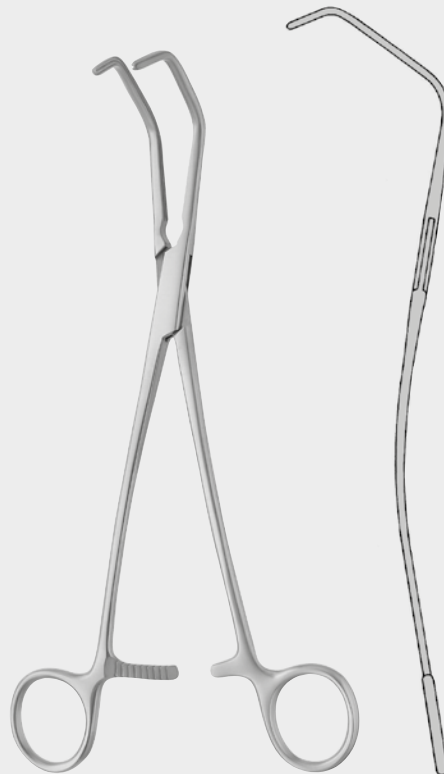
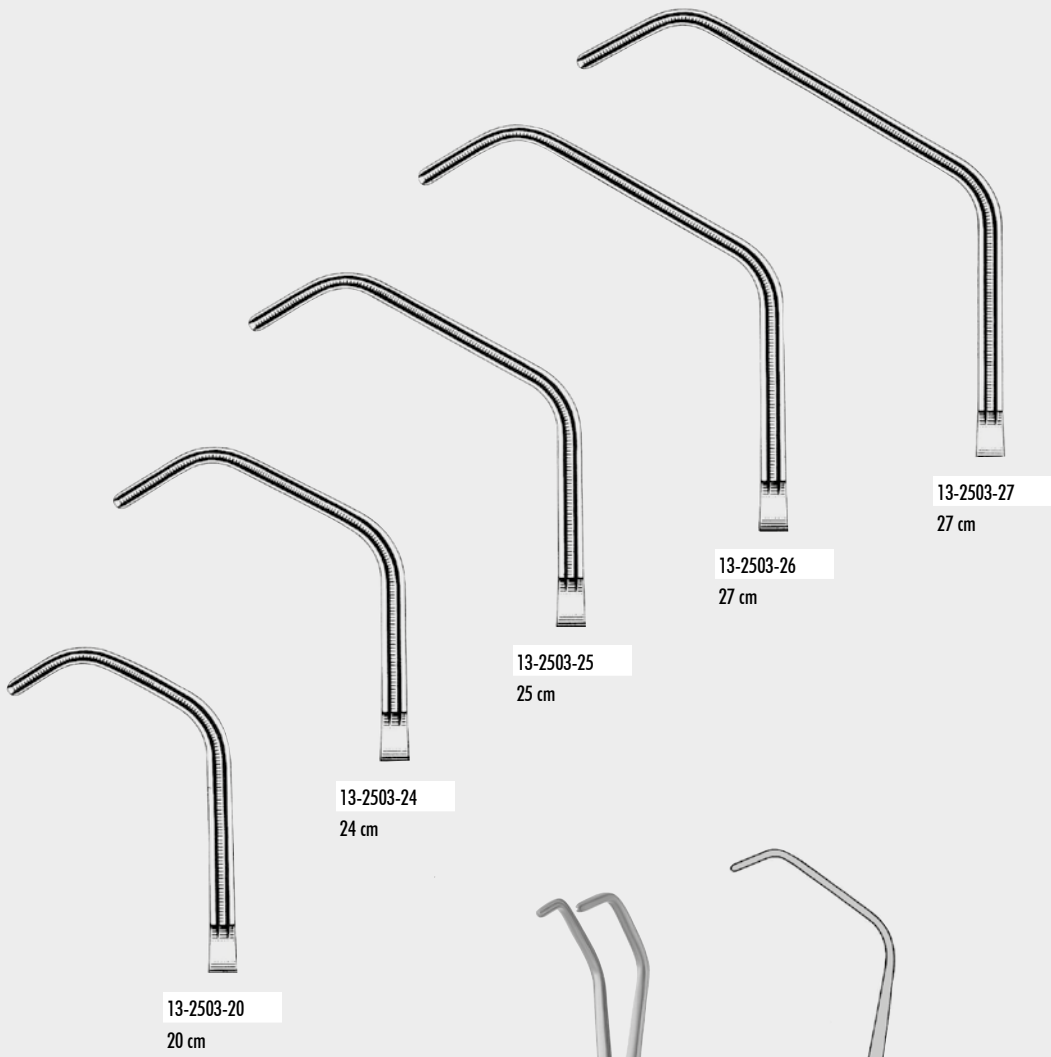

SATINSKY
13-2503-20 - 13-2503-27



ATRAUMA



DEBAKEY

Tangentialklemmen
Tangential Occlusion Clamps
Pinces-clamps pour occlusion tangentielle
Pinzas para oclusión tangencial
Pinze per occlusione tangenziale



WYLIE

13-2509-01 - 13-2509-02

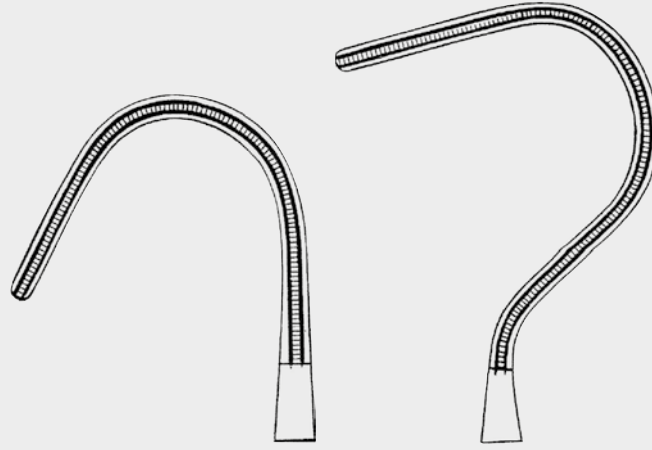

13-2509-01
21 cm

13-2509-02
22 cm

CARDIOVASCULAR
INSTRUMENTE

CARDIOVASCULAR
INSTRUMENTS

INSTRUMENTS
CARDIOVASCULAIRES

INSTRUMENTOS
CARDIOVASCULARES

STRUMENTI
CARDIOVASCOLARI



WYLIE

13-2509-01 - 13-2509-02

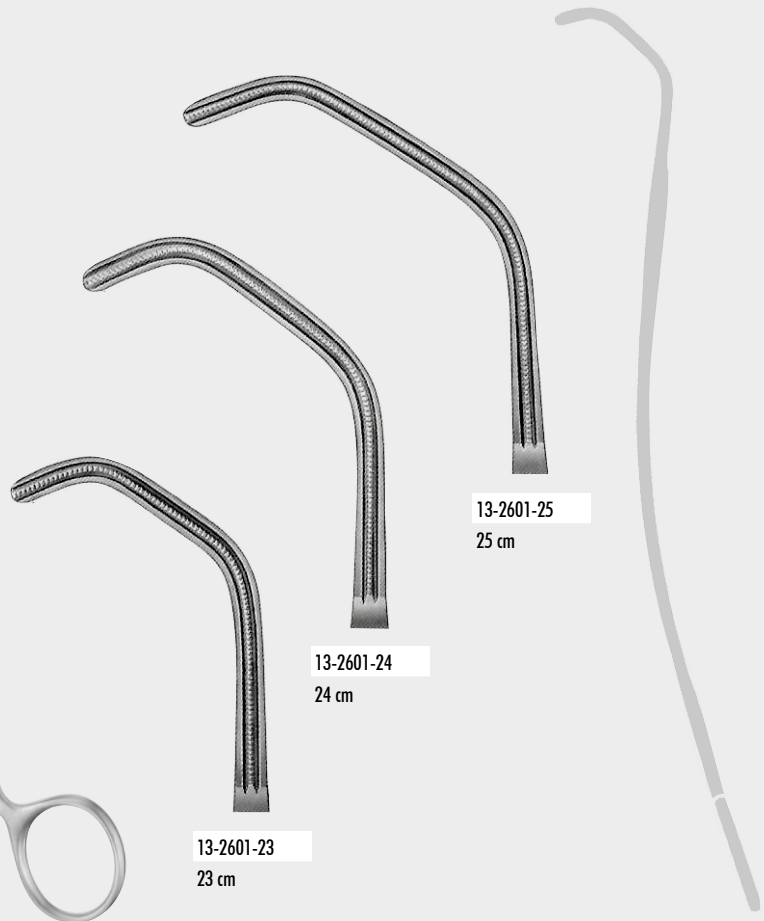

13-2601-23
23 cm

13-2601-24
24 cm

13-2601-25
25 cm

DEBAKEY SATINSKY

13-2601-23 - 13-2601-25

ZEPF®
INSTRUMENTS

13-2509-01

ATRAUMA



DEBAKEY



Aurikelklemmen
Auricle Clamps
Pincès auriculaires
Pinzas para aurícula
Pinze ventricolari



WYLIE
13-2603-25 - 13-2609-24
24 cm



13-2603-25



13-2605-24



13-2607-24

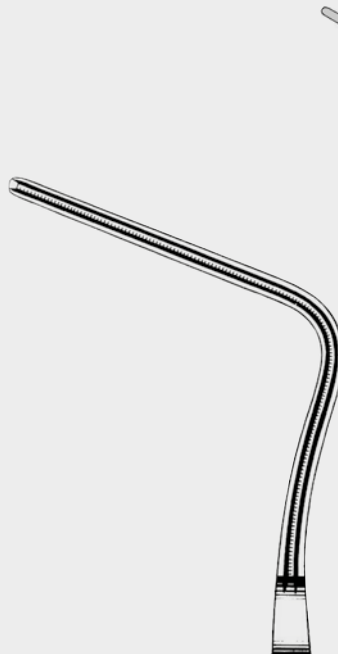

13-2609-24

CARDIOVASCULAR
INSTRUMENTE

CARDIOVASCULAR
INSTRUMENTS

INSTRUMENTS
CARDIOVASCULAIRES

PINZAS VASCULARES
ATRAUMÁTICAS

INSTRUMENTOS
CARDIOVASCULARES

ZEPF[®]
INSTRUMENTS

13-2609-24



ATRAUMA



DEBAKEY

Peripheal-Gefäßklemmen
Peripheal Vascular Clamps
Pinces-clamps, vasculaires périphériques
Pinzas para vasos periféricos
Pinze vascolari periferali

Organfaßzange
Organ grasping forceps
Pinces pour saisir des organes
Pinzas para sacar órganos
Pinze per afferrare organi

CARDIOVASCULAR
INSTRUMENTE

CARDIOVASCULAR
INSTRUMENTS

INSTRUMENTS
CARDIOVASCULAIRES

INSTRUMENTOS
CARDIOVASCULARES

STRUMENTI
CARDIOVASCOLARI

Peripheal-Gefäßklemmen
Peripheal Vascular Clamps
Pinces-clamps, vasculaires périphériques
Pinzas para vasos periféricos
Pinze vascolari periferali

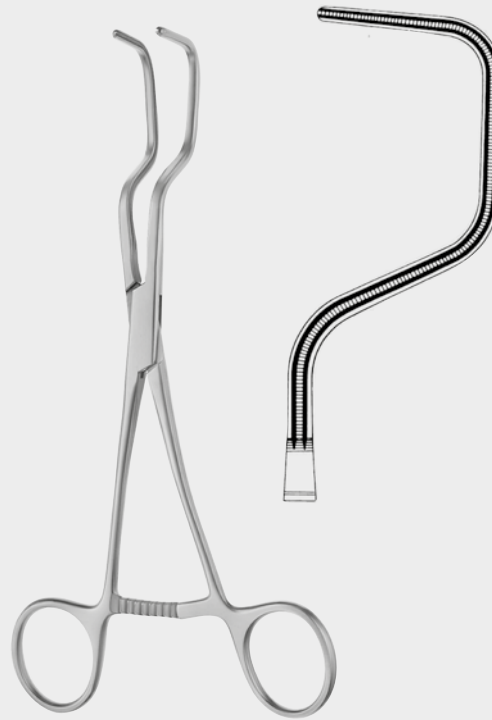

DALE
13-2701-18
18 cm

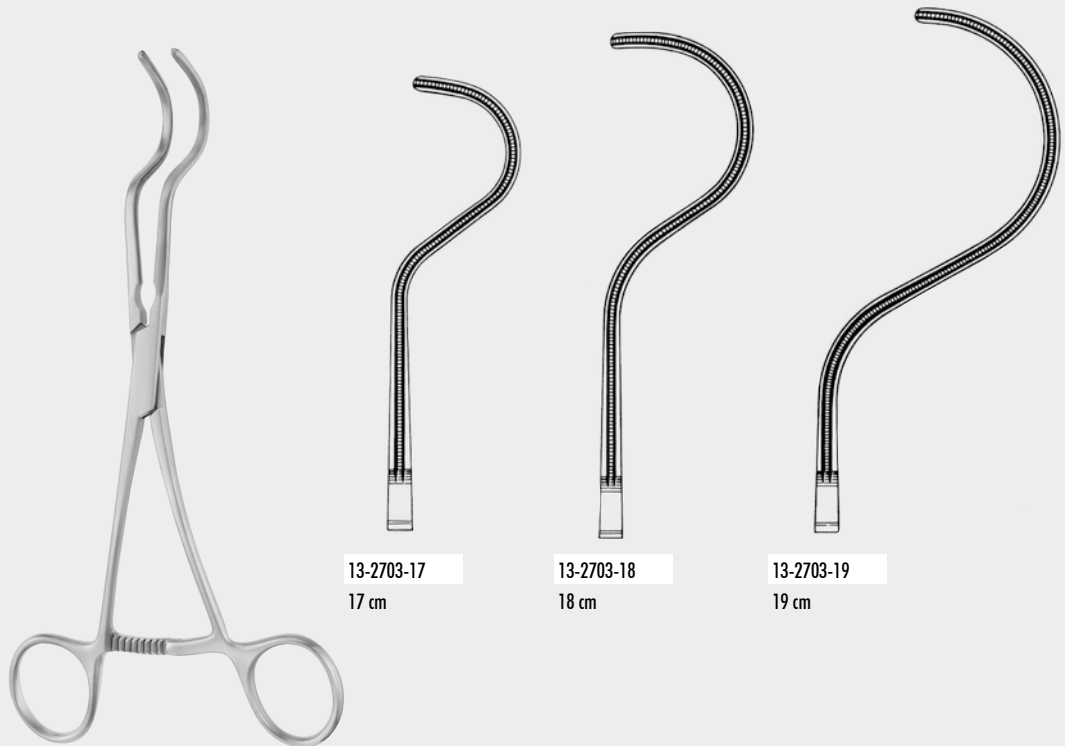

13-2703-17
17 cm

13-2703-18
18 cm

13-2703-19
19 cm

DALE
13-2703-17 - 13-2703-19



13-2701-18

ATRAUMA



DEBAKEY

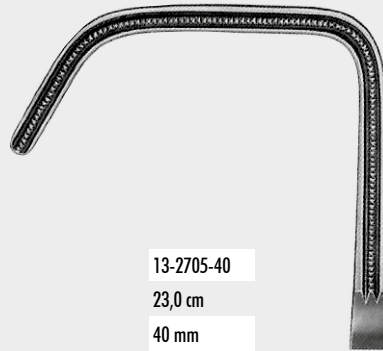

13-2705-40

23,0 cm

40 mm

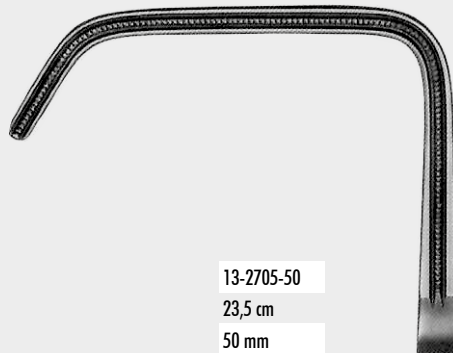

13-2705-50

23,5 cm

50 mm



HOPT

13-2705-40 - 13-2705-60

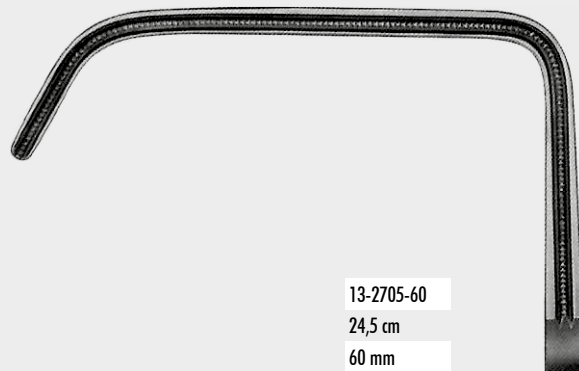

13-2705-60

24,5 cm

60 mm

CARDIOVASCULAR
INSTRUMENTE

CARDIOVASCULAR
INSTRUMENTS

INSTRUMENTS
CARDIOVASCULAIRES

PINZAS VASCULARES
ATRAUMÁTICAS

INSTRUMENTOS
CARDIOVASCULARES

ZEPF[®]
α
INSTRUMENTS

13-2705-60



ATRAUMA



DEBAKEY

Aorta-Anastomosenklemmen
Aorta-Anastomosis Clamps
Pinces-clamps pour anastomoses d'aorte
Pinzas clamps para anastomosis de aorta
Pinze aortiche

Atraumatische Mehrzweckklemmen
Atraumatic Multi-Purpose Clamps
Pinces-clamps polyvalentes
Pinzas clamps para usos varios
Pinze atraumatiche per diversi usi

**CARDIOVASCULAR
INSTRUMENTE**

**CARDIOVASCULAR
INSTRUMENTS**

**INSTRUMENTS
CARDIOVASCULAIRES**

**INSTRUMENTOS
CARDIOVASCULARES**

**STRUMENTI
CARDIOVASCOLARI**

Atraumatische Mehrzweckklemmen
Atraumatic Multi-Purpose Clamps
Pinces-clamps polyvalentes
Pinzas clamps para usos varios
Pinze atraumatiche per diversi usi

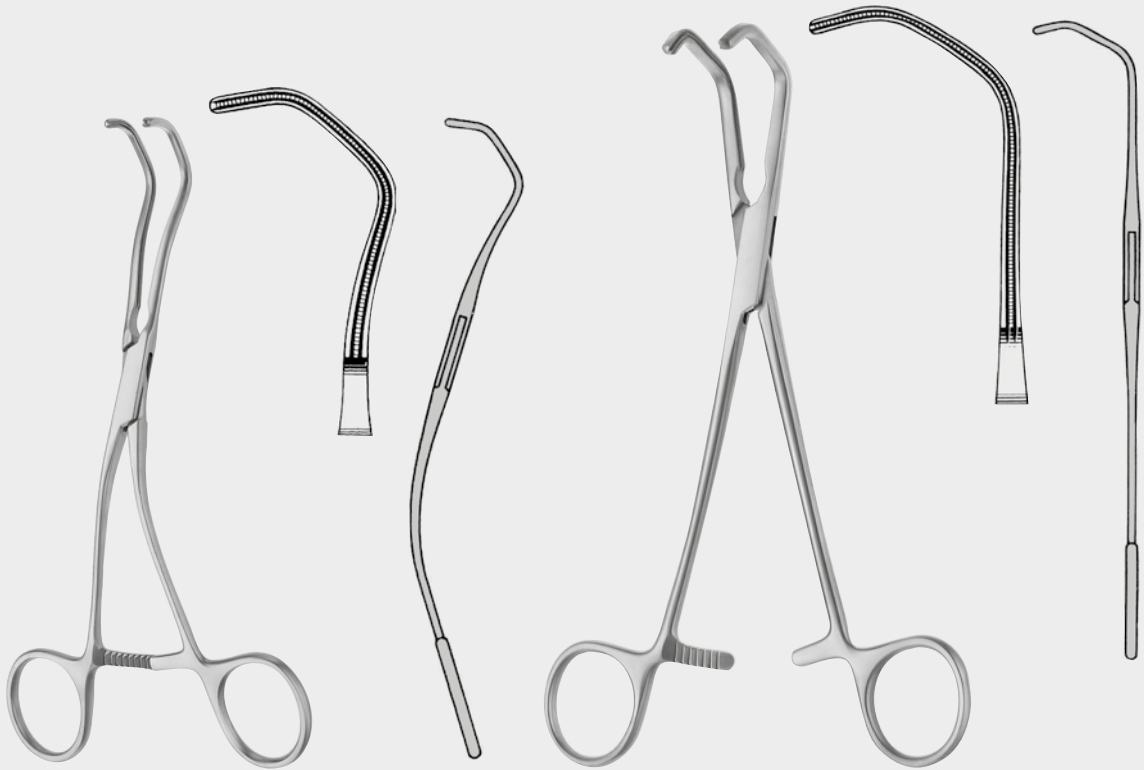

DEBAKEY
13-2709-17
17 cm

BECK
13-2803-17
17 cm

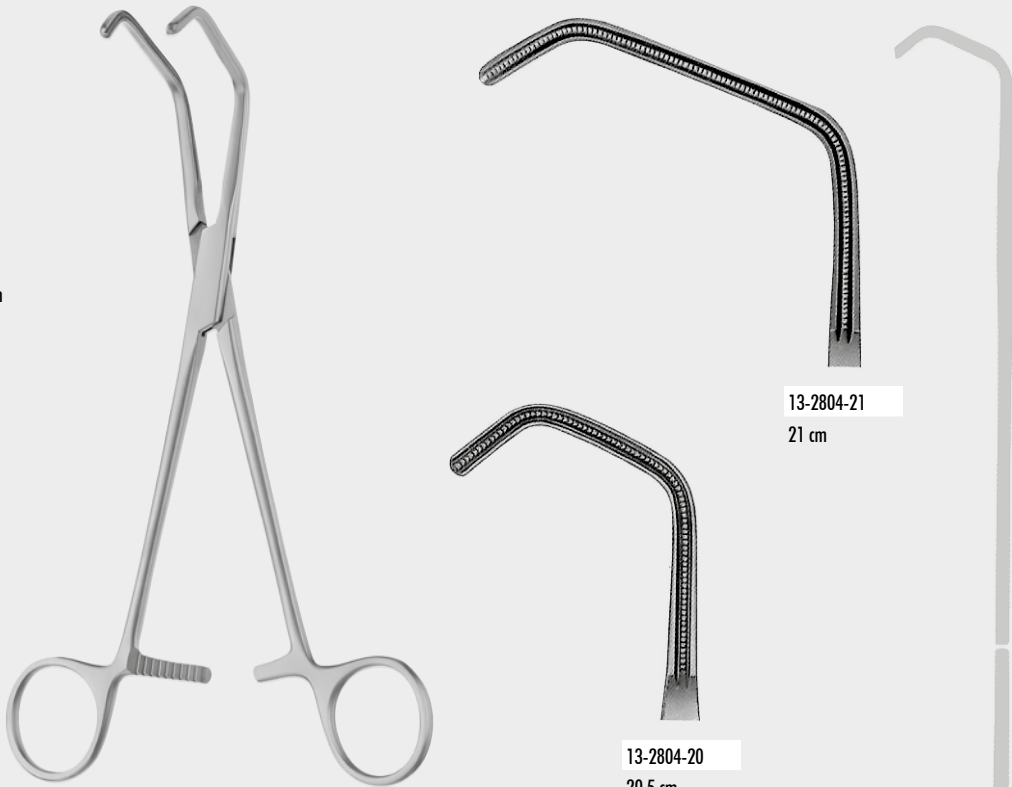

13-2804-21
21 cm

13-2804-20
20,5 cm

DEBAKEY BECK
13-2804-20 - 13-2804-21



13-2709-17

ATRAUMA



DEBAKEY



Präparier- und Ligaturklemmen
Dissecting and Ligature Clamps
Pincès à dissection et passe-fil
Pinzas de disección y para ligaduras
Pinze per dissezione e per legature

CARDIOVASCULAR
INSTRUMENTE

CARDIOVASCULAR
INSTRUMENTS

INSTRUMENTS
CARDIOVASCULAIRES

PINZAS VASCULARES
ATRAUMÁTICAS

INSTRUMENTOS
CARDIOVASCULARES

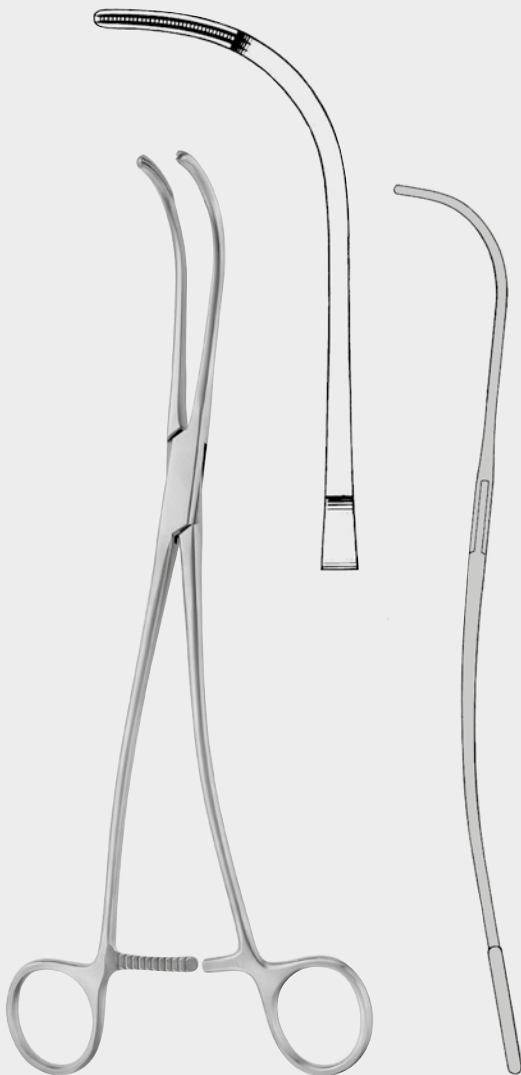

DEBAKEY
13-2805-24
24 cm



DEBAKEY
13-2807-24
24 cm

ZEPF[®]
α
INSTRUMENTS

13-2807-24



ATRAUMA



DEBAKEY

Coarctationsklemmen
Coarctation Clamps
Pinces à coarctacion
Pinzas para coarctación
Pinze per coarctazione

CARDIOVASCULAR
INSTRUMENTE

CARDIOVASCULAR
INSTRUMENTS

INSTRUMENTS
CARDIOVASCULAIRES

INSTRUMENTOS
CARDIOVASCULARES

STRUMENTI
CARDIOVASCOLARI



POTTS
13-2808-21 - 13-2808-31



13-2808-21
21 cm



13-2808-23
23 cm



13-2808-27
27 cm



13-2808-31
31 cm



POTTS
13-2809-21 - 13-2809-31



13-2809-21
21 cm

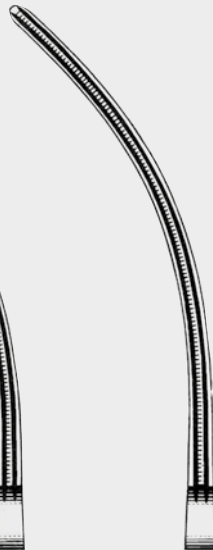

13-2809-23
23 cm



13-2809-27
27 cm



13-2809-31
31 cm

ZEPF®
INSTRUMENTS

13-2808-21

ATRAUMA



DEBAKEY



DERRA

13-2901-16 - 13-2901-18

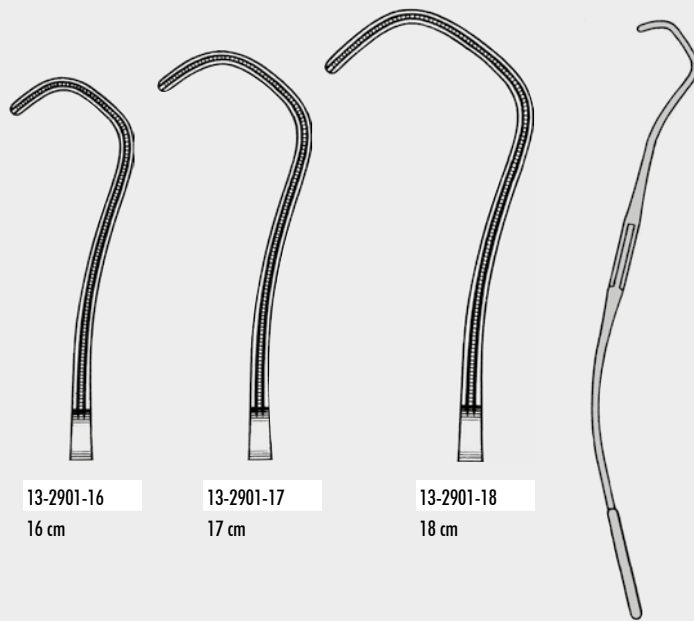

13-2901-16
16 cm

13-2901-17
17 cm

13-2901-18
18 cm

Anastomosenklemmen, Kindergrößen
Anastomosis Clamps, Pediatric
Pinces à anastomose, pédiatriques
Pinzas para anastomosis, pediátricas
Pinze per anastomosi, pediatriche

CARDIOVASCULAR
INSTRUMENTE

CARDIOVASCULAR
INSTRUMENTS

INSTRUMENTS
CARDIOVASCULAIRES

PINZAS VASCULARES
ATRAUMÁTICAS

INSTRUMENTOS
CARDIOVASCULARES

Coarctationsklemmen
Coarctation Clamps
Pinces à coarctation
Pinzas para coarctación
Pinze per coarctazione

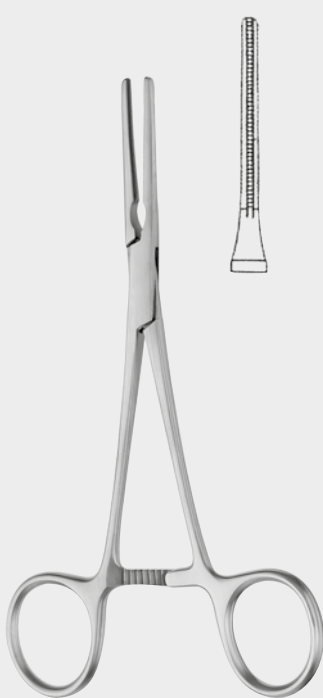

DEBAKEY
13-3002-16
16 cm

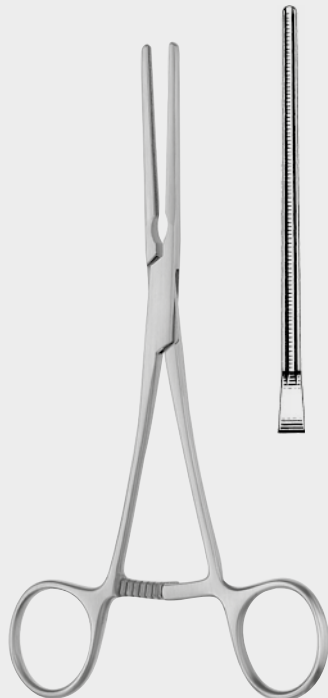

DEBAKEY
13-3002-17
17 cm

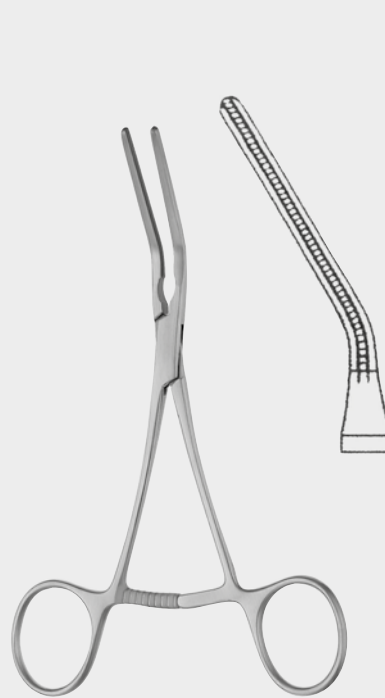

DEBAKEY
13-3003-15
15,5 cm

ZEPF®
INSTRUMENTS

13-3003-15



ATRAUMA



DEBAKEY

Anastomosenklemmen
Anastomosis Clamps
Pinces à anastomose
Pinzas para anastomosis
Pinze per anastomosi

Coarctationsklemmen
Coarctation Clamps
Pinces à coarctacion
Pinzas para coarctación
Pinze per coarctazione

CARDIOVASCULAR
INSTRUMENTE

CARDIOVASCULAR
INSTRUMENTS

INSTRUMENTS
CARDIOVASCULAIRES

INSTRUMENTOS
CARDIOVASCULARES

STRUMENTI
CARDIOVASCOLARI



DEBAKEY
13-3005-15
15,5 cm



DEBAKEY
13-3007-17
17 cm



13-3009-16
16 cm

13-3009-17
17 cm

DEBAKEY
13-3009-16 - 13-3009-17

ATRAUMA



DEBAKEY



Coarctationsklemmen
Coarctation Clamps
Pinces à coarctation
Pinzas para coarctación
Pinze per coarctazione

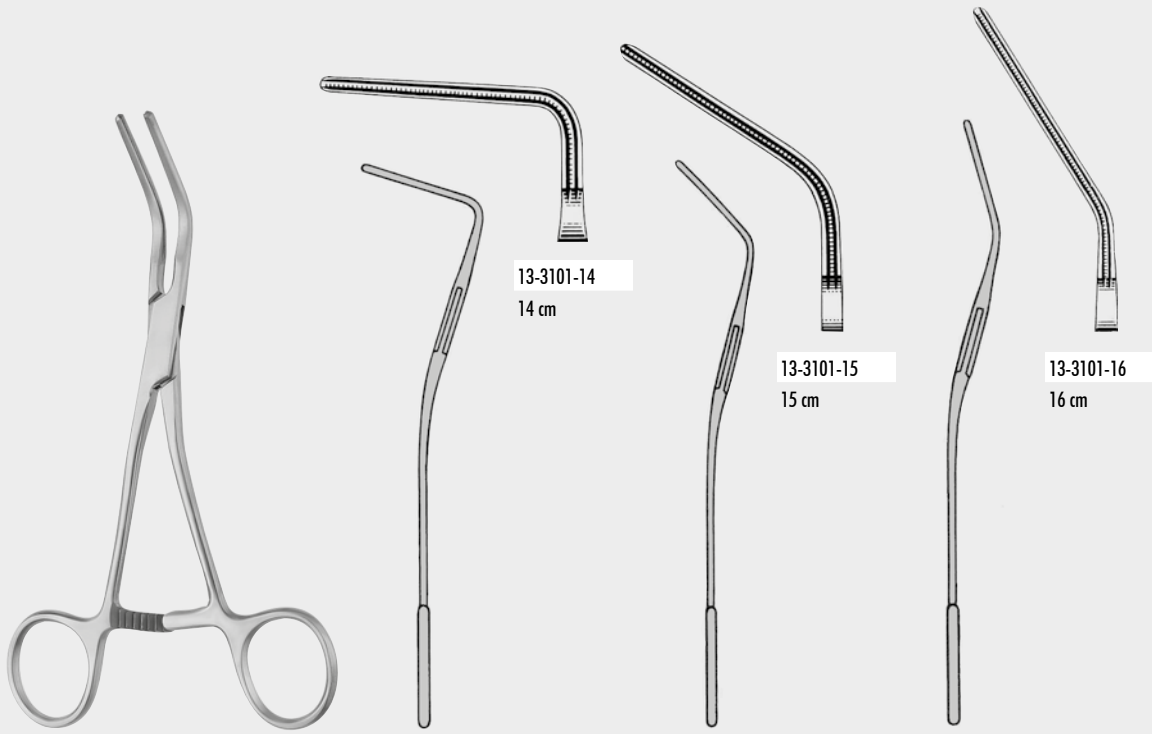

13-3101-14
14 cm

13-3101-15
15 cm

13-3101-16
16 cm

DEBAKEY
13-3101-14 - 13-3101-16

CARDIOVASCULAR
INSTRUMENTE

CARDIOVASCULAR
INSTRUMENTS

INSTRUMENTS
CARDIOVASCULAIRES

PINZAS VASCULARES
ATRAUMÁTICAS

INSTRUMENTOS
CARDIOVASCULARES

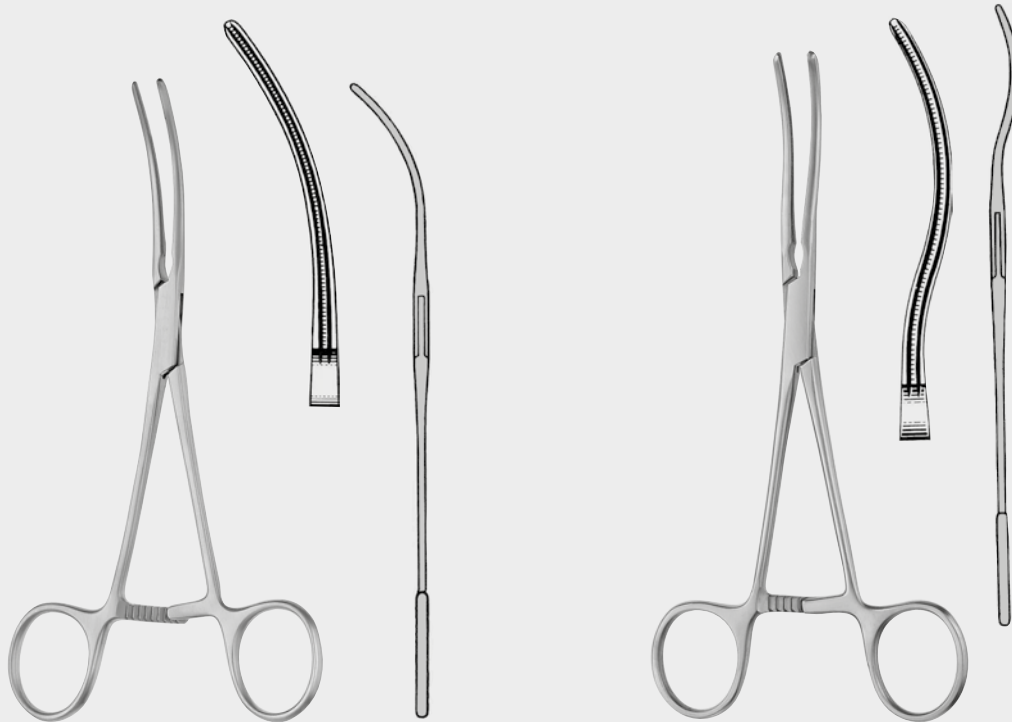

GLOVER
13-3201-17
17 cm

GLOVER
13-3203-17
17 cm



13-3203-17



ATRAUMA



DEBAKEY

Anastomosenklemmen
Anastomosis Clamps
Pinces à anastomose
Pinzas para anastomosis
Pinze per anastomosi



13-3209-01
18 cm

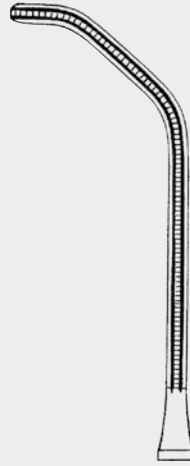

13-3209-02
18 cm

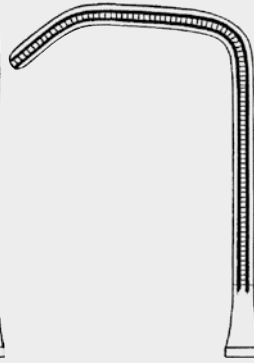

13-3209-03
16,5 cm

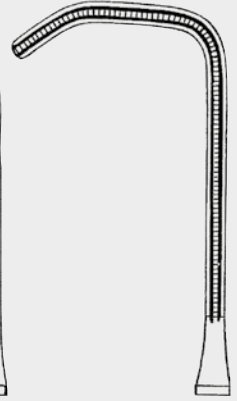

13-3209-04
16,5 cm

CARDIOVASCULAR INSTRUMENTE

DEBAKEY REYNOLDS
13-3209-01 - 13-3209-04

CARDIOVASCULAR INSTRUMENTS

INSTRUMENTS CARDIOVASCULAIRES

INSTRUMENTOS CARDIOVASCULARES

STRUMENTI CARDIOVASCOLARI

Aortaklemmen
Aortic Clamp
Pince-clamp à aorte
Pinza clamp para aorta
Pinza per aorta

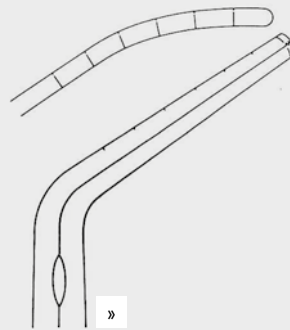

13-3303-16
16 cm

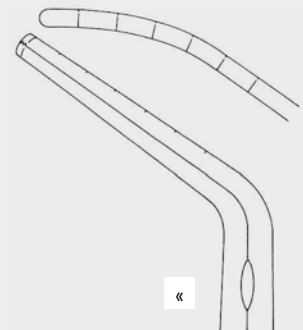

13-3305-16
16 cm



SUBRAMANIAN MINIATURE
13-3301-15
15 cm



SUBRAMANIAN
13-3303-16 - 13-3305-16



13-3209-01



Aortaklemmen
Aortic Clamp
Pince-clamp à aorte
Pinza clamp para aorta
Pinza per aorta



OCHSNER
13-3307-23 - 13-3307-26



13-3307-23
23 cm



13-3307-26
26 cm



DIETRICH
13-3309-21
21 cm

CARDIOVASCULAR
INSTRUMENTE

CARDIOVASCULAR
INSTRUMENTS

INSTRUMENTS
CARDIOVASCULAIRES

PINZAS VASCULARES
ATRAUMÁTICAS

INSTRUMENTOS
CARDIOVASCULARES



ATRAUMA



DEBAKEY

Ligaturklemmen
Ligature Clamps
Pinces à passe-fil
Pinzas para ligaduras
Pinze per legature

Anastomosenklemmen
Anastomosis Clamps
Pinces à anastomose
Pinzas para anastomosis
Pinze per anastomosi

Ligaturklemmen
Ligature Clamps
Pinces à passe-fil
Pinzas para ligaduras
Pinze per legature

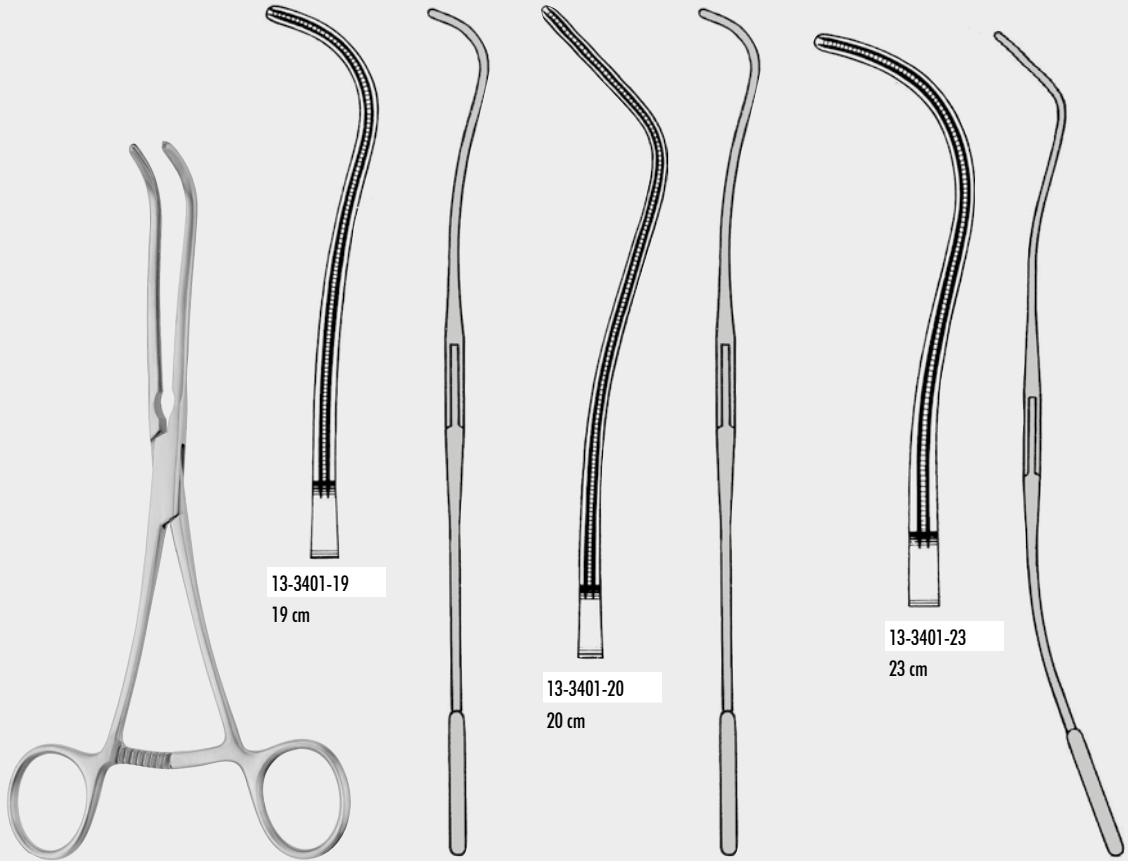

DEBAKEY
13-3401-19 - 13-3401-23

CARDIOVASCULAR
INSTRUMENTE

CARDIOVASCULAR
INSTRUMENTS

INSTRUMENTS
CARDIOVASCULAIRES

INSTRUMENTOS
CARDIOVASCULARES

STRUMENTI
CARDIOVASCOLARI

Carotis-Shuntklemmen
Carotid Shunt Clamps
Pinces pour carotide
Pinzas para shunt carótido
Pinze carotis

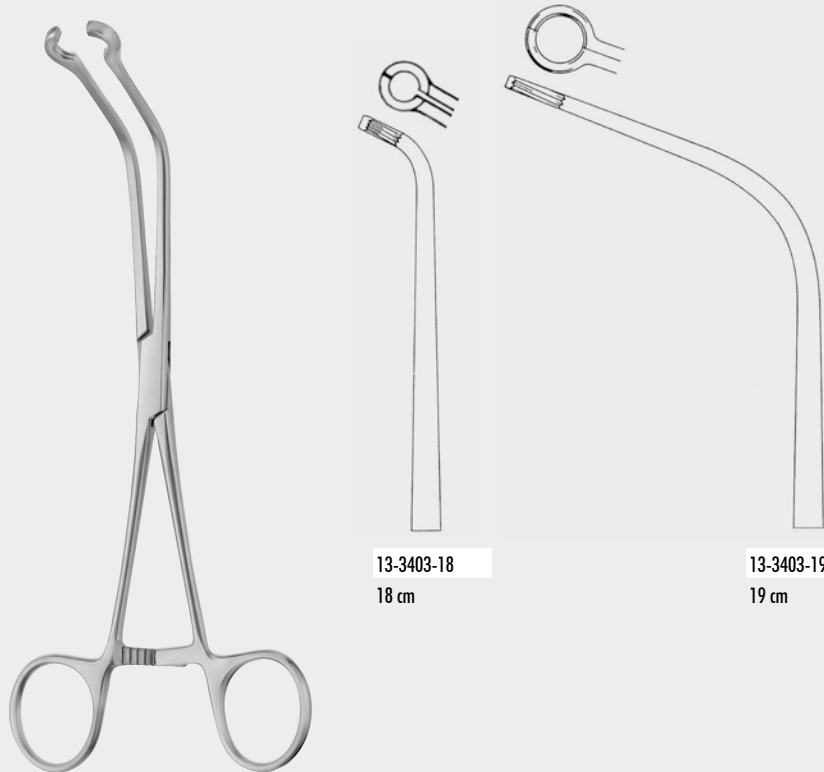

JAVID
13-3403-18 - 13-3403-19

ZEPF®
α
INSTRUMENTS

13-3401-19

Profunda-Klemmen
 Profunda Clamps
 Pinces-clamps pour profunda
 Pinzas clamps para profunda
 Pinze per profunda



GREGORY
 13-3409-14 - 13-3409-18

13-3409-14
 14 cm

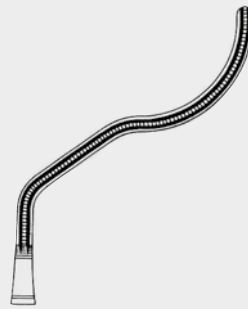

13-3409-16
 16 cm

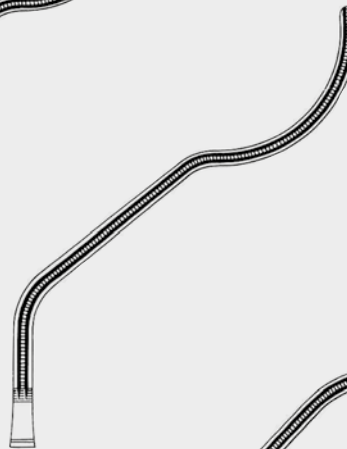

13-3409-18
 18 cm

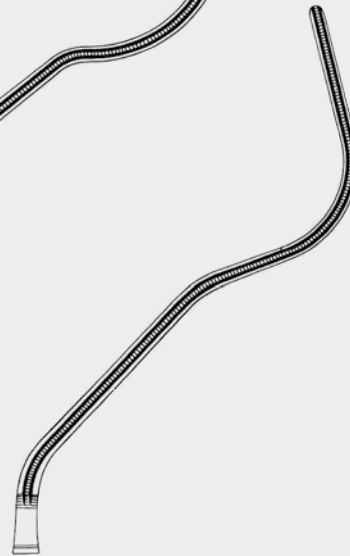

CARDIOVASCULAR
 INSTRUMENTE

CARDIOVASCULAR
 INSTRUMENTS

INSTRUMENTS
 CARDIOVASCULAIRES

PINZAS VASCULARES
 ATRAUMÁTICAS

INSTRUMENTOS
 CARDIOVASCULARES

Bulldogklemmen mit Ringgriff
 Ring Bulldog clamps
 Clamps Bulldog
 Clamps Bulldog
 Pinze Bulldog

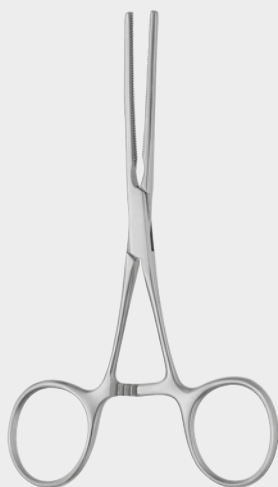

COOLEY
 13-3500-13 - 13-3501-13

13-3500-13
 12,5 cm



13-3501-13
 12,5 cm

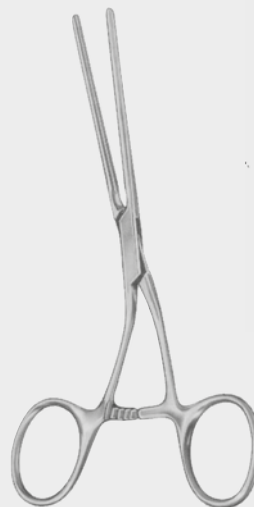
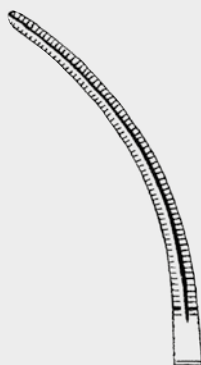

COOLEY
 13-3503-13
 13,5 cm



15°



ATRAUMA



COOLEY

Bulldogklemmen mit Ringgriff
Ring Bulldog clamps
Clamps Bulldog
Clamps Bulldog
Pinze Bulldog

CARDIOVASCULAR
INSTRUMENTE

CARDIOVASCULAR
INSTRUMENTS

INSTRUMENTS
CARDIOVASCULAIRES

INSTRUMENTOS
CARDIOVASCULARES

STRUMENTI
CARDIOVASCOLARI

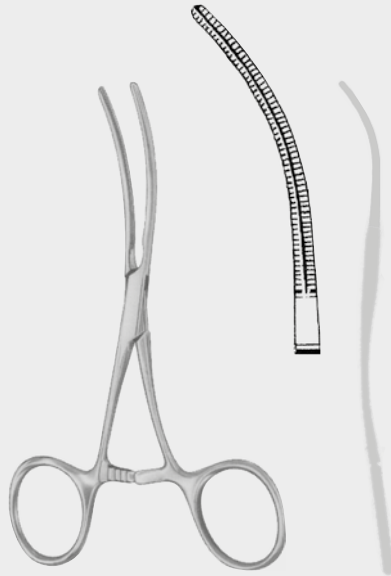

COOLEY
13-3505-13
13,0 cm



COOLEY
13-3507-12
12,5 cm



COOLEY
13-3509-10
10,5 cm

COOLEY
13-3601-12
12,5 cm

COOLEY
13-3603-13
13,5 cm



Katheterklemmen
Catheter clamps
Pinces pour sondes
Pinzas para catéteres
Pinze per cateteri



13-3701-24
16 cm
24 Charr.



13-3701-26
16 cm
26 Charr.



13-3703-28
20 cm
28 Charr.



13-3703-30
20 cm
30 Charr.



13-3703-32
20 cm
32 Charr.



13-3703-36
20 cm
36 Charr.



COOLEY

13-3701-24 - 13-3703-36

CARDIOVASCULAR
INSTRUMENTE

CARDIOVASCULAR
INSTRUMENTS

INSTRUMENTS
CARDIOVASCULAIRES

PINZAS VASCULARES
ATRAUMÁTICAS

INSTRUMENTOS
CARDIOVASCULARES



ATRAUMA



COOLEY

Coarctationsklemmen
Coarctation Clamps
Pinces à coarctacion
Pinzas para coarctación
Pinze per coarctazione

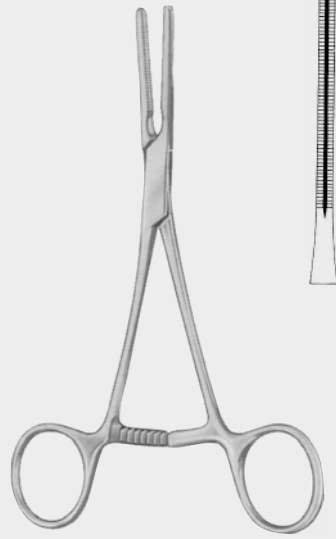

COOLEY
13-3706-14
14 cm

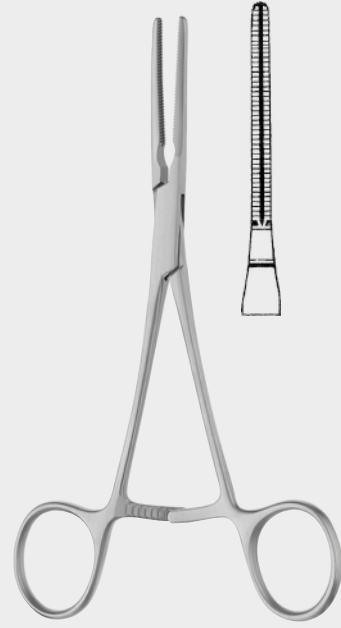

COOLEY
13-3706-16
16 cm

CARDIOVASCULAR
INSTRUMENTE

CARDIOVASCULAR
INSTRUMENTS

INSTRUMENTS
CARDIOVASCULAIRES

INSTRUMENTOS
CARDIOVASCULARES

STRUMENTI
CARDIOVASCOLARI

Neonatal- und Kinderklemmen, extra feine Modelle
Neonatal and Childrens Clamps, extra delicate patterns
Pinces-clamps pour des nouveaux-nés et des enfants, modèles très fins
Pinzas clamps para recién nacidos y niños, modelos muy finos
Pinze pediatriche, modelli molto fini



COOLEY
13-3707-16
16 cm



COOLEY
13-3709-14
14 cm



COOLEY
13-3800-14
14 cm

ZEPF®
INSTRUMENTS

13-3706-14

ATRAUMA



COOLEY

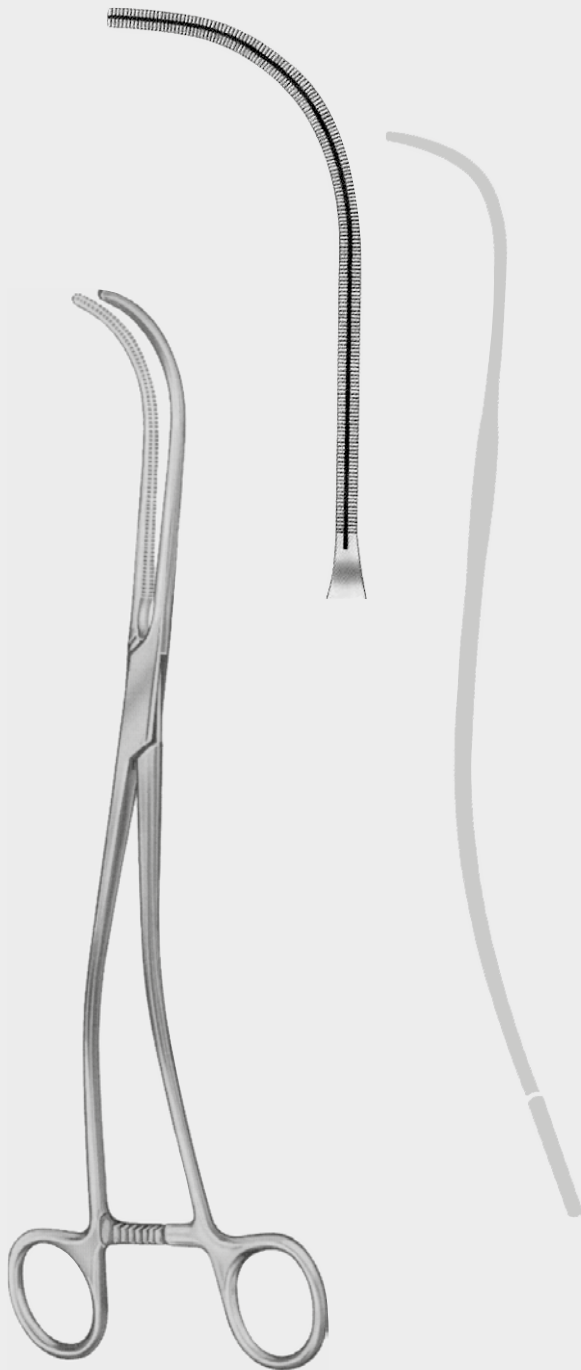

COOLEY
13-4005-27
27 cm

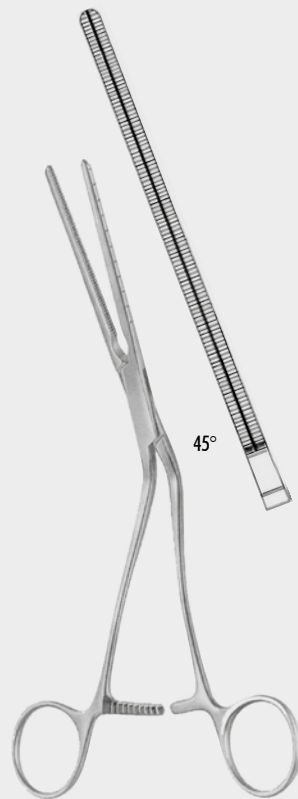

COOLEY
22,5 cm 13-4007-22
27,0 cm 13-4007-27

Atraumatische Mehrzweckklemmen
Atraumatic Multi-Purpose Clamps
Pinces-clamps polyvalentes
Pinzas clamps para usos varios
Pinze atraumatiche per diversi usi

CARDIOVASCULAR
INSTRUMENTE

CARDIOVASCULAR
INSTRUMENTS

INSTRUMENTS
CARDIOVASCULAIRES

PINZAS VASCULARES
ATRAUMÁTICAS

INSTRUMENTOS
CARDIOVASCULARES

Iliaca-Klemmen
Iliac Clamps
Pinces-clamps à iliaque
Pinzas clamps para iliaca
Pinze per iliaca

ZEPF[®]
α
INSTRUMENTS

13-4007-27



ATRAUMA



COOLEY

Coarctationsklemmen
Coarction Clamps
Pinces à coarctacion
Pinzas para coarctación
Pinze per coarctazione



13-4100-17
17 cm



13-4101-17
17 cm

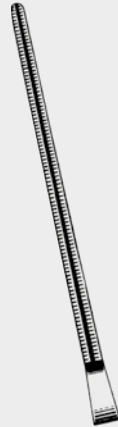

13-4107-17
17 cm



13-4109-17
17 cm



CARDIOVASCULAR
INSTRUMENTE

CARDIOVASCULAR
INSTRUMENTS

INSTRUMENTS
CARDIOVASCULAIRES

INSTRUMENTOS
CARDIOVASCULARES

STRUMENTI
CARDIOVASCOLARI

Anastomosenklemmen
Anastomosis Clamps
Pinces à anastomose
Pinzas para anastomosis
Pinze per anastomosi

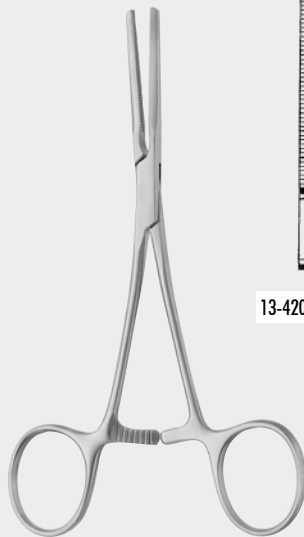

13-4200-14



13-4201-14

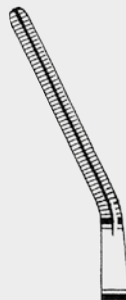

COOLEY
13-4200-14 - 13-4201-14
14 cm



COOLEY
13-4203-14
14 cm

ZEPF®
INSTRUMENTS

13-4100-17



Neonatal- und Kinderklemmen
 Neonatal and Children Clamps
 Pinces-clamps pour des nouveaux-nés et des enfants
 Pinzas clamps para recién nacidos y niños
 Pinze pediatriche

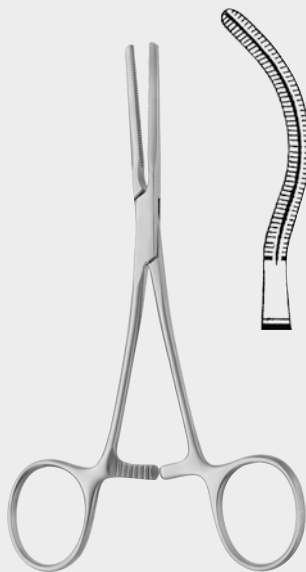

COOLEY
 13-4205-14
 14 cm



90°
 13-4301-90
 15 cm



CARDIOVASCULAR
 INSTRUMENTE

CARDIOVASCULAR
 INSTRUMENTS

INSTRUMENTS
 CARDIOVASCULAIRES

PINZAS VASCULARES
 ATRAUMÁTICAS

INSTRUMENTOS
 CARDIOVASCULARES

Atraumatische Mehrzweckklemmen
 Atraumatic Multi-Purpose Clamps
 Pinces-clamps polyvalentes
 Pinzas clamps para usos varios
 Pinze atraumatiche per diversi usi

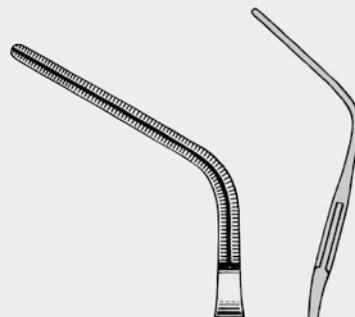

45°
 13-4301-45
 15,5 cm

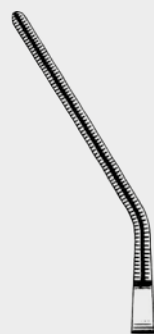

25°
 13-4301-25
 17 cm

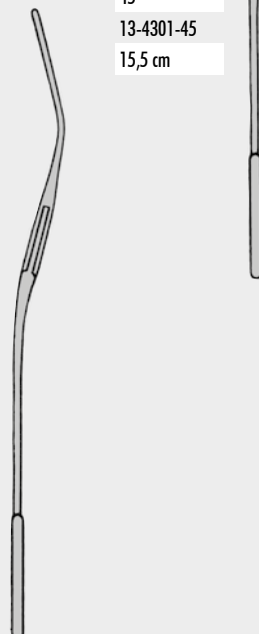

COOLEY
 13-4301-25 - 13-4301-90



ATRAUMA



COOLEY

CARDIOVASCULAR
INSTRUMENTE

CARDIOVASCULAR
INSTRUMENTS

INSTRUMENTS
CARDIOVASCULAIRES

INSTRUMENTOS
CARDIOVASCULARES

STRUMENTI
CARDIOVASCOLARI

Neonatal- und Kinderklemmen
Neonatal and Children Clamps
Pinces-clamps pour des nouveau-nés et des enfants
Pinzas clamps para recién nacidos y niños
Pinze pediatriche

Anastomosenklemmen
Anastomosis Clamps
Pinces à anastomose
Pinzas para anastomosis
Pinze per anastomosi

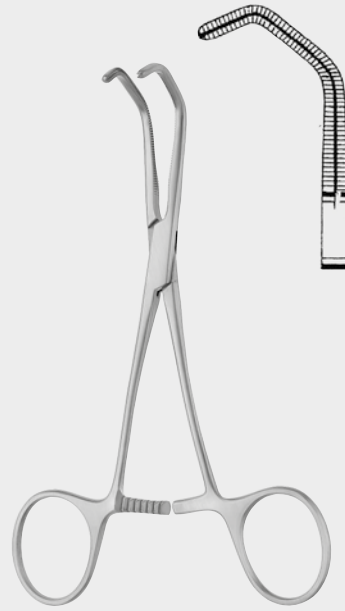

COOLEY
13-4303-14
14 cm



13-4401-16
16 cm

13-4401-17
17 cm

13-4401-18
18 cm

COOLEY DERRA

ZEPF®
INSTRUMENTS

13-4303-14



COOLEY
13-4407-17 - 13-4409-17

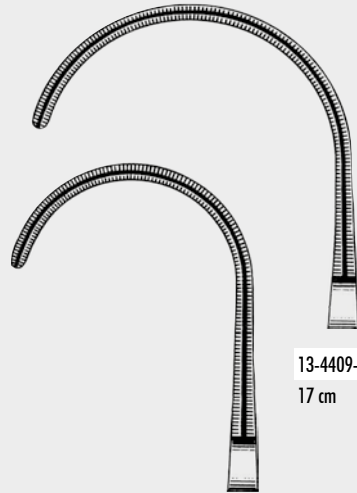

13-4409-17
17 cm

13-4407-17
16 cm



Anastomosenklemmen
Anastomosis Clamps
Pinces à anastomose
Pinzas para anastomosis
Pinze per anastomosi

CARDIOVASCULAR
INSTRUMENTE

CARDIOVASCULAR
INSTRUMENTS

INSTRUMENTS
CARDIOVASCULAIRES

PINZAS VASCULARES
ATRAUMÁTICAS

INSTRUMENTOS
CARDIOVASCULARES



COOLEY
13-4500-16 - 13-4505-17

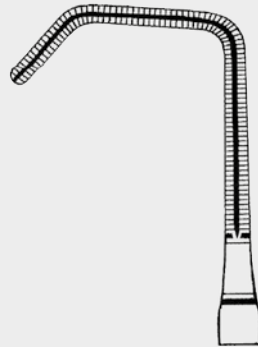

13-4500-16
16,5 cm

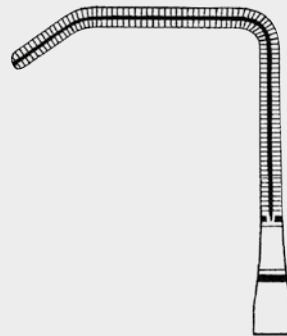

13-4501-16
16,5 cm

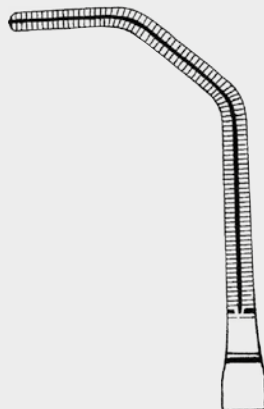

13-4503-16
17,5 cm

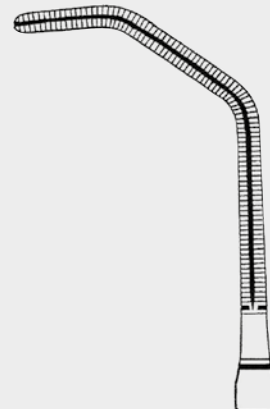

13-4505-17
17,5 cm



ATRAUMA



COOLEY

Atraumatische Mehrzweckklappen
Atraumatic Multi-Purpose Clamps
Pinces-clamps polyvalentes
Pinzas clamps para usos varios
Pinze atraumatiche per diversi usi

CARDIOVASCULAR
INSTRUMENTE

CARDIOVASCULAR
INSTRUMENTS

INSTRUMENTS
CARDIOVASCULAIRES

INSTRUMENTOS
CARDIOVASCULARES

STRUMENTI
CARDIOVASCOLARI

Carotis-Shuntklappen
Carotid Shunt Clamps
Pinces pour carotide
Pinzas para shunt carótido
Pinze carotis

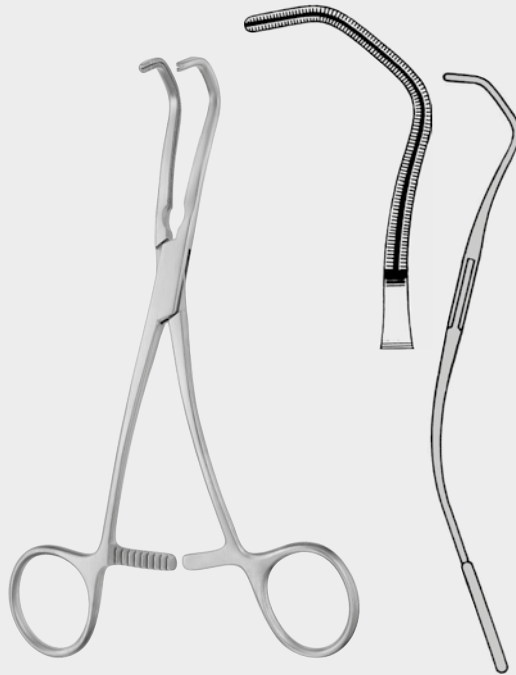

13-4507-17
17 cm

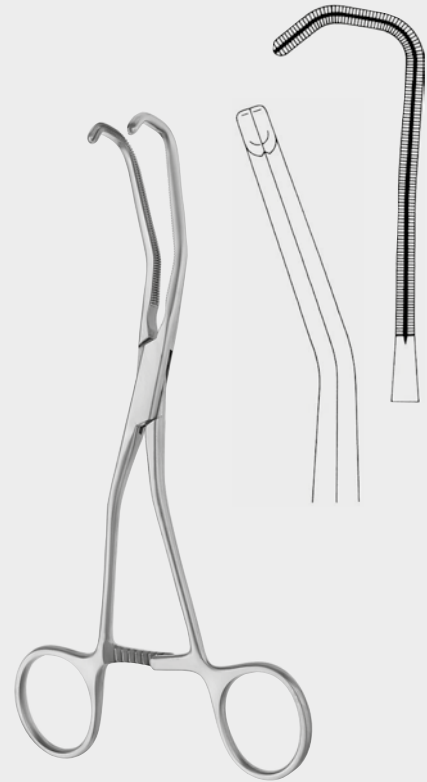

COOLEY
13-4601-17
17 cm



COOLEY
13-4605-18 - 13-4605-19

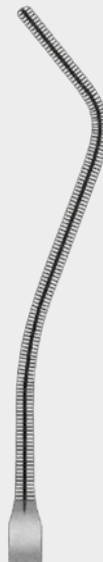

13-4605-18
18,5 cm



13-4605-19
19,5 cm



Carotis-Shuntklemmen
Carotid Shunt Clamps
Pinces pour carotide
Pinzas para shunt carótido
Pinze carotis

Atraumatische Mehrzweckklemmen
Atraumatic Multi-Purpose Clamps
Pinces-clamps polyvalentes
Pinzas clamps para usos varios
Pinze atraumatiche per diversi usi

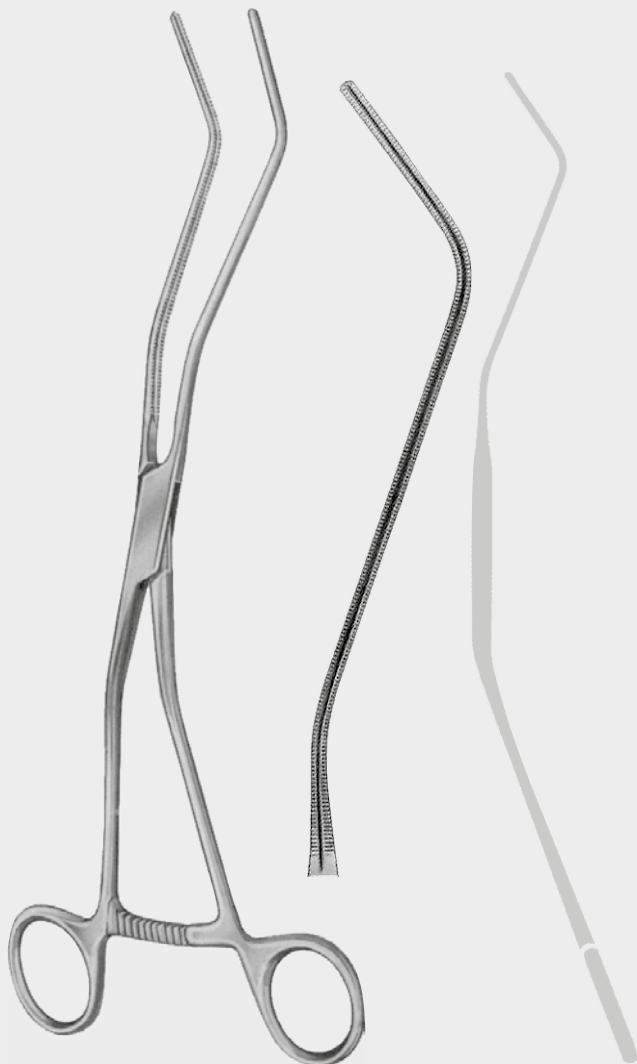

COOLEY
13-4605-26
26 cm



COOLEY
13-4607-27
27,5 cm

CARDIOVASCULAR
INSTRUMENTE

CARDIOVASCULAR
INSTRUMENTS

INSTRUMENTS
CARDIOVASCULAIRES

PINZAS VASCULARES
ATRAUMÁTICAS

INSTRUMENTOS
CARDIOVASCULARES



ATRAUMA



COOLEY

Atraumatische Gefäßklemmen
Atraumatic Vascular Clamps
Pinces vasculaires atraumatiques
Pinzas vasculares atraumáticas
Pinze vascolari atraumatiche

CARDIOVASCULAR
INSTRUMENTE

CARDIOVASCULAR
INSTRUMENTS

INSTRUMENTS
CARDIOVASCULAIRES

INSTRUMENTOS
CARDIOVASCULARES

STRUMENTI
CARDIOVASCOLARI

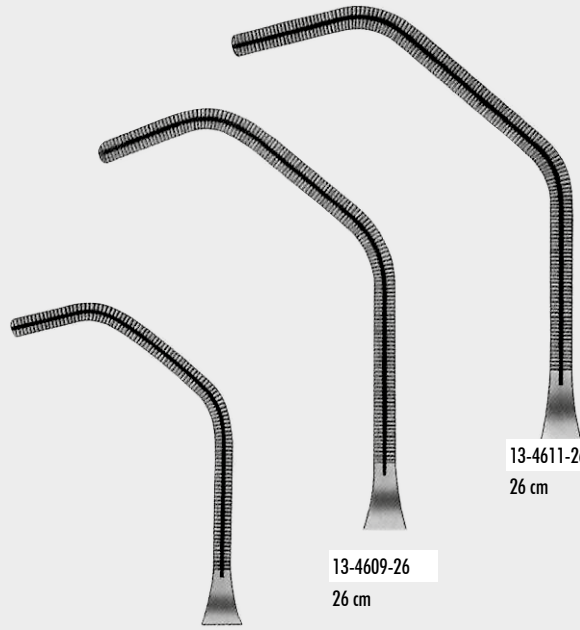

13-4611-26
26 cm

13-4609-26
26 cm

13-4609-20
20,5 cm



COOLEY
13-4609-20 - 13-4613-27

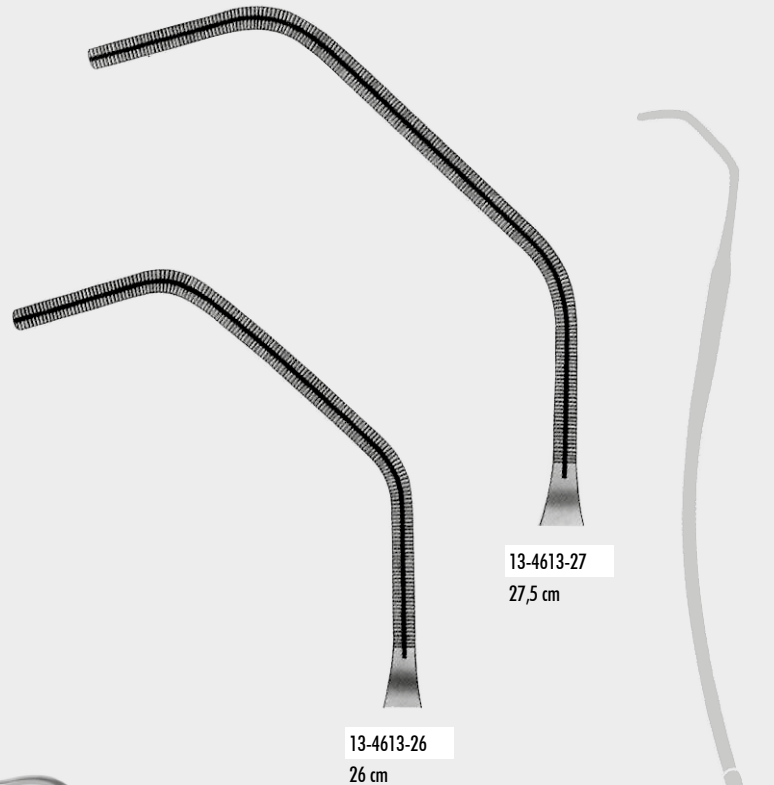

13-4613-27
27,5 cm

13-4613-26
26 cm

ZEPF®
INSTRUMENTS

13-4609-20



Neonatal- und Kinderklemmen, extra feine Modelle
 Neonatal and Children Clamps, extra delicate patterns
 Pinces-clamps pour des nouveaux-nés et des enfants, modèles très fins
 Pinzas clamps para recién nacidos y niños, modelos muy finos
 Pinze pediatriche, modelli molto fini

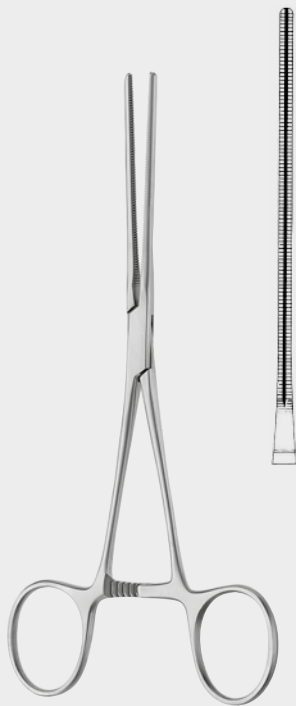

COOLEY
 13-4620-16
 16,5 cm



13-4621-16
 16 cm

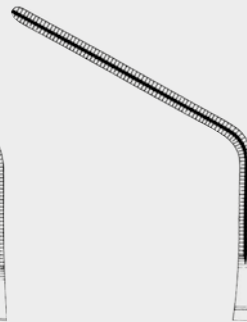

13-4623-16
 15,5 cm



COOLEY
 13-4621-16 - 13-4627-16

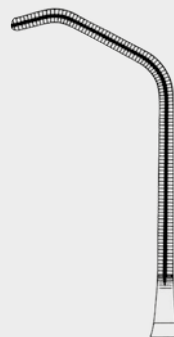

13-4625-16
 15,5 cm



13-4627-16
 16 cm

CARDIOVASCULAR
 INSTRUMENTE

CARDIOVASCULAR
 INSTRUMENTS

INSTRUMENTS
 CARDIOVASCULAIRES

PINZAS VASCULARES
 ATRAUMÁTICAS

INSTRUMENTOS
 CARDIOVASCULARES



ATRAUMA



CASTAÑEDA

Neonatal- und Kinderklemmen, extra feine Modelle
 Neonatal and Children Clamps, extra delicate patterns
 Pincés-clamps pour des nouveaux-nés et des enfants, modèles très fins
 Pinzas clamps para recién nacidos y niños, modelos muy finos
 Pinze pediatriche, modelli molto fini



CASTAÑEDA

13-4800-13 - 13-4907-12

CARDIOVASCULAR INSTRUMENTE

CARDIOVASCULAR INSTRUMENTS

INSTRUMENTS CARDIOVASCULAIRES

INSTRUMENTOS CARDIOVASCULARES

STRUMENTI CARDIOVASCOLARI



13-4800-13
13 cm

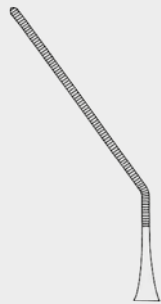

13-4803-13
12,5 cm

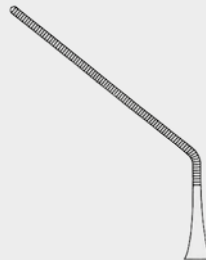

13-4805-13
11,5 cm

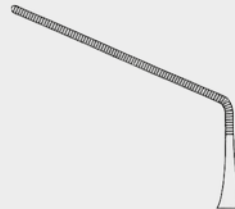

13-4807-13
11,5 cm



13-4809-13
11,5 cm

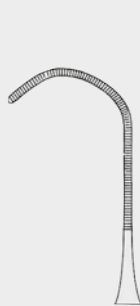

13-4901-11
11,5 cm

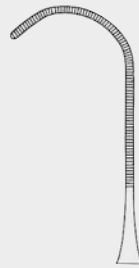

13-4903-12
12 cm

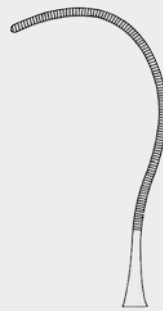

13-4905-12
12 cm



13-4907-12
12 cm



CASTAÑEDA 12 cm
13-4909-30 - 13-4909-45



30°
13-4909-30



45°
13-4909-45



13-4911-15
15 mm



13-4911-18
18 mm



CASTAÑEDA 15,5 cm
13-4911-15 - 13-4911-50



13-4911-23
23 mm



13-4911-50
50 mm

Neonatal- und Kinderklammen, extra feine Modelle
Neonatal and Children Clamps, extra delicate patterns
Pinces-clamps pour des nouveaux-nés et des enfants, modèles très fins
Pinzas clamps para recién nacidos y niños, modelos muy finos
Pinze pediatriche, modelli molto fini

**CARDIOVASCULAR
INSTRUMENTE**

**CARDIOVASCULAR
INSTRUMENTS**

**INSTRUMENTS
CARDIOVASCULAIRES**

**PINZAS VASCULARES
ATRAUMÁTICAS**

**INSTRUMENTOS
CARDIOVASCULARES**

Neonatal- und Kinderklammen, extra feine Modelle
Neonatal and Children Clamps, extra delicate patterns
Pinces-clamps pour des nouveaux-nés et des enfants, modèles très fins
Pinzas clamps para recién nacidos y niños, modelos muy finos
Pinze pediatriche, modelli molto fini



ATRAUMA



COOLEY

Neonatal- und Kinderklemmen, extra feine Modelle
 Neonatal and Children Clamps, extra delicate patterns
 Pincés-clamps pour des nouveaux-nés et des enfants, modèles très fins
 Pinzas clamps para recién nacidos y niños, modelos muy finos
 Pinze pediatriche, modelli molto fini

CARDIOVASCULAR INSTRUMENTE

CARDIOVASCULAR INSTRUMENTS

INSTRUMENTS CARDIOVASCULAIRES

INSTRUMENTOS CARDIOVASCULARES

STRUMENTI CARDIOVASCOLARI

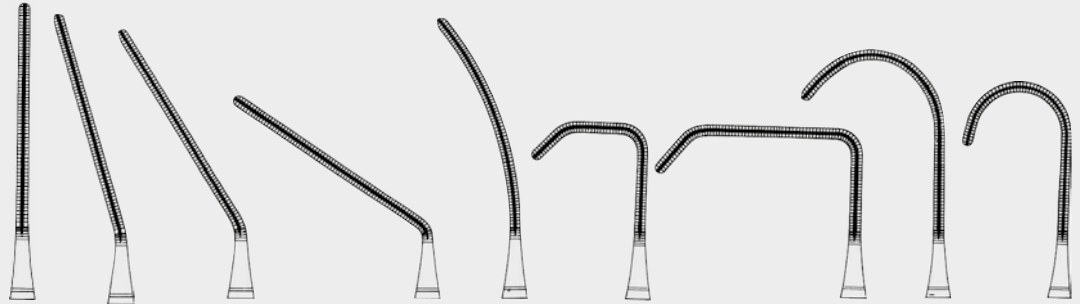

	Fig. 1	Fig. 2	Fig. 3	Fig. 4	Fig. 5	Fig. 6	Fig. 7	Fig. 8	Fig. 9
A	13-5002-01	13-5002-02	13-5002-03	13-5002-04	13-5002-05	13-5002-06	13-5002-07	13-5002-08	13-5002-09
B	13-5003-01	13-5003-02	13-5003-03	13-5003-04	13-5003-05	13-5003-06	13-5003-07	13-5003-08	13-5003-09
C	13-5005-01	13-5005-02	13-5005-03	13-5005-04	13-5005-05	13-5005-06	13-5005-07	13-5005-08	13-5005-09
	14 cm	14 cm	14 cm	13 cm	14 cm	13,5 cm	14 cm	13,5 cm	13 cm



COOLEY
13-5002-01 - 13-5005-09



A



B



C



Präparier- und Ligaturklemmen
Dissecting and Ligature Clamps
Pinces à dissection et passe-fil
Pinzas de disección y para ligaduras
Pinze per dissezione e per legature

CARDIOVASCULAR
INSTRUMENTE

CARDIOVASCULAR
INSTRUMENTS

INSTRUMENTS
CARDIOVASCULAIRES

PINZAS VASCULARES
ATRAUMÁTICAS

INSTRUMENTOS
CARDIOVASCULARES



DEBAKEY RUMEL
13-5201-01 - 13-5201-02



13-5201-01
25 cm



13-5201-02
25 cm



DEBAKEY McQUIGG MIXER
13-5205-21
21 cm



ATRAUMA



DEBAKEY

Präparier- und Ligaturklemmen
Dissecting and Ligature Clamps
Pinces à dissection et passe-fil
Pinzas de disección y para ligaduras
Pinze per dissezione e per legature

CARDIOVASCULAR
INSTRUMENTE

CARDIOVASCULAR
INSTRUMENTS

INSTRUMENTS
CARDIOVASCULAIRES

INSTRUMENTOS
CARDIOVASCULARES

STRUMENTI
CARDIOVASCOLARI



DEBAKEY MIXTER

13-5207-28

28,5 cm

ZEPF®
α
INSTRUMENTS

13-5207-28



**CARDIOVASCULAR
INSTRUMENTE**

**CARDIOVASCULAR
INSTRUMENTS**

**INSTRUMENTS
CARDIOVASCULAIRES**

**PINZAS VASCULARES
ATRAUMÁTICAS**

**INSTRUMENTOS
CARDIOVASCULARES**

ZEPF[®]
α
INSTRUMENTS

02-3200-19



CARDIOVASCULAR
INSTRUMENTE

CARDIOVASCULAR
INSTRUMENTS

INSTRUMENTS
CARDIOVASCULAIRES

INSTRUMENTOS
CARDIOVASCULARES

STRUMENTI
CARDIOVASCOLARI



**CARDIOVASCULAR
INSTRUMENTE**

**CARDIOVASCULAR
INSTRUMENTS**

**INSTRUMENTS
CARDIOVASCULAIRES**

**PINZAS VASCULARES
ATRAUMÁTICAS**

**INSTRUMENTOS
CARDIOVASCULARES**

CARDIOVASCULAR
INSTRUMENTE

CARDIOVASCULAR
INSTRUMENTS

INSTRUMENTS
CARDIOVASCULAIRES

INSTRUMENTOS
CARDIOVASCULARES

STRUMENTI
CARDIOVASCOLARI

ZEPF[®]
α
INSTRUMENTS
TUTTLINGEN
GERMANY

ZEPF MEDICAL INSTRUMENTS GMBH
GUNNINGERSTR. 21 · D-78606 SEITINGEN-OBERFLACHT
P.O.B. 4805 · D-78513 TUTTLINGEN
FON: +49 (0) 7464 / 985060
FAX: +49 (0) 7464 / 9850666
E-MAIL: info@zepf-medical-instruments.de
www.zepf-medical-instruments.de