

Microsyringes for multiple
applications in your laboratory



H
N
E
T
N
O
C

SELECTION GUIDE	09
Syringe Designs	10
Needle Tip Style	12
Plunger Seal	13
Instrument Compatibility	14
MICROSYRINGES	17
Automatic Liquid Handling	18
Dosage of Liquids	55
Dosage of Gas & Liquids	66
HPLC Syringes	76
On-Column Syringes	80
Dosage in Autosampler	82
NEEDLES	115
ACCESSORIES	121
Fitting	122
Washers	135
Syringe Guide	133
Flange Tool	133
Syringe Rack	134
VALVES	137

Stronger as One



- Industry leading solutions provider
- Larger global distribution network
- Increased product portfolio
- Support of existing and new customers



Gardner Denver Medical with its brands Thomas, Welch, Tricontinent, Zinsser and ILS is a leader in flow control products such as vacuum and liquid pumps, liquid handling robots and compressors for medical, life sciences and selected other industries – focused on solutions for OEMs. A global production network throughout the United States, Europe and Asia allows fast and flexible reaction to our customer needs.

www.gardnerdenvermedical.com

The logo for ILS Innovative Labor Systeme, consisting of the letters "ILS" in a large, bold, green, sans-serif font.

ILS Innovative Labor Systeme is a leading manufacturer of glass syringes and a global supplier to the world's leading laboratory equipment manufacturers, laboratories and laboratory consumables distributors. Today we manufacture more than 1000 types and variations of microsyringes. Our syringes range from 0,5 µL to 100 mL for precision sampling and dosage in chromatography, spectroscopy, preparation of standard solutions, manual application and for use in autosamplers, diluters, dispensers and other liquid handling instruments.

www.microsyringes.com



THOMAS has over 50 years' experience as a pioneering manufacturer of systems, compressors, vacuum, liquid and OEM pumps in the medical, laboratory, environmental and industrial sector. With a wide range of pressure, vacuum and liquid technologies THOMAS offers the broadest oil-free product range in the industry. With this vast product offering, we design ideal, customized solutions which meet our customers' precise needs.

www.gd-thomas.com



WELCH is a manufacturer of an innovative range of vacuum pumps, modular systems and network solutions for use in laboratory and industry. WELCH also manufactures standard and custom flanged components, chambers and valves to provide the best vacuum environment for all processes. The range of service maintenance and training provided is extensive and, with subsidiary companies, agents and service partners in more than 40 countries, our reach is worldwide.

www.welchvacuum.com



TriContinent Scientific is a leading manufacturer of precision OEM syringe pumps and liquid handling robots. We are a preferred supplier to the world's leading medical and biotechnology diagnostic and analytics equipment manufacturers. We are wellknown for continuous innovative pumps which offer an unique combination of low flow and low pulsation.

www.tricontinent.com



Zinsser Analytic is a leading company in customized automation. With more than 45 years of experience we have unique capabilities in developing automated fluid and powder handling systems for the biochemical, pharmaceutical and diagnostic research markets. Zinsser Analytic's consumables product portfolio includes scintillation cocktails and high quality polyethylene vials.

www.zinsser-analytic.com



ILS

ILS Innovative Labor System was founded in 1992 and is a leading manufacturer of glass syringes and a global supplier to the world's leading laboratory equipment manufacturers, laboratories and laboratory consumables distributors. Today we manufacture more than 1000 types and variations of microsyringes. Our syringes range from 0,5 μ L to 100 mL for precision sampling and dosage in chromatography, spectroscopy, preparation of standard solutions, manual applications and for use in autosamplers, diluters, dispensers and other liquid handling instruments.

Precision diluter valves are also available as a recent addition to the production range. ILS shrinks its own precision bore tubing from 3.3 borosilicate glass, highly resistant material. Also, all metal parts and PTFE-seals are made in-house. State-of-the-art computer-controlled equipment such as milling machines, lathes and glass shrinking machines and years of glass working experience guarantee the best quality in products.



ILS is located in Stuetzerbach, a small village in the Thuringian Forest in central Germany. Even though small in size, Stuetzerbach has made a name for itself all over the world and has quite a history in glass manufacturing. Since the first glass factory was founded in Stuetzerbach in 1674, it was a village of innovation. The German thermometer (1839), light bulb (1883), Mr. Röntgen's X-Ray tube (1893) and the vacuum flask (1895) were all first developed in Stuetzerbach.

Since September 2016 ILS is part of the Gardner Denver Medical Group. Gardner Denver Medical with its brands Thomas, Welch, Tricontinent, Zinsser and ILS is a leader in flow control products such as vacuum and liquid pumps, liquid handling robots and compressors for medical, life sciences and selected other industries – focused on solutions for OEMs. A global production network throughout the United States, Europe and Asia allows a fast and flexible reaction to our customer needs.

Visit our website for more Information:

**Our Products are now available 24/7 at
www.microsyringes.com**

SELECTION GUIDE

SYRINGE DESIGNS	10
NEEDLE TIP STYLE	12
PLUNGER SEAL	13
INSTRUMENT COMPATIBILITY	14

Selection Guide

Syringe Designs

Syringe selection guide for microsyringes by ILS:



Fixed Needles (FN)

- Easy to use
- Economical
- Not autoclavable



Removable Needles (RN)

- For inexperienced users
- Easy to replace in case of bending
- Use of different needle sizes on the same syringe barrel



Stainless Steel Plunger N

- For dispensing of liquids
- Plunger individually fitted to glass barrel
- Plunger not replaceable



PTFE-Seal H

- For dispensing of gas and liquids, headspace
- Gas tight
- Plunger replaceable



HDPE-Seal

- For buffer and other aqueous solutions
- For smoother operation
- Plunger replaceable



Adjustable PTFE-Seal P

- For gas chromatography and HPLC Valves
- Dosage under pressure
- Regulation of seal-pressure by screws



Glass Luer Tip LT

- For sample dosage
- Dosage of aggressive fluids
- Autoclavable



PTFE Luer Tip TL

- For sample dosage
- Dosage of aggressive fluids
- For luer lock needles and fittings



Luer Lock TLL

- For sample dosage, diluters and dispensers
- Dosage of aggressive fluids
- For luer hub needles and connectors



Zero Dead Volume T

- For gas chromatography and TLC
- Dosage of small amounts of liquids
- Plunger runs inside the needle



Extended Handle SN / SH

- For gas chromatography and HPLC Valves
- Prevents heat transfer from hand to content
- Protects plunger from bending



Static PTFE-Seal topping the glass barrel G

- For gas chromatography
 - HPLC Valves
 - Dosage under counter-pressure
-

Selection Guide

Needle Tip Style

ILS needle tip styles for microsyringes:



Needle Tip “a”

This tip is designed for optimum penetration of the septa and prevents septa coring. The 17° bevel is proven standard. In addition our electro tapered tip minimizes the necessary piercing force and diameter of the injection channel.



Needle Tip “b”

This tip has a 90° bevel for precise pipetting. This design releases drops completely, for maximum reproducibility. It is widely used for HPLC sample injection.



Needle Tip “c”

This tip has been specially designed for autosamplers in routine applications. The electro tapered tip and the polished 90° square end eliminate burrs. It is ideal for PTFE-Laminated-Seals and regular septas.



Needle Tip “c”**

Dual gauge – Narrow gauge at front end for on-column injection and wide gauge to increase strength for autosampler use.



Needle Tip “d”

Tip “d” is equipped with a side opening for dispensing and filling. This design avoids plugging and minimizes septum damage. It is ideal for thicker septa and recommended for headspace analysis.

Selection Guide

Plunger Seal

Seals with different materials for your specific application:



PTFE-Seal - virgin PTFE

- Excellent chemical resistance
-



PTFE-Black-Seal - special PTFE

- High chemical resistance
 - Less friction than virgin PTFE
 - Less electrostatic charge
 - Higher durability
 - Less “cold flow“
 - Higher longevity
 - Order information:
Add “BL“ to catalog number (XXXXXXXX-BL)
-



HDPE-Seal - polyethylene high density

- Better durability than PTFE when working with saline solutions
-

Selection Guide

Instrument Compatibility

Compatibilities of instruments and microsyringes by ILS:

Manufacturer	Instrument	Syringe Model
Abbott*	TDX / ADX / IMX / Cell Dyn 1700	TLL-X
	m2000sp	XP
	Cell Dyn 1300 / 1600 / 300	TLL-Abbott*
	Cell Dyn 1300 / 1600 / 300	TLL-X
ABI*	3100 Sequencer	ABI 3100
	3700 Sequencer	ABI 3700
BD Biosciences*	FACS MultiSET Sample Prep	XLP
Beckmann Coulter*	Prep Plus	XLP
	Biomek FX	XP
	Biomek NX	XP
	Vidiera NsP	XP
Behr*	behrotest	XLP
Behring*	BLN Module III	TLL
Boehringer*	Dilutrend	TLL
Caliper*	Sciclone ALH 3000	XLP
	Sciclone ALH 3000	XP
Cavro*	XL syringe pump	XE
	XP syringe pump	XP
	XCalibur syringe pump	XP
	XP Smart syringe pump	XP
	Centris	XE
	X-CMP (Centris for Fluent ?)	XE
	XL 3000	XL
	XLP 6000 syringe pump	XLP
	XMP 6000 Multi-Channel syringe pump	XLP
CGA*	EOS 890 / Plus	XLP
Cooper / Technicon*	RA XT / 500 / 100	TLL
Digene*	Rapid Capture System	RQ
Electro*	Autoloader I-III	TLL
Eppendorf*	EPOS / EASY / ERIS	AD
Gesim*	Nano-plotter	XP
Hamilton*	Microlab 400 / 500 / 900 / M / Digital Dilutor	TLL-X
	Microlab 400 / 500 / 900 / M / Digital Dilutor	DX
	Microlab 400 / 500 / 900 / M / Digital Dilutor	TLL
	Microlab 500 / 900	CX
	PSD/4	H-PD
Horiba*	ABX Pentra 400	TLL-X
Innovatis*	cedex	XLP
Instrumentation*	Multistat III	TLL
ISA Biologie*	ISA MAT (HSD)	TLL-X

*All other trademarks, service marks, registered trademarks, and registered service marks are the property of their respective owners.

Gardner Denver and ILS are not affiliated with Abbott, ABI, BD Biosciences, Beckmann Coulter, Behr, Behring, Boehringer, Caliper, Cavro, CGA, Cooper / Technicon, Digene, Electro, Eppendorf, Gesim, Hamilton, Horiba, Innovatis, Instrumentation, ISA Biologie, Kratel, Maihak, Mannheim, Moritex, MWG, Packard, Perkin Elmer, Qiagen, Roche, Rosys, Rosys Anthos, Spark, Tecan, Technicon, Thermo Electro, TriContinent Scientific, Wiener Lab, Zinsser Analytic, Zymark in any way.

Manufacturer	Instrument	Syringe Model
Kratel*	Partoscope FD	TLL-X
Maihak*	TOCOR 101	XLP
Mannheim*	ES300	TLL
Moritex*	EX-MULTI	XLP
MWG*	Roboprep 2500	XLP
	Robogo	XLP
	Roboseq 2500	XLP
Packard*	Multiprobe II	XLP
Perkin Elmer*	Multiprobe II	XLP
	Janus	XLP
Qiagen*	Biorobot 9600	RQ
Roche*	Midias	AD
	Cobas Integral	XLP
Rosys*	Plato 1000 / 3000 / 3000-1 / 7000	RQ
Rosys Anthos*	Lucy 2 / 3 / AutoLucy	RQ
Spark*	Triathlon	XLP
	Endurance	H-KP Spark
Tecan*	MiniPrep 50 / 75	XLP
	Fluent	XE
	Genesis	XP
	Genesis RMP 150	XP
	Genesis FE 500 Workcell	XP
	Hemotyper	XP
	Minilyser	XLP
	Miniprep 60 / 75	XLP
	Mini Swift	XLP
	Freedom EVO Clinical	XP
	Freedom EVO	XP
	Freedom EVO 75	XLP
	4-Channal-Dispenser	XLP
Technicon*		TLL
Thermo Electro*	Data Pro	XLP
TriContinent Scientific*	C3000	XP
	C24000	XP
	MC6000	XP
	C6000	XLP
Wiener Lab*	Metrolab 2300 plus	XLP
Zinsser Analytic*	Lissy XL / XXL / Plato / Sophas / Pepsy	RQ/XP
	Redy	RQ/XP
Zymark*	Sciclone ALH 3000	XLP
	Sciclone ALH 3000	XP

MICROSYRINGERES

AUTOMATIC LIQUID HANDLING	18
Stroke 30 mm	18
Stroke 60 mm	26
Syringes for Infusion Pumps	52
DOSAGE OF LIQUIDS - SERIES N	55
Fixed Needles	56
Removable Needles	58
Super Flexible Plunger	60
Series SN	61
Series T	62
Series LT	64
Series TLL	65
DOSAGE OF GAS & LIQUIDS - SERIES H	66
Fixed Needles	67
Removable Needles	69
Series SH	70
Series G	71
Series P	72
Series LT	73
Series TLT	74
Series TLL	75
HPLC SYRINGES	76
Most Common Valves	76
Valco* VISF-1 Valves	77
Waters* U6K Injection Valves	78
ON-COLUMN SYRINGES	80
DOSAGE IN AUTOSAMPLER	82
GC Autosampler	82
HPLC Autosampler	94
CTC* Instruments	104
One Lambda Jet*	108
TLC CAMAG* Linomat III, IV and V	109
Robbins Hydra	110
Olympus* AU Chemistry Analyzer	112

OVERVIEW

Automatic Liquid Handling - Stroke 30 mm

Description	Front Fitting	Plunger Top	Page
H-PD	Teflon Luer Lock (TLL)	Internal 6-32 UNC	19
XE	1/4"-28 UNF	Ball	20
XP	1/4"-28 UNF	Hour glass plunger button	21
XP-PD	1/4"-28 UNF	Internal 6-32 UNC	23
XP-XL	1/4"-28 UNF	Hole ø 4.8	24
XP-XL-"short"	1/4"-28 UNF "short"	Hole ø 4.8	25

PTFE-Seal

- Chemically resistant
- Heavy duty syringes

PTFE-Seal with Silicone

- Specially designed for handling of strong buffers and other aqueous solutions
- The modified PTFE-Seals guaranteed, extended lifetime under heavy duty conditions

PTFE-Black-Seal

- Specially designed for handling of strong buffers and other aqueous solutions
- The modified PTFE-Seals guaranteed, extended lifetime under heavy duty conditions

HDPE-Seal

- Long lifetime
- Good resistance to strong buffers and other aqueous solutions

UHMWPE-Seal

- Long lifetime
- Good resistance to strong buffers and other aqueous solutions

Automatic Liquid Handling - Stroke 30 mm

H-PD



TECHNICAL INFORMATION

Glass Barrel: Borosilicate 3.3

PTFE-Seal

Volume	Series	Stroke	Plunger Tip	Front Fitting	Plunger Top	Part No.
12.5 µL	H	30 mm	PTFE	Luer	6-32 UNC	2658415
25 µL	H	30 mm	PTFE	Luer	6-32 UNC	2658515
50 µL	H	30 mm	PTFE	Luer	6-32 UNC	2658615
100 µL	H	30 mm	PTFE	Luer	6-32 UNC	2658715
125 µL	H	30 mm	PTFE	Luer	6-32 UNC	2658714
250 µL	H	30 mm	PTFE	Luer	6-32 UNC	2658815
500 µL	H	30 mm	PTFE	Luer	6-32 UNC	2658915
1.0 mL	H	30 mm	PTFE	Luer	6-32 UNC	2658014
1.25 mL	H	30 mm	PTFE	Luer	6-32 UNC	2658015
2.5 mL	H	30 mm	PTFE	Luer	6-32 UNC	2658035
5.0 mL	H	30 mm	PTFE	Luer	6-32 UNC	2658055
12.5 mL	H	30 mm	PTFE	Luer	6-32 UNC	2658074

PTFE-Seal with Silicone

Volume	Series	Stroke	Plunger Tip	Front Fitting	Plunger Top	Part No.
12.5 µL	H	30 mm	Silicone	Luer	6-32 UNC	2666415
25 µL	H	30 mm	Silicone	Luer	6-32 UNC	2666515
50 µL	H	30 mm	Silicone	Luer	6-32 UNC	2666615
100 µL	H	30 mm	Silicone	Luer	6-32 UNC	2666715
125 µL	H	30 mm	Silicone	Luer	6-32 UNC	2666714
250 µL	H	30 mm	Silicone	Luer	6-32 UNC	2666815
500 µL	H	30 mm	Silicone	Luer	6-32 UNC	2666915
1.0 mL	H	30 mm	Silicone	Luer	6-32 UNC	2666014
1.25 mL	H	30 mm	Silicone	Luer	6-32 UNC	2666015
2.5 mL	H	30 mm	Silicone	Luer	6-32 UNC	2666035
5.0 mL	H	30 mm	Silicone	Luer	6-32 UNC	2666055
12.5 mL	H	30 mm	Silicone	Luer	6-32 UNC	2666074

UHMWPE-Seal

Volume	Series	Stroke	Plunger Tip	Front Fitting	Plunger Top	Part No.
25 µL	H	30 mm	UHMWPE	Luer	6-32 UNC	2665515
50 µL	H	30 mm	UHMWPE	Luer	6-32 UNC	2665615
100 µL	H	30 mm	UHMWPE	Luer	6-32 UNC	2665715
125 µL	H	30 mm	UHMWPE	Luer	6-32 UNC	2665714
250 µL	H	30 mm	UHMWPE	Luer	6-32 UNC	2665815
500 µL	H	30 mm	UHMWPE	Luer	6-32 UNC	2665915
1.0 mL	H	30 mm	UHMWPE	Luer	6-32 UNC	2665014
1.25 mL	H	30 mm	UHMWPE	Luer	6-32 UNC	2665015
2.5 mL	H	30 mm	UHMWPE	Luer	6-32 UNC	2665035
5.0 mL	H	30 mm	UHMWPE	Luer	6-32 UNC	2665055

Automatic Liquid Handling - Stroke 30 mm

XE



TECHNICAL INFORMATION

Glass Barrel: Borosilicate 3.3

PTFE-Seal

Volume	Series	Stroke	Plunger Tip	Front Fitting	Part No.
25 µL	H	30 mm	PTFE	1/4"-28 UNF	2607521
50 µL	H	30 mm	PTFE	1/4"-28 UNF	2607621
100 µL	H	30 mm	PTFE	1/4"-28 UNF	2607721
250 µL	H	30 mm	PTFE	1/4"-28 UNF	2607821
500 µL	H	30 mm	PTFE	1/4"-28 UNF	2607921
1.0 mL	H	30 mm	PTFE	1/4"-28 UNF	2607021
1.5 mL	H	30 mm	PTFE	1/4"-28 UNF	2607027
2.5 mL	H	30 mm	PTFE	1/4"-28 UNF	2607041
5.0 mL	H	30 mm	PTFE	1/4"-28 UNF	2607061

PTFE-Seal with Silicone

Volume	Series	Stroke	Plunger Tip	Front Fitting	Part No.
500 µL	H	30 mm	Silicone	1/4"-28 UNF	2646927
1.0 mL	H	30 mm	Silicone	1/4"-28 UNF	2646027
2.5 mL	H	30 mm	Silicone	1/4"-28 UNF	2646047
5.0 mL	H	30 mm	Silicone	1/4"-28 UNF	2646067

HDPE-Seal

Volume	Series	Stroke	Plunger Tip	Front Fitting	Part No.
50 µL	H	30 mm	HDPE	1/4"-28 UNF	2646628
100 µL	H	30 mm	HDPE	1/4"-28 UNF	2646728
500 µL	H	30 mm	HDPE	1/4"-28 UNF	2646928
1.0 mL	H	30 mm	HDPE	1/4"-28 UNF	2646028
2.5 mL	H	30 mm	HDPE	1/4"-28 UNF	2646048
5.0 mL	H	30 mm	HDPE	1/4"-28 UNF	2646068

Automatic Liquid Handling - Stroke 30 mm

XP



TECHNICAL INFORMATION

Glass Barrel: Borosilicate 3.3

PTFE-Seal

Volume	Series	Stroke	Plunger Tip	Front Fitting	Part No.
25 µL	H	30 mm	PTFE	1/4"-28 UNF	2607515
50 µL	H	30 mm	PTFE	1/4"-28 UNF	2607615
100 µL	H	30 mm	PTFE	1/4"-28 UNF	2607715
150 µL	H	30 mm	PTFE	1/4"-28 UNF	2607752
250 µL	H	30 mm	PTFE	1/4"-28 UNF	2607815
500 µL	H	30 mm	PTFE	1/4"-28 UNF	2607915
1.0 mL	H	30 mm	PTFE	1/4"-28 UNF	2607015
1.25 mL	H	30 mm	PTFE	1/4"-28 UNF	2607025
1.5 mL	H	30 mm	PTFE	1/4"-28 UNF	2607026
2.5 mL	H	30 mm	PTFE	1/4"-28 UNF	2607035
3.0 mL	H	30 mm	PTFE	1/4"-28 UNF	2607045
5.0 mL	H	30 mm	PTFE	1/4"-28 UNF	2607075
6.0 mL	H	30 mm	PTFE	1/4"-28 UNF	2607089
12.5 mL	H	30 mm	PTFE	1/4"-28 UNF	2607151

PTFE-Seal with Silicone

Volume	Series	Stroke	Plunger Tip	Front Fitting	Part No.
25 µL	H	30 mm	Silicone	1/4"-28 UNF	2647517
50 µL	H	30 mm	Silicone	1/4"-28 UNF	2647617
100 µL	H	30 mm	Silicone	1/4"-28 UNF	2647717
250 µL	H	30 mm	Silicone	1/4"-28 UNF	2647817
500 µL	H	30 mm	Silicone	1/4"-28 UNF	2647917
1.0 mL	H	30 mm	Silicone	1/4"-28 UNF	2647017
2.5 mL	H	30 mm	Silicone	1/4"-28 UNF	2647037
5.0 mL	H	30 mm	Silicone	1/4"-28 UNF	2647077
6.0 mL	H	30 mm	Silicone	1/4"-28 UNF	2647087

PTFE-Black-Seal

Volume	Series	Stroke	Plunger Tip	Front Fitting	Part No.
50 µL	H	30 mm	PTFE - Black	1/4"-28 UNF	9607615
100 µL	H	30 mm	PTFE - Black	1/4"-28 UNF	9607715
150 µL	H	30 mm	PTFE - Black	1/4"-28 UNF	2607752-BL
250 µL	H	30 mm	PTFE - Black	1/4"-28 UNF	9607811
500 µL	H	30 mm	PTFE - Black	1/4"-28 UNF	9607911
1.0 mL	H	30 mm	PTFE - Black	1/4"-28 UNF	9607011
2.5 mL	H	30 mm	PTFE - Black	1/4"-28 UNF	9607034
5.0 mL	H	30 mm	PTFE - Black	1/4"-28 UNF	9607074
6.0 mL	H	30 mm	PTFE - Black	1/4"-28 UNF	9607076

Automatic Liquid Handling - Stroke 30 mm

XP



TECHNICAL INFORMATION

Glass Barrel: Borosilicate 3.3

HDPE-Seal

Volume	Series	Stroke	Plunger Tip	Front Fitting	Part No.
50 µL	H	30 mm	HDPE	1/4"-28 UNF	2647618
100 µL	H	30 mm	HDPE	1/4"-28 UNF	2647718
250 µL	H	30 mm	HDPE	1/4"-28 UNF	2647818
500 µL	H	30 mm	HDPE	1/4"-28 UNF	2647918
1.0 mL	H	30 mm	HDPE	1/4"-28 UNF	2647018
2.5 mL	H	30 mm	HDPE	1/4"-28 UNF	2647038
5.0 mL	H	30 mm	HDPE	1/4"-28 UNF	2647078
6.0 mL	H	30 mm	HDPE	1/4"-28 UNF	2647088

UHMWPE-Seal

Volume	Series	Stroke	Plunger Tip	Front Fitting	Part No.
500 µL	H	30 mm	UHMWPE	1/4"-28 UNF	2647919
1.0 mL	H	30 mm	UHMWPE	1/4"-28 UNF	2647016
2.5 mL	H	30 mm	UHMWPE	1/4"-28 UNF	2647036
5.0 mL	H	30 mm	UHMWPE	1/4"-28 UNF	2647076
6.0 mL	H	30 mm	UHMWPE	1/4"-28 UNF	2607004

Automatic Liquid Handling - Stroke 30 mm

XP-PD



TECHNICAL INFORMATION

Plunger Top: 6-32UNC

Glass Barrel: Borosilicate 3.3

PTFE-Seal

Volume	Series	Stroke	Plunger Tip	Front Fitting	Part No.
12.5 µL	H	30 mm	PTFE	1/4"-28 UNF	2676401
25 µL	H	30 mm	PTFE	1/4"-28 UNF	2676501
50 µL	H	30 mm	PTFE	1/4"-28 UNF	2676601
100 µL	H	30 mm	PTFE	1/4"-28 UNF	2676701
125 µL	H	30 mm	PTFE	1/4"-28 UNF	2676702
250 µL	H	30 mm	PTFE	1/4"-28 UNF	2676801
500 µL	H	30 mm	PTFE	1/4"-28 UNF	2676901
1.0 mL	H	30 mm	PTFE	1/4"-28 UNF	2676011
1.25 mL	H	30 mm	PTFE	1/4"-28 UNF	2676012
2.5 mL	H	30 mm	PTFE	1/4"-28 UNF	2676031
5.0 mL	H	30 mm	PTFE	1/4"-28 UNF	2676051
12.5 mL	H	30 mm	PTFE	1/4"-28 UNF	2676072

Automatic Liquid Handling - Stroke 30 mm

XP-XL



TECHNICAL INFORMATION

Glass Barrel: Borosilicate 3.3

PTFE-Seal

Volume	Series	Stroke	Plunger Tip	Front Fitting	Part No.
12.5 µL	H	30 mm	PTFE	1/4"-28 UNF	2676415
25 µL	H	30 mm	PTFE	1/4"-28 UNF	2676515
50 µL	H	30 mm	PTFE	1/4"-28 UNF	2676615
100 µL	H	30 mm	PTFE	1/4"-28 UNF	2676715
250 µL	H	30 mm	PTFE	1/4"-28 UNF	2676815
500 µL	H	30 mm	PTFE	1/4"-28 UNF	2676915
1.0 mL	H	30 mm	PTFE	1/4"-28 UNF	2676015
1.5 mL	H	30 mm	PTFE	1/4"-28 UNF	2676020
2.5 mL	H	30 mm	PTFE	1/4"-28 UNF	2676035
5.0 mL	H	30 mm	PTFE	1/4"-28 UNF	2676055
12.5 mL	H	30 mm	PTFE	1/4"-28 UNF	2676075

HDPE-Seal

Volume	Series	Stroke	Plunger Tip	Front Fitting	Part No.
50 µL	H	30 mm	HDPE	1/4"-28 UNF	2676616
100 µL	H	30 mm	HDPE	1/4"-28 UNF	2676717
250 µL	H	30 mm	HDPE	1/4"-28 UNF	2676819
500 µL	H	30 mm	HDPE	1/4"-28 UNF	2676916
1.0 mL	H	30 mm	HDPE	1/4"-28 UNF	2676016
1.5 mL	H	30 mm	HDPE	1/4"-28 UNF	2676021
2.5 mL	H	30 mm	HDPE	1/4"-28 UNF	2676036
5.0 mL	H	30 mm	HDPE	1/4"-28 UNF	2676057

Automatic Liquid Handling - Stroke 30 mm

XP-XL »SHORT« (THREAD LENGTH 5 MM)



TECHNICAL INFORMATION

Glass Barrel: Borosilicate 3.3

PTFE-Seal

Volume	Series	Stroke	Plunger Tip	Front Fitting	Part No.
12.5 µL	H	30 mm	PTFE	1/4"-28 UNF	2685415
25 µL	H	30 mm	PTFE	1/4"-28 UNF	2685515
50 µL	H	30 mm	PTFE	1/4"-28 UNF	2685615
100 µL	H	30 mm	PTFE	1/4"-28 UNF	2685715
250 µL	H	30 mm	PTFE	1/4"-28 UNF	2685815
500 µL	H	30 mm	PTFE	1/4"-28 UNF	2685915
1.0 mL	H	30 mm	PTFE	1/4"-28 UNF	2685015
1.5 mL	H	30 mm	PTFE	1/4"-28 UNF	2685020
2.5 mL	H	30 mm	PTFE	1/4"-28 UNF	2685035
5.0 mL	H	30 mm	PTFE	1/4"-28 UNF	2685055

OVERVIEW

Automatic Liquid Handling - Stroke 60 mm

Description	Front Fitting	Plunger Top	Page
Abbott* CELL-DYN**	Teflon Luer Lock (TLL)	Threaded screw	33
ABI* PRISM 3100	1/4"-32 UNEF	Button with internal 6-32 UNC	40
AD	M8x0.75	Button	43
Adjustable Internal Stopper	Teflon Luer Lock (TLL) + Teflon Luer Tip (TLT)	Button	31
C	1/4"-28 UNF	Button	35
CX	1/4"-28 UNF	Button with plunger stop and internal 6-32 UNC	36
DAD	M8x0.75	Button with internal 6-32 UNC	44
Dionex* AS	1/4"-28 UNF	Hole ø 4.8	39
DX	Teflon Luer Lock (TLL)	Button with internal 6-32 UNC	32
Gilson* 401	M10	Hole with screw	47
Gilson* 402/406	M10	Internal M4	48
H-KP	1/4"-28 UNF	Hole ø 4.8	37
Innovadyne* Nanodrop**	1/4"-28 UNF	Hole ø 4.8 with screw	41
Kloehn* Drive Module 503000	1/4"-28 UNF	Hole ø 4.8	42
Kone / Thermo Instruments*	Different thread	Button	49
RQ	Teflon Luer Lock (TLL)	Hole ø 4.8 with screw	30
Selectra*	M8x0.75	Button with plunger stop	45
TLL	Teflon Luer Lock (TLL)	Button	27
TLL-X	Teflon Luer Lock (TLL)	Button with plunger stop	28
Tubing Connector	Connector M6 or 1/4"-28 UNF	Button	50
Tubing Connector HPLC	Connector 10-32 cone	Button	51
Varian*	M8x1	Button	46
XLP	1/4"-28 UNF	Hole ø 4.8	38
XL	Teflon Luer Lock (TLL)	Hole ø 4.8	29
Zymark Instruments*	Teflon Luer Lock (TLL)	Plunger rod with internal 6-32 UNC	34

PTFE-Seal

- Chemically resistant
- Heavy duty syringes

PTFE-Seal with Silicone

- Specially designed for handling of strong buffers and other aqueous solutions
- The modified PTFE-Seals guaranteed, extended lifetime under heavy duty conditions

PTFE - Black - Seal

- Specially designed for handling of strong buffers and other aqueous solutions
- The modified PTFE-Seals guaranteed, extended lifetime under heavy duty conditions

HDPE-Seal

- Long lifetime
- Good resistance to strong buffers and other aqueous solutions

UHMWPE - Seal

- Long lifetime
- Good resistance to strong buffers and other aqueous solutions

*All other trademarks, service marks, registered trademarks, and registered service marks are the property of their respective owners. Gardner Denver and ILS are not affiliated with Abbott, ABI, Dionex, Gilson, Innovadyne, Kloehn, Kone/Thermo Instruments, Selectra, Varian and Zymark Instruments in any way.

**Cell-Dyn is a trademark of Abbott. Nanodrop is a trademark of Innovadyne.

Automatic Liquid Handling - Stroke 60 mm

TLL

Hamilton* Microlab 400 / 500 / 900 / M / Digital Dilutor, Behring* BLN Module III, Boehringer* Dilutrend, Cooper / Technicon* RA XT / 500 / 100, Electro* Autoloader I-III, Multistat* III, Mannheim* ES300



TECHNICAL INFORMATION

Glass Barrel: Borosilicate 3.3

PTFE-Seal

Volume	Series	Stroke	Plunger Tip	Front Fitting	Part No.
25 µL	H	60 mm	PTFE	Luer	2607509
50 µL	H	60 mm	PTFE	Luer	2607609
100 µL	H	60 mm	PTFE	Luer	2607709
250 µL	H	60 mm	PTFE	Luer	2607809
500 µL	H	60 mm	PTFE	Luer	2607909
1.0 mL	H	60 mm	PTFE	Luer	2607011
2.5 mL	H	60 mm	PTFE	Luer	2607031
5.0 mL	H	60 mm	PTFE	Luer	2607051
10.0 mL	H	60 mm	PTFE	Luer	2607071
25.0 mL	H	60 mm	PTFE	Luer	2607091
50.0 mL	H	60 mm	PTFE	Luer	2607101
100.0 mL	H	120 mm	PTFE	Luer	2607121

HDPE-Seal

Volume	Series	Stroke	Plunger Tip	Front Fitting	Part No.
25 µL	H	60 mm	HDPE	Luer	2641518
50 µL	H	60 mm	HDPE	Luer	2641618
100 µL	H	60 mm	HDPE	Luer	2641718
250 µL	H	60 mm	HDPE	Luer	2641818
500 µL	H	60 mm	HDPE	Luer	2641918
1.0 mL	H	60 mm	HDPE	Luer	2641018
2.5 mL	H	60 mm	HDPE	Luer	2641038
5.0 mL	H	60 mm	HDPE	Luer	2641058
10.0 mL	H	60 mm	HDPE	Luer	2641078
25.0 mL	H	60 mm	HDPE	Luer	2641098

PTFE-Seal with Silicone

Volume	Series	Stroke	Plunger Tip	Front Fitting	Part No.
25 µL	H	60 mm	Silicone	Luer	2641517
50 µL	H	60 mm	Silicone	Luer	2641617
100 µL	H	60 mm	Silicone	Luer	2641717
250 µL	H	60 mm	Silicone	Luer	2641817
500 µL	H	60 mm	Silicone	Luer	2641917
1.0 mL	H	60 mm	Silicone	Luer	2641017
2.5 mL	H	60 mm	Silicone	Luer	2641037
5.0 mL	H	60 mm	Silicone	Luer	2641057
10.0 mL	H	60 mm	Silicone	Luer	2641077

Automatic Liquid Handling - Stroke 60 mm

TLL-X

Tecan* Sampler 505 / 510, RSP 5031 / 5032 / 5051 / 5052 / 5071 / 5072 / 8051, Abbott* TDX / ADX / IMX / Cell Dyn 1300 / 1600 / 300 / 1700, Hamilton* Microlab, Horiba* ABX Pentra 400, ISA Biologie* ISA MAT (HSD), Kratel* Partoscope FD



TECHNICAL INFORMATION

Glass Barrel: Borosilicate 3.3

PTFE-Seal

Volume	Series	Stroke	Plunger Tip	Front Fitting	Plunger Top	Part No.
25 µL	H	60 mm	PTFE	Luer	6-32 UNC	2607517
50 µL	H	60 mm	PTFE	Luer	6-32 UNC	2607617
100 µL	H	60 mm	PTFE	Luer	6-32 UNC	2607717
250 µL	H	60 mm	PTFE	Luer	6-32 UNC	2607817
500 µL	H	60 mm	PTFE	Luer	6-32 UNC	2607917
1.0 mL	H	60 mm	PTFE	Luer	6-32 UNC	2607017
2.5 mL	H	60 mm	PTFE	Luer	6-32 UNC	2607037
5.0 mL	H	60 mm	PTFE	Luer	6-32 UNC	2607057
10.0 mL	H	60 mm	PTFE	Luer	6-32 UNC	2607077
25.0 mL	H	60 mm	PTFE	Luer	6-32 UNC	2607155

PTFE-Seal with Silicone

Volume	Series	Stroke	Plunger Tip	Front Fitting	Plunger Top	Part No.
25 µL	H	60 mm	Silicone	Luer	6-32 UNC	2643517
50 µL	H	60 mm	Silicone	Luer	6-32 UNC	2643617
100 µL	H	60 mm	Silicone	Luer	6-32 UNC	2643717
250 µL	H	60 mm	Silicone	Luer	6-32 UNC	2643817
500 µL	H	60 mm	Silicone	Luer	6-32 UNC	2643917
1.0 mL	H	60 mm	Silicone	Luer	6-32 UNC	2643017
2.5 mL	H	60 mm	Silicone	Luer	6-32 UNC	2643037
5.0 mL	H	60 mm	Silicone	Luer	6-32 UNC	2643057
10.0 mL	H	60 mm	Silicone	Luer	6-32 UNC	2643077

HDPE-Seal

Volume	Series	Stroke	Plunger Tip	Front Fitting	Plunger Top	Part No.
50 µL	H	60 mm	HDPE	Luer	6-32 UNC	2643618
100 µL	H	60 mm	HDPE	Luer	6-32 UNC	2643718
250 µL	H	60 mm	HDPE	Luer	6-32 UNC	2643818
500 µL	H	60 mm	HDPE	Luer	6-32 UNC	2643918
1.0 mL	H	60 mm	HDPE	Luer	6-32 UNC	2643018
2.5 mL	H	60 mm	HDPE	Luer	6-32 UNC	2643038
5.0 mL	H	60 mm	HDPE	Luer	6-32 UNC	2643058
10.0 mL	H	60 mm	HDPE	Luer	6-32 UNC	2643078
25.0 mL	H	60 mm	HDPE	Luer	6-32 UNC	2643095

Automatic Liquid Handling - Stroke 60 mm

XL

Cavro* XL syringe pump, Perkin Elmer* Multiprobe II / Janus*, Caliper* Sciclone ALH 3000, BD FACS* MultiSet, Beckman* Coulter Prep Plus, Behr* behrotest, CGA* EOS 890 / Plus, Maihak* TOCOR 101, Moritex* EX-Multi, MWG* Robots, Roches* Cobas Integral, Spark* Triathlon, Tecan* MiniPrep 50/75, Tecan* Minilyser / Miniprep 60 / 75*Mini Swift, Thermo* Data Pro, Wiener Lab* Metrolab 2300 Plus



TECHNICAL INFORMATION

Glass Barrel: Borosilicate 3.3

PTFE-Seal

Volume	Series	Stroke	Plunger Tip	Front Fitting	Part No.
25 µL	H	60 mm	PTFE	Luer	2607511
50 µL	H	60 mm	PTFE	Luer	2607611
100 µL	H	60 mm	PTFE	Luer	2607711
250 µL	H	60 mm	PTFE	Luer	2607811
500 µL	H	60 mm	PTFE	Luer	2607911
1.0 mL	H	60 mm	PTFE	Luer	2607013
2.5 mL	H	60 mm	PTFE	Luer	2607033
5.0 mL	H	60 mm	PTFE	Luer	2607053
10.0 mL	H	60 mm	PTFE	Luer	2607073
25.0 mL	H	60 mm	PTFE	Luer	2607096
50.0 mL	H	60 mm	PTFE	Luer	2607103

PTFE-Seal with Silicone

Volume	Series	Stroke	Plunger Tip	Front Fitting	Part No.
25 µL	H	60 mm	Silicone	Luer	2645517
50 µL	H	60 mm	Silicone	Luer	2645617
100 µL	H	60 mm	Silicone	Luer	2645717
250 µL	H	60 mm	Silicone	Luer	2645817
500 µL	H	60 mm	Silicone	Luer	2645917
1.0 mL	H	60 mm	Silicone	Luer	2645017
2.5 mL	H	60 mm	Silicone	Luer	2645037
5.0 mL	H	60 mm	Silicone	Luer	2645057
10.0 mL	H	60 mm	Silicone	Luer	2645077
25.0 mL	H	60 mm	Silicone	Luer	2645097

HDPE-Seal

Volume	Series	Stroke	Plunger Tip	Front Fitting	Part No.
50 µL	H	60 mm	HDPE	Luer	2645618
100 µL	H	60 mm	HDPE	Luer	2645718
250 µL	H	60 mm	HDPE	Luer	2645818
500 µL	H	60 mm	HDPE	Luer	2645918
1.0 mL	H	60 mm	HDPE	Luer	2645018
2.5 mL	H	60 mm	HDPE	Luer	2645038
5.0 mL	H	60 mm	HDPE	Luer	2645058
10.0 mL	H	60 mm	HDPE	Luer	2645078

*All other trademarks, service marks, registered trademarks, and registered service marks are the property of their respective owners. Gardner Denver and ILS are not affiliated with Cavro, Perkin Elmer, Janus, Caliper, BD FACS, Beckman, Behr, CGA, Maihak, Moritex, MWG, Roches, Spark, Tecan, Thermo and Wiener Lab in any way.

Automatic Liquid Handling - Stroke 60 mm

RQ

Zinsser Analytic Lissy / Sophas / Speedy / Calli / Moss, Rosys* Plato & Lucy, Qiagen* Biorobot 9600, Digene* Rapid Capture System, Unitech Chemwell* 2910

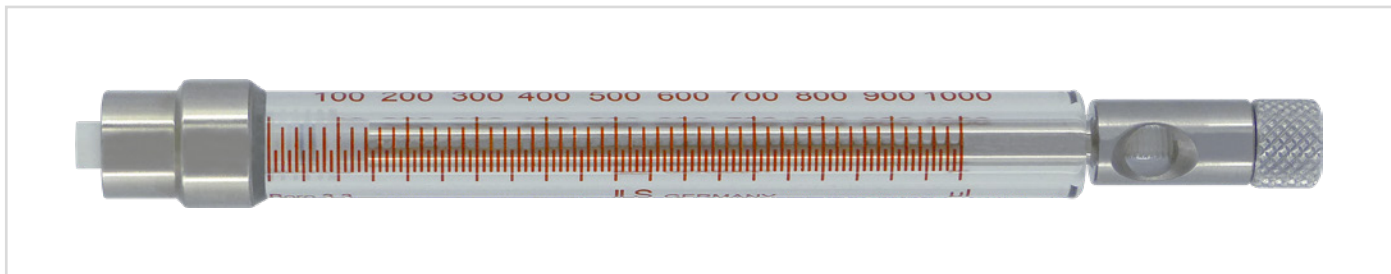

TECHNICAL INFORMATION

Glass Barrel: Borosilicate 3.3

PTFE-Seal

Volume	Series	Stroke	Plunger Tip	Front Fitting	Plunger Top	Part No.
25 µL	H	60 mm	PTFE	Luer	Screw	2607512
50 µL	H	60 mm	PTFE	Luer	Screw	2607612
100 µL	H	60 mm	PTFE	Luer	Screw	2607712
250 µL	H	60 mm	PTFE	Luer	Screw	2607812
500 µL	H	60 mm	PTFE	Luer	Screw	2607912
1.0 mL	H	60 mm	PTFE	Luer	Screw	2607014
2.5 mL	H	60 mm	PTFE	Luer	Screw	2607034
5.0 mL	H	60 mm	PTFE	Luer	Screw	2607054
10.0 mL	H	60 mm	PTFE	Luer	Screw	2607074

PTFE-Seal with Silicone

Volume	Series	Stroke	Plunger Tip	Front Fitting	Plunger Top	Part No.
25 µL	H	60 mm	Silicone	Luer	Screw	2644517
50 µL	H	60 mm	Silicone	Luer	Screw	2644617
100 µL	H	60 mm	Silicone	Luer	Screw	2644717
250 µL	H	60 mm	Silicone	Luer	Screw	2644817
500 µL	H	60 mm	Silicone	Luer	Screw	2644917
1.0 mL	H	60 mm	Silicone	Luer	Screw	2644017
2.5 mL	H	60 mm	Silicone	Luer	Screw	2644037
5.0 mL	H	60 mm	Silicone	Luer	Screw	2644057
10.0 mL	H	60 mm	Silicone	Luer	Screw	2644077

HDPE-Seal

Volume	Series	Stroke	Plunger Tip	Front Fitting	Plunger Top	Part No.
50 µL	H	60 mm	HDPE	Luer	Screw	2644618
100 µL	H	60 mm	HDPE	Luer	Screw	2644718
250 µL	H	60 mm	HDPE	Luer	Screw	2644818
500 µL	H	60 mm	HDPE	Luer	Screw	2644918
1.0 mL	H	60 mm	HDPE	Luer	Screw	2644018
2.5 mL	H	60 mm	HDPE	Luer	Screw	2644038
5.0 mL	H	60 mm	HDPE	Luer	Screw	2644058
10.0 mL	H	60 mm	HDPE	Luer	Screw	2644078

Automatic Liquid Handling - Stroke 60 mm

ADJUSTABLE INTERNAL STOPPER

TLL PTFE Luer Lock

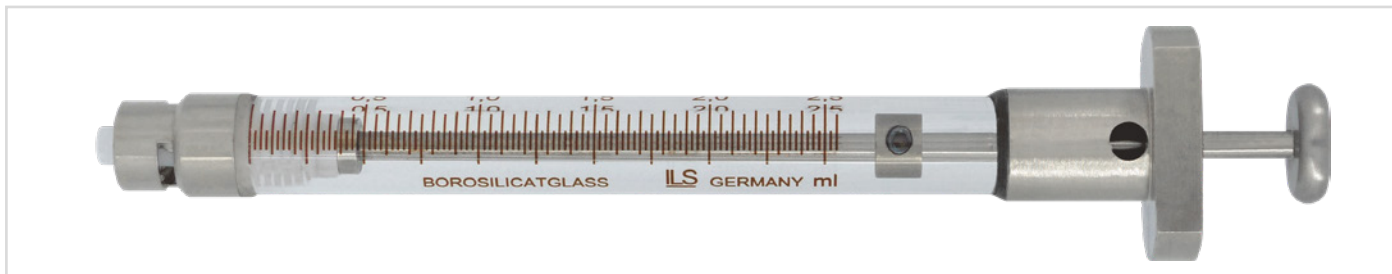

TECHNICAL INFORMATION

Main usage:

- Excellent for routine dosages
- Internal index stop is adjustable to any volume
- For faster work and better reproducibility

Glass Barrel: Borosilicate 3.3

Volume	Plunger Tip	Part No.
1.0 mL	PTFE	2614011
2.5 mL	PTFE	2614031
5.0 mL	PTFE	2614051
10.0 mL	PTFE	2614071
100.0 mL	PTFE	2614101

TLT PTFE Luer Tip

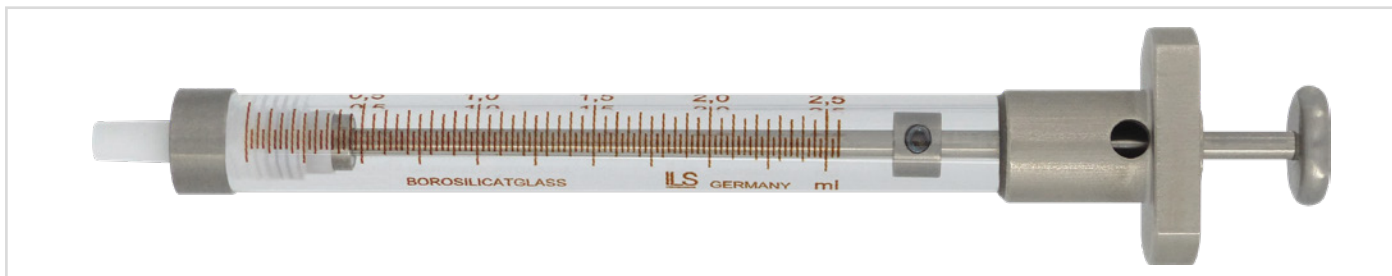

TECHNICAL INFORMATION

Main usage:

- Excellent for routine dosages
- Internal index stop is adjustable to any volume
- For faster work and better reproducibility

Glass Barrel: Borosilicate 3.3

Volume	Plunger Tip	Part No.
2.5 mL	PTFE	2614034
5.0 mL	PTFE	2614054
10.0 mL	PTFE	2614074

Automatic Liquid Handling - Stroke 60 mm

DX

Hamilton* Microlab / 400 / 500 / 900 / M / Serial Dilutor

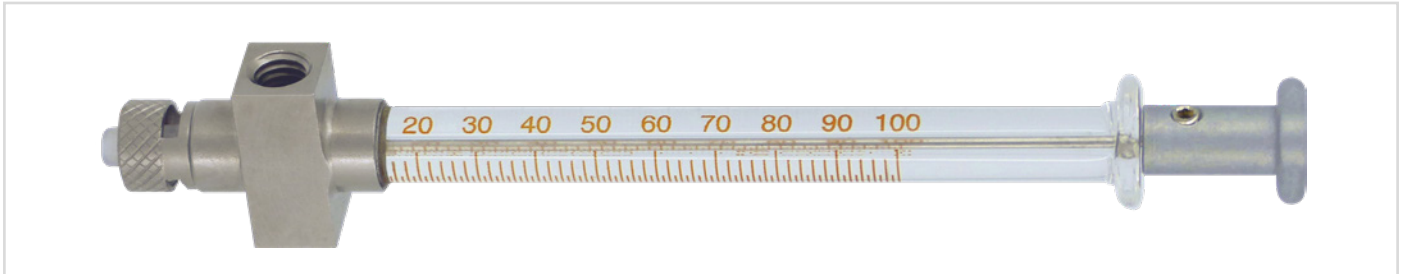

TECHNICAL INFORMATION

Side Connection: M6x1

Glass Barrel: Borosilicate 3.3

PTFE-Seal

Volume	Series	Stroke	Plunger Tip	Front Fitting	Plunger Top	Part No.
25 µL	H	60 mm	PTFE	Luer	6-32 UNC	2607516
50 µL	H	60 mm	PTFE	Luer	6-32 UNC	2607616
100 µL	H	60 mm	PTFE	Luer	6-32 UNC	2607716
250 µL	H	60 mm	PTFE	Luer	6-32 UNC	2607816
500 µL	H	60 mm	PTFE	Luer	6-32 UNC	2607916
1.0 mL	H	60 mm	PTFE	Luer	6-32 UNC	2607016

PTFE-Seal with Silicone

Volume	Series	Stroke	Plunger Tip	Front Fitting	Plunger Top	Part No.
25 µL	H	60 mm	Silicone	Luer	6-32 UNC	2627517
50 µL	H	60 mm	Silicone	Luer	6-32 UNC	2627617
100 µL	H	60 mm	Silicone	Luer	6-32 UNC	2627717
250 µL	H	60 mm	Silicone	Luer	6-32 UNC	2627817
500 µL	H	60 mm	Silicone	Luer	6-32 UNC	2627917
1.0 mL	H	60 mm	Silicone	Luer	6-32 UNC	2627017

HDPE-Seal

Volume	Series	Stroke	Plunger Tip	Front Fitting	Plunger Top	Part No.
50 µL	H	60 mm	PTFE	Luer	6-32 UNC	2627618
100 µL	H	60 mm	PTFE	Luer	6-32 UNC	2627718
250 µL	H	60 mm	PTFE	Luer	6-32 UNC	2627818
500 µL	H	60 mm	PTFE	Luer	6-32 UNC	2627918
1.0 mL	H	60 mm	PTFE	Luer	6-32 UNC	2627018

Automatic Liquid Handling - Stroke 60 mm

ABBOTT* CELL-DYN**

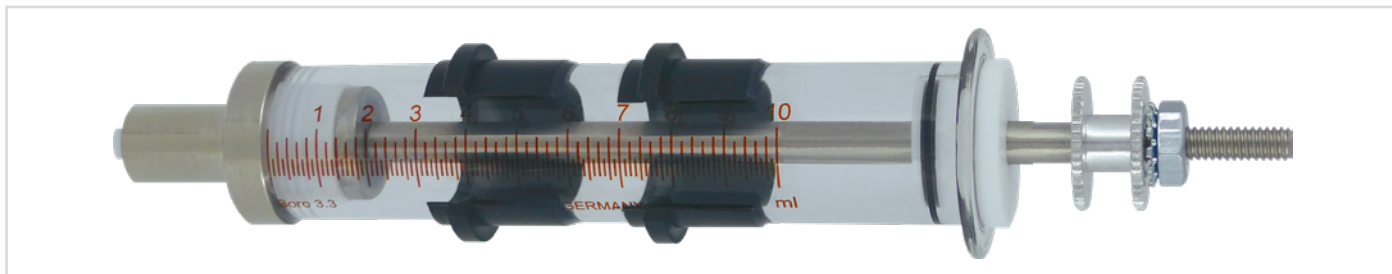

TECHNICAL INFORMATION

Glass Barrel: Borosilicate 3.3

PTFE-Seal

Volume	Stroke	Plunger Tip	Front Fitting	Part No.
10.0 mL	60 mm	PTFE	TLL	2607081

*All other trademarks, service marks, registered trademarks, and registered service marks are the property of their respective owners. Gardner Denver and ILS are not affiliated with Abbott in any way.
**CELL-DYN is a registered trademark of Abbott Laboratories, USA.

Automatic Liquid Handling - Stroke 60 mm

ZYMARK INSTRUMENTS*



TECHNICAL INFORMATION

Glass Barrel: Borosilicate 3.3

PTFE-Seal

Volume	Stroke	Plunger Tip	Front Fitting	Part No.
10.0 mL	60 mm	PTFE	Luer	2607080

Automatic Liquid Handling - Stroke 60 mm

C

Hamilton* Microlab 500



TECHNICAL INFORMATION

Glass Barrel: Borosilicate 3.3

PTFE-Seal

Volume	Series	Stroke	Plunger Tip	Front Fitting	Plunger Top	Part No.
10 µL	H	54 mm	PTFE	1/4"-28 UNF	-	2606414
25 µL	H	60 mm	PTFE	1/4"-28 UNF	-	2606514
50 µL	H	60 mm	PTFE	1/4"-28 UNF	-	2606614
100 µL	H	60 mm	PTFE	1/4"-28 UNF	-	2606714
250 µL	H	60 mm	PTFE	1/4"-28 UNF	-	2606814
500 µL	H	60 mm	PTFE	1/4"-28 UNF	-	2606914
1.0 mL	H	60 mm	PTFE	1/4"-28 UNF	6-32 UNC	2606015
2.5 mL	H	60 mm	PTFE	1/4"-28 UNF	6-32 UNC	2606035
5.0 mL	H	60 mm	PTFE	1/4"-28 UNF	6-32 UNC	2606055
10.0 mL	H	60 mm	PTFE	1/4"-28 UNF	6-32 UNC	2606075
25.0 mL	H	60 mm	PTFE	1/4"-28 UNF	6-32 UNC	2606095

PTFE-Seal with Silicone

Volume	Series	Stroke	Plunger Tip	Front Fitting	Plunger Top	Part No.
25 µL	H	60 mm	Silicone	1/4"-28 UNF	-	2606517
50 µL	H	60 mm	Silicone	1/4"-28 UNF	-	2606617
100 µL	H	60 mm	Silicone	1/4"-28 UNF	-	2606717
250 µL	H	60 mm	Silicone	1/4"-28 UNF	-	2606817
500 µL	H	60 mm	Silicone	1/4"-28 UNF	-	2606917
1.0 mL	H	60 mm	Silicone	1/4"-28 UNF	6-32 UNC	2606017
2.5 mL	H	60 mm	Silicone	1/4"-28 UNF	6-32 UNC	2606037
5.0 mL	H	60 mm	Silicone	1/4"-28 UNF	6-32 UNC	2606057
10.0 mL	H	60 mm	Silicone	1/4"-28 UNF	6-32 UNC	2606077

HDPE-Seal

Volume	Series	Stroke	Plunger Tip	Front Fitting	Plunger Top	Part No.
50 µL	H	60 mm	HDPE	1/4"-28 UNF	-	2606618
100 µL	H	60 mm	HDPE	1/4"-28 UNF	-	2606718
250 µL	H	60 mm	HDPE	1/4"-28 UNF	-	2606818
500 µL	H	60 mm	HDPE	1/4"-28 UNF	-	2606918
1.0 mL	H	60 mm	HDPE	1/4"-28 UNF	6-32 UNC	2606018
2.5 mL	H	60 mm	HDPE	1/4"-28 UNF	6-32 UNC	2606038
5.0 mL	H	60 mm	HDPE	1/4"-28 UNF	6-32 UNC	2606058
10.0 mL	H	60 mm	HDPE	1/4"-28 UNF	6-32 UNC	2606078

*All other trademarks, service marks, registered trademarks, and registered service marks are the property of their respective owners. Gardner Denver and ILS are not affiliated with Hamilton in any way.

Automatic Liquid Handling - Stroke 60 mm

CX

Hamilton* Microlab 500 / 900



TECHNICAL INFORMATION

Glass Barrel: Borosilicate 3.3

PTFE-Seal

Volume	Series	Stroke	Plunger Tip	Front Fitting	Plunger Top	Part No.
10 µL	H	54 mm	PTFE	1/4"-28 UNF	6-32 UNC	2606415
25 µL	H	60 mm	PTFE	1/4"-28 UNF	6-32 UNC	2606515
50 µL	H	60 mm	PTFE	1/4"-28 UNF	6-32 UNC	2606615
100 µL	H	60 mm	PTFE	1/4"-28 UNF	6-32 UNC	2606715
250 µL	H	60 mm	PTFE	1/4"-28 UNF	6-32 UNC	2606815
500 µL	H	60 mm	PTFE	1/4"-28 UNF	6-32 UNC	2606915

PTFE-Seal with Silicone

Volume	Series	Stroke	Plunger Tip	Front Fitting	Plunger Top	Part No.
25 µL	H	60 mm	Silicone	1/4"-28 UNF	6-32 UNC	2606527
50 µL	H	60 mm	Silicone	1/4"-28 UNF	6-32 UNC	2606627
100 µL	H	60 mm	Silicone	1/4"-28 UNF	6-32 UNC	2606727
250 µL	H	60 mm	Silicone	1/4"-28 UNF	6-32 UNC	2606827
500 µL	H	60 mm	Silicone	1/4"-28 UNF	6-32 UNC	2606927

HDPE-Seal

Volume	Series	Stroke	Plunger Tip	Front Fitting	Plunger Top	Part No.
50 µL	H	60 mm	HDPE	1/4"-28 UNF	6-32 UNC	2606628
100 µL	H	60 mm	HDPE	1/4"-28 UNF	6-32 UNC	2606728
250 µL	H	60 mm	HDPE	1/4"-28 UNF	6-32 UNC	2606828
500 µL	H	60 mm	HDPE	1/4"-28 UNF	6-32 UNC	2606928

Automatic Liquid Handling - Stroke 60 mm

H-KP

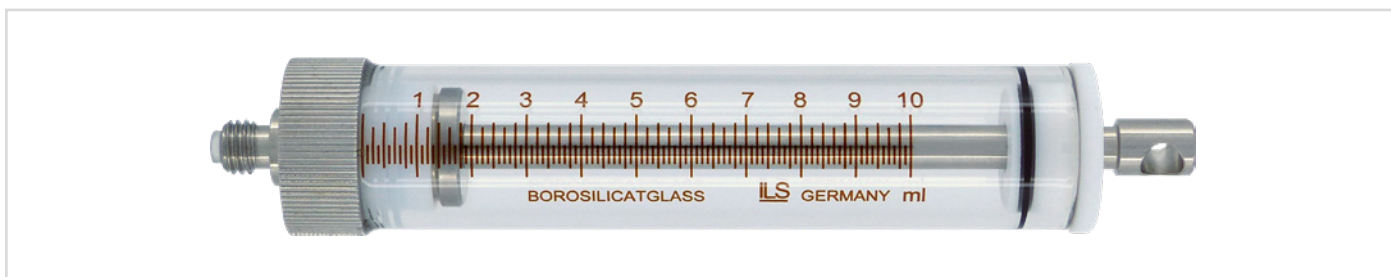

TECHNICAL INFORMATION

Glass Barrel: Borosilicate 3.3

PTFE-Seal

Volume	Series	Stroke	Plunger Tip	Front Fitting	Part No.
25 µL	H	60 mm	PTFE	1/4"-28 UNF	2608515
50 µL	H	60 mm	PTFE	1/4"-28 UNF	2608615
100 µL	H	60 mm	PTFE	1/4"-28 UNF	2608715
250 µL	H	60 mm	PTFE	1/4"-28 UNF	2608815
500 µL	H	60 mm	PTFE	1/4"-28 UNF	2608915
1.0 mL	H	60 mm	PTFE	1/4"-28 UNF	2608015
1.25 mL	H	60 mm	PTFE	1/4"-28 UNF	2608125
2.5 mL	H	60 mm	PTFE	1/4"-28 UNF	2608035
5.0 mL	H	60 mm	PTFE	1/4"-28 UNF	2608055
10.0 mL	H	60 mm	PTFE	1/4"-28 UNF	2608075
25.0 mL	H	60 mm	PTFE	1/4"-28 UNF	2608091
50.0 mL	H	60 mm	PTFE	1/4"-28 UNF	2608105

HDPE-Seal

Volume	Series	Stroke	Plunger Tip	Front Fitting	Part No.
25 µL	H	60 mm	HDPE	1/4"-28 UNF	2608516
50 µL	H	60 mm	HDPE	1/4"-28 UNF	2608616
100 µL	H	60 mm	HDPE	1/4"-28 UNF	2608716
250 µL	H	60 mm	HDPE	1/4"-28 UNF	2608816
500 µL	H	60 mm	HDPE	1/4"-28 UNF	2608916
1.0 mL	H	60 mm	HDPE	1/4"-28 UNF	2608016
2.5 mL	H	60 mm	HDPE	1/4"-28 UNF	2608036
5.0 mL	H	60 mm	HDPE	1/4"-28 UNF	2608056
10.0 mL	H	60 mm	HDPE	1/4"-28 UNF	2608076
25.0 mL	H	60 mm	HDPE	1/4"-28 UNF	2608096

Automatic Liquid Handling - Stroke 60 mm

XLP

Cavro® XLP Modular syringe pump



TECHNICAL INFORMATION

Glass Barrel: Borosilicate 3.3

PTFE-Seal

Volume	Series	Stroke	Plunger Tip	Front Fitting	Part No.
50 µL	H	60 mm	PTFE	1/4"-28 UNF	2679611
100 µL	H	60 mm	PTFE	1/4"-28 UNF	2679711
250 µL	H	60 mm	PTFE	1/4"-28 UNF	2679811
500 µL	H	60 mm	PTFE	1/4"-28 UNF	2679911
1.0 mL	H	60 mm	PTFE	1/4"-28 UNF	2679011
2.5 mL	H	60 mm	PTFE	1/4"-28 UNF	2679031
5.0 mL	H	60 mm	PTFE	1/4"-28 UNF	2679051
10.0 mL	H	60 mm	PTFE	1/4"-28 UNF	2679071
25.0 mL	H	60 mm	PTFE	1/4"-28 UNF	2679091
50.0 mL	H	60 mm	PTFE	1/4"-28 UNF	2679101

HDPE-Seal

Volume	Series	Stroke	Plunger Tip	Front Fitting	Part No.
50 µL	H	60 mm	HDPE	1/4"-28 UNF	2679613
100 µL	H	60 mm	HDPE	1/4"-28 UNF	2679713
250 µL	H	60 mm	HDPE	1/4"-28 UNF	2679813
500 µL	H	60 mm	HDPE	1/4"-28 UNF	2679913
1.0 mL	H	60 mm	HDPE	1/4"-28 UNF	2679015
2.5 mL	H	60 mm	HDPE	1/4"-28 UNF	2679035
5.0 mL	H	60 mm	HDPE	1/4"-28 UNF	2679055
10.0 mL	H	60 mm	HDPE	1/4"-28 UNF	2679075
25.0 mL	H	60 mm	HDPE	1/4"-28 UNF	2679095

Automatic Liquid Handling - Stroke 60 mm

DIONEX* AS



TECHNICAL INFORMATION

Glass Barrel: Borosilicate 3.3

PTFE-Seal

Volume	Stroke	Plunger Tip	Front Fitting	Part No.
25 µL	60 mm	PTFE	1/4"-28 UNF	2608525
50 µL	60 mm	PTFE	1/4"-28 UNF	2608625
100 µL	60 mm	PTFE	1/4"-28 UNF	2608725
250 µL	60 mm	PTFE	1/4"-28 UNF	2608825
500 µL	60 mm	PTFE	1/4"-28 UNF	2608925
1.0 mL	60 mm	PTFE	1/4"-28 UNF	2608025

HDPE-Seal

Volume	Stroke	Plunger Tip	Front Fitting	Part No.
25 µL	60 mm	HDPE	1/4"-28 UNF	2608527
50 µL	60 mm	HDPE	1/4"-28 UNF	2608627
100 µL	60 mm	HDPE	1/4"-28 UNF	2608727
250 µL	60 mm	HDPE	1/4"-28 UNF	2608827
500 µL	60 mm	HDPE	1/4"-28 UNF	2608927
1.0 mL	60 mm	HDPE	1/4"-28 UNF	2608027

Automatic Liquid Handling - Stroke 60 mm

ABI* PRISM 3100

ABI* 3100 Genetic Analyzer

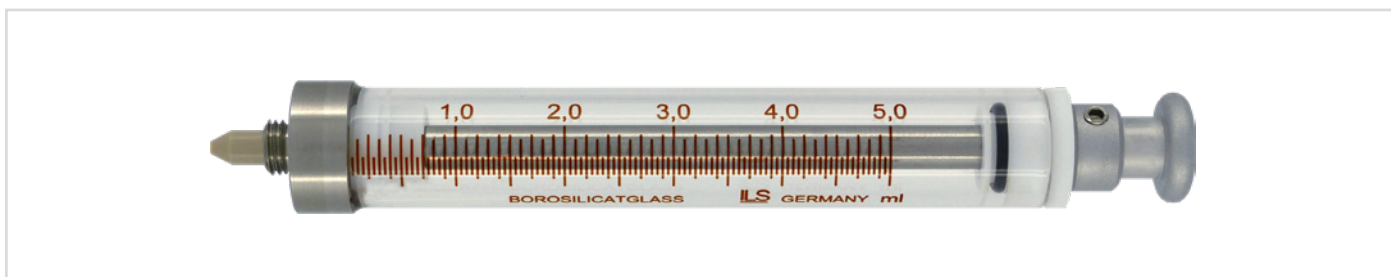

TECHNICAL INFORMATION

Glass Barrel: Borosilicate 3.3

Fitting w/o insert

Volume	Plunger Tip	Front Fitting	Part No.
250 µL	PTFE	1/4"-32 UNEF w/o insert	2618811
500 µL	PTFE	1/4"-32 UNEF w/o insert	2618911
1.0 mL	PTFE	1/4"-32 UNEF w/o insert	2618011
5.0 mL	PTFE	1/4"-32 UNEF w/o insert	2618051

Fitting with insert

Volume	Plunger Tip	Front Fitting	Part No.
250 µL	PTFE	1/4"-32 UNEF with insert	2618812
500 µL	PTFE	1/4"-32 UNEF with insert	2618912
1.0 mL	PTFE	1/4"-32 UNEF with insert	2618012
5.0 mL	PTFE	1/4"-32 UNEF with insert	2618052
10.0 mL	PTFE	1/4"-32 UNEF with insert	2618081

Automatic Liquid Handling - Stroke 60 mm

INNOVADYNE* NANODROP**



TECHNICAL INFORMATION

Glass Barrel: Borosilicate 3.3

Volume	Stroke	Series	Plunger Tip	Front Fitting	Part No.
100 µL	60 mm	H	PTFE	1/4\"-28 UNF with hex	2623717
250 µL	60 mm	H	PTFE	1/4\"-28 UNF with hex	2623817
500 µL	60 mm	H	PTFE	1/4\"-28 UNF with hex	2623917
1.0 mL	60 mm	H	PTFE	1/4\"-28 UNF with hex	2623017
2.5 mL	60 mm	H	PTFE	1/4\"-28 UNF with knurl	2623035
5.0 mL	60 mm	H	PTFE	1/4\"-28 UNF with knurl	2623054

*All other trademarks, service marks, registered trademarks, and registered service marks are the property of their respective owners. Gardner Denver and ILS are not affiliated with Innovadyne in any way.

**Nanodrop is a trademark of Innovadyne.

Automatic Liquid Handling - Stroke 60 mm

KLOEHN* DRIVE MODULE 503000

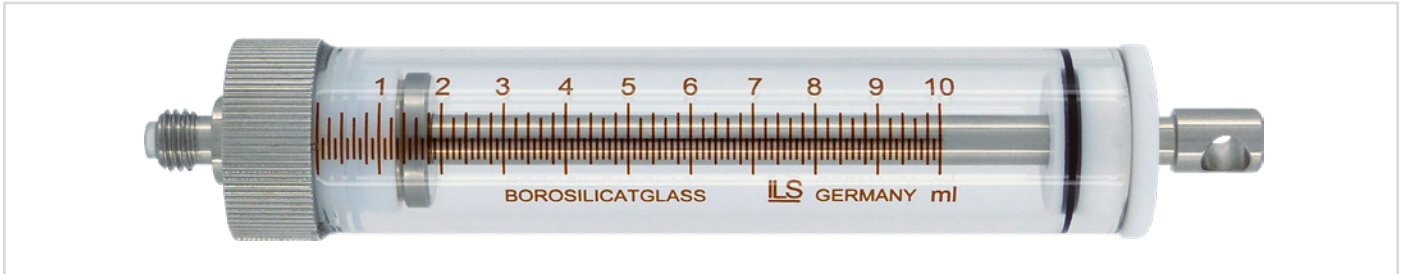

TECHNICAL INFORMATION

Glass Barrel: Borosilicate 3.3

PTFE-Seal

Volume	Stroke	Plunger Tip	Part No.
25 µL	60 mm	PTFE	2608515
50 µL	60 mm	PTFE	2608615
100 µL	60 mm	PTFE	2608715
250 µL	60 mm	PTFE	2608815
500 µL	60 mm	PTFE	2608915
1.0 mL	60 mm	PTFE	2608015
2.5 mL	60 mm	PTFE	2608035
5.0 mL	60 mm	PTFE	2608055
10.0 mL	60 mm	PTFE	2608075
25.0 mL	60 mm	PTFE	2608091

HDPE-Seal

Volume	Stroke	Plunger Tip	Part No.
25 µL	60 mm	HDPE	2608516
50 µL	60 mm	HDPE	2608616
100 µL	60 mm	HDPE	2608716
250 µL	60 mm	HDPE	2608816
500 µL	60 mm	HDPE	2608916
1.0 mL	60 mm	HDPE	2608016
2.5 mL	60 mm	HDPE	2608036
5.0 mL	60 mm	HDPE	2608056
10.0 mL	60 mm	HDPE	2608076

Automatic Liquid Handling - Stroke 60 mm

AD

CGA* EPOS / EASY / ERIS, Roche* Midias



TECHNICAL INFORMATION

Glass Barrel: Borosilicate 3.3

PTFE-Seal

Volume	Series	Stroke	Plunger Tip	Front Fitting	Part No.
50 µL	H	60 mm	PTFE	M8x0.75	2605613
100 µL	H	60 mm	PTFE	M8x0.75	2605713
250 µL	H	60 mm	PTFE	M8x0.75	2605813
500 µL	H	60 mm	PTFE	M8x0.75	2605913
1.0 mL	H	60 mm	PTFE	M8x0.75	2605014
2.5 mL	H	60 mm	PTFE	M8x0.75	2605034
5.0 mL	H	60 mm	PTFE	M8x0.75	2605054
10.0 mL	H	60 mm	PTFE	M8x0.75	2605074
25.0 mL	H	60 mm	PTFE	M8x0.75	2605094

PTFE-Seal with Silicone

Volume	Series	Stroke	Plunger Tip	Front Fitting	Part No.
50 µL	H	60 mm	Silicone	M8x0.75	2605617
100 µL	H	60 mm	Silicone	M8x0.75	2605717
250 µL	H	60 mm	Silicone	M8x0.75	2605817
500 µL	H	60 mm	Silicone	M8x0.75	2605917
1.0 mL	H	60 mm	Silicone	M8x0.75	2605017
2.5 mL	H	60 mm	Silicone	M8x0.75	2605037
5.0 mL	H	60 mm	Silicone	M8x0.75	2605057
10.0 mL	H	60 mm	Silicone	M8x0.75	2605077

HDPE-Seal

Volume	Series	Stroke	Plunger Tip	Front Fitting	Part No.
50 µL	H	60 mm	HDPE	M8x0.75	2605618
100 µL	H	60 mm	HDPE	M8x0.75	2605718
250 µL	H	60 mm	HDPE	M8x0.75	2605818
500 µL	H	60 mm	HDPE	M8x0.75	2605918
1.0 mL	H	60 mm	HDPE	M8x0.75	2605018
2.5 mL	H	60 mm	HDPE	M8x0.75	2605038
5.0 mL	H	60 mm	HDPE	M8x0.75	2605058
10.0 mL	H	60 mm	HDPE	M8x0.75	2605078

*All other trademarks, service marks, registered trademarks, and registered service marks are the property of their respective owners. Gardner Denver and ILS are not affiliated with CGA and Roche in any way.

Automatic Liquid Handling - Stroke 60 mm

DAD

DAD = Diluter ACCUDIL

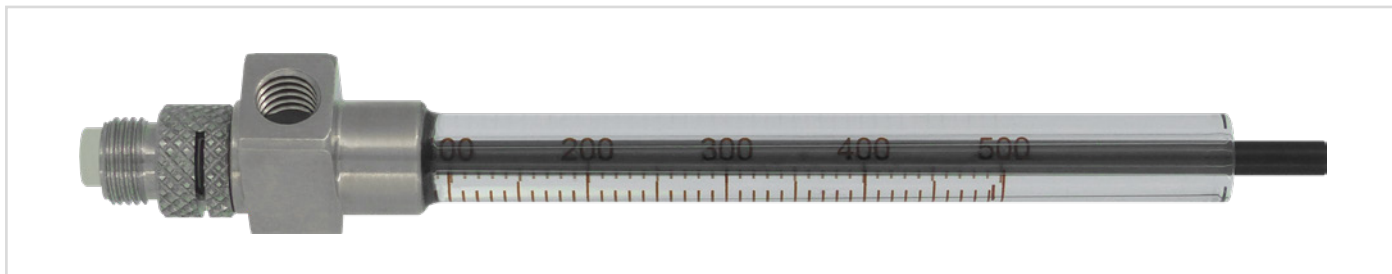

TECHNICAL INFORMATION

Side Connection: M6x1

Glass Barrel: Borosilicate 3.3

PTFE-Seal

Volume	Series	Stroke	Plunger Tip	Front Fitting	Plunger Top	Part No.
50 µL	H	60 mm	PTFE	M8x0.75	6-32 UNC	2607618
100 µL	H	60 mm	PTFE	M8x0.75	6-32 UNC	2607718
250 µL	H	60 mm	PTFE	M8x0.75	6-32 UNC	2607818
500 µL	H	60 mm	PTFE	M8x0.75	6-32 UNC	2607918
1.0 mL	H	60 mm	PTFE	M8x0.75	6-32 UNC	2607018
2.5 mL	H	60 mm	PTFE	M8x0.75	6-32 UNC	2607038

HDPE-Seal

Volume	Series	Stroke	Plunger Tip	Front Fitting	Plunger Top	Part No.
50 µL	H	60 mm	HDPE	M8x0.75	6-32 UNC	2626618
100 µL	H	60 mm	HDPE	M8x0.75	6-32 UNC	2626718
250 µL	H	60 mm	HDPE	M8x0.75	6-32 UNC	2626818
500 µL	H	60 mm	HDPE	M8x0.75	6-32 UNC	2626918
1.0 mL	H	60 mm	HDPE	M8x0.75	6-32 UNC	2626018
2.5 mL	H	60 mm	HDPE	M8x0.75	6-32 UNC	2626038

PTFE-Seal with Silicone

Volume	Series	Stroke	Plunger Tip	Front Fitting	Plunger Top	Part No.
50 µL	H	60 mm	Silicone	M8x0.75	6-32 UNC	2626617
100 µL	H	60 mm	Silicone	M8x0.75	6-32 UNC	2626717
250 µL	H	60 mm	Silicone	M8x0.75	6-32 UNC	2626817
500 µL	H	60 mm	Silicone	M8x0.75	6-32 UNC	2626917
1.0 mL	H	60 mm	Silicone	M8x0.75	6-32 UNC	2626017
2.5 mL	H	60 mm	Silicone	M8x0.75	6-32 UNC	2626037

Automatic Liquid Handling - Stroke 60 mm

SELECTRA*



TECHNICAL INFORMATION

Glass Barrel: Borosilicate 3.3

Volume	Stroke	Series	Plunger Tip	Front Fitting	Part No.
100 µL	60 mm	H	PTFE	M8x0.75	2605714
250 µL	60 mm	H	PTFE	M8x0.75	2605814
500 µL	60 mm	H	PTFE	M8x0.75	2605914
1.0 mL	60 mm	H	PTFE	M8x0.75	2605013

Automatic Liquid Handling - Stroke 60 mm

VARIAN*



TECHNICAL INFORMATION

Glass Barrel: Borosilicate 3.3

PTFE-Seal

Volume	Stroke	Series	Plunger Tip	Front Fitting	Part No.
100 µL	60 mm	H	PTFE	M8x1	2607706

Automatic Liquid Handling - Stroke 60 mm

GILSON* 401

Gilson* syringe pump 401



TECHNICAL INFORMATION

Glass Barrel: Borosilicate 3.3

PTFE-Seal

Volume	Series	Stroke	Plunger Tip	Front Fitting	Plunger Top	Part No.
500 µL	H	60 mm	PTFE	M10	Screw	2629911
1.0 mL	H	60 mm	PTFE	M10	Screw	2629013
5.0 mL	H	60 mm	PTFE	M10	Screw	2629053
10.0 mL	H	60 mm	PTFE	M10	Screw	2629073

Automatic Liquid Handling - Stroke 60 mm

GILSON* 402 / 406

Gilson* syringe pump 402 / 406



TECHNICAL INFORMATION

Glass Barrel: Borosilicate 3.3

PTFE-Seal

Volume	Series	Stroke	Plunger Tip	Front Fitting	Plunger Top	Part No.
100 µL	H	60 mm	PTFE	M10	Thread M4	2629710
250 µL	H	60 mm	PTFE	M10	Thread M4	2629810
500 µL	H	60 mm	PTFE	M10	Thread M4	2629910
1.0 mL	H	60 mm	PTFE	M10	Thread M4	2629015
2.5 mL	H	60 mm	PTFE	M10	Thread M4	2629031
5.0 mL	H	60 mm	PTFE	M10	Thread M4	2629051
10.0 mL	H	60 mm	PTFE	M10	Thread M4	2629071
25.0 mL	H	60 mm	PTFE	M10	Thread M4	2629091

Automatic Liquid Handling - Stroke 60 mm

KONE* / THERMO* INSTRUMENTS

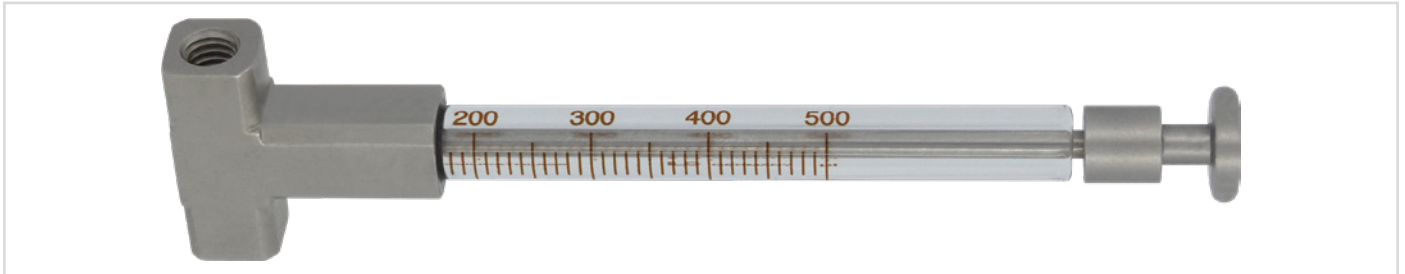

TECHNICAL INFORMATION

Glass Barrel: Borosilicate 3.3

M6

Volume	Stroke	Connection	Plunger Tip	Part No.
500 µL	60 mm	M6	PTFE	2612903

M8x1

Volume	Stroke	Connection	Plunger Tip	Part No.
25 µL	60 mm	M8x1	PTFE	2612502
50 µL	60 mm	M8x1	PTFE	2612602
100 µL	60 mm	M8x1	PTFE	2612702
250 µL	60 mm	M8x1	PTFE	2612802
500 µL	60 mm	M8x1	PTFE	2612902
1.0 mL	60 mm	M8x1	PTFE	2612001

Automatic Liquid Handling - Stroke 60 mm

TUBING CONNECTOR



TECHNICAL INFORMATION

Advantages:

- Direct connection
- Reduced dead volume
- PEEK Connector, no metal contact
- Fits any tube from \varnothing 0,8 mm to \varnothing 3,2 mm
- Chemically inert

Glass Barrel: Borosilicate 3.3

PTFE-Seal

Volume	Stroke	Plunger Tip	Connector	Part No.	Connector	Part No.
			PEEK		PEEK	
10 μ L	54 mm	PTFE	M6	2624414	1/4" - 28	2624415
25 μ L	60 mm	PTFE	M6	2624514	1/4" - 28	2624515
50 μ L	60 mm	PTFE	M6	2624614	1/4" - 28	2624615
100 μ L	60 mm	PTFE	M6	2624714	1/4" - 28	2624715
250 μ L	60 mm	PTFE	M6	2624814	1/4" - 28	2624815
500 μ L	60 mm	PTFE	M6	2624914	1/4" - 28	2624915
1.0 mL	60 mm	PTFE	M6	2624015	1/4" - 28	2624016
2.5 mL	60 mm	PTFE	M6	2624035	1/4" - 28	2624036
5.0 mL	60 mm	PTFE	M6	2624055	1/4" - 28	2624056
10.0 mL	60 mm	PTFE	M6	2624075	1/4" - 28	2624076
25.0 mL	60 mm	PTFE	M6	2624095	1/4" - 28	2624096
50.0 mL	60 mm	PTFE	M6	2624101	1/4" - 28	2624102

Volume	Stroke	Plunger Tip	Connector	Part No.	Connector	Part No.
			Aluminium		Aluminium	
50.0 mL	60 mm	PTFE	M6	2624105	1/4" - 28	2624106
100.0 mL	120 mm	PTFE	M6	2624116	1/4" - 28	2624115

HDPE-Seal

Volume	Stroke	Plunger Tip	Connector	Part No.	Connector	Part No.
			PEEK		PEEK	
10 μ L	54 mm	HDPE	M6	-	1/4" - 28	-
25 μ L	60 mm	HDPE	M6	-	1/4" - 28	-
50 μ L	60 mm	HDPE	M6	-	1/4" - 28	-
100 μ L	60 mm	HDPE	M6	2624718	1/4" - 28	2624719
250 μ L	60 mm	HDPE	M6	2624818	1/4" - 28	2624819
500 μ L	60 mm	HDPE	M6	2624918	1/4" - 28	2624917
1.0 mL	60 mm	HDPE	M6	-	1/4" - 28	2624017
2.5 mL	60 mm	HDPE	M6	-	1/4" - 28	2624037
5.0 mL	60 mm	HDPE	M6	-	1/4" - 28	2624059
10.0 mL	60 mm	HDPE	M6	-	1/4" - 28	2624080
25.0 mL	60 mm	HDPE	M6	-	1/4" - 28	2624098

Automatic Liquid Handling - Stroke 60 mm

HPLC TUBING CONNECTOR



TECHNICAL INFORMATION

Advantages:

- Direct connection with HPLC 10-32 cone fitting
- Reduced dead volume
- PEEK Connector totally inert, no metal contact
- Fits any tube from \varnothing 0,8 mm to \varnothing 3,2 mm
- Chemically resistant

Glass Barrel: Borosilicate 3.3

PTFE-Seal

Volume	Plunger Tip	Front Fitting	Part No.
250 μ L	PTFE	10-32 cone	2624812
500 μ L	PTFE	10-32 cone	2624919

HDPE-Seal

Volume	Plunger Tip	Front Fitting	Part No.
250 μ L	HDPE	10-32 cone	2624813
500 μ L	HDPE	10-32 cone	2624913
1.0 mL	HDPE	10-32 cone	2624013

OVERVIEW

SYRINGES FOR INFUSION PUMPS

TLL Pump	53
Tubing Connector	54

Automatic Liquid Handling - Syringes for Infusion Pumps

TLL PUMP



TECHNICAL INFORMATION

Glass Barrel: Borosilicate 3.3

PTFE-Seal

Volume	Series	Stroke	Plunger Tip	Front Fitting	Part No.
50 µL	H	60 mm	PTFE	Luer	2607608
100 µL	H	60 mm	PTFE	Luer	2607702
250 µL	H	60 mm	PTFE	Luer	2607808
500 µL	H	60 mm	PTFE	Luer	2607906
1.0 mL	H	60 mm	PTFE	Luer	2607003
2.5 mL	H	60 mm	PTFE	Luer	2607032
5.0 mL	H	60 mm	PTFE	Luer	2607046
10.0 mL	H	60 mm	PTFE	Luer	2607224
25.0 mL	H	60 mm	PTFE	Luer	2607128
50.0 mL	H	60 mm	PTFE	Luer	2607126
100.0 mL	H	120 mm	PTFE	Luer	2607127

Automatic Liquid Handling - Syringes for Infusion Pumps

TUBING CONNECTOR



TECHNICAL INFORMATION

Glass Barrel: Borosilicate 3.3

PTFE-Seal

Volume	Series	Stroke	Plunger Tip	Front Fitting	Part No.
50 µL	H	60 mm	PTFE	Female 1/4"-28 UNF	2624615
100 µL	H	60 mm	PTFE	Female 1/4"-28 UNF	2624715
250 µL	H	60 mm	PTFE	Female 1/4"-28 UNF	2624815
500 µL	H	60 mm	PTFE	Female 1/4"-28 UNF	2624915
1.0 mL	H	60 mm	PTFE	Female 1/4"-28 UNF	2624016
2.5 mL	H	60 mm	PTFE	Female 1/4"-28 UNF	2624036
5.0 mL	H	60 mm	PTFE	Female 1/4"-28 UNF	2624056
10.0 mL	H	60 mm	PTFE	Female 1/4"-28 UNF	2624076
25.0 mL	H	60 mm	PTFE	Female 1/4"-28 UNF	2624097
50.0 mL	H	60 mm	PTFE	Female 1/4"-28 UNF	2624109
100.0 mL	H	120 mm	PTFE	Female 1/4"-28 UNF	2624115

OVERVIEW

DOSAGE OF LIQUIDS - SERIES N

Fixed Needles	56
Removable Needles	58
Super Flexible Plunger	60
Series SN	61
Series T	62
Series LT	64
Series TLL	65

Dosage of Liquids - Series N

FIXED NEEDLES

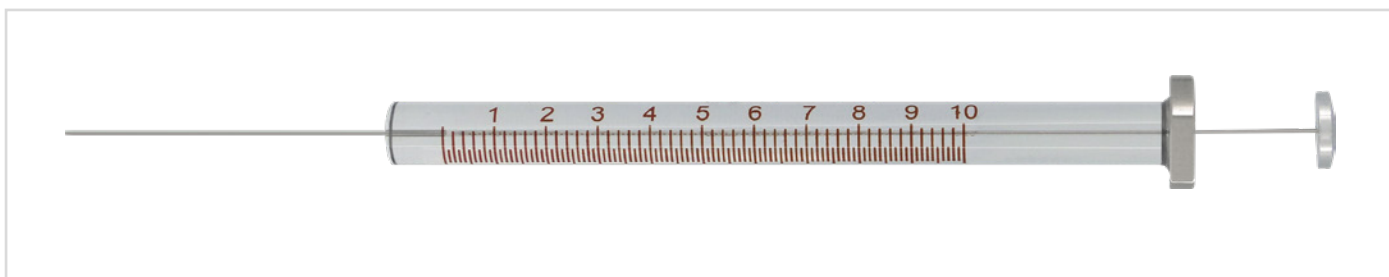
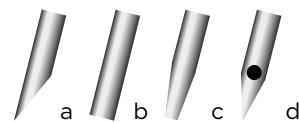

TECHNICAL INFORMATION

Main usage:

- Sample dosage for Gas Chromatography (GC)
- HPLC Valve
- Autosamplers
- Thin Layer Chromatography (TLC)

Glass Barrel: Borosilicate 3.3

Stainless Steel = sst*

Needle Tip			a	a	a	b	c	c	d
			(FN)	(FN)	(FN)	(FN)	(FN)	(FN)	(FN)
Length			51 mm	51 mm	70 mm	51 mm	51 mm	51 mm	51 mm
Volume	Plunger Tip	O.D. (Gauge)	Part No.	Part No.	Part No.	Part No.	Part No.	Part No.	Part No.
				6-Pack				6-Pack	
5 µL	sst*	0.47 (G26s)	2100301	2100311	-	2100302	2100303	2100323	2100304
10 µL	sst*	0.47 (G26s)	2100401	2100411	2100409	2100402	2100403	2100427	2100404
25 µL	sst*	0.72 (G22s)	2100501	-	2100509	2100502	2100503	-	2100504
50 µL	sst*	0.72 (G22s)	2100601	-	2100609	2100602	2100603	-	2100604
100 µL	sst*	0.72 (G22s)	2100701	-	2100709	2100702	2100703	-	2100704
250 µL	sst*	0.72 (G22)	2100801	-	-	2100802	2100803	-	2100804
500 µL	sst*	0.72 (G22)	2100901	-	-	2100902	2100903	-	2100904

Needle Tip		a; b; c;	
Length		Please specify needle tip & length (in mm).	
Volume	Plunger Tip	O.D. (Gauge)	Part No.
5 µL	sst*	0.47 (G26s)	2110300
10 µL	sst*	0.47 (G26s)	2110400
25 µL	sst*	0.72 (G22s)	2110500
50 µL	sst*	0.72 (G22s)	2110600
100 µL	sst*	0.72 (G22s)	2110700
250 µL	sst*	0.72 (G22)	2110800
500 µL	sst*	0.72 (G22)	2110900

Dosage of Liquids - Series N

FIXED NEEDLES

With guide

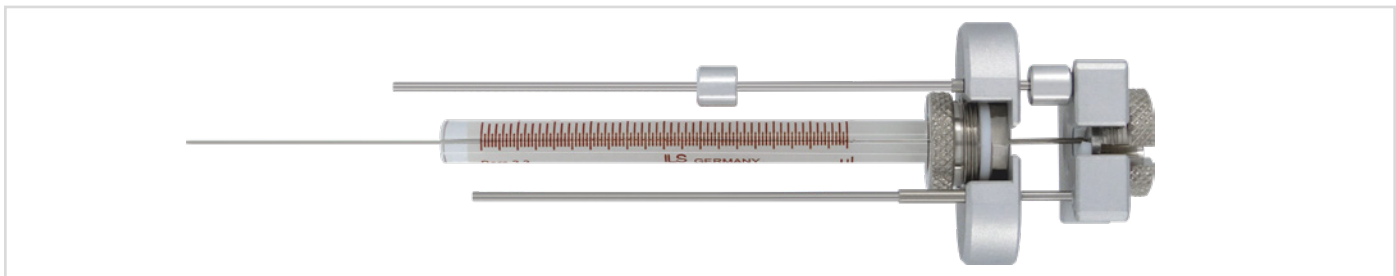

Needle Tip				a
				(FN)
Length				51 mm
Volume	Plunger Tip	O.D. (Gauge)	Part No.	
5 µL	sst*	0.47 (G26s)	2170301	
10 µL	sst*	0.47 (G26s)	2170401	
25 µL	sst*	0.72 (G22s)	2170501	
50 µL	sst*	0.72 (G22s)	2170601	
100 µL	sst*	0.72 (G22s)	2170701	
250 µL	sst*	0.72 (G22)	2170801	
500 µL	sst*	0.72 (G22)	2170901	

Dosage of Liquids - Series N

REMOVABLE NEEDLES

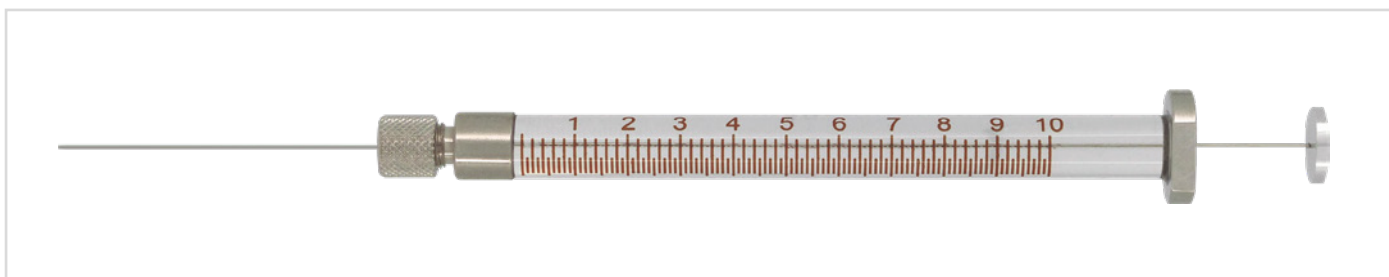
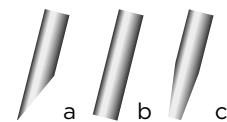

TECHNICAL INFORMATION

Main usage:

- Sample dosage for Gas Chromatography (GC)
- HPLC Valve
- Autosamplers
- Thin Layer Chromatography (TLC)

Glass Barrel: Borosilicate 3.3

Stainless Steel = sst*

Needle Tip			a	a	b	c
			(RN)	(RN)	(RN)	(RN)
Length			51 mm	51 mm	51 mm	51 mm
Volume	Plunger Tip	O.D. (Gauge)	Part No.	Part No.	Part No.	Part No.
				6-Pack		
5 µL	sst*	0.47 (G26s)	2100305	2100305-6P	2100306	2100307
10 µL	sst*	0.47 (G26s)	2100405	2100415	2100406	2100407
25 µL	sst*	0.72 (G22s)	2100505	-	2100506	2100507
50 µL	sst*	0.72 (G22s)	2100605	-	2100606	2100607
100 µL	sst*	0.72 (G22s)	2100705	-	2100706	2100707
250 µL	sst*	0.72 (G22)	2100805	-	2100806	2100807
500 µL	sst*	0.72 (G22)	2100905	-	2100906	2100907

Needle Tip		a; b; c;	
Length		Please specify needle tip & length (in mm).	
Volume	Plunger Tip	O.D. (Gauge)	Part No.
5 µL	sst*	0.47 (G26s)	2110301
10 µL	sst*	0.47 (G26s)	2110401
25 µL	sst*	0.72 (G22s)	2110501
50 µL	sst*	0.72 (G22s)	2110601
100 µL	sst*	0.72 (G22s)	2110701
250 µL	sst*	0.72 (G22)	2110801
500 µL	sst*	0.72 (G22)	2110901

Dosage of Liquids - Series N

REMOVABLE NEEDLES

With guide

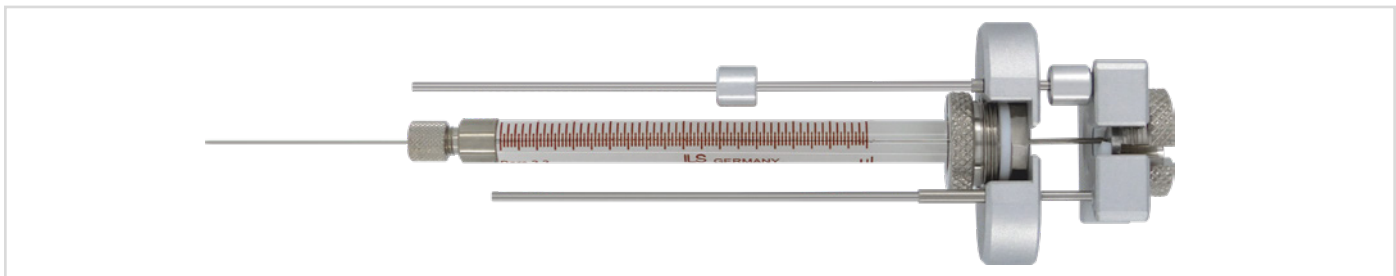

Needle Tip				a
				(RN)
Length				51 mm
Volume	Plunger Tip	O.D. (Gauge)	Guide incl.	
5 µL	sst*	0.47 (G26s)	2170305	
10 µL	sst*	0.47 (G26s)	2170405	
25 µL	sst*	0.72 (G22s)	2170505	
50 µL	sst*	0.72 (G22s)	2170605	
100 µL	sst*	0.72 (G22s)	2170705	
250 µL	sst*	0.72 (G22)	2170805	
500 µL	sst*	0.72 (G22)	2170905	

Dosage of Liquids - Series N

SUPER FLEXIBLE PLUNGER

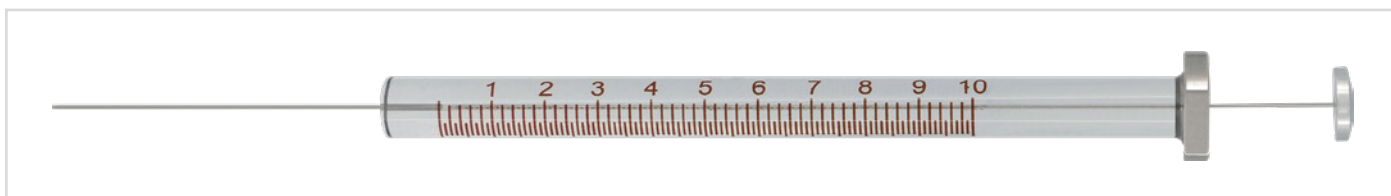
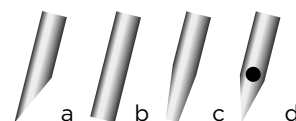

TECHNICAL INFORMATION

Main usage:

- Sample dosage for Gas Chromatography (GC)
- HPLC Valve
- Autosamplers

Plunger:

- Nickel titanium alloy, flexible memory metal

Glass Barrel: Borosilicate 3.3

Fixed Needles (FN)

Removable Needles (RN)

Stainless Steel = sst*

Needle Tip		a	a	b	c	c	d
		(FN)	(FN)	(FN)	(FN)	(FN)	(FN)
Length		51 mm	51 mm	51 mm	51 mm	51 mm	51 mm
Volume	O.D. (Gauge)	Part No.	Part No.	Part No.	Part No.	Part No.	Part No.
			6-Pack			6-Pack	
5 µL	0.47 (G26s)	2160301	2160311	2160302	2160303	-	-
5 µL	0.47 (G26)	-	-	-	-	-	2160304
10 µL	0.47 (G26s)	2160401	2160411	2160402	2160403	2160413	-
10 µL	0.47 (G26)	-	-	-	-	-	2160404

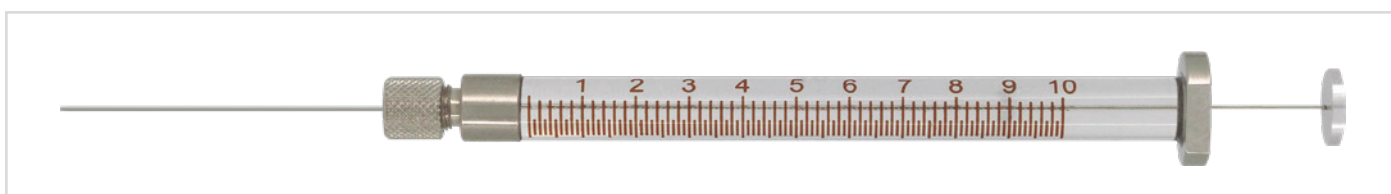

Needle Tip		a	a	b	c	d
		(RN)	(RN)	(RN)	(RN)	(RN)
Length		51 mm	51 mm	51 mm	51 mm	51 mm
Volume	O.D. (Gauge)	Part No.	Part No.	Part No.	Part No.	Part No.
			6-Pack			
5 µL	0.47 (G26s)	2160305	-	2160306	2160307	-
5 µL	0.47 (G26)	-	-	-	-	2160308
10 µL	0.47 (G26s)	2160405	2160415	2160406	2160407	-
10 µL	0.47 (G26)	-	-	-	-	2160408

Dosage of Liquids - Series N

SERIES SN

With Extended Handle

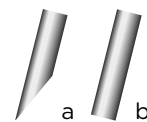

TECHNICAL INFORMATION

Main usage:

- Sample dosage for Gas Chromatography (GC)
- HPLC Valve

Functions:

- Bending is avoided through reinforced plunger
- Prevents transfer of body heat from the hand to contents
- Plunger stop prevents blowout
- Replaceable plunger

Glass Barrel: Borosilicate 3.3

Fixed Needles (FN)

Removable Needles (RN)

Stainless Steel = sst*

Needle Tip			a	b	a	b
			(FN)	(FN)	(RN)	(RN)
Length			51 mm	51 mm	51 mm	51 mm
Volume	Plunger Tip	O.D. (Gauge)	Part No.	Part No.	Part No.	Part No.
5 µL	sst*	0.47 (26s)	2500301	2500302	2500305	2500306
10 µL	sst*	0.47 (26s)	2500401	2500402	2500405	2500406
25 µL	sst*	0.72 (22s)	2500501	2500502	2500505	2500506
50 µL	sst*	0.72 (22s)	2500601	2500602	2500605	2500606
100 µL	sst*	0.72 (22s)	2500701	2500702	2500705	2500706
250 µL	sst*	0.72 (22)	2500801	2500802	2500805	2500806

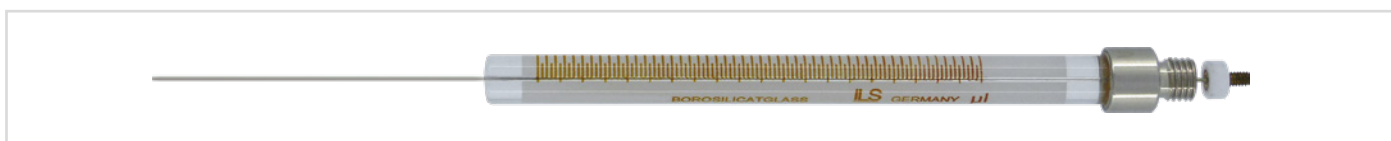

Needle Tip			a; b		a	a
Length					51 mm	51 mm
			Please specify with order: Needle tip & length (in mm)		Replacement Glass Barrel	
			(FN)	(RN)	(FN)	(RN)
Volume	Plunger Tip	O.D. (Gauge)	Part No.	Part No.	Part No.	Part No.
5 µL	sst*	0.47 (G26s)	2510300	2510305	2530301	2530305
10 µL	sst*	0.47 (G26s)	2510400	2510405	2530401	2530405
25 µL	sst*	0.72 (G22s)	2510500	2510505	2530501	2530505
50 µL	sst*	0.72 (G22s)	2510600	2510605	2530601	2530605
100 µL	sst*	0.72 (G22s)	2510700	2510705	2530701	2530705
250 µL	sst*	0.72 (G22)	2510800	2510805	2530801	2530805

Dosage of Liquids - Series N

SERIES T

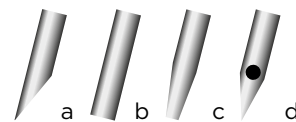

0.5 µL - 25 µL

- Zero Dead Volume
- Positive displacement
- Sample contained in the needle only
- Removable syringe parts
- Removable plunger stop
- Including: 1 needle & 1 calibrated piston wire



TECHNICAL INFORMATION

Main usage:

- Sample dosage for Gas Chromatography (GC)
- Dosage of small amounts of liquids
- For Thin Layer Chromatography (TLC)

Glass Barrel: Borosilicate 3.3

Removable Needles (RN)

Plunger is able to be pushed all the way to the tip of the needle.

Stainless Steel = sst*

Needle Tip			a	b	c	d
			(RN)	(RN)	(RN)	(RN)
Length			70 mm	70 mm	70 mm	70 mm
Volume	Plunger Tip	O.D. (Gauge)	Part No.	Part No.	Part No.	Part No.
0.5 µL	sst*	0.47 (G26s)	2200051	2200058	2200066	-
0.5 µL	sst*	0.64 (G23)	2200062	2200056	2200061	-
1 µL	sst*	0.47 (G26s)	2200101	2200102	2200110	2200103
1 µL	sst*	0.64 (G23)	2200118	-	2200113	-
1 µL	sst*	0.72 (G22s)	2200105	2200104	-	-
2 µL	sst*	0.64 (G23)	2200204	2200206	-	-
2 µL	sst*	0.72 (G22s)	2200201	2200202	-	2200203
5 µL	sst*	0.64 (G23)	2200307	-	2200306	-
10 µL	sst*	0.72 (G22s)	2200401	2200402	-	2200403
25 µL	sst*	1.10 (G19)	2200501	2200502	2200505	2200503

Dosage of Liquids - Series N

SERIES T

Replacement parts (1 needle & 1 calibrated piston wire)



Needle Tip			a	b	c	
			(RN)	(RN)	(RN)	Sealing Kit
Length			70 mm	70 mm	70 mm	5 Seals incl.
Volume	Plunger Tip	O.D. (Gauge)	Part No.	Part No.	Part No.	Part No.
1 µL	sst*	0.47 (G26s)	2231101	2231102	2231103	2230001
2 µL	sst*	0.72 (G22s)	2231201	2231202	-	2230002
10 µL	sst*	0.70 (G22s)	2231401	2231402	-	2230004
25 µL	sst*	1.10 (G19)	2231501	2231502	-	2230005

Dosage of Liquids - Series N

SERIES LT GLASS LUER LOCK



TECHNICAL INFORMATION

Main usage:
Sample dosage, syringes are autoclavable when disassembled

Glass Barrel: Borosilicate 3.3

Stainless Steel = sst*

Volume	Plunger Tip	Part No.
5 µL	sst*	2100312
10 µL	sst*	2100412
25 µL	sst*	2100512
50 µL	sst*	2100612
100 µL	sst*	2100714
250 µL	sst*	2100812
500 µL	sst*	2100912

Dosage of Liquids - Series N

SERIES TLL PTFE LUER LOCK



TECHNICAL INFORMATION

Main usage:
Sample dosage

Glass Barrel: Borosilicate 3.3

Stainless Steel = sst*

Volume	Plunger Tip	Part No.
25 µL	sst*	2100511
50 µL	sst*	2100611
100 µL	sst*	2100711
250 µL	sst*	2100811
500 µL	sst*	2100911

OVERVIEW

DOSAGE OF GAS & LIQUIDS - SERIES H

Fixed Needles	67
Removable Needles	69
Series SH	70
Series G	71
Series P	72
Series LT	73
Series TLT	74
Series TLL	75

HPLC SYRINGES

Most Common Valves	76
Valco* VISF	77
Waters* U6K	78

Dosage of Gas & Liquids - Series H

FIXED NEEDLES

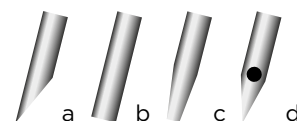

TECHNICAL INFORMATION

Main usage:

- Sample dosage for Gas Chromatography (GC)
- HPLC Valves
- Autosamplers
- Dosage of aggressive fluids

Glass Barrel: Borosilicate 3.3

Needle Tip			a	a	b	c	d
			(FN)	(FN)	(FN)	(FN)	(FN)
Length			51 mm	51 mm	51 mm	51 mm	51 mm
Volume	Plunger Tip	O.D. (Gauge)	Part No.	Part No.	Part No.	Part No.	Part No.
				6-Pack			
5 µL	PTFE	0.47 (G26s)	2600301	2600311	2600302	2600303	2600304
10 µL	PTFE	0.47 (G26s)	2600401	2600411	2600402	2600403	2600404
25 µL	PTFE	0.72 (G22s)	2600501	-	2600502	2600503	2600504
50 µL	PTFE	0.72 (G22s)	2600601	-	2600602	2600603	2600604
100µl	PTFE	0.72 (G22s)	2600701	-	2600702	2600703	2600704
250 µL	PTFE	0.72 (G22)	2600801	-	2600802	2600803	2600804
500 µL	PTFE	0.72 (G22)	2600901	-	2600902	2600903	2600904
1.0 mL	PTFE	0.64 (G23)	2600003	-	-	-	2600008
1.0 mL	PTFE	0.72 (G22)	2600000	-	2600001	2600016	2600002
2.5 mL	PTFE	0.64 (G23)	-	-	-	2600037	-
2.5 mL	PTFE	0.72 (G22)	2600020	-	2600021	2600084	2600022
5.0 mL	PTFE	0.72 (G22)	2600040	-	2600041	-	2600042
10.0 mL	PTFE	0.72 (G22)	2600060	-	2600061	-	2600062

Dosage of Gas & Liquids - Series H

FIXED NEEDLES

Customized length

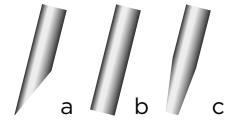

Needle Tip			a; b; c;
Length			Please specify needle tip & length (in mm)
Volume	Plunger	O.D. (Gauge)	Part No.
5 µL	PTFE	0.47 (G26s)	2610300
10 µL	PTFE	0.47 (G26s)	2610400
25 µL	PTFE	0.72 (G22s)	2610500
50 µL	PTFE	0.72 (G22s)	2610600
100 µL	PTFE	0.72 (G22s)	2610700
250 µL	PTFE	0.72 (G22)	2610800
500 µL	PTFE	0.72 (G22)	2610900
1.0 mL	PTFE	0.72 (G22)	2610000
2.5 mL	PTFE	0.72 (G22)	2610020
5.0 mL	PTFE	0.72 (G22)	2610040
10.0 mL	PTFE	0.72 (G22)	2610060

Dosage of Gas & Liquids - Series H

REMOVABLE NEEDLES

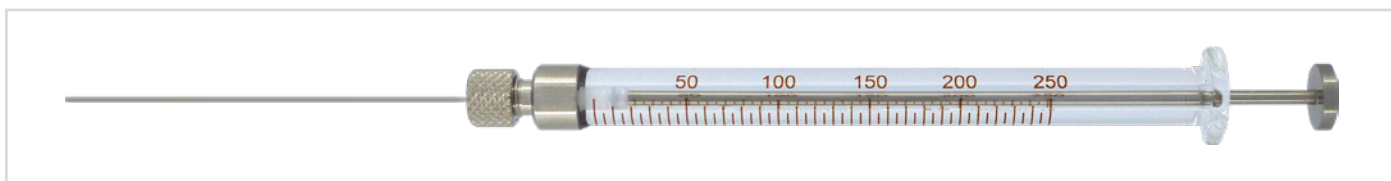
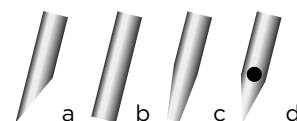

TECHNICAL INFORMATION

Main usage:

- Sample dosage for Gas Chromatography (GC)
- HPLC Valves
- Autosamplers
- Dosage of aggressive fluids

Glass Barrel: Borosilicate 3.3

Needle Tip			a	b	c	d
			(RN)	(RN)	(RN)	(RN)
Length			51 mm	51 mm	51 mm	51 mm
Volume	Plunger Tip	O.D. (Gauge)	Part No.	Part No.	Part No.	Part No.
5 µL	PTFE	0.47 (G26s)	2600305	2600306	2600307	2600308
10 µL	PTFE	0.47 (G26s)	2600405	2600406	2600407	2600408
25 µL	PTFE	0.72 (G22s)	2600505	2600506	2600507	2600508
50 µL	PTFE	0.72 (G22s)	2600605	2600606	2600607	2600608
100 µL	PTFE	0.72 (G22s)	2600705	2600706	2600707	2600708
250 µL	PTFE	0.72 (G22)	2600805	2600806	2600807	2600808
500 µL	PTFE	0.72 (G22)	2600905	2600906	2600907	2600908
1.0 mL	PTFE	0.72 (G22)	2600005	2600006	2600137	2600007
2.5 mL	PTFE	0.72 (G22)	2600025	2600026	-	2600027
5.0 mL	PTFE	0.72 (G22)	2600045	2600046	-	2600047
10.0 mL	PTFE	0.72 (G22)	2600065	2600066	-	2600067

Customized length

Needle Tip			a; b; c
Length			Please specify needle tip and length in mm
Volume	Plunger Tip	O.D. (Gauge)	Part No.
5 µL	PTFE	0.47 (G26s)	2610309
10 µL	PTFE	0.47 (G26s)	2610409
25 µL	PTFE	0.72 (G22s)	2610509
50 µL	PTFE	0.72 (G22s)	2610609
100 µL	PTFE	0.72 (G22s)	2610709
250 µL	PTFE	0.72 (G22)	2610809
500 µL	PTFE	0.72 (G22)	2610909
1.0 mL	PTFE	0.72 (G22)	2610007
2.5 mL	PTFE	0.72 (G22)	2610027
5.0 mL	PTFE	0.72 (G22)	2610047
10.0 mL	PTFE	0.72 (G22)	2610067

Dosage of Gas & Liquids - Series H

SERIES SH

With Extended Handle

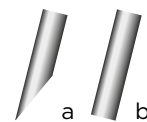

TECHNICAL INFORMATION

Main usage:

- Sample dosage for Gas Chromatography (GC)
- HPLC Valves

Glass Barrel: Borosilicate 3.3

Fixed Needles (FN)

Removable Needles (RN)

Functions:

- Bending is avoided by reinforced plunger
- Prevents transfer of body heat from hand to contents
- Plunger stop prevents blowout
- Replaceable plunger

Needle Tip			a	b	a	b
			(FN)	(FN)	(RN)	(RN)
Length			51 mm	51 mm	51 mm	51 mm
Volume	Plunger Tip	O.D. (Gauge)	Part No.	Part No.	Part No.	Part No.
5 µL	PTFE	0.47 (G26s)	2506301	2506302	2506305	2506306
10 µL	PTFE	0.47 (G26s)	2506401	2506402	2506405	2506406
25 µL	PTFE	0.72 (G22s)	2506501	2506502	2506505	2506506
50 µL	PTFE	0.72 (G22s)	2506601	2506602	2506605	2506606
100 µL	PTFE	0.72 (G22s)	2506701	2506702	2506705	2506706
250 µL	PTFE	0.72 (G22)	2506801	2506802	2506805	2506806
500 µL	PTFE	0.72 (G22)	2506901	2506902	2506905	2506906

Customized length and replacement barrels

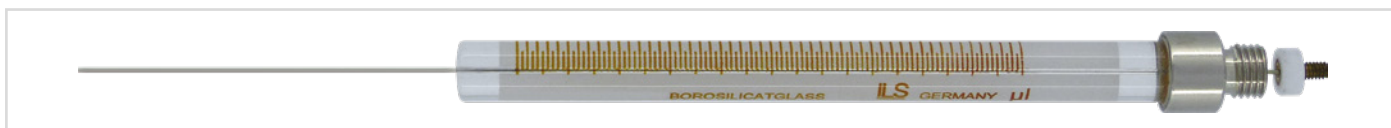

Needle Tip			a; b		a	a
Length			Specify with order (length in mm and tip style)		Replacement Glass Barrel	
Volume	Plunger Tip	O.D. (Gauge)	(FN)	(RN)	(FN)	(RN)
5 µL	PTFE	0.47 (G26s)	2516301	2516302	2536301	2536305
10 µL	PTFE	0.47 (G26s)	2516401	2516402	2536401	2536405
25 µL	PTFE	0.72 (G22s)	2516501	2516502	2536501	2536505
50 µL	PTFE	0.72 (G22s)	2516601	2516602	2536601	2536605
100 µL	PTFE	0.72 (G22s)	2516701	2516702	2536701	2536705
250 µL	PTFE	0.72 (G22)	2516801	2516802	2536801	2536805

Dosage of Gas & Liquids - Series H

SERIES G

With static PTFE-Seal topping the glass barrel

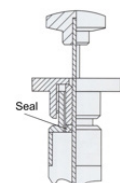
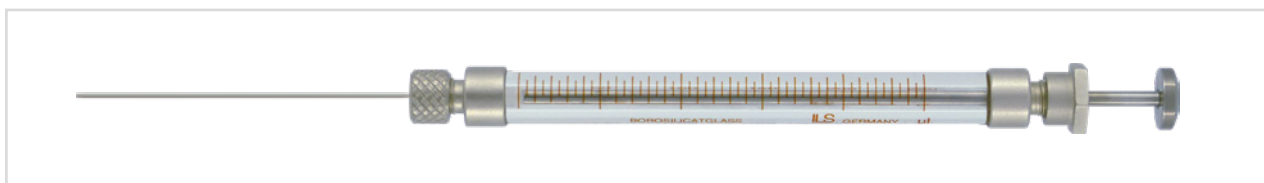

TECHNICAL INFORMATION

Main usage:

- Sample dosage for Gas Chromatography (GC)
- HPLC Valves
- Dosage with counter-pressure

Glass Barrel: Borosilicate 3.3

Fixed Needles (FN)

Removable Needles (RN)

Fixed Needle

Needle Tip			a	b	d	
			(FN)	(FN)		
Length			51 mm	51 mm	51 mm	
Volume	Plunger Tip	O.D. (Gauge)	Part No.	Part No.	O.D. (Gauge)	Part No.
10 µL	PTFE	0.47 (G26s)	2400401	2400402	0.47 (26)	2400404
25 µL	PTFE	0.72 (G22s)	2400501	2400502	0.72 (22)	2400504
50 µL	PTFE	0.72 (G22s)	2400601	2400602	0.72 (22)	2400604
100 µL	PTFE	0.72 (G22s)	2400701	2400702	0.72 (22)	2400704
250 µL	PTFE	0.72 (G22)	2400801	2400802	0.72 (22)	2400804
500 µL	PTFE	0.72 (G22)	2400901	2400902	0.72 (22)	2400904

Removable Needle

Needle Tip			a	b	d	
			(RN)	(RN)		
Length			51 mm	51 mm	51 mm	
Volume	Plunger Tip	O.D. (Gauge)	Part No.	Part No.	O.D. (Gauge)	Part No.
10 µL	PTFE	0.47 (G26s)	2400405	2400406	0.47 (26)	2400408
25 µL	PTFE	0.72 (G22s)	2400505	2400506	0.72 (22)	2400508
50 µL	PTFE	0.72 (G22s)	2400605	2400606	0.72 (22)	2400608
100 µL	PTFE	0.72 (G22s)	2400705	2400706	0.72 (22)	2400708
250 µL	PTFE	0.72 (G22)	2400805	2400806	0.72 (22)	2400808
500 µL	PTFE	0.72 (G22)	2400905	2400906	0.72 (22)	2400908

Dosage of Gas & Liquids - Series H

SERIES P

With adjustable PTFE-Seal

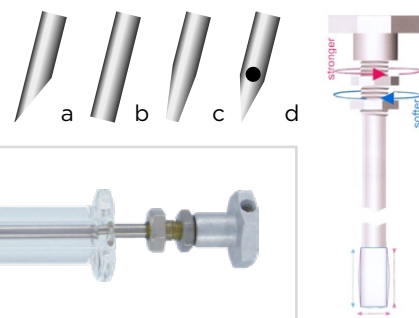
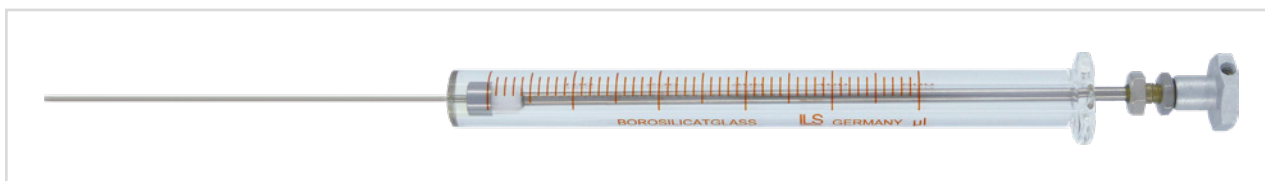

TECHNICAL INFORMATION

Main usage:

- Sample dosage for Gas Chromatography (GC)
- HPLC Valves
- Dosage with counter-pressure
- Gastight, adjustable PTFE-Seal on the top of the plunger
- Very long lifetime of the seal

Glass Barrel: Borosilicate 3.3

Fixed Needles (FN)

Removable Needles (RN)

Needle Tip			a	b	c		d
			(FN)	(FN)	(FN)		(FN)
Length			51 mm	51 mm	51 mm		51 mm
Volume	Plunger Tip	O.D. (Gauge)	Part No.	Part No.	Part No.	O.D. (Gauge)	Part No.
25 µL	PTFE	0.72 (G22s)	2300501	2300502	2300503	0.72 (G22)	2300504
50 µL	PTFE	0.72 (G22s)	2300601	2300602	2300603	0.72 (G22)	2300604
100 µL	PTFE	0.72 (G22s)	2300701	2300702	2300703	0.72 (G22)	2300704
250 µL	PTFE	0.72 (G22)	2300801	2300802	2300803	0.72 (G22)	2300804
500 µL	PTFE	0.72 (G22)	2300901	2300902	2300903	0.72 (G22)	2300904

Needle Tip			a	b	c		d
			(RN)	(RN)	(RN)		(RN)
Length			51 mm	51 mm	51 mm		51 mm
Volume	Plunger Tip	O.D. (Gauge)	Part No.	Part No.	Part No.	O.D. (Gauge)	Part No.
25 µL	PTFE	0.72 (G22s)	2300505	2300506	2300507	0.72 (G22)	2300508
50 µL	PTFE	0.72 (G22s)	2300605	2300606	2300607	0.72 (G22)	2300608
100 µL	PTFE	0.72 (G22s)	2300705	2300706	2300707	0.72 (G22)	2300708
250 µL	PTFE	0.72 (G22)	2300805	2300806	2300807	0.72 (G22)	2300808
500 µL	PTFE	0.72 (G22)	2300905	2300906	2300907	0.72 (G22)	2300908

Needle Tip			a, b, c	
			(FN)	(RN)
Length			Specify with order (length in mm and tip style)	
Volume	Plunger Tip	O.D. (Gauge)	Part No.	Part No.
25 µL	PTFE	0.72 (G22s)	2310500	2310501
50 µL	PTFE	0.72 (G22s)	2310600	2310601
100 µL	PTFE	0.72 (G22s)	2310700	2310701
250 µL	PTFE	0.72 (G22)	2310800	2310801
500 µL	PTFE	0.72 (G22)	2310900	2310901

Dosage of Gas & Liquids - Series H

SERIES LT GLASS LUER TIP



TECHNICAL INFORMATION

Main usage:

- Sample dosage
- Dosage of aggressive fluids
- Autoclavable

Glass Barrel: Borosilicate 3.3

Volume	Plunger Tip	Part No.
5 μ L	PTFE	2600314
10 μ L	PTFE	2600412
25 μ L	PTFE	2600511
50 μ L	PTFE	2600611
100 μ L	PTFE	2600711
250 μ L	PTFE	2600811
500 μ L	PTFE	2600911
1.0 mL	PTFE	2600013
2.5 mL	PTFE	2600033
5.0 mL	PTFE	2600053
10.0 mL	PTFE	2600073

Dosage of Gas & Liquids - Series H

SERIES TLT PTFE LUER TIP

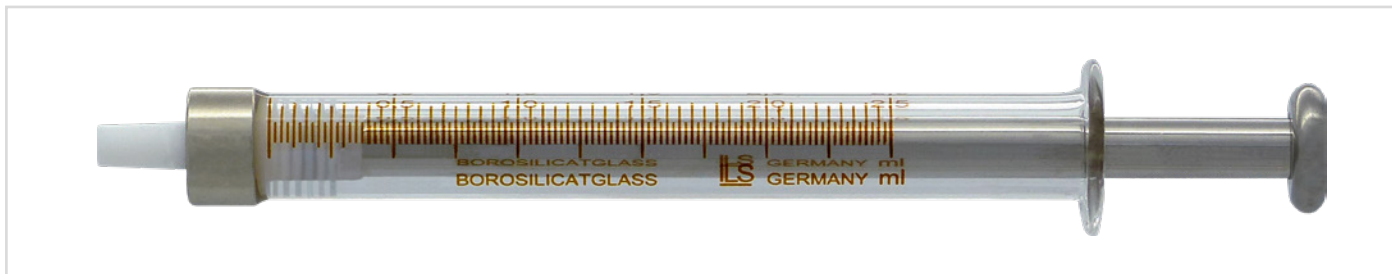

TECHNICAL INFORMATION

Main usage:

- Sample dosage
- Dosage of aggressive fluids

Glass Barrel: Borosilicate 3.3

Volume	Plunger Tip	Part No.
5 µL	PTFE	2600313
10 µL	PTFE	2600413
25 µL	PTFE	2600513
50 µL	PTFE	2600613
100 µL	PTFE	2600713
250 µL	PTFE	2600813
500 µL	PTFE	2600913
1.0 mL	PTFE	2600014
2.5 mL	PTFE	2600034
5.0 mL	PTFE	2600054
10.0 mL	PTFE	2600074

TLT-X (with plunger stop)

Volume	Plunger Tip	Part No.
50 µL	PTFE	2600626
100 µL	PTFE	2600726
250 µL	PTFE	2600826
500 µL	PTFE	2600926

Dosage of Gas & Liquids - Series H

SERIES TLL PTFE LUER LOCK



TECHNICAL INFORMATION

Main usage:

- Sample dosage
- Dosage of aggressive fluids

Glass Barrel: Borosilicate 3.3

Volume	Plunger Tip	Part No.
5 µL	PTFE	2600309
10 µL	PTFE	2600409
25 µL	PTFE	2607509
50 µL	PTFE	2607609
100 µL	PTFE	2607709
250 µL	PTFE	2607809
500 µL	PTFE	2607909
1.0 mL	PTFE	2607011
2.5 mL	PTFE	2607031
5.0 mL	PTFE	2607051
10.0 mL	PTFE	2607071
25.0 mL	PTFE	2607091
50.0 mL	PTFE	2607101
100.0 mL	PTFE	2607121

HPLC Syringes - Most Common Valves

MOST COMMON VALVES

Rheodyne*, Varian*, Shimadzu*, Knauer*, Hewlett Packard* / Agilent*, Beckman*, Valco* VISF-2, Jasco*, Altex* valve injectors

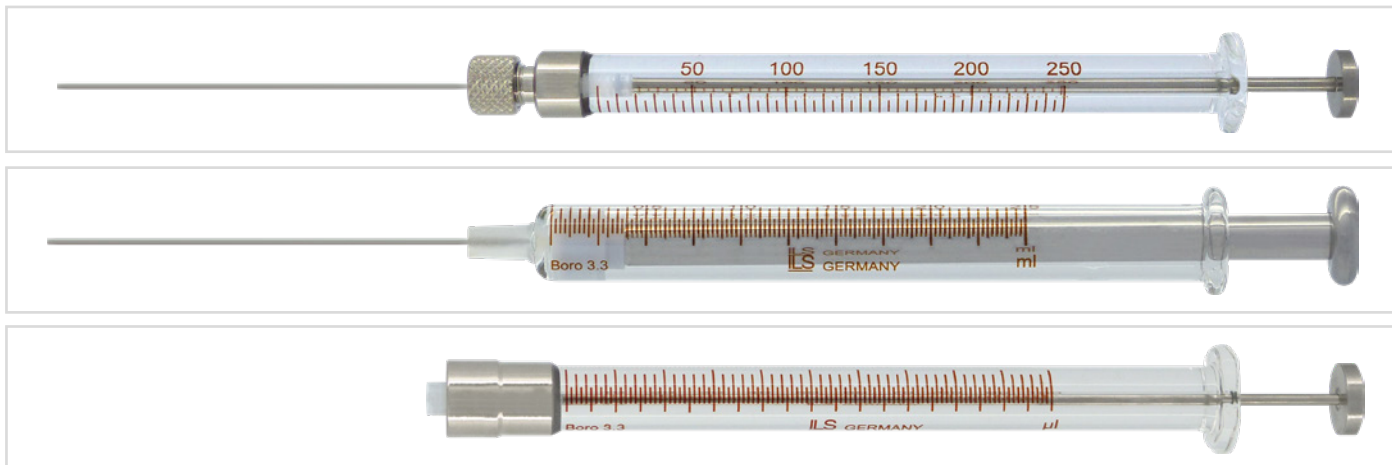

TECHNICAL INFORMATION

Fixed Needles (FN)

Removable Needles (RN)

Flexible Plunger = High corrosion resistance (Hi-Res)

Glass Barrel: Borosilicate 3.3

Stainless Steel = sst*

Extended Handle = eh

			TLL+NLL needle		
Needle Tip			b	b	b
			(FN)	(RN)	Luer Lock
Length			51 mm	51 mm	51 mm
Volume	Plunger Tip	O.D. (Gauge)	Part No.	Part No.	Part No.
5 µL	Hi-Res	0.72 (G22s)	2161302	2161306	-
10 µL	Hi-Res	0.72 (G22s)	2161402	2161406	-
5 µL	sst*	0.72 (G22s)	2101302	2101306	-
10 µL	sst*	0.72 (G22s)	2101402	2101406	-
25 µL	sst*	0.72 (G22s)	2101502	2101506	-
50 µL	sst*	0.72 (G22s)	2101602	2101606	2101609
100 µL	sst*	0.72 (G22s)	2101702	2101706	2101709
250 µL	sst*	0.72 (G22)	2101802	2101806	2101809
500 µL	sst*	0.72 (G22)	2101902	2101906	2101909
5 µL	PTFE	0.72 (G22s)	2601302	2601306	-
10 µL	PTFE	0.72 (G22s)	2601402	2601406	2601409
25 µL	PTFE	0.72 (G22s)	2601502	2601506	2601509
50 µL	PTFE	0.72 (G22s)	2601602	2601606	2601609
100 µL	PTFE	0.72 (G22s)	2601702	2601706	2601709
250 µL	PTFE	0.72 (G22)	2601802	2601806	2601809
500 µL	PTFE	0.72 (G22)	2601902	2601906	2601909
1.0 mL	PTFE	0.72 (G22)	2601001	2601002	2601003

HPLC Syringes - Valco* VISF

VALCO* VISF-1 VALVES

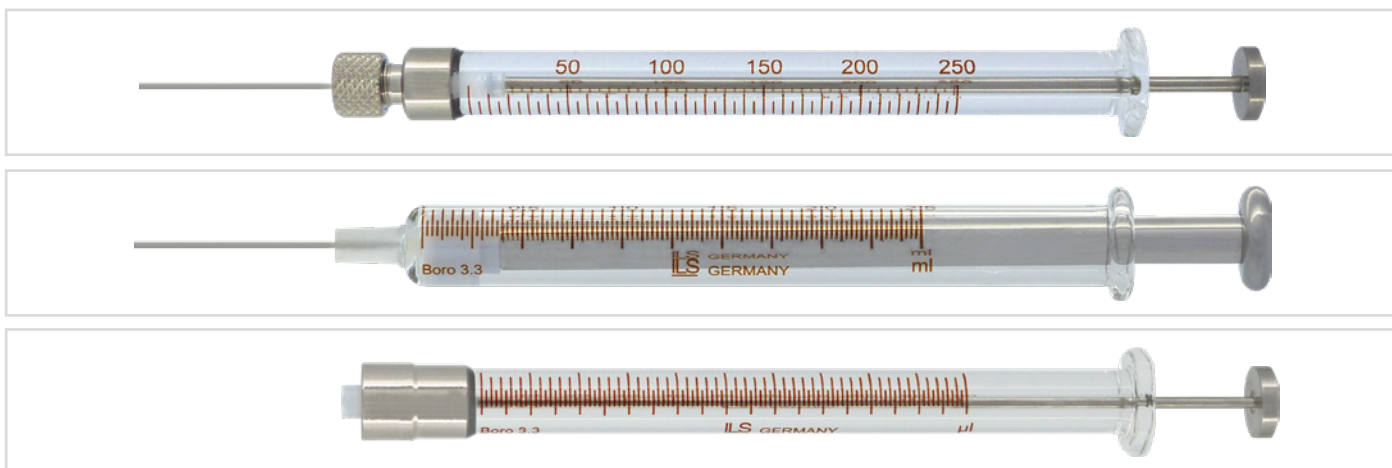

TECHNICAL INFORMATION

Fixed Needles (FN)

Removable Needles (RN)

Flexible Plunger = High corrosion resistance (Hi-Res)

Glass Barrel: Borosilicate 3.3

Stainless Steel = sst*

				TLL+NLL needle		
Needle Tip			b	b	b	
			(FN)	(RN)	Luer Lock	
Length			19 mm	19 mm	19 mm	
Volume	Plunger Tip	O.D. (Gauge)	Part No.	Part No.	Part No.	
5 µL	Hi-Res	0.72 (G22s)	2163303	2163307	-	
10 µL	Hi-Res	0.72 (G22s)	2163403	2163407	-	
5 µL	sst*	0.72 (G22s)	2103303	2103307	-	
10 µL	sst*	0.72 (G22s)	2103403	2103407	-	
25 µL	sst*	0.72 (G22s)	2103503	2103507	-	
50 µL	sst*	0.72 (G22s)	2103603	2103607	2103609	
100 µL	sst*	0.72 (G22s)	2103703	2103707	2103709	
250 µL	sst*	0.72 (G22)	2103803	2103807	2103809	
500 µL	sst*	0.72 (G22)	2103903	2103907	2103909	
10 µL	PTFE	0.72 (G22s)	2603403	2603407	-	
25 µL	PTFE	0.72 (G22s)	2603503	2603507	-	
50 µL	PTFE	0.72 (G22s)	2603603	2603607	2603609	
100 µL	PTFE	0.72 (G22s)	2603703	2603707	2603709	
250 µL	PTFE	0.72 (G22)	2603803	2603807	2603809	
500 µL	PTFE	0.72 (G22)	2603903	2603907	2603909	
1.0 mL	PTFE	0.72 (G22)	2603003	2603007	2603009	

*All other trademarks, service marks, registered trademarks, and registered service marks are the property of their respective owners. Gardner Denver and ILS are not affiliated with Valco in any way.

HPLC Syringes - Waters* U6K

INJECTION VALVES



TECHNICAL INFORMATION

Fixed Needles (FN)

Removable Needles (RN)

Flexible Plunger = High corrosion resistance (Hi-Res)

Glass Barrel: Borosilicate 3.3

Stainless Steel = sst*

Extended Handle = eh

				TLL + NLL needle		
Needle Tip				b	b	b
				(FN)	(RN)	Luer Lock
Length				50 mm	50 mm	50 mm
Volume	Plunger Tip	O.D. (Gauge)	Part No.	Part No.	Part No.	
5 µL	Hi-Res	0.50 (G25s)	2162302	2162306	-	
10 µL	Hi-Res	0.50 (G25s)	2162402	2162406	-	
5 µL	sst*	0.50 (G25s)	2102302	2102306	-	
10 µL	sst*	0.50 (G25s)	2102402	2102406	-	
25 µL	sst*	0.50 (G25s)	2102502	2102506	-	
50 µL	sst*	0.50 (G25s)	2102602	2102606		2102609
100 µL	sst*	0.50 (G25s)	2102702	2102706		2102709
250 µL	sst*	0.50 (G25)	2102802	2102806		2102809
500 µL	sst*	0.50 (G25)	2102902	2102906		2102909
10 µL	PTFE	0.50 (G25s)	2602402	2602406		-
25 µL	PTFE	0.50 (G25s)	2602502	2602506		-
50 µL	PTFE	0.50 (G25s)	2602602	2602606		2602609
100 µL	PTFE	0.50 (G25s)	2602702	2602706		2602709
250 µL	PTFE	0.50 (G25)	2602802	2602806		2602809
500 µL	PTFE	0.50 (G25)	2602902	2602906		2602909
1.0 mL	PTFE	0.50 (G25)	2602006	2602007		2602003
2.5 mL	PTFE	0.50 (G25)	2602026	2602027		-
5 µL	sst* eh	0.50 (G25s)	-	2502304		-
10 µL	sst* eh	0.50 (G25s)	2502402	2502404		-
25 µL	sst* eh	0.50 (G25s)	2502502	2502504		-
50 µL	sst* eh	0.50 (G25s)	2502602	2502604		-
100 µL	sst* eh	0.50 (G25s)	-	2502704		-
250 µL	sst* eh	0.50 (G25)	-	2502804		-
25 µL	PTFE eh	0.50 (25s)	-	2506511		-
50 µL	PTFE eh	0.50 (25s)	-	2506611		-
100 µL	PTFE eh	0.50 (25s)	-	2506711		-
250 µL	PTFE eh	0.50 (G25)	-	2506811		-

OVERVIEW

ON-COLUMN SYRINGES 80

DOSAGE IN AUTOSAMPLER

GC

Agilent*	82
Shimadzu*	86
Perkin Elmer*	88
LEAP*	89
Headspace	90
Mitsubishi*	91
Dani*	92
Siemens* / Nippon*	93

HPLC

Spark*	94
Perkin Elmer*	95
Waters* Wisp**	96
Thermo* Finnigan	97
Shimadzu* SIL	97
Hitachi*	98
Agilent*	99
Kontron*	100
Gynkotec Dionex*	101
LEAP* / CTC*	102

CTC* INSTRUMENTS

Combi & GC Pal	104
HTS, HTC, LC Pal	105
R-Series	106
DLW	107

ONE LAMBDA JET* 108

TLC CAMAG* 109

ROBBINS HYDRA 110

OLYMPUS* AU 112

*All other trademarks, service marks, registered trademarks, and registered service marks are the property of their respective owners. Gardner Denver and ILS are not affiliated with Agilent, Shimadzu, Perkin Elmer, LEAP, Mitsubishi, Dani, Siemens / Nippon, Spark, Waters, Thermo Finnigan, Hitachi, Kontron, Gynkotec Dionex, CTC, One Lambda Jet, TLC Camag and Olympus in any way. WISP is a registered trademark of Waters Corporation.

On-Column Syringes

ON-COLUMN INJECTION

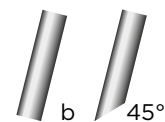

TECHNICAL INFORMATION

Needles:

- Stainless Steel (sst*) or fused silica
- Fixed Needles (FN)
- Removable Needles (RN)

Glass Barrel: Borosilicate 3.3

Stainless Steel = sst*

Needle Tip			45°	45°
Material			sst*	sst*
			(FN)	(FN)
Length			75 mm	85 mm
Volume	Plunger Tip	O.D.	Part No.	Part No.
5 µL	sst*	0.23 mm	2142306	2142307



Needle Tip			45°	45°	45°	b	b
Material			sst*	sst*	sst*	sst*	fused silica
			(RN)	(RN)	(RN)	(RN)	(RN)
Length			75 mm	85 mm	100 mm	125 mm	100 mm
Volume	Plunger Tip	O.D.	Part No.	Part No.	Part No.	Part No.	Part No.
5 µL	sst*	0.17 mm	-	-	-	-	2142303
5 µL	sst*	0.23 mm	2142313	-	2142312	-	2142304
10 µL	sst*	0.17 mm	-	-	-	-	2142402
10 µL	sst*	0.23 mm	2142407	2142408	2142412	2142406	2142404
10 µL	PTFE	0.17 mm	-	-	-	-	2642401
10 µL	PTFE	0.23 mm	2642403	-	-	-	2642402

On-Column Syringes

ON-COLUMN INJECTION

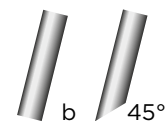

Replacement needles

Needle Tip		45°	45°	45°	b	b
Material		sst*	sst*	sst*	sst*	fused silica
		(RN)	(RN)	(RN)	(RN)	(RN)
Length		75 mm	85 mm	100 mm	125 mm	100 mm
Volume	O.D.	3-Pack	3-Pack	3-Pack	3-Pack	3-Pack
5 µL	0.17 mm	-	-	-	-	2822021
5 µL	0.23 mm	2822303	2822304	2822302	-	-
10 µL	0.17 mm	-	-	-	-	2822022
10 µL	0.23 mm	2822408	2822409	2822407	2822406	2822042

Dosage in Autosampler - GC Autosampler

AGILENT* TECHNOLOGIES (HP)

7673-7683, 6850

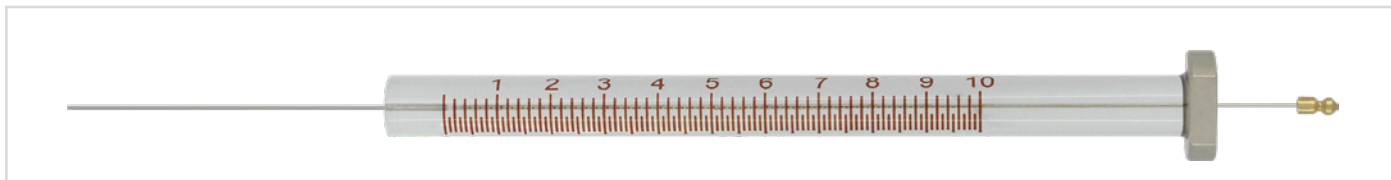
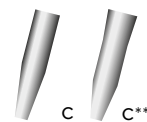

Needle Tip			c	c	c	c	c	c
			(FN)	(FN)	(FN)	(FN)	(FN)	(FN)
Length			42 mm	42 mm	42 mm	42 mm	42 mm	42 mm
Volume	Plunger Tip	O.D. (Gauge)	Part No.	Part No.	Part No.	Part No.	Part No.	Part No.
				6-Pack		6-Pack		6-Pack
5 µL	Hi-Res	0.47 (G26s)	2164303	2164313	-	-	-	-
10 µL	Hi-Res	0.47 (G26s)	2164403	2164413	-	-	-	-
5 µL	Hi-Res	0.47/0.64**	-	-	2164304	2164314	-	-
10 µL	Hi-Res	0.47/0.64**	-	-	2164404	2164414	-	-
5 µL	Hi-Res	0.64 (G23s)	-	-	-	-	2164305	2164315
10 µL	Hi-Res	0.64 (G23s)	-	-	-	-	2164405	2164415

5 µL	sst*	0.47 (G26s)	2104303	2104313	-	-	-	-
10 µL	sst*	0.47 (G26s)	2104403	2104413	-	-	-	-
5 µL	sst*	0.47/0.64**	-	-	2104304	2104314	-	-
10 µL	sst*	0.47/0.64**	-	-	2104404	2104414	-	-
5 µL	sst*	0.64 (G23s)	-	-	-	-	2104305	2104315
10 µL	sst*	0.64 (G23s)	-	-	-	-	2104405	2104415
25 µL	sst*	0.64 (G23s)	-	-	-	-	2104505	-
50 µL	sst*	0.64 (G23s)	-	-	-	-	2104605	-
100 µL	sst*	0.64 (G23s)	-	-	-	-	2104705	-

5 µL	PTFE	0.47 (G26s)	2604303	2604313	-	-	-	-
10 µL	PTFE	0.47 (G26s)	2604403	2604413	-	-	-	-
5 µL	PTFE	0.47/0.64**	-	-	2604304	2604314	-	-
10 µL	PTFE	0.47/0.64**	-	-	2604404	2604414	-	-
5 µL	PTFE	0.64 (G23s)	-	-	-	-	2604305	2604315
10 µL	PTFE	0.64 (G23s)	-	-	-	-	2604405	2604415
25 µL	PTFE	0.64 (G23s)	-	-	-	-	2604505	-
50 µL	PTFE	0.64 (G23s)	-	-	-	-	2604605	-
100 µL	PTFE	0.64 (G23s)	-	-	-	-	2604705	-

Dosage in Autosampler - GC Autosampler

AGILENT* TECHNOLOGIES (HP)

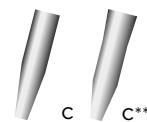

A-Syringe



TECHNICAL INFORMATION

Advantage:

- Longer lifetime
- With static PTFE-Seal topping the glass barrel
- Straight guided plunger

Fixed Needles (FN)

Needle Tip			c	c	c	c	c	c
			(FN)	(FN)	(FN)	(FN)	(FN)	(FN)
Length			42 mm	42 mm	42 mm	42 mm	42 mm	42 mm
Volume	Plunger Tip	O.D. (Gauge)	Part No.	Part No.	Part No.	Part No.	Part No.	Part No.
				6-Pack		6-Pack		6-Pack
5 µL	Hi-Res	0.47 (G26s)	2164333	2164336	-	-	-	-
10 µL	Hi-Res	0.47 (G26s)	2164433	2164436	-	-	-	-
5 µL	Hi-Res	0.47/0.64**	-	-	2164337	2164338	-	-
10 µL	Hi-Res	0.47/0.64**	-	-	2164434	2164438	-	-
5 µL	Hi-Res	0.64 (G23s)	-	-	-	-	2164339	2164340
10 µL	Hi-Res	0.64 (G23s)	-	-	-	-	2164435	2164437

5 µL	sst*	0.47 (G26s)	2104333	2104337	-	-	-	-
10 µL	sst*	0.47 (G26s)	2104433	2104437	-	-	-	-
5 µL	sst*	0.47/0.64**	-	-	2104334	2104338	-	-
10 µL	sst*	0.47/0.64**	-	-	2104434	2104438	-	-
5 µL	sst*	0.64 (G23s)	-	-	-	-	2104335	2104336
10 µL	sst*	0.64 (G23s)	-	-	-	-	2104435	2104436

*All other trademarks, service marks, registered trademarks, and registered service marks are the property of their respective owners. Gardner Denver and ILS are not affiliated with Agilent in any way.

Dosage in Autosampler - GC Autosampler

AGILENT* TECHNOLOGIES (HP)

7673-7683

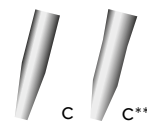

Needle Tip			c	c	c	c
			(RN)	(RN)	(RN)	(RN)
Length			42 mm	42 mm	42 mm	42 mm
Volume	Plunger Tip	O.D. (Gauge)	Part No.	Part No.	Part No.	Part No.
						6-Pack
0.5 µL	T	0.47 (G26s)	2204051	-	-	-
0.5 µL	T	0.47/0.64	-	2204053	-	-
0.5 µL	T	0.64 (G23s)	-	-	2204052	-
1.0 µL	T	0.47 (G26s)	2204104	-	-	-
1.0 µL	T	0.64 (G23)	-	-	2204103	-
5.0 µL	T	0.64 (G23s)	-	-	2204303	2204313
5 µL	Hi-Res	0.47 (G26s)	2164307	-	-	-
10 µL	Hi-Res	0.47 (G26s)	2164407	-	-	-
5 µL	Hi-Res	0.47/0.64**	-	2164308	-	-
10 µL	Hi-Res	0.47/0.64**	-	2164408	-	-
5 µL	Hi-Res	0.64 (G23s)	-	-	2164309	-
10 µL	Hi-Res	0.64 (G23s)	-	-	2164409	-
5 µL	sst*	0.47 (G26s)	2104307	-	-	-
10 µL	sst*	0.47 (G26s)	2104407	-	-	-
5 µL	sst*	0.47/0.64**	-	2104308	-	-
10 µL	sst*	0.47/0.64**	-	2104408	-	-
5 µL	sst*	0.64 (G23s)	-	-	2104309	-
10 µL	sst*	0.64 (G23s)	-	-	2104409	2604409-6P
5 µL	PTFE	0.47 (G26s)	2604307	-	-	-
10 µL	PTFE	0.47 (G26s)	2604407	-	-	-
5 µL	PTFE	0.47/0.64**	-	2604308	-	-
10 µL	PTFE	0.47/0.64**	-	2604408	-	-
5 µL	PTFE	0.64 (G23s)	-	-	2604309	-
10 µL	PTFE	0.64 (G23s)	-	-	2604409	-

Dosage in Autosampler - GC Autosampler

AGILENT* TECHNOLOGIES (HP)

7670 / 7671 / 7672

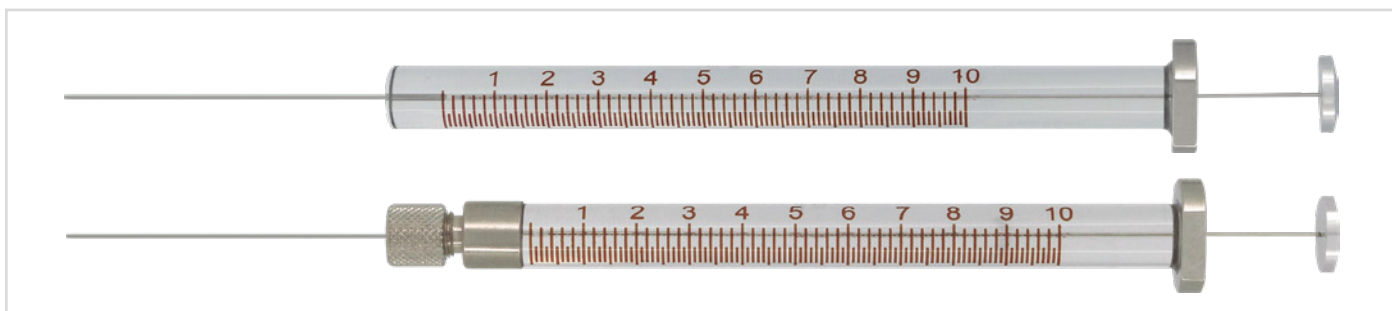

TECHNICAL INFORMATION

Fixed Needles (FN)

Removable Needles (RN)

Flexible Plunger = High corrosion resistance (Hi-Res)

Glass Barrel: Borosilicate 3.3

Zero Dead Volume (plunger in needle) = T

Stainless Steel = sst*

Needle Tip			a	a	a	a
			(FN)	(FN)	(RN)	(RN)
Length			51 mm	51 mm	51 mm	51 mm
Volume	Plunger Tip	O.D. (Gauge)	Part No.	Part No.	Part No.	Part No.
				6-Pack		6-Pack
5 µL	Hi-Res	0.47 (G26s)	2160301	2160311	2160305	-
10 µL	Hi-Res	0.47 (G26s)	2160401	2160411	2160405	2160415
5 µL	sst*	0.47 (G26s)	2100301	2100311	2100305	2100305-6P
10 µL	sst*	0.47 (G26s)	2100401	2100411	2100405	2100415
10 µL	PTFE	0.47 (G26s)	2600401	2600411	2600405	2600405-6P

*All other trademarks, service marks, registered trademarks, and registered service marks are the property of their respective owners. Gardner Denver and ILS are not affiliated with Agilent in any way.

Dosage in Autosampler - GC Autosampler

SHIMADZU* AOC 14 / 17 / 20

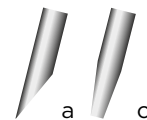

TECHNICAL INFORMATION

Fixed Needles (FN)

Removable Needles (RN)

Flexible Plunger = High corrosion resistance (Hi-Res)

Glass Barrel: Borosilicate 3.3

Stainless Steel = sst*

Needle Tip				a	a	c	c	a	c
				(FN)	(FN)	(FN)	(FN)	(RN)	(RN)
Length				42 mm	42 mm	42 mm	42 mm	42 mm	42 mm
Volume	Plunger Tip	Series	O.D. Gauge	Part No.	Part No.	Part No.	Part No.	Part No.	Part No.
					6-Pack		6-Pack		
5 µL	Hi-Res	N	0,47(G26s)	2165301	-	-	-	2165307	-
5 µL	Hi-Res	N	0,64(G23s)	2165302	-	2165304	-	2165308	-
5 µL	Hi-Res	A	0,47(G26s)	-	-	2165320	2165340	-	-
10 µL	Hi-Res	N	0,47(G26s)	2165401	-	2165403	-	2165407	-
10 µL	Hi-Res	N	0,64(G23s)	2165402	-	2165404	-	2165408	2165410
10 µL	Hi-Res	A	0,47(G26s)	2165417	2165417-6P	2165419	-	-	-
10 µL	Hi-Res	A	0,64(G23s)	2165418	-	2165421	2165421-6P	-	-

5 µL	sst*	N	0,47(G26s)	2105301	-	2105303	-	2105307	-
5 µL	sst*	N	0,64(G23s)	2105302	-	2105304	2105304-6P	2105308	2105309
5 µL	sst*	A	0,47(G26s)	2105317	2105336	2105319	2105338	-	-
5 µL	sst*	A	0,64(G23s)	2105318	2105337	2105321	2105339	-	-
10 µL	sst*	N	0,47(G26s)	2105401	-	2105403	2105413	2105407	2105409
10 µL	sst*	N	0,64(G23s)	2105402	2105412	2105404	2105414	2105408	2105410
10 µL	sst*	A	0,47(G26s)	2105417	2105436	2105419	2105438	2105427	2105429
10 µL	sst*	A	0,64(G23s)	2105418	2105437	2105421	2105439	2105428	2105430

10 µL	PTFE	H	0,47(G26s)	2605401	-	2605403	-	2605407	2605409
10 µL	PTFE	H	0,64(G23s)	2605402	-	2605404	2605404-6P	2605408	2605410

Dosage in Autosampler - GC Autosampler

SHIMADZU* AOC 5000



d



TECHNICAL INFORMATION

Fixed Needles (FN)

Glass Barrel: Borosilicate 3.3

Needle Tip				d
				(FN)
Length				51 mm
Volume	Plunger Tip	O.D. (Gauge)	Part No.	
1.0 mL	PTFE	0.47 (G26)	2620003	
1.0 mL	PTFE	0.64 (G23)	2620002	
2.5 mL	PTFE	0.47 (G26)	2620040	
2.5 mL	PTFE	0.64 (G23)	2620043	
5.0 mL	PTFE	0.47 (G26)	2620053	
5.0 mL	PTFE	0.64 (G23)	2620052	

*All other trademarks, service marks, registered trademarks, and registered service marks are the property of their respective owners. Gardner Denver and ILS are not affiliated with Shimadzu in any way.

Dosage in Autosampler - GC Autosampler

PERKIN ELMER*

AS 100 / AS 2000, AS 3000 GC autosystems, CLARUS 600 / 680

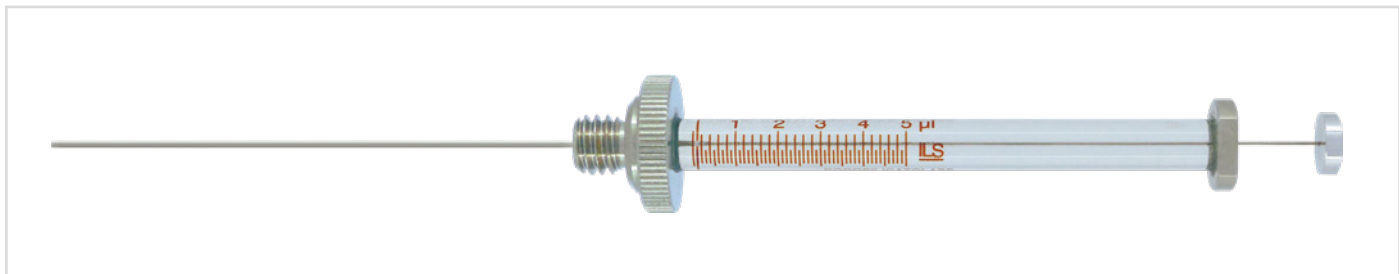

TECHNICAL INFORMATION

Fixed Needles (FN)

Removable Needles (RN)

Glass Barrel: Borosilicate 3.3

Stainless Steel = sst*

Zero Dead Volume = T

Needle Tip			c		c	
			(FN)		(RN)	
Length			70 mm		70 mm	
Volume	Plunger Tip	O.D. (Gauge)	Part No.	Part No.	Part No.	Part No.
0,5 µL	T	0,47 (G26s)	-	2208051	-	2208051
0,5 µL	T	0,64 (G23s)	-	2208053	-	2208053
5 µL	sst*	0,47 (G26s)	2108302	-	-	-
5 µL	sst*	0,64 (G23s)	2108303	-	-	-
50 µL	sst*	0,64 (G23s)	2108604	-	-	-
5 µL	PTFE	0,47 (G26s)	2608302	-	-	-
5 µL	PTFE	0,64 (G23s)	2608303	-	-	-
50 µL	PTFE	0,47 (G26s)	2608603	-	-	-
50 µL	PTFE	0,64 (G23s)	2608604	-	-	-
100 µL	PTFE	0,47 (G26s)	2608703	-	-	-

Dosage in Autosampler - GC Autosampler

LEAP*, CTC*, CARLO ERBA*, FISIONS*

CTC* A200 S / A200 SE / A 800 / Combi PAL / GC PAL

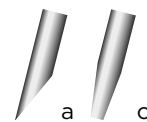

TECHNICAL INFORMATION

Fixed Needles (FN)

Removable Needles (RN)

Flexible Plunger = High corrosion resistance (Hi-Res)

Glass Barrel: Borosilicate 3.3

Stainless Steel = sst*

Zero Dead Volume = T

Needle Tip					a	c	c	c
					(FN)	(FN)	(FN)	(FN)
Length					51 mm	51 mm	51 mm	80 mm
Volume	Glass Barrel O.D. mm	Plunger Tip	Series	O.D. Gauge				
1,2 µL	6,5	T	-	26P	-	2220001	2220001-6P	-
5 µL	6,5	Hi-Res	N	0,47 (G26s)	2166301	2166303	-	-
5 µL	6,5	Hi-Res	A	0,47 (G26s)	-	2166333	-	-
10 µL	6,5	Hi-Res	N	0,47 (G26s)	2166401	2166421	2166421-6P	-
10 µL	6,5	Hi-Res	A	0,47 (G26s)	2166408	2166402		2166434
10 µL	6,5	Hi-Res	A	0,64 (G23s)	-	2166406	2166407	-
5 µL	6,5	sst*	N	0,47 (G26s)	2106301	2106302	2106302-6P	-
5 µL	6,5	sst*	N	0,64 (G23s)		2106303	2106303-6P	-
5 µL	6,5	sst*	A	0,47 (G26s)	2106334	2106333	2106337	-
5 µL	6,5	sst*	A	0,64 (G23s)		2106335	2106338	-
10 µL	6,5	sst*	N	0,47 (G26s)	2106401	2106416	2106425	2106412
10 µL	6,5	sst*	N	0,64 (G23s)	2106422	2106403	2106449	2106413
10 µL	6,5	sst*	N	0,72 (G22s)	-	-	-	2106415
10 µL	6,5	sst*	A	0,47 (G26s)	2106439	2106433	2106436	2106434
10 µL	6,5	sst*	A	0,64 (G23s)		2106451	2106451-6P	2106438
10 µL	6,5	PTFE	H	0,47 (G26s)	2606401	2606407	2606422	2606412
10 µL	6,5	PTFE	H	0,64 (G23s)	-	2606403	2606421	2606406
25 µL	6,5	PTFE	H	0,47 (G26s)	-	2620506	-	-
25 µL	6,5	PTFE	H	0,64 (G23s)	-	2620503	-	-
50 µL	6,5	PTFE	H	0,47 (G26s)	-	2620606	-	-
50 µL	6,5	PTFE	H	0,64 (G23s)	2620601	2620603	-	2620612
100 µL	6,5	PTFE	H	0,47 (G26s)	-	2620706	2620706-6P	-
100 µL	6,5	PTFE	H	0,64 (G23s)	-	2620703	-	-
250 µL	7,8	PTFE	H	0,47 (G26)	-	2620803	-	-
250 µL	6,5	PTFE	H	0,64 (G23)	-	2620809	-	2620812
500 µL	7,8	PTFE	H	0,47 (G26)	-	2620903	-	-
500 µL	6,5	PTFE	H	0,64 (G23)	-	2620909	-	2620906

*All other trademarks, service marks, registered trademarks, and registered service marks are the property of their respective owners. Gardner Denver and ILS are not affiliated with LEAP, CTC, Carlo Erba and Finsons in any way.

Dosage in Autosampler - GC Autosampler

HEADSPACE SAMPLING



d



TECHNICAL INFORMATION

Fixed Needles (FN)

Glass Barrel: Borosilicate 3.3

Needle Tip			d	d
			(FN)	(FN)
Length			51 mm	56 mm
Volume	Plunger Tip	O.D. (Gauge)	Part No.	Part No.
1.0 mL	PTFE	0.47 (G26)	2620003	2620014
1.0 mL	PTFE	0.64 (G23)	2620002	2620012
1.0 mL	PTFE	0.72 (G22)	-	2620013
2.5 mL	PTFE	0.47 (G26)	2620040	2620034
2.5 mL	PTFE	0.64 (G23)	2620043	2620032
2.5 mL	PTFE	0.72 (G22)	2620024	2620023
5.0 mL	PTFE	0.47 (G26)	2620053	2620051
5.0 mL	PTFE	0.64 (G23)	2620052	2620050
5.0 mL	PTFE	0.72 (G22)	-	2620049

Dosage in Autosampler - GC Autosampler

MITSUBISHI* DIA INSTRUMENTS



TECHNICAL INFORMATION

Fixed Needles (FN)

Glass Barrel: Borosilicate 3.3

Needle Tip				c
				(FN)
Length				50 mm
Volume	Plunger Tip	O.D. (Gauge)	Part No.	
50 µL	PTFE	0.64 (G23s)	2606604	
100 µL	PTFE	0.64 (G23s)	2606704	
250 µL	PTFE	0.64 (G23s)	2606801	

*All other trademarks, service marks, registered trademarks, and registered service marks are the property of their respective owners. Gardner Denver and ILS are not affiliated with Mitsubishi in any way.

Dosage in Autosampler - GC Autosampler

DANI* ALS

ALS 104

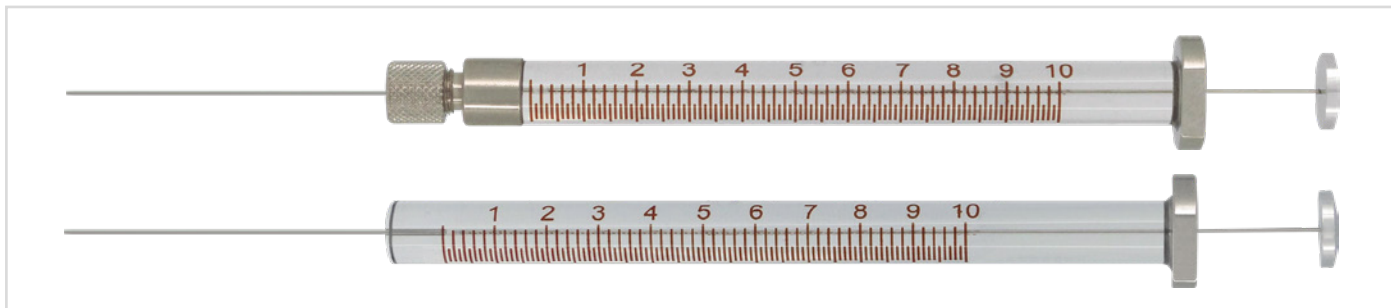

TECHNICAL INFORMATION

Fixed Needles (FN)

Removable Needles (RN)

Glass Barrel: Borosilicate 3.3

Stainless Steel = sst*

Needle Tip			d	d
			(FN)	(RN)
Length			51 mm	51 mm
Volume	Plunger Tip	O.D. (Gauge)	Part No.	Part No.
10 µL	sst*	0.64 (G23s)	2120410	2120408
10 µL	PTFE	0.64 (G23s)	2607404	2607408

ALS 3841

Needle Tip			d
			(FN)
Length			51 mm
Volume	Plunger Tip	O.D. (Gauge)	Part No.
10 µL	sst*	0.64 (G23s)	2120410

ALS-G

Needle Tip			a	c
			(FN)	(FN)
Length			51 mm	51 mm
Volume	Plunger Tip	O.D. (Gauge)	Part No.	Part No.
10 µL	sst*	0.47 (G26s)	2106401	2106416
10 µL	PTFE	0.47 (G26s)	2606401	2606407

Dosage in Autosampler - GC Autosampler

SIEMENS* LC 12 / 20 / 32; NIPPON* INSTRUMENTS COOPERATION

LC 12 / 20 / 32 (Siemens*)

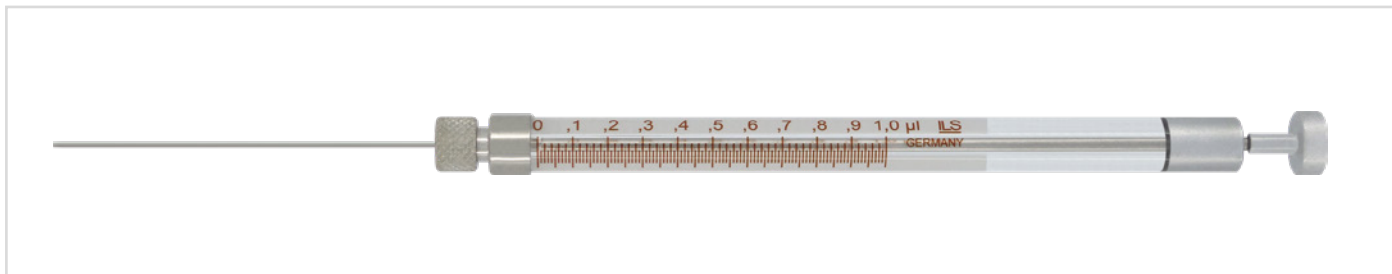
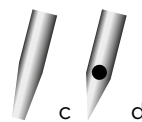

TECHNICAL INFORMATION

Fixed Needles (FN)

Removable Needles (RN)

Glass Barrel: Borosilicate 3.3

Stainless Steel = sst*

Zero Dead Volume (plunger in needle) = T

Needle Tip					c
					(RN)
Length					70 mm
Volume	Series	Plunger Tip	O.D. (Gauge)	Part No.	
1 µL	T	sst*	0.64 (G23)	2200115	

PE-1000, RA-342 (Nippon* Corp.)

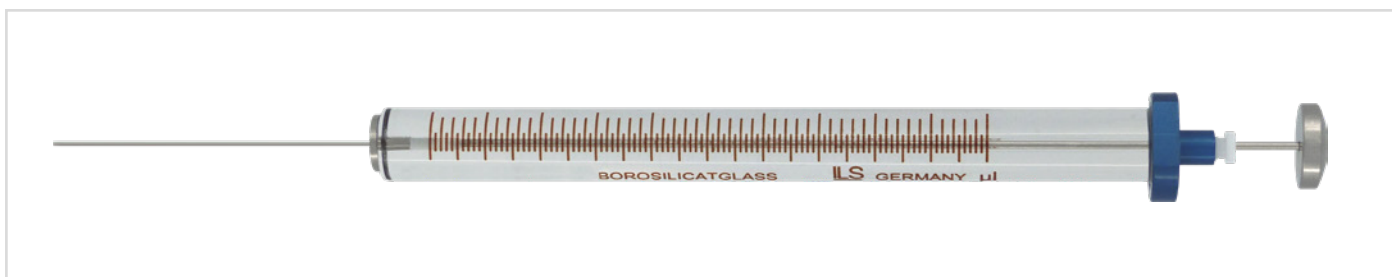

Needle Tip					d
					(FN)
Length					55 mm
Volume	Series	Plunger Tip	O.D. (Gauge)	Part No.	
50 µL	A	PTFE - black	0.72 (G22)	2600642	
100 µL	A	PTFE - black	0.72 (G22)	2600742	

Dosage in Autosampler - HPLC Autosampler

SPARK*



TECHNICAL INFORMATION

PTFE-Seal:

- Chemically resistant
- Heavy duty syringes

Glass Barrel: Borosilicate 3.3

Volume	Series	Plunger Tip	Front Fitting	Part No.
25 µL	H	PTFE	1/4"-28 UNF	2608517
50 µL	H	PTFE	1/4"-28 UNF	2608617
100 µL	H	PTFE	1/4"-28 UNF	2608717
250 µL	H	PTFE	1/4"-28 UNF	2608817
500 µL	H	PTFE	1/4"-28 UNF	2608917
1.0 mL	H	PTFE	1/4"-28 UNF	2608017

HDPE-Seal

- Chemically resistant
- Long lifetime
- Good resistance to strong buffers and other aqueous solution

Glass Barrel: Borosilicate 3.3

Volume	Series	Plunger Tip	Front Fitting	Part No.
25 µL	H	HDPE	1/4"-28 UNF	2608518
50 µL	H	HDPE	1/4"-28 UNF	2608622
100 µL	H	HDPE	1/4"-28 UNF	2608722
250 µL	H	HDPE	1/4"-28 UNF	2608822
500 µL	H	HDPE	1/4"-28 UNF	2608922
1,0 mL	H	HDPE	1/4"-28 UNF	2608022

PTFE-Seal with Silicone

- Specially designed for handling of strong buffers and other aqueous solutions

Glass Barrel: Borosilicate 3.3

Volume	Series	Plunger Tip	Front Fitting	Part No.
25 µL	H	PTFE	1/4"-28 UNF	2608521
50 µL	H	PTFE	1/4"-28 UNF	2608621
100 µL	H	PTFE	1/4"-28 UNF	2608721
250 µL	H	PTFE	1/4"-28 UNF	2608821
500 µL	H	PTFE	1/4"-28 UNF	2608921
1,0 mL	H	PTFE	1/4"-28 UNF	2608021

Dosage in Autosampler - HPLC Autosampler

PERKIN ELMER*

Perkin Elmer* Series 200 Autosampler H-CX



Perkin Elmer* Series 200 Autosampler H-C



TECHNICAL INFORMATION

Glass Barrel: Borosilicate 3.3

Volume	Plunger Tip	Front Fitting	Plunger Tip	H / CX	H / C
				Part No.	Part No.
50 µL	PTFE	1/4"x28 UNF	6-32 UNC	2606615	-
250 µL	PTFE	1/4"x28 UNF	6-32 UNC	2606815	-
500 µL	PTFE	1/4"x28 UNF	6-32 UNC	2606915	-
1.0 mL	PTFE	1/4"x28 UNF	6-32 UNC	-	2606015
2.5 mL	PTFE	1/4"x28 UNF	6-32 UNC	-	2606035

*All other trademarks, service marks, registered trademarks, and registered service marks are the property of their respective owners. Gardner Denver and ILS are not affiliated with Perkin Elmer in any way.

Dosage in Autosampler - HPLC Autosampler

WATERS* WISP**

WATERS* WISP**, plastic coated safety syringes



TECHNICAL INFORMATION

Glass Barrel: Borosilicate 3.3

Volume	Series	Plunger Tip	Front Fitting	Plunger Top	Part No.
25 µL	H	PTFE	1/4"x28 UNF	4-40 UNC	2663514
250 µL	H	PTFE	1/4"x28 UNF	4-40 UNC	2663814
500 µL	H	PTFE	1/4"x28 UNF	4-40 UNC	2663914
2.5 mL	H	PTFE	1/4"x28 UNF	4-40 UNC	2663034

Dosage in Autosampler - HPLC Autosampler

THERMO* FINNIGAN, THERMO* SEPARATION, SPECTRA-PHYSICS*, VARIAN*



Thermo* Finnigan

Thermo* Separation / Spectra-Physics* / SP 8780 / SP 8875 / SP 8880

Thermo* Separation AS 100 / AS 300 / AS 1000 / AS 3000 / AS 3500

Varian* 9090

TECHNICAL INFORMATION

Glass Barrel: Borosilicate 3.3

Volume	Series	Plunger Tip	Front Fitting	Part No.
100 µL	H/C	PTFE	1/4"-28 UNF	2606714
250 µL	H/C	PTFE	1/4"-28 UNF	2606814
500 µL	H/C	PTFE	1/4"-28 UNF	2606914
1.0 mL	H/C	PTFE	1/4"-28 UNF	2606015
2.5 mL	H/C	PTFE	1/4"-28 UNF	2606035

SHIMADZU* SIL 6A / 9A



TECHNICAL INFORMATION

Glass Barrel: Borosilicate 3.3

Volume	Glass Barrel O.D.	Plunger Tip	Front Fitting	Part No.
100 µL	8.0 mm	PTFE	1/4"-32 UNEF	2606700

Dosage in Autosampler - HPLC Autosampler

HITACHI* / LACHROM*

Hitachi* L-7200 / L-7250 / L-2200 / L-8800 / L-8900 / AS1000 / AS2000 / AS42000 / VWR LaChrom* Elite



TECHNICAL INFORMATION

Glass Barrel: Borosilicate 3.3

Volume	Series	Plunger Tip	Front Fitting	Part No.	
100 µL	H	PTFE	M10x1	2611712	with guide
500 µL	H	PTFE	M10x1	2611912	with guide
1.0 mL	H	PTFE	M10x1	2611012	
2.5 mL	H	PTFE	M10x1	2611032	

Volume	Series	Plunger Tip	Front Fitting	Part No.	
100 µL	H	PTFE-Black-Seal	M10x1	2611715	with guide
500 µL	H	PTFE-Black-Seal	M10x1	2611915	with guide
1.0 mL	H	PTFE-Black-Seal	M10x1	2611015	
2.5 mL	H	PTFE-Black-Seal	M10x1	2611035	

Dosage in Autosampler - HPLC Autosampler

AGILENT* (HP)



TECHNICAL INFORMATION

Removable Needle (RN)
(needle not included - please order it separately)

Glass Barrel: Borosilicate 3.3

Volume	Series	Plunger Tip	Front Fitting	Part No.
25 µL	H	PTFE	1/4" - 32 UNEF	2606500
50 µL	H	PTFE	1/4" - 32 UNEF	2606600
100 µL	H	PTFE	1/4" - 32 UNEF	2606700
250 µL	H	PTFE	1/4" - 32 UNEF	2606800
500 µL	H	PTFE	1/4" - 32 UNEF	2606900

Dosage in Autosampler - HPLC Autosampler

KONTRON* 360, 460 & 465



TECHNICAL INFORMATION

Glass Barrel: Borosilicate 3.3

Volume	Series	Plunger Tip	Front Fitting	Part No.
50 µL	H	PTFE	M8x0.75	2652616
100 µL	H	PTFE	M8x0.75	2652716
250 µL	H	PTFE	M8x0.75	2652816
500 µL	H	PTFE	M8x0.75	2652916
1.0 mL	H	PTFE	M8x0.75	2652016
2.5 mL	H	PTFE	M8x0.75	2652036

Dosage in Autosampler - HPLC Autosampler

GYNKOTEK DIONEX* GINA

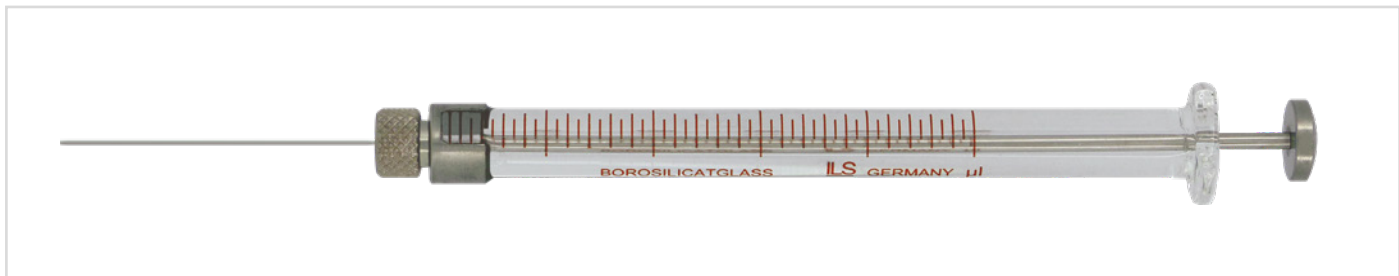

TECHNICAL INFORMATION

Removable Needle (RN)

Glass Barrel: Borosilicate 3.3

Needle Tip					a
					(RN)
Length					51 mm
Volume	Series	Plunger Tip	O.D. (Gauge)	Part No.	
25 µL	H	PTFE	0.72 (G22s)	2606505	
250 µL	H	PTFE	0.72 (G22s)	2606805	

Dionex* ASI 100 w/o needle

Volume	Series	Plunger Tip	Front Fitting	Part No.
25 µL	H	PTFE	1/4"-32 UNEF	2606509
250 µL	H	PTFE	1/4"-32 UNEF	2606802

Dosage in Autosampler - HPLC Autosampler

LEAP*, CTC*

LEAP*, CTC*-HTC PAL / HTS PAL / LC PAL - with STOP



TECHNICAL INFORMATION

Fixed Needles (FN)

Glass Barrel: Borosilicate 3.3
Stainless Steel = sst*

Needle Tip						b	b
						(FN)	(FN)
Length						51 mm	56 mm
Volume	Glass Barrel O.D. mm	Plunger Tip	Series	O.D. Gauge			
10 µL	6,5	sst*	N	0,72(G22s)	2120402	-	
10 µL	6,5	sst*	A	0,72(G22s)	2106447	-	
10 µL	6,5	PTFE	H	0,72(G22s)	2606420	-	
25 µL	7,8	PTFE	H	0,72(G22s)	2620519	2620511	
50 µL	6,5	PTFE	H	0,72(G22s)	2620616	-	
50 µL	6,5	PTFE	H	0,72(G22)	2620617	-	
100 µL	6,5	PTFE	H	0,72(G22s)	2620770	-	
100 µL	6,5	PTFE	H	0,72(G22)	2620772	-	
250 µL	7,8	PTFE	H	0,72(G22)	2620810	-	
500 µL	7,8	PTFE	H	0,72(G22)	2620908	2620914	

Dosage in Autosampler - HPLC Autosampler

LEAP*, CTC*

LEAP* / CTC* / HTS PAL / HTC PAL / LC PAL - with KNOB



TECHNICAL INFORMATION

Fixed Needles (FN)

Glass Barrel: Borosilicate 3.3
Stainless Steel = sst*

Needle Tip					b	b
					(FN)	(FN)
Length					51 mm	56 mm
Volume	Glass Barrel O.D. mm	Plunger Tip	Series	O.D. Gauge		
10 µL	6,5	PTFE	H	0,72(G22s)	2606416	
25 µL	6,5	PTFE	H	0,72(G22s)	2620517	
25 µL	6,5	HDPE	H	0,72(G22s)	2620521	
25 µL	7,8	PTFE	H	0,72(G22s)	2620504	2620502
25 µL	7,8	HDPE	H	0,72(G22s)		2620520
50 µL	6,5	PTFE	H	0,72(G22s)	2620602	
50 µL	6,5	PTFE	H	0,72(G22)	2620605	
50 µL	6,5	HDPE	H	0,72(G22s)	2620609	
50 µL	6,5	HDPE	H	0,72(G22)	2620608	
100 µL	6,5	PTFE	H	0,72(G22s)	2620702	
100 µL	6,5	PTFE	H	0,72(G22)	2620705	
100 µL	6,5	PE-HD	H	0,72(G22s)	2620708	
100 µL	6,5	PE-HD	H	0,72(G22)	2620709	
250 µL	7,8	PTFE	H	0,72(G22)	2620805	
1,0 mL	7,8	PTFE	H	0,72(G22)	2620010	
2,5 mL	9,8	PTFE	H	0,72(G22)	2620041	2620030
5,0 mL	13,5	PTFE	H	0,72(G22)	2620058	2620056

Dosage in Autosampler - CTC Instruments

COMBI & GC PAL

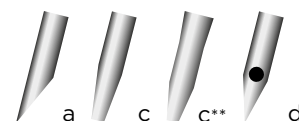

TECHNICAL INFORMATION

Fixed Needles (FN)

Glass Barrel: Borosilicate 3.3

Stainless Steel = sst*

Zero Dead Volume = T

Needle Tip				a	c	d	
				(FN)	(FN)	(FN)	
Length				51 mm	51 mm	56 mm	CTC
Volume	Series	Plunger Tip	O.D. (Gauge)	Part No.	Part No.	Part No.	Part No.
1.2 µL	T	sst*	26P	-	2220001	-	SYRC L 1.2-26P-AS

5 µL	N	sst*	0.47 (G26s)	-	2106302	-	SYRC L 5-26S-AS
5 µL	N	sst*	0.47 (G26s)	2106301	-	-	-
10 µL	N	sst*	0.47 (G26s)	-	2106416	-	SYRC L 10-26S-AS
10 µL	N	sst*	0.47 (G26s)	2106401	-	-	SYRC L 10-26S-2
10 µL	N	sst*	0.64 (G23s)	-	2106403	-	SYRC L 10-23S-AS
10 µL	N	sst*	0.64 (G23s)	2106422	-	-	SYRC L 10-23S-2
10 µL	N	sst*	0.47/0.64**	-	2106426	-	SYRC 10-23S/26S-AS

25 µL	H	PTFE	0.47 (G26s)	-	2620508	-	SYRC G 25-26S-AS
25 µL	H	PTFE	0.47 (G26s)	-	2620506	-	SYRC G 25S-26S-AS
100 µL	H	PTFE	0.47 (G26s)	-	2620706	-	SYRC G 100-26S-AS
250 µL	H	PTFE	0.47 (G26)	-	2620806	-	SYRC G 250-26-AS
500 µL	H	PTFE	0.47 (G26)	-	2620903	-	SYRC G 500-26-AS

1.0 mL	H	PTFE	0.47 (G26)	-	-	2620014	SYRC HS 1.0-26-5
1.0 mL	H	PTFE	0.64 (G23)	-	-	2620012	SYRC HS 1.0-23-5
2.5 mL	H	PTFE	0.47 (G26)	-	-	2620034	SYRC HS 2.5-26-5
2.5 mL	H	PTFE	0.64 (G23)	-	-	2620032	SYRC HS 2.5-23-5
5.0 mL	H	PTFE	0.64 (G23)	-	-	2620050	SYRC HS 5.0-23-5

Dosage in Autosampler - CTC Instruments

HTS, HTC, LC PAL



TECHNICAL INFORMATION

Fixed Needle (FN)

Glass Barrel: Borosilicate 3.3
Stainless Steel = sst*

Needle Tip			b	
			(FN)	
Length			51 mm	CTC
Volume	Plunger Tip	O.D. (Gauge)	Part No.	Part No.
10 µL	sst*	0.72 (G22s)	2106424	SYRC L 10-22S-3

10 µL	PTFE	0.72 (G22s)	2606416	SYRC G 10-22S-3
25 µL	PTFE	0.72 (G22s)	2620517	SYRC G 25-22S-3
100 µL	PTFE	0.72 (G22s)	2620702	SYRC G 100-22S-3
100 µL	PTFE	0.72 (G22)	2620705	SYRC G 100-22-3
250 µL	PTFE	0.72 (G22)	2620805	SYRC G 250-22-3
1.0 mL	PTFE	0.72 (G22)	2620010	SYRC G 1000-22-3
2.5 mL	PTFE	0.72 (G22)	2620041	SYRC G 2500-22-3
5.0 mL	PTFE	0.72 (G22)	2620058	SYRC G 5000-22-3

Dosage in Autosampler - CTC Instruments

R-SERIES

Plunger end piece golden color: indication for coated needle protects the plunger before damage

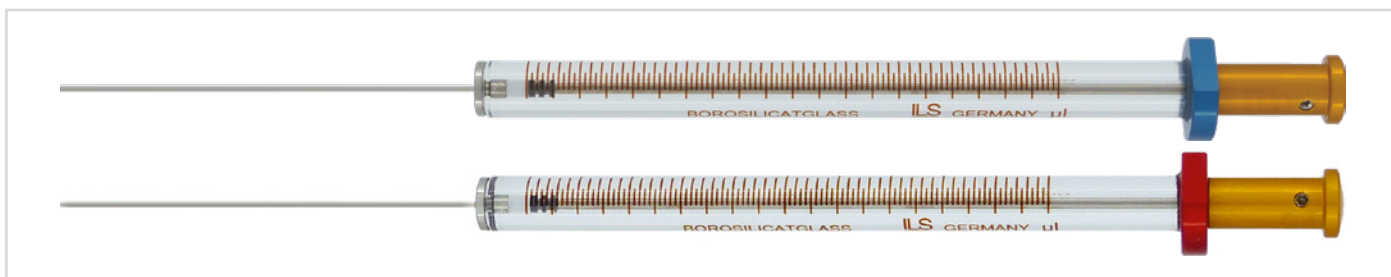

TECHNICAL INFORMATION

Glass Barrel: Borosilicate 3.3

Fixed Needles (FN)

PTFE-Black-Seal

Needle Tip						b
						(FN)
Length						51 mm
Volume	Series	Glass Barrel	Plunger Tip	O.D. (Gauge)	Part No.	
10 µL	R	6.5 mm	PTFE - black	0.72 (G22s) coated	2620440	
25 µL	R	6.5 mm	PTFE - black	0.72 (G22s) coated	2620540	
25 µL	R	6.5 mm	PTFE - black	0.72 (G22) coated	2620541	
50 µL	R	6.5 mm	PTFE - black	0.72 (G22s) coated	2620640	
50 µL	R	6.5 mm	PTFE - black	0.72 (G22) coated	2620641	
100 µL	R	6.5 mm	PTFE - black	0.72 (G22s) coated	2620740	
100 µL	R	6.5 mm	PTFE - black	0.72 (G22) coated	2620741	
250 µL	R	6.5 mm	PTFE - black	0.72 (G22s) coated	2620840	
250 µL	R	6.5 mm	PTFE - black	0.72 (G22) coated	2620841	

HDPE-Seal

Needle Tip						b
						(FN)
Length						51 mm
Volume	Series	Glass Barrel	Plunger Tip	O.D. (Gauge)	Part No.	
25 µL	R	6.5 mm	HDPE	0.72 (G22s) coated	2620542	
25 µL	R	6.5 mm	HDPE	0.72 (G22) coated	2620543	
50 µL	R	6.5 mm	HDPE	0.72 (G22s) coated	2620642	
50 µL	R	6.5 mm	HDPE	0.72 (G22) coated	2620643	
100 µL	R	6.5 mm	HDPE	0.72 (G22s) coated	2620742	
100 µL	R	6.5 mm	HDPE	0.72 (G22) coated	2620743	

Dosage in Autosampler - CTC Instruments

DLW

These syringes are designed, for the nearly carry-over free method. PTFE-Black-Seal plunger tip and the plunger guide ensure a long lifetime.

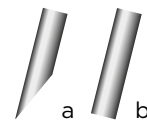

TECHNICAL INFORMATION

Glass Barrel: Borosilicate 3.3

PTFE-Seal

Volume	Plunger tip	Front Fitting	Part No.	Part No.	Replacement Plunger
				6-Pack	6-Pack
50 µL	PTFE	1/4"-28 UNF	2620635	-	-
100 µL	PTFE	1/4"-28 UNF	2620735	2620735-6P	2636736
250 µL	PTFE	1/4"-28 UNF	2620835	-	-
500 µL	PTFE	1/4"-28 UNF	2620935	-	-

PTFE-Black-Seal

Volume	Plunger tip	Front Fitting	Part No.	Part No.	Replacement Plunger
				6-Pack	6-Pack
10 µL	PTFE - black	1/4"-28 UNF	2620435-BL		
50 µL	PTFE - black	1/4"-28 UNF	2620635-BL		
100 µL	PTFE - black	1/4"-28 UNF	2620735-BL		2636736-BL
250 µL	PTFE - black	1/4"-28 UNF	2620835-BL		2636835-BL
500 µL	PTFE - black	1/4"-28 UNF	2620935-BL		2636935-BL
1,0 mL	PTFE - black	1/4"-28 UNF	2620080-BL		2636086-BL

With Integrated Washer

Volume	Plunger tip	Front Fitting	Part No.	Part No.	Replacement Plunger
				6-Pack	6-Pack
100 µL	PTFE - black	1/4"-28 UNF	2620755-BL	2620755-BL-6P	2636736-BL

Replacement needles

O.D. (Gauge)	Tip Style	Length	Coated	non coated
0,72 (G22)	a	59,4	21080736	21080734
0,72 (G22)	b	58,7	21080735	21080733
0,72 (G22s)	b	58,7	21080740	

Dosage in Autosampler - One Lambda Jet*

ONE LAMBDA JET*



TECHNICAL INFORMATION

Removable Needles (RN)

Glass Barrel: Borosilicate 3.3

Needle Tip			b
			(RN)
Length			42 mm
Volume	Plunger Tip	O.D. (Gauge)	Part No.
200 µL	PTFE	0.72 (G22)	2653706

Dosage in Autosampler - TLC Camag*

LINOMAT III, IV AND V



TECHNICAL INFORMATION

Needle: especially developed for Linomat III, IV and V

Main usage:

- Thin Layer Chromatography (TLC)

Glass Barrel: Borosilicate 3.3

Fixed Needles (FN)

Volume	Plunger Tip	Part No.
25 µL	PTFE	2606504
100 µL	PTFE	2606702
500 µL	PTFE	2606902

Dosage in Autosampler - Robbins Hydra

HYDRA 96

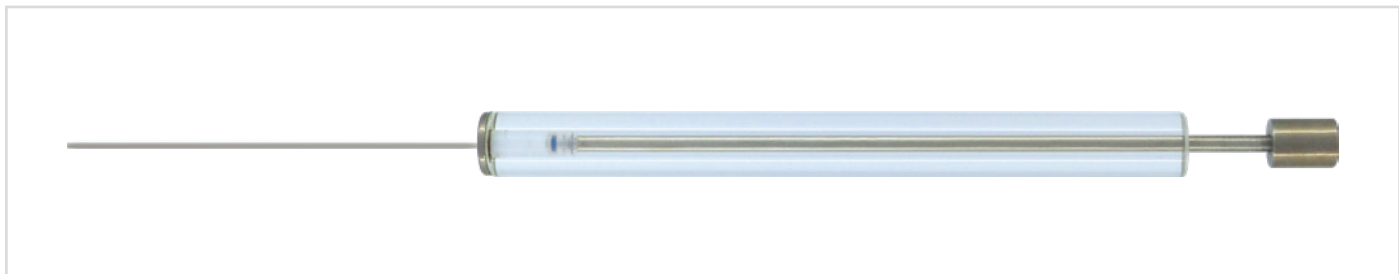

TECHNICAL INFORMATION

Fixed Needles (FN)

Glass Barrel: Borosilicate 3.3

Needle: PTFE coated

Hydra 96

Syringe					Replacement Seal			
Needle Tip				b				
				(FN)				
Length				62 mm				
Volume	Series	Plunger Tip	O.D. x I.D.	Part No.	Part No.	Part No.	Part No.	
				10-Pack		50-Pack		100-Pack
100 µL	H	PTFE	0.45 x 0.25	2615700	2615702	2615705	2615709	
290 µL	H	PTFE	0.70 x 0.40	2615800	2615802	2615805	2615809	
580 µL	H	PTFE	0.70 x 0.40	2615900	2615902	2615905	2615909	
1.0 mL	H	PTFE	0.70 x 0.40	2615100	2615102	2615105	2615109	

R / B

Syringe					Replacement Seal			
Needle Tip				b				
				(FN)				
Length				62 mm				
Volume	Series	Plunger Tip	O.D. x I.D.	Part No.	Part No.	Part No.	Part No.	
				10-Pack		50-Pack		100-Pack
290 µL	H	PTFE	1.20 x 0.80	2615810	2615812	2615815	2615819	
580 µL	H	PTFE	1.20 x 0.80	2615910	2615912	2615915	2615919	
1.0 mL	H	PTFE	1.20 x 0.80	2615110	2615112	2615115	2615119	

Dosage in Autosampler - Robbins Hydra

HYDRA 384



TECHNICAL INFORMATION

Fixed Needles (FN)

Glass Barrel: Borosilicate 3.3

Needle: PTFE coated

Syringe					Replacement Seal			
Needle Tip					b			
					(FN)			
Length					62 mm			
Volume	Series	Plunger Tip	O.D. x I.D.	Part No.	Part No.	Part No.	Part No.	
					10-Pack	50-Pack	100-Pack	
100 µL	H	PTFE	0.45 x 0.25	2615760	2615702	2615705	2615709	

HYDRA 384

With metal jacket



TECHNICAL INFORMATION

Fixed Needles (FN)

Needle: PTFE coated

Syringe					Replacement Seal			
Needle Tip					b			
					(FN)			
Length					62 mm			
Volume	Series	Plunger Tip	O.D. x I.D.	Part No.	Part No.	Part No.	Part No.	
					10-Pack	50-Pack	100-Pack	
100 µL	H	PTFE	0.45 x 0.25	2615764	2615702	2615705	2615709	

Dosage in Autosampler - Olympus* AU

CHEMISTRY ANALYZER

Page 108 Olympus* ZM0111

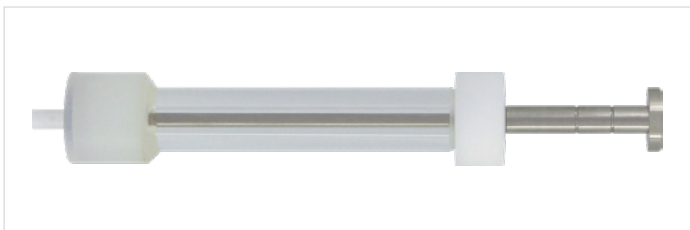

Page 108 Olympus* ZM0112



Page 108 Olympus* ZM0018



Page 108 Olympus* ZM0179



TECHNICAL INFORMATION

Glass Barrel: Borosilicate 3.3

PTFE-Seal

Description	Plunger Tip	Part No.
ZM0112 ISE Reagent	PTFE	2678000
ZM0111 Sample	PTFE	2678001
ZM0179 R Type	PTFE	2678002
ZM0018 G Type	PTFE	2678003

NEEDLES

ILS REMOVABLE NEEDLES	116
NLL NEEDLES METAL LUER SCREW	117
KNLL NEEDLES PLASTIC LUER SCREW	118
HAMILTON* REMOVABLE NEEDLES	119
CLEANING WIRES	119

Needles

ILS REMOVABLE NEEDLES

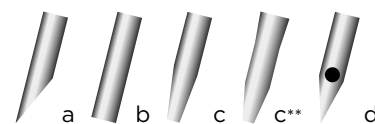

TECHNICAL INFORMATION

O.D. (Gauge)	Length	Needle Tip		5 µL		10 µL		25 µL - 100 µL		250 µL - 10.0 mL	
				Part No.	Part No.	Part No.	Part No.	Part No.	Part No.		
0.47	42 mm	a	3-Pack	2865308	2865408	-	-	-	-	-	-
0.47	42 mm	c	3-Pack	2834307	2834407	-	-	-	-	-	-
0.47	51 mm	a	3-Pack	2832301	2832401	-	-	-	-	-	-
0.47	51 mm	b	3-Pack	2832302	2832402	-	-	-	-	-	-
0.47	51 mm	c	3-Pack	2832303	2832403	-	-	-	-	-	-
0.47	51 mm	d	2-Pack	2832304	2832404	-	-	-	-	-	-
0.55	51 mm	a	3-Pack	-	-	2831013	-	2841013	-	-	-
0.55	51 mm	b	3-Pack	-	-	2831014	-	2841014	-	-	-
0.55	51 mm	d	2-Pack	-	-	2831015	-	2841015	-	-	-
0.64 / 0.47	42 mm	c**	3-Pack	2834308	2834408	-	-	-	-	-	-
0.64	42 mm	c	3-Pack	2834309	2834409	-	-	-	-	-	-
0.72	51 mm	a	3-Pack	-	-	2832501	-	2832601	-	-	-
0.72	51 mm	c	3-Pack	-	-	2832503	-	2832603	-	-	-
0.72	51 mm	d	2-Pack	-	-	2832504	-	2832604	-	-	-
0.90	51 mm	a	3-Pack	-	-	-	-	2831023	-	-	-
1.10	51 mm	a	3-Pack	-	-	-	-	2831027	-	-	-
2.00	51 mm	a	2-Pack	-	-	-	-	2831029	-	-	-

HP 7670 - 7672

0.47	51 mm	a	3-Pack	2860307	2860407	-	-	-	-	-	-
------	-------	---	--------	---------	---------	---	---	---	---	---	---

Waters*

0.50	50 mm	b	3-Pack	2832306	2832406	2832506	-	2842606	-	-	-
------	-------	---	--------	---------	---------	---------	---	---------	---	---	---

Valco* VISF-1

0.72	19 mm	b	3-Pack	2833305	2833405	2833506	-	2833505	-	-	-
------	-------	---	--------	---------	---------	---------	---	---------	---	---	---

Rheodyne*

0.72	51 mm	b	3-Pack	2831305	2831405	2831505	-	2832602	-	-	-
------	-------	---	--------	---------	---------	---------	---	---------	---	---	---

Needles

NLL NEEDLES METAL LUER SCREW



TECHNICAL INFORMATION

Length: 51 mm

Needle: CrNi 1.4301 (AISI SS 304)

Luer: brass, nickel plated

Needle Tip			a	b	d
Gauge	O.D. (mm)	I.D. (mm)	Part No.	Part No.	Part No.
			3-Pack	3-Pack	2-Pack
G32	0.25	0.11	2840025	2842025	-
G30	0.30	0.15	2840030	2842030	-
G29	0.35	0.15	2840035	2842035	-
G27	0.40	0.20	2840040	2842040	-
G26	0.45	0.25	2840045	2842045	2843045
G26s	0.47	0.13	2840047	2842047	-
G25	0.50	0.28	2840050	2842050	2843050
G24	0.55	0.32	2840055	2842055	2843055
G23	0.64	0.35	2840065	2842065	2843065
G22	0.72	0.40	2840070	2842070	2843070
G22s	0.72	0.20	2840072	2842072	-
G21	0.80	0.50	2840080	2842080	2843080
G20	0.90	0.60	2840090	2842090	2843090
-	1.00	0.68	2840100	2842100	2843100
G19	1.10	0.80	2840110	2842110	2843110
G18	1.30	0.90	2840130	2842130	2843130
G17	1.50	1.10	2840150	2842150	2843150
G16	1.70	1.20	2840170	2842170	2843170
G15	1.80	1.40	2840180	2842180	2843180
-	2.00	1.26	2840200	2842200	2843200
G13	2.40	1.90	2840240	2842240	2843240
G12	2.80	2.20	2840280	2842280	2843280
-	3.00	2.60	2840302	2842302	2843302
G11	3.00	2.40	2840304	2842304	2843304
G10	3.40	2.70	2840340	2842340	2843340

Needles

KNLL NEEDLES PLASTIC LUER SCREW



TECHNICAL INFORMATION

Length: 51 mm

Needle: CrNi 1.4301 (AISI SS 304)

Luer: Polyvinylidenfluorid (PVDF)

Needle Tip			a	b	d
Gauge	O.D. (mm)	I.D. (mm)	Part No.	Part No.	Part No.
			3-Pack	3-Pack	2-Pack
G32	0.25	0.11	2846025	2849025	-
G30	0.30	0.15	2846030	2849030	-
G29	0.35	0.15	2846035	2849035	-
G27	0.40	0.20	2846040	2849040	-
G26	0.45	0.25	2846045	2849045	2844045
G26s	0.47	0.13	2846047	2849047	-
G25	0.50	0.28	2846050	2849050	2844050
G24	0.55	0.32	2846055	2849055	2844055
G23	0.64	0.35	2846065	2849065	2844065
G22	0.72	0.40	2846070	2849070	2844070
G22s	0.72	0.20	2846072	2849072	-
G21	0.80	0.50	2846080	2849080	2844080
G20	0.90	0.60	2846090	2849090	2844090
-	1.00	0.68	2846100	2849100	2844100
G19	1.10	0.80	2846110	2849110	2844110
G18	1.30	0.90	2846130	2849130	2844130
G17	1.50	1.10	2846150	2849150	2844150
G16	1.70	1.20	2846170	2849170	2844170
G15	1.80	1.40	2846180	2849180	2844180
-	2.00	1.26	2846200	2849200	2844200
G13	2.40	1.90	2846240	2849240	2844240
G12	2.80	2.20	2846280	2849280	2844280
-	3.00	2.06	2846302	2849302	2844302
G11	3.00	2.40	2846304	2849304	2844304
G10	3.40	2.70	2846340	2849340	2844340

Needles

HAMILTON* REMOVABLE NEEDLES



TECHNICAL INFORMATION

Removable needles for Hamilton* syringes

				25 µL - 100 µL	250 µL 10 mL
O.D. (mm)	Length (mm)	Needle Tip		Part No.	Part No.
0.50	50	b	3-Pack	21080426	-
0.47	51	a	6-Pack	21775802	21777904
0.72	51	a	6-Pack	21777003	21777901
0.72	51	b	6-Pack	21777001	-

CLEANING WIRES

TECHNICAL INFORMATION

Gauge	O.D.	Part No.
		12-Pack
G26s, 31, 33	0.09 mm	21018300
G22s, G25, G28, G33	0.13 mm	21018301
G27	0.16 mm	21018302
G24, G26	0.20 mm	21018303

ACCESSORIES

FITTING

Flanged Fitting	122
Clamping Rings	122
Tubing Sets	123
Flangeless Fitting	124
HPLC Fitting	125
HPLC Union	126
Connector for Tube with Thread	127
Connector for Tube with Luer	128
Fitting to Fitting	129
Pipe Thread Fitting	130
Plugs for Valves	131
Plugs for Luer	132

SYRINGE GUIDE **133**

FLANGE TOOL **133**

SYRINGE RACK **134**

WASHERS **135**

Accessories

FLANGED FITTING



TECHNICAL INFORMATION

Need to use without our Clamping Rings

Thread	For tubing with O.D.	Part No.
		10-Pack
1/4"x28	1.6 mm (1/16")	4130019
1/4"-28	2.7 mm	4130025
1/4"-28	3.2 mm (1/8")	4130020

Thread	For tubing with O.D.	Part No.
		10-Pack
M6	1.6 mm (1/16")	4130016
M6	2.7 mm	4130004
M6	3.2 mm (1/8")	4130005

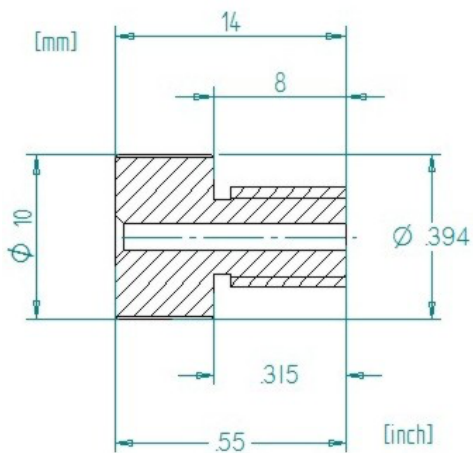

CLAMPING RINGS

For tubing with O.D.	Part No.
ID	10-Pack
1.6 mm	4132016
2.7 mm	4132031
3.2 mm	4132032

Accessories

TUBING SETS

TECHNICAL INFORMATION

Size	Description	Part No.
3.2x1.6	tubing 3.2x1.6 + fitting M6 + washer	4133032
3.2x1.6	tubing 3.2x1.6 + fitting 1/4"-28 UNF + washer	4133033
1.6x0.8	tubing 1.6x0.8 + fitting M6 + washer	4133168
1.6x0.8	tubing 1.6x0.8 + fitting 1/4"-28 UNF + washer	4133169
1.6x0.5	tubing 1.6x0.5 + fitting M6 + washer	4133165
1.6x0.5	tubing 1.6x0.5 + fitting 1/4"-28 UNF + washer	4133166

Accessories

FLANGELESS FITTINGS



TECHNICAL INFORMATION

Description	For tubing with thread	O.D.	Material	Part No.
10-Pack				
Fitting	1/4"-28 UNF	1.6 mm (1/16")	PP	4130066
Fitting	1/4"-28 UNF	3.2 mm (1/8")	PP	4130045
Fitting	1/4"-28 UNF	1.6 mm (1/16")	PEEK	4130079
Fitting	1/4"-28 UNF	3.2 mm (1/8")	PEEK	4130083

Ferrule	-	1.6 mm (1/16")	PTFE	4130058
Ferrule	-	3.2 mm (1/8")	PTFE	4130060
Ferrule	-	1.6 mm (1/16")	PEEK	4130048
Ferrule	-	3.2 mm (1/8")	PEEK	4130065

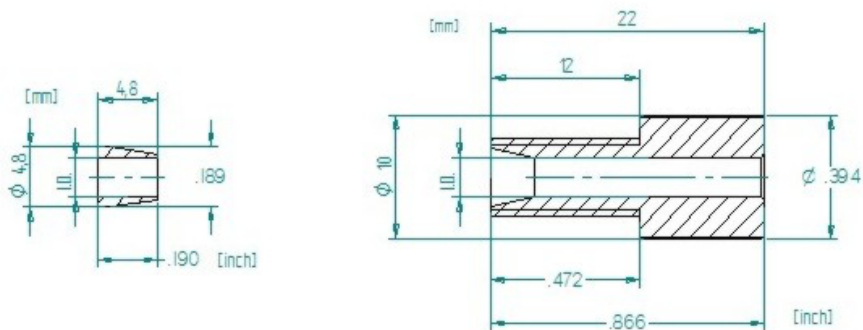

Accessories

HPLC FITTING

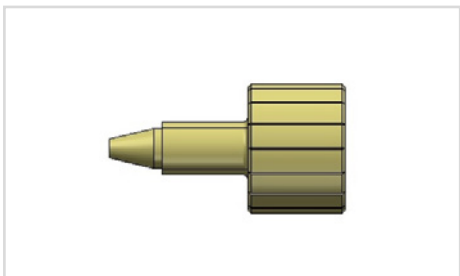

TECHNICAL INFORMATION

Different tubing dimensions and materials are available.

Description	Thread	Tubing O.D.	Material	Part No.
HPLC Fitting	10-32 UNF	1.6 mm (1/16")	PEEK	4130080
HPLC Fitting Spanner Flat	10-32 UNF	1.6 mm (1/16")	PEEK	4130081

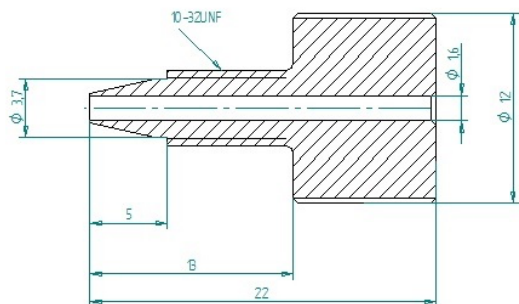

Accessories

HPLC UNION

TECHNICAL INFORMATION

Description	Thread	Tubing O.D.	Material	Part No.
HPLC Union	10-32 UNF	1.6 mm (1/16")	PEEK	4130091

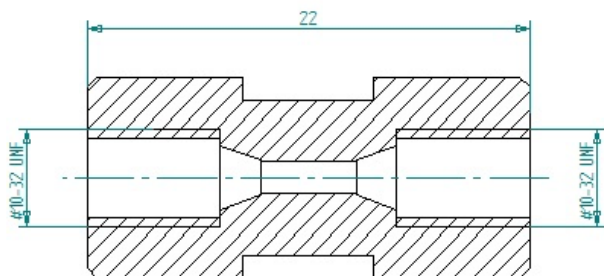

Accessories

CONNECTOR FOR TUBE WITH THREAD



TECHNICAL INFORMATION

Thread	Connection material	O.D.	Part No.
1/4"-28 UNF	Polypropylene (PP)	3 mm	4130024
M6	Polypropylene (PP)	3 mm	4130023

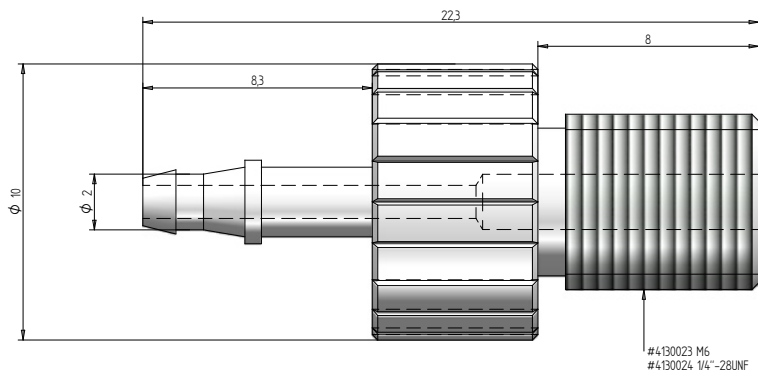

Accessories

CONNECTOR FOR TUBE WITH LUER

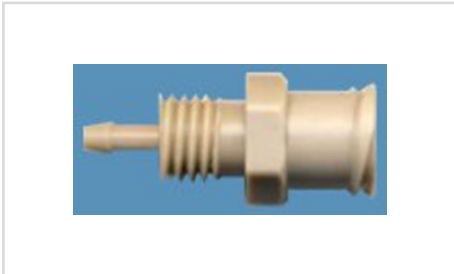

TECHNICAL INFORMATION

Thread	Connection material	O.D.	Part No.
1/4"-28 UNF	PEEK	3 mm	2702226

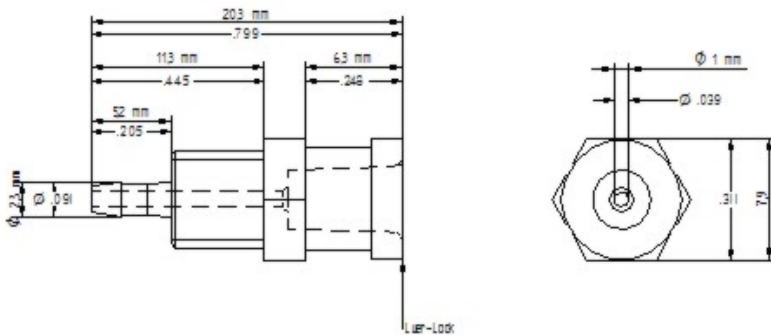

Accessories

FITTING TO FITTING

TECHNICAL INFORMATION

Description	Thread	O.D.	Part No.
Fitting to Fitting	1/4"-28 UNF to 1/4"-28 UNF	1.0 mm	4130076

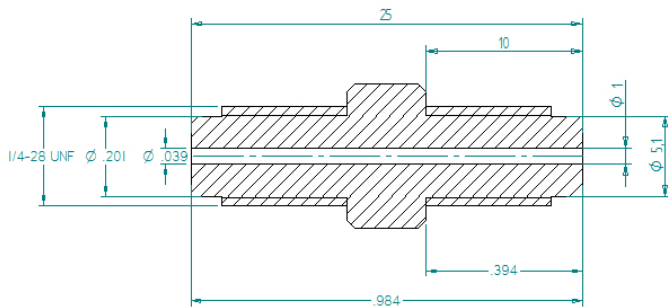

Accessories

PIPE THREAD FITTING

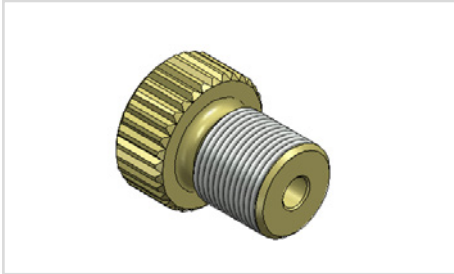

TECHNICAL INFORMATION

Description	Thread	Material	I.D.	Part No.
Fitting short	G 1/8	PEEK	3.2 mm	41006990
Fitting long	G 1/8	PEEK	3.2 mm	41007175

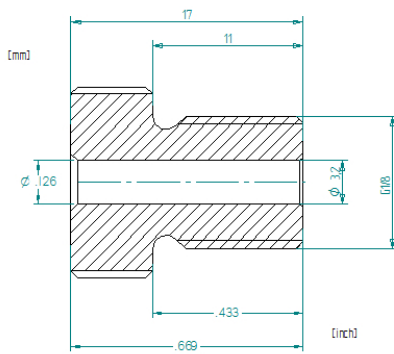

Accessories

PLUGS FOR VALVES

Without bore

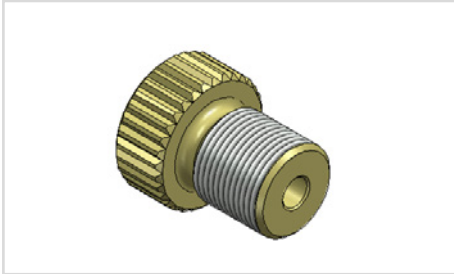

TECHNICAL INFORMATION

	Thread	Part No.
		10-Pack
	M6	4130021
	1/4"-28 UNF	4130022

Accessories

PLUGS FOR LUER



TECHNICAL INFORMATION

Thread	Part No.
	10-Pack
Luer	2702206

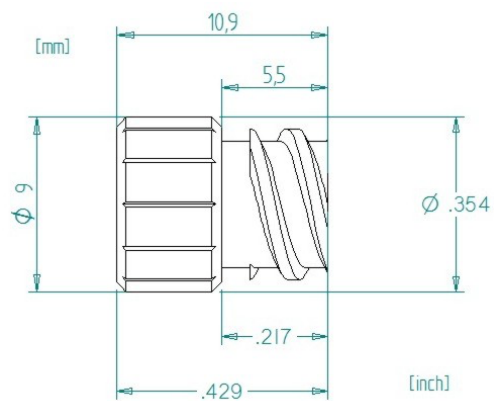

Accessories

SYRINGE GUIDE



TECHNICAL INFORMATION

Made of stainless steel and anodized aluminium.

Part No.

2700001

FLANGE TOOL



TECHNICAL INFORMATION

With ProFlange you can form:

- Conical flanges **without** warm supply medium, hard polymer tubes
- PTFE, PE, ETFE, PP, ect.
- From 1.6 to 3.2 mm external diameter
- Fast, easily, with few carry out movements

Part No.

2700181

Accessories

SYRINGE RACK



TECHNICAL INFORMATION

Rack for 3 syringes

Part No.

2700002



TECHNICAL INFORMATION

Rack for 8 syringes

Part No.

2700201

Accessories

WASHERS



TECHNICAL INFORMATION

Description	O.D.	I.D.	Wall thickness	Material	Part No.
					2-Pack
Washer	5.2 mm	1.9 mm	0.9 mm	PTFE	4132033
Washer	5.2 mm	2.4 mm	0.9 mm	PTFE	4132035

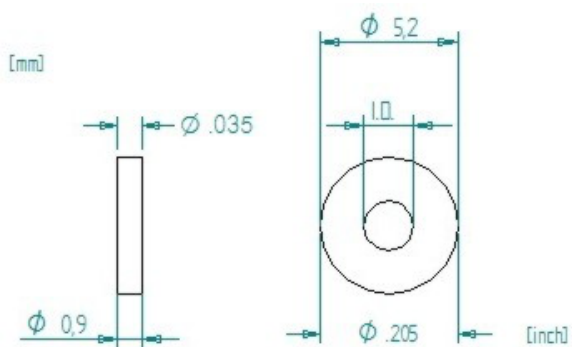

VALVES

VALVES

C3000	138
VP9100 + VP9101	139
Cavro* XP	140
Cavro* XE	141
RQ	142
XL3000	143
Cybertron*	144
PSD 2 / 3	145
Sampling Valves	146
Perkin Elmer* Multi Probe 2	147

Valves

C3000



TECHNICAL INFORMATION

Part No.	2700055
Fitting	1/4"-28 UNF
Ports / Flow path	3-Ports-120°
Syringe connection	1/4"-28 UNF
Fluid contact material (Plug / Body)	PTFE / PCTFE

Alternative Material Combinations

Part No.	2700054
Fitting	1/4"-28 UNF
Fluid contact material (Plug / Body)	PTFE / PEEK

Valves

VP9100



TECHNICAL INFORMATION

Part No.	2700091
Fitting	1/4"-28 UNF
Ports / Flow path	3-Port-120°
Syringe connection	1/4"-28 UNF
Fluid contact material (Plug / Body)	PTFE / PCTFE

VP9101



TECHNICAL INFORMATION

Part No.	2709103
Fitting	1/4"-28 UNF
Ports / Flow path	3-Port-120°
Syringe connection	1/4"-28 UNF
Fluid contact material (Plug / Body)	PTFE / PCTFE

Alternative Material Combinations

Part No.	2729102
Fluid contact material (Plug / Body)	PTFE / PEEK

Valves

CAVRO* XP

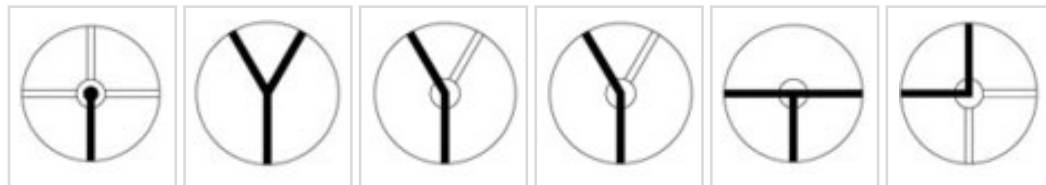

TECHNICAL INFORMATION

Part No.	2700067	2700068	2700069	2700060	2700066	2700065
Fitting	1/4"-28 UNF	1/4"-28 UNF	M6	1/4"-28 UNF	1/4"-28 UNF	1/4"-28 UNF
Ports / Flow path	4-Port-90°	3-Port-120°	3-Port-120°	3-Port-120°	3-Port-T-90°	4-Port-90°
Fluid contact material (Plug / Body)	PTFE / PCTFE	PTFE	PTFE / PCTFE	PTFE / PCTFE	PTFE / PCTFE	PTFE / PCTFE

Alternative Material Combinations

Part No.	2720067	2720068	2720069	2720060	2720066	2720065
Fitting	1/4"-28 UNF	1/4"-28 UNF	M6	1/4"-28 UNF	1/4"-28 UNF	1/4"-28 UNF
Fluid contact material (Plug / Body)	PTFE / PEEK	PTFE / PEEK	PTFE / PEEK	PTFE / PEEK	PTFE / PEEK	PTFE / PEEK

Valves

CAVRO* XE



TECHNICAL INFORMATION

Part No.	2700080	2700081
Fitting	M6	1/4"-28 UNF
Ports / Flow path	3-Port-120°	3-Port-120°
Syringe connection	1/4"-28 UNF	1/4"-28 UNF
Fluid contact material (Plug / Body)	PTFE / PCTFE	PTFE / PCTFE

Alternative Material Combinations		
Part No.	2720080	2720081
Fitting	M6	1/4"-28 UNF
Fluid contact material (Plug / Body)	PTFE / PEEK	PTFE / PEEK

*All other trademarks, service marks, registered trademarks, and registered service marks are the property of their respective owners. Gardner Denver and ILS are not affiliated with Cavro in any way.

Valves

RQ FOR ROSYS* / QIAGEN*

For Rosys* / Qiagen* / Zinsser Instruments



TECHNICAL INFORMATION

Part No.	2700040	2700045
Fitting	M6	1/4"-28 UNF
Ports / Flow path	4-Port-90°	4-Port-90°
Syringe connection	Luer	Luer
Fluid contact material (Plug / Body)	PCTFE / PTFE	PCTFE / PTFE

Valves

XL3000



TECHNICAL INFORMATION

Part No.	2700190	2700191
Fitting	M6	1/4"-28 UNF
Ports / Flow path	3-Port-120°	3-Port-120°
Syringe connection	Luer	Luer
Fluid contact material (Plug / Body)	PTFE / PCTFE	PTFE / PCTFE

Alternative Material Combinations

Part No.	2720190	2720191
Fitting	M6	1/4"-28 UNF
Fluid contact material (Plug / Body)	PTFE / PEEK	PTFE / PEEK

Part No.	-	2700192
Fitting	M6	1/4"-28 UNF
Fluid contact material (Plug / Body)		UHMWPE / PEEK

Valves

CYBERTRON*



TECHNICAL INFORMATION

Part No.	2700064
Fitting	1/4"-28 UNF
Ports / Flow path	3-Port-120°
Syringe connection	Luer
Fluid contact material (Plug / Body)	PTFE / PCTFE

Valves

PSD 2 / 3



TECHNICAL INFORMATION

Part No.	2700021	2700022
Fitting	1/4"-28 UNF	1/4"-28 UNF
Ports / Flow path	3-Port-T	3-Port-T Sampling
Syringe connection	Luer	Luer
Fluid contact material (Plug / Body)	PTFE / PCTFE	PTFE / PCTFE

Valves

SAMPLING VALVES

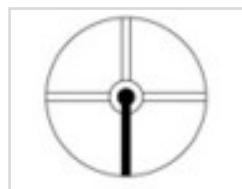

TECHNICAL INFORMATION

Part No.	2700009	2700017
Fitting	For transporting and storing sample in gastight TLL-Syringes	
Ports / Flow path	3-Port-T	1-Port-On / Off
Syringe connection	Luer	Luer
Fluid contact material (Plug / Body)	PTFE / PCTFE	PTFE

Valves

PERKIN ELMER* MULTI PROBE 2



TECHNICAL INFORMATION

Part No.	2700134
Fitting	1/4"-28 UNF
Ports / Flow path	4-Port-90°
Syringe connection	Luer
Fluid contact material (Plug / Body)	PCTFE / PTFE

Abbott is a registered trademark of Abbott.
ABI is a registered trademark of ABI.
Agilent is a registered trademark of Agilent.
Altex is a registered trademark of Altex.
BD Biosciences is a registered trademark of BD Biosciences.
BD FACS is a registered trademark of BD FACS.
Beckman is a registered trademark of Beckman.
Behr is a registered trademark of Behr .
Behring is a registered trademark of Behring.
Boehringer is a registered trademark of Boehringer.
Caliper is a registered trademark of Caliper.
Carlo Erba is a registered trademark of Carlo Erba.
Cavro is a registered trademark of Cavro.
Cell-Dyn is a registered trademark of Abbott.
CGA is a registered trademark of CGA.
Cooper / Technicon is a registered trademark of Cooper / Technicon.
CTC is a registered trademark of CTC.
Cybertron is a registered trademark of Cybertron.
Dani is a registered trademark of Dani.
Digene is a registered trademark of Digene.
Dionex is a registered trademark of Dionex.
Electro is a registered trademark of Electro.
Eppendorf is a registered trademark of Eppendorf.
Finsons is a registered trademark of Finsons.
Gilson is a registered trademark of Gilson.
Gesim is a registered trademark of Gesim.
Gynkotek Dionex is a registered trademark of Gynkotek Dionex.
Hamilton is a registered trademark of Hamilton.
Hewlett Packard is a registered trademark of Hewlett Packard.
Hitachi is a registered trademark of Hitachi.
Horiba is a registered trademark of Horiba.
Innovadyne is a registered trademark of Innovadyne.
Innovatis is a registered trademark of Innovatis.
ISA Biologie is a registered trademark of ISA Biologie.
Janus is a registered trademark of Janus.
Jasco is a registered trademark of Jasco.
Kloehn is a registered trademark of Kloehn.

Knauer is a registered trademark of Knauer.
Kone is a registered trademark of Kone.
Kontron is a registered trademark of Kontron.
Kratel is a registered trademark of Kratel.
Lachrom is a registered trademark of Lachrom.
LEAP is a registered trademark of LEAP.
Maihak is a registered trademark of Maihak.
Mannheim is a registered trademark of Mannheim.
Mitsubishi is a registered trademark of Mitsubishi.
Moritex is a registered trademark of Moritex.
Multistat is a registered trademark of Multistat.
MWG is a registered trademark of MWG.
Nippon is a registered trademark of Nippon.
Olympus is a registered trademark of Olympus.
One Lambda Jet is a registered trademark of One Lambda Jet.
Packard is a registered trademark of Packard.
Perkin Elmer is a registered trademark of Perkin Elmer.
Qiagen is a registered trademark of Qiagen.
Rheodyne is a registered trademark of Rheodyne.
Roche is a registered trademark of Roche.
Rosys is a registered trademark of Rosys.
Selectra is a registered trademark of Selectra.
Siemens is a registered trademark of Siemens.
Shimadzu is a registered trademark of Shimadzu.
Spark is a registered trademark of Spark.
Spectra-Physics is a registered trademark of Spectra-Physics.
Tecan is a registered trademark of Tecan.
Technicon is a registered trademark of Technicon.
Thermo is a registered trademark of Thermo.
TLC Camag is a registered trademark of TLC Camag.
Unitech Chemwell is a registered trademark of Unitech Chemwell.
Valco is a registered trademark of Valco.
Varian is a registered trademark of Varian.
Waters is a registered trademark of Waters.
Wiener Lab is a registered trademark of Wiener Lab.
Wisp is a registered trademark of Waters.
Zymark is a registered trademark of Zymark.



Contact Europe

ILS Innovative Labor Systeme GmbH
Mittelstr. 37, 98714 Stuetzerbach, Germany
Tel: +49 36784 525 24, Fax: +49 36784 525 25

Contact Americas

12740 Earhart Avenue
Auburn, CA 95602, USA
Tel: +1 530 273 8888, Fax: +1 530 273 2586

Contact Asia Pacific

No. 1 New Dong An Road
Shuofang Town
Wuxi, Xinwu District
Jiangsu 214142, China
Tel: +86 510 6878 2217, Fax: +86 510 6878 2200

Headquarters

Livry-Gargan-Str. 10
82256 Fürstenfeldbruck, Germany
Tel: +49 8141 2280 0, Fax: +49 8141 8892136

**Visit our website for more information:
Our Products are now available 24/7 at
www.microsyringes.com**