

F · S · T
FINE SCIENCE TOOLS

2022

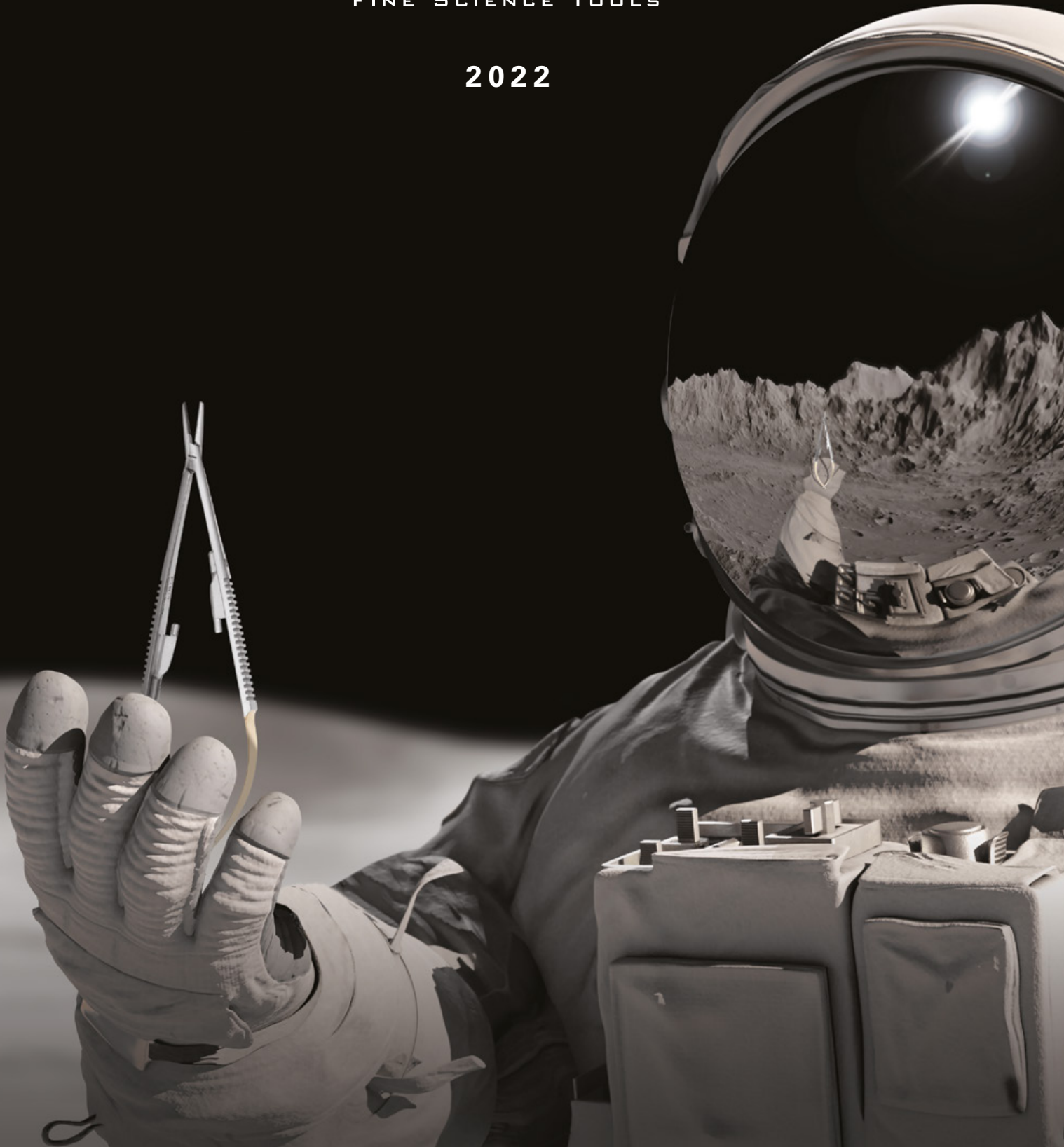

FINE SURGICAL INSTRUMENTS FOR RESEARCH™

Letter from the Managing Partner

Dear valued customers,

As we are coming into 2022 together, I would like to start by saying thank you to our incredibly loyal customer base – who have continuously been walking side by side with Fine Science Tools on this journey, with many of you actively working on research, diagnostics, therapeutics, and vaccinations against Covid-19. Going through this unprecedented time reveals the core values and the culture of every company, who we are, what we stand for and what kind of future we want to build together. We have been reminded of what is truly important – love, compassion, empathy, and taking care of one another. Across Fine Science Tools, we have embraced the spirit by focusing again on our core values and services that have defined us for over 45 years. Our commitment to listening and closely working with our customers has remained the same. Working together once again highlights our true abilities towards the long-term value of our company. Together we will overcome the most difficult obstacles.

To ensure that our values are exemplified we have introduced a management team of 7 specializing in fundamental areas of our business – all of them collaborating very closely with our amazing teams worldwide. We have as well extensively expanded our product range by 100+ products, many of which directly result from requests by customers like you. This growth displays our continued guarantee of high-quality instrumentation, impeccable customer service, and wide selection.

As always, neither this growth nor this success would be possible without you. On behalf of all of us at Fine Science Tools, once again thank you for placing your trust in us as your partner. Thank you for your tireless commitment, every day, to putting our shared values into action. I remain as optimistic as ever about our ability to build a better tomorrow, because we will be building it together with you.

Sincerely,



Markus Gawenda



Markus Gawenda
Managing Partner



Hans Gawenda
Founder



Rob Gawenda
President

Please note the following information for your safety.

All surgical instruments and devices from the Fine Science Tools product range are intended exclusively for use in experimental research laboratories and facilities or in veterinary medicine. Our Customer Support is available to answer any questions you may have about the field of application and the material properties.



Scissors	3 – 35
Spring	3 – 14
Fine	15 – 28
Surgical	29 – 35
Bone Instruments	36 – 51
Rongeurs	36 – 38
Cutters	41 – 48
Other Bone Instruments	49 – 50
Curettes & Chisels	51
Knives & Scalpels	52 – 63



Forceps	65 – 95
Dumont	65 – 74
Fine	75 – 84
Moria	78
S&T	79, 81
Standard	85 – 95
Hemostats	96 – 101

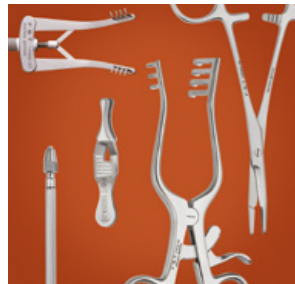

Probes & Hooks	103 – 107
Spatulae	106 – 109
Hippocampal Tools & Spoons	110 – 111
Pins & Holders	112 – 113
Wound Closure	114 – 125
Needle Holders & Suture	114 – 122
Staplers, Clips & Applicators	123 – 125
Retractors	126 – 133
Vascular Instruments	134 – 143
Clamps & Occluders	134 – 138
Ligation Aids	139
Dilation & Cannulation	140 – 143



Animal Accessories	145 – 148
Feeding Needles	145 – 146
Animal Identification	147 – 148
Instrument Care & Accessories	149 – 161
Hot Bead Sterilizer	154
Instrument Cases	157 – 160
Surgical Accessories	162 – 165
Drill Accessories	162
Cauterizers	163 – 164
Laboratory Accessories	166 – 177
Tools	166 – 171
Magnifiers & Lens Paper	172 – 177



Student Instruments	179 – 199
Quality instruments with the student in mind	
Scissors	179 – 184
Cutter	184
Scalpel Handles	185
Forceps	186 – 191
Fine Forceps	186 – 188
Standard Forceps	189 – 191
Hemostats	192 – 197
Needle Holder	198
Retractors, Vessel Dilator & Clamps	199

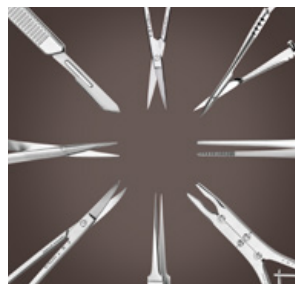

Reference Pages	201 – 220
Worldwide Locations	201
Scissors Test	202
Features and Alloys	203
Maintenance and Care	204 – 205
Quality Control	206
Student Line	207
Selection	208
Dumont	209
Numerical and Alphabetical Indexes	210 – 219
Additional Information	220



Scissors, Bone Instruments, Knives & Scalpels

Spring Scissors	Pages	3 – 14
Fine Scissors	Pages	15 – 28
Surgical Scissors	Pages	29 – 35
Bone Instruments	Pages	36 – 51
Knives & Scalpels	Pages	52 – 63



Micro Vannas

These Vannas-style spring scissors have the smallest blades ever produced. They are ideal where space is restricted and where absolute precision is demanded.



**FST
HAND
CRAFTED**

For more information
see page 38.



300%



Straight
Sharp/Sharp

8 cm
Cutting edge: 2 mm
Tip Ø: 0,05 mm

No. 15000-03



Curved
Sharp/Sharp

8 cm
Cutting edge: 2 mm
Tip Ø: 0,05 mm

No. 15000-04

Micro Vannas

The short taper is ideal for small, precise cuts.



**MOST
POPULAR**

15000-08



**FST
HAND
CRAFTED**

For more information
see page 38.



300%



Straight
Sharp/Sharp

8 cm
Cutting edge: 2,5 mm
Tip Ø: 0,05 mm

No. 15000-08



Curved
Sharp/Sharp

8 cm
Cutting edge: 2,5 mm
Tip Ø: 0,05 mm

No. 15001-08



Angled to side
Sharp/Sharp

8 cm
Cutting edge: 2,5 mm
Tip Ø: 0,05 mm

No. 15002-08

Micro Vannas

The long taper is ideal for cutting vessel walls or when a longer cutting edge is needed.



15000-00



**FST
HAND
CRAFTED**

For more information
see page 38.



300%



Straight
Sharp/Sharp

8 cm
Cutting edge: 3 mm
Tip Ø: 0,05 mm

No. 15000-00



Curved
Sharp/Sharp

8 cm
Cutting edge: 3 mm
Tip Ø: 0,05 mm

No. 15000-10



Straight
Sharp/Sharp

10,5 cm
Cutting edge: 4 mm
Tip Ø: 0,15 mm

No. 15018-10



Curved
Sharp/Sharp

10,5 cm
Cutting edge: 4 mm
Tip Ø: 0,15 mm

No. 15019-10



**FST
HAND
CRAFTED**

For more information
see page 38.



Vannas-Tübingen



15003-08



**FST
HAND
CRAFTED**

For more information
see page 38.



Straight
Sharp/Sharp

8,5 cm
Cutting edge: 5 mm
Tip Ø: 0,075 mm

No. 15003-08



Angled to side
Sharp/Sharp

8,5 cm
Cutting edge: 5 mm
Tip Ø: 0,075 mm

No. 15008-08



Curved
Sharp/Sharp

8,5 cm
Cutting edge: 5 mm
Tip Ø: 0,075 mm

No. 15004-08



Angled up
Sharp/Sharp

9,5 cm
Cutting edge: 5 mm
Tip Ø: 0,075 mm

No. 15005-08

Vannas Scissors with Microserrations

Microserrated to minimize slippage.



**FST
HAND
CRAFTED**

For more information
see page 38.

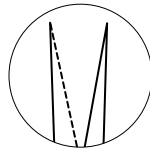

300%

Miniature Vannas

Hand finished under high magnification, these tips are especially useful when incising vessel walls for catheter insertion.



Straight
Sharp/Sharp

8,5 cm
Cutting edge: 4 mm
Tip Ø: 0,1 mm

No. 15070-08



Straight
Sharp/Sharp

9 cm
Cutting edge: 5 mm
Tip Ø: 0,1 mm

No. 15007-08



Curved
Sharp/Sharp

8,5 cm
Cutting edge: 4 mm
Tip Ø: 0,1 mm

No. 15071-08



Moria 9600

Straight
Sharp/Sharp

8 cm
Cutting edge: 5 mm
Tip Ø: 0,1 mm

No. 15396-00



Moria 9601

Curved
Sharp/Sharp

8 cm
Cutting edge: 5 mm
Tip Ø: 0,1 mm

No. 15396-01

Titanium Vannas

TITANIUM

For more information see page 205.



**FST
HAND
CRAFTED**

For more information see page 38.



Straight
Sharp/Sharp

9,5 cm
Cutting edge: 5 mm
Tip Ø: 0,3 mm

No. 15610-08



Curved
Sharp/Sharp

9,5 cm
5 mm
Tip Ø: 0,3 mm

No. 15615-08



Angled up
Sharp/Sharp

9,5 cm
5 mm
Tip Ø: 0,3 mm

No. 15617-08

Cohan-Vannas

Long cutting blades for a more controlled cut.



**FST
HAND
CRAFTED**

For more information see page 38.



Straight
Sharp/Sharp

6 cm
Cutting edge: 6 mm
Tip Ø: 0,1 mm

No. 15000-02



Curved
Sharp/Sharp

6 cm
6 mm
Tip Ø: 0,1 mm

No. 15000-01

Straight
Blunt/Blunt

6 cm
6 mm
Tip Ø: 0,1 mm

No. 15000-12

Curved
Blunt/Blunt

6 cm
6 mm
Tip Ø: 0,1 mm

No. 15000-11

ToughCut® Spring Scissors

**TOUGH
CUT**

For more information see page 205.



**FST
HAND
CRAFTED**

For more information see page 38.



Straight
Sharp/Sharp

12,5 cm
6 mm
Tip Ø: 0,3 mm

No. 15124-12



Curved
Sharp/Sharp

12,5 cm
6 mm
Tip Ø: 0,3 mm

No. 15123-12

Round Handled Vannas

Round handles allow easy fingertip adjustments.



For more information see page 38.



Straight
Sharp/Sharp

12,5 cm
Cutting edge: 6 mm
Tip Ø: 0,075 mm

No. 15400-12



Curved
Sharp/Sharp

12,5 cm
Cutting edge: 6 mm
Tip Ø: 0,075 mm

No. 15401-12



For more information see page 38.

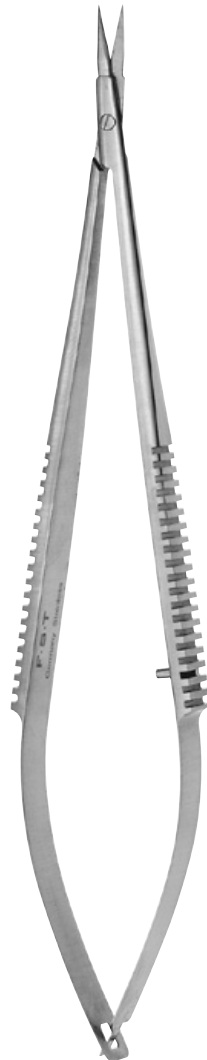

Straight
Sharp/Sharp

14 cm
Cutting edge: 6 mm
Tip Ø: 0,15 mm

No. 15020-15



Curved
Sharp/Sharp

14 cm
Cutting edge: 6 mm
Tip Ø: 0,15 mm

No. 15021-15



For more information about our ceramic instruments please visit page 203.



For more information see page 38.



Straight
Sharp/Sharp

10 cm
Cutting edge: 7 mm
Tip Ø: 0,1 mm

No. 15750-11



Curved
Sharp/Sharp

10 cm
Cutting edge: 7 mm
Tip Ø: 0,1 mm

No. 15751-11

Vannas-Wolff



Moria MC52



Straight
Sharp/Sharp

10 cm

Cutting edge: 7 mm

Tip Ø: 0,15 mm

No. 15370-52

Moria MC50

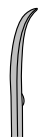

Curved
Sharp/Sharp

10 cm

Cutting edge: 7 mm

Tip Ø: 0,15 mm

No. 15370-50

Vannas

Ultra long cutting edge
without sacrificing tip width.



For more information
see page 38.



Straight
Sharp/Sharp

8,5 cm

Cutting edge: 8 mm

Tip Ø: 0,1 mm

No. 15009-08

Castroviejo



For more information
see page 38.



Angled to side
Sharp/Sharp

10 cm

Cutting edge: 10 mm

Tip Ø: 0,125 mm

No. 15006-09

Castroviejo with Ball Tip

Same as No. 15006-09 but with a ball tip to prevent piercing of underlying tissue.



For more information see page 38.



Angled to side
Sharp/Sharp

9 cm
Cutting edge: 8 mm
Tip Ø: 1,3 mm Ball

No. 15033-09

Spring Scissors



For more information see page 38.



Straight
Sharp/Sharp

10 cm
Cutting edge: 8 mm
Tip Ø: 0,15 mm

No. 15024-10



Straight
Blunt/Blunt

10 cm
Cutting edge: 8 mm
Tip Ø: 0,15 mm

No. 15025-10



Curved
Sharp/Sharp

10 cm
Cutting edge: 8 mm
Tip Ø: 0,15 mm

No. 15023-10



For more information see page 38.



Straight
Sharp/Sharp

11,5 cm
Cutting edge: 10 mm
Tip Ø: 0,1 mm

No. 15040-11

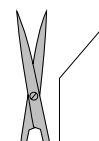

Angled up
Sharp/Sharp

11,5 cm
Cutting edge: 10 mm
Tip Ø: 0,1 mm

No. 15042-11

Noyes



For more information see page 38.

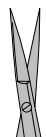

Straight
Sharp/Sharp

12 cm
Cutting edge: 14 mm
Tip Ø: 0,2 mm

No. 15012-12



Curved
Sharp/Sharp

12 cm
Cutting edge: 14 mm
Tip Ø: 0,2 mm

No. 15011-12

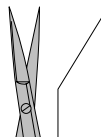

Angled up
Sharp/Sharp

12 cm
Cutting edge: 14 mm
Tip Ø: 0,2 mm

No. 15013-12

Tungsten Carbide Noyes

Tungsten carbide cutting edges provide long lasting sharpness.



For more information see page 203.



For more information see page 38.



Straight
Sharp/Sharp

12 cm
Cutting edge: 14 mm
Tip Ø: 0,275 mm

No. 15514-12

Castroviejo



For more information see page 38.



Sharply curved
Sharp/Sharp

10 cm
Cutting edge: 10 mm
Tip Ø: 0,2 mm

No. 15017-10

Ceramic Coated Titanium Castroviejo



For more information see page 38.



For more information see page 203.



For more information about our ceramic instruments please visit page 203.

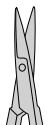

Straight
Sharp/Sharp

11 cm
Cutting edge: 5 mm
Tip Ø: 0,2 mm

No. 15650-11



Curved
Sharp/Sharp

11 cm
Cutting edge: 5 mm
Tip Ø: 0,2 mm

No. 15651-11

Westcott



For more information see page 38.



Slightly curved
Sharp/Sharp

11 cm
Cutting edge: 15 mm
Tip Ø: 0,25 mm

No. 15015-11

Fine Angled Spring Scissors

These spring scissors aid in cutting tissues from various angles.



For more information see page 38.



Angled up
Sharp/Sharp

9,5 cm
Cutting edge: 2 mm
Tip Ø: 0,1 mm

No. 15010-09



Angled up
Sharp/Sharp

10 cm
Cutting edge: 4 mm
Tip Ø: 0,125 mm

No. 15010-10

Trident II

A re-release of a popular spring scissors now with a new innovative design for a better feel.



Straight
Sharp/Sharp

8 cm
Cutting edge: 8 mm
Tip Ø: 0,2 mm

No. 15110-08



Angled to side
Sharp/Sharp

8 cm
Cutting edge: 8 mm
Tip Ø: 0,2 mm

No. 15111-08

Pascheff-Wolff

Very delicate blades.



Moria MC19/B



Angled up
Sharp/Sharp

10,5 cm
Cutting edge: 3 mm
Tip Ø: 0,15 mm

No. 15371-92

Long Handle Spring Scissors



Straight
Sharp/Sharp

18,5 cm
Cutting edge: 5 mm
Tip Ø: 0,2 mm

No. 15028-18



Curved
Sharp/Sharp

18,5 cm
Cutting edge: 5 mm
Tip Ø: 0,2 mm

No. 15027-18

Micro Scissors

With microserrations to minimize slippage.



For more information see page 38.



300%

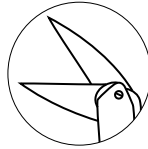

300%

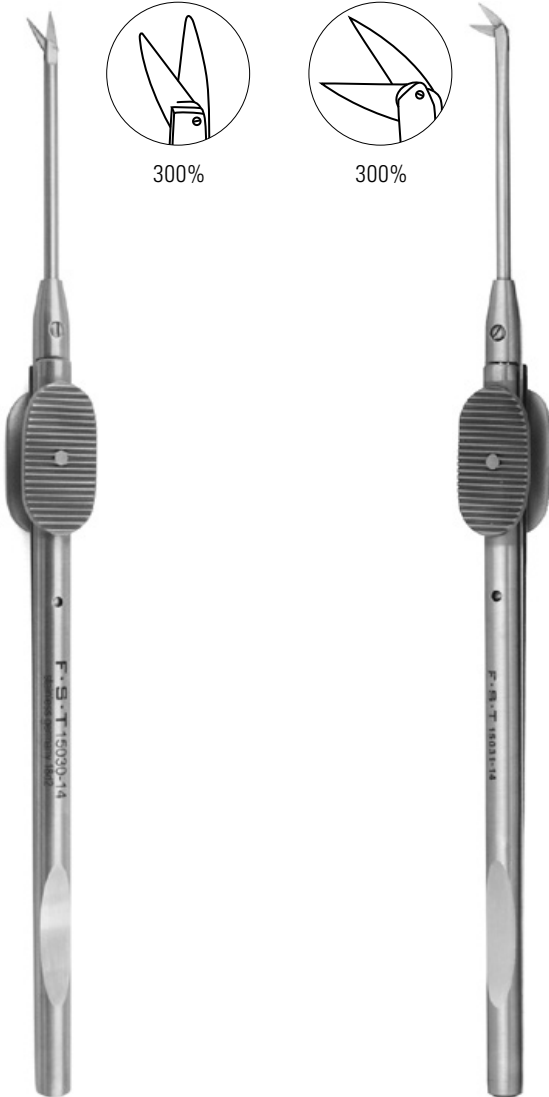

Straight
Sharp/Sharp

14,5 cm
Cutting edge: 2,5 mm
Tip Ø: 0,175 mm

No. 15030-14



Angled to side
Sharp/Sharp

14,5 cm
Cutting edge: 2,5 mm
Tip Ø: 0,175 mm

No. 15031-14

Vitrectomy Scissors

The finest blades on spring scissors. Designed for ophthalmic surgery (vitrectomy). The spring handles are made of ribbed plastic to ensure a solid grip. **Autoclavable.**



For more information see page 38.

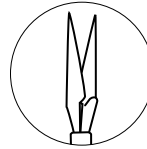

300%

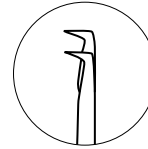

300%



Straight
Sharp/Sharp

14 cm
Cutting edge: 2,2 mm
Tip Ø: 0,15 mm

No. 15036-14



Angled 90°
Sharp/Sharp

14 cm
Cutting edge: 1 mm
Tip Ø: 0,1 mm

No. 15037-14

Ultra Fine Clipper Scissors II

For microscopic dissections of soft and mucous tissue. The minute fineness of the blades allows clear visualization of the tissue being dissected.



Uses:

- Removing sheath of ganglia to access neurons in aplysia.
- Cutting single nerve axons in aplysia, mollusk and snail.
- Stripping fascia off arteries and muscles.
- Ultra fine brain tissue dissection.
- Cutting of minute fiber optic strands.

Straight
Sharp/Sharp

10 cm
Cutting edge: 1,5–2 mm
Tip Ø: 0,05–0,08 mm
Blade shape: Triangular
Blade thickness: 0,1 mm

No. 15300-00

Biemer Scissors

These scissors are designed to securely cut vessels without slipping.



Straight
Blunt/Blunt

8,5 cm
Cutting edge: 4 mm
Tip Ø: 2 mm

No. 15032-08

Straight
Blunt/Blunt

13 cm
Cutting edge: 2 mm
Tip Ø: 2 mm

No. 15032-13

Extra Fine Bonn

Our finest iris scissors, best suited for microdissection under high magnification.



14084-08
14085-08



Straight
Sharp/Sharp

8,5 cm
Cutting edge: 13 mm

No. 14084-08



Curved
Sharp/Sharp

8,5 cm
Cutting edge: 13 mm

No. 14085-08



Straight
Sharp/Blunt

8,5 cm
Cutting edge: 13 mm

No. 14083-08

Bonn

Highly polished.



Straight
Sharp/Sharp

9 cm
Cutting edge: 13 mm

No. 14184-09



Curved
Sharp/Sharp

9 cm
Cutting edge: 13 mm

No. 14185-09

ToughCut® Bonn-Strabismus

A fusion of two light and delicate iris scissors with ToughCut cutting edges.



For more information
see page 203.



Straight
Blunt/Blunt

9 cm
Cutting edge: 14 mm

No. 14084-09



Curved
Blunt/Blunt

9 cm
Cutting edge: 14 mm

No. 14085-09

Hardened Fine Iris Scissors

These scissors have an anti-reflective finish to reduce glare.

MOST POPULAR

14090-09



Straight
Sharp/Sharp

9 cm
Cutting edge: 24 mm

No. 14090-09



Curved
Sharp/Sharp

9 cm
Cutting edge: 24 mm

No. 14091-09

11 cm
Cutting edge: 26 mm

No. 14090-11

11 cm
Cutting edge: 26 mm

No. 14091-11

Fine Iris Scissors

Made from Martensitic stainless steel, combined with Molybdenum and Vanadium.



Straight
Sharp/Sharp

10,5 cm
Cutting edge: 26 mm

No. 14094-11



Curved
Sharp/Sharp

10,5 cm
Cutting edge: 26 mm

No. 14095-11

Iris Scissors

Delicate pattern.

MOST POPULAR

14060-11



Straight
Sharp/Sharp

9 cm
Cutting edge: 21 mm

No. 14060-09



Curved
Sharp/Sharp

9 cm
Cutting edge: 21 mm

No. 14061-09

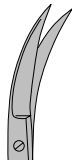

Curved to side
Sharp/Sharp

9 cm
Cutting edge: 21 mm

No. 14062-09

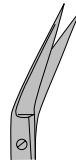

Angled to side
Sharp/Sharp

9 cm
Cutting edge: 21 mm

No. 14063-09

10,5 cm
Cutting edge: 23 mm

No. 14060-10

10,5 cm
Cutting edge: 23 mm

No. 14061-10

10,5 cm
Cutting edge: 23 mm

No. 14062-10

11,5 cm
Cutting edge: 23 mm

No. 14063-11

11,5 cm
Cutting edge: 25 mm

No. 14060-11

11,5 cm
Cutting edge: 25 mm

No. 14061-11

Left Handed Iris Scissors

LEFT HANDED



Straight
Sharp/Sharp

11,5 cm
Cutting edge: 25 mm

No. 14160-10



Curved
Sharp/Sharp

11,5 cm
Cutting edge: 25 mm

No. 14161-10

Moria Iris Scissors



Moria 4877



Straight
Sharp/Sharp

12,5 cm
Cutting edge: 25 mm

No. 14370-22

Moria 4878



Shallow curve
Sharp/Sharp

10,5 cm
Cutting edge: 25 mm

No. 14370-23

Extra Narrow Iris Scissors

Extra narrow, delicate pattern. Very slim blades with gentle cutting action.



Side-view showing
extra narrow pattern

Straight
Sharp/Sharp

10,5 cm
Cutting edge: 23 mm

No. 14088-10

Large Loops Scissors



Straight
Sharp/Sharp

10 cm
Cutting edge: 25 mm

No. 14040-10



Curved
Sharp/Sharp

10 cm
Cutting edge: 25 mm

No. 14041-10

Wagner



Straight
Sharp/Sharp

12 cm
Cutting edge: 30 mm

No. 14068-12



Curved
Sharp/Sharp

12 cm
Cutting edge: 30 mm

No. 14069-12



Straight
Sharp/Sharp

12 cm
Cutting edge: 30 mm

No. 14070-12



Curved
Sharp/Sharp

12 cm
Cutting edge: 30 mm

No. 14071-12

ToughCut®

MOST POPULAR

14058-09
14058-11

TOUGH CUT

For more information
see page 203.



Straight
Sharp/Sharp

9 cm
Cutting edge: 22 mm

No. 14058-09



Curved
Sharp/Sharp

9 cm
Cutting edge: 22 mm

No. 14059-11

11,5 cm
Cutting edge: 25 mm

No. 14058-11

11,5 cm
Cutting edge: 25 mm

No. 14059-11

Tungsten Carbide

MOST POPULAR

14568-09
14568-12

TUNGSTEN CARBIDE

For more information
see page 203.



Straight
Sharp/Sharp

9 cm
Cutting edge: 22 mm

No. 14568-09



Curved
Sharp/Sharp

9 cm
Cutting edge: 22 mm

No. 14569-09

11,5 cm
Cutting edge: 25 mm

No. 14568-12

11,5 cm
Cutting edge: 25 mm

No. 14569-12

ToughCut® and Tungsten Carbide



For more information see page 203.



For more information see page 203.



Straight
Sharp/Sharp

9 cm
Cutting edge: 22 mm

No. 14558-09



Curved
Sharp/Sharp

9 cm
Cutting edge: 22 mm

No. 14559-09

11,5 cm
Cutting edge: 25 mm

No. 14558-11

11,5 cm
Cutting edge: 25 mm

No. 14559-11

CeramaCut®

These ceramic-coated scissors are the cleanest cutting, longest lasting scissors ever produced. Utilizing the unique properties of a ceramic coating, they will last six times longer than tungsten carbide instruments and cut even better than ToughCut® scissors. The black, corrosion-resistant coating has a non-glare finish.



For more information see page 203.



Straight
Sharp/Sharp

9 cm
Cutting edge: 22 mm

No. 14958-09



Curved
Sharp/Sharp

9 cm
Cutting edge: 22 mm

No. 14959-09

11,5 cm
Cutting edge: 25 mm

No. 14958-11

11,5 cm
Cutting edge: 25 mm

No. 14959-11

Fine Scissors

Lexer-Baby



Straight
Sharp/Blunt

Curved
Sharp/Blunt

10 cm
Cutting edge: 27 mm

10 cm
Cutting edge: 27 mm

No. 14028-10

No. 14029-10



Straight
Blunt/Blunt

Curved
Blunt/Blunt

10 cm
Cutting edge: 25 mm

10 cm
Cutting edge: 25 mm

No. 14078-10

No. 14079-10

Strabismus

Tungsten Carbide Strabismus

**TUNGSTEN
CARBIDE**

For more information
see page 203.



Straight
Blunt/Blunt

9 cm
Cutting edge: 20 mm

No. 14074-09

11,5 cm
Cutting edge: 23 mm

No. 14074-11



Curved
Blunt/Blunt

9 cm
Cutting edge: 20 mm

No. 14075-09

11,5 cm
Cutting edge: 23 mm

No. 14075-11



Straight
Blunt/Blunt

9 cm
Cutting edge: 20 mm

No. 14574-09

11 cm
Cutting edge: 23 mm

No. 14574-11



Curved
Blunt/Blunt

9 cm
Cutting edge: 20 mm

No. 14575-09

11 cm
Cutting edge: 23 mm

No. 14575-11

Walton



Slightly curved
Sharp/Sharp

9,5 cm
Cutting edge: 15 mm

No. 14077-09



Slightly curved
Sharp/Sharp

10,5 cm
Cutting edge: 18 mm

No. 14077-10

Stevens Tenotomy



Straight
Sharp/Sharp

11 cm
Cutting edge: 21 mm

No. 14064-11



Straight
Blunt/Blunt

11 cm
Cutting edge: 21 mm

No. 14066-11



Curved
Sharp/Sharp

11 cm
Cutting edge: 21 mm

No. 14065-11



Curved
Blunt/Blunt

11 cm
Cutting edge: 21 mm

No. 14067-11

LaGrange

One edge is serrated to minimize slippage of tissue during cutting. Curved handle helps when cutting from an awkward angle.



Side View



Curved
Sharp/Sharp

11,5 cm
Cutting edge: 18 mm

No. 14173-12

Shea

Transplant scissors with light and delicate pattern.



Curved
Blunt/Blunt

12 cm
Cutting edge: 20 mm

No. 14105-12

Dissector Scissors

Slim blades for cutting tissue.

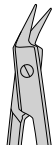

Angled to side
Sharp/Sharp

10 cm
Cutting edge: 8 mm

No. 14081-09

Dissector Scissors

Similar to 14081-09, but with stronger blades for cutting fine bone.

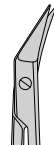

Angled to side
Sharp/Sharp

10,5 cm
Cutting edge: 12 mm

No. 14082-09

Spencer Ligature

Used for cutting stitches or suture.



Straight
Sharp/Sharp

9 cm
Cutting edge: 20 mm

No. 14076-09

Bonn Artery

Iris scissors with one ball tip to prevent piercing of underlying tissue.



Straight
Sharp/Ball tip

9 cm
Cutting edge: 13 mm
Tip Ø: 1,5 mm Ball

No. 14086-09



Straight
Sharp/Ball tip

11,5 cm
Cutting edge: 25 mm
Tip Ø: 1,5 mm Ball

No. 14080-11

Tissue Separating Scissors

Straight
Blunt/Blunt

11,5 cm
Cutting edge: 23 mm

No. 14072-10

Graefe

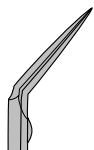

Sharply angled up
Sharp/Sharp

10,5 cm
Cutting edge: 14 mm

No. 14037-10

Adjustable Loops Fine Scissors

The finger loops can be enlarged to fit almost any size.



Straight
Sharp/Sharp

9,5 cm
Cutting edge: 14 mm

No. 14106-09



Straight
Blunt/Blunt

9,5 cm
Cutting edge: 14 mm

No. 14108-09

Kaye

These scissors have semi-sharp outer edges to better facilitate dissection.



Slightly curved
Blunt/Blunt

10,5 cm
Cutting edge: 22 mm

No. 14171-10

Standard Pattern

MOST POPULAR

14001-12 – 14001-18

LEFT HANDED 

14008-14

Our standard surgical scissors are recognized for these important features:

- Excellent feel and handling capability.
- Overall execution that marks them as fine examples of German craftsmanship.



Length (cm)	Cutting edge (mm)	Straight Sharp/Sharp	Straight Sharp/Blunt	Straight Blunt/Blunt
12	40	No. 14002-12	No. 14001-12	No. 14000-12
13	40	No. 14002-13	No. 14001-13	No. 14000-13
14,5	45	No. 14002-14	No. 14001-14	No. 14000-14
16,5	50	No. 14002-16	No. 14001-16	No. 14000-16
18,5	55		No. 14001-18	No. 14000-18
20	60			No. 14000-20

Length (cm)	Cutting edge (mm)	Straight Sharp/Blunt
14,5	45	No. 14008-14



Length (cm)	Cutting edge (mm)	Curved Sharp/Sharp	Curved Sharp/Blunt	Curved Blunt/Blunt
12	40	No. 14005-12	No. 14004-12	No. 14003-12
13	40	No. 14005-13	No. 14004-13	No. 14003-13
14,5	45	No. 14005-14	No. 14004-14	No. 14003-14
16,5	50	No. 14005-16	No. 14004-16	No. 14003-16
18,5	55		No. 14004-18	No. 14003-18
20	60			No. 14003-20

ToughCut® Standard Pattern



14054-13



For more information
see page 203.



80% of
actual size

Tungsten Carbide Standard Pattern



For more information
see page 203.



80% of
actual size

**Standard Pattern
with Serrations**



80% of
actual size



Straight
Sharp/Blunt
13 cm
Cutting edge: 40 mm
No. 14054-13



Straight
Sharp/Blunt
17,5 cm
Cutting edge: 60 mm
No. 14130-17



Straight
Sharp/Sharp
14,5 cm
45 mm
No. 14502-14



Straight
Sharp/Blunt
14,5 cm
45 mm
No. 14501-14



Curved
Sharp/Sharp
14,5 cm
45 mm
No. 14505-14



Curved
Sharp/Blunt
14,5 cm
45 mm
No. 14504-14



Straight
Sharp/Blunt
14 cm
40 mm
No. 14007-14

Standard Pattern with Large Finger Loops



80% of actual size



Straight
Sharp/Blunt

14,5 cm
Cutting edge: 45 mm

No. 14101-14

Tungsten Carbide Mini-Lister



For more information see page 203.



Angled to side
Blunt/Blunt

9 cm
Cutting edge: 20 mm

No. 14531-09

Lister

Excellent skin cutting scissors. Longer, blunt blade prevents damaging tissue underneath skin without losing the cutting line.



80% of actual size



Angled to side
Blunt/Blunt

14 cm
Cutting edge: 30 mm

No. 14131-14

Metzenbaum Baby

Tungsten Carbide Metzenbaum Fino

SCISSORS

**TUNGSTEN
CARBIDE**

For more information
see page 203.

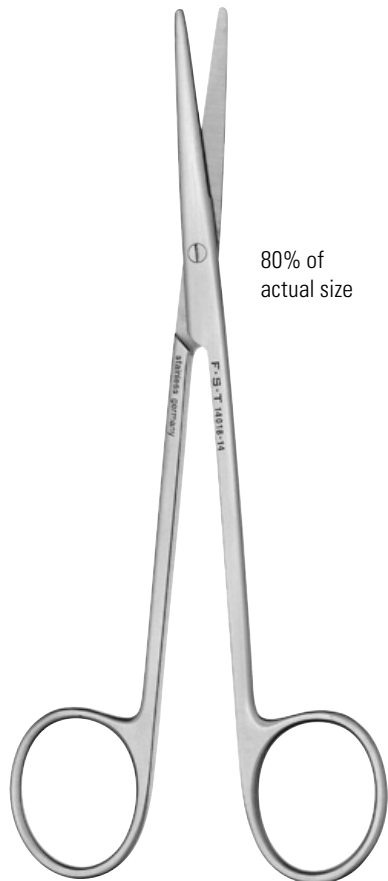

80% of
actual size



80% of
actual size

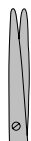

Straight
Blunt/Blunt

13 cm
Cutting edge: 30 mm

No. 14018-13



Curved
Blunt/Blunt

13 cm
30 mm

No. 14019-13

14,5 cm
Cutting edge: 35 mm

No. 14018-14

14,5 cm
35 mm

No. 14019-14

18 cm
Cutting edge: 40 mm

No. 14018-18

18 cm
40 mm

No. 14019-18



Straight
Blunt/Blunt
Ultra fine tips

14,5 cm
35 mm

No. 14508-15



Straight
Blunt/Blunt

14,5 cm
35 mm

No. 14518-14



Curved
Blunt/Blunt
Ultra fine tips

14,5 cm
35 mm

No. 14509-15



Curved
Blunt/Blunt

14,5 cm
35 mm

No. 14519-14

18 cm
40 mm

No. 14518-18

18 cm
40 mm

No. 14519-18

Metzenbaum

ToughCut® Metzenbaum



For more information
see page 203.

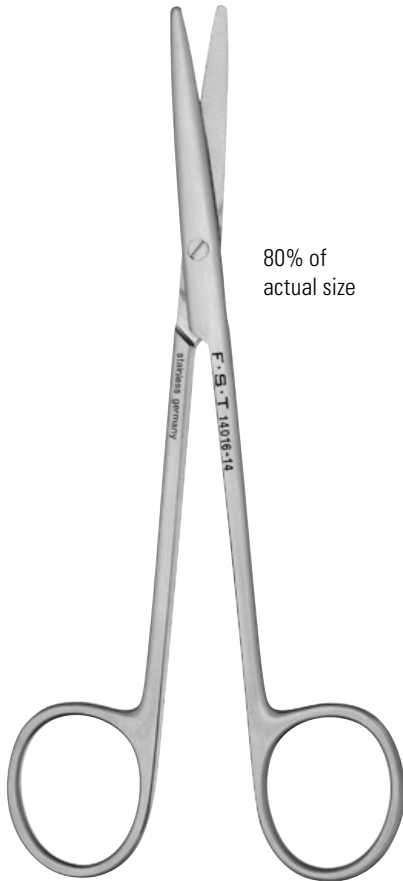

80% of
actual size



80% of
actual size

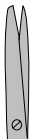

Straight
Sharp/Blunt

14,5 cm
Cutting edge: 30 mm

No. 14024-14



Straight
Blunt/Blunt

14,5 cm
Cutting edge: 30 mm

No. 14016-14



Curved
Blunt/Blunt

14,5 cm
Cutting edge: 30 mm

No. 14017-14

18 cm
Cutting edge: 35 mm

No. 14016-18

18 cm
Cutting edge: 35 mm

No. 14017-18



Straight
Blunt/Blunt

14,5 cm
Cutting edge: 30 mm

No. 14116-14



Curved
Blunt/Blunt

14,5 cm
Cutting edge: 30 mm

No. 14117-14

18 cm
Cutting edge: 35 mm

No. 14116-18

18 cm
Cutting edge: 35 mm

No. 14117-18

Mayo

ToughCut® Mayo

Tungsten Carbide Mayo



For more information see page 203.



For more information see page 203.



14512-15 & 14512-17
For more information see page 203.



80% of actual size



80% of actual size



80% of actual size



Straight
Blunt/Blunt

Curved
Blunt/Blunt

15 cm
Cutting edge: 40 mm

15 cm
40 mm

No. 14010-15

No. 14011-15

17 cm
Cutting edge: 45 mm

17 cm
45 mm

No. 14010-17

No. 14011-17

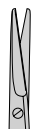

Straight
Blunt/Blunt

Curved
Blunt/Blunt

15 cm
40 mm

15 cm
40 mm

No. 14110-15

No. 14111-15

17 cm
45 mm

17 cm
45 mm

No. 14110-17

No. 14111-17



Straight
Blunt/Blunt

Curved
Blunt/Blunt

Straight
Blunt/Blunt

15 cm
40 mm

15 cm
40 mm

15 cm
40 mm

No. 14510-15

No. 14511-15

No. 14512-15

17 cm
45 mm

17 cm
45 mm

17 cm
45 mm

No. 14510-17

No. 14511-17

No. 14512-17

Mayo-Stille



80% of actual size

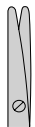

Straight
Blunt/Blunt

15 cm
Cutting edge: 40 mm

No. 14012-15



Curved
Blunt/Blunt

15 cm
Cutting edge: 40 mm

No. 14013-15

17 cm
Cutting edge: 45 mm

No. 14012-17

17 cm
Cutting edge: 45 mm

No. 14013-17

Mayo-Noble



80% of actual size



Straight
Blunt/Blunt

16,5 cm
Cutting edge: 45 mm

No. 14014-17



Curved
Blunt/Blunt

16,5 cm
Cutting edge: 45 mm

No. 14015-17

Decapitation Scissors

Stop guard at tips to prevent slippage.



70% of actual size



Straight
Blunt/Blunt

21 cm
Cutting edge: 55 mm

No. 14200-21

Friedman-Pearson

This popular, fine-tipped rongeur is suited for delicate work. The fine-cupped jaws have been designed with a longer and slimmer approach for better visibility.



For more information see page 38.

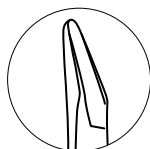

200%

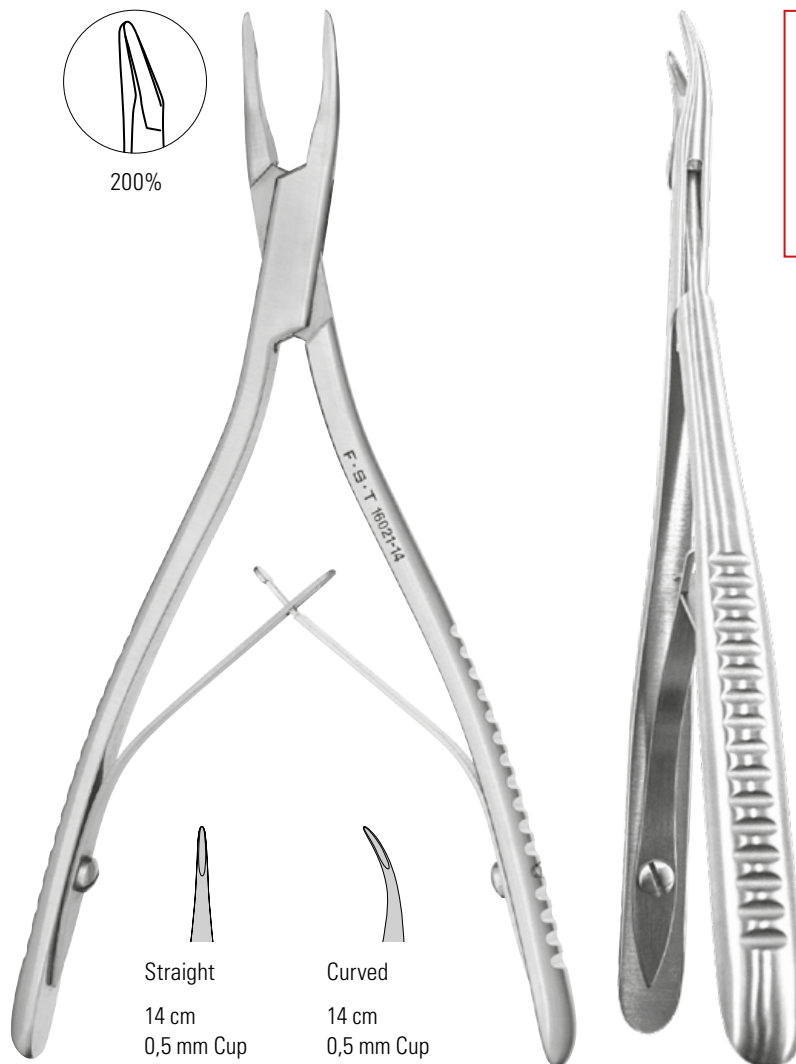

Cautionary note:
The fine rongeur tips shown on this page are extremely fragile. Removal of material with a twisting motion can damage the tips.



Straight

14 cm
0,5 mm Cup

No. 16220-14



Curved

14 cm
0,5 mm Cup

No. 16221-14

14 cm
0,7 mm Cup
No. 16120-14

14 cm
0,7 mm Cup
No. 16121-14

14 cm
1 mm Cup
No. 16020-14

14 cm
1 mm Cup
No. 16021-14

Pearson

Provides excellent visibility at dissection site due to its extra long and narrow approach to the fine cutting jaws. Especially suitable for larger hands.



Luer

Cautionary note:

The fine rongeur tips shown on this page are extremely fragile. Removal of material with a twisting motion can damage the tips.

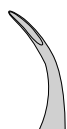

Slightly Curved

17 cm
1,2 mm Cup

No. 16015-17

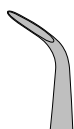

Sharply Curved

17 cm
1,2 mm Cup

No. 16016-17



Curved

15 cm
4 mm Cup

No. 16001-15



Precision that makes a mark.

Our surgical mechanics refine and perfect instruments in FST's very own workshop, this is a step that only we take in this form. This is essential for the precision and quality of each and every one of our products.

For example, our Friedman-Pearson rongeurs with tip diameters of 0.5 or 0.7 mm, both are unique in the world. Also, our spring scissors have established themselves in the research industry and are second to none in terms of fineness.

The result: a level of quality that makes its mark - and to which we have now dedicated our own. Our new symbol "Hand-Crafted" stands for 100% guaranteed craftsmanship and instruments you can rely on in any situation.

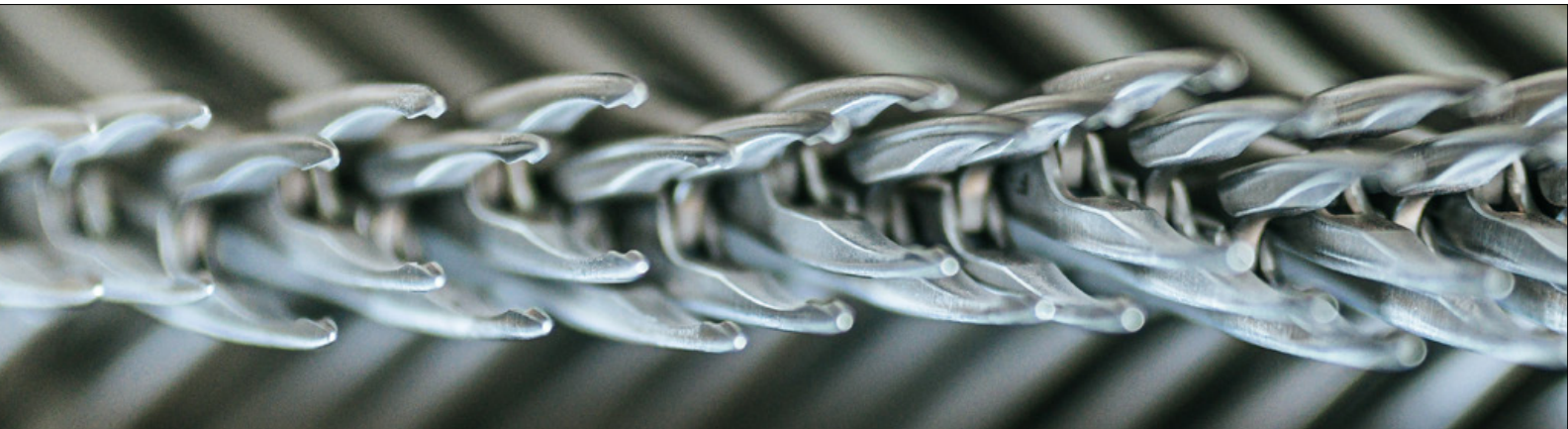

Baby-Beyer

Double-action rongeur with strong jaws helps relieve hand strain.

Beyer

Double-action rongeur with strong jaws helps relieve hand strain.

Diameter of this circle determines cup size.
 Form an imaginary circle that will fit in the very tip of the instrument and measure its diameter.



Straight

15 cm
2 mm Cup

No. 16023-15

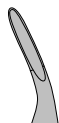

Curved

15 cm
2 mm Cup

No. 16022-15

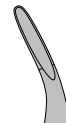

Curved

18 cm
2,5 mm Cup

No. 16002-18

Friedman

Strong and large jaws are ideal for use on the harder, outer regions of the spinal cord. Also can be used to gain access to delicate structures encased in bone.

Lempert

Extra fine jaws.

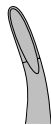
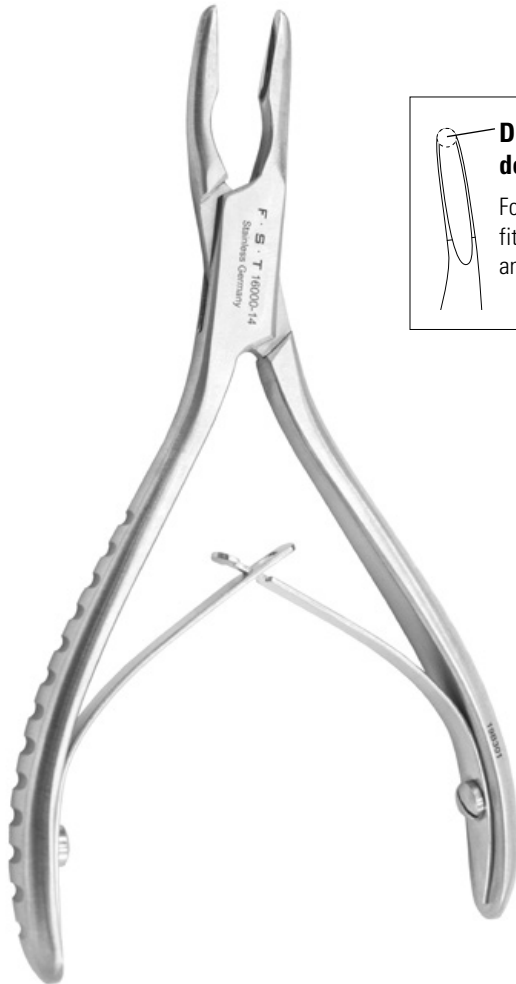

Curved
13 cm
2,5 mm Cup
No. 16000-14

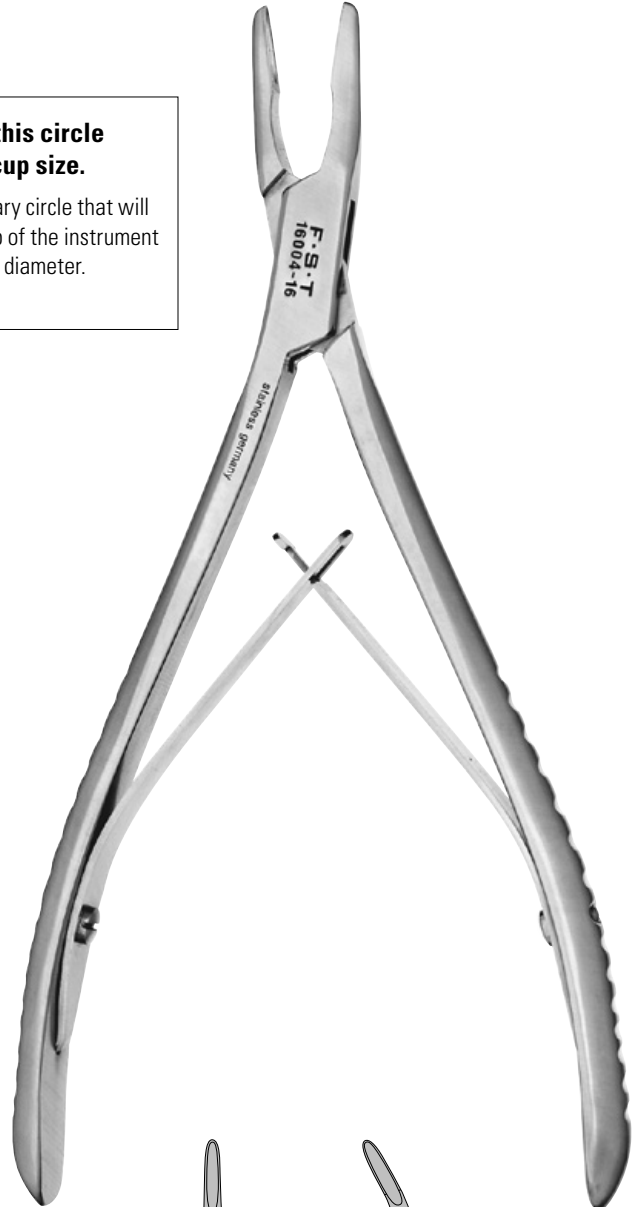
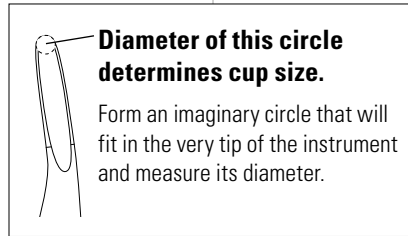

Straight
16 cm
2,5 mm Cup
No. 16004-16



Curved
16 cm
2,5 mm Cup
No. 16005-16

Bone Trimmers

Curved

14 cm

Cutting edge: 8 mm

No. 16109-14

Cartilage Cutter

Round cutting blades for tissue, cartilage and soft bone.



Curved

14 cm

Cutting edge: 9 mm

No. 16107-14

Dumont #15a Bone Cutter

Cutting edge on both outside and inside bevel. Cuts suture, cartilage, bone and steel wire to 0,06 mm, and copper wire to 0,15 mm.

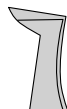

11,5 cm
 Cutting edge: 10 mm
 Jaw opening: 2,5 mm
 Hard carbon steel
 No. 11215-01

Dumont #15a Bone Cutter – Epoxy Coated

Same structure and functionality as Item No. 11215-01 (left), but with an epoxy coating up to the cutting edge for easier care and maintenance.



11,5 cm
 Cutting edge: 6 mm
 Jaw opening: 2,5 mm
 Epoxy coated carbon steel
 No. 11215-02

Tungsten Carbide Bone Cutter

**TUNGSTEN
CARBIDE**

For more information
see page 203.

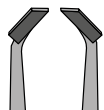

Angled

11,5 cm

Cutting edge: 10 mm

Stainless Steel handle with
Tungsten Carbide Tips

No. 11515-02

Micro Bone Cutter



Angled 25°

13 cm

Cutting edge: 5 mm

Rolling Bearing Steel handle
with TPE Grip

No. 16103-11

Bone Nipper

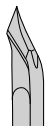

Angled
11 cm
Cutting edge: 5 mm
No. 16102-11

Offset Bone Nipper

Strong jaws for cutting tough cartilage.



Angled
10 cm
Cutting edge: 7 mm
No. 16101-10

Malleus Nipper



Bone Cutting Spring Scissors



Delicate Bone Cutting Spring Scissors

Slim, strong blades for cutting fine bones and tissues.

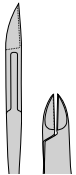
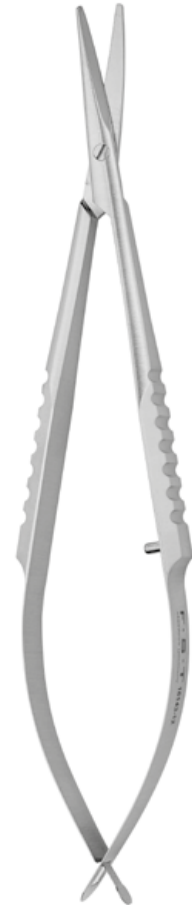

Straight

11 cm
Cutting edge: 9 mm

No. 16140-11

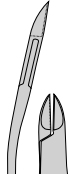

Angled down

11 cm
Cutting edge: 9 mm

No. 16141-11

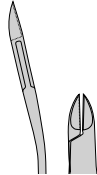

Angled up

11 cm
Cutting edge: 9 mm

No. 16142-11

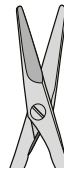

Straight

13 cm
Cutting edge: 12 mm

No. 16144-13

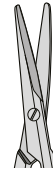

Curved

12 cm
Cutting edge: 12 mm

No. 16143-12

Littauer Bone Cutter



Straight
11 cm
Cutting edge: 15 mm
No. 16152-11



Straight
12,5 cm
Cutting edge: 17 mm
No. 16152-12



Straight
15 cm
Cutting edge: 19 mm
No. 16152-15

Beebee Bone Scissors

Very strong jaws with sharp points.

MOST POPULAR



Straight
10 cm
Cutting edge: 15 mm
No. 16044-10

Tungsten Carbide Bone Scissors

Strong heavy blades for cutting bone.

TUNGSTEN CARBIDE

SERRATED

For more information see page 203.



Straight
12,5 cm
Cutting edge: 15 mm
No. 16030-12



Straight
16 cm
Cutting edge: 15 mm
No. 16030-16

Boehler

Bone splitting cutter with very fine tips and double action joint to relieve strain on your hand.



Angled up 10°
15 cm
Cutting edge: 18 mm
No. 16130-15

Skull Flap Cutter

One tip has a flat and narrow platform which fits between dura and skull. Other tip has sharp cutting edge. The double action joint relieves strain on your hand.



Angled up 15°
14 cm
Cutting edge: 10 mm
No. 16050-15

Cleveland Cutter

Liston

Gross anatomy bone cutter.

CUTTERS



Slightly angled
15 cm
Cutting edge: 14 mm
No. 16106-14

17 cm
Cutting edge: 15 mm
No. 16105-16



Straight
14 cm
Cutting edge: 20 mm
No. 16104-14

20 cm
Cutting edge: 30 mm
No. 16104-19

Bone Pliers

To peel back skull flaps.

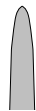

Straight
15,5 cm
Flat surface
No. 16025-14

Bone Shears



60% of
actual size

Curved
24 cm
Cutting edge: 6,5 cm
No. 16150-24

Bone Forceps

Strong cross-serrated tips for bone crushing and removal.



Angled
11,5 cm
Tip Ø: 1 mm
Cross serrated
No. 16060-11

Self-Holding Pin and Bone Screw Forceps

Designed with a serrated tip and grooved cup for a stable and secure grip, these forceps hold pins and screws allowing precise placement at your target area. They are compatible with all Fine Science Tools insect pins, minution pins and bone screws.

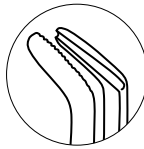

200%

Angled
14 cm
Polished stainless steel
No. 26100-00

Miniature Self-Tapping Bone Screws

Used extensively to anchor dental cement to bone, these self-tapping screws have superior holding strength over ordinary machine screws. Stainless steel with fillister flat head.



4 mm
Shaft diameter: 0,86 mm
Pkg. of 100 screws
No. 19010-10

4,8 mm
Shaft diameter: 1,19 mm
Pkg. of 100 screws
No. 19010-00

Pkg. of 10 screws
No. 19010-11

Pkg. of 10 screws
No. 19010-01

For pre-drilling use our 0,7 mm burrs, see page 162.

For pre-drilling use our 0,9 mm burrs, see page 162.

Bone Wax

A beeswax-based compound for bone hemostasis. Soft, kneadable and ready to use.

Sterile.



Box of 12 foil packs (2,5 g each)
No. 19009-00

Micro Curette

Curette tips consist of a scoop with sharp edges and are used for scraping or cleaning. They can also be used for separating and transporting, inoculating plates or transferring small amounts of chemicals.



Delicate Bone Scraper

For scraping tissue without cutting into bone.



Austin Chisel



Dissecting Chisel



CURETTES & CHISELS

Serrations on cutting edge

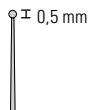

13 cm
No. 10080-05

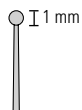

13 cm
No. 10081-10

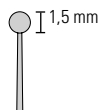

13 cm
No. 10082-15

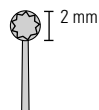

12,5 cm
No. 10083-20

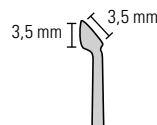

16,5 cm
No. 10075-16

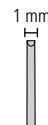

16 cm
No. 10096-16

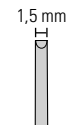

16 cm
No. 10097-16

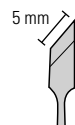

12,5 cm
No. 10095-12

Von Graefe Knife

Used for cutting dura.

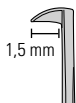

Angled 90°
13 cm
Cutting edge: 1,5 mm
No. 10059-13

Cataract Knife

One of the most popular dissecting knives with a microfine point. The cutting edge is lance shaped to provide the ideal cutting angle.

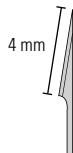
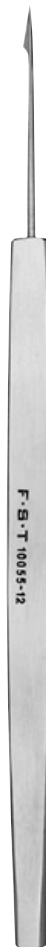

Straight
12,5 cm
Cutting edge: 4 mm
No. 10055-12

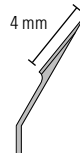

Angled 30°
12,5 cm
Cutting edge: 4 mm
No. 10056-12

Sichel

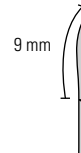

Curved
12 cm
Cutting edge: 9 mm
No. 10073-14

Micro Knife



Straight
13 cm
Cutting edge: 28 mm
No. 10370-13

Micro Knife Side Cut

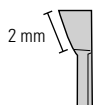

Side blade 20°
15 cm
Cutting edge: 2 mm
No. 10058-15

Circle Knife

Sharp cutting edge around tip.

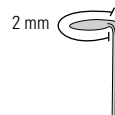
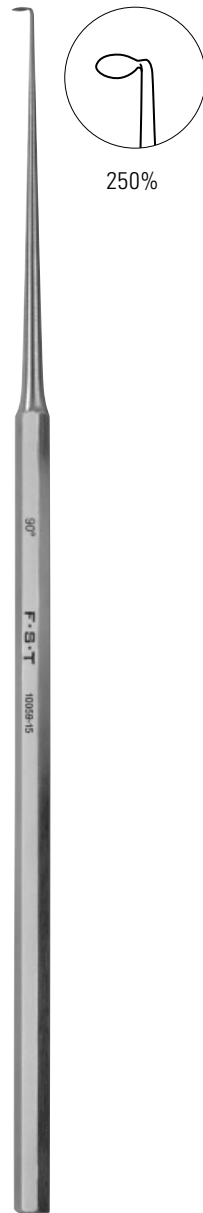

Angled 90°
16 cm
Cutting edge: 2 mm
No. 10059-15

Gross Anatomy Knives

Handles are made of fiberglass reinforced yellow nylon with a slip resistant surface that allows little chance of bacterial accumulation. The blades are made of German Molybdenum Stainless Steel.

KNIVES



40% of actual size

Dissection knife

28 cm
Cutting edge: 13 cm
No. 10157-13

30 cm
Cutting edge: 15 cm
No. 10157-15

33 cm
Cutting edge: 18 cm
No. 10157-18



40% of actual size

Brain sectioning knife

45 cm
Cutting edge: 30 cm
No. 10152-30

Obsidian Stone Age Scalpels

For applications where extremely fine cuts are required or for studies where trace metals from ordinary scalpel blades cannot be tolerated. These ultra fine cutting edges have been used in human surgical procedures where objectionable scar tissue results from the use of standard scalpels.

The blade is made from obsidian—a type of volcanic glass—which allows a much finer blade than is possible with the conventional steel blade. In some cases this makes the relatively inexpensive obsidian scalpel a suitable substitute for an expensive diamond knife.

Patterned after “stone age” knives which first made their appearance about 18,000 years ago, these modern versions utilize hard wood and plastic dowels for handles. Plastic dowels are made of polyoxymethylene.

Cautionary note:
 Obsidian is a very fragile material. Great care should be taken to not exert any lateral pressure on the blade during cutting. Each blade is hand-fashioned, so sizes, shapes and points will vary. While all the blades will have at least one sharp edge, some will have two.



Wood Dowel
Not autoclavable

Straight
 Approximate blade length: 6 mm
 No. 10110-01

Straight
 Approximate blade length: 12 mm
 No. 10110-03



Plastic Dowel
Autoclavable

Straight
 Approximate blade length: 6 mm
 No. 10110-05



Plastic Dowel
Autoclavable

Angled
 Approximate blade length: 6 mm
 No. 10110-07

Ceramic Blades

Advantages:

- Ceramic edge stays sharp 100 times longer than steel edge
- Rust and corrosion free
- Chemical and acid resistant
- Withstands up to 2400°C (4352°F)
- No electrostatic discharge concerns
- No trace metal contamination
- Fully nonmagnetic

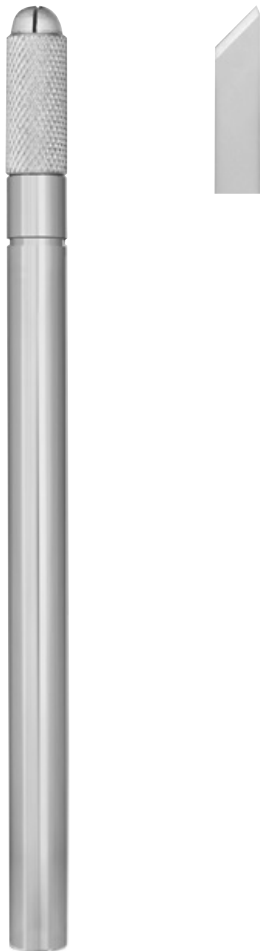

Aluminum Alloyed Handle
12,5 cm
No. 10025-50

Ceramic Blade
45° Cutting Edge
33 x 6 x 0,5 mm
Cutting edge: 8 mm
Pkg. of 5 blades
No. 10025-45

Diamond Knives

This knife has a gem-quality, neutral diamond blade which is honed to the finest cutting edge possible. The blade is made to an ophthalmic surgical standard and is inspected under 400x magnification. The retractable handle aids in care and storage.

Cautionary note:

This blade is extremely fragile and vulnerable to lateral pressure.

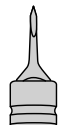

Cutting angle: 30°
12 cm
Cutting edge: 1 mm
Tip thickness: 0,15 mm
No. 10100-30



Cutting angle: 45°
12 cm
Cutting edge: 1 mm
Tip thickness: 0,15 mm
No. 10100-45

Grip slides up the handle to protect the tip for safe storage and packing.

Blade Holders and Breakers



11 cm
Jaw width: 4 mm
Flat surface
No. 10052-11



9 cm
Jaw width: 4 mm
Surface with concave and convex jaws
Handle diameter: 5,5 mm
No. 10053-09

13 cm
Jaw width: 4 mm
Surface with concave and convex jaws
Handle diameter: 8 mm
No. 10053-13

Breakable Carbon Steel Blades

These special, high carbon content blades are the only blades that will break cleanly. **Not autoclavable.**



Blade thickness: 0,1 mm
Box of 10 blades
No. 10050-00

Create Your Own Blade

With these blade holders/breakers and our special carbon steel blades, No. 10050-00, you can produce microblades in sizes that meet your own individual needs.

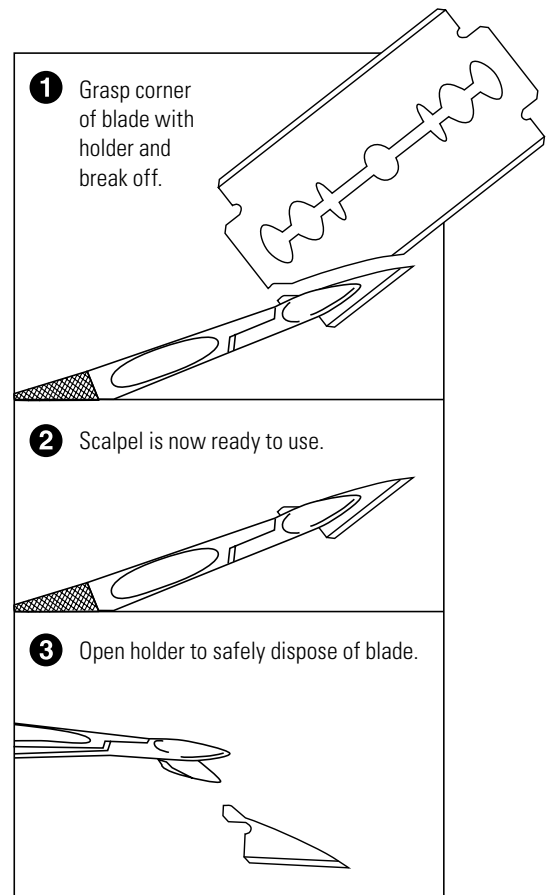

Carbon Steel Scalpel

Cold forged from carbon steel and sharpened to eliminate tissue distortion and blade drag. 12,5 cm plastic handle with slip-proof grip. **Sterile.**

MOST POPULAR

10316-14
10315-12

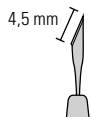

Cutting angle: 22,5°
13,5 cm
Cutting edge: 4,5 mm
Tip thickness: 0,15 mm
No. 10316-14



Cutting angle: 15°
13 cm
Cutting edge: 5 mm
Tip thickness: 0,15 mm
No. 10315-12

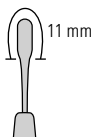

Crescent blade
14 cm
Cutting edge: 11 mm
Tip thickness: 0,20 mm
No. 10317-14



Needle blade
14,5 cm
Cutting edge: 4 mm
Tip thickness: 0,20 mm
No. 10318-14

Interchangeable Carbon Steel Blades

NOT AUTOCLAVABLE



Angled blade
Carbon steel
Cutting edge: 10 mm
Pkg. of 5 blades
No. 10035-15



Curved blade
Carbon steel
Cutting edge: 10 mm
Pkg. of 5 blades
No. 10035-20



Small flat blade
Carbon steel
Cutting edge: 1,5 mm
Pkg. of 5 blades
No. 10035-05



Large flat blade
Carbon steel
Cutting edge: 2,75 mm
Pkg. of 5 blades
No. 10035-10



Cane blade
Carbon steel
Cutting edge: 12 mm
Pkg. of 5 blades
No. 10035-25



Arc blade
Carbon steel
Cutting edge: 12 mm
Pkg. of 5 blades
No. 10035-30

Handle for Interchangeable Blades

9,5 cm
No. 10035-00
12,5 cm
No. 10035-12

Scalpel Handle #4 with Silicone

For heavy, gross anatomy work.
Molded to fit hand.



13,5 cm
No. 10009-13

Standard Scalpel Handle #4 Solid

Especially suitable for large dissections.



13 cm
No. 10004-13

Blades for #4 Scalpel Handle

The alloy used has a high carbon content which provides a longer lasting edge. Blades come individually wrapped. **Non-sterile.**



Box of 100 blades
No. 10020-00



Box of 100 blades
No. 10021-00



Box of 100 blades
No. 10022-00



Box of 100 blades
No. 10023-00

#3 Standard

MOST POPULAR



12 cm
No. 10003-12

#3 Secure

A safety lock holds the blade securely, and allows simple and safe blade attachment and removal.



1 Slide blade onto front pin of the handle.

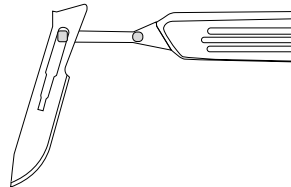

2 Then slide pin to front slot of blade. Rotate blade clockwise and secure blade to back pin on handle.

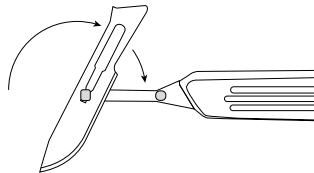

3 Scalpel is ready to use.

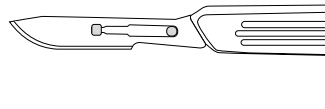

12 cm
No. 10003-13

Blades for #3 and #7 Scalpel Handles

The alloy used has a high carbon content which provides a longer lasting edge. Blades come individually wrapped. **Non-sterile.**

NOT AUTOCLAVABLE



Box of 100 blades
No. 10010-00



Box of 100 blades
No. 10011-00



Box of 100 blades
No. 10012-00



Box of 100 blades
No. 10015-00

**Short Scalpel
Handle #7**

12 cm

No. 10007-12

**Standard Scalpel
Handle #7**

16,5 cm

No. 10007-16

Scalpel Blade Remover

For safe removal of scalpel blades, simply insert scalpel with blade into the Scalpel Blade Remover and press the sides together. This will dislodge the blade from handle and hold the blade securely for release.

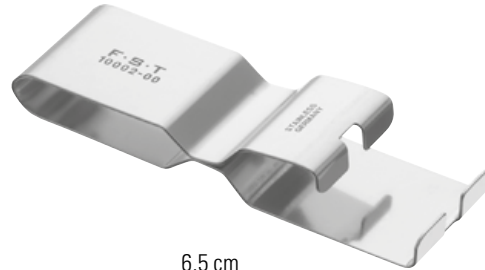

6,5 cm

No. 10002-00

Scalpel Blade Removal and Disposal Box

This plastic device will remove used scalpel blades safely and retain them for safe disposal. Can be used for blades that fit the #3, #4, #7 and Gross Anatomy handles.



7,5 x 5 x 2,5 cm

Capacity approximately 80 blades

Carton of 10 boxes

No. 10002-50

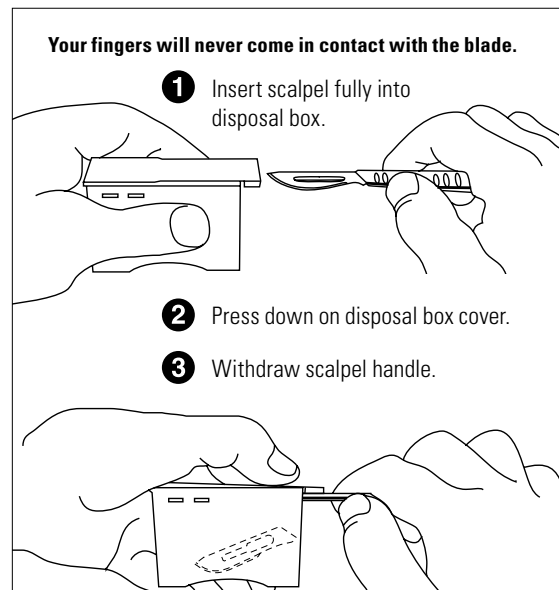

Gross Anatomy Blade and Handle



7,5 cm
Box of 100 blades
No. 10060-00

13 cm
No. 10060-13

Disposable Safety Scalpels

Plastic handle #3 with stainless steel blades. The protective cartridge completely covers the blade for safe, fast, and easy disposal. **Single-use and non-sterile.**



#10 scalpels
Pkg. of 10
No. 10000-10

#11 scalpels
Pkg. of 10
No. 10000-11

#15 scalpels
Pkg. of 10
No. 10000-15



Scalpel shown with safety cartridge closed and locked into place.

Safety Scalpel Handle #3 and Blade Cartridges

The Safety Scalpel Handle #3 is compatible with all Safety Scalpel Blades. The handle is reusable and made of Teflon coated stainless steel which provides a non-stick surface. The Blade Cartridges are color-coded with clear windows for easy identification. The protective cartridge completely covers the blade for safe, fast, and easy disposal. **Handle is reusable and autoclavable. Blades are single-use and non-sterile.**

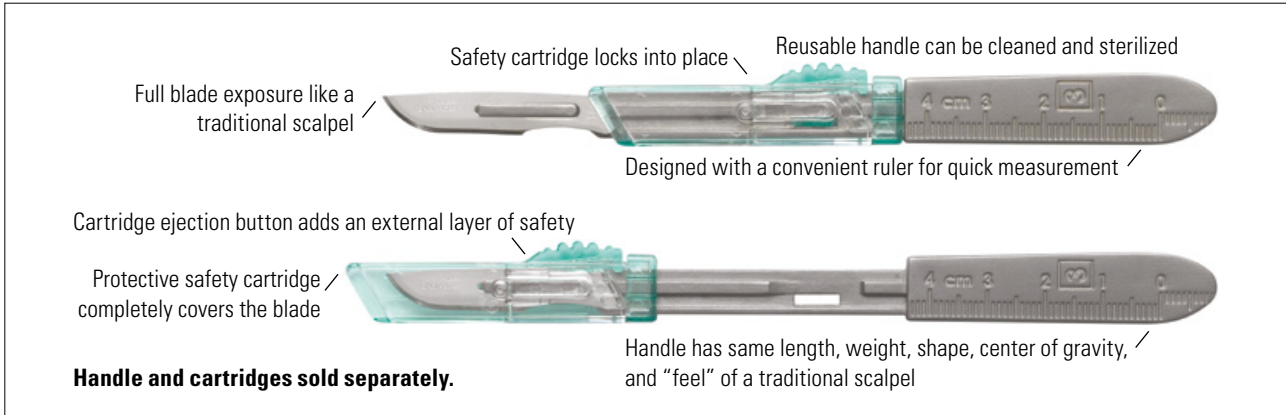

Safety Scalpel Handle #3



12,5 cm
Teflon coated stainless steel
No. 10006-12

Safety Scalpel Blade Cartridges



Safety Scalpel Blade Cartridges shown open and attached to handle.
Handle and cartridges sold separately.

#10 blades

Pkg. of 10

No. 10010-10

#11 blades

Pkg. of 10

No. 10011-10

#15 blades

Pkg. of 10

No. 10015-10



Forceps & Hemostats

Dumont	Pages	65 – 74
Fine	Pages	75 – 84
Moria	Page	78
S&T	Pages	79, 81
Standard	Pages	85 – 95
Hemostats	Pages	96 – 101

See page 209 for alloy and additional information.

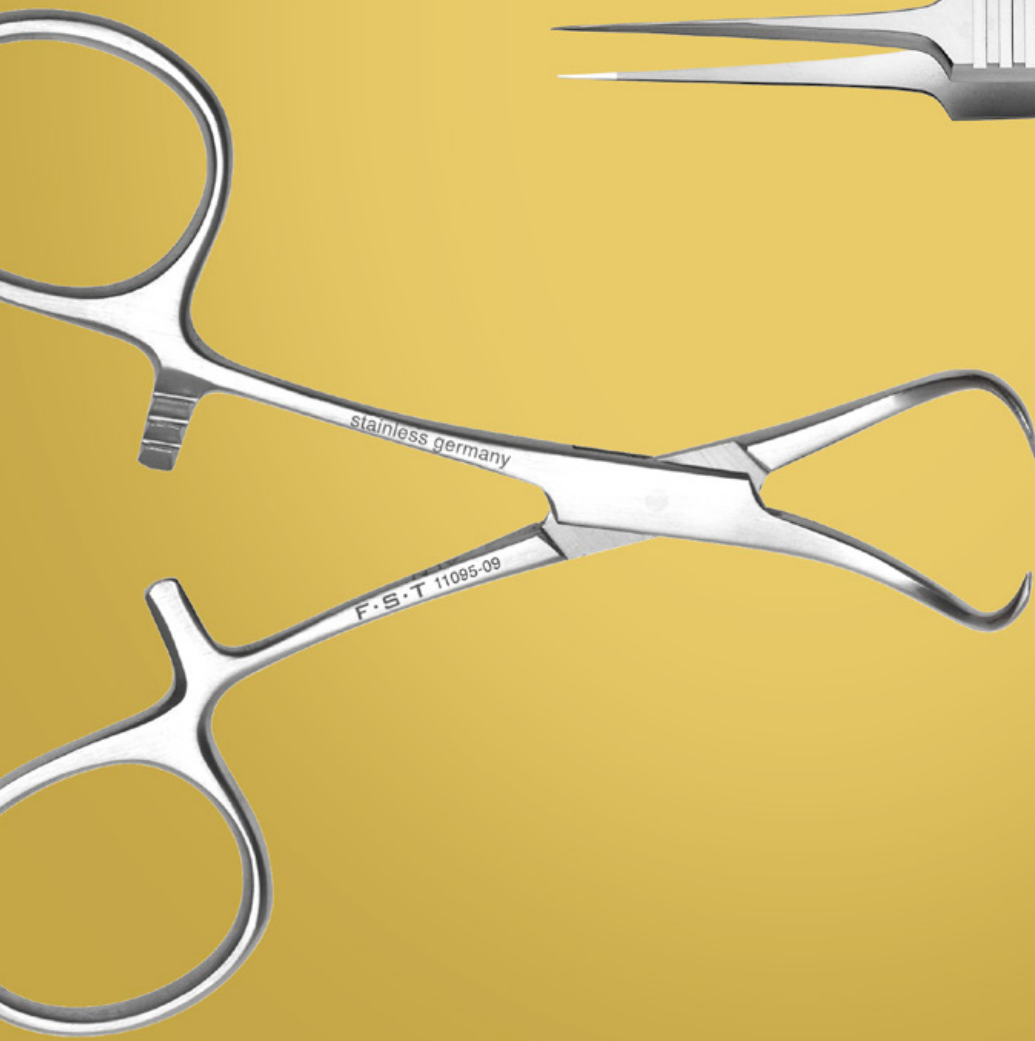

Dumont #5SF

The finest tips ever produced by Dumont.



Super fine tip
11 cm
Inox
0,025 x 0,005 mm
No. 11252-00

Dumont #5 Fine Tips

Finished under magnification and polished on the inside, the tips close flat to 3 mm and are less likely to open under excess pressure.

MOST POPULAR



Biology tip
11 cm
Inox
0,05 x 0,01 mm
No. 11254-20

Dumont #5 Ceramic Coated

These forceps are non-reflective. The scratch and corrosion resistant coating guarantees durability.

CERAMIC COATED

For more information about our ceramic instruments please visit page 203.



Biology tip
11 cm
Ceramic coated inox
0,05 x 0,01 mm
No. 11252-50

Dumont #5C0

These forceps have been honed down to make this the lightest and most precise Dumont forceps available.



Biology tip
11 cm
Dumostar
0,05 x 0,01 mm
No. 11295-20

FORCEPS

For information on Dumont alloys and tip styles, see page 209.

Dumont Micro-Blunted, Atraumatic Tipped Forceps

The sides of these forceps are distinctively ribbed to provide a better holding surface for maximum control of the instrument. The shanks are arched toward each other to transmit more holding strength to the points. The smooth inside surfaces at the tips will close flat to 5 mm with gentle pressure, increasing the total holding area considerably. The microscopically matched tips are gently blunted to prevent tissue puncture and are recommended as micro needle holders.

FORCEPS

For information on Dumont alloys and tip styles, see page 209.



Medical #5

Straight

11 cm
Inox
0,10 x 0,06 mm

No. 11253-20



Medical #5A

Off-center

11,5 cm
Inox
0,13 x 0,08 mm

No. 11253-21



Medical #7S

Short curve

12 cm
Inox
0,17 x 0,10 mm

No. 11273-22

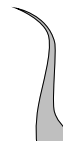

Medical #7

Curved

11,5 cm
Inox
0,17 x 0,10 mm

No. 11273-20



Medical #5/45

Angled 45°

11 cm
Inox
0,10 x 0,06 mm

No. 11253-25



Medical #5/90

Angled 90°

11 cm
Inox
0,10 x 0,06 mm

No. 11253-29

Dumont #55

Bevelled, like #5 but with extra light and fine shanks.



Biology tip
11 cm
Inox
0,05 x 0,02 mm
No. 11255-20

11 cm
Dumostar
0,05 x 0,02 mm
No. 11295-51

Dumont #5 Mirror Finish Forceps

The last 5 mm on the inside of the tips are highly polished to help prevent tissue from sticking. Ideal for embryos, nerves, or any other adhesive tissue.



Standard tip
11 cm
Inox
0,10 x 0,06 mm
No. 11251-23



Biology tip
11 cm
Inox
0,05 x 0,02 mm
No. 11252-23

Dumont #5

These are the most widely used Dumont forceps. Bevelled, very fine shanks for best visibility.

MOST POPULAR
11251-20
11252-20

335°C NOT AUTOCLAVABLE
11251-10

TITANIUM
11252-40
For more information see page 203.



Standard tip
11 cm
Inox
0,10 x 0,06 mm
No. 11251-20

Dumoxel
No. 11251-30

Dumostar
No. 11295-00

11 cm
Carbon
0,08 x 0,04 mm
No. 11251-10



Biology tip
11 cm
Inox
0,05 x 0,02 mm
No. 11252-20

Dumoxel
No. 11252-30

Dumostar
No. 11295-10

Titanium
No. 11252-40

For information on Dumont alloys and tip styles, see page 209.

Dumont WA #5

These specially designed forceps offer improved stability with an ergonomic body that allows the forceps to fit more comfortably in your hand. A domed end with no soldering grooves allows the forceps to be thoroughly and easily cleaned, preventing biofilm residues.

Dumont #5XL

FORCEPS

For information on Dumont alloys and tip styles, see page 209.



Side View



Standard tip
12 cm
Inox
0,10 x 0,06 mm

No. 11251-21



Biology tip
12 cm
Inox
0,05 x 0,02 mm

No. 11252-21



Standard tip
15 cm
Inox
0,10 x 0,06 mm

No. 11253-10

Dumont #L5

Slide sleeve keeps tips together so specimens may be securely held and retained. Slide may be locked in place so that forceps can be used in regular fashion.



Standard tip
11 cm
Inox
0,10 x 0,06 mm

No. 11253-27

Dumont #5 Teflon® Coated

These antimagnetic forceps are ideal for use in cryogenic environments and for EM samples. Teflon® coating provides a non-stick surface.



Standard tip
11 cm
Teflon coated inox
0,10 x 0,06 mm

No. 11626-11

Dumont #5/45

45° tips for improved visibility and control.

MOST
POPULAR



Standard tip
11 cm
Dumoxel
0,10 x 0,06 mm

No. 11251-35

Dumont #5/45 Cover Slip Forceps

Designed to pick up cover slips out of multi-well plates. The tip width is squared for a better grip.



300%

For information on
Dumont alloys
and tip styles,
see page 209.



1 mm from tip to bend
11,5 cm
Dumoxel
Upper tip: 0,10 x 0,08 mm
Lower tip: 0,10 x 0,02 mm

No. 11251-33

FORCEPS

Dumont #3

Tapered and sturdy shanks.

Dumont #3c

Dumont #6

Sharply angled tips for access to difficult areas.

FORCEPS

For information on Dumont alloys and tip styles, see page 209.

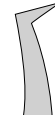

Standard tip

Standard tip

Standard tip

Standard tip

12 cm

12 cm

11 cm

11,5 cm

Dumoxel

Dumostar

Inox

Inox

0,17 x 0,10 mm

0,17 x 0,10 mm

0,17 x 0,10 mm

0,17 x 0,10 mm

No. 11231-30

No. 11293-00

No. 11231-20

No. 11260-20

Dumont #7 Fine Tips

Finished under magnification and polished on the inside, the tips close flat to 3 mm and therefore less likely to open under excess pressure.



Biology tip
11 cm
Inox
0,07 x 0,03 mm
No. 11274-20

Dumont #7

•TITANIUM•

11272-40
For more information see page 203.



Biology tip
11,5 cm
Dumoxel
0,07 x 0,04 mm
No. 11272-30



Standard tip
Dumoxel
No. 11271-30
Dumostar
No. 11297-10
Titanium
No. 11272-40

Dumont #7 Ceramic Coated

CERAMIC
COATED

For more information about our ceramic instruments please visit page 203.



Biology tip
11 cm
Ceramic coated inox
0,07 x 0,04 mm
No. 11272-50

Dumont #7B

SERRATED



Standard tip
11 cm
Inox
0,17 x 0,10 mm
No. 11270-20

For information on Dumont alloys and tip styles, see page 209.

FORCEPS

Dumont #4

Similar to #5, but with broader shanks.



Standard tip
11 cm
Dumoxel
0,13 x 0,08 mm
No. 11241-30

Biology tip
11 cm
Dumoxel
0,06 x 0,04 mm
No. 11242-40

Dumont #2 Laminectomy Forceps

These forceps can be used to break off delicate bone during mouse laminectomies, as well as fine skull bone removal.



Standard tip
12 cm
Inox
0,40 x 0,02 mm
No. 11223-20

Dumont #2AP Epoxy Coated

Provides good insulation for up to 220 AC voltage work and highly impervious to chemical solutions. Frozen or super cold sections will not adhere to the gripping surfaces.



Standard tip
12 cm
Epoxy coated Inox
Tip width: 1,5 mm
No. 11220-21

For information on Dumont alloys and tip styles, see page 209.

Dumont AA

Dumont AA Epoxy Coated

Slip-proof acid and electric shock resistant epoxy coating covering 17,5 mm from the tips.

Dumont SS

The tips are smooth on the inside for a gentle grip. Applying full strength will not separate tips and a strong hold on the smallest specimen is ensured.



Standard tip
12,5 cm
Inox
0,4 x 0,2 mm
No. 11210-20

Standard tip
12,5 cm
Epoxy coated inox
0,4 x 0,2 mm
No. 11210-10

Standard tip
13,5 cm
Inox
0,20 x 0,12 mm
No. 11203-23

Angled 45°
13,5 cm
Inox
0,20 x 0,12 mm
No. 11203-25

Biology tip
13,5 cm
Dumoxel
0,10 x 0,06 mm
No. 11200-33

For information on Dumont alloys and tip styles, see page 209.

FORCEPS

Dumont Mini Forceps

Dumont #5AC

FORCEPS

For information on Dumont alloys and tip styles, see page 209.



Style 3

7 cm
Inox
0,12 x 0,07 mm

No. 11200-10



Style 4

7 cm
Inox
0,14 x 0,06 mm

No. 11200-12



Style 5

8 cm
Inox
0,09 x 0,05 mm

No. 11200-14

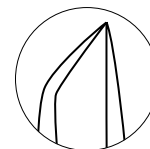

300%

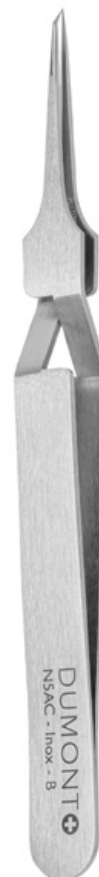

Biology Tip
Type #5 Anti-Capillary

11,5 cm
Inox
0,07 x 0,02 mm

No. 11258-20

O-Rings for Forceps

These rubber O-rings fit our forceps and keep them closed with variable degrees of pressure on the tips.



Pkg. of 10

No. 11200-00

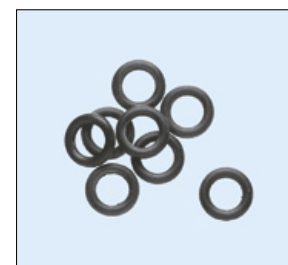

Gold Plated Forceps

Gold-Plating gives corrosion resistance to most chemicals, salts and acids. These forceps are perfect for any application where corrosion resistance and toughness are primary requirements.



Straight

11,5 cm
0,1 x 0,06 mm

Gold Plated
Stainless Steel

No. 11915-11



Curved

11,5 cm
0,2 x 0,1 mm

Gold Plated
Stainless Steel

No. 11917-12



Angled 30°

11,5 cm
0,1 x 0,06 mm

Gold Plated
Stainless Steel

No. 11911-11

Diamond Coated Forceps

Diamond coating provides increased corrosion resistance and greater protection from wear and tear, thus extending the operational life of the forceps, as well as providing a stronger grip at the tips.



Straight

14 cm
0,15 x 0,1 mm

Diamond Coated
Stainless Steel

No. 11990-14



Angled 30°

14 cm
0,15 x 0,1 mm

Diamond Coated
Stainless Steel

No. 11991-14



Straight

12 cm
1,65 x 0,05 mm

Diamond Coated
Stainless Steel

No. 11992-12

Mirror Finish Broad Shanks

These forceps have long and narrow shanks with thin, highly polished tips to prevent tissue from sticking. Ideal for embryos, nerves, or other adhesive tissues.



Straight
13 cm
0,3 x 0,15 mm
No. 11923-13

Forceps with Replaceable Tips

Stainless steel body with replaceable plastic tips. Tips are made of polyvinylidene fluoride (PVDF) and are electrostatic discharge (ESD) safe. Body and plastic tips are corrosion and abrasion resistant.



Straight
13 cm
0,5 x 0,5 mm
Stainless Steel body with replaceable plastic tips
No. 11980-13



Pkg. of 2 tips and 3 screws
Replacement plastic tips
Straight, strong
4 cm
0,5 mm
No. 11988-01

Pkg. of 2 tips and 3 screws
Replacement plastic tips
Straight, very fine
4 cm
0,5 mm
No. 11988-02

Pkg. of 2 tips and 3 screws
Replacement plastic tips
Curved
4 cm
0,5 mm
No. 11988-03

Fine Forceps Broad Shanks

Straight forceps with sturdy coarse tips.



12 cm
0,2 x 0,12 mm

No. 11445-12

Fine Forceps Mirror Finish

The last 5 mm on the inside of the tips are highly polished to help prevent tissue from sticking. Ideal for embryos, nerves, or other adhesive tissue.



11 cm
0,10 x 0,06 mm

No. 11412-11



11 cm
0,05 x 0,02 mm

No. 11413-11

Fine Forceps Self-Closing

Ideal for lifting and holding EM grids. Consistent pressure at tips. Correctly tensioned "cross-over" shanks come to a microscopically matched point.



11,5 cm
0,08 x 0,04 mm

No. 11480-11



11 cm
0,10 x 0,06 mm

No. 11485-11



11,5 cm
0,20 x 0,12 mm

No. 11487-11

Moria Ultra Fine Forceps

These forceps have the most finely executed points available. They are extremely light, superbly balanced, and have a gentle spring action. The shanks are specially designed with an arch which ensures maximum force to the tips. The tips close flat for 6 mm from the points to give a large holding area. The tips have been expertly finished under magnification.

Moria Iris Forceps

Balanced with gentle spring action and tips that are perfectly matched.

FORCEPS



Moria MC40

Moria MC40/B

Moria 9980

Moria 9987

Moria MC32/B

Moria MC31/B



Straight

Curved

Straight

Curved

Smooth
Blunt

Smooth
Blunt

10 cm
Tip width: 0,5 mm

10 cm
Tip width: 0,5 mm

No. 11373-22

No. 11373-12

Moria MC32

Moria MC31



Microserrated

Microserrated

No. 11370-32

No. 11370-31

Fine Forceps



Straight

11 cm
0,3 x 0,25 mm

No. 00108-11



Angled 45°

11 cm
0,3 x 0,25 mm

No. 00109-11

SuperGrip Forceps

The tips are processed with MicroCrystals®, a method developed by S&T® to infuse tungsten carbide on stainless steel. The formation of this ultra-fine coating guarantees atraumatic handling of tissue while improving the grip dramatically. The recommended use is where forceps are utilized as needle holders or when slippery tissues might be encountered.



300%

The gripping surface is similar to a match head.



Straight

11 cm
0,3 x 0,25 mm

No. 00632-11



Angled 45°

11 cm
0,3 x 0,25 mm

No. 00649-11

Bonn

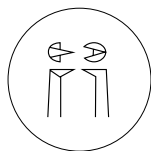

20x magnification

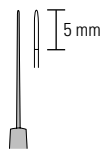

Smooth

7 cm

Tip width: 0,3 mm

Tying Platform: 5 mm

No. 11083-07

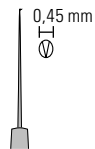

1x2 teeth

7 cm

Tip width: 0,45 mm

Teeth width: 0,1 mm

No. 11084-07

Mirror Finish Bonn Forceps

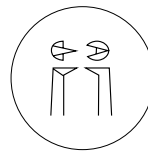

20x magnification

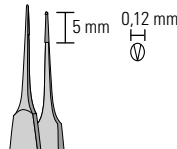

Straight

1x2 teeth

10 cm

Tip width: 0,12 mm

Tying Platform: 5 mm

Partly polished

No. 11090-10

Mirror Finish Suture Tying Forceps with Teeth

A unique tip style fusing a suture tying platform and a 1x2 teeth tip for tissue manipulation.

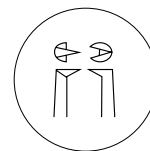

20x magnification

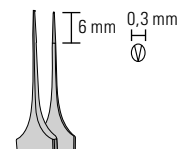

Straight

9 cm

Tip width: 0,3 mm

Platform with 1x2 teeth

No. 11090-09

Mirror Finish Suture Tying Forceps

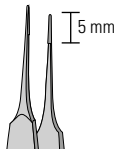

Straight
10 cm
Tip diameter: 0,3 mm
Tying Platform: 5 mm
Partly polished
No. 11093-10

McPherson Forceps

MOST POPULAR

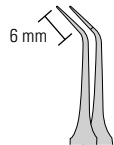

Angled 45°
Smooth
9 cm
Tip width: 0,4 mm
Tying Platform: 6 mm
No. 11063-07

Suture Tying Forceps

The platform tips close flat. This ensures a reliable grip on sutures.

S&T®

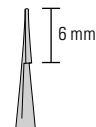
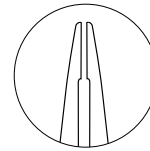

13,5 cm
Tip diameter: 0,3 mm
Tying platform: 6 mm
No. 00272-13

Suture Tying Forceps

The platform tips close flat. This ensures a reliable grip on sutures.

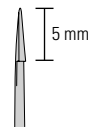

10 cm
Tip diameter: 0,5 mm
Tying platform: 5 mm
No. 18025-10

**Round Handled
Suture Tying Forceps**

Round handles allow easy fingertip adjustments.

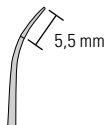

10,5 cm
Tip diameter: 0,35 mm
Tying platform: 5,5 mm
No. 18026-10

Vial Forceps

Tips taper for 6 cm allowing easy access to specimens in vials.

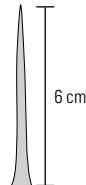
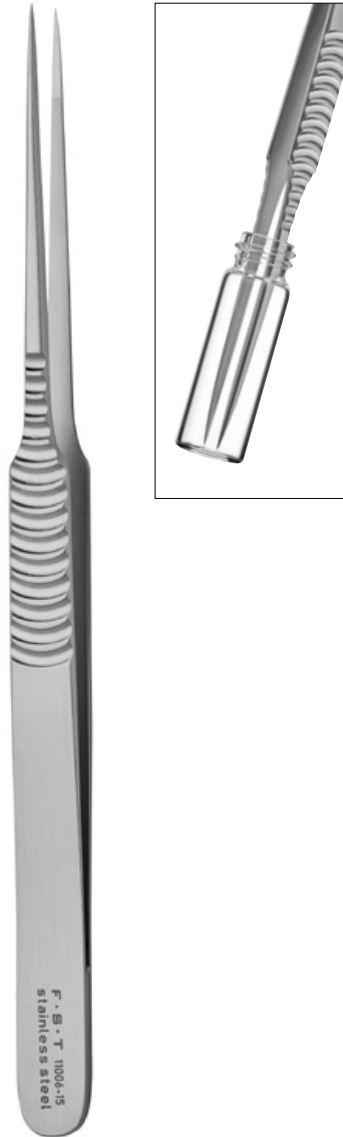

15 cm
Tip diameter: 0,5 mm
No. 11006-15

Vitro Grasping Forceps



14 cm
Serrated
Tip diameter: 0,7 mm
No. 11900-14

Graefe Forceps



Straight
Serrated

7 cm
Tip width: 0,6 mm

No. 11064-07



Curved
Serrated

7 cm
Tip width: 0,6 mm

No. 11065-07

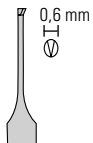

Straight
1x2 teeth

No. 11066-07

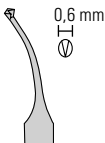

Curved
1x2 teeth

No. 11067-07

Bishop-Harman

Extra light, fenestrated handles ensure a good grip.

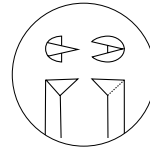

10x magnification



Serrated

8,5 cm
Tip width: 0,5 mm

No. 11069-08

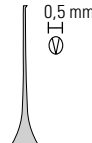

1x2 teeth

8,5 cm
Tip width: 0,5 mm

No. 11070-08

Octagon Forceps

The octagon shaped grip provides a particularly secure finger hold.



Straight
Serrated

9,5 cm
Tip width: 0,8 mm

No. 11040-08



Curved
Serrated

9,5 cm
Tip width: 0,8 mm

No. 11041-08

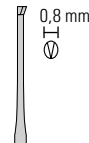

Straight
1x2 teeth

No. 11042-08

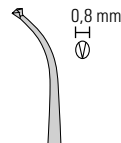

Curved
1x2 teeth

No. 11043-08

Extra Fine Graefe Forceps

FORCEPS



80% of actual size



Serrated
10 cm
Tip width: 0,5 mm
No. 11150-10



Serrated
10 cm
Tip width: 0,5 mm
No. 11151-10



Serrated
10 cm
Tip width: 0,5 mm
No. 11152-10



Smooth
No. 11158-10



Smooth
No. 11159-10



Smooth
No. 11160-10

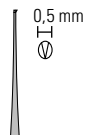

1x2 teeth
No. 11153-10



1x2 teeth
No. 11154-10



1x2 teeth
No. 11155-10

Graefe Forceps

MOST POPULAR
11051-10
11054-10

TITANIUM
11650-10 – 11652-10
For more information see page 203.



Serrated
Tip width: 0,8 mm
No. 11050-10



Serrated
Tip width: 0,8 mm
No. 11051-10



Serrated
Tip width: 0,8 mm
No. 11052-10



Serrated
Tip width: 0,8 mm
No. 11049-10

Titanium
Tip width: 1,2 mm
No. 11650-10

Titanium
Tip width: 1,2 mm
No. 11651-10

Titanium
Tip width: 1,2 mm
No. 11652-10

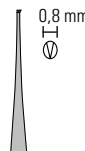

1x2 teeth
Tip width: 0,8 mm
No. 11053-10



1x2 teeth
Tip width: 0,8 mm
No. 11054-10



1x2 teeth
Tip width: 0,8 mm
No. 11055-10

Sliding Lock Forceps



Smooth
11 cm
Tip width: 1 mm
Slide lock
No. 11062-10

Episcleral Forceps

The tips of these forceps arch toward each other, closing flat. Exceptional gripping power is possible with minimal damage to tissue. A limit pin prevents excessive applied pressure.

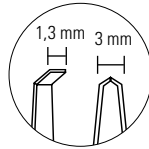

300%



10 cm
Tip thickness: 0,2 mm
Tip Dimension: 1,3 x 3 mm
No. 11071-10

Pierson Fixation Forceps

For exceptional gripping power with no damage to sclera, vascular sheath and epineurium.

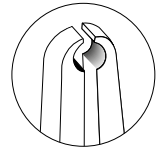

1800%

Tissue retention hole of 0,3 mm behind tips.



Straight
13 cm
Tip Dimension: 0,1 x 0,4 mm
No. 18155-13

Plastic Forceps

These forceps are non-magnetic, acid resistant and able to withstand temperatures up to 240°C (464°F). Tips do not spread under pressure. Plastic forceps are made of Acetyl and will be sold in packages of 10 pieces.

FORCEPS



Sharp
Straight
11,5 cm
0,40 x 0,25 mm
No. 11700-00



Blunt
Straight
11,5 cm
1,5 x 0,40 mm
No. 11700-03

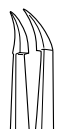

Sharp
Curved
11,5 cm
0,30 x 0,20 mm
No. 11700-01



Blunt
Curved
11,5 cm
1,5 x 0,40 mm
No. 11700-04

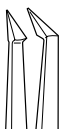

Sharp
Angled 45°
11,5 cm
0,30 x 0,20 mm
No. 11700-02

Cross Action Forceps

These tissue transport forceps have a gentle action.

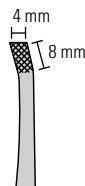

Cross serrated
10 cm
Tip Dimension: 4 x 8 mm
No. 11075-00

Cover Glass Forceps

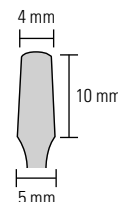

Straight
10,5 cm
Tip Dimension: 4 x 5 x 10 mm
No. 11074-02



Angled
10,5 cm
Tip Dimension: 4 x 5 x 10 mm
No. 11073-10

Ring Forceps

For transport of tissue and organs. With limit screw to prevent excessive applied pressure.



8,5 cm
Inner Diameter: 1 mm
Outer Diameter: 1,5 mm

No. 11101-09



9 cm
Inner Diameter: 2,2 mm
Outer Diameter: 3 mm

No. 11103-09



9 cm
Inner Diameter: 4,8 mm
Outer Diameter: 6 mm

No. 11106-09

Circle Forceps

Cupped forceps for atraumatic gripping of organs and tissues.



11,5 cm
Tip diameter: 0,7 mm

No. 11072-11

Live Insect Handling Forceps

Very delicate.



Narrow
10 cm

No. 26029-10



Wide
10 cm

No. 26030-10

Micro-Adson

Our most delicate version of the popular Adson forceps.

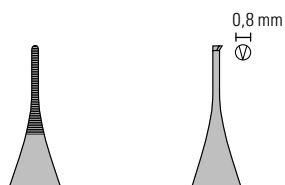

Serrated	1x2 teeth
12 cm	12 cm
Tip width: 0,8 mm	0,8 mm
No. 11018-12	No. 11019-12

Micro-Adson with Fenestrated Handle

Our delicate Micro-Adson forceps, with five windows to aid in stability and easy finger adjustments.

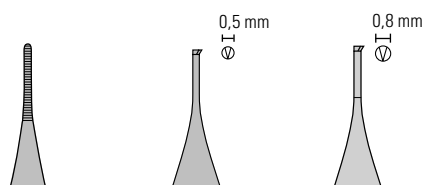

Serrated	1x2 teeth	1x2 teeth with 6 mm platform
12 cm	12 cm	12 cm
0,8 mm	0,5 mm	0,8 mm
No. 11020-12	No. 11032-12	No. 11022-12

Adson

Wide, strong grip with narrow tips.

MOST POPULAR

11006-12
11027-12

TUNGSTEN CARBIDE

11506-12
For more information see page 203.

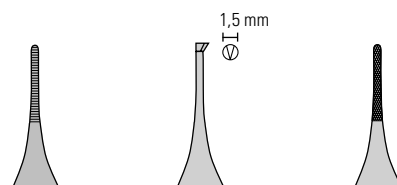

Serrated	1x2 teeth	Cross serrated tungsten carbide inlaid tip
12 cm	12 cm	12 cm
1,5 mm	1,5 mm	1,5 mm
No. 11006-12	No. 11027-12	No. 11506-12

Adson DeBakey



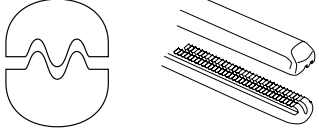

Atraumatic DeBakey Serrations

This tooth pattern, as shown, consists of one row of atraumatic teeth meshed with two opposite rows of atraumatic teeth.

These two forceps are ideal for gentle, atraumatic gripping of vessels, tissue and other delicate structures.

Adson-Graefe



Adson-Brown



FORCEPS



DeBakey serrations
12,5 cm
Tip width: 1,5 mm
No. 11617-12



DeBakey serrations
15 cm
Tip width: 1,5 mm
No. 11616-15



Fine sharp teeth
12,5 cm
Tip width: 4,5 mm
No. 11030-12

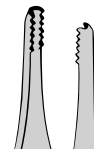

Shark teeth
12 cm
Tip width: 1,4 mm
No. 11627-12

Standard Pattern

Broad pattern with strong spring action.

FORCEPS



Straight Serrated

Tip width (mm)	Length (cm)	Item
2,5	12	No. 11000-12
2,8	13	No. 11000-13
3,25	14,5	No. 11000-14
3,3	16	No. 11000-16
3,7	18	No. 11000-18
3,75	20	No. 11000-20
3,9	25	No. 11000-25
4	30	No. 11000-30

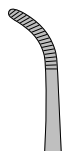

Curved Serrated

Tip width (mm)	Length (cm)	Item
2,5	12	No. 11001-12
2,8	13	No. 11001-13
3,25	14,5	No. 11001-14
3,3	16	No. 11001-16
3,7	18	No. 11001-18
3,75	20	No. 11001-20

Narrow Pattern

Lighter spring action than standard pattern for grasping more delicate tissue.

•TITANIUM•

11602-14
For more information see page 203.



Straight Serrated

Tip width (mm)	Length (cm)	Item
2	12	No. 11002-12
2,15	13	No. 11002-13
2,25	14,5	No. 11002-14
2,25	14,5	No. 11602-14
2,35	16	No. 11002-16
2,4	18	No. 11002-18
2,75	20	No. 11002-20
3,2	25	No. 11002-25



Curved Serrated

Tip width (mm)	Length (cm)	Item
2	12	No. 11003-12
2,15	13	No. 11003-13
2,25	14,5	No. 11003-14
2,35	16	No. 11003-16
2,4	18	No. 11003-18
2,75	20	No. 11003-20

Semken

Slim pattern with long, narrow shanks and gentle spring action.

•TITANIUM•

11608-15
For more information
see page 203.



Straight
Serrated

Tip width (mm)	Length (cm)	Item
1,3	13	No. 11008-13
1,5	15	No. 11008-15
1,5	15	No. 11608-15



Curved
Serrated

Tip width (mm)	Length (cm)	Item
1,3	13	No. 11009-13
1,5	15	No. 11009-15

Mouse Handling Forceps

Long handles make picking up small rodents easy and help prevent bites.



21 cm
Forceps with serrated silicone tips
Gripping surface: 15 x 20 mm

No. 11036-20



Replacement silicone tips
Pkg of 2 tips

No. 11036-90

FORCEPS

Tissue Forceps



Straight
Narrow 1x2 teeth
10 cm
No. 11023-10

12 cm
No. 11023-12

Straight
Narrow 1x2 teeth
14,5 cm
No. 11023-14

15,5 cm
No. 11023-15

Straight
Standard 1x2 teeth
12 cm
No. 11021-12

14,5 cm
No. 11021-14

Straight
Standard 2x3 teeth
14,5 cm
No. 11022-14

15,5 cm
No. 11022-15



Curved
Narrow 1x2 teeth
14 cm
No. 11029-14

Tissue Forceps

Used with rongeur No. 16021-14 (page 36) in laminectomy to securely hold spinal column.

Gillies

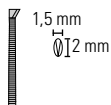

Cross-Serrated
1x2 teeth
15 cm
Tip Dimension: 1,5 x 2 mm
No. 11028-15

Russian

Special cupped pattern for superior grip.

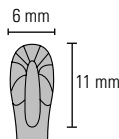

15 cm
Tip Dimension: 6 x 11 mm
No. 11026-15

Organ Holding Forceps

With limit screw to prevent excessive applied pressure.

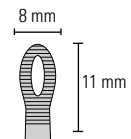

Serrated
14,5 cm
Tip Dimension: 8 x 11 mm
No. 11031-15

London Forceps

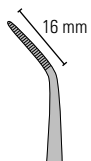

Angled
Serrated

16 cm

No. 11080-02

Titanium Forceps

•TITANIUM•

For more information
see page 203.



Straight
Serrated

16 cm

No. 11602-16

Gerald Forceps



Straight
Serrated

18 cm

No. 11014-18

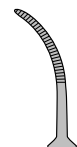

Curved
Serrated

18 cm

No. 11015-18

Taylor Forceps

Serrated and smooth versions available.





 Straight
Serrated
17 cm
No. 11010-17



 Curved
Serrated
17 cm
No. 11011-17

 Straight
Smooth
17 cm
No. 11016-17

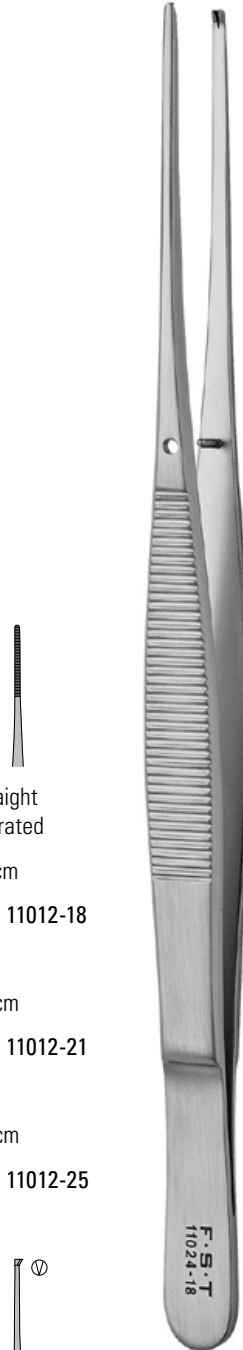
 Curved
Smooth
17 cm
No. 11017-17

Potts-Smith Forceps





 Straight
Serrated
18 cm
No. 11012-18

 21 cm
No. 11012-21

 25 cm
No. 11012-25

 Curved
Serrated
18 cm
No. 11013-18

 21 cm
No. 11013-21

 Straight
1x2 teeth
18 cm
No. 11024-18

 Curved
1x2 teeth
18 cm
No. 11025-18

Ultra Fine Hemostat



Straight
Smooth

12 cm
Tip width: 0,6 mm

No. 13020-12



Curved
Smooth

12 cm
Tip width: 0,6 mm

No. 13021-12

Fine Hemostat



Straight
Smooth

12 cm
Tip width: 1 mm

No. 13006-12



Curved
Smooth

12 cm
Tip width: 1 mm

No. 13007-12

Micro-Mosquito



Straight
Serrated

12 cm
Tip width: 1,3 mm

No. 13010-12



Curved
Serrated

12 cm
Tip width: 1,3 mm

No. 13011-12

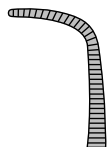

Angled 90°
Serrated

12 cm
Tip width: 1,3 mm

No. 13012-12

Halsted-Mosquito



13108-12



13008-12



13109-12



Straight
Serrated

12,5 cm
Tip width: 1 mm

No. 13008-12



Curved
Serrated

12,5 cm
Tip width: 1 mm

No. 13009-12



Straight
Serrated

12,5 cm
Tip width: 1 mm
Left handed

No. 13108-12



Curved
Serrated

12,5 cm
Tip width: 1 mm
Left handed

No. 13109-12

HEMOSTATS

Crile



Straight
Serrated

14 cm
Tip width: 1,5 mm

No. 13004-14

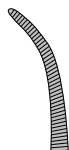

Curved
Serrated

14 cm
Tip width: 1,5 mm

No. 13005-14

Kelly



Straight
Serrated

14 cm
Tip width: 1,5 mm

No. 13018-14

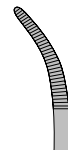

Curved
Serrated

14 cm
Tip width: 1,5 mm

No. 13019-14

Baby-Mixter

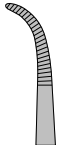

Curved
Serrated
14 cm
Tip width: 1,3 mm
No. 13013-14

Providence-Hospital

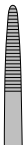

Straight
Serrated
14 cm
Tip width: 1,5 mm
No. 13014-14

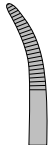

Curved
Serrated
14 cm
Tip width: 1,5 mm
No. 13015-14

HEMOSTATS

Hartman

MOST POPULAR

13003-10



Straight
Serrated

10 cm
Tip width: 1 mm

No. 13002-10



Curved
Serrated

10 cm
Tip width: 1 mm

No. 13003-10

Backhaus Towel Clamp



9 cm

No. 11095-09



13 cm

No. 11095-13

Allis Clamp

Tissue and organ holding forceps.



Allis



4 mm

5x6 teeth

15 cm

Tip width: 4 mm

No. 11091-15

Allis-Baby



3 mm

4x5 teeth

12 cm

Tip width: 3 mm

No. 11092-12

Lorna Clamp



Serrated

10 cm

Tip width: 6 mm

No. 11096-10



Serrated

13 cm

Tip width: 7 mm

No. 11096-13

HEMOSTATS



Probes, Needle Holders, Wound Closure, Retractors & Clamps

Probes & Hooks	Pages	103 – 107
Spatulae	Pages	106 – 109
Hippocampal Tools	Page	110
Spoons	Page	111
Pins & Holders	Pages	112 – 113
Wound Closure	Pages	114 – 125
Retractors	Pages	126 – 133
Vascular Instruments	Pages	134 – 143

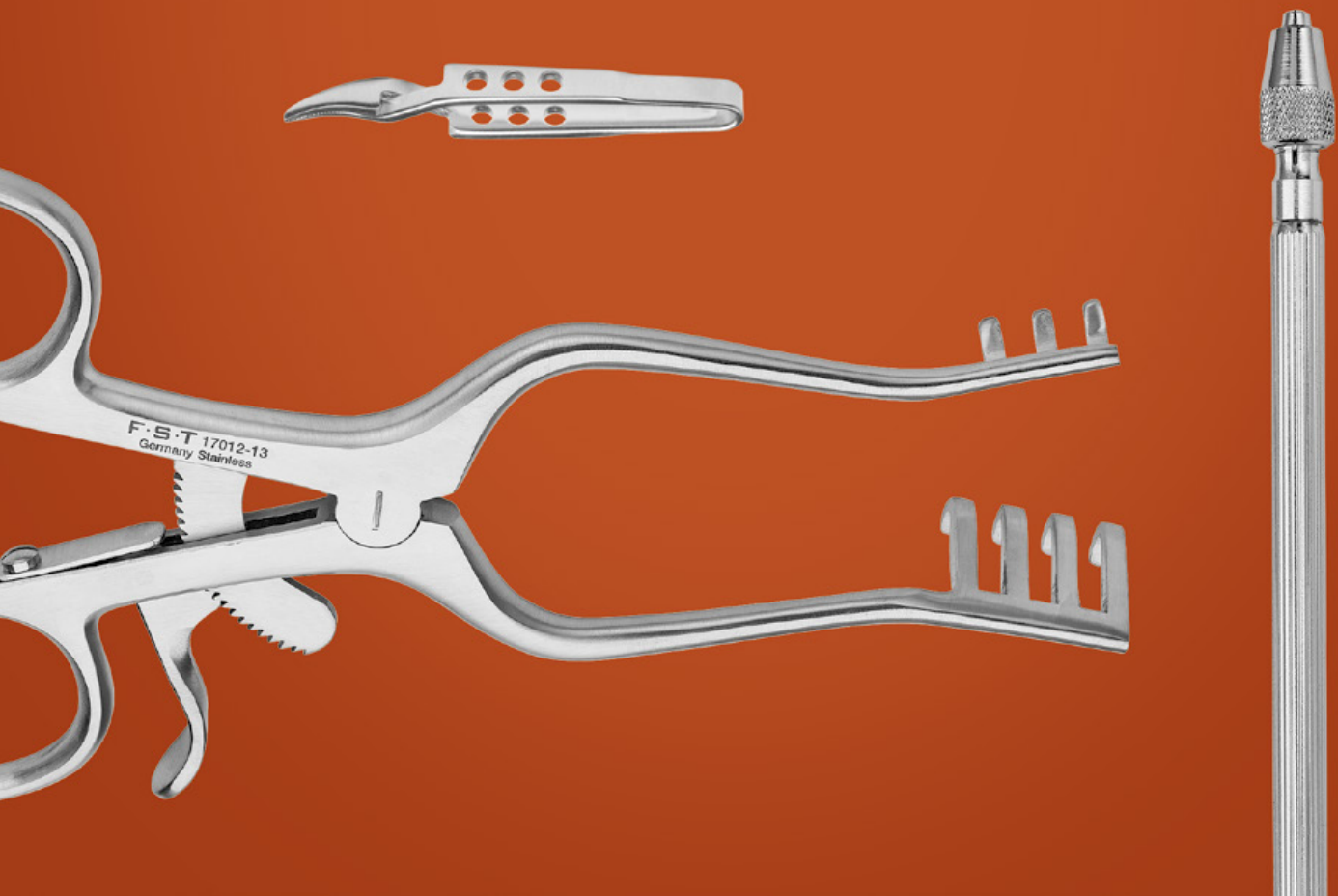

Double Pronged Pick

For peritoneum, pleura, endocardium, organ capsules and skin. Grasps and lifts skin, tissue and dura, etc.

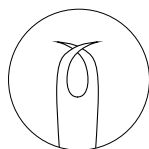

700%

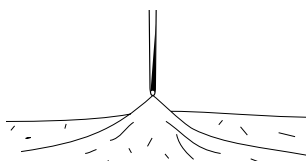

The tip consists of two very sharp, nearly horizontally opposed points. By applying gentle downward pressure and twisting slightly in a clockwise fashion, the points will embed themselves horizontally into fine membranes or skin, etc., so that it may be lifted upward. This instrument also has been used successfully when separating fine tissue from an underlying area that is not to be cut.

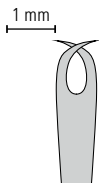

11 cm
Tip diameter: 1 mm

No. 18067-11

Spinal Cord Hook

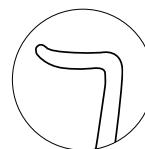

300%

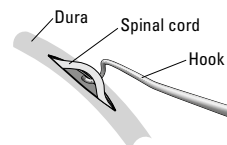

Shaped like a ligation aid and sized to isolate the spinal cord from the dura of adult mice and neonatal rats. The cord can then be cut with minimal damage to the dura.



12 cm
Tip diameter: 3 mm

No. 10162-12

Bonn Micro Probes

Micro Points



Actual size
 Angled 45°
 13,5 cm
 Tip diameter: 0,025 mm
 No. 10032-13



Actual size
 Straight
 13,5 cm
 Tip diameter: 0,025 mm
 No. 10030-13



Actual size
 Large curve
 13,5 cm
 Tip diameter: 0,038 mm
 No. 10033-13



Actual size
 Curved
 13,5 cm
 Tip diameter: 0,025 mm
 No. 10031-13



300%
 Angled 90° short
 15,5 cm
 Tip diameter: 0,05 mm
 No. 10063-15



300%
 Angled 45°
 15,5 cm
 Tip diameter: 0,038 mm
 No. 10066-15



300%
 Angled 90°
 15,5 cm
 Tip diameter: 0,02 mm
 No. 10065-15

Probes and Explorers

Micro Hooks

MOST POPULAR

10140-01

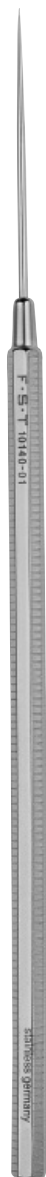

Actual size

Short angle

15,5 cm
Tip diameter: 0,12 mm

No. 10140-04



Actual size

Straight

15,5 cm
Tip diameter: 0,25 mm

No. 10140-01



Actual size

Long angled

15,5 cm
Tip diameter: 0,15 mm

No. 10140-03



Actual size

Angled

15,5 cm
Tip diameter: 0,15 mm

No. 10140-02



175%

Short round hook

13 cm
Tip diameter: 0,05 mm

No. 10064-14



175%

Blunt hook

12 cm
Tip diameter: 0,30 mm

No. 10062-12



175%

Sharp hook

12 cm
Tip diameter: 0,075 mm

No. 10061-12

Titanium Micro Point, Y-Hook, and Spatula

These instruments are lightweight, color coded for easy identification, have an ergonomic design and a non-reflective surface.

•TITANIUM•

For more information
see page 203.

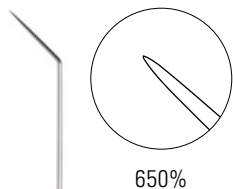

650%



Micro Point

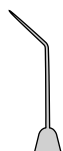

Angled 45°

12,5 cm
Tip diameter: 0,4 mm

No. 10165-11

•TITANIUM•

For more information
see page 203.

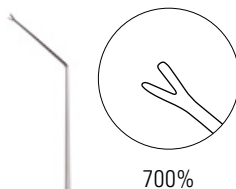

700%



Y-Hook



Angled 45°

12,5 cm
Tip width: 0,5 mm

No. 10166-11

•TITANIUM•

For more information
see page 203.

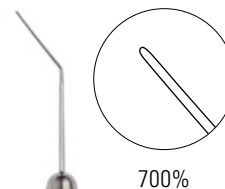

700%



Micro Spatula



Angled 30°

12,5 cm
Tip width: 0,6 mm
Tip thickness: 0,25 mm

No. 10167-11

Vessel Dilating Probe



200%



Angled 45°

12,5 cm
Tip diameter: 0,6 mm

No. 10160-13

Gross Anatomy Probe

MOST POPULAR

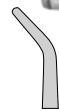

Angled 45°

15 cm
Tip diameter: 1,2 mm

No. 10088-15

Combination Probe and Spatula

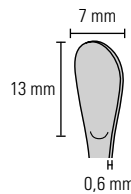

14 cm
Spatula dimension: 13 x 7 x 0,6 mm
Tip diameter: 0,1 mm

No. 10090-13

Combination Spoon and Spatula

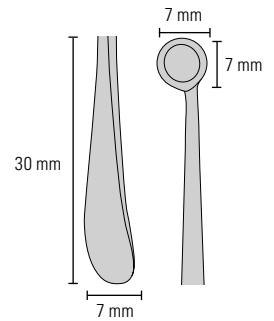

17,5 cm
Spatula dimension: 30 x 7 mm
Spoon diameter: 7 mm

No. 10090-17

SPATULAE

Micro Spatula

Mirror Finish Micro Spatula

Mirror finished to provide a non-stick spatula.

Double-Ended Micro Spatula

MOST POPULAR

Iris Spatulae

SPATULAE

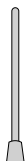

Straight

11 cm
Tip width: 1 mm
Tip thickness: 0,25 mm

No. 10089-11



Slightly curved

12 cm
Tip width: 0,8 mm
Tip thickness: 0,25 mm

No. 10087-12

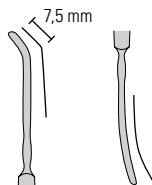
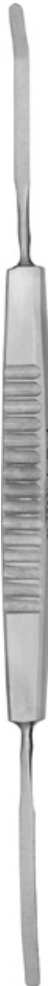

Angled

13 cm
Tip width: 2 mm
Tip thickness: 0,3 mm

No. 10091-12



Straight

13 cm
Tip width: 3 mm
Tip thickness: 0,4 mm

No. 10094-13



Slightly curved

13 cm
Tip width: 1,7 mm
Tip thickness: 0,3 mm

No. 10093-13



Curved

12 cm
Tip width: 1,8 mm
Tip thickness: 0,3 mm

No. 10092-12

Micro Spatula Kit

Kit with 4 pieces



150% of actual size

SPATULAE

Black



Straight

6 cm
Tip width: 0,2 mm

No. 10098-06

Blue



Straight

6 cm
Tip width: 0,3 mm

Green



Straight

6 cm
Tip width: 0,5 mm

Red



Straight

6 cm
Tip width: 0,7 mm

Mini Hippocampal Dissecting Tool

The instrument ends are malleable to allow you to adjust their shape to the correct angle for optimal positioning.



14,5 cm
Spatula dimension: 20 x 6 mm & 13 x 3 mm
Tip thickness: 0,5 mm

No. 10099-12

Hippocampal Dissecting Tool

The instrument ends are malleable to allow you to adjust their shape to the correct angle for optimal positioning.

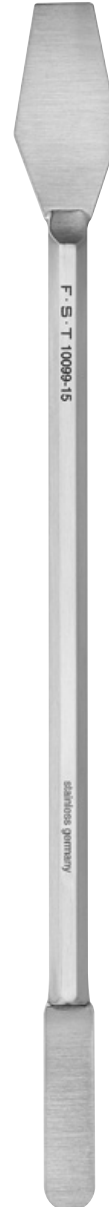

16 cm
Spatula dimension: 27 x 14 mm & 27 x 6 mm
Tip thickness: 0,5 mm

No. 10099-15

Spoon



Moria 1121B

12,5 cm
Diameter: 8 mm
Depth: 2 mm

No. 10321-08

Mini Perforated Spoon

Most commonly used to take embryos out of solution and handling very small organs.

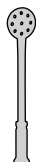

Moria MC 17C

10 cm
Diameter: 8 mm
Depth: 1 mm

Perforations: 0,8 mm
in diameter

No. 10370-19

Perforated Spoon

Most commonly used to take embryos out of solution and handling very small organs.

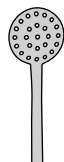

Moria MC 17 BIS

14,5 cm
Diameter: 15 mm
Depth: 3 mm

Perforations: 0,9 mm
in diameter

No. 10370-18

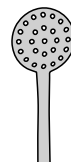

Moria MC 17

14,5 cm
Diameter: 20 mm
Depth: 5 mm

Perforations: 0,9 mm
in diameter

No. 10370-17

**Mirror Finish
Cutting Spoon**

Non stick cutting spoon.



13 cm
Diameter: 4,5 mm
Depth: 0,15 mm

No. 10360-13

SPOONS

Pin Holder

Light weight



90% of actual size

17 cm
Nickel-plated chuck
Aluminum handle
Jaw opening: 0–1 mm

No. 26018-17

Pin Holder



Moria MC1

12 cm
Nickel-plated
Jaw opening: 0–1 mm

No. 26016-12

Self Holding Pin and Bone Screw Forceps

Designed with a serrated tip and grooved cup for a stable and secure grip, these forceps hold pins and screws allowing precise placement at your target area. They are compatible with all Fine Science Tools insect pins, minuten pins and bone screws.

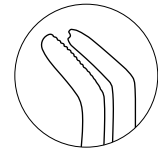

200%



14 cm
Polished stainless steel

No. 26100-00

Insert Pins

All insert pins fit any of our pin holders. Pins are antimagnetic and acid resistant.

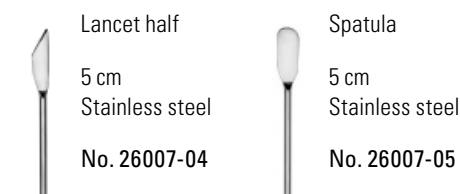
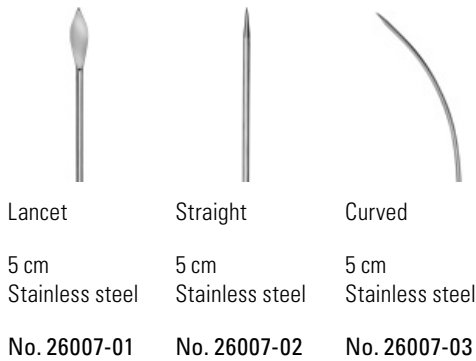

Black Anodized Minutien Pins

These high quality pins are black for best visibility under high magnification and bright light.

Tip diameter: 0,0175 mm
Rod diameter: 0,15 mm
10 mm

Box of 500 pins
No. 26002-15 **MOST POPULAR**

Stainless Steel Minutien Pins

The thinnest and finest pins available.

Tip diameter: 0,0125 mm
Rod diameter: 0,1 mm
10 mm

Box of 500 pins
No. 26002-10 **MOST POPULAR**

Tip diameter: 0,02 mm
Rod diameter: 0,2 mm
10 mm

Box of 500 pins
No. 26002-20 **MOST POPULAR**



Black Anodized Insect Pins

Nylon heads
Tip diameter: 0,03 mm
Pkg. of 100 pins

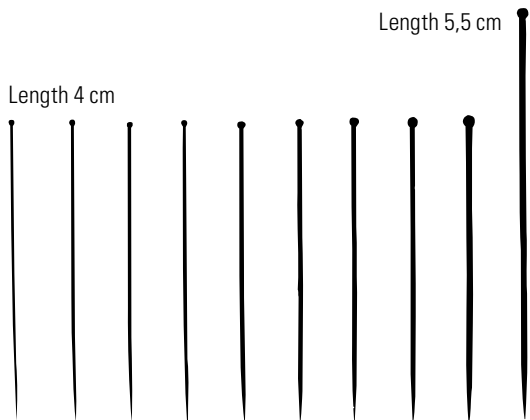

Size	000	00	0	1	2	3	4	5	6	7
Rod diameter (mm)	0,25	0,30	0,35	0,40	0,45	0,50	0,55	0,60	0,65	0,70
No. 26000	-25	-30	-35	-40	-45	-50	-55	-60	-65	-70

Stainless Steel Insect Pins

Nylon heads
Tip diameter: 0,03 mm
Pkg. of 100 pins

Size	000	00	0	1	2	3	4	5	6	7
Rod diameter (mm)	0,25	0,30	0,35	0,40	0,45	0,50	0,55	0,60	0,65	0,70
No. 26001	-25	-30	-35	-40	-45	-50	-55	-60	-65	-70

Etched Tungsten Micro Needles

These tungsten micro needles are drawn to a 1 micron tip and three different rod diameters are offered. Each provides lateral stability as well as minimal spring action during manipulation. The micro needles can be used with our pin holders shown on page 112.

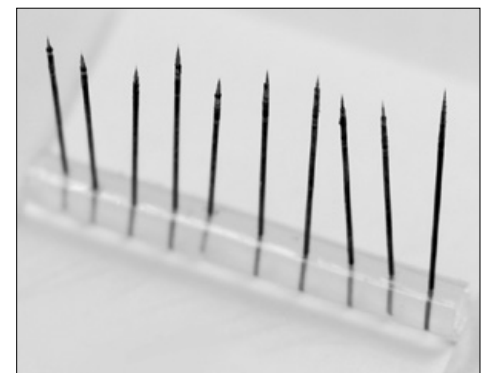

Tip diameter: 1 µm (0,001 mm)
12 mm

Box of 10 needles

Rod diameter (mm)	Item
0,125	No. 10130-05
0,25	No. 10130-10
0,5	No. 10130-20

Castroviejo

Micro pattern, with slightly blunted tips.

Round Handled Needle Holder with Suture Cutter

Round handles allow easy fingertip adjustments.

Round Handled Needle Holder

Round handles allow easy fingertip adjustments.

Cautionary note: Never use a micro needle holder with needles that are too thick, as this can easily damage the fine jaws. Use only micro needles of less than 0,2 mm diameter (see page 120).



Straight

9 cm

With lock
No. 12060-01

Without lock
No. 12060-02



Curved

9 cm

With lock
No. 12061-01

Without lock
No. 12061-02

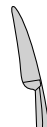

Curved
Cutting edge: 3,5 mm

14 cm

Without lock
No. 12075-14



Straight

12,5 cm

With lock
No. 12075-12

Without lock
No. 12076-12

Mathieu

Extra slim and narrow profile, with squeeze-lock.
Facilitates excellent wrist motion for suturing.

**TUNGSTEN
CARBIDE**

For more information
see page 203.



14 cm

With lock
No. 12010-14



With tungsten
carbide jaws
14 cm

With lock
No. 12510-14

Castroviejo with Tungsten Carbide Jaws

**TUNGSTEN
CARBIDE**

For more information
see page 203.



With tungsten carbide jaws
14 cm

With lock
No. 12565-14

Halsey

MOST POPULAR

TUNGSTEN CARBIDE

For more information see page 203.



13 cm
Smooth
With lock

No. 12001-13



13 cm
With tungsten carbide jaws
With lock

No. 12501-13

Halsey with Tungsten Carbide Jaws

TUNGSTEN CARBIDE

For more information see page 203.



12,5 cm
With tungsten carbide jaws
With lock

No. 12500-12

Olsen-Hegar with Suture Cutter

MOST POPULAR

LEFT HANDED 

12102-12



12 cm
10 mm cutting edge
With lock

No. 12002-12

No. 12102-12

14 cm
15 mm cutting edge
With lock

No. 12002-14

Olsen-Hegar with Suture Cutter and Tungsten Carbide Jaws

TUNGSTEN CARBIDE

LEFT HANDED 

12512-12

For more information see page 203.



12 cm
With tungsten carbide jaws
10 mm cutting edge
With lock

No. 12502-12

No. 12512-12

14 cm
With tungsten carbide jaws
15 mm cutting edge
With lock

No. 12502-14

NEEDLE HOLDERS

Crile-Wood

**TUNGSTEN
CARBIDE**

For more information
see page 203.

**LEFT
HANDED** 

12504-15



15 cm
With lock

No. 12003-15

15 cm
With tungsten
carbide jaws
With lock

No. 12503-15

No. 12504-15

Mayo-Hegar



16 cm
With lock

No. 12004-16



18 cm
With lock

No. 12004-18

NEEDLE HOLDERS

**Slim Elongated Needle Holder
with Tungsten Carbide Jaws**

**TUNGSTEN
CARBIDE**

For more information
see page 203.



15 cm
With tungsten
carbide jaws
With lock

No. 12005-15

Ryder Mini-Select Needle Holder

This needle holder has been uniquely fashioned with tungsten carbide dust tips, giving the clamping platform an extra secure grip.

**TUNGSTEN
CARBIDE**

For more information
see page 203.



15 cm
With tungsten
carbide dust tips
With lock

No. 12505-15

NEEDLE HOLDERS

Microsurgical Needles with Suture Thread Attached

The combination of proprietary needle design technology and state-of-the-art manufacturing techniques has enabled S&T to provide a microsurgical needle that is unmatched in the industry. S&T microsurgical needles provide frictionless tissue penetration. They are inspected under the microscope at critical stages during the manufacturing process, and a multi-point final inspection of each suture and needle combination ensures a high quality product. The suture-to-needle attachment is tested to higher standards than the USP specifications.

Features:

- Needle and thread combination comprising of non-absorbable black nylon polyamide monofilament thread and stainless steel 3/8 circle needle. Nylon is suitable for closing ophthalmic, neurological and microvascular wounds.
- 3/8 circle precision taper point. Stainless steel needle honed under microscope by hand. Superfine round tip with flattened body to improve stability in needle holder. Easy penetration. Precise stitch placement.
- Grinding geometry and suture needle attachment are directed toward frictionless tissue penetration.
- Each needle suture combination is individually packed and sealed in a peel-open blister pack.



400% of actual size

No. 12051-11



No. 12051-10



No. 12051-08



Sterile

Pkg. of 12 disposable units

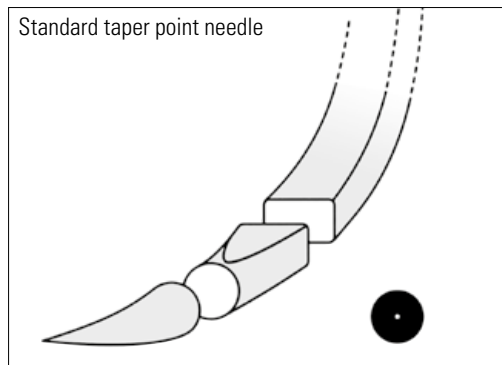

Suture size	Suture length (cm)	Needle diameter (micron)	Needle diameter (mm)	Needle chord length (mm)	Circle	Arch (mm)	Item
11/0	10	50	0,05	3	3/8	3,8	No. 12051-11
10/0	10	70	0,07	3	3/8	3,8	No. 12051-10
8/0	15	140	0,14	5	3/8	6,4	No. 12051-08



Suture size	Suture length (cm)	Needle diameter (micron)	Needle diameter (mm)	Needle chord length (mm)	Circle	Arch (mm)	Item
11/0	10	50	0,05	3,8	3/8	3,8	12052-11
10/0	10	70	0,07	3,8	3/8	3,8	12052-10
9/0	15	100	0,1	5	3/8	5,1	12052-09
8/0	15	140	0,14	5	3/8	6,4	12052-08

Suture Needles

Polished stainless steel
 3/8 curved
 Round with standard eye
 Diameter 0,35 mm
 Suitable for sutures up to 0,32 mm diameter

Non-sterile

Pkg. of 12 needles

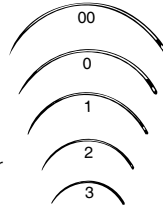

Size	Item
00	No. 12050-20
0	No. 12050-10
1	No. 12050-01
2	No. 12050-02
3	No. 12050-03

Silk Suture

Silk suture has a smooth flow through tissue while maintaining knot security.

Braided silk

Non-sterile

Can be ETO sterilized



Size	Diameter (mm)	Spool length (m)	Item
7/0	0,05	91	No. 18020-70
6/0	0,08	23	No. 18020-60
5/0	0,12	23	No. 18020-50
4/0	0,17	23	No. 18020-40
3/0	0,22	23	No. 18020-30
2/0	0,32	23	No. 18020-20
0	0,37	23	No. 18020-00
1	0,45	23	No. 18020-01
2	0,55	23	No. 18020-02
3	0,65	23	No. 18020-03

For Suture Tying Forceps, see pages 80, 81 and 82.

Nylon Monofilament Suture

Nylon is known for its uniform diameter flexibility and outstanding consistent knot security.

Nylon monofilament

Non-sterile

Can be ETO sterilized



Size	Diameter (mm)	Spool length (m)	Item
8/0	0,04	91	No. 18030-80
7/0	0,05	91	No. 18030-70
6/0	0,07	91	No. 18030-60
5/0	0,10	91	No. 18030-50
4/0	0,15	91	No. 18030-40
3/0	0,20	91	No. 18030-30

Suturing Principles and Techniques in Laboratory Animals

Introduces the basic principles, materials and surgical instruments required for suturing and wound closure used on animals. The manual provides descriptions and pictures portraying proper tissue handling and aseptic technique, correct hand placement and use of surgical instruments, proper needle placement on needle holders, and provides an in-depth explanation of various suture patterns and associated principles for proper knot tying during wound closure.

The DVD provides descriptive narrative and step-by-step video demonstrations for each of the suturing techniques.

Manual and DVD

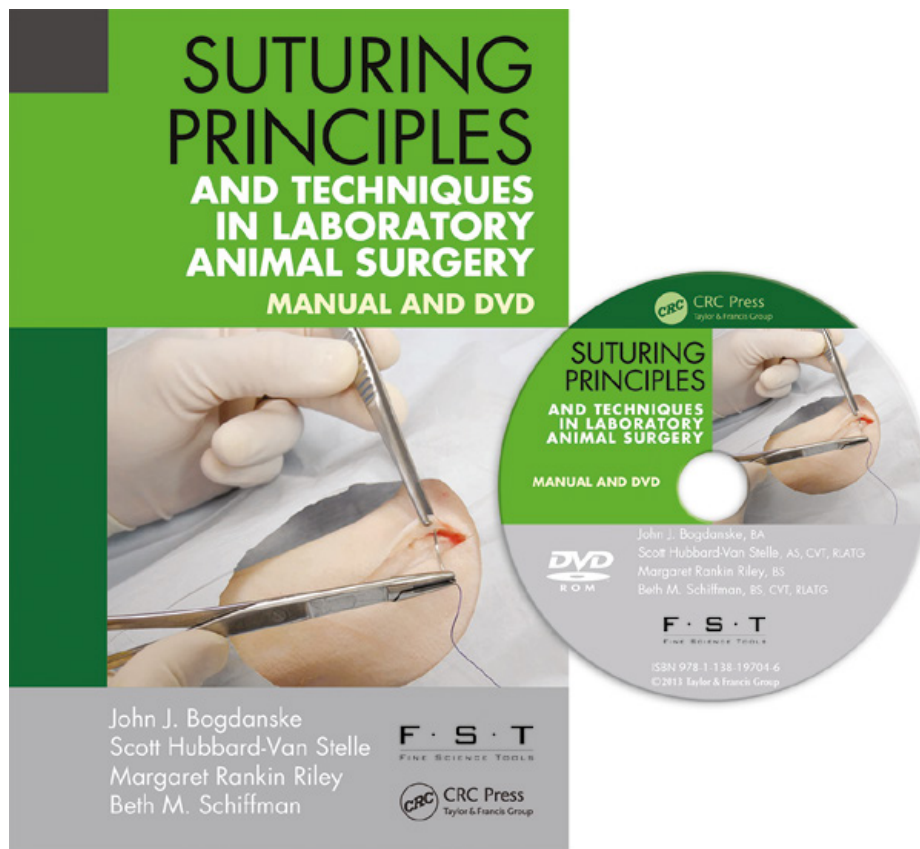

Includes: Fine Science Tools Item Number Reference Page for all surgical instruments used in the manual.

No. 23005-10

Michel Suture Clips

Anti-magnetic, acid-resistant stainless steel
Pkg. of 1.000 clips

Size (mm)	Item
7,5 x 1,75	No. 12040-01
11 x 2	No. 12040-02
12 x 2,5	No. 12040-03

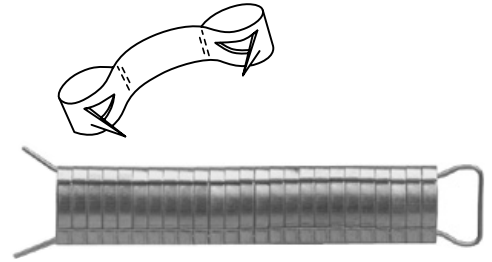

Applying Forceps



12,5 cm
For clip sizes 12040-02 and 12040-03

No. 12018-12

Applying and Removing Instruments



Curved

13 cm
For clip sizes 12040-02 and larger

No. 12028-12



Angled

13 cm
For clip size 12040-01

No. 12029-12

Reloadable Skin Stapler with Rotating Head

The 360° degree swivel nose and unique design offers maximum visibility at the delivery point. The stainless steel staples are non-sterile and feature a patented staple design which make for quick and easy removal. The disposable staple cartridge includes a printed staple counter. **The handle is reusable and autoclavable. Staples are non-sterile. Components sold separately or as a kit.**

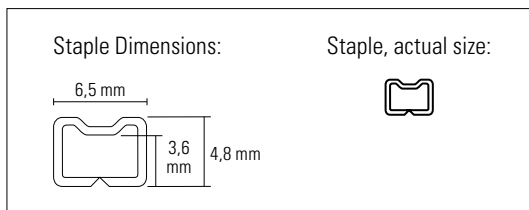
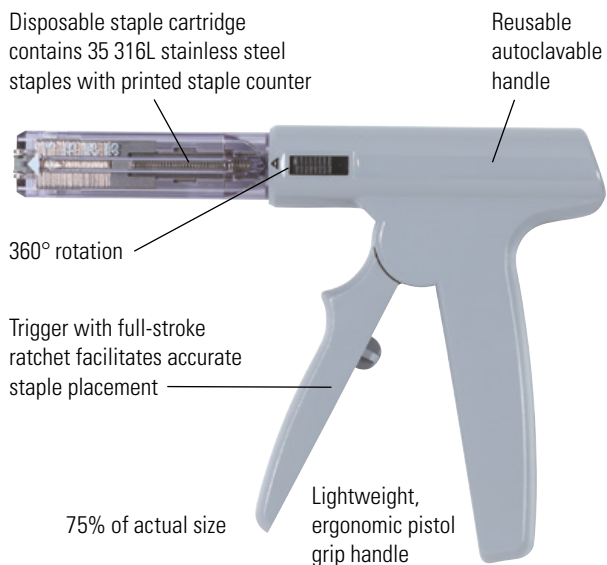

Surgical staple kit

- 1 Handle
- 1 Remover
- 12 Disposable staple cartridges

No. 12030-20

Single disposable cartridge
35 staples per cartridge
No. 12030-22

12 disposable cartridges
35 staples per cartridge
No. 12030-23

Handle
No. 12030-01

Surgical Staple Remover

Compatible with Reloadable Skin Stapler with Rotating Head and Manipler® Skin Stapler.



10 cm
No. 12030-04

CLIPS

Manipler® Skin Stapler

Quality, slim, lightweight design with consistent actuation and staple count indicator. **Disposable, sterile, and not autoclavable.**

15 cm
35 staples per cartridge
No. 12035-00

NOT
AUTOCLAVABLE

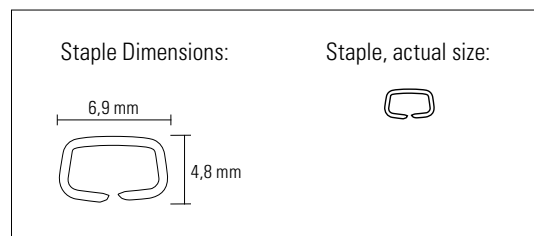

AutoClip® System

The AutoClip® System is a safe, secure method of wound closure. Faster and easier than suture, this system is perfect when staples may be too thin to provide adequate closure. **Non-sterile. Components sold separately or as a kit.** We recommend using wet steam sterilization at 120 – 125°C for at least 30 minutes in an autoclave to sterilize the device.

MOST POPULAR

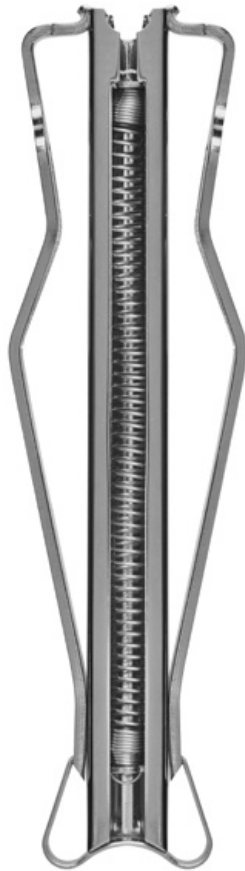

Applier



Clips



Remover

CLIPS

- AutoClip® Kit
- 1 Applier
 - 9 mm clips (100)
 - 1 Remover
 - Storage case

No. 12020-00

AutoClip® applier
11,5 cm

No. 12020-09

AutoClip® clips
9 mm
Pkg. of 100 clips

No. 12022-09

AutoClip® clips
9 mm
Pkg. of 1000 clips

No. 12022-19

AutoClip® remover
12,5 cm

No. 12023-00

RETRACTORS

Guthrie

Extra delicate pattern.



2,5 mm



13 cm
2 Pronged
Blunt

No. 17021-13

Fine Retractor



6 mm



13,5 cm
2 Pronged
Blunt

No. 17023-13

Blair



6 mm



13,5 cm
4 Pronged
Blunt

No. 17022-13

Fomon



80% of
actual size

13 mm



17 cm
2 Pronged
2 mm Ball at each tip

No. 17020-17

Slide Retractor with Blades



2 cm
Maximum spread: 1 cm
Atraumatic blades

No. 17004-03

Mini-Goldstein

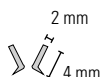

2 cm
Maximum spread: 0,5 cm
3x3 Sharp teeth

No. 17002-02

Mini-Colibri



2 cm
Maximum spread: 1 cm

No. 17000-01

Slide Retractor with Teeth



2 cm
Maximum spread: 1 cm
2x2 Blunt teeth

No. 17005-03

Goldstein

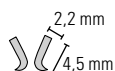
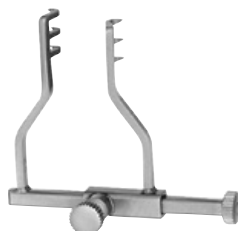

3 cm
Maximum spread: 1,8 cm
3x3 Sharp teeth

No. 17003-03

Colibri

MOST POPULAR

17000-03



3 cm
Maximum spread: 1,5 cm

No. 17000-03

4 cm
Maximum spread: 1,5 cm

No. 17000-04



3 cm
Maximum spread: 1,2 cm

No. 17000-02

Fine Adjustable Wire Retractor



5 cm
Maximum spread: 3,5 cm
Thin, curved blades

No. 17004-05

Agricola

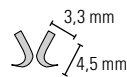

4 cm
Maximum spread: 3,5 cm
3x3 Sharp teeth

No. 17005-04

Speculum

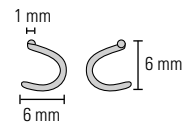

Moria 7699

4,5 cm
Maximum spread: 3,5 cm
Thin, curved blades and grooved finger grips

No. 17370-53

Alm Retractor with Wire Teeth

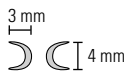

7 cm
Maximum spread: 4 cm
Arms gently curved down

No. 17010-07

Alm Retractor with Blunt Teeth



7 cm
Maximum spread: 4 cm
Arms gently curved down

Blunt teeth
No. 17008-07

7 cm
Maximum spread: 4 cm
Arms gently curved down

Long blunt teeth
No. 17009-07

Alm Retractor with Blades

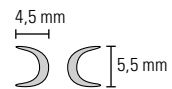

7.5 cm
Maximum spread: 4.5 cm
Arms gently curved down
Thin, curved blades

No. 17009-08

Spring-Loaded Retractor

Curved atraumatic blades

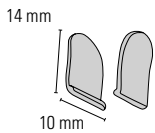

5,5 cm
Maximum spread: 3 cm
Blade dimensions: 14 x 10 mm

No. 17006-05

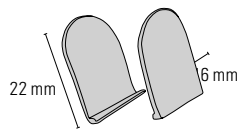

8 cm
Maximum spread: 4 cm
Blade dimensions: 22 x 16 mm

No. 17007-08

Bowman

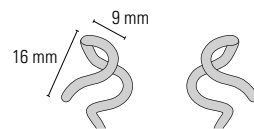

8 cm
Maximum spread: 2,5 cm

No. 17001-07

Heiss

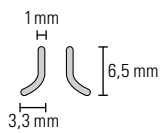

Maximum spread: 2,3 cm
4x4 Blunt teeth
10 cm

No. 17011-10

Gelpi

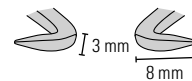

Maximum spread: 3 cm
Angled down
1x1 Sharp teeth
10 cm

No. 17017-10

Weitlaner-Locktite

Wullstein

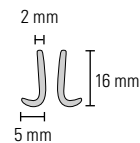
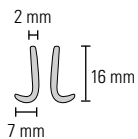

2x3 Blunt teeth

3x4 Blunt teeth

11 cm

Maximum spread: 4,5 cm

No. 17012-11

13 cm

Maximum spread: 6,5 cm

No. 17012-13

Angled down
3x3 Blunt teeth

11 cm

Maximum spread: 4,5 cm

No. 17018-11

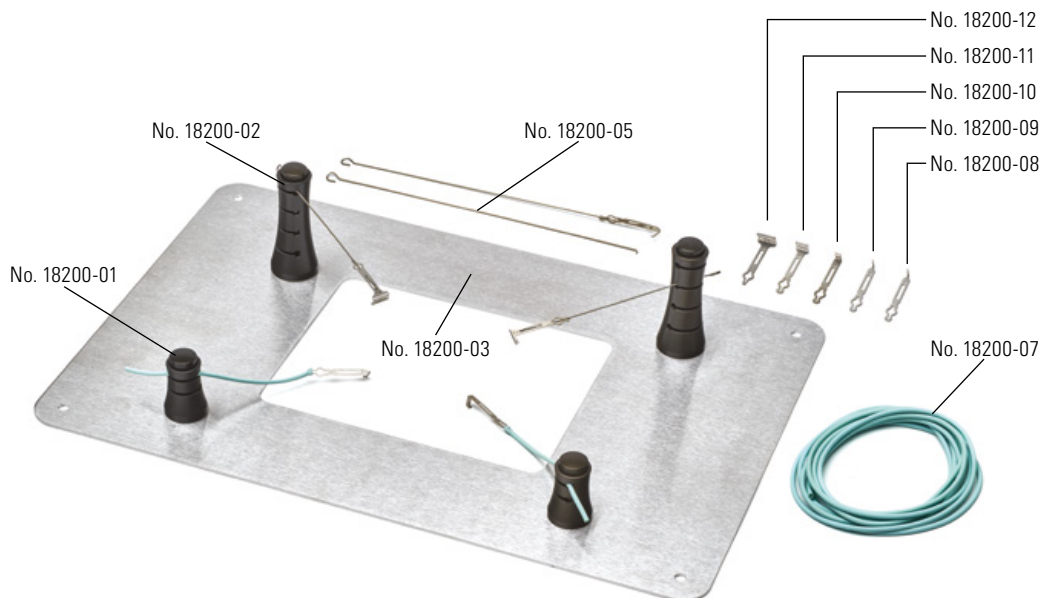

Magnetic Fixator Retraction System

This Small Animal Retraction System simplifies set-up procedure and provides the examiner with an excellent overview of the operative site. It consists of three components: **Base Plate** (Nos. 18200-03 & 18200-04); **Fixators** (Nos. 18200-01 & 18200-02); and **Retractors** (Nos. 18200-05 through 18200-12).

The **Base Plates** are made from magnetic stainless steel and are available in two sizes. The surface is nonreflective and both plates have a window in the center which allows the animal contact with body temperature control systems. The window sizes are 10 x 13 cm for the small base plate and 15 x 25 cm for the large.

The **Fixators** are movable anchors made from anodized aluminum with a surgical grade rare earth magnet in the base for attachment anywhere on the Base Plate. The magnets do not interfere with lab electronics and can be used in close proximity (3 cm) to ferro-magnetic items. They incorporate pushbutton-activated spring locks that grip either the Wire or Elastomer Retractors.

The **Retractors** are interchangeable Retractor Tips (Nos. 18200-08 through 18200-12) which attach to either Retractor Wire (Nos. 18200-05 & 18200-06) for static retraction or to Elastomer (No. 18200-07) for dynamic retraction. The Retractor Tips are light and atraumatic to delicate tissue or membrane.

All system components are autoclavable.

Kit for animals up to 200 g

Includes:

- 1 Small base plate (No. 18200-03)
- 2 Short fixators (No. 18200-01)
- 1 Tall fixator (No. 18200-02)
- 1 Elastomer, 2 m roll (No. 18200-07)
- 1 Package of retractors, blunt, 1 mm wide (No. 18200-09)
- 1 Package of retractors, blunt, 2,5 mm wide (No. 18200-10)

No substitutions

No. 18200-20

Kit for animals from 200 g up to 5 kg

Includes:

- 1 Large base plate (No. 18200-04)
- 2 Short fixators (No. 18200-01)
- 2 Tall fixators (No. 18200-02)
- 1 Elastomer, 2 m roll (No. 18200-07)
- 1 Package of retractors, blunt, 2,5 mm wide (No. 18200-10)
- 1 Package of retractors, blunt, 5 mm wide (No. 18200-11)

No substitutions

No. 18200-50

Individual parts:

Short fixator, 2,5 cm high
Each

No. 18200-01

Tall fixator, 5 cm high
Each

No. 18200-02

Small base plate, (20 x 30 cm)
Each

No. 18200-03

Large base plate, (25 x 35 cm)
Each

No. 18200-04

Wire handles, 10 cm long
Pkg. of 10

No. 18200-05

Wire handles, 14 cm long
Pkg. of 10

No. 18200-06

Elastomer, 2 m roll

No. 18200-07

Sharp retractors
Pkg. of 10

No. 18200-08

Blunt retractors, 1 mm wide
Pkg. of 10

No. 18200-09

Blunt retractors, 2,5 mm wide
Pkg. of 10

No. 18200-10

Blunt retractors, 5 mm wide
Pkg. of 10

No. 18200-11









Blunt retractors, 7,5 mm wide
Pkg. of 10

No. 18200-12

Clamp Size and Clamp Pressure

Clamp pressure is determined by the closing force of the clamp (in grams), divided by the area of the vessel wall that is compressed between the jaws (in square millimeters). Thus, the smaller the vessel, the higher the pressure exerted.

Despite the wide range of closing forces, the pressure exerted by each clamp, big or small, remains consistent throughout the series. Each size of clamp exerts a pressure of 5g/mm² when used on the largest vessel in its range, and 15g/mm² when used on the smallest vessel. Even at the higher range, S&T's micro clamps have the gentlest working pressure of any small vessel clamp available.

Clamp (ea)	L x W (mm)	Vessel Diameter Range (mm)
00396-01 & 18040-11	3,5 x 1,0	0,4 - 1,0  
00398-02 & 18040-22	5,5 x 1,5	0,6 - 1,5  
00400-03 & 18040-33	7,5 x 1,75	1,0 - 2,25  
00325-00	10 x 2,15	2,0 - 5,0  

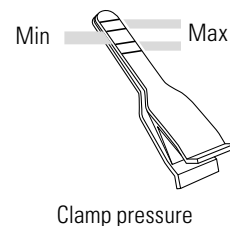
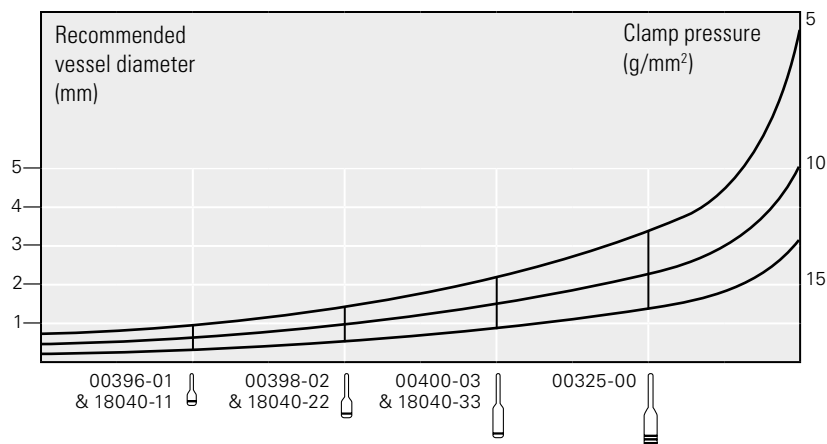

CLAMPS

Micro Clamps

S&T®



S&T B-1
No. 00396-01



S&T B-2
No. 00398-02



S&T B-3
No. 00400-03



S&T HD-S
No. 00325-00

Double Micro Clamps

For vascular approximation at anastomosis. These clamps are mounted on a 10 mm sliding bar and can easily be moved by applying gentle force. The distance between the jaws of the clamps is adjustable from 3 to 16 mm.



No. 18040-11



No. 18040-22



No. 18040-33

Micro Clamp Applying Forceps

S&T®



14 cm
Only compatible with
S&T Micro Clamps

With lock
No. 00071-14

Without lock
No. 00072-14

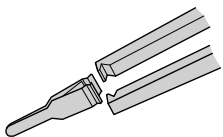

Micro Clamp Applying Forceps



14,5 cm
Compatible with S&T
Micro Clamps and
Double Micro Clamps

Without lock
No. 18040-14

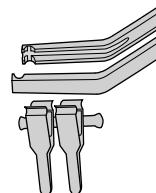
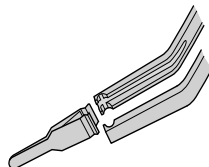

CLAMPS

Micro Clip Applicator with Lock

MOST POPULAR

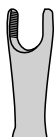

14 cm
For use with our 18055 and 18555 series micro serrefines

With lock
No. 18056-14

Forceps Style Clip Applicator

This applicator features special U-shaped side supports for improved seating of the clips.



14 cm
For use with our 18055 and 18555 series micro serrefines

Without lock
No. 18057-14

Stainless Steel Micro Serrefines

Used to obtain a clear surgical field for extended arterial cross-clamping.

MOST POPULAR

Delicate atraumatic serrations
Spring width: 2 mm



	No. 18055-01	-02	-03	-04
Jaw length (mm)	10	8	6	4
Jaw width (mm)	2	2	1	0,75
Total length (mm)	19	16	15	13
Jaw pressure (g)	60	85	100	125



	No. 18055-05	-06
Jaw length (mm)	6	4
Jaw width (mm)	1	0,75
Total length (mm)	17	16
Jaw pressure (g)	100	125

Titanium Micro Serrefines

TITANIUM

Lightweight with strong clamping pressure.

For more information see page 203.

Delicate atraumatic serrations
Spring width: 2 mm



	No. 18555-01	-02	-03	-04
Jaw length (mm)	10	8	6	4
Jaw width (mm)	2	2	1	0,75
Total length (mm)	19	16	15	13
Jaw pressure (g)	60	85	100	125

Cautionary note: Micro Serrefines should never be compressed with fingers; use only the appropriate applicator No. 18056-14 or No. 18057-14.

CLAMPS



Moria Vessel Clamp

Straight

33 mm
 Finely serrated (atraumatic)
 Light pressure
 For vessels up to 2 mm in diameter
 Calibrated to 15g/mm²
 1,8 mm wide, 3 cm long



Moria 201/A

No. 18320-11

Moria Bulldog Type Clamps

53 mm
 Non-serrated
 Strong pressure
 2 mm wide



Straight

Moria MC43

No. 18374-43



Curved

Moria MC44

No. 18374-44

Dietrich Bulldog Clamps

Serrated
 Good access to deep seated vessels
 Closing pressure: 50 g (light)
 Weight: 3 g



Straight
 52,5 mm

No. 18038-45



Angled
 50 mm

No. 18039-45

Bulldog Type Serrefines

Serrated

Straight
 28 mm
 Medium pressure



No. 18050-28

Curved
 28 mm
 Medium pressure



No. 18051-28



Straight
 35 mm
 Strong pressure

No. 18050-35

Straight
 50 mm
 Strong pressure

No. 18050-50



Curved
 35 mm
 Strong pressure

No. 18051-35



Curved
 50 mm
 Strong pressure

No. 18051-50

Schwartz Micro Serrefines

Non-serrated
 Strong pressure
 26 mm



Straight



No. 18052-01

Light bend



No. 18052-02

Sharp bend



No. 18052-03

Mini Serrefines

28 mm
 Smallest bulldog-type hemostatic clamps
 Medium pressure
 Gentle serrations
 2 mm wide

Straight



No. 18054-28

Curved



No. 18053-28

Bulldog Artery Spring Clamp

Can be used with a minimum of distortion
 for MRI investigations.



For more information
 see page 203.

Straight



30 mm
 Serrated
 Light pressure

No. 18144-30

CLAMPS

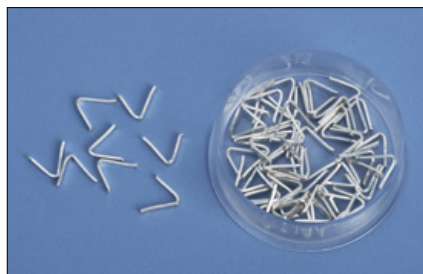

Silver Neuro Clips

These single-use, silver neuro clips are meant for permanent vessel occlusion.

Pkg. of 100 clips
No. 18040-00

Vascular Occluders

Applications

- Fast, dependable zero-flow baseline determination in blood flow studies.
- Partial to full occlusion of vessels for circulation research studies.
- Prolonged implantations, such as chronic blood flow studies.
- Constriction of soft organs in acute or chronic applications.

Operation

- Step 1** Apply the occluder cuff around the exposed blood vessel. Secure it in place with suture material through the eyelets.
- Step 2** Occlude the vessel to the desired degree by inflating the diaphragm with air or liquid injected into the actuating tube using a syringe and blunt needle. Clamp the tubing to maintain occlusion of the vessel over time.
- Step 3** To deflate, simply withdraw the air or liquid.

Benefits

- Occlusion is accomplished without traction on vessels or surrounding tissues.
- The actuating tube may be exteriorized from the occlusion site for remote actuation.
- Performance during implantations is reliable and consistent.
- Autoclavable or cold sterilized, and easily maintained.
- Made from soft, flexible 100% silicone rubber.
- Fully operational with instant response using air, liquids, or inert gases.

Selection

The lumen diameter when deflated is usually the determining factor in the selection of the proper device. Select the occluder size that provides a slightly loose fit around the subject vessel. The cuff width and thickness will vary, depending on models and sizes.



The actuating tube length is 90 cm and measures 0,76 mm ID x 1,6 mm OD. Detailed instructions are included.

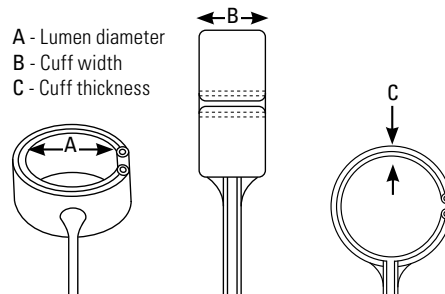

VO-1.5 N

Lumen diameter: 1,5 mm
Cuff width: <3,5 mm
Cuff thickness: 1,5 mm

No. 18080-01

VO-2

Lumen diameter: 2 mm
Cuff width: 5 mm
Cuff thickness: 1,5 mm

No. 18080-02

VO-3

Lumen diameter: 3 mm
Cuff width: 5 mm
Cuff thickness: 1,5 mm

No. 18080-03

V-Hook

Aids in feeding fine suture around blood vessels, works very similar to ligation aids.



300%



11 cm
Tip diameter: 0,4 x 0,2 mm

No. 18052-12

Ligation Aids

A handy instrument for leading a fine suture under and around a blood vessel for tying-off purposes. Also useful for ligating peripheral nerves. Grooves toward hole help threading.



300%

Ultrafine



10,5 cm
Hole diameter: 0,4 mm

No. 18062-12



18063-13

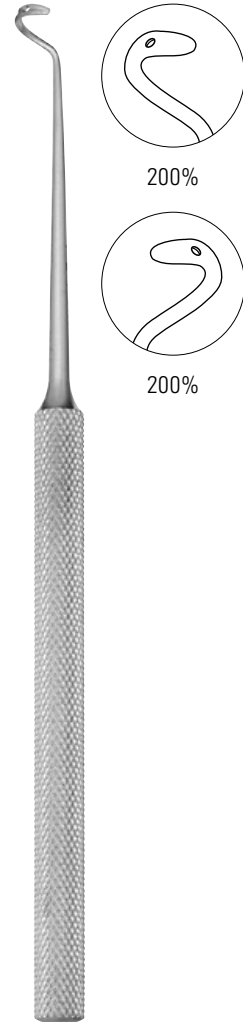

200%

200%



13,5 cm
Hole diameter: 1 mm

No. 18062-13



13,5 cm
Hole diameter: 1 mm

No. 18063-13

LIGATION

Vessel Dilators

Highly modified forceps with elongated, parallel tips which are highly polished. Designed for controlled intraluminal vessel dilation.

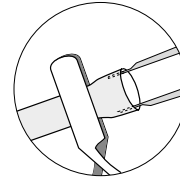

S&T®

S&T®

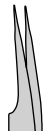

Angled 10°

11 cm
Tip diameter: 0,1 mm

No. 00126-11

Tip diameter: 0,2 mm

No. 00125-11

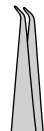

Angled 45°

13,5 cm
Tip diameter: 0,2 mm

No. 00276-13

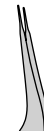

Angled 10°

12 cm
Tip diameter: 0,1 mm

No. 18131-12

Tip diameter: 0,2 mm

No. 18132-12

Balanced Instruments

Balanced instruments are designed to put the center of gravity between the thumb and index finger. This is accomplished by adding a slight counter weight to the proximal end of the instruments. The design enhances tactile feel, aiding in better control and precision.

Vessel Dilators

The tips of these multipurpose forceps are configured to enable their use as dilators at the front, as well as needle holders and tying forceps further in the back. The platform at the tips close parallel ensuring a reliable grip.

Vessel Dilator



80% of actual size



Straight

14,5 cm
Suture tying platform
Tip diameter: 0,1 mm

No. 18601-15



80% of actual size



Straight

15 cm
Suture tying platform
Tip diameter: 0,3 mm

No. 18602-15



80% of actual size



Angled

14,5 cm
Smooth
Tip diameter: 0,2 mm

No. 18603-14

Micro Cannulation System

This micro cannula is most helpful for quick and easy insertion in arteries and veins. It can be used as an “indwelling” catheter during long term experiments. With care, thorough rinsing and sterilization, it can be reused several times. Detailed instructions are included.



Features

- Biocompatible Teflon® tubing.
- Cannula size 0,33 mm OD – 0,16 mm ID
- A pointed stainless steel stylus (trocar), to aid in vascular penetration and allow a maximum range of cannula manipulation during insertion.
- Contoured tip for easy insertion, fitted with shoulder for “tie-in” to prevent accidental removal.
- Female luer connection for linkage to infusion lines.



CANNULATION

1 Approach
Cannulation Forceps (Item No. 18403-11) and Spinal Cord Hook (Item No. 10162-12) aid in the insertion process.

2 Insertion
Remove trocar and advance cannula.

3 Secure
Use shoulder hub and suture to “tie in” cannula to prevent accidental removal.

Instruments sold separately.

8 cm

Cannula size 0,33 mm OD - 0,16 mm ID

No. 18000-10

Vessel Cannulation Forceps

These vessel cannulation forceps are useful whenever a fine plastic tube has to be introduced into a small blood vessel of almost equal size. The hollowed jaws hold the tubing securely without deforming it. The tip of the tubing is directed exactly into the vessel opening without damage to the vessel from unwanted movement.

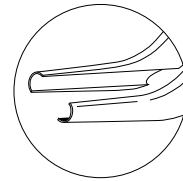

11 cm
For tubing between
0,5 and 1 mm OD

No. 00574-11



11 cm
For tubing of 0,35 mm OD

No. 11280-11

11 cm
For tubing of 0,5 mm OD

No. 11281-11

11 cm
For tubing of 1 mm OD

No. 11282-11



11,5 cm
For tubing of 0,35 mm OD

No. 18403-11

11,5 cm
For tubing of 0,6 mm OD

No. 18406-11

13,5 cm
For tubing of 0,6 mm OD

No. 18406-13

CANNULATION



Accessories & Instrument Care

Animal Accessories	Pages	145 – 148
Instrument Care & Sterilization	Pages	149 – 161
Surgical & Laboratory Accessories	Pages	162 – 177



Reusable Gavage Feeding Needles

Stainless steel feeding needles with luer lock hub. Also ideal for transcardiac perfusions with a fixative.



Gauge	Length (mm)	Tip diameter (mm)	Shape	Mice	Rats	Guinea pigs	Item
24	25	1,25	Straight	>14 g			No. 18061-24
22	25	1,25	Straight	15-20 g			No. 18061-22
20	30	Barrel	Straight	20-25 g	50-75 g		No. 18060-20
20	38	2,25	Straight	20-25 g	50-75 g		No. 18064-20
20	38	2,25	Curved	20-25 g	50-75 g		No. 18065-20
18	38	2,25	Straight	20-30 g	100-200 g	250-300 g	No. 18061-38
18	50	2,25	Curved	25-30 g	100-200 g	250-300 g	No. 18061-50
16	75	3,00	Curved		150-300 g	350-450 g	No. 18061-75
16	100	3,00	Curved		150-300 g	350-450 g	No. 18061-10

Single Use Gavage Feeding Needles

These economical feeding needles feature plastic luer hubs with silicone tips. They are nontoxic and nonpyrogenic. Needles can be easily formed to any desired shape. **Sterile.**



Pkg. of 5 needles

Gauge	Length (mm)	Tip diameter (mm)	Shape	Mice	Rats	Guinea pigs	Item
20	38	1,75	Flexible	20-25 g	50-75 g		No. 18061-20
18	50	2,50	Flexible	25-30 g	100-200 g		No. 18061-18
15	75	3,00	Flexible		200-350 g	400-600 g	No. 18061-15

FEEDING

Disposable Flexible PTFE Feeding Needles

These affordable needles feature flexible PTFE tube with silicon tip and plastic luer hub, delivered in sterile pouches. They are very flexible, and translucent for easy confirmation of reagent delivery. The soft silicone tips are non-toxic and non-pyrogenic and ensure that no damage occurs during the insertion. **Sterile.**



Malleable to any angle

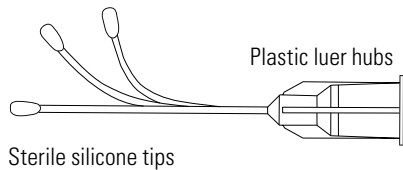

Pkg. of 5 needles

Gauge	Length (mm)	Tip diameter (mm)	Shape	Mice	Rats	Guinea pigs	Item
20	38	Barrel 1,8	Flexible	20-25 g	50-75 g		No. 18961-20
18	38	Barrel 2	Flexible	20-30 g	100-200 g	250-300 g	No. 18961-18
17	52	Barrel 2,4	Flexible	25-30 g	100-200 g	250-300 g	No. 18961-17
15	78	Barrel 2,6	Flexible		200-350 g	400-600 g	No. 18961-15
18	75	Barrel 2	Flexible	25-30 g	150-250 g	250-300 g	No. 18961-75
17	85	Barrel 2,4	Flexible	25-30 g	150-250 g	250-300 g	No. 18961-85

GenoPunch

The interchangeable GenoPunch aids in the fast and simple collection of the 2 mm tissue sample for DNA analysis and/or genotyping. FST Exclusive Item. **Autoclavable.**

Autoclavable.

MOST POPULAR



70% of actual size



GenoPunch includes:

- 1 GenoPunch
- 1 0,5 ml tube holder
- 1 1,6 ml tube holder
- 1 Screwdriver
- 4 Screws



FST does not supply microtubes.

11,5 cm
Stainless steel and anodized aluminum
Punch diameter: 2 mm

No. 24215-02

Ear Punch

Designed to ensure a fast and clean punch, this ear punch is lightweight and fits comfortably in the palm of your hand. FST Exclusive Item. **Autoclavable.**



70% of actual size

11,5 cm
Stainless steel and anodized aluminum
Punch diameter: 2 mm

No. 24214-02

Finger Loop Ear Punch

This ear punch provides stability and control for researchers using the numbering system. The 1 mm ear punch offers greater numbering variations and/or patterns.



70% of actual size

10,5 cm
Punch diameter: 1 mm

No. 24212-01

Punch diameter: 2 mm

No. 24212-02

Surgical Skin Marker

This marker features a versatile tip for precise fine (0,2 mm) line marking, or when held at an angle, a broad (2 mm) line marking.

The marker's violet ink is nontoxic, non-tattooing and surgical prep-resistant. Markings can be removed from the skin with isopropyl alcohol. A six-inch ruler calibrated in both centimeters and inches is included.



50% of actual size

14 cm

No. 18000-30

IDENTIFICATION

Self Piercing Ear Tags

Ideal for use in small animals such as mice and rats, these ear tags come numbered from 1-100 or 1-500. Silver colored tags with black numbers provide high visibility making them easy to read. Once applied, tags seal and cannot be removed, providing an easy to use, permanent identification method. These ear tags are safe for use in salt water.



Ear tags
Alloy: Monel
7,8 x 2,8 mm

Black numbers 1-100

No. 24220-10

Black numbers 1-500

No. 24220-50

Black numbers 501-1000

No. 24220-90



Ear Tags (enlarged view)

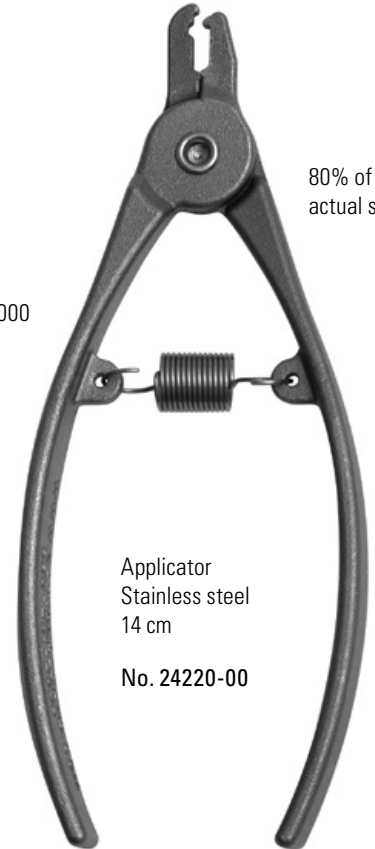

80% of actual size

Applicator
Stainless steel
14 cm

No. 24220-00

IDENTIFICATION

Animal Microtattoo System

A quick, efficient and affordable method of permanently identifying laboratory animals (mice as early as 1 day old). Designed and tested by laboratory animal technicians, the system utilizes a hypodermic needle at one end of a stainless steel forceps and a small metal cup containing green tattoo paste at the other side of the forceps.

By squeezing the forceps together, the needle penetrates the toe, footpad or ear of the animal and injects a deposit of green tattoo paste into the animal. A grid location pattern provided enables a numbering system that extends over 1 million.

Use of the microtattoo system is humane and in compliance with regulatory agencies for the care and use of laboratory animals. Detailed instructions are included. **Both the microtattoo forceps and green tattoo paste are autoclavable.**

Animal microtattoo system includes:

- 1 Pair plated steel microtattoo forceps
- 1 Tube (1 oz.) of green tattoo paste
- 1 Aluminum planchette
- 2 Hypodermic needles
- 1 Plastic holding case



13 cm
Animal microtattoo system

No. 24201-00



Green tattoo paste
1 oz / 29,6 ml

No. 24201-01

Silicone Seal and Lubricant



This stiff non-melting silicone base maintains its consistency from -40°C to 200°C (40°F to 392°F) with less than 2% evaporation after 24 hours of exposure to 150°C (302°F). Typical applications include lubrication of stopcock rotating parts and other lab items. Seals vacuum and low pressure systems. Compatible with glass, plastics, metals, synthetic rubber gaskets and seals. **Autoclavable.**

15 ml container

No. 29051-45

Demagnetizer

This safe and easy to operate tabletop demagnetizer has a large coil opening of 8 x 4 cm in a rigid, molded housing. Can be used to demagnetize or magnetize instruments.

12 x 5,5 x 9 cm

No. 18000-15



Instrument Sharpening Stones

Natural Arkansas oil stones feature unequaled fineness, hardness and structural density. When used with mineral oil, they will produce a sharper cutting edge.

6 mm x 9 cm

Square stone

No. 29008-01

Triangular stone

No. 29008-12

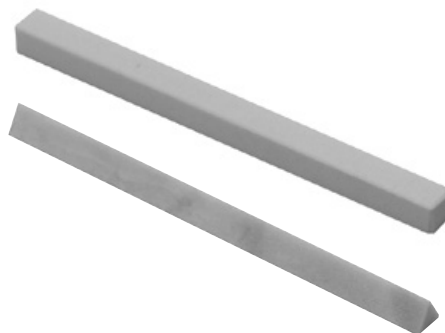

Instrument Oil

Physiologically inert oil for lubricating surgical instruments, box locks, ratchets and any overlapping joints.

50 ml bottle

No. 29055-00



Sharpening Stone for Fine Forceps

This natural Arkansas stone assists in reshaping the tips of fine forceps. The stone has two grooves, 0,8 mm and 1,6 mm, and comes in a cedar box with ten O-rings.



European version differs from photo.

4 x 1 x 10 cm

No. 29008-22

Fine Forceps Repair Kit

Realign and repair fine forceps with this convenient kit. Bent forceps tips can be restraightened with the chain nose pliers. The sharpening stone has two grooves, 1,6 mm and 0,8 mm, to assist in reshaping the forceps tips. O-rings clamp the forceps shut to ensure that both shanks are equally aligned and sharpened. Instrument oil assists in producing a smooth sharp edge. Detailed instructions are included.

**MOST
POPULAR**



Kit includes:

- 1 Sharpening stone for fine forceps with ten O-rings (No. 29008-22)
- 1 Instrument oil, 50 ml bottle (No. 29055-00)
- 1 Chain nose pliers

No. 29000-00

INSTRUMENT CARE

Optical Cleaning Kit and Lens Paper

This convenient kit contains everything you need to clean lens surfaces safely. Perfect for microscopes, camera lenses, binoculars, telescopes, graphic art optics, and all other fragile lenses. Storage case included.

Kit includes:

- 1 Bottle of lens cleaner (30 ml)
- 1 Ultra soft duster brush
- 1 Cleaning cloth (20 x 20 cm)
- 3 Books of lens paper (25 sheets each)

Lens Paper

15 x 10 cm

Kit

Book of 50 sheets

No. 29000-10

No. 29015-50



Instrument Marking Tape

Organize instruments quickly and easily with this economical, non-toxic, pressure sensitive tape. Color is unaffected by boiling, cold sterilization or autoclaving. 8 colors available. **Autoclavable.**



290 x 0,6 cm
Green
Material: Vinyl

No. 29071-01



290 x 0,6 cm
Blue
Material: Vinyl

No. 29071-02



290 x 0,6 cm
Yellow
Material: Vinyl

No. 29071-03



290 x 0,6 cm
Red
Material: Vinyl

No. 29071-04



290 x 0,6 cm
White
Material: Vinyl

No. 29071-05



290 x 0,6 cm
Black
Material: Vinyl

No. 29071-06



290 x 0,6 cm
Brown
Material: Vinyl

No. 29071-07



290 x 0,6 cm
Orange
Material: Vinyl

No. 29071-08

**Instrument Marking Tape
8 Assorted Colors**

Organize instruments quickly and easily with this economical, non-toxic, pressure sensitive tape. Color is unaffected by boiling, cold sterilization or autoclaving. Includes 8 assorted color rolls: Yellow, Red, Black, White, Green, Brown, Blue and Orange. **Autoclavable.**



107 x 0,6 cm (each roll)
Material: Vinyl

No. 29080-00

Instrument Tip Protectors

These tip protectors are a convenient, color-coded way to protect surgical instrument tips and edges. They provide exceptional protection and are vented to prevent rusting from condensation. Instrument tip protectors are recommended during handling, storage, and sterilization. **Autoclavable.**

MOST POPULAR
29060-00



1,6 x 19,1 mm
Pkg. of 25
Material: Plastisol

No. 29060-01



2 x 19 mm
Pkg. of 25
Material: Plastisol

No. 29060-02



2,8 x 19,1 mm
Pkg. of 25
Material: Plastisol

No. 29060-03



3,2 x 25,4 mm
Pkg. of 25
Material: Plastisol

No. 29060-04



4,8 x 25,4 mm
Pkg. of 25
Material: Plastisol

No. 29060-05



2 x 9,5 x 25,4 mm
Pkg. of 25
Material: Plastisol

No. 29060-06



Assorted pack, five of each size
Pkg. of 30
Material: Plastisol

No. 29060-00

INSTRUMENT CARE

Double Tip Protectors

These vented tip protectors are designed to hold hemostats and rongeurs firmly while allowing the jaws, box hinge and tips to stay open for thorough sterilization. **Autoclavable.**



12,7 x 20 mm
Pkg. of 10
Material: Plastisol

No. 29066-01



9 x 25,5 mm
Pkg. of 10
Material: Plastisol

No. 29066-02



15 x 25 mm
Pkg. of 10
Material: Plastisol

No. 29066-03



25 x 26 mm
Pkg. of 10
Material: Plastisol

No. 29066-04



Assorted pack, three of each size
Pkg. of 12
Material: Plastisol

No. 29066-00

Self Sealing Sterilization Pouches

Preformed pouches with self adhering tape are blue tinted on one side for visualization of contents, and paper-backed on the other side. Pouches will work with either steam autoclave or ethylene oxide sterilization.

Material properties:

- Protects instruments during sterilization.
- Provides sterile storage until use.
- Write on pouches for easier identification during sterilization.



STERILIZATION

10 x 18 cm
For instruments up to 13 cm long

Pkg. of 100 pouches

No. 28000-07

13 x 26 cm
For instruments up to 23 cm long

Pkg. of 100 pouches

No. 28000-10

18 x 30 cm
For instruments up to 26 cm long

Pkg. of 100 pouches

No. 28000-12

Hot Bead Sterilizer

The sterilizer provides a safe, effective and convenient method for sterilizing your surgical instruments prior to and during surgery or tissue culture. Without using potentially dangerous gases, flames or chemicals, you can ensure that your instruments will be free of pathogens and microbial contaminants.

The beads take 15–20 minutes to reach 240°C to 270°C (464°F to 518°F), and then the sterilizer is ready for use. The temperature is thermostatically maintained, and the unit can be left on all day. Instruments require approximately 20 seconds of contact with the beads for complete sterilization. The sterilizer is safe to use even in laminar flow hoods.

Sterilization test results conducted by the Pasteur Institute in Lille, France, are available upon request. Available in 110V and 220V. CE Certified and UL Approved.

Sterilizer includes:

- Sterilizer unit
- 2 Bags of glass beads
- 1 Dust cover for well
- 1 Small heat-tempered glass dish for small objects (only with FST 250)



FST 250 shown.
Instruments not included.

FST 250 Sterilizer

Well diameter: 4 cm
Well depth: 8 cm
Well volume: 100 ml
Total unit size: 14,5 x 12,5 x 13,5 cm

No. 18000-45

Replacement glass beads for FST 250
No. 18000-46

FST 350 Sterilizer

Well diameter: 4 cm
Well depth: 14 cm
Well volume: 175 ml
Total unit size: 20,5 x 12,5 x 13,5 cm

No. 18000-50

Replacement glass beads for FST 350
No. 18000-51

Autoclave Tape Dispenser

Easy loading core with heavy duty steel construction and a non-skid base. Serrated cutting blade cuts tape fast and cleanly.



Tape sold separately.

23,5 cm
Coated steel
No. 28001-00

Autoclave Tape

Tape will permanently indicate diagonal stripes after exposure to steam autoclave temperature between 121°C and 130° C during a 40-60 minute time period. Use with sterilization pouches, sterilization wraps and sterilization cases.

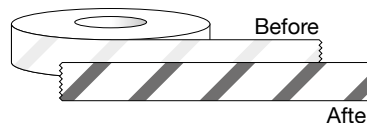

2 cm x 55 m
No. 28001-02

Disposable Sterilization Wraps

These biodegradable cellulose fiber wraps are resistant to tears and conform easily to maintain a breathable yet impervious barrier to airborne bacteria, saline, blood and water. Wrapping your instrument case securely will ensure the sterility of your instruments until ready for use. Available in two sizes.



Cases not included.

38 x 38 cm
Pkg. of 25 wraps
No. 28015-15

51 x 51 cm
Pkg. of 25 wraps
No. 28020-20

STERILIZATION

Silicone Mat

High quality, extra soft mat for safe and secure placement of delicate instruments. This mat can easily be cut along the premarked grooves to fit in various sized instrument cases. **Autoclavable.**

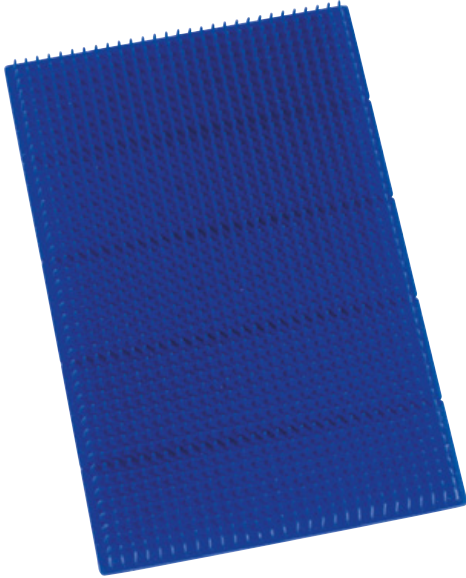

30 x 20 cm

No. 20325-00

Magnetic Sterilization Mat

Used during sterilization and for safe anti-slip placement around surgical settings. **Autoclavable.**



Instruments not included.

30 x 20 cm

No. 20350-00

MATS

Silicone Mat

Large, economical silicone mat. **Autoclavable.**

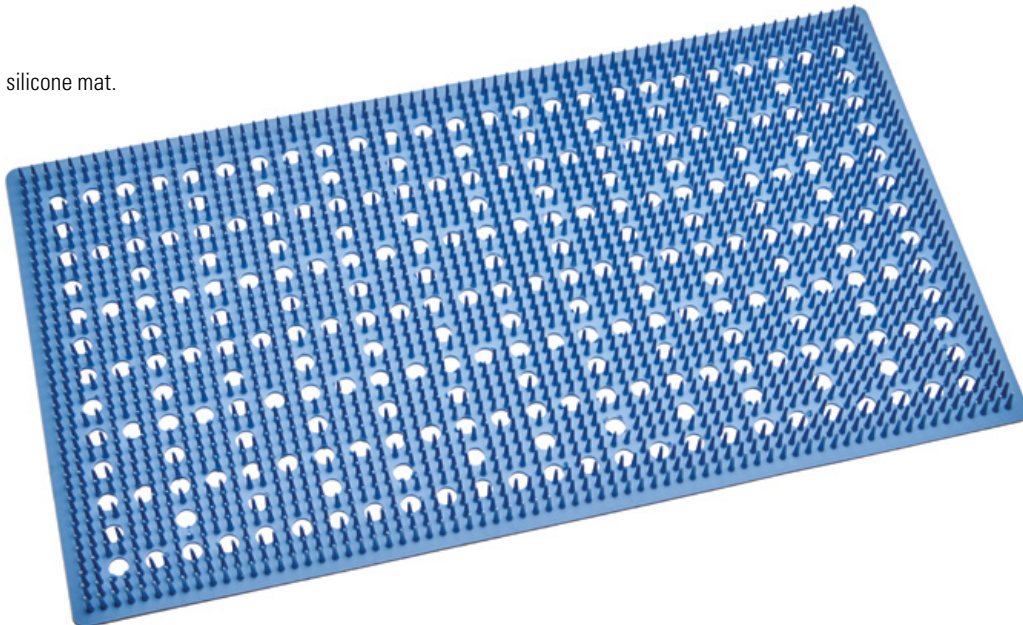

46 x 25 cm

No. 20325-10

Sterilization Container

This plastic sterilization container includes a silicone mat for safe placement of instruments. Perforated top is clear for visual identification of instruments. **Suitable for autoclave or ethylene oxide sterilization.**



19 x 10 x 2 cm
No. 20810-01

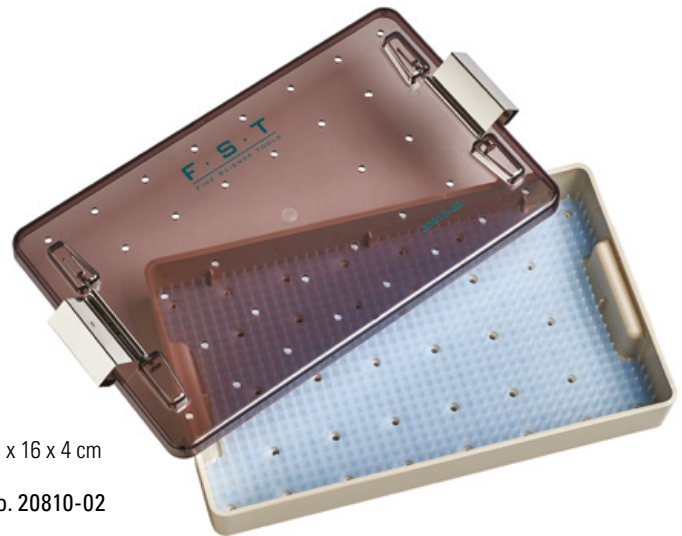

27 x 16 x 4 cm
No. 20810-02

Two Tiered Sterilization Container

This plastic sterilization container has two tiers of silicone slots that will accommodate up to 12 different instruments. Hinged top and bottom lock tight. Container is perforated. **Suitable for autoclave or ethylene oxide sterilization.**



25 x 12 x 3 cm
No. 20820-00

Sterilization Container

This sterilization container is made from Ultem® polymer to ensure strength and long lasting durability. The transparent perforated lid provides easy identification of your surgical instruments. Silicone mat is included for a safe and secure hold. Trays are also stackable for convenience. **Suitable for autoclave or ethylene oxide sterilization.**

**MOST
POPULAR**
20840-03

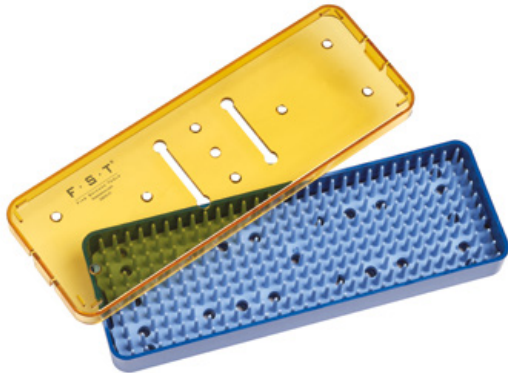

19 x 7 x 2 cm
Single tier

No. 20840-01

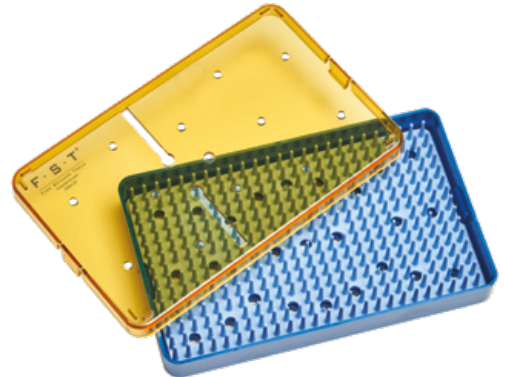

17 x 10 x 2 cm
Single tier

No. 20840-02

CASES

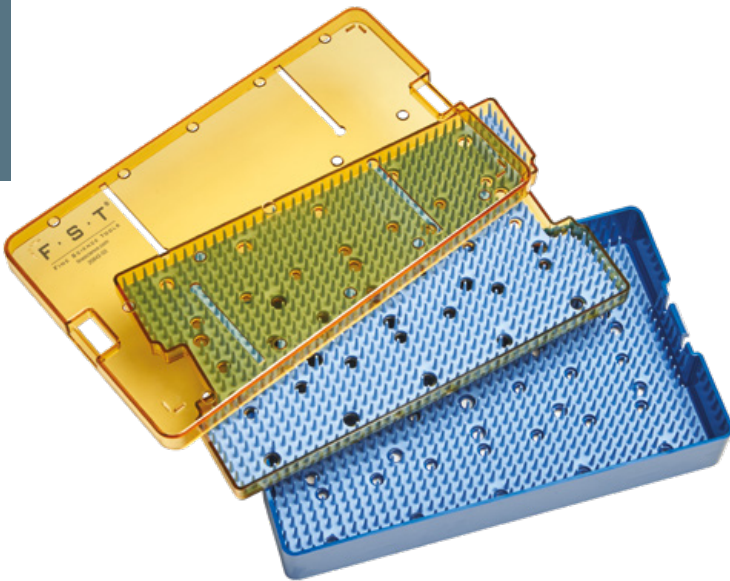

25 x 15 x 4 cm
Double tier

No. 20842-03

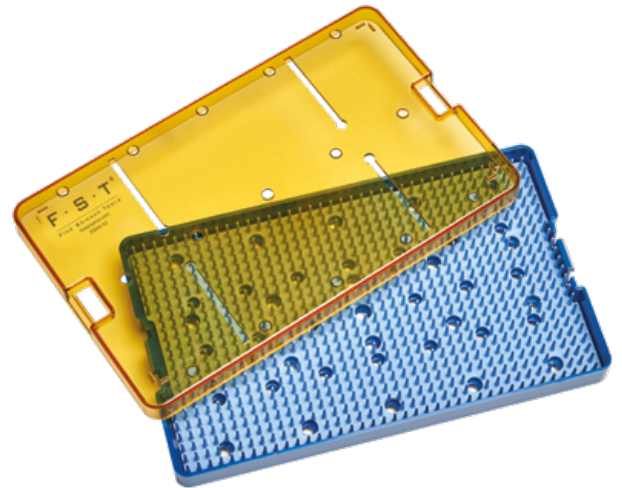

25 x 15 x 2 cm
Single tier

No. 20840-03

Dual Clamping Stainless Steel Sterilization Container

This container will assist in the sterilization and storage of your fine surgical instruments. It comes with a custom fit silicon mat and one single-use filter for keeping the instruments sterile while they remain in the container. **Suitable for autoclave or ethylene oxide sterilization.**



30 x 14 x 4 cm

No. 20850-00

5 Long-term textile filters
No. 20850-10

One Long-term textile filter
No. 20850-11

Stainless Steel Sterilization Container

Removable perforated interior plates hold long-term textile filters which keep the instruments sterile while they remain in the container. Lid can be locked in place. Comes with two textile filters installed. **Suitable for autoclave or ethylene oxide sterilization.**



20 x 10 x 4 cm

No. 20890-51

10 Long-term textile filters
No. 20890-72

One Long-term textile filter
No. 20890-71



Utility Instrument Case

Comes with a silicone mat for safe placement of instruments. **Case and silicone insert are autoclavable but should not be used for sterilizing surgical instruments.**



18 x 9 x 3 cm

No. 20311-21

CASES

Roll Up Travel Case

Vinyl dissection roll up case with Velcro strap to hold the case closed. Holds up to 10 tools, one ruler holder, and one Velcro sealed pouch. **Instruments not included.**



No. 20831-10

Instrument Case

This plastic case is compact, safe, secure, and slotted for placement of individual surgical instruments, aiding in the prevention of tip damage. Seven colors available. **Case is autoclavable but should not be used for sterilizing surgical instruments.**

MOST POPULAR



Instruments not included.



17 x 8 x 2 cm
Blue

No. 20830-00



17 x 8 x 2 cm
Green

No. 20830-01

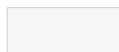

17 x 8 x 2 cm
Clear

No. 20830-02



17 x 8 x 2 cm
Yellow

No. 20830-03



17 x 8 x 2 cm
Pink

No. 20830-04



17 x 8 x 2 cm
Orange

No. 20830-05



17 x 8 x 2 cm
Purple

No. 20830-06

Instrument Beaker with Silicone Bottom

Instruments are placed in the beaker with their tips immersed in distilled water when not in immediate use. This keeps the instruments clean and functional and ready to grasp. The instrument tips are protected from damage by the soft silicone rubber bottom. Segmented lid keeps instruments organized and secure.



Instrument not included.

Diameter: 10 cm
Height: 8 cm

No. 00081-00

Instrument Holding Spring

For the safe placement of delicate surgical instruments during use. Pin the sharp ends into the drape to secure the mounting spring.

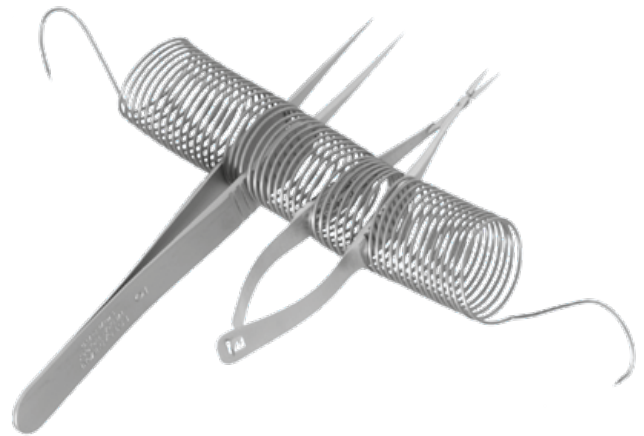

Instruments not included.

Length: 4 cm (closed)
Diameter: 2 cm

No. 18090-00

Stainless Steel Burrs

Length: 44 mm
 Shaft diameter: 2,3 mm
 Pkg. of 10 burrs



Diameter (mm)	Item
0,7*	No. 19008-07
0,9**	No. 19008-09
1,4	No. 19008-14

* Use this size for screws No. 19010-10 (page 50).
 ** Use this size for screws No. 19010-00 (page 50).

Carbon Steel Burrs

Length: 44 mm
 Shaft diameter: 2,3 mm
 Pkg. of 10 burrs



19007-07

Diameter (mm)	Item
0,5	No. 19007-05
0,7*	No. 19007-07
0,9**	No. 19007-09
1,4	No. 19007-14
2,1	No. 19007-21
2,9	No. 19007-29

* Use this size for screws No. 19010-10 (page 50).
 ** Use this size for screws No. 19010-00 (page 50).

Tungsten Carbide Burrs

Length: 44 mm
 Shaft diameter: 2,3 mm
 Pkg. of 5 burrs



For more information
 see page 203.

Diameter (mm)	Item
0,5	No. 19009-05
0,7*	No. 19009-07
0,9**	No. 19009-09

* Use this size for screws No. 19010-10 (page 50).
 ** Use this size for screws No. 19010-00 (page 50).

Stainless Steel Trepines

Side opening for clearing of material.

Length: 44 mm
 Shaft diameter: 2,3 mm
 Sold individually



1,8 - 2,7 mm

5 mm

Outer Diameter (mm)	Item
1,8	No. 18004-18
2,3	No. 18004-23
2,7	No. 18004-27
5	No. 18004-50

Stainless Steel Circular Saw

For cutting bone and other hard substances.
 Attaches to mandrel (No. 18000-18), right.

Diameter: 16 mm
 Thickness: 0,1 mm

Pkg. of 10 saws
 No. 18000-20



Stainless Steel Mandrel

Screw allows attachment of discs
 and circular saws for use with high
 speed drills.

Length: 45 mm
 Shaft diameter: 2,3 mm

No. 18000-18



High Temperature Cautery Kit

This low cost, high temperature cauterizer is a great alternative to disposable cautery units. Temperature at tips is approximately 1000°C (1832°F). Replacement cautery tips are available. **Not autoclavable.**



Plastic body
Stainless steel tips: 0,2 mm diameter
Total weight: 70 g
Length: 16 cm (without tip)

- Cautery kit includes:
- 1 Cautery handle
 - 2 AA Batteries
 - 2 Standard tips
 - 1 Storage case
 - 2 Fine tips

65% of actual size

Low Temperature Cautery Kit

This low temperature cautery kit is a great alternative to disposable cautery units. Temperature at the tips is approximately 649°C. Replacement cautery tips are available. **Not autoclavable.**



Plastic body
Stainless steel tips: 0,2 mm diameter
Operation temperature: 649°C (1200°F)
Total weight: 60 g
Length: 12 cm (without tip)

- Cautery kit includes:
- 1 Cautery Handle
 - 2 AA Batteries
 - 2 Fine Tips
 - 1 Storage Case
 - 2 Elongated Fine Tips

MOST POPULAR

Cautery kit
No. 18010-00

MOST POPULAR



Replacement tips
Straight standard
Sterile
Single use

Box of 10 tips
No. 18010-01

MOST POPULAR



Replacement tips
Straight fine
Sterile
Single use

Box of 10 tips
No. 18010-02



Replacement tips
Straight Fine
Sterile
Single use

Cautery kit
No. 18019-00

Box of 10 tips
No. 18019-01



Replacement tips
Elongated Straight Fine
Sterile
Single use

Box of 10 tips
No. 18019-02

CAUTERIZERS

Small Vessel Cauterizer

This small hand-held unit keeps bleeding to a minimum and therefore provides a surgical field clear of clamps and hemostats. The cauterizer should be activated momentarily so the delicate tips do not burn out. Temperature at tips is approximately 1000°C (1832 °F). Replacement cautery tips are available. **Autoclavable.**



Heavy gauge stainless steel body
 Platinum-iridium tips: 0,3 mm diameter
 Total weight: 100 g
 Length: 13,5 cm (without tip)

Cautery kit includes:

- 1 Cautery handle
- 1 Straight fine tip
- 1 Angled fine tip
- 2 AA Batteries
- 1 Storage Case

Cautionary note:

Remove batteries before autoclaving.

80% of actual size

CAUTERIZERS



Replacement tip
Straight fine

No. 18000-01



Replacement tip
Angled fine

No. 18000-02



Replacement tip
Straight knife

No. 18000-03



Replacement tip
Straight knob

No. 18000-04

Cautery kit

No. 18000-00

Neuro Punches

N.I.H. style neuro punches for punch removal of frozen brain microregions.

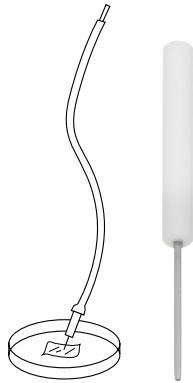

ID (mm)	OD (mm)	Gauge	Length (cm)	Item
0,31	0,61	24	4,2	No. 18036-24
0,41	0,70	22	4,5	No. 18036-22
0,69	1,00	19	4,5	No. 18036-19

Sample Corers

For quantitative analysis. Comes with plunger.

8,5 cm

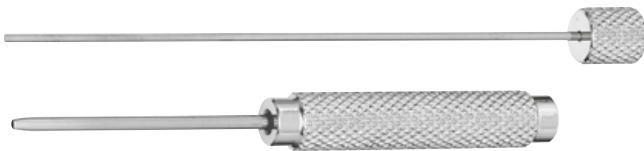

ID (mm)	OD (mm)	Gauge	Item
0,35	0,80	21	No. 18035-35
0,50	1,00	19	No. 18035-50
0,80	1,45	17	No. 18035-80
1,00	1,80	15	No. 18035-01
2,00	3,00	11	No. 18035-02
3,00	4,00	8	No. 18035-03
5,00	6,00	4	No. 18035-05

Absorption Spears and Triangles

These synthetic surgical sponges absorb fluids twice as fast as the best cotton sponges and have three times their fluid-holding capacity. They are made from strong, soft, lint-free biocompatible-proven material that is non-irritating to delicate tissue and leaves no fibrous residue that might cause wound contamination. The Absorption Spears are sterilized by radiation.

MOST POPULAR



Absorption Spears
7 cm
Sterile

Box of 200 spears
No. 18105-01



Absorption Triangles
2 cm
Sterile

Box of 500 triangles
No. 18105-03

Fiber Optic Swabs



Straight

15 cm
Tip diameter: 2,5 mm
Pack of 100

No. 18106-01

Micro Cleaning Brush



70 mm
Nylon

Bag of 25

No. 18196-10

Miniature File Set

Comes with 8 different file profiles in a vinyl pouch.

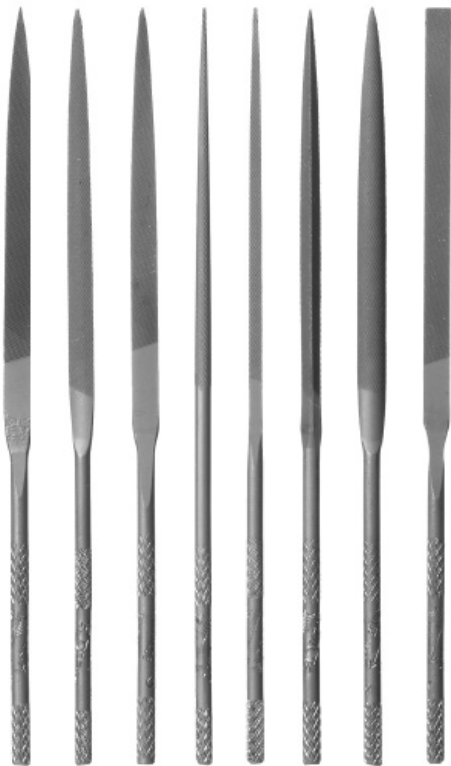

10 cm
Carbon Steel

No. 30076-14

4-in-1 Screwdriver

With 4 hardened, interchangeable blades stored in handle: 1,5, 2, 2,5, and 3 mm.

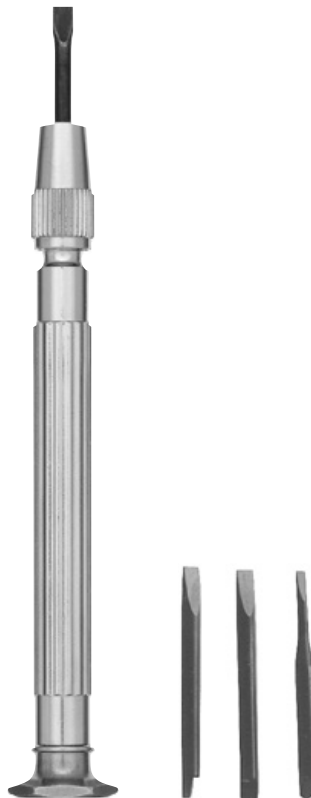

10,5 cm
Nickel handle

No. 30051-10

Ceramic Blade Cutter

Ceramic edge stays sharp 100 times longer than a steel edge. Rust and corrosion free. No trace metal contamination. **Autoclavable.**



Straight

13 cm
Cutting Edge: 58 mm
Ceramic blade
with plastic handle

No. 10025-70

Utility Scissors

These scissors are extremely hard (54 on the Rockwell scale). Useful for cutting tin or aluminum sheets, bone, plastics, etc. The strong, 3 mm thick blades are magnetic. The plastic handles are anatomically shaped.



37000-00

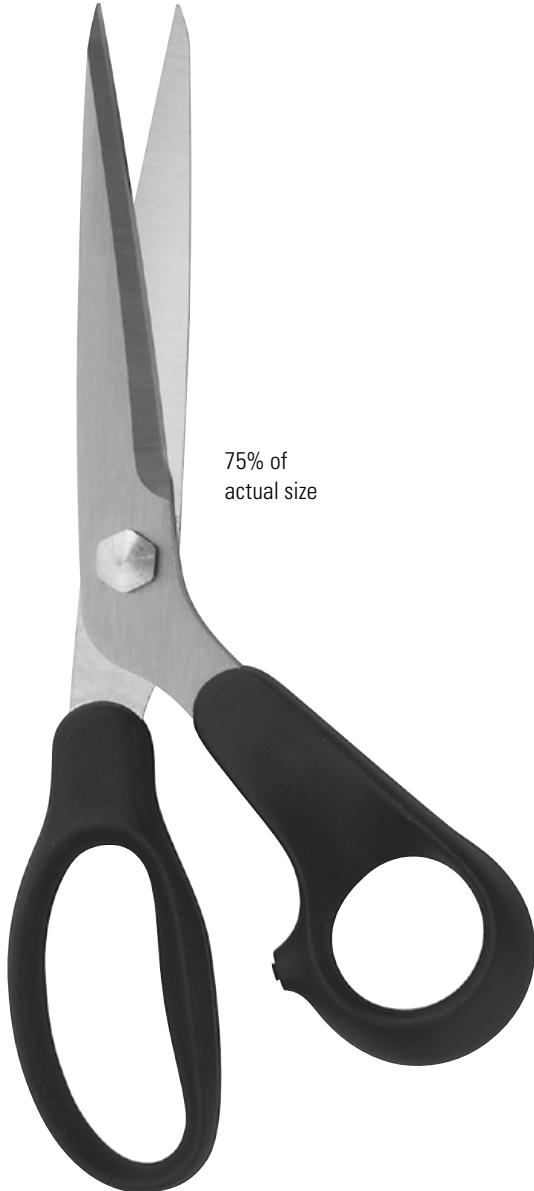

75% of actual size

21 cm
Stainless steel
with plastic handle

No. 37500-00

21 cm
Stainless steel
with plastic handle

No. 37000-00

Universal Scissors

The scissor blades are made of high quality stainless-steel and guarantee a perfect cut. Handles are made of glass fiber reinforced polyamide.



13 cm
Stainless steel
with plastic handle

No. 37500-05

TOOLS

Ruler with Gauge Measurements

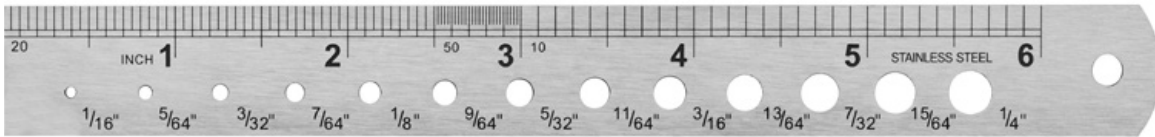

Front

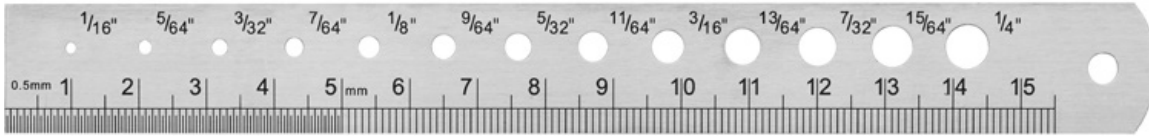

Back

90% of actual size

Stainless steel

15 cm (6")

No. 30085-15

Ruler with Metric Conversion Table



Front

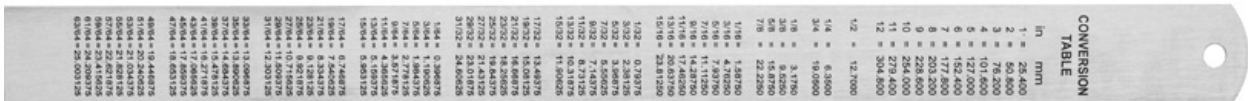

Back

50% of actual size

Stainless steel

30 cm (12")

No. 30085-30

Ruler Label

Used for stable measurements in all surgical platforms.

6 cm

Pkg. of 25 labels
No. 29027-00



Plastic Vernier Caliper

Tough polymer is unbreakable under normal conditions. Measures inside, outside, step and depth, metric and inch to 0,1 mm or 1/64". Maximum measurement: 153 mm.



75% of actual size

Plastic

21 cm

No. 30087-20

Digital Electronic Caliper

Wide screen LED display with the ability to measure in millimeters, inches and fractions. Measures inside, outside, step and depth. Battery, spare battery and plastic storage case included.



70% of actual size

Stainless steel

23,5 cm

No. 30087-00

Castroviejo Surgical Caliper

Used for precise measurement during surgery.



0-20 mm with 0,5 mm divisions
Tip diameter: 0,5 mm

8,5 cm

No. 18000-35

CALIPERS

**Magnifying Loupe with
Micrometer and LED**

High quality loupe features a removable micrometer and ultra-bright LED lights surrounding the circumference for a defined image and clear contrast.

Magnification: 10x
Field of view: 30 mm
Working distance: 10 mm
(without scale)
Illumination: Ultra-bright LED
38 x 38 x 40 mm

No. 29026-10



Stage Micrometers

These are highly accurate stage micrometers for use with transmitted light in both compound and stereo microscopes. Comes with a plastic case.

76 x 26 mm

10 mm with 100 divisions (0,1 mm)
No. 29025-01

1 mm with 100 divisions (0,01 mm)
No. 29025-02

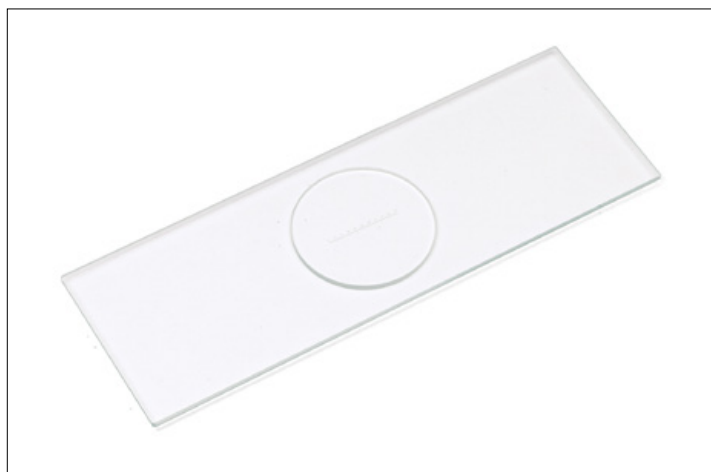

Electronic Clock / Triple Timer

Three activities can be timed up or down simultaneously or individually. Time can be displayed either in 12 or 24 hours and features a memory function. Maximum countdown time is 19 hours, 59 minutes, 59 seconds. Minimum time interval is 1 second. The timer housing includes a powerful magnet for mounting.

LCD display: 4,5 x 4,5 cm
7 x 8,5 x 1,5 cm
AAA battery included

No. 27000-01



Gold Wire Contacts

Matching pin and socket. Contacts are crimp terminated, but also can be used for solder connections.

Total length: 16 mm (when connected together)
Diameter: 1,2 mm
Opening for wire: 0,63 mm

Pkg. of 50 male contacts
No. 19003-00

Pkg. of 50 female contacts
No. 19003-01

Enlarged 225%



Headband Magnifier

Precision ground and polished optical glass lenses. The padded headband is lightweight and fully adjustable. Can be worn with spectacles.



Headband magnifier shown with VisorLIGHT™ (sold separately).

MAGNIFIERS

Magnification: 2,5x
Working distance: 200 mm (8")

No. 28030-02

Magnification: 2,75x
Working distance: 150 mm (6")

No. 28030-03

Magnification: 3,5x
Working distance: 100 mm (4")

No. 28030-04

VisorLIGHT™

Small, portable light source with 26 cm cord for attachment to headband. It comes with a battery pack that holds two AA batteries. Completely adjustable. Replacement bulbs are available upon request.



No. 28030-10

Interchangeable Magnifier Headset with LED

Economical and fully interchangeable headband magnifier with LED light.

Includes:

- Multiple Lens Magnifications (1,0x, 1,5x, 2,0x, 2,5x, 3,5x)
- LED Light Source
- Tilting Functionality
- Cushioned Nose Pads
- Adjustable Headband
- Interchangeable Lens Frames
- Requires 3 AAA Batteries (Batteries not included)

MOST
POPULAR



Can be used with or without the adjustable head strap (included).



Magnification: 1x, 1,5x, 2x, 2,5x, and 3,5x
Field of view: Variable
Working distance: Variable

No. 28080-10

Galilean Loupes

These loupes are lightweight and easy to use. Made from the finest optical coated lenses which deliver excellent clarity and high resolution. The loupes are mounted onto a strong yet flexible wraparound safety frame with a headband for stability and comfort. Ability to flip loupes up for use as safety glasses. Comes with mini screwdriver for fine adjustments, micro cloth, and storage case.



Magnification: 3x
Working distance: 400 mm (16")
Weight: 72 g

No. 28050-30

Magnification: 3,5x
Working distance: 300 mm (12")
Weight: 77 g

No. 28050-35

MAGNIFIERS

Eschenbach Magnifier Spectacles

These magnifier spectacles allow full adjustments on almost all parts. Headband keeps spectacles steady and in place. Leather case and Headband included.



Magnification: 2,5x
Working distance: 350 mm (14")
Weight: 70 g
Plastic frame reinforced with fiberglass

No. 28040-30

Spectacles Headband

Compatible with the Eschenbach Max Detail Spectacles (Item No. 28030-20) and Eschenbach Magnifier Spectacles (Item No. 28040-30).



Material: Neoprene

No. 28080-90

Eschenbach Max Detail Spectacles

These spectacles are portable, lightweight, and easily adjustable. Designed with frosted objective lens housing which eliminates distracting reflections. Bendable ear pieces for a secure, comfortable fit. Protective case is included.



Max Detail Spectacles shown with Eschenbach Clip-On LED Light (sold separately).

Magnification: 2x
 Field of view: 110 mm (4")
 Working distance: 400 mm (16")
 Weight: 49 g

No. 28030-20

Eschenbach Clip-On LED Light

A compact and lightweight light source with two high-performance SMD LED's and a lens that concentrates the light producing a more powerful, bright and homogenous field of view. Light can be set high or low. Compatible with the Max Detail Spectacles and Headband Magnifiers. Comes with 3 AA batteries and storage case.



Gross Weight: 106 g (including batteries)

No. 28030-25

Eschenbach Vario Flex with LED

The Vario LED Flex ensures ease and precision by its smooth flexible neck and tiltable magnifying lens. This magnifier's innovative features provide a spacious working platform suitable for any application. Mounting clamp provides uncompromised workspace due to its sturdy, slim design. The magnification lens is illuminated with shadow-free full or half ring optimum bright LEDs.

- Magnification: 2,5x
- Diopter: 6D
- Lens size: 76 mm
- Lens shape: Aspheric
- Working distance: Variable
- Lens material: PXM® lightweight lens with patented Ceratec® scratch-resistant coating
- Illumination: Latest SMD LED technology
- Power source: 120V & 220V

No. 28015-25



Eschenbach Scribolux Magnifier

This magnifier provides an illuminated platform suitable for any working condition. The open design allows for a spacious working platform. Supplied in a microfiber pouch for protecting and cleaning the lens.

- Magnification: 2,8x
- Diopter: 7/11D
- Lens size: 100 x 75 mm
- Lens shape: Aspheric
- Working distance: 75 mm (3")
- Lens material: PXM® lightweight lens with patented Ceratec® scratch-resistant coating
- Illumination: Latest SMD LED technology
- Power source: 4 AA batteries (included)

No. 28020-28

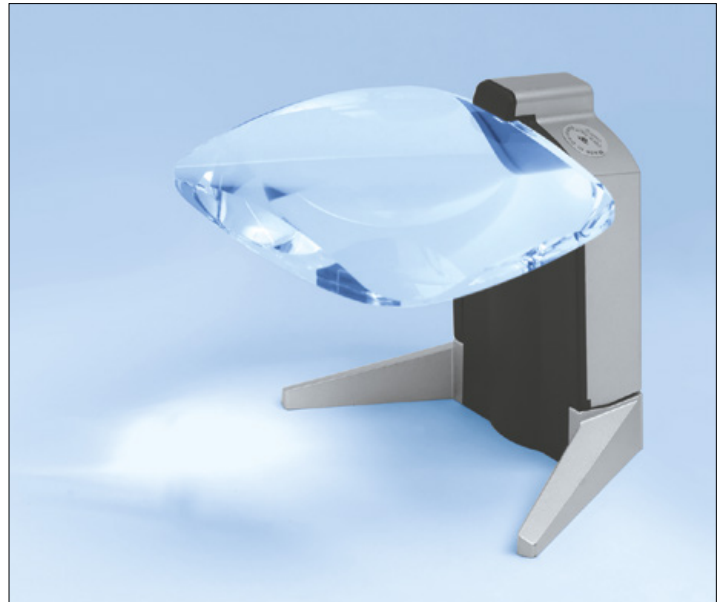

Optical Cleaning Kit

This convenient kit contains everything you need to clean lens surfaces safely. Perfect for microscopes, camera lenses, binoculars, telescopes, graphic art optics, and all other fragile lenses. Storage case included.

Kit includes:

- 1 Bottle of lens cleaner (30 ml)
- 1 Ultra soft duster brush
- 1 Cleaning cloth (20 x 20 cm)
- 3 Books of lens paper (25 sheets each)

No. 29000-10



Lens Paper

This premium grade optical lens tissue is extremely soft and safe for any glass or plastic optical lens surface.

15 x 10 cm

Book of 50 sheets
No. 29015-50



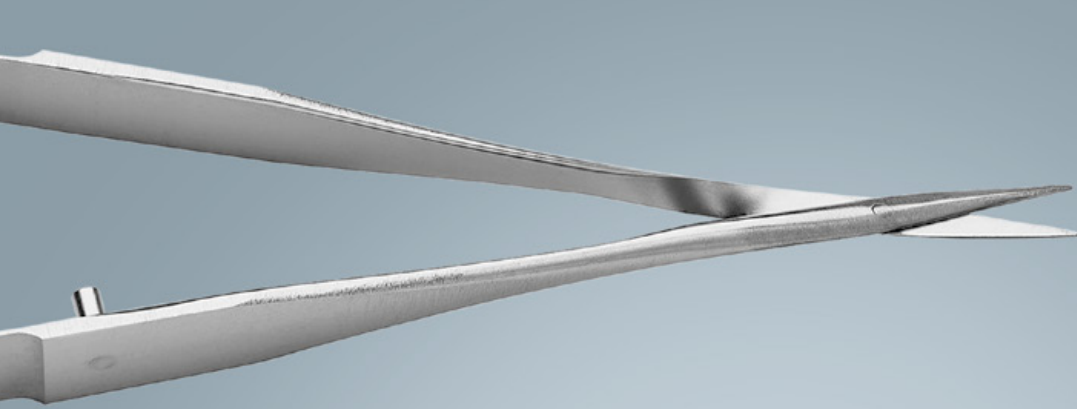

Student Instruments

Scissors	Pages	179 – 184
Cutter	Page	184
Scalpel Handles	Page	185
Forceps	Pages	186 – 191
Hemostat, Needle Holder, Retractor, Vessel Dilator & Clamp	Pages	192 – 199



Vannas Spring Scissors

Ideal for introductory courses in microdissection. The manufacturer, material and general pattern are the same as our No. 15003-08 but with much of the costly hand finishing omitted.

MOST POPULAR
91500-09

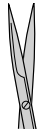

Straight Sharp/Sharp

9 cm
Cutting edge: 5 mm
Tip Ø: 0,35 mm

No. 91500-09



Curved Sharp/Sharp

9 cm
Cutting edge: 5 mm
Tip Ø: 0,35 mm

No. 91501-09

Fine Scissors

MOST POPULAR
91460-11



Straight Sharp/Sharp

11,5 cm
Cutting edge: 20 mm

No. 91460-11



Curved Sharp/Sharp

11,5 cm
Cutting edge: 20 mm

No. 91461-11

Straight Sharp/Sharp

12 cm
Cutting edge: 20 mm

No. 91460-12

Curved Sharp/Sharp

12 cm
Cutting edge: 20 mm

No. 91461-12

Sanvenero



Straight Sharp/Sharp

14,5 cm
Cutting edge: 30 mm

No. 91408-14

%
DISCOUNT

Quantity discount for student instruments:

5-9 = 5%
10+ = 10%

Per item, selection cannot be assorted for discount.

STUDENT

Surgical Scissors



Length (cm)	Cutting edge (mm)	Straight Sharp/Sharp	Straight Sharp/Blunt	Straight Blunt/Blunt
10,5	35	No. 91402-10	No. 91401-10	No. 91400-10
12	40	No. 91402-12	No. 91401-12	No. 91400-12
13	40	No. 91402-13	No. 91401-13	
14,5	45	No. 91402-14	No. 91401-14	No. 91400-14

%

DISCOUNT

Quantity discount for student instruments:

5-9 = 5%
10+ = 10%

Per item, selection cannot be assorted for discount.



Length (cm)	Cutting edge (mm)	Curved Sharp/Sharp	Curved Sharp/Blunt
11,5	40	No. 91405-11	
12	40		No. 91404-12
13	40	No. 91405-13	No. 91404-13
14,5	45	No. 91405-14	No. 91404-14



Wagner



Straight
Sharp / Sharp
11,5 cm
Cutting edge: 25 mm
No. 91405-10

Spencer Ligature



Straight
Sharp / Sharp
9 cm
Cutting edge: 20 mm
No. 91476-09

**%
DISCOUNT**

Quantity discount
for student
instruments:

5-9 = 5 %
10+ = 10 %

*Per item, selection
cannot be assorted
for discount.*

STUDENT

Lister Scissors

Longer blunt blade prevents damaging tissue underneath skin without losing the cutting line.



Mayo

90% of actual size

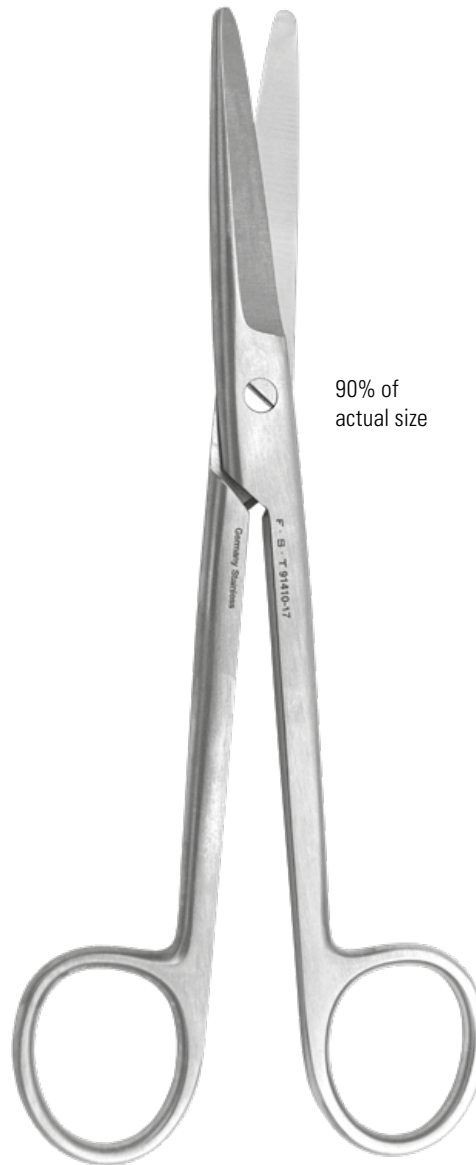

DISCOUNT

Quantity discount for student instruments:

5-9 = 5%
10+ = 10%

Per item, selection cannot be assorted for discount.

STUDENT



Angled to side
Blunt/Blunt

14 cm
Cutting edge: 35 mm

No. 91413-14



Angled to side
Blunt/Blunt

18 cm
Cutting edge: 45 mm

No. 91413-18



Angled to side
Blunt/Blunt

20 cm
Cutting edge: 50 mm

No. 91413-20



Curved
Sharp/Blunt

14,5 cm
Cutting edge: 50 mm

No. 91409-15



Straight
Blunt/Blunt

17 cm
Cutting edge: 50 mm

No. 91410-17



Curved
Blunt/Blunt

17 cm
Cutting edge: 50 mm

No. 91411-17

Metzenbaum Baby



Curved
Blunt/Blunt
14,5 cm
Cutting edge: 30 mm
No. 91419-14

Metzenbaum

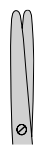

Straight
Blunt/Blunt
14,5 cm
Cutting edge: 35 mm
No. 91416-14



Curved
Blunt/Blunt
18 cm
Cutting edge: 35 mm
No. 91417-18

**%
DISCOUNT**

**Quantity discount
for student
instruments:**

5-9 = 5 %
10+ = 10 %

*Per item, selection
cannot be assorted
for discount.*

STUDENT

Heavy Scissors

**%
DISCOUNT**

**Quantity discount
for student
instruments:**

5-9 = 5%
10+ = 10%

*Per item, selection
cannot be assorted
for discount.*



Curved
Heavy Blades
Sharp/Sharp
10,5 cm
Cutting edge: 30 mm
No. 91405-10

Bone Scissors

For cutting fine bone.

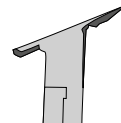

Curved
9 cm
Cutting edge: 9 mm
No. 91604-09

**Bone Cutter**

Angled 30°
11 cm
Cutting edge: 19,5 mm
Blue Plastic Handle
No. 91601-11



Scalpel Handle #4



For scalpel blades, see page 59.

#4
13 cm
No. 91004-13

Standard Scalpel Handle #3



For scalpel blades, see page 60.

#3
12 cm
No. 91003-12

**%
DISCOUNT**

Quantity discount for student instruments:

5-9 = 5%
10+ = 10%

Per item, selection cannot be assorted for discount.

STUDENT

Dumont #5

MOST POPULAR



Standard tip
Straight

11 cm
Inox
0,1 x 0,06 mm

No. 91150-20

Dumont #7

MOST POPULAR



Standard tip
Curved

11 cm
Inox
0,17 x 0,1 mm

No. 91197-00

**%
DISCOUNT**

**Quantity discount
for student
instruments:**

5-9 = 5%
10+ = 10%

*Per item, selection
cannot be assorted
for discount.*

STUDENT

Fine Forceps Straight



F.S.T 91115-10
CE



Straight
11 cm
0,2 x 0,1 mm
No. 91115-10

Fine Forceps Broad Shanks



F.S.T 91113-10
CE



Broad Shanks
12 cm
0,2 x 0,2 mm
No. 91113-10

Fine Forceps Curved



F.S.T 91117-10
CE



Curved
12 cm
0,2 x 0,2 mm
No. 91117-10

Fine Forceps Angled



F.S.T 91110-10
CE



Angled
11 cm
0,2 x 0,2 mm
No. 91110-10

**%
DISCOUNT**

Quantity discount for student instruments:

5-9 = 5%
10+ = 10%

Per item, selection cannot be assorted for discount.

STUDENT

Feilchenfeld



Straight

9,5 cm
Tip Ø: 0,75 mm

No. 91139-09



Straight

11,5 cm
Tip Ø: 1 mm

No. 91139-12

Splinter Forceps



Straight
Sharp

10,5 cm
Tip Ø: 0,3 mm

No. 91156-11

**%
DISCOUNT**

**Quantity discount
for student
instruments:**

5-9 = 5%
10+ = 10%

*Per item, selection
cannot be assorted
for discount.*

Micro Adson



91118-12



80% of actual size



Serrated
12 cm
Tip width: 0,7 mm
No. 91118-12

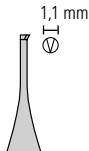

1x2 teeth
12 cm
Tip width: 1,1 mm
No. 91119-12

Adson

Wide, strong grip with narrow tips.



91106-12



80% of actual size



Serrated
12 cm
Tip width: 1,5 mm
No. 91106-12

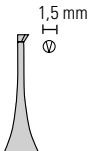

1x2 teeth
12 cm
Tip width: 1,5 mm
No. 91127-12

Adson-Brown

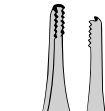

Shark teeth
12 cm
Tip width: 2,5 mm
No. 91162-12

Adson with Cross Serrations

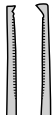

1x2 teeth
Cross-serrations
12 cm
Tip width: 1,3 mm
No. 91427-12



Quantity discount for student instruments:

5-9 = 5%
10+ = 10%

Per item, selection cannot be assorted for discount.

STUDENT

Standard Pattern

Broad pattern with strong spring action.

MOST POPULAR

91100-12

Anatomical Standard Pattern



Straight
Serrated

Tip width (mm)	Length (cm)	Item
2,5	11,5	No. 91100-12
2,7	13	No. 91100-13
3	14,5	No. 91100-14
3,5	16	No. 91100-16
4	17	No. 91100-17

Surgical Standard Pattern

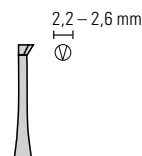

Straight
1x2 teeth

Tip width (mm)	Length (cm)	Item
2,2	12	No. 91121-12
2,4	13	No. 91121-13
2,6	14,5	No. 91121-14
2,8	15,5	No. 91121-15
3	16	No. 91121-16
3,5	18	No. 91121-18
4	20	No. 91121-20
4,5	25	No. 91121-25



DISCOUNT

Quantity discount for student instruments:

5-9 = 5%
10+ = 10%

Per item, selection cannot be assorted for discount.

Anatomical Narrow Pattern



Straight
Serrated

Tip width (mm)	Length (cm)	Item
1,5	11,5	No. 91102-12
2,1	13	No. 91102-13
2,2	14,5	No. 91102-14
2,3	16	No. 91102-16

Surgical Narrow Pattern

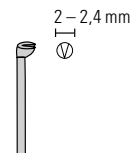

Straight
1x2 teeth

Tip width (mm)	Length (cm)	Item
2	11,5	No. 91123-12
2,2	14,5	No. 91123-14
2,4	16	No. 91123-16

Semken



Straight
11,5 cm
Tip width: 1,2 mm
No. 91108-12

Straight
14,5 cm
Tip width: 2,2 mm
No. 91108-14

Gillies



80% of actual size

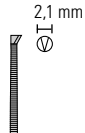

1x2 teeth
Cross-Serrated
15,5 cm
Tip width: 2,1 mm
No. 91128-15

Russian

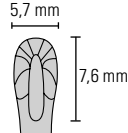

15 cm
Tip dimensions: 7,6 x 5,7 mm
No. 91126-15

McIndoe

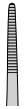

Serrated
15 cm
Tip width: 1,2 mm
No. 91138-15



Quantity discount for student instruments:
5-9 = 5%
10+ = 10%
Per item, selection cannot be assorted for discount.

STUDENT

Halsted-Mosquito

Hartmann



**%
DISCOUNT**

**Quantity discount
for student
instruments:**

5-9 = 5%
10+ = 10%

*Per item, selection
cannot be assorted
for discount.*

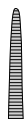

Straight
Serrated

12,5 cm

No. 91308-12



Curved
Serrated

12,5 cm

No. 91309-12



Curved
1x2 teeth

12 cm
Tip width: 1,9 mm

No. 91331-12



Curved
Serrated

10 cm
Tip width: 1,6 mm

No. 91303-10

Crile

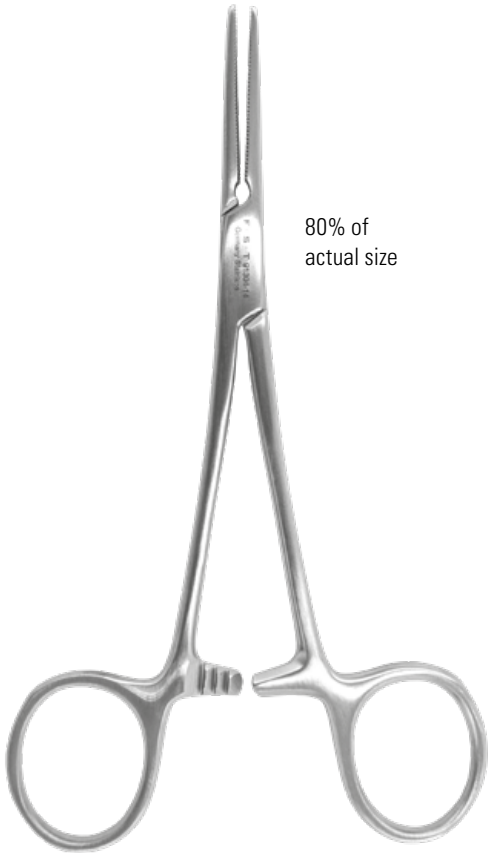

80% of actual size



Straight Serrated

14 cm
Tip width: 1,3 mm

No. 91304-14

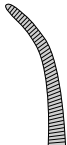

Curved Serrated

14 cm
Tip width: 1,3 mm

No. 91305-14

Straight Serrated

16 cm
Tip width: 1,7 mm

No. 91304-16

Curved Serrated

16 cm
Tip width: 1,7 mm

No. 91305-16

Kelly



Straight Serrated

14,5 cm
Tip width: 1,6 mm

No. 91318-14

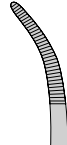

Curved Serrated

14,5 cm
Tip width: 1,8 mm

No. 91319-14

**%
DISCOUNT**

Quantity discount for student instruments:

5-9 = 5%
10+ = 10%

Per item, selection cannot be assorted for discount.

STUDENT

Rochester-Pean

Pean

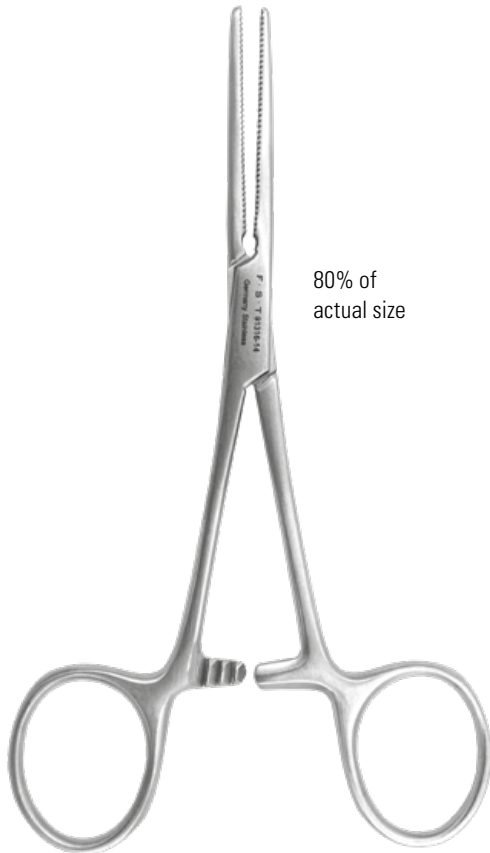

80% of actual size

**%
DISCOUNT**

Quantity discount for student instruments:

5-9 = 5%
10+ = 10%

Per item, selection cannot be assorted for discount.

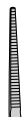

Straight
Serrated

14 cm
Tip width: 2 mm

No. 91316-14



Curved
Serrated

14 cm
Tip width: 2 mm

No. 91317-14

Straight
Serrated

16 cm
Tip width: 2,5 mm

No. 91316-16

Curved
Serrated

16 cm
Tip width: 2,5 mm

No. 91317-16



Straight
Serrated
Narrow

14 cm
Tip width: 2 mm

No. 91322-14



Curved
Serrated
Narrow

14 cm
Tip width: 2 mm

No. 91323-14

STUDENT

Ochsner-Kocher

Kocher

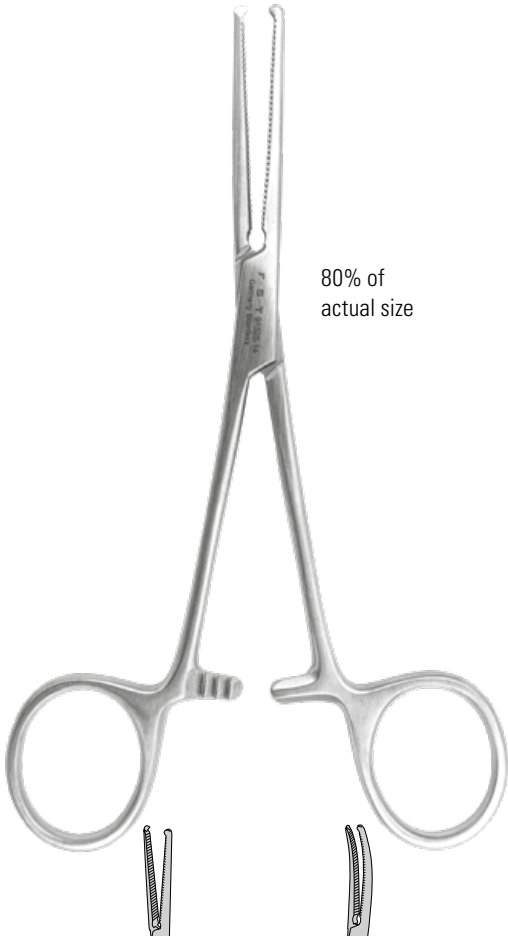

Straight
Serrated
1x2 teeth
14 cm
Tip width: 2,2 mm
No. 91328-14

Curved
Serrated
1x2 teeth
14 cm
Tip width: 2,2 mm
No. 91329-14

Straight
Serrated
1x2 teeth
16 cm
Tip width: 3 mm
No. 91328-16

Curved
Serrated
1x2 teeth
16 cm
Tip width: 3 mm
No. 91329-16



Straight
Serrated
Narrow 1x2 teeth
14 cm
Tip width: 2,2 mm
No. 91330-14

Curved
Serrated
Narrow 1x2 teeth
14 cm
Tip width: 2,2 mm
No. 91331-14

**%
DISCOUNT**

Quantity discount
for student
instruments:

5-9 = 5%
10+ = 10%

*Per item, selection
cannot be assorted
for discount.*

STUDENT

Backhaus Towel Clamp



Tohoku Towel Clamp



**%
DISCOUNT**

**Quantity discount
for student
instruments:**

5-9 = 5%
10+ = 10%

*Per item, selection
cannot be assorted
for discount.*

STUDENT

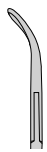

9 cm

No. 91195-09



11 cm

No. 91195-11



13 cm

No. 91195-13



Serrated

10 cm

Tip width: 2,4 mm

No. 91194-10



Serrated

13 cm

Tip width: 2,8 mm

No. 91194-13

Lorna Towel Clamp



Serrated
13 cm
Tip width: 7 mm
No. 91196-13

Babcock



Serrated
16 cm
Tip width: 6 mm
No. 91393-16

**%
DISCOUNT**

Quantity discount
for student
instruments:

5-9 = 5 %
10+ = 10 %

*Per item, selection
cannot be assorted
for discount.*

STUDENT

Pin Holder

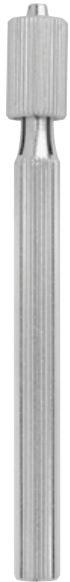

**%
DISCOUNT**

**Quantity discount
for student
instruments:**

5-9 = 5%
10+ = 10%

*Per item, selection
cannot be assorted
for discount.*

For pins, see
page 113.

Nickel-plated
7,5 cm
Jaw opening: 0-1 mm
No. 91606-07

Halsey Needle Holder

**MOST
POPULAR**



80% of
actual size

For suture needles,
see page 120 & 121.



Straight
13 cm
Tip width: 1,5 mm
clamping length: 18 mm
with lock
without scissors
No. 91201-13

Mayo-Hegar



80% of
actual size

For suture needles,
see page 120 & 121.



Straight
16 cm
Tip width: 2,6 mm
clamping length: 21 mm
with lock
without scissors
No. 91204-16

Senn-Miller



16 cm
3 sharp teeth 7 x 8 mm
1 blunt tooth 18 x 6 mm
No. 91790-16

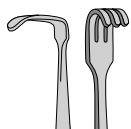

16 cm
3 blunt teeth 7 x 8 mm
1 blunt tooth 18 x 6 mm
No. 91791-16

Vessel Dilator



Angled 10°
11 cm
Tip diameter: 0,3 mm
No. 91815-11

Spring-Loaded Retractor

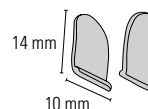

Curved atraumatic blades
8,5 cm
Maximum spread: 3 cm
Blade dimensions: 14 x 10 mm
No. 91706-05

Barraquer

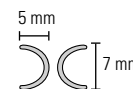

3 cm
Maximum spread: 1,1 cm
Tip dimensions: 5 x 7 mm
No. 91700-03

Dieffenbach



Straight
35 mm
Strong pressure
No. 91850-35



Quantity discount for student instruments:

5-9 = 5%
10+ = 10%

Per item, selection cannot be assorted for discount.

STUDENT



Reference Pages

Worldwide Locations	Page	201
Scissors Test	Page	202
Features and Alloys	Page	203
Maintenance and Care	Pages	204 – 205
Quality Control	Page	206
Student Line	Page	207
Selection	Page	208
Dumont	Page	209
Numerical Index	Pages	210 – 213
Alphabetical Index	Pages	214 – 219
Additional Information	Page	220

Fine Science Tools Around the World

Commitment to excellence

For decades, we've demonstrated our commitment to excellence with genuine quality and a 100% satisfaction guarantee. As a result, our products continue to be the preferred instruments among scientists and biomedical researchers worldwide.

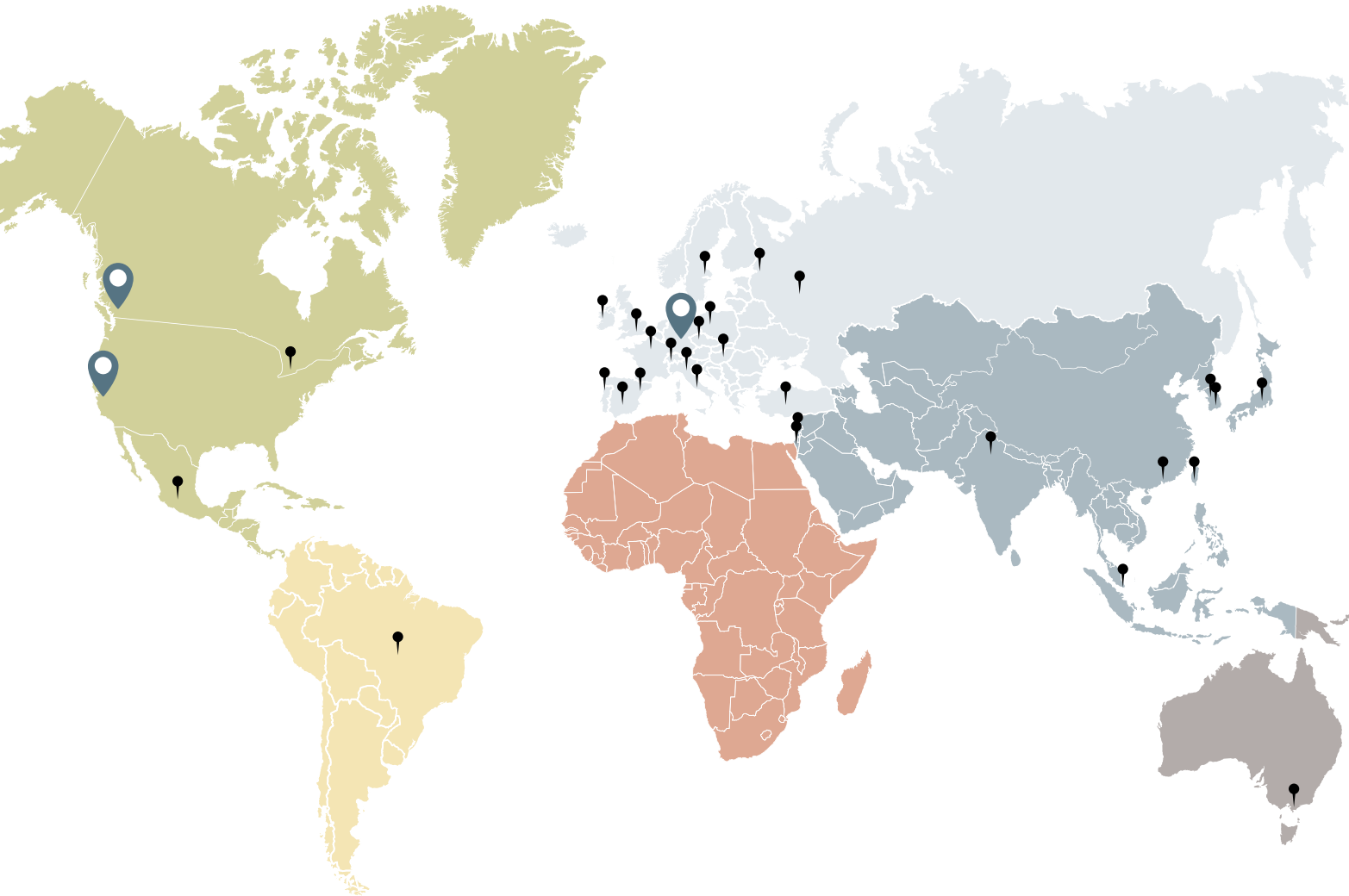

We have offices and dealers throughout the world and have been shipping globally since 1974.

WORLDWIDE

Does paying more for a pair of scissors really buy more value and a longer cutting life?

Pictured below is a scissors testing device used to compare various alloys and cutting edge styles. The scissors repeatedly cut through a continuous feed of cotton cloth, and a counter keeps track of the number of cuts made to evaluate when the scissors begin to show a decrease in cutting quality.

The results verify that the addition of various features dramatically increases the cutting life of the scissors. Most notably, the cutting life is more than doubled with the addition of ToughCut blades to stainless steel, and over six times longer with CeramaCut blades.

See the chart below for a comparison of four different scissors sold by FST.

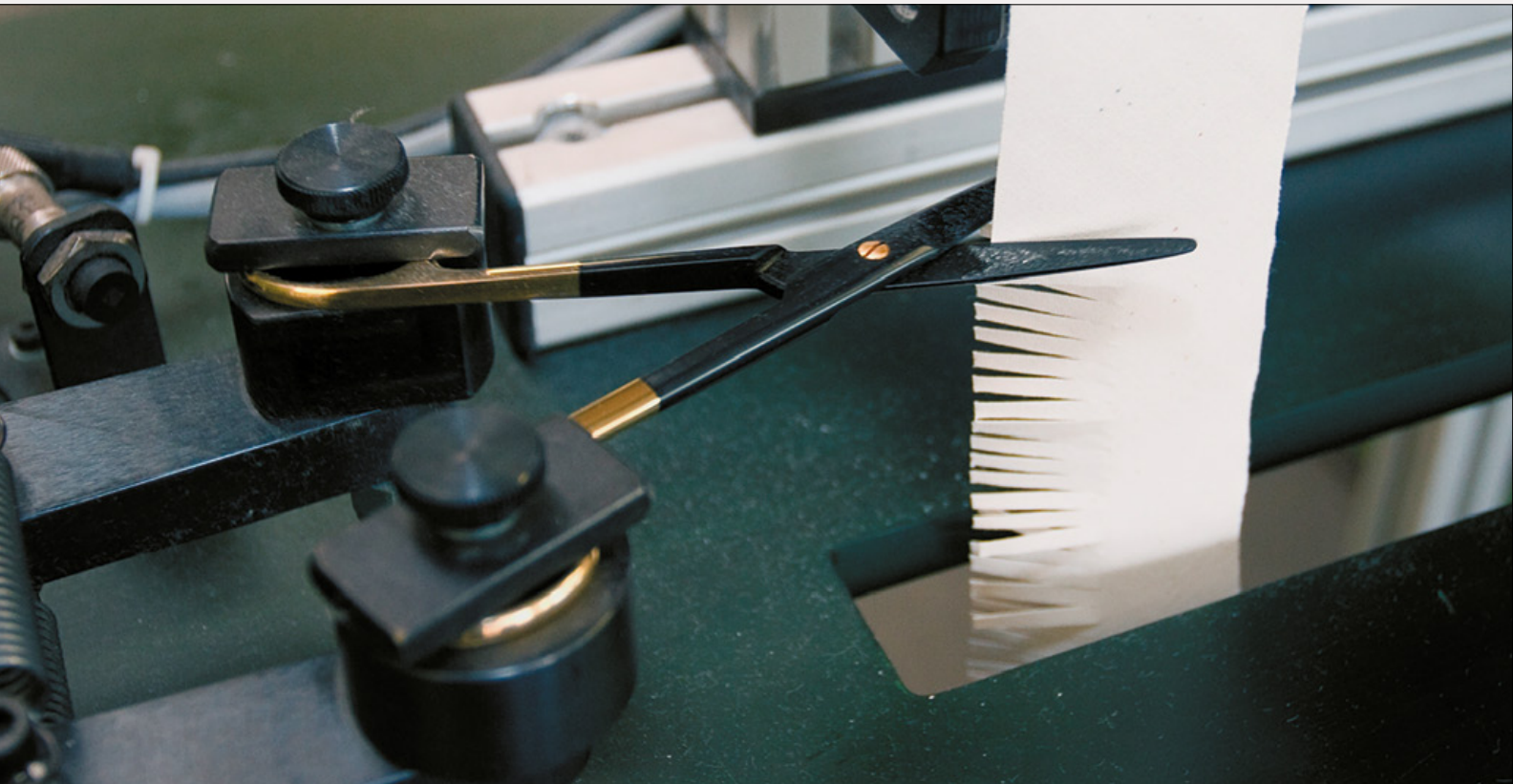

The cutting life is more than doubled with the addition of ToughCut blades to stainless steel, and over six times longer with CeramaCut blades.

Alloy/Material	Lasts longer than stainless steel by:
Tungsten Carbide	1,9x
Stainless Steel with ToughCut	2,3x
Tungsten Carbide with ToughCut	4,1x
CeramaCut (Ceramic Coated Tungsten Carbide with ToughCut)	6,6x

See page 203 for more information on ToughCut, Tungsten Carbide and CeramaCut.

Tungsten Carbide

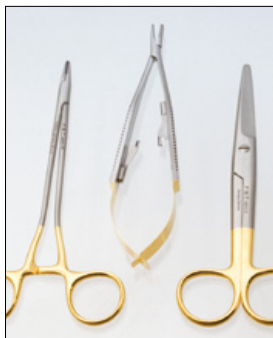

When you place heavy demands on your surgical instruments, be it scissors, needle holders, or forceps, you should consider the benefits of tungsten carbide, one of the hardest alloys available. Tungsten carbide scissors last almost two times longer than stainless steel, and needle holder tips can be made with a pyramid cross pattern that holds suture needles much more securely. Inlays are either glued or welded into place.

Compare the extra cost of these instruments with the length of useful wear and you have a cost effective solution for your instrument requirements. Tungsten carbide instruments are identified by their gold handles.

Bone Cutters: page 43
 Scissors: pages 10, 20–21, 23, 30–32, 34 and 46
 Forceps: page 88
 Needles: page 113
 Needle Holders: pages 115–119
 Burrs: page 162

Look for this symbol



ToughCut® Scissors



ToughCut scissors feature two unique cutting edges that cut through the toughest tissue with exceptional ease and accuracy. One blade is honed to razor sharpness, and the other is micro-serrated to minimize tissue slippage during cutting. Scissors with ToughCut edges are identified by their black handles.

For ToughCut scissors that last almost two times longer, select ToughCut with tungsten carbide cutting edges.

Scissors: pages 6, 15, 20–21, 30, 33–34

Look for this symbol



Ceramic and CeramaCut® Instruments

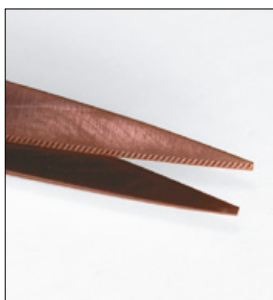

One of the hardest materials on Earth, ceramic is used in surgical instruments to form edges that last longer than stainless steel and even longer than tungsten carbide. Ceramic also has a high slide capacity which reduces surface tension and results in a much cleaner cut than metal instruments. Our CeramaCut scissors combine ToughCut technology with tungsten carbide edges and a ceramic coating for one of the best, cleanest cutting scissors available on the market today.

CeramaCut Scissors: page 21
 Ceramic Blades: page 56
 Ceramic Cutter: page 166
 Ceramic Coated Forceps: pages 65 and 71
 Ceramic Coated Spring Scissors: pages 7 and 11

Look for this symbol



Titanium

Titanium instruments are over 40% lighter than equivalent stainless steel instruments, with better flexibility and strength. Elemental titanium (Ti) is a very strong, lustrous, white metal with a specific gravity of 4.54. Titanium and titanium alloys readily form stable protective surface layers, giving them excellent corrosion resistance to saltwater, laboratory saline solutions, blood and other bodily fluids, oxidizing acids, alkalis and chlorides. Titanium is 100% nonmagnetic; a great benefit when working with nerves. Its inherent surface oxide film provides bactericidal and non-allergenic properties. Titanium alloys can be heated up to 440°C (824°F).

Scissors: pages 6 and 11
 Forceps: pages 67, 71, 84, 90, 91 and 94
 Probes, Y-Hook and Spatula: page 106
 Vascular Clamps: pages 136–137

Look for this symbol



Cleaning, Sterilization, Maintenance, & Storage of Surgical Instruments

Proper care of your surgical instruments will improve their longevity and function. Below are different cleaning, sterilization, and maintenance processes to guide you through your techniques.

General Care & Maintenance

Guidelines to extend the life of your surgical instruments.

- Clean and thoroughly dry your instruments as soon as possible after each use, paying special attention to joints, hinges, and anywhere there is metal to metal contact.
- Handle your instruments delicately and with care.
- Use your instruments for their intended purpose.
- Store your instruments with tip protectors, and always place them so that they do not touch each other.

Cleaning

Fine surgical instruments should be cleaned immediately after use. Blood or saline solutions left on instruments for any length of time can quickly start corrosive action. Time, temperature, and agitation play important roles in the cleaning process. Time affects the efficiency of cleaning solutions as most are effective after a certain time period. Higher temperature cleaning solutions result in better cleaning. During manual or ultrasonic cleaning it is helpful to loosen any surgical residue. Before any of the below procedures, rinse your instruments under warm running water to remove all blood and tissue. Instruments can be cleaned manually or ultrasonically, but always:

- Use a neutral pH (pH 7) cleaning solution.
 - Clean instruments in the open position to ensure a thorough and effective cleaning process.
 - Use soft textile or paper cloths, soft plastic brushes made of nylon, or water spray guns.
- Do **NOT** use steel wool, wire brushes, or scouring pads as these are abrasive to the instruments.

Manual Cleaning

- Make sure all instruments are visibly clean and free from stains, wiping them carefully to remove all blood and tissue matter.
- Rinse instruments thoroughly with distilled water, paying close attention to joints and hinges as these areas can accumulate unwanted material.
- Air dry your instruments completely and use a can of compressed air to blow out any water at the joints and hinges. Then store them only in clean and dry environments.

Ultrasonic Cleaning

Ultrasonic cleaning is the most effective cleaning method. The vibrating sound waves create micron-sized bubbles in the solution that grow with the alternating pressure. When the bubbles reach a particular size, they collapse creating a force that dislodges dirt and particles, even in the smallest of crevices.

- **NOT** recommended for delicate and micro instruments.
- Follow the manufacturer's guidelines for specific instructions and cleaning cycle times. Instruments should be processed for the full recommended cycle time.
- Place instruments in the open position in the ultrasonic cleaner.
 - Do **NOT** allow instruments with sharp blades to touch other instruments.
 - Do **NOT** place dissimilar metals (stainless, copper, chrome plated) in the same cleaning cycle.
 - Make sure all instruments are completely submerged.
- After the ultrasonic cleaning cycle is complete, rinse instruments thoroughly to remove all ultrasonic cleaning solution.
- Dry instruments thoroughly with a clean towel.
- Use a spray lubricant in the hinges to minimize the risk of corrosion and maintain functionality.

Sterilization

It is important that instruments are free from all traces of organic or other matter prior to sterilization.

Steam Sterilization/Autoclaving

The autoclave process utilizes moist heat (or steam) under pressure for sterilization. The steam used must be from distilled water and free of all impurities.

- Lubricate all instruments that have any metal to metal interaction such as; scissors, rongeurs, needle holders, hemostats, and retractors. Do **NOT** use WD-40 or other industrial lubricants.
- Instruments may be autoclaved individually or in sets.
 - **Individual instruments:** Disposable wraps or sterilization pouches are ideal. Make sure the pouch size is sufficient for the instrument to be in an open (unlocked) position.
 - **Instrument sets:** Open and unlock all instruments. Place the heavier instruments on the bottom of the set when two layers are needed.
- Do **NOT** lock instruments during autoclaving. This will prevent the steam from reaching and sterilizing the metal to metal surfaces, and heat expansion during autoclaving can cause cracks in the hinge areas.
- Do **NOT** over load the autoclave chamber as this may hinder steam penetration.
- Place a towel on the bottom of the pan to absorb excess moisture during autoclaving. Make sure the towel has no detergent residue and is pH neutral if immersed in water.
- At the end of the autoclave cycle (before the drying cycle) unlock the autoclave door and open it slightly. Run the dry cycle for the recommended time period by the autoclave manufacturer.

IMPORTANT NOTE: Do **NOT** mix instruments of different or unknown alloys in the autoclave.

Please note: If the autoclave door is fully opened before the drying cycle, cold air will rush into the chamber, which can cause condensation on the instruments. This will result in water stains on the instruments.

Hot Bead Sterilization

Recommended for speed and convenience when instrument tips or blade sterilization is required. The Hot Bead Sterilizer does not use dangerous gases, flames, or chemicals. Highlights:

- Bench top set up.
- Only 20 seconds of contact required to ensure your instruments are free of pathogens and microbial contaminants.
- Can be left on all day.
- Beads reach temperature of 240° - 270°C (464° - 518°F) within 15-20 minutes heating time.

Please see page 154 for more information on the FST Hot Bead Sterilizers.

Ethylene Oxide (ETO) Sterilization

This method is recommended for instruments that will not tolerate high temperatures or moisture (e.g., catheters, cannulae, etc.). This is a process consisting of 4 primary variables; gas concentration, humidity, temperature and time. Sterilization pouches and wraps available, see pages 153 and 155.

Storage

Surgical instruments should be properly stored in a clean and dry environment. It is highly recommended to use tip protectors and instrument cases to avoid possible damage to your instruments. Instrument tip protectors are available, see page 152. Instrument cases are available, see pages 157 – 160.

Oxidation (Rust)

All FST stainless steel surgical instruments are manufactured from medical grade stainless steel under strict European standards. It is very important to properly take care of your instruments to extend their lifespan.

Although stainless steel is corrosive resistant, it can still rust or stain if handled improperly. Under unfavorable conditions instruments may oxidize because stainless steel that is exposed to physical, thermal, or chemical manipulations may lose some of its stainless properties.

Quality Control

The high quality of Fine Science Tools surgical and microsurgical instruments is the result of our relentless attention to detail. Almost every instrument we sell is manufactured by skilled European craftsmen, designed to exacting specifications made from the finest German stainless steel alloys, and forged from the strongest, lightest materials available, and tested to ensure precision performance and ergonomics.

We are dedicated to quality control, with technicians in our German office inspecting most FST instruments. Aside from checking instrument dimensions and specifications, we thoroughly inspect tip sharpness, cutting edges, springs, joints, and other various components. Only after passing our detailed inspections, instruments are approved and sealed with our "FST Inspected" sticker.

We are proud to guarantee all of our products with your 100% satisfaction. If, for any reason, you are not completely satisfied with your purchase, you may return it for a full refund.

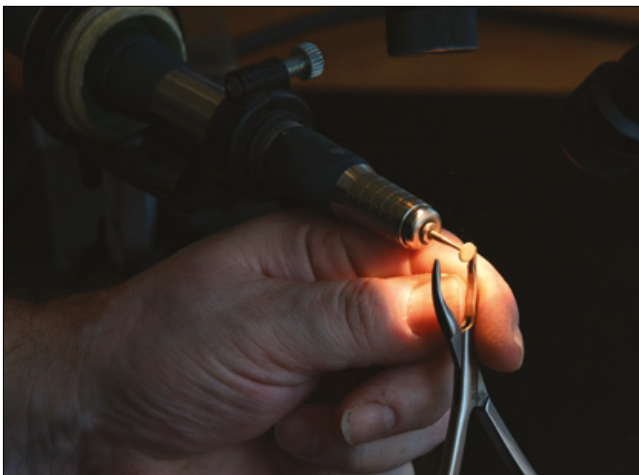



FST Student Quality Instruments

One of the hallmarks of FST has always been to accurately assess the needs of our customers. We gather information not only from the lab, but from conferences, journals and researchers. Whether it is designing new tools or finding new applications for existing instruments, we believe our best information comes directly from you.

Our customers wanted reduced costs and quantity discounts without sacrificing the precision and quality inherent in German instruments. To meet their needs, we have developed a full line of "student" instruments. They were created for use in the classroom where students are learning proper instrument care.

Unlike our competitors, the quality of these instruments does not drop dramatically with the price. Our student line uses quality stainless steel and maintains the precision you expect from FST. In addition they carry our unconditional satisfaction guarantee while being offered at a significantly reduced price.

Not intended as a substitute for our highest quality instruments, the student line may require extra care as the alloys used are more susceptible to corrosion. All of our shipments come with an instruction pamphlet describing the use and care of surgical instruments. Visit our website at finescience.com for more information.

Features:

- Economy
- Quantity discounts
- Quality
- Less hand finishing
- Less expensive alloys

We Proudly Stock



Fine Science Tools is proud to offer a large selection of left-handed surgical instruments to the research community. To find our left-handed instruments in this catalog, look for the “left-handed” icon on the pages below.

Scissors: pages 17, 29 and 167

Hemostatic Forceps: page 97

Needle Holders: pages 117-118

Ligation Aid: page 139



FST features a selection of scissors with larger than normal finger loops. Most of these loops are easily adjustable to fit larger fingers more comfortably. To find our large loop scissors please look for the “large loop” icon on the pages below.

Scissors: pages 19, 28 and 31



Fine Science Tools has noted which items are most frequently purchased for use in a variety of surgical procedures. To find our most popular items, look for the “most popular” icon throughout the catalog.



Fine Science Tools offers a wide selection of the latest and most popular Dumont forceps. Hand crafted in Switzerland for more than a century, these forceps are known for their consistent and uncompromised fineness. Dumont forceps come in a wide array of styles and alloys. On page 209, you will find detailed descriptions to help guide you in choosing the right Dumont forceps best suited for your needs.



Moria of France is one of the most respected and well known ophthalmic instrument manufacturers in the world, offering some of the finest surgical instruments in the industry for almost 200 years.

Only quality Swedish and German stainless alloys are selected; and many hours of highly skilled labor are put into the manufacturing process, which includes hand crafted sharpening, balancing, and polishing, often done under 40x magnification. Moria’s product line includes scissors, spring scissors, forceps, spoons, vessel clamps, and more.



This Swiss manufacturer has established itself as one of the premier suppliers of superb microsurgical instruments worldwide. Unique designs, precise instrument balance, and optimum angles gives S&T instruments the “right feel” which is important for all procedures. S&T’s product line includes forceps, needle holders, scissors, vessel clamps, sutures, vessel cannulation forceps, vessel dilators, and more.

Finding the Dumont forceps best suited for your needs:



Alloys	Hardness	Magnetic	Temperature resistance	Autoclavable	Advantages
Titanium	Least Hard	No	Up to 430° C	Yes	Resistant to corrosion from nitric acid, chloride, and salt water. Titanium is 40% lighter than stainless steel.
Dumoxel	Hard	No	400° C	Yes	The most popular alloy available for Dumont forceps offers the best resistance to corrosion, sulphuric environments, hydrochloric acids, and all other mineral and organic acids.
Inox	Harder	Yes	400° C	Yes	Available for most Dumont forceps. Contains chromium added to carbon steel, which results in some loss of hardness but offers good stainless qualities and resistance to corrosion.
Dumostar	Harder	No	500° C	Yes	More durable and corrosion resistant than the best stainless steels. Highly resistant to mineral and organic acids, and salt water. Dumostar lasts an average of four times longer than Dumoxel and Inox. Most cost effective alloy for laboratory use.
Carbon	Hardest	Yes	N/A	No	Extremely hard; ensuring strong tips. Easily stains and rusts without proper care. Carbon cannot be immersed in a water bath or sterilized.

Tip profiles: Dimensions vary. See each style for specific dimensions (width x thickness).

Standard	Made for high precision and consistently precise work under a microscope.
Biology	Twice as fine as "Standard Tips." Especially produced for high precision laboratory work under the microscope.
Super Fine Tips	Four times finer than the "Standard Tips." These tips are extremely delicate for the finest work under the microscope. Extra care is needed for these tips as they are very fragile.

Styles

#2	Straight forceps with wide yet fine tips, referred to as Mouse Laminectomy Forceps because of their popularity in breaking off delicate bone from mouse skulls.
#2AP	Epoxy coated with flat wide blunt tips.
#3	Long straight forceps with coarse tips. Popular in low magnification procedures.
#3C	Shorter version of #3.
#4	Similar to the #5 but with broader shanks and stronger tips.
#5	Most popular style of Dumont straight forceps with fine tips which come in several styles.
#55	Similar to the #5 but with lighter shanks, giving the forceps a lighter spring action.
#5CO	Similar to the #55 but with even finer shanks producing the lightest spring action and longest meeting surface of any Dumont style.
#5L	Medical #5 forceps with slide sleeve for a secure hold and retention.
#5SF	The finest tips ever produced by Dumont.
#5XL	Extra Long #5 forceps.
#5/45	Tips angled at 45°.
#5/45C	Designed to pick up cover slips from multi-well plates.
#5/90	Tips angled at 90°.
#5AC	Self-closing Anti-Capillary forceps.
#6	Sharply angled, broad tips.
#7	Most popular style of Dumont curved forceps with fine tips which come in several styles.
#7B	Curved serrated tips.
AA	Strong broad tips.
M	Mini forceps.
Medical	Denotes distinctive ribbed handle to maximize grip.
SS	Long and narrow shanks with thin tips.
WA	One piece design with no soldering grooves allows the forceps to be thoroughly and easily cleaned preventing biofilm residue.

Item No.	Page No.										
		10032-13.....	104	10099-15.....	110	11002-12.....	90	11028-15.....	93	11151-10.....	84
		10033-13.....	104	10100-30.....	56	11002-13.....	90	11029-14.....	92	11152-10.....	84
		10035-00.....	58	10100-45.....	56	11002-14.....	90	11030-12.....	89	11153-10.....	84
00071-14.....	135	10035-05.....	58	10110-01.....	55	11002-16.....	90	11031-15.....	93	11154-10.....	84
00072-14.....	135	10035-10.....	58	10110-03.....	55	11002-18.....	90	11032-12.....	88	11155-10.....	84
00081-00.....	161	10035-12.....	58	10110-05.....	55	11002-20.....	90	11036-20.....	91	11158-10.....	84
00108-11.....	79	10035-15.....	58	10110-07.....	55	11002-25.....	90	11036-90.....	91	11159-10.....	84
00109-11.....	79	10035-20.....	58	10130-05.....	113	11003-12.....	90	11040-08.....	83	11160-10.....	84
00125-11.....	140	10035-25.....	58	10130-10.....	113	11003-13.....	90	11041-08.....	83	11200-00.....	74
00126-11.....	140	10035-30.....	58	10130-20.....	113	11003-14.....	90	11042-08.....	83	11200-10.....	74
00272-13.....	81	10050-00.....	57	10140-01.....	105	11003-16.....	90	11043-08.....	83	11200-12.....	74
00276-13.....	140	10052-11.....	57	10140-02.....	105	11003-18.....	90	11049-10.....	84	11200-14.....	74
00325-00.....	134	10053-09.....	57	10140-03.....	105	11003-20.....	90	11050-10.....	84	11200-33.....	73
00396-01.....	134	10053-13.....	57	10140-04.....	105	11006-12.....	88	11051-10.....	84	11203-23.....	73
00398-02.....	134	10055-12.....	52	10152-30.....	54	11006-15.....	82	11052-10.....	84	11203-25.....	73
00400-03.....	134	10056-12.....	52	10157-13.....	54	11008-13.....	91	11053-10.....	84	11210-10.....	73
00574-11.....	143	10058-15.....	53	10157-15.....	54	11008-15.....	91	11054-10.....	84	11210-20.....	73
00632-11.....	79	10059-13.....	52	10157-18.....	54	11009-13.....	91	11055-10.....	84	11215-01.....	42
00649-11.....	79	10059-15.....	53	10160-13.....	107	11009-15.....	91	11062-10.....	85	11215-02.....	42
10000-10.....	62	10060-00.....	62	10162-12.....	103	11010-17.....	95	11063-07.....	81	11220-21.....	72
10000-11.....	62	10060-13.....	62	10165-11.....	106	11011-17.....	95	11064-07.....	83	11223-20.....	72
10000-15.....	62	10061-12.....	105	10166-11.....	106	11012-18.....	95	11065-07.....	83	11231-20.....	70
10002-00.....	61	10062-12.....	105	10167-11.....	106	11012-21.....	95	11066-07.....	83	11231-30.....	70
10002-50.....	61	10063-15.....	104	10315-12.....	58	11012-25.....	95	11067-07.....	83	11241-30.....	72
10003-12.....	60	10064-14.....	105	10316-14.....	58	11013-18.....	95	11069-08.....	83	11242-40.....	72
10003-13.....	60	10065-15.....	104	10317-14.....	58	11013-21.....	95	11070-08.....	83	11251-10.....	67
10004-13.....	59	10066-15.....	104	10318-14.....	58	11014-18.....	94	11071-10.....	85	11251-20.....	67
10006-12.....	63	10073-14.....	52	10321-08.....	111	11015-18.....	94	11072-11.....	87	11251-21.....	68
10007-12.....	61	10075-16.....	51	10360-13.....	111	11016-17.....	95	11073-10.....	86	11251-23.....	67
10007-16.....	61	10080-05.....	51	10370-13.....	53	11017-17.....	95	11074-02.....	86	11251-30.....	67
10009-13.....	59	10081-10.....	51	10370-17.....	111	11018-12.....	88	11075-00.....	86	11251-33.....	69
10010-00.....	60	10082-15.....	51	10370-18.....	111	11019-12.....	88	11080-02.....	94	11251-35.....	69
10010-10.....	63	10083-20.....	51	10370-19.....	111	11020-12.....	88	11083-07.....	80	11252-00.....	65
10011-00.....	60	10087-12.....	108	11000-12.....	90	11021-12.....	92	11084-07.....	80	11252-20.....	67
10011-10.....	63	10088-15.....	107	11000-13.....	90	11021-14.....	92	11090-09.....	80	11252-21.....	68
10012-00.....	60	10089-11.....	108	11000-14.....	90	11021-15.....	92	11090-10.....	80	11252-23.....	67
10015-00.....	60	10090-13.....	107	11000-16.....	90	11022-12.....	88	11091-15.....	101	11252-30.....	67
10015-10.....	63	10090-17.....	107	11000-18.....	90	11022-14.....	92	11092-12.....	101	11252-40.....	67
10020-00.....	59	10091-12.....	108	11000-20.....	90	11022-15.....	92	11093-10.....	81	11252-50.....	65
10021-00.....	59	10092-12.....	108	11000-25.....	90	11023-10.....	92	11095-09.....	100	11253-10.....	68
10022-00.....	59	10093-13.....	108	11000-30.....	90	11023-12.....	92	11095-13.....	100	11253-20.....	66
10023-00.....	59	10094-13.....	108	11001-12.....	90	11023-14.....	92	11096-10.....	101	11253-21.....	66
10025-45.....	56	10095-12.....	51	11001-13.....	90	11023-15.....	92	11096-13.....	101	11253-25.....	66
10025-50.....	56	10096-16.....	51	11001-14.....	90	11024-18.....	95	11101-09.....	87	11253-27.....	69
10025-70.....	166	10097-16.....	51	11001-16.....	90	11025-18.....	95	11103-09.....	87	11253-29.....	66
10030-13.....	104	10098-06.....	109	11001-18.....	90	11026-15.....	93	11106-09.....	87	11254-20.....	65
10031-13.....	104	10099-12.....	110	11001-20.....	90	11027-12.....	88	11150-10.....	84	11255-20.....	67

11258-20.....74	11700-00.....86	12051-08.....120	14000-14.....29	14019-13.....32	14084-09.....15
11260-20.....70	11700-01.....86	12051-10.....120	14000-16.....29	14019-14.....32	14085-08.....15
11270-20.....71	11700-02.....86	12051-11.....120	14000-18.....29	14019-18.....32	14085-09.....15
11271-30.....71	11700-03.....86	12052-08.....120	14000-20.....29	14024-14.....33	14086-09.....27
11272-30.....71	11700-04.....86	12052-09.....120	14001-12.....29	14028-10.....22	14088-10.....18
11272-40.....71	11900-14.....82	12052-10.....120	14001-13.....29	14029-10.....22	14090-09.....16
11272-50.....71	11911-11.....75	12052-11.....120	14001-14.....29	14037-10.....28	14090-11.....16
11273-20.....66	11915-11.....75	12060-01.....114	14001-16.....29	14040-10.....19	14091-09.....16
11273-22.....66	11917-12.....75	12060-02.....114	14001-18.....29	14041-10.....19	14091-11.....16
11274-20.....71	11923-13.....76	12061-01.....114	14002-12.....29	14054-13.....30	14094-11.....16
11280-11.....143	11980-13.....76	12061-02.....114	14002-13.....29	14058-09.....20	14095-11.....16
11281-11.....143	11988-01.....76	12075-12.....114	14002-14.....29	14058-11.....20	14101-14.....31
11282-11.....143	11988-02.....76	12075-14.....114	14002-16.....29	14059-09.....20	14105-12.....25
11293-00.....70	11988-03.....76	12076-12.....114	14003-12.....29	14059-11.....20	14106-09.....28
11294-00.....72	11990-14.....75	12102-12.....117	14003-13.....29	14060-09.....17	14108-09.....28
11295-00.....67	11991-14.....75	12500-12.....116	14003-14.....29	14060-10.....17	14110-15.....34
11295-10.....67	11992-12.....75	12501-13.....116	14003-16.....29	14060-11.....17	14110-17.....34
11295-20.....65	12001-13.....116	12502-12.....117	14003-18.....29	14061-09.....17	14111-15.....34
11295-51.....67	12002-12.....117	12502-14.....117	14003-20.....29	14061-10.....17	14111-17.....34
11297-00.....71	12002-14.....117	12503-15.....118	14004-12.....29	14061-11.....17	14116-14.....33
11297-10.....71	12003-15.....118	12504-15.....118	14004-13.....29	14062-09.....17	14116-18.....33
11370-31.....78	12004-16.....118	12505-15.....119	14004-14.....29	14062-10.....17	14117-14.....33
11370-32.....78	12004-18.....118	12510-14.....115	14004-16.....29	14063-09.....17	14117-18.....33
11370-40.....78	12005-15.....119	12512-12.....117	14004-18.....29	14063-11.....17	14130-17.....30
11370-42.....78	12010-14.....115	12565-14.....115	14005-12.....29	14064-11.....24	14131-14.....31
11373-12.....78	12018-12.....123	13002-10.....100	14005-13.....29	14065-11.....24	14160-10.....17
11373-22.....78	12020-00.....125	13003-10.....100	14005-14.....29	14066-11.....24	14161-10.....17
11399-80.....78	12020-09.....125	13004-14.....98	14005-16.....29	14067-11.....24	14171-10.....28
11399-87.....78	12022-09.....125	13005-14.....98	14007-14.....30	14068-12.....19	14173-12.....25
11412-11.....77	12022-19.....125	13006-12.....96	14008-14.....29	14069-12.....19	14184-09.....15
11413-11.....77	12023-00.....125	13007-12.....96	14010-15.....34	14070-12.....19	14185-09.....15
11445-12.....77	12028-12.....123	13008-12.....97	14010-17.....34	14071-12.....19	14200-21.....35
11480-11.....77	12029-12.....123	13009-12.....97	14011-15.....34	14072-10.....27	14370-22.....18
11485-11.....77	12030-01.....124	13010-12.....97	14011-17.....34	14074-09.....23	14370-23.....18
11487-11.....77	12030-04.....124	13011-12.....97	14012-15.....35	14074-11.....23	14501-14.....30
11506-12.....88	12030-20.....124	13012-12.....97	14012-17.....35	14075-09.....23	14502-14.....30
11515-02.....43	12030-22.....124	13013-14.....99	14013-15.....35	14075-11.....23	14504-14.....30
11602-14.....90	12030-23.....124	13014-14.....99	14013-17.....35	14076-09.....26	14505-14.....30
11602-16.....94	12035-00.....124	13015-14.....99	14014-17.....35	14077-09.....24	14508-15.....32
11608-15.....91	12040-01.....123	13018-14.....98	14015-17.....35	14077-10.....24	14509-15.....32
11616-15.....89	12040-02.....123	13019-14.....98	14016-14.....33	14078-10.....22	14510-15.....34
11617-12.....89	12040-03.....123	13020-12.....96	14016-18.....33	14079-10.....22	14510-17.....34
11626-11.....69	12050-01.....121	13021-12.....96	14017-14.....33	14080-11.....27	14511-15.....34
11627-12.....89	12050-02.....121	13108-12.....97	14017-18.....33	14081-09.....26	14511-17.....34
11650-10.....84	12050-03.....121	13109-12.....97	14018-13.....32	14082-09.....26	14512-15.....34
11651-10.....84	12050-10.....121	14000-12.....29	14018-14.....32	14083-08.....15	14512-17.....34
11652-10.....84	12050-20.....121	14000-13.....29	14018-18.....32	14084-08.....15	14518-14.....32

14518-18.....32	15020-15.....7	16022-15.....39	17010-07.....129	18026-10.....82	18061-18.....145
14519-14.....32	15021-15.....7	16023-15.....39	17011-10.....131	18030-30.....121	18061-20.....145
14519-18.....32	15023-10.....9	16025-14.....49	17012-11.....132	18030-40.....121	18061-22.....145
14531-09.....31	15024-10.....9	16030-12.....46	17012-13.....132	18030-50.....121	18061-24.....145
14558-09.....21	15025-10.....9	16030-16.....46	17017-10.....131	18030-60.....121	18061-38.....145
14558-11.....21	15027-18.....12	16044-10.....46	17018-11.....132	18030-70.....121	18061-50.....145
14559-09.....21	15028-18.....12	16050-15.....47	17020-17.....126	18030-80.....121	18061-75.....145
14559-11.....21	15030-14.....13	16060-11.....50	17021-13.....126	18035-01.....165	18062-12.....139
14568-09.....20	15031-14.....13	16101-10.....44	17022-13.....126	18035-02.....165	18062-13.....139
14568-12.....20	15032-08.....14	16102-11.....44	17023-13.....126	18035-03.....165	18063-13.....139
14569-09.....20	15032-13.....14	16103-11.....43	17370-53.....128	18035-05.....165	18064-20.....145
14569-12.....20	15033-09.....9	16104-14.....48	18000-00.....164	18035-35.....165	18065-20.....145
14574-09.....23	15036-14.....13	16104-19.....48	18000-01.....164	18035-50.....165	18067-11.....103
14574-11.....23	15037-14.....13	16105-16.....48	18000-02.....164	18035-80.....165	18080-01.....138
14575-09.....23	15040-11.....9	16106-14.....48	18000-03.....164	18036-19.....165	18080-02.....138
14575-11.....23	15042-11.....9	16107-14.....41	18000-04.....164	18036-22.....165	18080-03.....138
14958-09.....21	15070-08.....5	16109-14.....41	18000-10.....142	18036-24.....165	18090-00.....161
14958-11.....21	15071-08.....5	16120-14.....36	18000-15.....149	18038-45.....137	18105-01.....165
14959-09.....21	15110-08.....12	16121-14.....36	18000-18.....162	18039-45.....137	18105-03.....165
14959-11.....21	15111-08.....12	16130-15.....47	18000-20.....162	18040-00.....138	18106-01.....165
15000-00.....4	15123-12.....6	16140-11.....45	18000-30.....147	18040-11.....134	18131-12.....140
15000-01.....6	15124-12.....6	16141-11.....45	18000-35.....169	18040-14.....135	18132-12.....140
15000-02.....6	15300-00.....14	16142-11.....45	18000-45.....154	18040-22.....134	18144-30.....137
15000-03.....3	15370-50.....8	16143-12.....45	18000-46.....154	18040-33.....134	18155-13.....85
15000-04.....3	15370-52.....8	16144-13.....45	18000-50.....154	18050-28.....137	18196-10.....165
15000-08.....3	15371-92.....12	16150-24.....49	18000-51.....154	18050-35.....137	18200-01.....133
15000-10.....4	15396-00.....5	16152-11.....46	18004-18.....162	18050-50.....137	18200-02.....133
15000-11.....6	15396-01.....5	16152-12.....46	18004-23.....162	18051-28.....137	18200-03.....133
15000-12.....6	15400-12.....7	16152-15.....46	18004-27.....162	18051-35.....137	18200-04.....133
15001-08.....3	15401-12.....7	16220-14.....36	18004-50.....162	18051-50.....137	18200-05.....133
15002-08.....3	15514-12.....10	16221-14.....36	18010-00.....163	18052-01.....137	18200-06.....133
15003-08.....4	15610-08.....6	17000-01.....127	18010-01.....163	18052-02.....137	18200-07.....133
15004-08.....4	15615-08.....6	17000-02.....127	18010-02.....163	18052-03.....137	18200-08.....133
15005-08.....4	15617-08.....6	17000-03.....127	18019-00.....163	18052-12.....139	18200-09.....133
15006-09.....8	15650-11.....11	17000-04.....127	18019-01.....163	18053-28.....137	18200-10.....133
15007-08.....5	15651-11.....11	17001-07.....130	18019-02.....163	18054-28.....137	18200-11.....133
15008-08.....4	15750-11.....7	17002-02.....127	18020-00.....121	18055-01.....136	18200-12.....133
15009-08.....8	15751-11.....7	17003-03.....127	18020-01.....121	18055-02.....136	18200-20.....133
15010-09.....11	16000-14.....40	17004-03.....127	18020-02.....121	18055-03.....136	18200-50.....133
15010-10.....11	16001-15.....37	17004-05.....128	18020-03.....121	18055-04.....136	18320-11.....137
15011-12.....10	16002-18.....39	17005-03.....127	18020-20.....121	18055-05.....136	18374-43.....137
15012-12.....10	16004-16.....40	17005-04.....128	18020-30.....121	18055-06.....136	18374-44.....137
15013-12.....10	16005-16.....40	17006-05.....130	18020-40.....121	18056-14.....136	18403-11.....143
15015-11.....11	16015-17.....37	17007-08.....130	18020-50.....121	18057-14.....136	18406-11.....143
15017-10.....10	16016-17.....37	17008-07.....129	18020-60.....121	18060-20.....145	18406-13.....143
15018-10.....4	16020-14.....36	17009-07.....129	18020-70.....121	18061-10.....145	18555-01.....136
15019-10.....4	16021-14.....36	17009-08.....129	18025-10.....81	18061-15.....145	18555-02.....136

18555-03.....136	20840-03.....158	26016-12.....112	29066-02.....152	91121-20.....190	91400-12.....180
18555-04.....136	20842-03.....158	26018-17.....112	29066-03.....152	91121-25.....190	91400-14.....180
18601-15.....141	20850-00.....159	26029-10.....87	29066-04.....152	91123-12.....190	91401-10.....180
18602-15.....141	20850-10.....159	26030-10.....87	29071-01.....151	91123-14.....190	91401-12.....180
18603-14.....141	20850-11.....159	26100-00...50, 112	29071-02.....151	91123-16.....190	91401-13.....180
18961-15.....146	20890-51.....159	27000-01.....171	29071-03.....151	91126-15.....191	91401-14.....180
18961-17.....146	20890-71.....159	28000-07.....153	29071-04.....151	91127-12.....189	91402-10.....180
18961-18.....146	20890-72.....159	28000-10.....153	29071-05.....151	91128-15.....191	91402-12.....180
18961-20.....146	23005-10.....122	28000-12.....153	29071-06.....151	91138-15.....191	91402-13.....180
18961-75.....146	24201-00.....148	28001-00.....155	29071-07.....151	91139-09.....188	91402-14.....180
18961-85.....146	24201-01.....148	28001-02.....155	29071-08.....151	91139-12.....188	91404-12.....180
19003-00.....171	24212-01.....147	28015-15.....155	29080-00.....151	91150-20.....186	91404-13.....180
19003-01.....171	24212-02.....147	28015-25.....176	30051-10.....166	91156-11.....188	91404-14.....180
19007-05.....162	24214-02.....147	28020-20.....155	30076-14.....166	91162-12.....189	91405-10.....184
19007-07.....162	24215-02.....147	28020-28.....176	30085-15.....168	91194-10.....196	91405-11.....180
19007-09.....162	24220-00.....148	28030-02.....172	30085-30.....168	91194-13.....196	91405-13.....180
19007-14.....162	24220-10.....148	28030-03.....172	30087-00.....169	91195-09.....196	91405-14.....180
19007-21.....162	24220-50.....148	28030-04.....172	30087-20.....169	91195-11.....196	91408-14.....179
19007-29.....162	24220-90.....148	28030-10.....172	37000-00.....167	91195-13.....196	91409-15.....182
19008-07.....162	26000-25.....113	28030-20.....175	37500-00.....167	91196-13.....197	91410-17.....182
19008-09.....162	26000-30.....113	28030-25.....175	37500-05.....167	91197-00.....186	91411-17.....182
19008-14.....162	26000-35.....113	28040-30.....174	91003-12.....185	91201-13.....198	91413-14.....182
19009-00.....50	26000-40.....113	28050-30.....174	91004-13.....185	91204-16.....198	91413-18.....182
19009-05.....162	26000-45.....113	28050-35.....174	91100-12.....190	91303-10.....192	91413-20.....182
19009-07.....162	26000-50.....113	28080-10.....173	91100-13.....190	91304-14.....193	91416-14.....183
19009-09.....162	26000-55.....113	28080-90.....174	91100-14.....190	91304-16.....193	91417-18.....183
19010-00.....50	26000-60.....113	29000-00.....150	91100-16.....190	91305-14.....193	91419-14.....183
19010-01.....50	26000-65.....113	29000-10 150, 177	91100-17.....190	91305-16.....193	91427-12.....189
19010-10.....50	26000-70.....113	29008-01.....149	91102-12.....190	91308-12.....192	91460-11.....179
19010-11.....50	26001-25.....113	29008-12.....149	91102-13.....190	91309-12.....192	91460-12.....179
20311-21.....159	26001-30.....113	29008-22.....150	91102-14.....190	91316-14.....194	91461-11.....179
20325-00.....156	26001-35.....113	29015-50 150, 177	91102-16.....190	91316-16.....194	91461-12.....179
20325-10.....156	26001-40.....113	29025-01.....170	91106-12.....189	91317-14.....194	91468-12.....181
20350-00.....156	26001-45.....113	29025-02.....170	91108-12.....191	91317-16.....194	91476-09.....181
20810-01.....157	26001-50.....113	29026-10.....170	91108-14.....191	91318-14.....193	91500-09.....179
20810-02.....157	26001-55.....113	29027-00.....168	91110-10.....187	91319-14.....193	91501-09.....179
20820-00.....157	26001-60.....113	29051-45.....149	91113-10.....187	91322-14.....194	91601-11.....184
20830-00.....160	26001-65.....113	29055-00.....149	91115-10.....187	91323-14.....194	91604-09.....184
20830-01.....160	26001-70.....113	29060-00.....152	91117-10.....187	91328-14.....195	91606-07.....198
20830-02.....160	26002-10.....113	29060-01.....152	91118-12.....189	91328-16.....195	91700-03.....199
20830-03.....160	26002-15.....113	29060-02.....152	91119-12.....189	91329-14.....195	91706-05.....199
20830-04.....160	26002-20.....113	29060-03.....152	91121-12.....190	91329-16.....195	91790-16.....199
20830-05.....160	26007-01.....113	29060-04.....152	91121-13.....190	91330-14.....195	91791-16.....199
20830-06.....160	26007-02.....113	29060-05.....152	91121-14.....190	91331-12.....192	91815-11.....199
20831-10.....160	26007-03.....113	29060-06.....152	91121-15.....190	91331-14.....195	91850-35.....199
20840-01.....158	26007-04.....113	29066-00.....152	91121-16.....190	91393-16.....197	
20840-02.....158	26007-05.....113	29066-01.....152	91121-18.....190	91400-10.....180	

Alphabetical Index

A

Absorption Spears and Triangles	165
Adson forceps.....	88-89
Adson.....	88
Adson-Brown.....	89
Adson DeBakey.....	89
Adson-Graefe.....	89
Micro Adson.....	88
Micro Adson Fenestrated.....	88
Agricola retractor.....	128
Allis hemostatic forceps.....	101
Alm retractors.....	129
Applicators.....	
Micro serrefine.....	134-137
Suture clips.....	123-125
Applying forceps, clamp.....	135-136
Arc blade.....	58
Arteriotomy knives.....	52-53, 55-56
Artery scissors.....	27
Austin Chisel.....	51
AutoClip® System.....	125

B

Baby-Beyer.....	39
Baby-Mixter hemostatic forceps.....	99
Backhaus towel forceps.....	100
Balanced Instruments.....	141
Ball Tipped.....	
Scissors.....	27
Spring Scissors.....	9
Beebee bone scissors.....	46
Beyer rongeurs.....	39
Biemer spring scissors.....	14
Bishop-Harman forceps.....	83
Bonn-Strabismus scissors.....	15
Blade.....	
Breakers.....	57
Cartridges.....	63
Holders.....	56-63
Blades.....	
Breakable.....	57
Ceramic.....	56
Scalpel.....	55-63
Blair retractor.....	126
Boehler bone cutter.....	47
Bone.....	
Cutters.....	42-49

Delicate scraper.....	51
Forceps.....	50
Nipper.....	44-45
Pliers.....	49
Rongeurs.....	36-41
Scissors.....	46
Scissors, Student.....	184
Scraper.....	51
Screw forceps.....	50
Screws, self-tapping.....	50
Shears.....	49
Wax.....	50
Bone cutters.....	
Beebee.....	46
Bone Trimmers.....	41
Boehler.....	47
Cartilage Cutter.....	41
Cleveland.....	48
Dumont carbon steel.....	42
Dumont epoxy coated.....	42
Liston.....	48
Littauer.....	46
Malleus Nipper.....	45
Micro.....	43
Offset Bone Nipper.....	44
Skull Flap.....	47
Spring Scissors.....	45
Tungsten Carbide.....	43, 46
Bone Nipper.....	44
Bonn.....	
Artery.....	27
Forceps.....	80
Micro probes.....	104
Scissors.....	15, 27
Strabismus.....	15
Book and DVD-Suturing Principles.....	122
Bowman retractor.....	130
Brush.....	165
Bulldog clamps.....	137
Burrs.....	162

C

Calipers.....	
Castroviejo.....	169
Digital electronic.....	169
Cane blade Plastic Vernier.....	169
Cannulation aids.....	58
Cartilage Cutter.....	139-143
Cases, instrument.....	41
Castroviejo.....	157-160

Caliper.....	169
Needle holders.....	114-115
Spring scissors.....	8-11
Cauterizers, vessel.....	163-164
Ceramic.....	
About.....	203
Blades.....	56
Cutter.....	166
Dumont forceps.....	65, 71
Scissors.....	21
Spring scissors.....	7, 11
Titanium.....	11
Chisels.....	
Austin.....	51
Dissecting.....	51
Circle forceps.....	87
Circle knife.....	53
Clamps.....	
Applying forceps.....	135-136
Bulldog Artery Spring Clamps.....	137
Bulldog Type Serrefines.....	137
Dietrich Bulldog Clamps.....	137
Double Micro Clamps.....	134
Mini Serrefines.....	137
Moria.....	137
S&T.....	134
Schwartz Micro Serrefines.....	137
Silver Neuro Clips.....	138
Titanium.....	136, 137
Towel.....	100-101
Vascular.....	134, 136-137
Vascular Occluders.....	138
Cleveland bone cutters.....	48
Clip-On LED Light.....	175
Clipper style scissors.....	14
Cohan-Vannas spring scissors.....	6
Colibri retractor.....	127
Colibri retractor (mini).....	127
Combination Probe and Spatula.....	107
Combination Spoon and Spatula.....	107
Contacts, Gold wire.....	171
Corers, sample.....	165
Cover glass forceps.....	86
Cover slip forceps.....	69
Crile hemostatic forceps.....	98
Crile-Wood needle holders.....	118
Curettes, micro.....	51

D

DeBakey forceps.....	89
----------------------	----

Decapitation scissors.....	35
Demagnetizer.....	149
Diamond coated forceps.....	75
Diamond knives.....	56
Dietrich bulldog clamps.....	137
Digital Electronic Caliper.....	169
Dilator, vessel.....	140-141
Disposable safety scalpels.....	62-63
Disposable scalpel box.....	61
Dissecting Chisel.....	51
Dissecting knives.....	52-53
Double-Ended Micro Spatula.....	108
Double Micro Clamps.....	134
Double pronged tissue pick.....	103
Double tip protectors.....	152
Dowell spring scissors.....	9
Dressing forceps.....	84, 90-91
Dumont.....	
Bone Cutter.....	42
Ceramic.....	65, 71
Coverslip.....	69
Epoxy.....	42, 72-73
Forceps.....	65-74, 143
Forceps repair kit.....	150
Forceps sharpening stones.....	150
Laminectomy.....	72
Mini Forceps.....	74
Slide Lock.....	69
Super Fine Tip.....	65
Teflon.....	69
Titanium.....	67, 71
Tweezers.....	65-74, 143
Dura cutting knife.....	52
Dura hook.....	103
E	
Ear.....	
Punches.....	147
Tags.....	148
Tattoo system.....	148
Electronic timers.....	171
Etched micro needles.....	113
Eschenbach magnifiers.....	174-176
Extra Fine Bonn.....	15
Explorers.....	105
F	
Feeding needles.....	145-146
File set.....	166
Filters, sterilization.....	159

Fine.....	
Bonn.....	15
Forceps.....	77-84
Iris Scissors.....	16-18
Scissors.....	15-35
Spring scissors.....	3-14
Fine Hemostat.....	96
Fixation forceps, Pierse.....	85
Fomon retractor.....	126
Forceps.....	
Adson.....	88-89
Adson-Brown.....	89
Adson DeBakey.....	89
Adson-Graefe.....	89
Applying and removing.....	123
Bishop-Harman.....	83
Bone.....	50
Bonn.....	80
Cannulation.....	143
Ceramic.....	65, 71
Circle.....	87
Cover glass.....	86
Cover slip.....	69
Cross action.....	86
Diamond coated.....	75
Dressing.....	84, 90-91
Dumont.....	65-74, 143
Epoxy coated.....	72-73
Fine.....	77-84
Fixation.....	85
Gerald.....	94
Gillies.....	93
Gold plated.....	75
Graefe.....	83
Grasping.....	82
Hemostatic.....	96-101
Insect handling.....	87
Laminectomy.....	72
London.....	94
Micro.....	65-79
Mirror Finish.....	67, 76-77, 80-81
Moria.....	78
Mouse laminectomy.....	72
Mouse handling.....	91
Narrow Pattern.....	90
Octagon.....	83
Organ holding.....	93
Pierse fixation.....	85
Pin & bone screw holding.....	50, 112
Plastic.....	76, 86
Potts-Smith.....	95

Repair kit.....	150
Replaceable tip.....	76
Ring.....	87
Russian.....	93
S&T.....	79, 81, 135, 143
Self-Closing.....	77
Semken.....	91
Standard Forceps.....	85-95
Standard Pattern.....	90
Student.....	186-191
SuperGrip.....	79
Suture tying.....	80-82
Taylor.....	95
Titanium.....	67, 71, 84, 90, 94
Tungsten carbide.....	88
Vitro Grasping.....	82
Vial.....	82
Friedman rongeur.....	40
Friedman-Pearson rongeur.....	36

G	
Galilean Loupes.....	174
Gavage feeding needles.....	145
Gelpi retractor.....	130
GenoPunch.....	147
Gerald forceps.....	94
Gillies forceps.....	93
Gold plated forceps.....	75
Gold wire contacts.....	171
Goldstein retractor.....	127
Graefe forceps.....	83
Graefe knife.....	52
Grasping forceps.....	82
Grease, silicone.....	149
Gross anatomy.....	
Knives.....	54
Probe.....	107
Scalpel.....	62
Scissors.....	29-35
Guthrie retractor.....	126

H	
Halsey needle holders.....	
Halsted-Mosquito hemostatic forceps.....	97
Handles, scalpel.....	58-63
Hardened Fine Iris Scissors.....	16
Hartman hemostatic forceps.....	100
Headband magnifier.....	172
Headband, spectacles.....	174

Heiss retractor.....	131
Hemostatic forceps.....	
Allis Clamp.....	101
Baby-Mixer.....	99
Backhaus Towel Clamp.....	100
Crile.....	98
Fine.....	96
Halsted-Mosquito.....	97
Hartman.....	100
Kelly.....	98
Left-handed.....	97
Lorna Clamp.....	101
Micro-Mosquito.....	97
Providence-Hospital.....	99
Smooth.....	96
Student.....	192-197
Ultra Fine.....	96
High-temp cauterizer.....	163-164
Hippocampal dissecting tools.....	110
Holders.....	
Blade.....	54-63
Ceramic blade.....	56
Micro needle.....	114
Needle.....	114-119
Pin.....	112
Scalpel blade.....	54-63
Student.....	198
Hooks.....	
Micro.....	105-16
Spinal cord.....	103
Y-Hook.....	106
V-Hook.....	139
Hot bead sterilizers.....	154

I	
Identification, animal.....	
Tattoo system.....	148
Ear punches.....	147
Ear tags.....	148
Insect.....	
Handling forceps.....	87
Pins.....	113
Insert.....	
Pin holders.....	112, 198
Pins.....	113
Instrument.....	
Beaker.....	161
Cases.....	157-160
Holding spring.....	161
Oil and Oil Pen.....	149

Sharpening Stones.....	149-150
Tape, identification.....	151
Tip protectors.....	152
Iridectomy scissors.....	3-14
Iris Spatulae.....	108

K

Kaye scissors.....	28
Kelly hemostatic forceps.....	98
Knives.....	
Circle.....	53
Diamond.....	56
Dura cutting.....	52
Gross anatomy (blade).....	54
Micro.....	52-53
Sichel.....	52
Stone age.....	55
Von Graefe.....	52

L

LaGrange scissors.....	25
Laminectomy forceps, mouse.....	72
Large Loops.....	19, 28, 31
Left-handed.....	
Fine scissors.....	17
Hemostatic forceps.....	97
Ligation aid.....	139
Needle holders.....	117-118
Surgical scissors.....	29
Universal scissors.....	167
Lempert rongeur.....	40
Lens paper.....	150, 177
Lexer-Baby scissors.....	22
Ligation aid.....	139
Ligature scissors.....	26
Lister scissors.....	31
Liston gross anatomy cutter.....	48
Littauer bone cutter.....	46
Live Insect Handling Forceps.....	87
Low-temp cauterizer.....	163
Lorna Clamp.....	101
Lubricant, silicone.....	149
Luer rongeur.....	37

M

Magnetic sterilization mat.....	156
Magnifiers.....	
Eschenbach Clip-On LED Light.....	175
Galilean Loupes.....	174

Headband.....	174
Interchangeable Headset with LED.....	173
Magnifying Loupe with Micrometer.....	
and LED.....	170
Spectacles.....	172-175
Stands.....	176
Scribolux.....	176
Vario Flex.....	176
Malleus Nipper.....	45
Mandrel.....	162
Maniplier®, skin stapler.....	124
Manual and DVD, Suturing Principles and Techniques in Laboratory Animals.....	122
Marker, skin.....	147
Mat, silicone.....	156
Mathieu needle holder.....	115
Max Detail spectacles.....	175
Mayo scissors.....	34
Mayo-Hegar needle holder.....	118
Mayo-Noble scissors.....	35
Mayo-Stillie scissors.....	35
Metzenbaum scissors.....	
Baby scissors.....	32
Scissors.....	33
ToughCut Metzenbaum.....	33
Tungsten Carbide Metzenbaum Fino.....	32
Michel suture clips.....	123
Micro-.....	
Bone cutter.....	43
Brush.....	165
Cannulation System.....	142
Curettes.....	51
Dissecting knives.....	52-53
Dissection scissors.....	3-14
Forceps.....	65-79
Hooks.....	105-106
Needles, etched.....	113
Needle holders.....	114
Needles and sutures.....	120-121
Points.....	104, 106
Probes.....	104, 106
Rongeurs.....	36-37
Serrefine applicators.....	135-136
Serrefines.....	134, 136
Spatulae.....	106-109
Micrometers.....	170
Micro-Mosquito Hemostat.....	97
Mini-Biemer spring scissors.....	14
Mini-Colibri retractor.....	127
Mini-Lister.....	31

Mini-Vannas spring scissors	5
Minutien pins	113
Mirror finish	
Cutting spoon	111
Forceps	67, 77
Micro spatula	108
Suture tying forceps	80-81
Moria	
Forceps	78
Instrument case	159
Pin holders	112
Retractors	128
Scissors	18
Spoons	111
Spring scissors	5, 8, 12
Vascular clamps	137
Mosquito hemostatic forceps	97
Mouse	
Feeding needles	145-146
Laminectomy forceps	72
Handling forceps	91
N	
Narrow Pattern Forceps	90-91
Needle Holders	
Castroviejo	114
Castroviejo with Tungsten Carbide Jaws	115
Crile-Wood	118
Halsey	116
Halsey with Tungsten Carbide Jaws	116
Mathieu	115
Mayo-Hegar	118
Needle Holder with Suture Cutter	114
Olsen-Hegar with Suture Cutter	117
Round Handled	114
Ryder Mini-Select Needle Holder	119
Slim Elongated Needle Holder	119
Needles	
Etched, micro	113
Feeding	145-146
Micro needles and sutures	120-121
Neuro punches	165
Neuro clips, silver	138
Noyes spring scissors	10
Nylon suture thread	121
O	
Obsidian scalpels	55

Occluders, vascular	138
Octagon Forceps	83
Offset Bone Nipper	44
Oil, instrument	149
O-rings for forceps	74
Olsen-Hegar needle holders	117
Optical cleaning kit	150, 177
Organ holding forceps	87

P

Pascheff-Wolff spring scissors	12
Pearson rongeur	36
Pen, skin marker	147
Perforated Spoons	111
Pick	
Double Pronged Pick	103
Pierse fixation forceps	85
Pin holders	112
Pins	
Etched Tungsten Micro Needles	113
Insect	113
Insert	113
Minutien	113
Plastic cases	157-158, 160
Plastic forceps	86
Plastic sterilization container	157-158
Plastic Vernier Caliper	169
Potts-Smith forceps	95
Pouches, sterilization	153
Probes	
Bonn Micro Probes	104
Combination Probe and Spatula	107
Gross Anatomy Probe	107
Micro Hooks	105-106
Micro Points	104, 106
Probes and Explorers	105
Vessel Dilating Probe	107
Providence-Hospital hemostatic forceps	99
PTFE feeding needles	146
Punches	
Ear	147
Neuro	165

R

Repair kit, forceps	150
Replaceable tips/tip forceps	76
Retractors	
Agricola	128
Alm Retractors	129

Blade	127-130
Blair	126
Bowman	130
Colibri	127
Fine Adjustable Wire Retractor	128
Fomon	126
Heiss	131
Gelpi	131
Goldstein	127
Guthrie	126
Large	128-132
Mini-Goldstein	127
Mini-Colibri	127
Moria	128
Slide	127
Small	127
Speculum	128
Spring-Loaded	130
Student	199
Systems	133
Weitlaner-Locktite	132
Wire	128
Wullstein	132
Ring forceps	87
Roll up travel case	160
Rongeurs	
Baby-Beyer	39
Beyer	39
Bone	36-40
Friedman	40
Friedman-Pearson	36
Lempert	40
Luer	37
Micro	36
Pearson	36
Round Handled	
Needle holder	114
Spring scissors	7
Suture tying forceps	82
Rulers	
Label Tape	168
Steel	168
Russian forceps	93

S

S&T	
Cannulation forceps	143
Forceps	79, 81, 135, 140, 143
Instrument beaker	161
Micro needles and suture	120

SuperGrip forceps.....	79	Student Lister.....	182	Angled.....	3-4, 6, 8-13
Suture tying forceps.....	81	Surgical.....	29-35	Ball Tipped.....	9
Vascular clamps.....	134	Titanium.....	6	Biemer.....	14
Vessel dilator.....	140	ToughCut.....	6, 15, 20, 30, 33-34	Bone Cutter.....	45
Safety scalpel.....		ToughCut with tungsten carbide.....	21	Castroviejo.....	8-11
Blade cartridges.....	63	Tungsten carbide...10, 20-21, 23, 30-32, 34		Ceramic coated.....	7, 11
Disposable.....	62	Universal.....	167	Clipper Scissors II.....	14
Handle.....	63	Utility.....	167	Cohan-Vannas.....	6
Sample corers.....	165	Vitrectomy.....	13	Dowell.....	9
Saw, Circular.....	162	Walton.....	24	Extra fine.....	3-5, 12-13
Scalpel.....		Screwdrivers.....	166	Iridectomy.....	3-14
Blade handles.....	56-63	Screws, self-tapping.....	50	Mini-Vannas.....	3-5
Blade removers.....	61	Secure scalpel handle.....	60	Moria.....	5, 8, 12
Blades.....	56-60	Self closing forceps.....	77	Noyes.....	10
Ceramic blades.....	56	Self Holding Pin and Bone Screw Forceps.....	50	Pascheff-Wolff.....	12
Disposal Box.....	61	Self-Sealing Sterilization Pouches.....	153	Round Handled.....	7
Disposal Safety.....	62	Semken forceps.....	91	Serrated.....	5
Gross anatomy.....	62	Serrefines.....	136-137	Student Vannas.....	179
Safety Scalpels.....	62-63	Sharpening stones.....	148-149	Titanium Vannas.....	6
Stone age.....	55	Shea scissors.....	25	ToughCut.....	6
Schwartz micro serrefine.....	137	Shears, bone.....	49	Trident II.....	12
Scissors.....		Sichel knife.....	52	Vannas.....	3-8, 179
Bone.....	46	Silicone lubricant.....	149	Vannas-Miniature.....	6
Bonn.....	15, 27	Silicone mats.....	156	Vannas-Tubingen.....	4
CeramCut.....	21	Silicone tips, forceps.....	91	Vannas-Wolff.....	8
Clipper.....	14	Silk sutures.....	121	Vessels.....	14
Decapitation.....	35	Skin marker.....	147	Vitrectomy.....	13
Dissector.....	26	Skin staplers.....	124-125	Wescott.....	11
Dowell.....	9	Skull flap cutter.....	47	Spring, instrument holding.....	161
Fine.....	15-28	Slide retractors.....	127	Stage micrometers.....	170
Kaye.....	28	Spatulae.....		Standard Pattern Forceps.....	90
LaGrange.....	25	Combination Spoon and Spatula.....	107	Standard Pattern Scissors.....	
Large loops.....	19, 28, 31	Combination Probe and Spatula.....	107	Large Loops.....	31
Left-handed.....	17, 29, 167	Double-Ended Micro Spatula.....	108	Scissors.....	29-31
Lexer-Baby.....	22	Hippocampal Dissecting Tool.....	110	Serrations.....	30
Ligature.....	26	Iris Spatulae.....	108	ToughCut.....	30
Lister.....	31	Micro Spatula.....	106, 108	Tungsten Carbide.....	30
Mayo.....	34	Micro Spatula Kit.....	109	Staplers, skin.....	124-125
Mayo-Noble.....	35	Mini Hippocampal Dissecting Tool.....	110	Sterilizers, hot bead.....	154
Mayo-Stille.....	35	Mirror Finish Micro Spatula.....	108	Sterilizing containers.....	157-159
Metzenbaum.....	32-33	Spears, absorption.....	165	Sterilizing mats.....	156
Mini-Lister.....	31	Spectacles Headband.....	174	Sterilizing pouches.....	153
Moria.....	5, 7, 12, 18	Spectacles, magnifier.....	172-175	Sterilizing wraps.....	155
Shea.....	25	Spencer Ligature.....	26	Stevens tenotomy scissors.....	24
Spencer Ligature.....	26	Spinal Cord Hook.....	103	Stone Age Scalpels.....	55
Spring.....	3-14	Spoons.....		Strabismus.....	23
Standard Pattern.....	29	Mini Perforated Spoon.....	111	Student.....	
Stevens Tenotomy.....	24	Mirror Finish Cutting Spoon.....	111	Adson, micro, -Brown forceps.....	189
Strabismus.....	23	Moria Spoon.....	111	Babcock clamp.....	197
Student.....	179-184	Perforated Spoon.....	111	Backhaus towel clamp.....	196
		Spring scissors.....		Barraquer retractor.....	199

Bone Scissors.....	184	Laboratory Animals, Manual and DVD .	122	Forceps.....	88
Bone Cutter.....	184	Thread.....	120-121	Mayo.....	34
Clamps.....	199	Tying forceps.....	80-82	Metzenbaum Fino.....	32
Crile hemostat.....	193	With needle and thread.....	120	Needle holders.....	115-119
Dieffenbach clamp.....	199	Swabs.....		Noyes.....	10
Dumont forceps.....	186	Fiber Optic.....	165	Scissors.....	10, 20-21, 23, 30-32, 34, 46
Feilchenfeld forceps.....	188	T		Scissors with ToughCut.....	21
Forceps.....	186-191	Tags, Ear.....	148	Standard Pattern.....	30
Gillies forceps.....	191	Tape.....		Strabismus.....	23
Halsey needle holder.....	198	Dispenser.....	155	Tweezers, Dumont.....	65-74, 143
Halsted-Mosquito hemostat.....	192	Identification.....	151	U	
Hartmann hemostat.....	192	Sterilization.....	155	Ultra Fine Clipper Scissors II.....	14
Hemostatic forceps.....	192-197	Ruler Label.....	168	Ultra Fine Hemostat.....	96
Instruments, About.....	203	Tattoo system.....	148	Utility scissors.....	167
Kelly hemostat.....	193	Taylor forceps.....	95	V	
Kocher hemostat.....	195	Timers.....	171	Vannas spring scissors.....	3-8, 179
Lister scissors.....	182	Tip protectors.....	152	Vannas-Miniature spring scissors.....	5
Lorna towel clamp.....	197	Tip Replacement.....	91	Vannas-Tubingen spring scissors.....	4
Mayo scissors.....	182	Tissue.....		Vannas-Wolff spring scissors.....	8
Mayo-Hegar needle holder.....	198	Pick.....	103	Vascular clamps.....	134, 136-137
McIndoe forceps.....	191	Scissors.....	27	Vascular occluders.....	138
Metzenbaum, baby scissors.....	183	Titanium.....		Vernier caliper.....	169
Needle holder.....	198	About.....	203	Vessel cannulation aids.....	140-143
Ochsner-Kocher hemostat.....	195	Artery clamp.....	137	Vessel cauterizer.....	163-164
Pean hemostat.....	194	Ceramic.....	11	Vessel dilating probe.....	107
Pin holder.....	198	Forceps.....	67, 71, 84, 91, 94	Vessel dilators.....	107, 140-141
Retractor.....	199	Micro Point.....	106	Vessel spring scissors.....	14
Rochester-Pean hemostat.....	194	Micro Spatula.....	106	Vetro grasping forceps.....	82
Russian forceps.....	191	Scissors.....	6, 11	Vial forceps.....	82
Sanvenero scissors.....	179	Serrefines.....	136	VisorLight.....	172
Scalpel handle.....	185	Vascular Clamps.....	136-137	Vitreotomy scissors.....	13
Scissors.....	179-184	Y-Hook.....	106	V-Hook.....	139
Semken forceps.....	191	Tools.....	166-167	Von Graefe knife.....	52
Senn-Miller retractor.....	199	ToughCut.....		W	
Spencer ligature scissors.....	181	About.....	203	Wagner.....	19
Splinter forceps.....	188	Bonn-Strabismus.....	15	Walton.....	24
Spring scissors, Vannas.....	179	Mayo.....	34	Wax.....	50
Tohoku towel clamp.....	196	Metzenbaum.....	33	Weitlaner-Locktite retractor.....	132
Vessel dilator.....	199	Scissors.....	6, 15, 20, 30, 33-34	Westcott spring scissors.....	11
Wagner scissors.....	181	Spring scissors.....	6	Wire contacts, gold.....	171
SuperGrip forceps.....	79	Scissors with tungsten carbide.....	21	Wire teeth retractor.....	129
Surgical scissors.....	29-35	Standard Pattern.....	30	Wound Closure.....	114-125
Left-handed.....	29	Travel case.....	160	Wraps, sterilization.....	155
Surgery plate.....	133	Trephines.....	162	Wullstein retractor.....	132
Suture.....		Trident II spring scissors.....	12		
Clips, AutoClip.....	125	Tungsten needles, etched.....	113		
Clips, Michel.....	123	Tungsten carbide.....			
Needles.....	120-121	About.....	203		
Nylon.....	121	Burrs.....	162		
S&T micro needles and suture.....	120	Cutter.....	43		
Suturing Principles and Techniques in.....					

Fine Science Tools Online

Helping you find and buy the right tools

Whether you contact us at our offices, through dealers, or online—our priority is customer service. As part of that service, we have a variety of features to help you research, quote, and purchase Fine Science Tools products at **finescience.com**. These features enhance and streamline your shopping experience by helping you:

- Quickly identify products by type and attributes with advanced search
- Get detailed specs and enlarged product views
- Use the extensive FAQs and pop-up glossary
- Save quotes and convert to orders online
- Pay with credit card or purchase order*
- View your online order history
- Track your shipments

*Payment by purchase order is available only for customers with a Net 30 account.

Our website is more engaging and informative than ever.



Zoom
Feature



High-Resolution
Images



Multi-Language
Support



Updated
Event Listings

We are continuously adding new products to our inventory.
Visit **finescience.com** to view all of our products.

Featured Products Online

Our Featured Products are available in limited quantities, for a limited time while supplies last. Please visit our website, **finescience.com** for updates on what's new and currently available.

All of our European suppliers are ISO 9001 certified.

All FST surgical instruments are made from the finest German stainless steel alloys (unless otherwise noted) and manufactured by skilled European craftsmen.

Most surgical instruments are shown actual size. As these instruments are handcrafted, dimensions may vary slightly from those stated in this catalog.

THE INFORMATION IN THIS CATALOG IS ACCURATE TO THE BEST OF OUR KNOWLEDGE. DESIGNS, STYLES AND DIMENSIONS DEPICTED IN THIS CATALOG ARE SUBJECT TO CHANGE WITHOUT NOTICE. ALL RECOMMENDATIONS OR SUGGESTIONS ARE MADE WITHOUT GUARANTEE, AND WE DISCLAIM ANY LIABILITY INCURRED IN CONNECTION WITH ANY RECOMMENDATION. WITH THE PURCHASE OF ANY PRODUCT FROM THIS CATALOG THE USER ASSUMES ALL RISKS AND LIABILITIES WHATSOEVER IN THE USE OF SUCH PRODUCTS. NEITHER SELLER NOR MANUFACTURER SHALL BE LIABLE IN TORT OR CONTRACT FOR ANY LOSS OR DAMAGE (DIRECT, INCIDENTAL, OR CONSEQUENTIAL) ARISING OUT OF THE USE, MISUSE, OR INABILITY TO USE SUCH PRODUCT.

FST IS A REGISTERED TRADEMARK OF FINE SCIENCE TOOLS INC. FINE SCIENCE TOOLS, TOUGH CUT, CERAMA CUT, AND FINE SURGICAL INSTRUMENTS FOR RESEARCH ARE TRADEMARKS OF FINE SCIENCE TOOLS INC. FST, TOUGH CUT, AND CERAMA CUT ARE REGISTERED TRADEMARKS OF FINE SCIENCE TOOLS (USA) INC. FINE SCIENCE TOOLS AND FINE SURGICAL INSTRUMENTS FOR RESEARCH ARE TRADEMARKS OF FINE SCIENCE TOOLS (USA) INC. FINE SCIENCE TOOLS AND FST ARE REGISTERED TRADEMARKS OF FINE SCIENCE TOOLS GMBH.

© COPYRIGHT 2021 THE TEXT, PHOTOS AND DRAWINGS CONTAINED IN THIS CATALOG ARE PROPRIETARY TO FINE SCIENCE TOOLS INC. AND MAY ONLY BE COPIED, DUPLICATED OR OTHERWISE REPRODUCED WITH THE WRITTEN CONSENT OF FINE SCIENCE TOOLS INC.



Scissors, Bone Instruments,
Knives & Scalpels
pages 3 – 63



Forceps & Hemostats
pages 65 – 101



Probes, Needle Holders, Thread,
Retractors & Clamps
pages 103 – 143



Surgical & Laboratory
Accessories
pages 145 – 177



Student Quality Instruments
pages 179 – 199

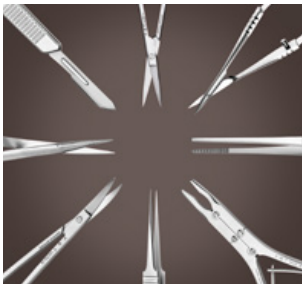

Reference Pages
pages 201 – 220



INTERNATIONAL

Fine Science Tools Inc.

410-197 Forester Street
North Vancouver, British Columbia
Canada V7H 0A6

Telephone +1 800-665-5355 / +1 604-980-2481

Fax +1 800-665-4544 / +1 604-987-3299

E-Mail canada@finescience.com

Web finescience.ca



Fine Science Tools (USA) Inc.

4000 East 3rd Avenue, Suite 100
Foster City, CA 94404-4824
USA

Telephone +1 800-521-2109 / +1 650-349-1636

Fax +1 800-523-2109 / +1 650-349-3729

E-Mail info@finescience.com

Web finescience.com



Fine Science Tools GmbH

Vangerowstraße 14
69115 Heidelberg
Germany

Telephone +49 62 21 - 90 50 50

Fax +49 62 21 - 90 50 590

E-Mail europa@finescience.de

Web finescience.de

F · S · T
FINE SCIENCE TOOLS