



Innovative  
Design & Quality from  
**DENMARK**

---

**ELCOLD – YOUR PARTNER – ALL THE  
WAY FROM DESIGN TO DELIVERY  
AND AFTER SALE SERVICE**

Our vision is to make a partnership with our customers – not only for the first delivery, but on a long term range.

To do this, we supply supreme quality, where you can expect the cooler or freezer to run for years once you have plugged it in.

But for us, supreme quality is not related only to the product itself. It also includes short and reliable delivery time, precise communication, short response time on standard requests and follow up on current projects.

Parallel, we are supported by the ISO 9001-2015 Quality Assurance System as well as the ISO 14001-2015 Environmental Management System. This gives both our customers and Elcold the best chances to continue business for many years.

# MANAGEMENT SYSTEM CERTIFICATE

Certificate No:  
197889-2016-AE-DEN-DANAK

Initial certification date:  
30, March, 1994

Valid:  
02, May, 2019 - 15, April, 2022

This is to certify that the management system of

**Elcold Fryserne, Hobro ApS**  
Løgstørvej 81, 9500, Hobro, Denmark

has been found to conform to the Management System standards:

**ISO 9001:2015 & ISO 14001:2015**

This certificate is valid for the following scope:

**Development, production and sale of refrigerators and freezers for household- and commercial use, wholesale of refrigerators and freezers**

Place and date:  
Hellerup, 02, May, 2019



For the issuing office:  
DNV GL - Business Assurance  
Tuborg Parkvej 8, 2., DK-2900, Hellerup,  
Denmark

**Jesper Schultz**  
Management Representative

Lack of fulfilment of conditions as set out in the Certification Agreement may render this Certificate invalid.

ACCREDITED UNIT: DNV GL Business Assurance Denmark A/S, Tuborg Parkvej 8, DK-2900 Hellerup, Denmark. TEL: +45 39 45 48 00.  
<http://www.dnvgl.com/assurance>



# TABLE OF CONTENTS

## ICE CREAM & DISPLAY FREEZERS

FOCUS .....	8
FOCUS V .....	10
SCOOP .....	11
NOVA .....	12
CUBE .....	14
DUO .....	16
MOBILUX .....	17
CVG .....	18
EL .....	20
EL SS .....	22
UNI .....	24
UNI-S .....	26
VISION .....	28

## HOUSEHOLD & DOMESTIC FREEZERS

XLE .....	32
PRO for Tuna fish .....	34

## SUPERMARKET FREEZERS

DSM .....	38
ESM .....	40
GSM .....	42
FSM .....	44

## DISPLAY COOLERS

EBC COOLER .....	48
CAN COOLER & ESC .....	50
COMBI .....	51

## LABORATORY & MEDICAL EQUIPMENT

LAB .....	54
VAC .....	56
PRO .....	58
UNI .....	60

## ACCESSORIES

BASKETS .....	62
SUPERMARKET FREEZERS ...	65
ADDITIONAL EQUIPMENT ..	66

### GENERAL EXPLANATION:

Throughout this book, we inform about different climate classes.  
Our information is based on the following:

Climate class 4:	30 degree Celsius / 55 % Relative Humidity
Climate class 7:	35 degree Celsius / 70 % Relative Humidity
Climate class 5:	40 degree Celsius / 70 % Relative Humidity

All contents and temperatures are based on measurements made in the load line according to EN 23953 and EN 16901.

Some photos may contain parts which are not supplied as standard.







ICE CREAM  
& DISPLAY  
FREEZERS



# | FOCUS |

## ICE CREAM & DISPLAY FREEZER

With the FOCUS freezer, Elcold has succeeded to design two very different parameters into one unit: Elegance but still robust. The result is an optimal way to catch the attention of your customers. The lid design, the improved insulation and the heated frame ensure minimum ice build-up.

## FEATURES

- HC refrigerants as standard
- Heating wire and extra hot pipe in the top frame to prevent condensation
- Environmentally friendly
- Low service costs
- Perfect view to the products
- Long life
- Available in all climate classes
- Minimum icebuild-up
- Designed for transport
- Eye Catching design
- 75 mm insulation
- Also available as combination of cooler and freezer
- Accessories including baskets - see page 62
- Graphics (option)
- LED internal light (option)



FOCUS 73 GREY



FOCUS 106 BLUE



FOCUS 131 RED



LED LIGHT FOR FOCUS



FOCUS 151 RED



FOCUS 171 BLUE



# THINK GREEN

SAVE UP TO 30% ENERGY

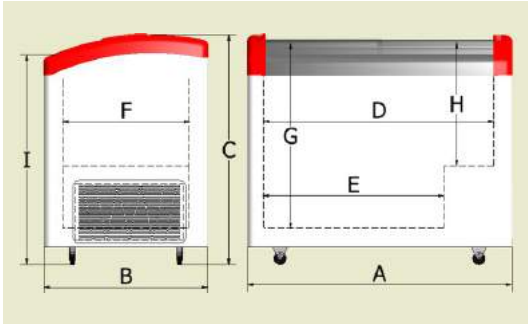

Dimensions according to technical data below

Heavy investment in new technology has resulted in very low energy consumption and use of the environmental friendly hydro carbon gas. Cyclopentane is used as blowing agent.

### TYPICAL CONFIGURATION OF VENTILATION GRIDS



	FOCUS 73	FOCUS 106	FOCUS 131	FOCUS 151	FOCUS 171
Climate class 4	4	4	4	4	4
Ambient temperature range	+16 to +30	+16 to +30	+16 to +30	+16 to +30	+16 to +30
Climate class 4+	4+	4+	4+	4+	4+
Ambient temperature range	+16 to +35	+16 to +35	+16 to +35	+16 to +35	+16 to +35
Gross volume, litres	161	270	352	418	484
Net volume, litres	113	193	254	302	351
Temperature range inside unit	-16 to -23	-16 to -23	-16 to -23	-16 to -23	-16 to -23
Refrigerant	R600a	R600a	R600a	R290	R290
Energy consumption / 24 h kwh at 30 deg. C	1,8	2,3	3,2	3,5	4,5
AE-Annual Energy consumption, kwh	664	926	1033	1293	1545
EEl-Energy Efficiency Index	54,90%	67,90%	66,10%	68,20%	74,60%
EC-Energy Class	D	E	E	E	E
Input power (watt)	141	153	203	204	230

### DIMENSIONS

External dimensions (WxDxH)	726*656*850	1056*656*850	1306*656*850	1506*656*850	1706*656*850
Internal dimensions (WxDxH)	570*500*670	900*500*670	1150*500*670	1350*500*670	1550*500*670
Dimension A	726	1056	1306	1506	1706
Dimension B	656	656	656	656	656
Dimension C	850	850	850	850	850
Dimension D	570	900	1150	1350	1550
Dimension E	370	700	950	1150	1350
Dimension F	500	500	500	500	500
Dimension G	670	670	670	670	670
Dimension H	420	420	420	420	420
Dimension I	760	760	760	760	760
Insulation (mm)	75	75	75	75	75

### ACCESSORIES

Dividers	Optional	Optional	Optional	Optional	Optional
Max. number of baskets (model C75-01/C75-02)	2/3	4/4	5/6	6/7	7/8
Castors	Incl.	Incl.	Incl.	Incl.	Incl.
Castors w. brakes	Optional	Optional	Optional	Optional	Optional
Lock	Optional	Optional	Optional	Optional	Optional
Thermometer	Optional	Optional	Optional	Optional	Optional
Internal light	Optional	Optional	Optional	Optional	Optional

### OTHER DATA

Outer cabinet	White	White	White	White	White
Inner cabinet	Aluminium	Aluminium	Aluminium	Aluminium	Aluminium
Inner cabinet: option	Steel inner liner	Steel inner liner	Steel inner liner	Steel inner liner	Steel inner liner
Graphics	Optional	Optional	Optional	Optional	Optional
Type of cooling	Static	Static	Static	Static	Static
Type of defrost	Manual	Manual	Manual	Manual	Manual
Power	220V/50Hz	220V/50Hz	220V/50Hz	220V/50Hz	220V/50Hz
Power 110volt / 60Hz	Optional	Optional	Optional	Optional	Optional
UL approval / DOE approval	Yes	Yes	Yes	Yes	Yes
Thermostat	Mechanical	Mechanical	Mechanical	Mechanical	Mechanical
Net weight, kg	44	54	62	68	73
Gross weight, kg	47	58	66	73	79

### SHIPPING

20' cont. Capacity	42	30	24	20	18
40' cont. Capacity	90	64	50	44	40
40' HC cont. Capacity	135	96	75	66	59
Standard Trailer capacity	153	108	90	75	66



S-DISPLAY

# FOCUS V

## IDEAL FOR BULK

The FOCUS V freezer has an elegant, yet robust, design to optimally catch the attention of your customers. The lid design, the improved insulation and the heated frame ensure minimum ice build-up.

Cyclopentane is used as blowing agent and the cabinets are CFC free.



FOCUS 106 V WITH BULK CONTAINER



FOCUS 106 V WITH OPEN LID

	FOCUS 73 V	FOCUS 106 V	FOCUS 131 V
Climate class 4	4	4	4
Ambient temperature range	+16 to +30	+16 to +30	+16 to +30
Climate class 4+	4+	4+	4+
Ambient temperature range	+16 to +35	+16 to +35	+16 to +35
Gross volume, litres	161	270	352
Net volume, litres	113	193	254
Temperature range inside unit	-14 to -23	-14 to -23	-14 to -23
Standard refrigerant	R600a	R600a	R600a
Energy consumption / 24 h kwh at 30 deg. C	1,8	2,3	3,2
AE-Annual Energy consumption, kwh	664	926	1033
EEL-Energy Efficiency Index	54,90%	67,90%	66,10%
EC-Energy Class	D	E	E
Input power (watt)	141	153	203
<b>DIMENSIONS</b>			
External dimensions (WxDxH)	726*656*878	1056*656*878	1306*656*878
Internal dimensions (WxDxH)	570*500*670	900*500*670	1150*500*670
Dimension A	726	1056	1306
Dimension B	656	656	656
Dimension C	890	890	890
Dimension D	570	900	1150
Dimension E	370	700	950
Dimension F	500	500	500
Dimension G	725	725	725
Dimension H	475	475	475
Dimension I	770	770	770
Insulation (mm)	75	75	75
<b>ACCESSORIES</b>			
Dividers	Optional	Optional	Optional
Container for bulk food, PLASTD21	Optional (2pcs)	Optional (3 pcs)	Optional (4 pcs)
Max. number of baskets (model C75-01/C75-02)	2/3	4/4	5/6
Castors	Incl.	Incl.	Incl.
Castors w. brakes	Optional	Optional	Optional
Lock	Optional	Optional	Optional
Thermometer	Optional	Optional	Optional
Internal light	Optional	Optional	Optional
<b>OTHER DATA</b>			
Outer cabinet	White	White	White
Inner cabinet	Aluminium	Aluminium	Aluminium
Inner cabinet: option	Steel inner liner	Steel inner liner	Steel inner liner
Graphics	Optional	Optional	Optional
Type of cooling	Static	Static	Static
Type of defrost	Manual	Manual	Manual
Power	220V/50Hz	220V/50Hz	220V/50Hz
Power 110volt / 60Hz	Optional	Optional	Optional
UL approval / DOE approval	Yes	Yes	Yes
Thermostat	Mechanical	Mechanical	Mechanical
Net weight, kg	44	54	62
Gross weight, kg	47	58	66
<b>SHIPPING</b>			
20' cont. Capacity	42	30	24
40' cont. Capacity	90	64	50
40' HC cont. Capacity	126	88	62
Standard Trailer capacity	153	108	90



FOOD BUCKET  
(FDA-APPROVED FOR FOOD)

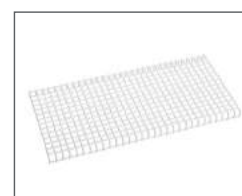

DRAIN

## FEATURES

- HC refrigerants as standard
- Environmentally friendly
- Low service costs
- Perfect view to the products
- Long life
- Available in all climate classes
- Minimum icebuild-up
- Designed for transport
- Eye Catching design
- 75 mm insulation
- Also available as combination of cooler and freezer - see page 51.
- Accessories including baskets - see page 62
- Graphics (option)
- LED internal light (option)

# | SCOOP |

## PRESENTATION & VISIBILITY

Presentation and visibility are the key words when selling ice cream in the consumer market. Most customers make their final purchase decision on the point of sales. Therefore it is important, that the customers notice your ice cream freezer.

With the Elcold Scoop ice cream program, you are offered the possibility to create your own ice cream freezer solution to match your needs and optimize your promotion. You can combine our Nova freezer with the Elcold canopies (Sneezeguards).



GLASS TOP CANOPY WITH NOVA FREEZER



ALUMINUM TOP CANOPY WITH NOVA FREEZER

## FEATURES

- High Quality
- Available for Nova 22 to Nova 61 freezers
- Elegant design
- Scoop baskets available
- Available in all climate classes
- Graphics (option)
- Illuminated canopy (option)
- Accessories including baskets - see page 63

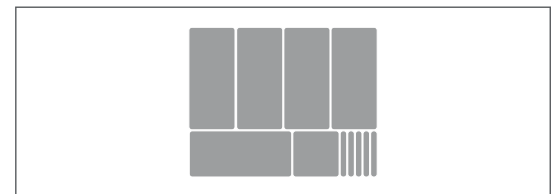

NOVA 22 BASKET LAYOUT

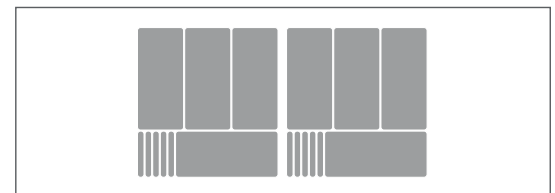

NOVA 35 BASKET LAYOUT

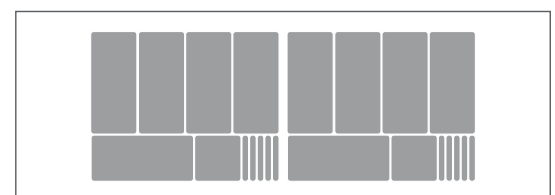

NOVA 45 BASKET LAYOUT

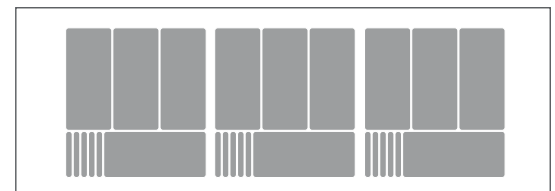

NOVA 53 BASKET LAYOUT

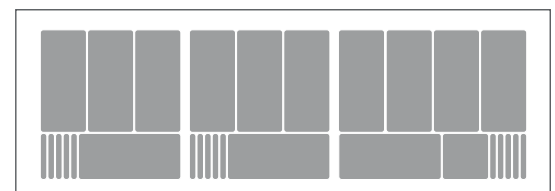

NOVA 61 BASKET LAYOUT

### WIRE BASKETS FOR SCOOP

The baskets are designed for 5 liter plastic containers with a dimension of 342\*154\*130 mm.

FREEZER MODEL	NUMBER OF BASKETS (3 + 1 ACROSS)	NUMBER OF BASKETS (4 + 1 ACROSS)	NUMBER OF DIFF 5 LITER FLAVOURS
Nova 22	0	1	5
Nova 35	2	0	8
Nova 45	0	2	10
Nova 53	3	0	12
Nova 61	2	1	13



Nova 22 basket layout



# | NOVA |

## ICE CREAM & DISPLAY FREEZER

## FEATURES

- Steel inner liner
- HC refrigerants as standard
- Low service costs
- Custom made design
- Long life
- Available in all climate classes
- 5 different sizes
- Partially self closing lid
- 77 mm insulation
- Environmental friendly
- Accessories including baskets - see page 63
- Graphics (option)
- Scoope (option)

At first sight it may look like a traditional freezer for ice cream and frozen food but furthermore we can offer very high quality and reliability. New technologies have allowed us to use compressors with very low energy consumption, which also includes the use of hydro carbons. The lid system is unique. Once you get to the final part of the closing process, the lid is partially self-closing.



## TYPICAL CONFIGURATION OF VENTILATION GRIDS



Ventilation grid with digital thermometer



Standard ventilation grid

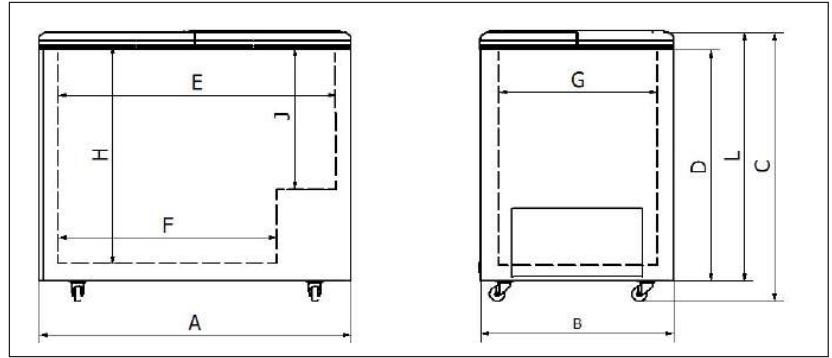

	NOVA 22	NOVA 35	NOVA 45	NOVA 53	NOVA 61
Climate class 4	4	4	4	4	4
Ambient temperature range	+16 to +30	+16 to +30	+16 to +30	+16 to +30	+16 to +30
Climate class 4+	4+	4+	4+	4+	4+
Ambient temperature range	+16 to +35	+16 to +35	+16 to +35	+16 to +35	+16 to +35
Gross volume, litres	205	331	426	503	602
Net volume, litres	163	267	345	408	489
Temperature range inside unit	-16 to -23	-16 to -23	-16 to -23	-16 to -23	-16 to -23
Refrigerant	R600a	R600a	R600a	R290	R290
Energy consumption / 24h kwh at 30 deg. C	1,4	2,1	3,0	3,7	3,9
AE-Annual Energy consumption, kwh	531	996	1383	1402	1424
EEL-Energy Efficiency Index	38,20%	62,00%	74,20%	61,60%	55,40%
EC-Energy Class	D	D	D	D	D
Input power (watt)	141	153	203	204	230
<b>DIMENSIONS</b>					
External dimensions (WxDxH)	764*694*867	1094*694*867	1344*694*867	1544*694*867	1804*694*867
Internal dimensions (WxDxH)	606*536*688	936*536*688	1186*536*688	1386*536*688	1646*536*688
Dimension A	764	1094	1344	1544	1804
Dimension B	694	694	694	694	694
Dimension C	867	867	867	867	867
Dimension D	764	764	764	764	764
Dimension E	606	936	1186	1386	1646
Dimension F	406	736	986	1186	1446
Dimension G	536	536	536	536	536
Dimension H	688	688	688	688	688
Dimension J	438	438	438	438	438
Dimension L	798	798	798	798	798
Insulation (mm)	77	77	77	77	77
<b>ACCESSORIES</b>					
Dividers	Optional	Optional	Optional	Optional	Optional
Max number of baskets (option)	2	3	4	5	6
Castors	Incl.	Incl.	Incl.	Incl.	Incl.
Castors w brakes	Optional	Optional	Optional	Optional	Optional
Lock	Optional	Optional	Optional	Optional	Optional
Thermometer	Optional	Optional	Optional	Optional	Optional
Internal light	n/a	n/a	n/a	n/a	n/a
<b>OTHER DATA</b>					
Outer cabinet	White	White	White	White	White
Inner cabinet	Steel inner liner	Steel inner liner	Steel inner liner	Steel inner liner	Steel inner liner
Graphics	Optional	Optional	Optional	Optional	Optional
Type of cooling	Static	Static	Static	Static	Static
Type of defrost	Manual	Manual	Manual	Manual	Manual
Power	220-240 v / 50 Hz	220-240 v / 50 Hz	220-240 v / 50 Hz	220-240 v / 50 Hz	220-240 v / 50 Hz
Power 110 volt / 60 Hz	Optional	Optional	Optional	Optional	Optional
UL / DOE approval	Yes	Yes	Yes	Yes	Yes
Thermostat	Mechanical	Mechanical	Mechanical	Mechanical	Mechanical
Net weight, kg	45	53	61	68	71
Gross weight, kg	48	57	65	72	75
Gross weight, kg	48	57	65	72	75
<b>SHIPPING</b>					
20' cont. capacity	42	30	24	20	18
40' cont. capacity	84	62	50	44	38
40' HC cont. capacity	126	91	74	64	55
Standard trailer capacity	153	105	84	78	66



# | CUBE |

## ICECREAM & DISPLAY FREEZER

## FEATURES

- Steel inner liner
- HC refrigerants as standard
- Low service costs
- Custom made design
- Long life
- Available in all climate classes
- 5 different sizes
- Partially self closing lid
- 77 mm insulation
- Environmental friendly
- Accessories including baskets - see page 63
- Graphics (option)
- Scoop (option)

At first sight it may look like a traditional freezer for ice cream and frozen food but furthermore we can offer very high quality and reliability. New technologies has allowed us to use compressors with very low energy consumption, which also includes the use of hydro carbons. The lid system is unique. Once you get to the final part of the closing process, the lid is partially self-closing.



## TYPICAL CONFIGURATION OF VENTILATION GRIDS



Ventilation grid with digital thermometer



Standard ventilation grid

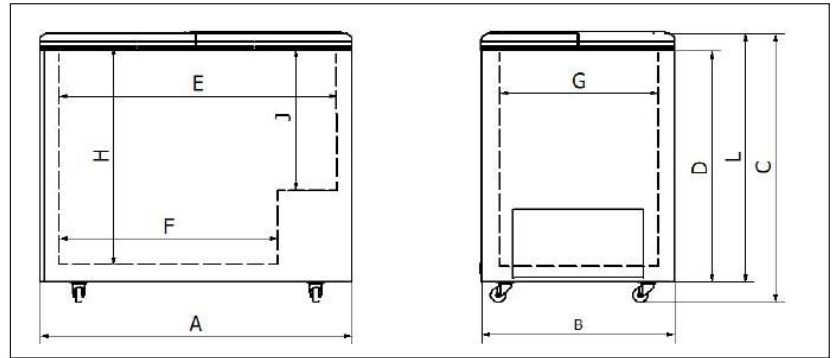

	CUBE 22	CUBE 35	CUBE 45	CUBE 53	CUBE 61
Climate class 4	4	4	4	4	4
Ambient temperature range	+16 to +30	+16 to +30	+16 to +30	+16 to +30	+16 to +30
Climate class 4+	4+	4+	4+	4+	4+
Ambient temperature range	+16 to +35	+16 to +35	+16 to +35	+16 to +35	+16 to +35
Gross volume, litres	205	331	426	503	602
Net volume, litres	163	267	345	408	489
Temperature range inside unit	-16 to -23	-16 to -23	-16 to -23	-16 to -23	-16 to -23
Refrigerant	R600a	R600a	R600a	R290	R290
Energy consumption / 24h kwh at 30 deg. C	1,5	2,1	3,0	3,7	3,9
AE-Annual Enrgy consumption, kwh	532	996	1383	1402	1425
EEl-Energy Efficiency Index	55,40%	62,00%	74,20%	61,60%	62,50%
EC-Energy Class	C	D	E	E	D
Input power (watt)	141	153	203	204	230
<b>DIMENSIONS</b>					
External dimensions (WxDxH)	764*694*867	1094*694*867	1344*694*867	1544*694*867	1804*694*867
Internal dimensions (WxDxH)	606*536*688	936*536*688	1186*536*688	1386*536*688	1646*536*688
Dimension A	764	1094	1344	1544	1804
Dimension B	694	694	694	694	694
Dimension C	867	867	867	867	867
Dimension D	764	764	764	764	764
Dimension E	606	936	1186	1386	1646
Dimension F	406	736	986	1186	1446
Dimension G	536	536	536	536	536
Dimension H	688	688	688	688	688
Dimension J	438	438	438	438	438
Dimension L	798	798	798	798	798
Insulation (mm)	77	77	77	77	77
<b>ACCESSORIES</b>					
Dividers	Optional	Optional	Optional	Optional	Optional
Max number of baskets (option)	2	3	4	5	6
Castors	Incl.	Incl.	Incl.	Incl.	Incl.
Castors w brakes	Optional	Optional	Optional	Optional	Optional
Lock	Optional	Optional	Optional	Optional	Optional
Thermometer	Optional	Optional	Optional	Optional	Optional
Internal light	n/a	n/a	n/a	n/a	n/a
<b>OTHER DATA</b>					
Outer cabinet	White	White	White	White	White
Inner cabinet	Steel inner liner	Steel inner liner	Steel inner liner	Steel inner liner	Steel inner liner
Graphics	Optional	Optional	Optional	Optional	Optional
Type of cooling	Static	Static	Static	Static	Static
Type of defrost	Manual	Manual	Manual	Manual	Manual
Power	220-240 v / 50 Hz	220-240 v / 50 Hz	220-240 v / 50 Hz	220-240 v / 50 Hz	220-240 v / 50 Hz
Power 110 volt / 60 Hz	Optional	Optional	Optional	Optional	Optional
UL / DOE approval	Yes	Yes	Yes	Yes	Yes
Thermostat	Mechanical	Mechanical	Mechanical	Mechanical	Mechanical
Net weight, kg	45	53	61	68	71
Gross weight, kg	48	57	65	72	75
<b>SHIPPING</b>					
20' cont. capacity	42	30	24	20	18
40' cont. capacity	84	62	50	44	38
40' HC cont. capacity	126	91	74	64	55
Standard trailer capacity	153	105	84	78	66

# | DUO |

## PERFECT VIEW



DUO 127

	DUO 80	DUO 127
Climate class	3	3
Ambient temperature range	+10 to +25	+10 to +25
Gross volume, litres	123	224
Net volume, litres	82	139
Temperature range inside unit	-16 to -23	-16 to -23
Refrigerants available:	R404a / R290	R404a / R290
Energy consumption/ 24 h	9,03 (R290)	14,62 (R290)
Input power (watt)	447	850
<b>DIMENSIONS</b>		
External dim. (WxDxH)	800*750*1178	1270*750*1178
Internal dim. (WxDxH) upper	670*325*380	1140*325*380
Internal dim. (WxDxH) lower	670*530*440	1140*530*440
Insulation (mm)	60	60
<b>ACCESSORIES</b>		
Divider	2 in top section/ 2 in lower section	4 in top section/ 4 in lower section
Feet	Incl.	Incl.
Lock	n / a	n/a
Thermometer	Analog	Analog
Digital controller	n/a	n/a
Internal light	Incl.	Incl.
<b>OTHER DATA</b>		
Outer cabinet	White	White
Inner cabinet	Painted steel	Painted steel
Graphics	Optional	Optional
Type of cooling	Static	Static
Type of defrost	Manual	Manual
Power	220 v/ 50 Hz	220 v/ 50 Hz
Power 110volt / 60 hz	Optional	Optional
Net weight, kg	83	123
Gross weight, kg	93	135
<b>SHIPPING</b>		
20' cont. Capacity	12	10
40' cont. Capacity	28	22
40' cont. HC Capacity	56	44
Standard Trailer capacity	64	52

## FEATURES

- Low service costs
- Perfect view to the products
- Long life
- Graphics (option)

MINIMUM QUANTITY APPLIES



# | MOBILUX |

## BATTERY FREEZER W. TRICYCLE

Combi version of freezer and cooler. The Mobilux 12 V freezer or cooler is the right choice if you need mobility or don't have power available. It will help you to sell your ice cream, frozen foods or cold drinks in places, where this normally would not be possible as it can be supplied and installed on a tricycle. It works with an input of 230 volt/ 110 volt to a charger, which supplies a 12 volt gel battery. Once loaded, the battery will run a 12 volt compressor. The battery and compressor are both well hidden inside the motor compartment.



TRICYCLE FOR MOBILUX 11

TRICYCLE	
Dimensions of package:(WxDxH)	60x80x150 cm
Weight of package (kg)	30
Dimensions unpacked (WxDxH) (Incl. freezer)	210x90x118 cm
FEATURES:	
Handbrake	Yes
Internal brake	Yes
Internal gears, pcs	3



MOBILUX 11 FREEZER WITH SCOOP CONTAINER

## FEATURES

- Low service costs
- Long life
- Combi version of cooler and freezer
- Accessories including baskets  
- see page 62
- Graphics (option)



CONTROL PANEL  
- available from  
early 2022

	MOBILUX 11	MOBILUX 21
Climate class 4	4	4
Ambient temperature range	+16 to +30	+16 to +30
Climate class 5	5	n/a
Ambient temperature range	+16 to +43	-
Gross volume, litres	144	249
Net volume, litres	117	206
Temperature range inside unit	-18 or +4	-18 or +4
Standard refrigerant	R290	R290
Energy consumption / 24 h. Climate class 4 (kwh) 60 % running time	0,9	1,2
Input power for R290 (watt)	59	83
DIMENSIONS		
External dimensions (WxDxH)	724*654*916	1054*654*916
Internal dimensions (WxDxH)	520*450*686	850*450*686
Dimension A	724	1054
Dimension B	654	654
Dimension C	916	916
Dimension D	780	780
Dimension E	520	850
Dimension F	320	650
Dimension G	450	450
Dimension H	686	686
Dimension J	436	436
Dimension L	846	846
Insulation (mm)	100	100
ACCESSORIES		
Max. number of baskets	1	2
Scoop baskets available	Yes	n/a
Castors	Incl.	Incl.
Castors w. brakes	Optional	Optional
Charger and battery included	Yes	Yes
Lock	Yes	Yes
Thermometer	Optional	Optional
Internal light	n/a	n/a
OTHER DATA		
Outer cabinet	White	White
Inner cabinet	Aluminium	Aluminium
Graphics	Optional	Optional
Type of cooling	Static	Static
Type of defrost	Manual	Manual
Power	220V/50Hz	220V/50Hz
Power 110volt / 60 hz	Optional	Optional
Thermostat	Mechanical	Mechanical
Net weight, kg	55	68
Gross weight, kg	62	75
SHIPPING		
20' cont. Capacity	42	30
40' cont. Capacity	90	64
Standard Trailer capacity	102	74

\*FOR DIMENSIONS SEE PAGE 23



CVG 61

# | CVG |

## ICE CREAM & DISPLAY FREEZER

## FEATURES

- Low service costs
- Perfect view to the products
- Long life
- Available in all climate classes
- Different divider systems available
- Accessories including baskets - see page 63
- Graphics (option)
- Bumperbar and kickplate (option)

The CVG freezer is the perfect freezer solution for supermarkets. The large glass lid does not only ensure an optimal display area – but also a low energy consumption compared with open freezers. The main feature is the lid. Some users of a sliding lids display freezer might forget to close the lids completely. With this freezer you are quite sure, that once the lid is placed in horizontal position, it is completely closed.



CVG 35



CVG 53



CVG 61



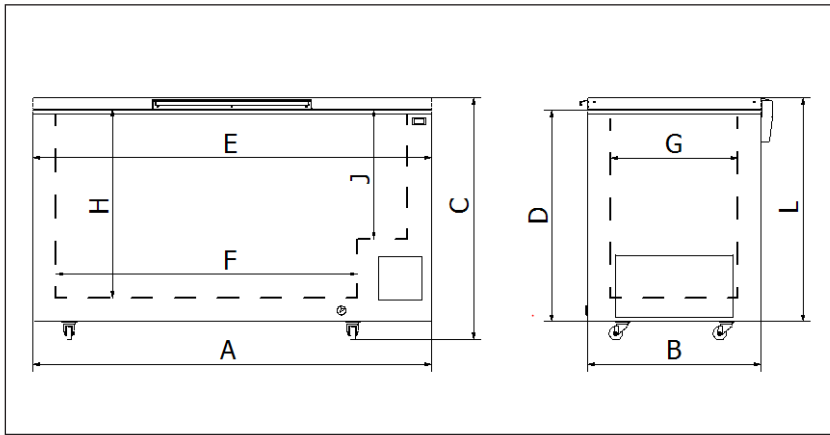

	CVG 22	CVG 35	CVG 45	CVG 53	CVG 61
Climate class 4	4	4	4	4	4
Ambient temperature range	+16 to +30	+16 to +30	+16 to +30	+16 to +30	+16 to +30
Climate class 4+	4+	4+	4+	4+	4+
Ambient temperature range	+16 to +35	+16 to +35	+16 to +35	+16 to +35	+16 to +35
Gross volume, litres	209	337	435	513	590
Net volume, litres	183	298	385	454	524
Temperature range inside unit	-14 to -23	-14 to -23	-14 to -23	-14 to -23	-14 to -23
Refrigerants available: R290 / R600a	Yes	Yes	Yes	Yes	Yes
Energy consumption / 24 h kwh at 30 deg C.	2,1	3,4	4,2	4,5	5,2
Input power (watt)	141	141	226	217	313
<b>DIMENSIONS</b>					
External dimensions (WxDxH)	724*654*910	1054*654*910	1304*654*910	1504*654*910	1704*654*910
Internal dimensions (WxDxH)	606*536*760	936*536*760	1186*536*760	1386*536*760	1586*536*760
Dimension A	724	1054	1304	1504	1704
Dimension B	654	654	654	654	654
Dimension C	910	910	910	910	910
Dimension D	780	780	780	780	780
Dimension E	606	936	1186	1386	1586
Dimension F	406	736	986	1186	1386
Dimension G	536	536	536	536	536
Dimension H	760	760	760	760	760
Dimension J	510	510	510	510	510
Dimension L	840	840	840	840	840
Insulation (mm)	60	60	60	60	60
<b>ACCESSORIES</b>					
Dividers	Optional	Optional	Optional	Optional	Optional
Max. number of baskets (model c145/c150)	2/2	4/3	5/4	6/4	7/5
Castors	Incl.	Incl.	Incl.	Incl.	Incl.
Castors w. brakes	Optional	Optional	Optional	Optional	Optional
Lock	n/a	n/a	n/a	n/a	n/a
Thermometer	Optional	Optional	Optional	Optional	Optional
Internal light	n/a	n/a	n/a	n/a	n/a
Bumper bar & kickplate	Optional	Optional	Optional	Optional	Optional
Supermarket divider	n/a	n/a	n/a	n/a	Optional
<b>OTHER DATA</b>					
Outer cabinet	White	White	White	White	White
Inner cabinet	Steel inner liner	Steel inner liner	Steel inner liner	Steel inner liner	Steel inner liner
Grapics	Optional	Optional	Optional	Optional	Optional
Type of cooling	Static	Static	Static	Static	Static
Type of defrost	Manual	Manual	Manual	Manual	Manual
Power	220V/50Hz	220V/50Hz	220V/50Hz	220V/50Hz	220V/50Hz
Power 110volt / 60 Hz	Optional	Optional	Optional	Optional	Optional
Thermostat	Mechanical	Mechanical	Mechanical	Mechanical	Mechanical
Net weight, kg	43	54	64	67	77
Gross weight, kg	46	58	68	71	82
<b>SHIPPING</b>					
20' cont. Capacity	42	30	24	20	18
40' cont. Capacity	90	64	50	46	40
40' HC cont. Capacity	126	88	62	61	52
Standard Trailer capacity	102	74	60	52	44



EL 71

## FEATURES

- Low service costs
- Long life
- Available in all climate classes
- Accessories including baskets
- Graphics (option)
- Accessories including baskets  
- see page 63

| EL |

## ICE CREAM FREEZER FOR DIRECT SALES



EL 22



EL 35



EL 45



EL 53



EL 61

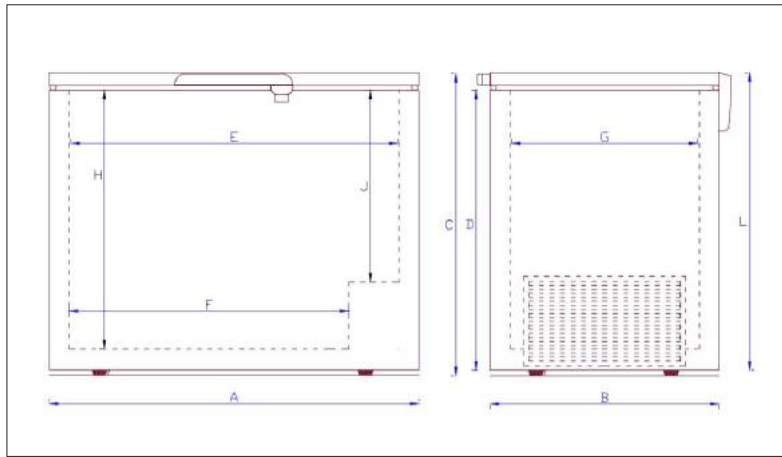

	EL 22	EL 35	EL 45	EL 53	EL 61	EL 71
Ambient temperature range	+10 to +30	+10 to +30	+10 to +30	+10 to +30	+10 to +30	+10 to +31
Gross volume, litres	200	323	416	491	566	691
Net volume, litres	177	279	361	426	492	564
Temperature range inside unit	-16 to -22	-16 to -22	-16 to -22	-16 to -22	-16 to -22	-16 to -22
Standard refrigerant	R600a	R600a	R600a	R600a	R600a	R600a
Energy consumption / 24 h (kwh) at 18 deg	0,9	1,2	1,6	1,9	2,0	3,2
AE-Annual Enery consumption, kwh	347	447	543	717	737	1166
EEL-Energy Efficiency Index	24,10%	24,70%	25,80%	30,60%	28,6	41,1
EC-Energy Class	B	B	B	B	B	C
Input power (wattf)	124	141	146	211	211	245
<b>DIMENSIONS</b>						
External dimensions (WxDxH)	725x655x865	1055x655x865	1305x655x865	1505*655*865	1705*655*865	1805x695x865
Internal dimensions (WxDxH)	606*536*697	936*536*697	1186*536*697	1386*536*697	1586*536*697	1686*576*741
Dimension A	725	1055	1305	1505	1705	1805
Dimension B	655	655	655	655	655	695
Dimension C	865	865	865	865	865	865
Dimension D	780	780	780	780	780	780
Dimension E	606	936	1186	1386	1586	1686
Dimension F	406	736	986	1186	1386	1486
Dimension G	536	536	536	536	536	576
Dimension H	697	697	697	697	697	741
Dimension J	447	447	447	447	447	491
Dimension L	850	850	850	850	850	850
Insulation, mm	60	60	60	60	60	60
<b>ACCESSORIES</b>						
Dividers	Optional	Optional	Optional	Optional	Optional	Optional
Baskets included	1	2	2	3	3	3
Max. Number of basket possible	1	2	3	4	4	6
Castors	Optional	Optional	Optional	Optional	Optional	Optional
Castors w. brakes	Optional	Optional	Optional	Optional	Optional	Optional
Lock	Incl.	Incl.	Incl.	Incl.	Incl.	Incl.
Thermometer	Optional	Optional	Optional	Optional	Optional	Optional
<b>OTHER DATA</b>						
Outer cabinet	White	White	White	White	White	White
Inner cabinet:	Steel inner liner	Steel inner liner	Steel inner liner	Steel inner liner	Steel inner liner	Steel inner liner
Type of cooling	Static	Static	Static	Static	Static	Static
Type of defrost	Manual	Manual	Manual	Manual	Manual	Manual
Power	220V/50Hz	220V/50Hz	220V/50Hz	220V/50Hz	220V/50Hz	220V/50Hz
Power 110volt / 60 hz	Optional	Optional	Optional	Optional	Optional	Optional
Thermostat	Analog	Analog	Analog	Analog	Analog	Analog
Freezing capacity kg/ 24 h	15	22	27	36	38	43
Light in Lid	Incl.	Incl.	Incl.	Incl.	Incl.	Incl.
Calendar in Lid	Incl.	Incl.	Incl.	Incl.	Incl.	Incl.
Net weight, kg	43	54	64	67	77	85
Gross weight, kg	46	58	68	71	82	89
<b>SHIPPING</b>						
20' cont. Capacity	42	30	24	20	18	14
40' cont. Capacity	90	64	50	46	40	30
40' HC cont. Capacity	126	88	62	61	52	42
Standard Trailer capacity	102	74	60	52	44	42



## FEATURES

- Low service costs
- Long life
- Available in all climate classes
- Accessories including baskets
- Graphics (option)
- Accessories including baskets - see page 63

| EL SS |

**ICE CREAM FREEZER**  
FOR DIRECT SALES WITH  
STAINLESS STEEL LID



EL 45 SS



EL 61 SS



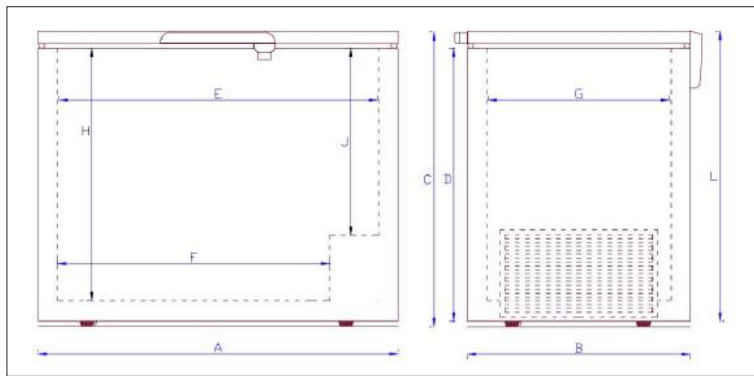

	EL 22 SS	EL 35 SS	EL 45 SS	EL 53 SS	EL 61 SS	EL 71 SS
Ambient temperature range	+10 to +30	+10 to +30	+10 to +30	+10 to +30	+10 to +30	+10 to +30
Gross volume, litres	200	323	416	491	566	691
Net volume, litres	177	279	361	426	492	564
Temperature range inside unit	-16 to -22	-16 to -22	-16 to -22	-16 to -22	-16 to -22	-16 to -22
Standard refrigerant	R600a	R600a	R600a	R600a	R600a	R600a
Energy consumption / 24 h (kwh) at 18 deg	0,95	1,2	1,6	1,9	2,0	3,2
AE-Annual Enegy consumption, kwh	347	447	543	717	737	1166
EEL-Energy Efficiency Index	24,10%	24,70%	25,80%	30,60%	28,6	41,1
EC-Energy Class	B	B	B	B	B	C
Input power (watt):	124	141	146	211	211	245
<b>DIMENSIONS</b>						
External dimensions (WxDxH)	725x655x865	1055x655x865	1305x655x865	1505*655*865	1705*655*865	1805x695x865
Internal dimensions (WxDxH)	606*536*697	936*536*697	1186*536*697	1386*536*697	1586*536*697	1686*576*741
Dimension A	725	1055	1305	1505	1705	1805
Dimension B	655	655	655	655	655	695
Dimension C	865	865	865	865	865	865
Dimension D	780	780	780	780	780	780
Dimension E	606	936	1186	1386	1586	1686
Dimension F	406	736	986	1186	1386	1486
Dimension G	536	536	536	536	536	576
Dimension H	697	697	697	697	697	741
Dimension J	447	447	447	447	447	491
Dimension L	850	850	850	850	850	850
Insulation, mm	60	60	60	60	60	60
<b>ACCESSORIES</b>						
Dividers	Optional	Optional	Optional	Optional	Optional	optional
Baskets included	1	2	2	3	3	3
Max. Number of basket possible	1	2	3	4	4	6
Castors	Optional	Optional	Optional	Optional	Optional	optional
Castors w. brakes	Optional	Optional	Optional	Optional	Optional	optional
Lock	Incl.	Incl.	Incl.	Incl.	Incl.	Incl.
Thermometer	Optional	Optional	Optional	Optional	Optional	Optional
<b>OTHER DATA</b>						
Outer cabinet	White	White	White	White	White	White
Inner cabinet:	Steel inner liner	Steel inner liner	Steel inner liner	Steel inner liner	Steel inner liner	Steel inner liner
Lid	Stainless EN 1.4301	Stainless EN 1.4301	Stainless EN 1.4301	Stainless EN 1.4301	Stainless EN 1.4301	Stainless EN 1.4301
Type of cooling	Static	Static	Static	Static	Static	Static
Type of defrost	Manual	Manual	Manual	Manual	Manual	Manual
Power	220V/50Hz	220V/50Hz	220V/50Hz	220V/50Hz	220V/50Hz	220V/50Hz
Power 110volt / 60 Hz	Optional	Optional	Optional	Optional	Optional	Optional
Thermostat	Analog	Analog	Analog	Analog	Analog	Analog
Freezing capacity kg / 24 h	15	22	27	36	38	43
Light in Lid	Incl.	Incl.	Incl.	Incl.	Incl.	Incl.
Calendar in Lid	Incl.	Incl.	Incl.	Incl.	Incl.	Incl.
Net weight, kg	43	54	64	67	77	85
Gross weight, kg	46	58	68	71	82	89
<b>SHIPPING</b>						
20' cont. Capacity	42	30	24	20	18	14
40' cont. Capacity	90	64	50	46	40	30
40' HC cont. Capacity	126	88	62	61	52	42
Standard Trailer capacity	102	74	60	52	44	42



UNI 31

## FEATURES

- Low service costs
- Long life
- Ideal for special product including fish and ice cream
- Digital controller with potential free contact (which makes it possible to connect it to an external alarm)
- Accessories including baskets - see page 64

# | UNI |

**PERFECT FOR RELIABLE  
STORING IN LOW TEMPERATURE**



UNI 11



UNI 21



UNI 41



UNI 51



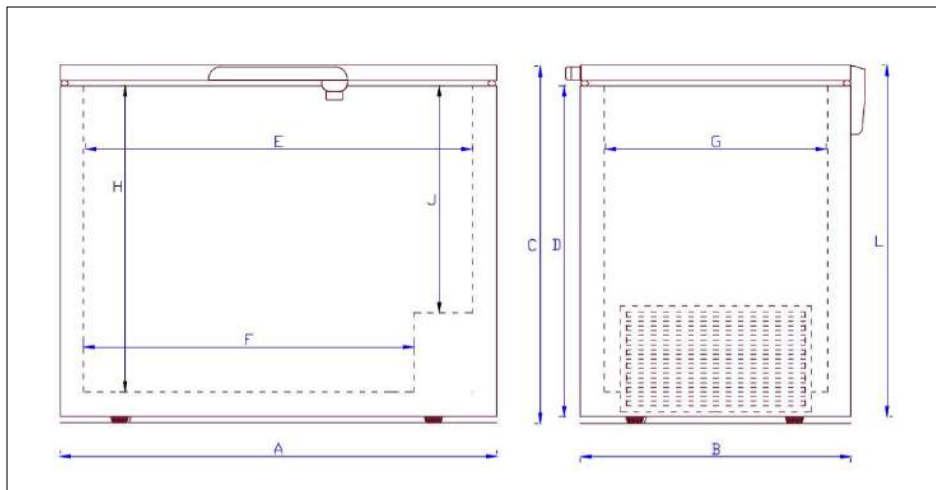

	UNI 11	UNI 21	UNI 31	UNI 41	UNI 51
Ambient temperature range	+10 to +30	+10 to +30	+10 to +30	+10 to +30	+10 to +30
Gross volume, litres	130	226	300	360	416
Net volume, litres	130	226	300	360	416
Temperature range inside unit	-10 to -45	-10 to -45	-10 to -45	-10 to -45	-10 to -45
Refrigerant: R290	Yes	Yes	Yes	Yes	Yes
Energy consumption / 24 h kwh- estimated	1,0	1,5	1,5	1,8	2,0
AEC	377	539	555	641	725
EEl	31,4	35,2	31,1	32,2	33,2
Energy class	C	C	B	C	C
Input power	210	340	380	400	420
<b>DIMENSIONS</b>					
External dimensions (WxDxH)	725*655*865	1055*655*865	1305*655*865	1505*655*865	1705*655*865
Internal dimensions (WxDxH)	520*450*650	850*450*650	1100*450*650	1300*450*650	1500*450*650
Dimension A	725	1055	1305	1505	1705
Dimension B	655	655	655	655	655
Dimension C	865	865	865	865	865
Dimension D	780	780	780	780	780
Dimension E	520	850	1100	1300	1500
Dimension F	320	650	900	1100	1300
Dimension G	450	450	450	450	450
Dimension H	650	650	650	650	650
Dimension J	400	400	400	400	400
Dimension L	850	850	850	850	850
Insulation, mm	100	100	100	100	100
<b>ACCESSORIES</b>					
Dividers	Optional	Optional	Optional	Optional	Optional
Max. number of baskets (option) KURVUNIO1	2	3	4	5	5
Castors	Optional	Optional	Optional	Optional	Optional
Castors w. brakes	Optional	Optional	Optional	Optional	Optional
Lock	Incl.	Incl.	Incl.	Incl.	Incl.
Digital controller w. acoustic alarm	Incl.	Incl.	Incl.	Incl.	Incl.
<b>OTHER DATA</b>					
Outer cabinet	White	White	White	White	White
Inner cabinet	Steel inner liner	Steel inner liner	Steel inner liner	Steel inner liner	Steel inner liner
Type of cooling	Static	Static	Static	Static	Static
Type of defrost	Manual	Manual	Manual	Manual	Manual
Power	220V/50Hz	220V/50Hz	220V/50Hz	220V/50Hz	220V/50Hz
Power 110volt / 60 hz	Optional	Optional	Optional	Optional	Optional
Potential free contact	Incl.	Incl.	Incl.	Incl.	Incl.
Thermostat	Digital	Digital	Digital	Digital	Digital
Net weight, kg	46	59	67	74	80
Gross weight, kg	49	62	71	78	85
<b>SHIPPING</b>					
20' cont. Capacity	42	30	24	20	18
40' cont. Capacity	90	64	50	46	40
Standard Trailer capacity	102	74	60	52	44



UNI 31 S

# | UNI-S |

## LOW TEMP FREEZER FOR FROZEN FOOD

### FEATURES

- Low service costs
- Perfect view to the products
- Long life
- Digital controller
- Acoustic alarm
- Down to -35°C
- Digital controller with potential free contact, (which makes it possible to connect it to an external alarm.)
- Accessories including baskets - see page 64
- Graphics (option)

Low temperatures are often essential when you need to serve special ice cream or special kind of food. The UNI-S offers a unique combination of -35°C and glass sliding lids.



UNI 11 S



UNI 21 S



UNI 31 S



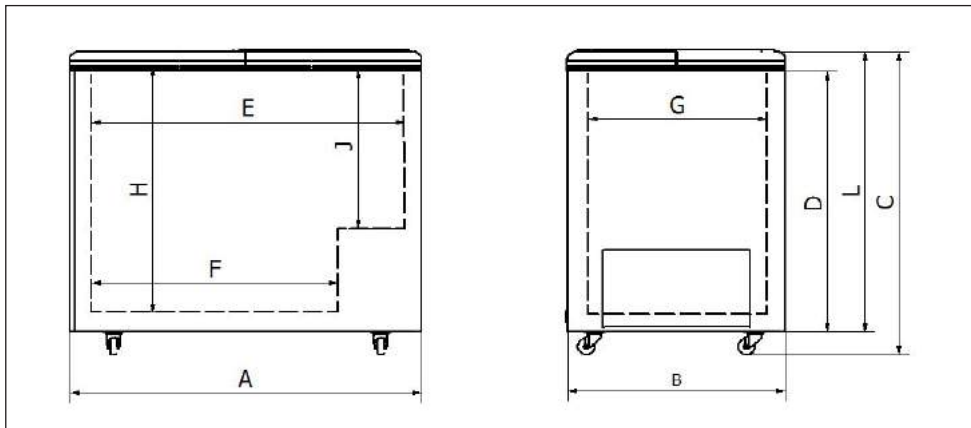

	UNI 11 S	UNI 21 S	UNI 31 S
Climate Class 4	4	4	4
Ambient temperature range	+10 to +30	+10 to +30	+10 to +30
Gross volume, litres	140	243	322
Net volume, litres	116	203	270
Temperature range inside unit	-10 to -35	-10 to -35	-10 to -35
Refrigerant: R290	Yes	Yes	Yes
Energy consumption / 24 h (kwh)	1,89	2,98	3,08
Annual energy consumption kwh	690	1088	1124
Energy efficiency index	62,1%	77,9%	69,5%
Energy class	D	E	E
Input power (watt)	190	305	340
<b>DIMENSIONS</b>			
External dimensions (WxDxH)	725x655x916	1055x655x916	1305x655x916
Internal dimensions (WxDxH)	520x450x710	850x450x710	1100x450x710
Dimension A	725	1055	1305
Dimension B	655	655	655
Dimension C	916	916	916
Dimension D	780	780	780
Dimension E	520	850	1100
Dimension F	320	650	900
Dimension G	450	450	450
Dimension H	710	710	710
Dimension J	460	460	460
Dimension L	846	846	846
Insulation (mm)	100	100	100
<b>ACCESSORIES</b>			
Dividers	Optional	Optional	Optional
Baskets	Optional	Optional	Optional
Castors	Incl.	Incl.	Incl.
Castors w. brakes	Optional	Optional	Optional
Lock	Incl.	Incl.	Incl.
Digital controller w. acoustic alarm	Incl.	Incl.	Incl.
Potential free contact	Yes	Yes	Yes
<b>OTHER DATA</b>			
Outer cabinet	White	White	White
Inner cabinet	Aluminum	Aluminum	Aluminum
Inner cabinet: option	Steel inner liner	Steel inner liner	Steel inner liner
Type of cooling	Static	Static	Static
Type of defrost	Manual	Manual	Manual
Power	220 v/ 50 Hz	220 v/ 50 Hz	220 v/ 50 Hz
Power 110 v/ 60 Hz	Optional	Optional	Optional
UL / DOE approval	Yes	Yes	Yes
Potential free contact	Yes	Yes	Yes
Net weight, kg	46	59	67
Gross weight, kg	49	62	71
<b>SHIPPING</b>			
20' cont. Capacity	42	30	24
40' cont. Capacity	90	64	50
Standard Trailer capacity	102	74	60

# | VISION |

EASY ACCESS AND  
PERFECT VISIBILITY

## FEATURES

- Low service costs
- Perfect view to the products
- Long life
- Graphics (option)



VISION ESD 46



VISION ESD 76



VISION ESD 92



VISION EKF 870



VISION 60



VISION 390

DOUBLE DOOR FREEZERS AVAILABLE ON REQUEST

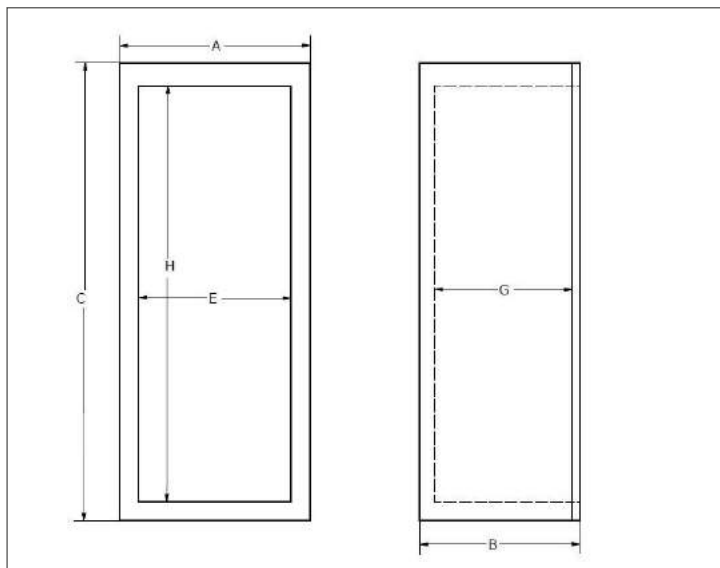

	VISION ESD46	VISION ESD 76	VISION ESD 92	VISION EKF 870	VISION 60	VISION 390
Climate class	3	3	3	3	4	7
Ambient temp. range	+16 to +25	+16 to +25	+16 to +25	+16 to +25	+16 to +30	+16 to +35
Volume	45	92	92	370	60	384
Temperature range inside unit	-9 to -24	-9 to -24	-9 to -24	-12 to -24	-16 to -23	-14 to -23
Refrigerants available	R290	R290	R290	R290	R290	R290
Input power (watt)	150	195	195	654	100	520
Energy consumption(kwh)/ 24 h	2,35	2,8	2,95	9,8	3,5	
<b>DIMENSIONS</b>						
External dimensions (WxDxH)	570*500*500	595*516*688	595*540*855	660*663*2110	570*610*635	660*675*1930
Internal dimensions (WxDxH)	500*350*358	485*376*540	485*376*540	544*490*1344	570*500*470	540*550*1330
Dimension A	570	595	595	660	570	660
Dimension B	500	516	540	663	610	675
Dimension C	500	688	855	2110	635	1930
Dimension E	500	485	485	544	450	540
Dimension G	350	376	376	490	420	550
Dimension H	358	540	540	1344	470	1330
Insulation (mm)	35	55	55	58	60	60
<b>ACCESSORIES</b>						
Castors/ feet	feet	feet	feet	feet	2pcs incl.	2 pcs incl.
Shelves	2	3	3	6	2	7
Lock	n/a	n/a	n/a	Yes	n /a	included
Thermometer	n/a	n/a	n/a	Yes	n/a	controller
Internal light	LED	LED	LED	Vertical LED	LED	in canopy and at door
<b>OTHER DATA</b>						
Outer cabinet	White	White	White	White	White	White
Inner cabinet	White	White	White	White	Stainless	White
Graphics	Optional	Optional	Optional	Optional	Optional	Optional
Type of cooling	Static	Static	Static	Ventilated	Static	ventilated
Type of defrost	Manual	Manual	Manual	Auto	Manual	Manual
Fixed shelves w evaporator	Yes	Yes	No	No	No	no
Power	230V/50hz	230V/50hz	230V/50hz	230V/50hz	220V/50Hz	230V/50hz
Thermostat	Mechanical	Mechanical	Mechanical	Digital	Mechanical	controller
Net weight, kg	30	55	65	116	44	120
Gross weight, kg	34	60	70	125	52	124
<b>SHIPPING</b>						
20 ft container capacity	160 pcs	111 pcs	74 pcs	24 pcs	48 pcs	21 pcs
40 ft container capacity	328 pcs	231 pcs	154 pcs	48 pcs	153 pcs	48 pcs
40 ft HC container capacity	410 pcs	234 pcs	234 pcs	48 pcs	n/a	48 pcs
Minimum quantity will apply					Yes	51 pcs

MINIMUM QUANTITY APPLIES FOR VISION 60 AND VISION 390



HOUSEHOLD  
& DOMESTIC  
FREEZERS



# FEATURES

- Environmentally friendly
- Low service costs
- Long life
- 100 mm insulation
- Accessories including baskets - see page 64



51 XLE

| XLE |

**OPTIMAL LOW  
ENERGY SOLUTION**



11 XLE



21 XLE



31 XLE



41 XLE



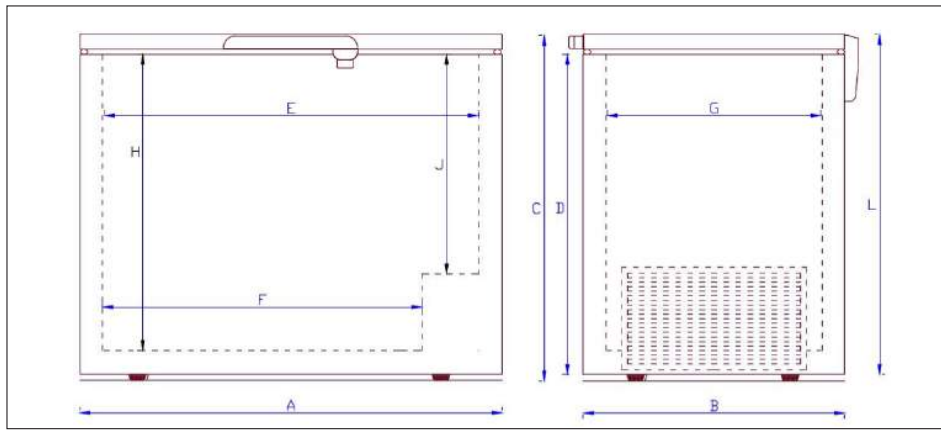

100 MM INSULATION

	XLE 11	XLE 21	XLE 31	XLE 41	XLE 51
Ambient temperature range	+10 to +30	+10 to +30	+10 to +30	+10 to +30	+10 to +30
Gross volume, litres	130	226	300	360	416
Net volume, litres	130	226	300	360	416
Temperature range inside unit	-14 to -22	-14 to -22	-14 to -22	-14 to -22	-14 to -22
Refrigerant: R600	Yes	Yes	Yes	Yes	Yes
Input power (watt)	90	102	114	126	138
Energy consumption / 24 h (kwh) at 25 degree amb.	0,43	0,55	0,64	0,72	0,81
Annual energy consumption kwh	157	201	234	263	296
Energy Efficiency Index	87,70%	96%	100,50%	104,50%	109,90%
Energy Class	D	D	E	E	E
<b>DIMENSIONS</b>					
External dimensions (WxDxH)	725*655*865	1055*655*865	1305*655*865	1505*655*865	1705*655*865
Internal dimension (WxDxH)	520*450*650	850*450*650	1100*450*650	1300*450*650	1500*450*650
Dimension A	725	1055	1305	1505	1705
Dimension B	655	655	655	655	655
Dimension C	865	865	865	865	865
Dimension D	780	780	780	780	780
Dimension E	520	850	1100	1300	1500
Dimension F	320	650	900	1100	1300
Dimension G	450	450	450	450	450
Dimension H	650	650	650	650	650
Dimension J	400	400	400	400	400
Dimension L	850	850	850	850	850
Insulation, mm	100	100	100	100	100
<b>ACCESSORIES</b>					
Dividers	Optional	Optional	Optional	Optional	Optional
Number of baskets included	1	2	3	4	4
Castors	Optional	Optional	Optional	Optional	Optional
Castors w. brakes	Optional	Optional	Optional	Optional	Optional
Freezing capacity kg /24 h	16	25	31	34	36
Lock	Incl.	Incl.	Incl.	Incl.	Incl.
Thermometer	Optional	Optional	Optional	Optional	Optional
Lock	Incl.	Incl.	Incl.	Incl.	Incl.
Thermometer	Optional	Optional	Optional	Optional	Optional
<b>OTHER DATA</b>					
Outer cabinet	White	White	White	White	White
Inner cabinet	Aluminium	Aluminium	Aluminium	Aluminium	Aluminium
Inner cabinet: option	Steel inner liner	Steel inner liner	Steel inner liner	Steel inner liner	Steel inner liner
Type of cooling	Static	Static	Static	Static	Static
Type of defrost	Manual	Manual	Manual	Manual	Manual
Power	220 V / 50 Hz	220 V / 50 Hz	220 V / 50 Hz	220 V / 50 Hz	220 V / 50 Hz
Power 110volt / 60 hz	Optional	Optional	Optional	Optional	Optional
Thermostat	Analog	Analog	Analog	Analog	Analog
Net weight, kg	43	54	64	67	77
Gross weight, kg	46	58	68	71	82
<b>SHIPPING</b>					
20' cont. Capacity	42	30	24	20	18
40' cont. Capacity	90	64	50	46	40
40' HC cont. Capacity	126	88	62	61	52
Standard Trailer capacity	102	74	60	52	44



# FEATURES

- Low service costs
- Long life
- Acoustic alarm
- Digital controller with potential free contact (which makes it possible to connect it to an external alarm)

## | PRO |

IDEAL FOR STORING  
**TUNA FISH FOR SUSHI**



PRO 11



PRO 21



PRO 31



PRO 41



PRO 60

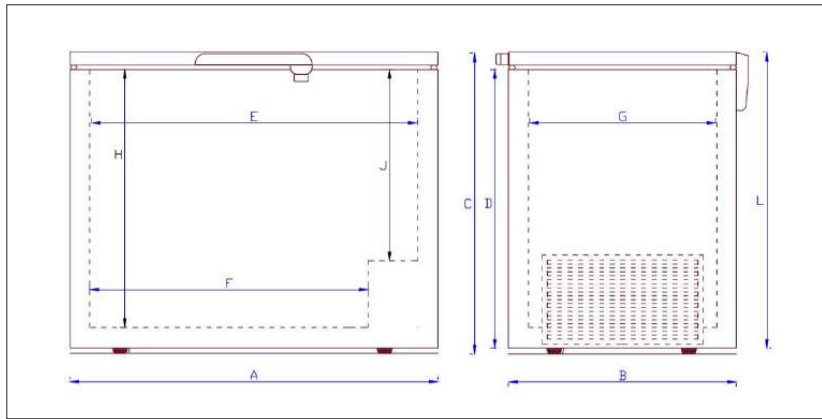

	PRO 11	PRO 21	PRO 31	PRO 41	PRO 60
Ambient temperature range	+10 to +30	+10 to +30	+10 to +30	+10 to +30	+10 to +30
Gross volume, litres	130	226	300	360	481
Net volume, litres	130	226	300	360	481
Temperature range inside unit	-30 to -60	-30 to -60	-30 to -60	-30 to -60	-30 to -60
Refrigerant: Mix of 2 Hydro carbons	Yes	Yes	Yes	Yes	Yes
Energy consumption / 24 h kwh	4,3	5	5,2	6,1	9,2
Input power (watt)	375	455	544	587	612
<b>DIMENSIONS</b>					
External dimensions (WxDxH)	725*655*865	1055*655*865	1305*655*865	1505*655*865	1705*655*865
Internal dimensions (WxDxH)	520*450*650	850*450*650	1100*450*650	1300*450*650	1540*490*670
Dimension A	725	1055	1305	1505	1705
Dimension B	655	655	655	655	655
Dimension C	865	865	865	865	865
Dimension D	780	780	780	780	780
Dimension E	520	850	1100	1300	1540
Dimension F	320	650	900	1100	1340
Dimension G	450	450	450	450	490
Dimension H	650	650	650	650	670
Dimension J	400	400	400	400	420
Dimension L	850	850	850	850	850
Insulation (mm)	100	100	100	100	80
<b>ACCESSORIES</b>					
Dividers	Optional	Optional	Optional	Optional	Optional
Max. number of baskets (option)	2	3	4	5	n/a
Castors w. brakes	Incl.	Incl.	Incl.	Incl.	Incl.
Lock	Incl.	Incl.	Incl.	Incl.	Incl.
Digital controller w. acoustic alarm	Incl.	Incl.	Incl.	Incl.	Incl.
<b>OTHER DATA</b>					
Outer cabinet	White	White	White	White	White
Inner cabinet	Steel inner liner	Steel inner liner	Steel inner liner	Steel inner liner	Steel inner liner
Type of cooling	Static	Static	Static	Static	Static
Type of defrost	Manual	Manual	Manual	Manual	Manual
Power	220V/50Hz	220V/50hz	220V/50hz	220V/50hz	220V/50hz
Power 110volt / 60 hz	Optional	Optional	Optional	Optional	Optional
Potential free contact	Incl.	Incl.	Incl.	Incl.	Incl.
Thermostat	Digital	Digital	Digital	Digital	Digital
Net weight, kg	56	67	80	89	95
Gross weight, kg	63	74	88	97	104
<b>SHIPPING</b>					
20' cont. Capacity	42	30	24	20	18
40' cont. Capacity	90	64	50	44	38
Standard Trailer capacity	102	72	56	50	44





SUPERMARKET  
FREEZERS



DSM 220

| DSM |

FLOOR SPACE **OPTIMIZER**



DSM 146

# FEATURES

- Capacity / Volume: 8% more than 2 units GSM 200
- 27 % less floor space than 2 units GSM 200
- 28% energy saving compared with 2 units GSM 200
- LED light included
- Accessories including baskets - see page 65
- Options:
  - Variable speed compressor
  - Combi mode of cooler and freezer
  - Evaporated defrost



	DSM 146	DSM 220
Climate class	3LN1	3LN1
Ambient temperature range	+10 to +25	+10 to +25
Climate class 4 and 7 (4+)	n/a	n/a
Gross volume, litres	425	1697
Net volume, litres	334	1255
Temperature range inside unit	-18 to -28	-18 to -28
Refrigerant: R290	Yes	Yes
Compressors	1 pcs	2 pcs
Energy consumption / 24 h (kwh)	3,9	9,2
Annual energy consumption (kwh)	1497	3358
Energy efficiency indes	34,9	26,7
Energy class	C	C
Input power (watt)	237	580/665
<b>DIMENSIONS</b>		
External dimensions (WxDxH)	1470*812*915	2150*1465*930
Insulation, mm	80	80
Packing dimension (WxDxH)	1530*920*1000	2240*1550*1050
<b>ACCESSORIES</b>		
Baskets	n/a	n/a
Dividers	1+1	4
Feet	Incl.	Incl.
Bumper bar	Standard	Standard
LED	included	Included
Single or double shelve	Optional	Optional
Price ticket holder	Optional	Optional
<b>OTHER DATA</b>		
Outer cabinet	White	White
Inner cabinet	White	White
Type of cooling	Static	Static
Digital controller	Yes	Yes
HACCP-Hazard analysis System	Yes	Yes
Dual mode cool /freeze	Optional	Optional
Variable speed compr.	Optional	Optional
Evaporating defrost	Incl	incl
Power	220V/50Hz	220V/50Hz
Power 110volt / 60 hz	Optional	Optional
No. of compressors	1	2
Net weight, kg	125	198
Gross weight, kg	85	251
<b>SHIPPING</b>		
20' cont. Capacity	16	6
40' cont. Capacity	30	14
40' HC cont. Capacity	30	14
Standard Trailer capacity	46	16



DSM 220



ESM ISLAND

# | ESM |

## EXCLUSIVE DISPLAY



ESM 150



ESM 200



ESM 177



ESM back to back



# FEATURES

- Low service costs
- Perfect view to the products
- Long life
- Minimum icebuild-up
- Eye Catching design
- 60 mm insulation
- Graphics (option)
- LED internal light (option)
- Accessories including baskets  
- see page 65
- Options:
  - Combi mode of cooler and freezer
  - Automated defrost



	ESM 150	ESM 200	ESM 177
Climate class	3LN1	3LN1	3LN1
Ambient temperature range	+10 to +25	+10 to +25	+10 to +25
Climate Class 4 and 7(4+)	Optional	Optional	Optional
Gross volume, litres	492	712	520
Net volume, litres	350	518	370
Temperature range inside unit	-18 to -28	-18 to -28	-18 to -28
Refrigerant: R134a / R290	Yes	Yes	Yes
Number of compressors	2	2	2
Energy consumption / 24 h kwh	7,5	8,4	9,0
Annual energy consumption (kwh)	2738	3066,0	3286
Energy efficiency index	57,6	55,2	65,2
Energy class	E	E	E
Input power (watt)	561	526	574

DIMENSIONS			
External dimensions (WxDxH)	1500*880*940	2000*880*940	1820*840*900
Internal dimensions (WxDxH)	1360*810*c1/c2	1860*810*c1/c2	1640*838*c1/c2
Dimension A	1500	2000	1820
Dimension B	885	885	838
Dimension C1/C2	940/460	940/460	900/445
Dimension F1/F2	1360/-	1860/-	395/840
Dimension H	310	310	310
Insulation, mm	70	70	70

ACCESSORIES			
Baskets	Optional (max. 5)	Optional (max. 5)	Optional (max. 6)
Dividers	Optional	Optional	Optional
Feet	Incl.	Incl.	Incl.
Lock	n/a	n/a	n/a
Bumper bar	Incl.	Incl.	Incl.
Single or double shelf	Optional	Optional	Optional
Price ticket holder	Optional	Optional	Optional
LED light	Optional	Optional	Optional

OTHER DATA			
Outer cabinet	White	White	White
Inner cabinet	White	White	White
Graphics	Optional	Optional	Optional
Type of cooling	Static	Static	Static
Dual mode cool/freeze	optional	optional	optional
Type of defrost	Manual	Manual	Manual
Automatic defrost	Optional	Optional	Optional
Digital controller	Incl.	Incl.	Incl.
Power	230 v/ 50 hz	230 v/ 50 hz	230 v/ 50 hz
Power 110volt / 60 hz	Optional	Optional	Optional
Net weight, kg	98	123	100
Gross weight, kg	113	138	125

SHIPPING			
20' cont. Capacity	14	12	12
40' cont. Capacity	28	24	24
40' HC cont. Capacity	28	24	24
Standard Trailer capacity	32	28	28

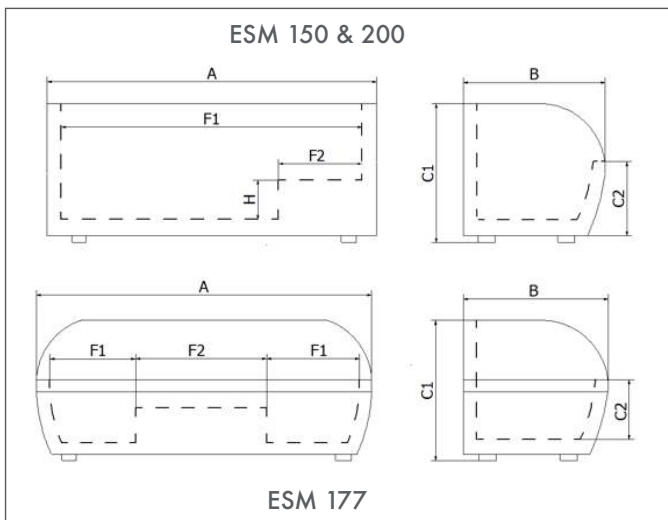

# FEATURES

- Low service costs
- Perfect view to the products
- Long life
- Minimum icebuild-up
- Eye Catching design
- LED internal light
- 70 mm insulation
- Graphics (option)
- Auto Defrost (option)
- Switch mode between cooling and freezing (option)
- Accessories including baskets - see page 65
- Options:
  - Variable speed compressor
  - Combi mode of cooler and freezer
  - Evaporated defrost



## | GSM |

### HIGH VOLUME AND PERFECT DISPLAY



GSM 200



GSM ISLAND



CONTROLLER

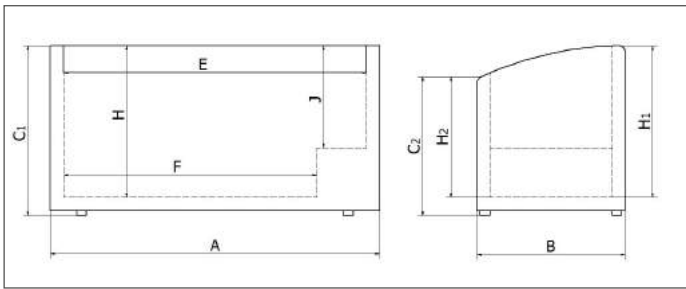

Dimensions according to technical datas below

	GSM 150	GSM 200	GSM 220	GSM 250	GSM 197
Climate class	3LN1	3LN1	3LN1	3LN1	3LN1
Ambient temp. range	+10 to +25	+10 to +25	+10 to +25	+10 to +25	+10 to +25
Climate class 4 and 7(4+)	Optional	Optional	Optional	Optional	Optional
Gross volume, litres	590	800	870	1030	540
Net volume, litres	400	580	630	750	430
Temperature range inside unit	-18 to -28	-18 to -28	-18 to -28	-18 to -28	-18 to -28
Refrigerant: R290	Yes	Yes	yes	Yes	Yes
Number of compressors	2	2	2	2	2
Energy consumption / 24 h kwh	6	6,1	6,8	7,4	6,3
Annual energy consumption /kwh	2248	2358	2573	2847	2464
Energy efficiency index	41,6	33,9	34,4	30,6	33,7
Energy class	D	C	C	C	C
Input power (watt) R290	644	662	662	681	656
<b>DIMENSIONS</b>					
External dimensions (WxDxC1)	1520*920*790	2020*920*790	2200*920*790	2500*920*790	1990*920*790
Internal dimensions (WxDxH1)	1364*775*720	1864*775*720	2044*775*720	2344*775*720	1830*775*720
Dimension A	1520	2020	2200	2500	1990
Dimension B	920	920	920	920	920
Dimension C1	790	790	790	790	790
Dimension C2	710	710	710	710	710
Dimension E	1364	1864	2044	2344	1830
Dimension F	1054	1554	1734	2034	1520
Dimensions H1	720	720	720	720	720
Dimension H2	640	640	640	640	640
Dimension J	438	438	438	438	438
Insulation, mm	70	70	70	70	70
<b>ACCESSORIES</b>					
Number of baskets: standard / maximum	0/3	0/5	0/6	0/7	n/a
Number of dividers: standard / maximum	1/1	2/2	2/2	2/2	2/2
Feet	Incl.	Incl.	incl	Incl.	Incl.
Lock	n/a	n/a	n/a	n/a	n/a
Bumper bar	Incl.	Incl.	incl	Incl.	Incl.
Price ticket holder	Optional	Optional	Optional	Optional	Optional
Single or double shelve	Optional	Optional	Optional	Optional	Optional
LED light	Incl.	Incl.	incl	Incl.	Incl.
Digital controller	Incl.	Incl.	incl	Incl.	Incl.
Graphics	Optional	Optional	Optional	Optional	Optional
<b>OTHER DATA</b>					
Outer cabinet	White	White	White	White	White
Inner cabinet	White	White	White	White	White
Type of cooling	Static	Static	static	Static	Static
Evaporating defrost	Yes	Yes	Yes	Yes	Yes
Dual mode cool/freeze	Optional	Optional	Optional	Optional	Optional
Variable speed compressor	Optional	Optional	Optional	Optional	Optional
Power	230 v/ 50 hz	230 v/ 50 hz	230 v/ 50 Hz	230 v/ 50 hz	230 v/ 50 hz
Power 110 volt / 60 hz	Optional	Optional	Optional	Optional	Optional
Net weight	98	127	135	150	121
Gross weight	129	161	190	190	155
<b>SHIPPING</b>					
20' cont. Capacity	12	12	12	8	12
40' cont. Capacity	28	24	24	16	22
40' HC cont. Capacity	42	33	33	24	33
Standard Trailer capacity	48	39	39	30	39



FSM 200

# | FSM |

## TRADITIONAL SUPERMARKET FREEZERS



FSM 150



FSM 200



FSM 250

# FEATURES

- Low service costs
- Long life
- Minimum icebuild-up
- 60 mm insulation
- Graphics (option)
- Accessories including baskets  
- see page 65
- Options:
  - Combi mode of cooler and freezer
  - Automated defrost

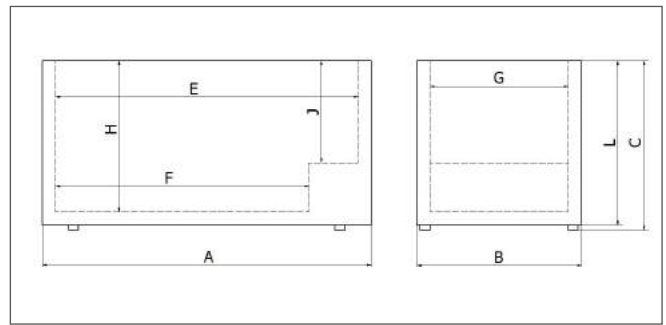

Dimensions according to technical datas below



	FSM 150	FSM 200	FSM 250
Climate class	3LN1	3LN1	3LN1
Ambient temperature range	+10 to +25	+10 to +25	+10 to +25
Climate class4 and 7(4+)	Optional	Optional	Optional
Gross volume, litres	597	839	1032
Net volume, litres	459	652	805
Temperature range inside unit	-18 to -28	-18 to -28	-18 to -28
Refrigerant: R290a	Yes	Yes	Yes
Number of compressors	2	2	2
Energy consumption / 24 h kwh	3,9	4,5	5,4
Annual energy consumption / kwh	1424	1643,0	1789
Energy efficiency Index	28	25,7	24,7
Energy Class	C	C	C
Input power (watt)	316	356	356
<b>DIMENSIONS</b>			
External dimensions (WxDxH)	1550*960*780	2050*960*780	2500*960*780
Internal dimensions (WxDxH)	1375*790*570	1880*790*570	2280*790*570
Dimension A	1550	2050	2505
Dimension B	960	960	960
Dimension C	780	780	780
Dimension E	1375	1880	2280
Dimension F	1065	1570	1970
Dimension J	280	280	280
Dimension G	790	790	790
Dimension H	570	570	570
Dimension L	700	700	700
Insulation, mm	60	60	60
<b>ACCESSORIES</b>			
Number of baskets: standard / maximum	1/3	1/5	1/7
Number of dividers: standard / maximum	2/5	3/7	3/10
Feet	Incl.	Incl.	Incl.
Lock	n/a	n/a	n/a
Bumper bar	Incl.	Incl.	Incl.
<b>OTHER DATA</b>			
Outer cabinet	White	White	White
Inner cabinet	White	White	White
Type of cooling	Static	Static	Static
Type of defrost	Manual	Manual	Manual
Auto defrost	Optional	Optional	optional
Dual mode cool/freeze	Optional	Optional	optional
Power*	220 v /50 Hz	220 v /50 Hz	220 v /50 Hz
Power 110volt / 60 hz	Optional	Optional	optional
Net weight, kg	81	105	125
<b>GROSS WEIGHT, KG</b>	<b>96</b>	<b>120</b>	<b>142</b>
20' cont. Capacity	12	10	8
40' cont. Capacity	28	22	16
40' HC cont. Capacity	42	33	24
Standard Trailer capacity	48	39	30





DISPLAY  
COOLERS

# FEATURES

- Low service costs
- Long life
- Available in all climate classes
- Accessories including baskets - see page 63



EBC 61

## | EBC COOLER |

RELIABLE AND TRADITIONAL  
**STORAGE**



EBC 22



EBC 35



EBC 45



EBC 53



EBC 61





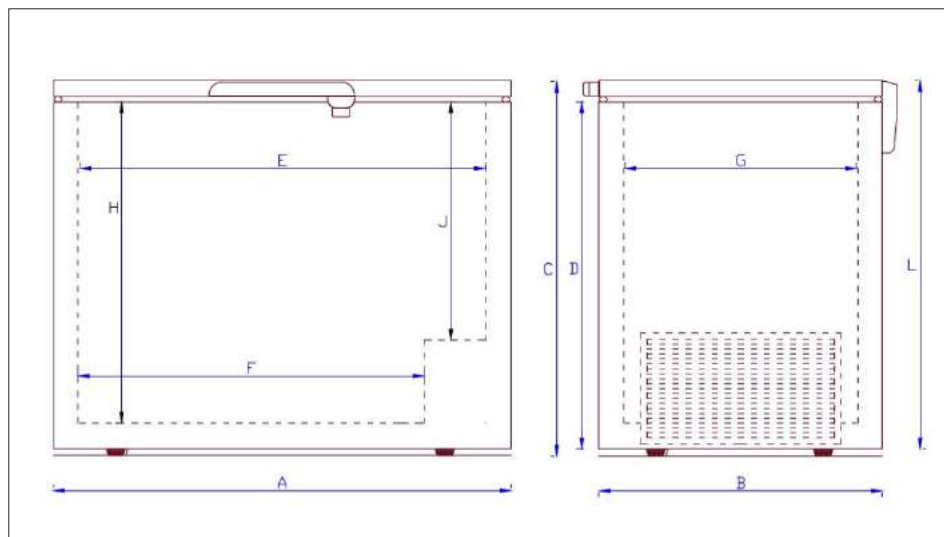

	EBC 22	EBC 35	EBC 45	EBC 53	EBC 61
Ambient temperature range	+10 to +30	+10 to +30	+10 to +30	+10 to +30	+10 to +30
Gross volume, litres	215	347	447	527	607
Net volume, litres	205	331	427	504	580
Temperature range inside unit	+2 to +8	-30 to -60	+2 to +8	+2 to +8	+2 to +8
Refrigerant: R600	Yes	Yes	Yes	Yes	Yes
Energy cons. / 24 h kwh at 18 deg. C	0,71	0,9	1,05	1,3	1,52
Input power (watt)	124	141	146	211	211
<b>DIMENSIONS</b>					
External dimensions (WxDxH)	725x655x865	1055x655x865	1305x655x865	1505x655x865	1705x655x865
Internal dimensions (WxDxH)	606x536x745	936x536x745	1186x536x745	1386x536x745	1586x536x745
Dimension A	725	1055	1305	1505	1705
Dimension B	655	655	655	655	655
Dimension C	865	865	865	865	865
Dimension D	780	780	780	780	780
Dimension E	606	936	1186	1386	1586
Dimension F	406	736	986	1186	1386
Dimension G	536	536	536	536	536
Dimension H	697	697	697	697	697
Dimension J	447	447	447	447	447
Dimension L	850	850	850	850	850
Insulation (mm)	60	60	60	60	60
<b>ACCESSORIES</b>					
Dividers	Optional	Optional	Optional	Optional	Optional
Baskets Incl.	1	2	2	3	3
Max. number of baskets possible	2	2	4	4	4
Castors	Optional	Optional	Optional	Optional	Optional
Castors w. brakes	Optional	Optional	Optional	Optional	Optional
Lock	Not Incl.	Not Incl.	Not Incl.	Not Incl.	Not Incl.
<b>OTHER DATA</b>					
Outer cabinet	White	White	White	White	White
Inner cabinet	Steel inner liner	Steel inner liner	Steel inner liner	Steel inner liner	Steel inner liner
Type of cooling	Static	Static	Static	Static	Static
Type of defrost	Manual	Manual	Manual	Manual	Manual
Power	220 v/ 50 Hz	220 v/ 50 Hz	220 v/ 50 Hz	220 v/ 50 Hz	220 v/ 50 Hz
Power 110 v/ 60 Hz	Optional	Optional	Optional	Optional	Optional
Thermostat	Analog	Analog	Analog	Analog	Analog
Net weight, kg	43	54	64	67	77
Gross weight, kg	46	58	68	71	82
<b>SHIPPING</b>					
20' cont. Capacity	42	30	24	20	18
40' cont. Capacity	90	64	50	46	40
40' HC cont. Capacity	126	88	62	61	52
Standard Trailer capacity	102	74	60	52	44

# I CAN COOLER & ESC BACK BAR COOLERS | A GOOD VIEW



CAN COOLER ETK 41



ESC-BACK BAR

## FEATURES

- Graphics (option)

ETK 41	
Ambient temperature range	+10 to +30
Volume	40
Temperature range inside unit	+2 to +10
Refrigerant	R600a
Energy consumption / 24 h (kwh) at 18 deg	0,39
Annual energy consumption (kwh)	142
Energy efficiency index	16,3
Energy class	B
Input power (watt)	100
<b>DIMENSIONS</b>	
External dimensions (wxdxh)	ø 445
Height	735
Insulation	42
<b>ACCESSORIES</b>	
Castors	Incl.
Lock	n/a
Thermometer	n/a
Internal light	n/a
<b>OTHER DATA</b>	
Outer cabinet	White
Inner cabinet	White
Graphics	Optional
Type of cooling	Static
Defrost	Manual
Power*	220 V / 50 Hz
Power 110 volt / 60 Hz	n/a
Net weight, kg	17
Gross weight, kg	19
<b>SHIPPING</b>	
40' cont. Capacity	375

	ESC 141	ESC 211	ESC 311
Ambient temperature range	+10 to +25	+10 to +25	+10 to +25
GrossVolume	136	211	324
Temperature range inside unit	0 - +10	0 - +10	0 - +10
Refrigerant	R600a	R600a	R600a
Input power (watt)	160	190	220
Energy consumption / 24 h (kwh)	1,1	1,7	1,9
Annual energy consumption	402	613	683
Energy efficiency index	37,2	48,2	44,7
Energy class	D	D	D
<b>DIMENSIONS</b>			
External dimensions (WxDxH)	600*530*865	900*520*865	1350*520*865
Internal dimensions (WxDxH)	520*385*715	820*385*715	1250*385*715
<b>OTHER DATA</b>			
Shelves	2	4	6
Ajustable feet	Included	Included	Included
Lock	Included	Included	Included
Internal light	LED	LED	LED
Outer cabinet	Black	Black	Black
Inner cabinet	Alu	Alu	Alu
Electronic controller	Included	Included	Included
Type of cooling	Ventilated	Ventilated	Ventilated
Power*	220 V / 50 Hz	220 V / 50 Hz	220 V / 50 Hz
Net weight, kg	42	59	82
Gross weight, kg	46	63	86
<b>SHIPPING</b>			
40'HC cont. Capacity	144	96	66



# FEATURES

- Flexible unit
- Low service costs
- Available in all climate classes
- Temperature range: +2 to 8 degree or -16 to -23 degree
- Graphics (option)

We offer a high quality and flexible product, which can either be used as a cooler or as a freezer. You just have to turn the switch to choose. Both versions has its own thermostat. The minimum quantity per model is 20 units.

## | COMBI | COMBINATION OF COOLER AND FREEZER



CVG 45



FOCUS 151 RED



TRICYCLE FOR MOBILUX 11



NOVA 53



A close-up photograph of a hand holding a glass pipette, dispensing a clear liquid into a petri dish. The background is a blurred laboratory setting with other petri dishes and glassware. The overall color palette is dominated by light blues and whites, creating a clean and professional atmosphere.

LABORATORY  
& MEDICAL  
EQUIPMENT

# FEATURES

- Used by universities, hospitals and research institutes for long term storing of blood, skincells, DNA and organs
- Digital controller with potential free contact (which makes it possible to connect it to an external alarm)



LAB 11



DIGITAL CONTROLLER

## | LAB |

### RELIABLE STORING AT **LOW** **TEMPERATURE**



LAB 31



ALARM BOX

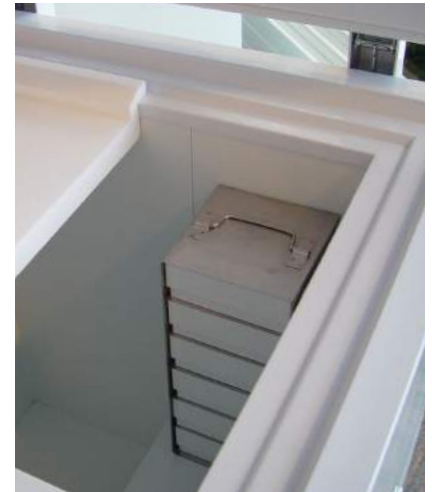
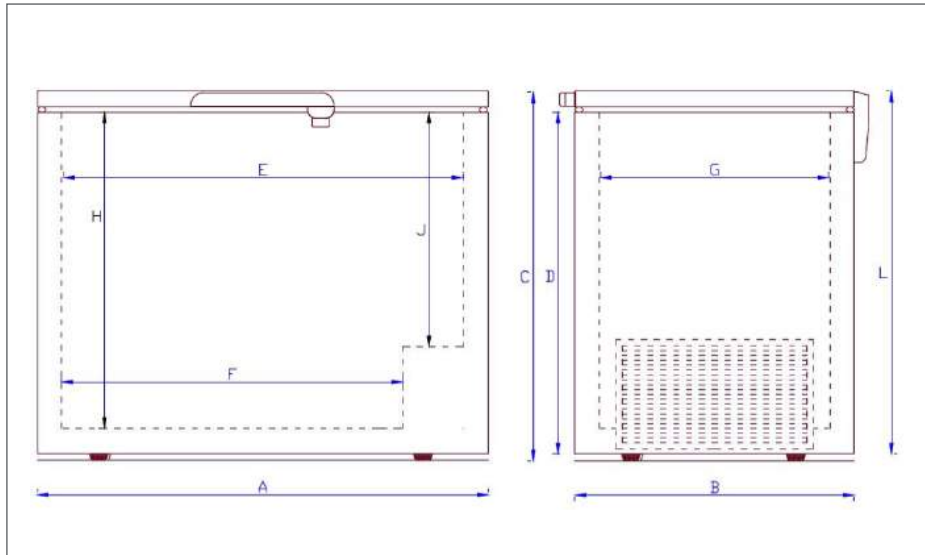

Inner lids (left hand side) which are mandatory for optimized function

	LAB 11	LAB 31
Ambient temperature range	+10 to +30	+10 to +25
Gross volume, litres	130	300
Net volume, litres	130	300
Temperature range inside unit	-50 to -86	-50 to -86
Refrigerant: Mix of Hydro Carbons	Yes	Yes
Energy consumption / 24 h kwh	5,8	8,5
Input power (watt):	480	710
<b>DIMENSIONS</b>		
External dimensions (WxDxH)	725*655*865	1305*655*865
Internal dimensions (WxDxH)	520*450*650	1100*450*650
Dimension A	725	1305
Dimension B	655	655
Dimension C	865	865
Dimension D	780	780
Dimension E	520	1100
Dimension F	320	900
Dimension G	450	450
Dimension H	620	620
Dimension J	370	370
Dimension L	850	850
Insulation, mm	100	100
<b>ACCESSORIES</b>		
Basket and dividers	n/a	n/a
Castors with brakes	Incl.	Incl.
Lock	Incl.	Incl.
Digital controller w. acoustic alarm	Incl.	Incl.
Data logger (independent)	Option	Option
<b>OTHER DATA</b>		
Outer cabinet	White	White
Inner cabinet	Painted steel	Painted steel
Potential free contact	Incl.	Incl.
Inner foam lids incl (pcs)	2	5
Type of cooling	Static	Static
Type of defrost	Manual	Manual
Power*	220V/50Hz	220V/50Hz
Power 110volt / 60 Hz	n/a	n/a
Thermostat	Digital	Digital
Net weight, kg	56	80
Gross weight, kg	63	88
<b>SHIPPING</b>		
20' cont. Capacity	42	24
40' cont. Capacity	90	50
Standard Trailer capacity	102	60

# FEATURES

- Used by universities, hospitals and research institutes for long term storing of blood, skin cells, DNA, organs and vaccines
- Digital controller with potential free contact (which makes it possible to connect it to an external alarm)



VAC 11

## | VAC |

RELIABLE  
STORING AT **LOW**  
**TEMPERATURE**



VAC 21



VAC 31



DIGITAL CONTROLLER



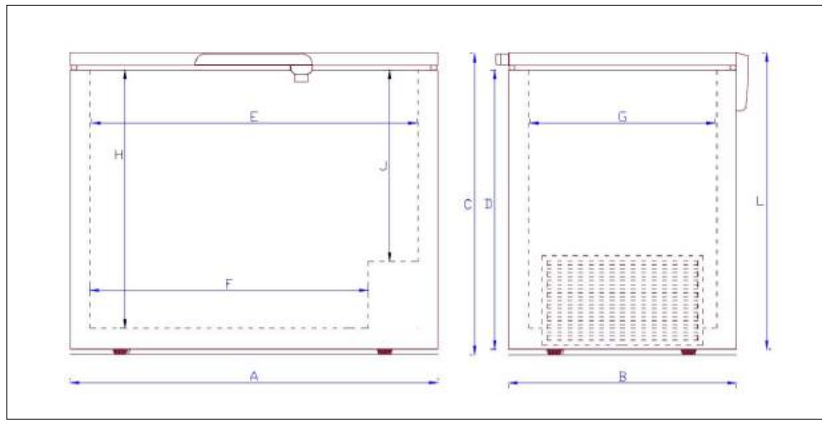

Inner lids (left hand side) which are mandatory for optimized function

	VAC 11	VAC 21	VAC 31
Ambient temperature range	+10 to +25	+10 to +25	+10 to +25
Gross volume, litres	130	226	300
Net volume, litres	130	226	300
Temperature range inside unit (Celcius)	-20 to -70	-20 to -70	-20 to -70
Refrigerant: Mix of 2 Hydro carbons	Yes	Yes	Yes
Energy consumption / 24 h kwh	4,3	5	5,2
Input power (watt)	375	455	544
<b>DIMENSIONS</b>			
External dimensions (WxDxH)	725*655*865	1055*655*865	1305*655*865
Internal dimensions (WxDxH)	520*450*650	850*450*650	1100*450*650
Dimension A	725	1055	1305
Dimension B	655	655	655
Dimension C	865	865	865
Dimension D	780	780	780
Dimension E	520	850	1100
Dimension F	320	650	900
Dimension G	450	450	450
Dimension H	650	650	650
Dimension J	400	400	400
Dimension L	850	850	850
Insulation (mm)	100	100	100
<b>ACCESSORIES</b>			
Dividers	Optional	Optional	Optional
Max. number of baskets (option)	0	0	0
EPS Inner lids	Incl.	Incl.	Incl.
Castors w. brakes	Incl.	Incl.	Incl.
Lock	Incl.	Incl.	Incl.
Digital controller w. acoustic alarm	Incl.	Incl.	Incl.
<b>OTHER DATA</b>			
Outer cabinet	White	White	White
Inner cabinet	Steel inner liner	Steel inner liner	Steel inner liner
Type of cooling	Static	Static	Static
Type of defrost	Manual	Manual	Manual
Power	220V/50Hz	220V/50hz	220V/50hz
Power 110volt / 60 hz	Optional	Optional	Optional
Potential free contact	Incl.	Incl.	Incl.
Thermostat	Digital	Digital	Digital
Net weight, kg	56	67	80
Gross weight, kg	63	74	88
<b>SHIPPING</b>			
20' cont. Capacity	42	30	24
40' cont. Capacity	90	64	50
Standard Trailer capacity	102	72	56



## FEATURES

- Low service costs
- Long life
- Perfect for storage of rubber and steel for testing
- Digital controller with potential free contact (which makes it possible to connect it to an external alarm)
- Accessories including baskets - see page 64

# | PRO |

## LOW TEMPERATURE FOR INDUSTRIAL RESEARCH

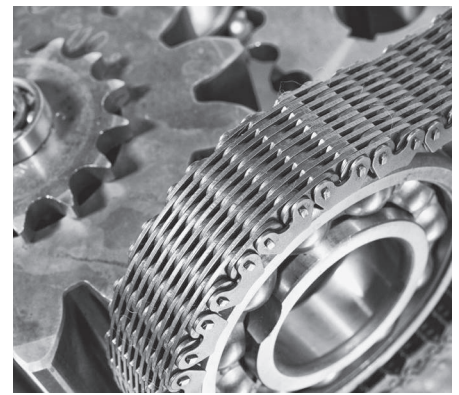

PRO 11



PRO 21



PRO 31



DIGITAL CONTROLLER



PRO 41



PRO 60

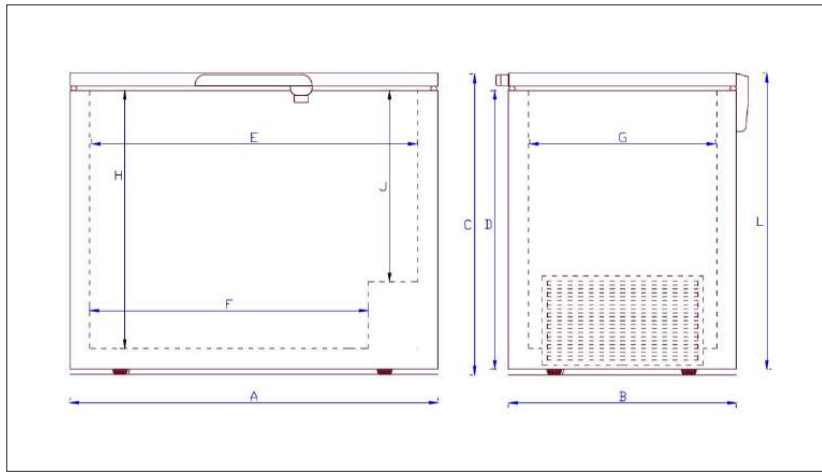

	PRO 11	PRO 21	PRO 31	PRO 41	PRO 60
Ambient temperature range	+10 to +30	+10 to +30	+10 to +30	+10 to +30	+10 to +30
Gross volume, litres	130	226	300	360	481
Net volume, litres	130	226	300	360	481
Temperature range inside unit	-30 to -60	-30 to -60	-30 to -60	-30 to -60	-30 to -60
Refrigerant: Mix of 2 Hydro carbons	Yes	Yes	Yes	Yes	Yes
Energy consumption / 24 h kwh	4,3	5	5,2	6,1	9,2
Input power (watt)	375	455	544	587	612
<b>DIMENSIONS</b>					
External dimensions (WxDxH)	725*655*865	1055*655*865	1305*655*865	1505*655*865	1705*655*865
Internal dimensions (WxDxH)	520*450*650	850*450*650	1100*450*650	1300*450*650	1540*490*670
Dimension A	725	1055	1305	1505	1705
Dimension B	655	655	655	655	655
Dimension C	865	865	865	865	865
Dimension D	780	780	780	780	780
Dimension E	520	850	1100	1300	1540
Dimension F	320	650	900	1100	1340
Dimension G	450	450	450	450	490
Dimension H	650	650	650	650	670
Dimension J	400	400	400	400	420
Dimension L	850	850	850	850	850
Insulation (mm)	100	100	100	100	80
<b>ACCESSORIES</b>					
Dividers	Optional	Optional	Optional	Optional	Optional
Max. number of baskets (option)	2	3	4	5	n/a
Castors w. brakes	Incl.	Incl.	Incl.	Incl.	Incl.
Lock	Incl.	Incl.	Incl.	Incl.	Incl.
Digital controller w. acoustic alarm	Incl.	Incl.	Incl.	Incl.	Incl.
<b>OTHER DATA</b>					
Outer cabinet	White	White	White	White	White
Inner cabinet	Steel inner liner	Steel inner liner	Steel inner liner	Steel inner liner	Steel inner liner
Type of cooling	Static	Static	Static	Static	Static
Type of defrost	Manual	Manual	Manual	Manual	Manual
Power	220V/50Hz	220V/50Hz	220V/50Hz	220V/50Hz	220V/50Hz
Power 110volt / 60 hz	Optional	Optional	Optional	Optional	Optional
Potential free contact	Incl.	Incl.	Incl.	Incl.	Incl.
Thermostat	Digital	Digital	Digital	Digital	Digital
Net weight, kg	56	67	80	89	95
Gross weight, kg	63	74	88	97	104
<b>SHIPPING</b>					
20' cont. Capacity	42	30	24	20	18
40' cont. Capacity	90	64	50	44	38
Standard Trailer capacity	102	72	56	50	44



UNI 31

## FEATURES

- Low service costs
- Long life
- Short term storage of blood and plasma
- Digital controller with potential free contact (which makes it possible to connect it to an external alarm)
- Accessories including baskets - see page 64

# | UNI |

PERFECT FOR RELIABLE  
STORING IN LOW TEMPERATURE



UNI 11



UNI 21



UNI 41



DIGITAL CONTROLLER



UNI 51

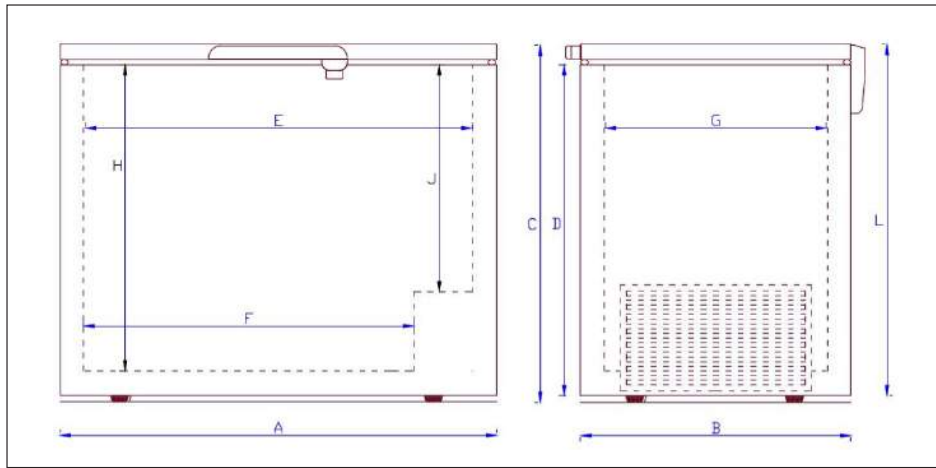

	UNI 11	UNI 21	UNI 31	UNI 41	UNI 51
Ambient temperature range	+10 to +30	+10 to +30	+10 to +30	+10 to +30	+10 to +30
Gross volume, litres	130	226	300	360	416
Net volume, litres	130	226	300	360	416
Temperature range inside unit	-10 to -45	-10 to -45	-10 to -45	-10 to -45	-10 to -45
Refrigerant: R290	Yes	Yes	Yes	Yes	Yes
Energy consumption / 24 h kwh- estimated	1,0	1,5	1,5	1,8	2,0
AEC	377	539	555	641	725
EEl	31,4	35,2	31,1	32,2	33,2
Energy class	C	C	B	C	C
Input power	210	340	380	400	420
<b>DIMENSIONS</b>					
External dimensions (WxDxH)	725*655*865	1055*655*865	1305*655*865	1505*655*865	1705*655*865
Internal dimensions (WxDxH)	520*450*650	850*450*650	1100*450*650	1300*450*650	1500*450*650
Dimension A	725	1055	1305	1505	1705
Dimension B	655	655	655	655	655
Dimension C	865	865	865	865	865
Dimension D	780	780	780	780	780
Dimension E	520	850	1100	1300	1500
Dimension F	320	650	900	1100	1300
Dimension G	450	450	450	450	450
Dimension H	650	650	650	650	650
Dimension J	400	400	400	400	400
Dimension L	850	850	850	850	850
Insulation, mm	100	100	100	100	100
<b>ACCESSORIES</b>					
Dividers	Optional	Optional	Optional	Optional	Optional
Max. number of baskets (option) KURVUNIO1	2	3	4	5	5
Castors	Optional	Optional	Optional	Optional	Optional
Castors w. brakes	Optional	Optional	Optional	Optional	Optional
Lock	Incl.	Incl.	Incl.	Incl.	Incl.
Digital controller w. acoustic alarm	Incl.	Incl.	Incl.	Incl.	Incl.
<b>OTHER DATA</b>					
Outer cabinet	White	White	White	White	White
Inner cabinet	Steel inner liner	Steel inner liner	Steel inner liner	Steel inner liner	Steel inner liner
Type of cooling	Static	Static	Static	Static	Static
Type of defrost	Manual	Manual	Manual	Manual	Manual
Power	220V/50Hz	220V/50Hz	220V/50Hz	220V/50Hz	220V/50Hz
Power 110volt / 60 hz	Optional	Optional	Optional	Optional	Optional
Potential free contact	Incl.	Incl.	Incl.	Incl.	Incl.
Thermostat	Digital	Digital	Digital	Digital	Digital
Net weight, kg	46	59	67	74	80
Gross weight, kg	49	62	71	78	85
<b>SHIPPING</b>					
20' cont. Capacity	42	30	24	20	18
40' cont. Capacity	90	64	50	46	40
Standard Trailer capacity	102	74	60	52	44

# | ACCESSORIES |

## BASKETS

### FOCUS



BASKET: KURVC75-01  
W X H: 215 X 226 MM  
DIVIDER: SKILC75-01



BASKET: KURVC75-02  
W X H: 185 X 226 MM  
DIVIDER: SKILC75-02

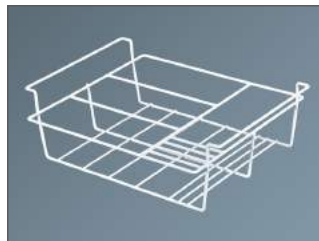

SCOOP BASKET:  
KURVSCOOPF3+1  
W X H: 442 X 123 MM



SCOOPBASKET:  
KURVSCOOPF4+1  
W X H: 587 X 123 MM

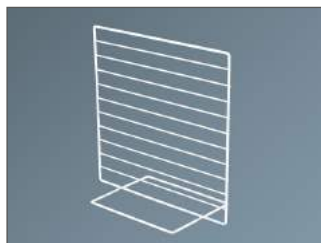

DIVIDER: DELERIST  
W X H: 430 X 430 MM

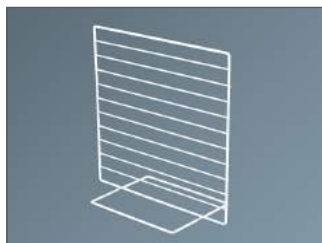

DIVIDER: DELERIST2  
W X H: 480 X 490 MM

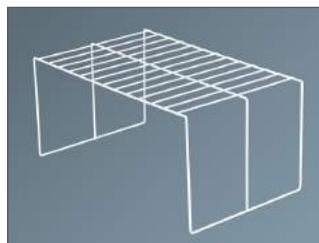

FALSE BOTTOM: FALSKBUND4  
W X H: 315 X 252 MM

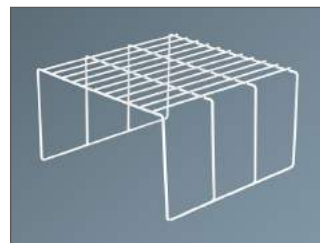

FALSE BOTTOM: FALSKBUND5  
W X D: 430 X 252 MM



PLEXI DIVIDER



FOOD BUCKET: PLASTD21

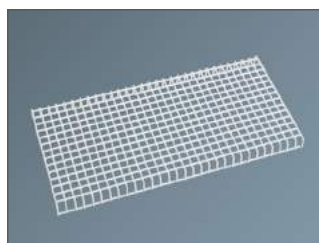

FALSE BOTTOM: FALSKBUND6

### MOBILUX



BASKET: KURVSLEH  
W X H: 267 X 180 MM

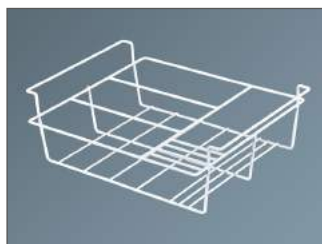

SCOOP BASKET: ONLY FOR  
MOBILUX 11  
KURVSCOOPF3+1  
W X H: 442 X 123 MM

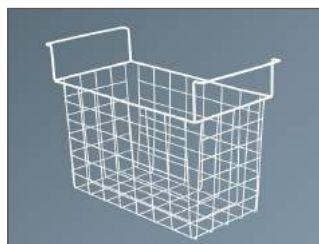

BASKET: KURVUNI01  
DIVIDER: SKILO1  
W X H: 256 X 260 MM

## CVG + EL + EL SS + EBC



BASKET: KURVC145 (NOT SUITABLE FOR EL 71), W X H: 225 X 320 MM  
DIVIDER: SKILC145



BASKET: KURVC150 (NOT SUITABLE FOR EL 71)  
W X H: 278 X 196 MM



DIVIDER: DELERIST3  
W X D: 530 X 640 MM

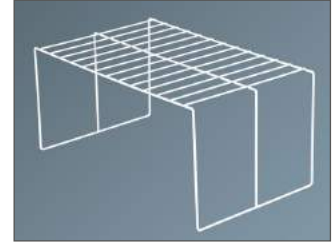

FALSE BOTTOM: FALSKBUND1  
W X H: 320 X 252 MM

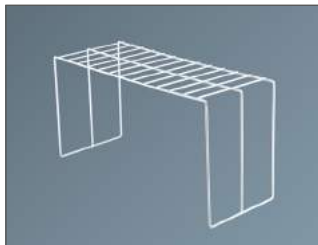

FALSE BOTTOM: FALSKBUND 2  
W X D: 200 X 252 MM

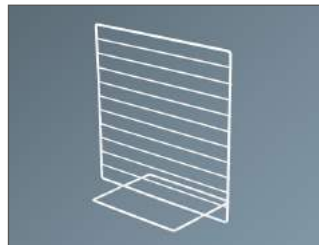

DIVIDER: DELERIST2 (ONLY FOR EL)  
W X H: 480 X 490 MM



BASKET: KURVC200F (ONLY FOR EL71)  
W X D: 278 X 311



SUPERMARKET DIVIDER FOR CVG 61 AND EL 61

## NOVA + CUBE



BASKET: KURVN1  
W X H: 272 X 235 MM  
DIVIDER: SKILO3



SCOOP BASKET: KURVSCOOPICEN3+1  
W X H: 442 X 125 MM



SCOOP BASKET: KURVSCOOPICEN4+1  
W X H: 587 X 125 MM

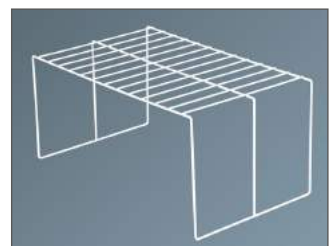

FALSE BOTTOM: FALSKBUND1  
W X H: 320 X 252 MM

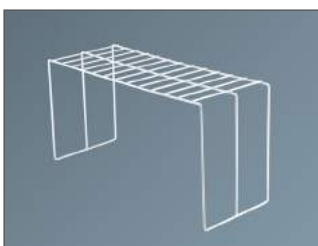

FALSE BOTTOM: FALSKBUND 2  
W X D: 200 X 252 MM



BASKET: KURVN4  
W X D: 150 X 130 MM



DIVIDER: DELERIST3  
W X D: 530 X 640 MM

# | ACCESSORIES |

## BASKETS

### UNI-S + UNI + XLE + PRO

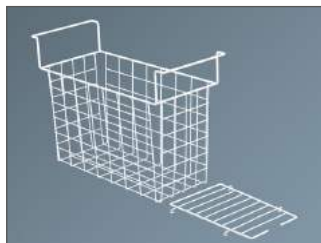

BASKET: KURVSLEDD2  
W X H: 205 X 260 MM  
DIVIDER: SKIL SLEDD2



BASKET: KURVUNI01  
DIVIDER: SKIL01  
W X H: 256 X 260 MM



BASKET: KURVSLEH  
W X H: 267 X 180 MM

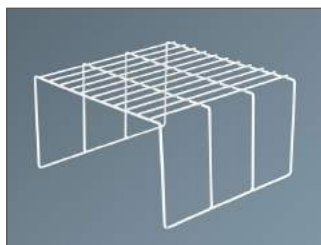

FALSE BOTTOM: FALSKBUND5  
W X H: 430 X 252 M

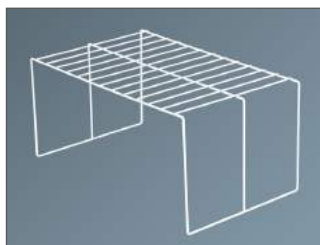

FALSE BOTTOM: FALSKBUND4  
W X H: 315 X 252 MM



# | ACCESSORIES |

## SUPERMARKET FREEZERS

### DSM + ESM + FSM + GSM



SINGLE SHELF - 1 LEVEL  
FOR GSM & ESM



DOUBLE SHELF - 1 LEVEL  
FOR DSM, GSM & ESM



SINGLE SHELF - 2 LEVELS  
FOR GSM & ESM



DOUBLE SHELF - 2 LEVELS  
FOR GSM & ESM



UNION KIT  
FOR GSM & ESM



PRICE HOLDER  
FOR FSM



PRICE HOLDER  
FOR DSM, GSM & ESM

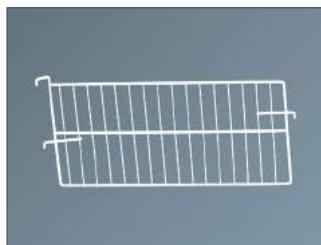

DIVIDER AR088  
FOR ESM

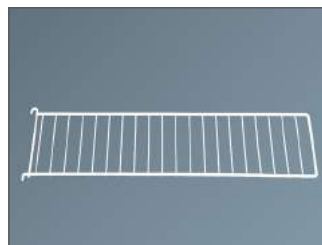

DIVIDER AR093  
FOR ESM



BASKET AR050  
FOR FSM



DIVIDER AR097  
FOR FSM



DIVIDER AR098  
FOR GSM



DIVIDER AR099  
FOR GSM



DIVIDER AR213  
FOR DSM

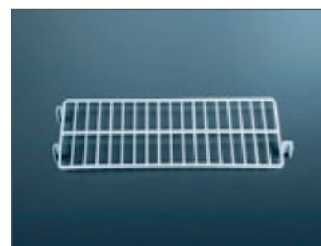

DIVIDER AR214  
FOR DSM

# | ACCESSORIES |

## ADDITIONAL EQUIPMENT

### LOCKS



**E54SD + CYLINDER 2**  
LOCK FOR CUBE, NOVA  
AND FOCUS

### CASTORS



A) HJULBØ50	SINGLE CASTOR WITH BRAKE, Ø50
B) HJULØ50	SINGLE CASTOR, Ø50
C) HJULBØ50GRÅ	DOUBLE CASTOR, Ø50
D) HJULDBØ50GRÅ	DOUBLE CASTOR WITH BRAKE, Ø50
E) HJULØ32DOBB	DOUBLE CASTORS, Ø32MM

### THERMOMETER



**TERMOMET1**  
TERMOMETER FOR BASKETS



**TERMOMETRK70**  
CIRCULAR THERMOMETER  
FOR BASKET



**FTERMOMETB2**  
DIGITAL THERMOMETER

### DISPLAY



**HBACKB22C.HBACKB71C**  
BACKBOARD

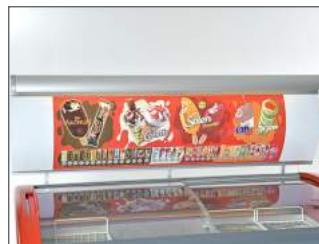

**HLS2222.HLS2271**  
S-DISPLAY

### LIGHT



**8100.0610.8100.0614**  
LED LIGHT FOR FOCUS

### BUMPERBAR



**HBB22.HBB71**  
BUMPERBAR

### KICKPLATE

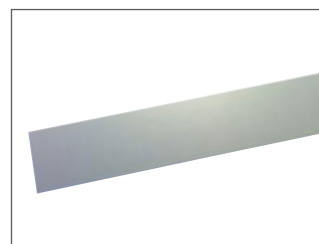

**SPARKPL**  
KICKPLATE

### CANOPY/SNEEZEGUARD



**ALUMINUM TOP CANOPY**



**GLAS TOP CANOPY**



