

*dimeda*<sup>®</sup>  
SURGICAL INSTRUMENTS

Chirurgie  
Surgery  
Chirurgie  
Cirugía  
Chirurgia



*dimeda*<sup>®</sup>  
SURGICAL INSTRUMENTS

Chirurgie  
Surgery  
Chirurgie  
Cirugía  
Chirurgia



DE

Seit 1976 sind wir erfolgreich in der Medizinbranche tätig. Wir bieten ein komplettes Programm chirurgischer Instrumente an. Im Mittelpunkt aller Maßnahmen und Aktivitäten unseres Hauses steht der Kunde. Seine Wünsche, Ansprüche und Anforderungen sind für uns eine tägliche Herausforderung. Deshalb ist absolute Kundenorientierung für uns oberstes Prinzip. Sie prägt unsere Geschäftspolitik und ist jederzeit Ansporn für das Handeln und Denken unserer Mitarbeiter. Deshalb sind wir stets für morgen gerüstet. Unser Qualitätsmanagement ist ein essentieller Bestandteil unserer langfristigen Unternehmensstrategie, in die jeder einzelne Mitarbeiter eingebunden ist und die von einem Wir-Gefühl getragen wird. Unabhängig vom jeweiligen Arbeitsplatz, fühlt sich jeder Dimeda-Mitarbeiter für die Einhaltung der Qualität verantwortlich.

EN

Since 1976 we have been working successfully in the medical field. The focus of all our measures and activities is the customer. His wishes, demands and requirements are a daily challenge for us. Therefore, customer service is our top priority. It effects our business policy and is a permanent task for every member of the DIMEDA TEAM. For this reason we are prepared for the future at any time. Our Quality Management is an essential component in our long-term company strategy in which every single employee is involved and which is supported by a common feeling. Every DIMEDA employee feels himself responsible for observance of quality no matter in which department he is active.

FR

Depuis 1976, nous travaillons avec succès dans le secteur médical. Nous offrons une gamme complète des instruments chirurgicaux. Le client est au centre de toutes les opérations et activités de notre maison. Ses souhaits, demandes et exigences sont pour nous un défi quotidien. C'est pourquoi nous avons pour principe suprême une orientation totale vers le client. Cette orientation marque fortement notre politique commerciale et représente une motivation constante de l'action et réflexion de nos collaborateurs. De ce fait, nous préparons d'une manière continuelle l'avenir. Notre management de qualité est un composant essentiel de notre stratégie d'entreprise à long terme, dans laquelle chaque collaborateur est intégré et qui est marqué par un fort esprit d'équipe. Quelque soit le poste de travail, chaque collaborateur de DIMEDA se sent responsable pour la qualité des produits.

ES

Desde 1976 trabajamos con éxito en la rama medicinal. Ofertamos completamente el instrumental quirúrgico. El objetivo de todas diligencias y actividades es la satisfacción de nuestros clientes. Sus deseos, demandas y requerimientos constituye nuestro reto diario. Por esta razón, el servicio al cliente es la premisa principal en nuestra casa, marca nuestra política empresarial y representa un constante estímulo en las tareas de todos los empleados. Por ello, nos hemos preparado para el día de mañana. La administración de cualidad es un pilar muy importante en nuestra estrategia empresarial. Todos y cada uno de los empleados se identifican con esta filosofía. Independiente de la función en la empresa, se siente cada empleado de DIMEDA responsable de su cumplimiento.

IT

Dal 1976 siamo attive nel campo di medicina con molto successo. In primo luogo viene per noi il cliente. I suoi desideri, le esigenze, le richieste sono per noi una continua sfida giornaliera. Per questo è per noi supremo principio l'orientamento della nostra clientela. Caratterizzano gli affari politici stimolano di più il modo di pensare e trattare dei nostri collaboratori. Per questo siamo sempre per il domani attrezzarti. Nostra qualità totale è un importante elemento a lungo tempo per la strategia dell'impresa. Ogni collaboratore è incluso con una sensibilità insieme. Ugual che lavoro fanno il personale di DIMEDA sono responsabile per la qualità.







Wir verfügen über modernste Logistik. Unser umfassendes Lager garantiert schnelle Lieferzeiten. Sollten Artikel nicht lagermäßig vorrätig sein, so können diese durch einen speziellen Service kurzfristig zur Verfügung gestellt und versendet werden. Alle Instrumente und Geräte aus unserem Sortiment werden von geschulten und erfahrenen Fachkräften mit handwerklichem Geschick unter Einsatz modernster Maschinen und Anlagen hergestellt. Dabei kommen ausnahmslos Materialien zum Einsatz, die unseren besonders hohen Qualitätsstandards genügen. Unsere Produktpalette mit mehr als 23.000 verschiedenen Standardinstrumenten für die Human-, Dental und Veterinärmedizin wird durch die enge Zusammenarbeit mit unseren Kunden, Ärzten und Wissenschaftlern im In- und Ausland ständig erweitert und nach dem neuesten Stand der Technik optimiert.

DE

Our extensive warehouse guarantees quick delivery times. Articles which are not available ex stock can be supplied in a short time due to a special service. All instruments and devices of our product range are manufactured by well-trained and experienced skilled workers with special craftsmanship and by use of most modern machines and equipment. On this occasion we only use materials which meet our high quality standards. Our product range with more than 23,000 different standard instruments for Human, Dental and Veterinary medical applications is permanently increased and optimized as per the state of the art by the close cooperation of our domestic and foreign customers, physicians and scientists.

EN

Nous disposons d'une logistique la plus moderne. Notre vaste stock garantit une livraison prompte. Les articles non disponibles peuvent être mis à disposition par un service spécial et expédiés très rapidement. Tous nos instruments et appareils sont fabriqués par un personnel bien formé et expérimenté, faisant preuve d'un grand savoir-faire artisanal associé aux machines et aux installations les plus modernes. Il va de soi que pour un résultat optimal, nous utilisons seulement des matériaux qui répondent aux standards de qualité particulièrement élevés. Notre gamme de produits se compose de plus de 23.000 instruments standard pour la médecine humaine, dentaire et vétérinaire. Elle s'élargit constamment grâce à l'étroite collaboration entre nos clients, des chirurgiens et des scientifiques en Allemagne et à l'étranger en appliquant les plus nouvelles techniques.

FR

Disponemos una logística de las mas modernas. Nuestro almacén extenso garantiza un despacho rapido. Sino tenemos un articulo disponible, podemos facilitar y mandarlo en corto plazo por un servicio especial. Todos nuestros productos son fabricados por personal especializado y experto con maquinas e instalaciones de las mas modernas. En ello usamos sin excepción materiales, que cumplen con nuestro estándar de alta cualidad. Nuestra gama de productos abarca mas de 23.000 diferentes instrumentos generales para la medicina humana, dental y veterinaria. A través de estrechas relaciones con nuestros clientes, cirujanos y científicos en todo el mundo, actualizamos y ampliamos constantemente nuestra técnica.

ES

Noi disponiamo di una logistica moderna. Il nostro magazzino garantisce una consegna veloce. Caso mai non sono disponibili possiamo con un servizio speciale spedirli in breve termine. Tutti strumenti del nostro assortimento vengono fatti da persone competenti con un talento professionale con un impianto di macchine moderne. In cui inseriamo materiale che è sufficiente per il nostro particolare grado di qualità. Il nostro gamma di prodotti con più di 23.000 diversi strumenti standard per la medicina Umano-, Dentali-, é Veterinari attraverso la nostra collaborazione con la clientela con persone pratiche é scienziati nel interne/estero siamo in continua estensione é ci completiamo sul nuovo livello tecnico.

IT

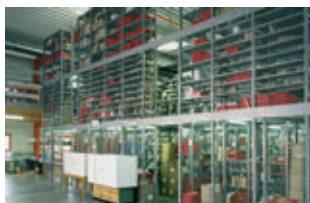

## Zeichenerklärung

Explanation of Symbols  
Explication des symboles  
Explicación de los símbolos  
Spiegazione dei simboli



Gerades Instrument  
Straight Instrument  
Instrument droit  
Instrumento recto  
Strumento retto



Gebogenes Instrument  
Curved Instrument  
Instrument courbe  
Instrumento curvo  
Strumento curvo



Scharfes Instrument  
Sharp Instrument  
Instrument pointu  
Instrumento agudo  
Strumento acuto



Stumpfes Instrument  
Blunt Instrument  
Instrument mousse  
Instrumento romo  
Strumento smusso

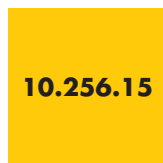

**10.256.15**

Mit TC-Einsätzen  
TC Lined  
A mors TC  
Con bocas TC  
Con morso TC

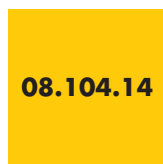

**08.104.14**

TC Schneiden  
TC Cutting Edges  
Tranchant TC  
Filos de corte TC  
Taglio TC

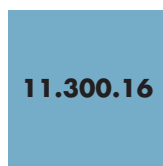

**11.300.16**

Titan  
Titanium  
Titane  
Titanio  
Titanio











## DIMEDA Instrumente GmbH











Gänsäcker 54 + 58  
D-78532 Tuttlingen, Germany









Tel. +49.7462.94 61-0  
Fax +49.7462.94 61-33

info@dimedia.de  
www.dimedia.de





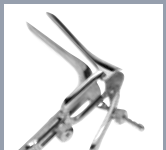

© DIMEDA Instrumente GmbH  
Art Nr. 99.999.01 12-2013  
Printed in Germany

<p><b>Diagnostik</b> Diagnostics Diagnostic Diagnóstico Diagnostica</p>	02	
<p><b>Sauger</b> Suction Tubes Tubes d'aspiration Tubos de aspiración Tubi d'aspirazione</p>	04	
<p><b>Scalpel &amp; Messer</b> Scalpel &amp; Knives Scalpel &amp; Couteaux Bisturí y Cuchillos Bisturi &amp; Coltelli</p>	06	
<p><b>Super Cut Scheren</b> Super Cut Scissors Super Cut Ciseaux Super Cut Tijeras Super Cut Forbici</p>	07	
<p><b>Scheren</b> Scissors Ciseaux Tijeras Forbici</p>	08	
<p><b>Mikro Scheren</b> Micro Scissors Micro Ciseaux Micro Tijeras Micro Forbici</p>	09	
<p><b>Pinzetten</b> Thumb and Tissue Forceps Pincés à dissection Pinzas de dissection Pinze per dissezione</p>	10 - 11	
<p><b>Arterienklemmen</b> Hemostatic Forceps Pincés hémostatiques Pinzas atraumaticas Pinze atraumatiche</p>	12	
<p><b>Tuchklemmen</b> Towel Clamps Pincés à champs Pinzas para campos Pinze fissateli</p>	14	
<p><b>Tupfer-/ Kornzangen</b> Polypus and Dressing Forceps Pincés à pansements et à polypes Pinzas para pólipos y esponjas Pinze per polipi e per tamponi</p>	16	

<b>Wundhaken</b> Retractors Ecarteurs Separadores Divaricatori	18	
<b>Sonden, Spatel, Watteträger</b> Probes, Spatulas, Applicators Sondes, Spatules, porte-coton Sondas, Espátulas, porta-algodón Sonde, Spatole, portacotone	20	
<b>Trokare, Punktionsnadeln</b> Trocars, Puncture Needles Trocarts, Aiguilles à ponction Trócares, Agujas para punción Trequarti, Aghi da punzione	22	
<b>Nadelhalter</b> Needle Holders Porte-aiguilles Porta-agujas Port'aghi	24	
<b>Naht</b> Suture Suture Sutura Sutura	26	
<b>Sterilisierhilfen</b> Sterilizing Aids Instrumente pour Sterilisation Auxilios para la esterilización Utensili per la sterilizzazione	28	
<b>Gipsverband</b> Plaster of Paris Bandages plâtrés Vendajes enyesados Bendaggi gessati	30	
<b>Orthopädie, Osteosynthese</b> Bone Surgery, Osteosynthesis Chirurgie osseuse, Ostéosynthèse Cirugía ósea, Osteosíntesis Chirurgia ossea, Osteosintesi	32 - 33	
<b>Ophthalmologie</b> Ophthalmology Ophthalmologie Oftalmología Oftalmologia	42 - 43	
<b>Otologie</b> Otology Otologie Otología Otologia	44	

<p><b>Rhinologie</b> Rhinology Rhinologie Rinología Rinologia</p>	46	
<p><b>Mund und Zunge</b> Mouth and Tongue Bouche et langue Boca y lengua Bocca e lingua</p>	48	
<p><b>Tonsillen</b> Tonsils Amygdales Amígdalas Tonsille</p>	50	
<p><b>Kehlkopf</b> Larynx Larynx Laringe Laringe</p>	52	
<p><b>Tracheotomie, Kropf</b> Tracheostomy, Goitre Trachéotomie, Goitre Traqueotomía, Bocio Tracheotomia, Gozzo</p>	54	
<p><b>Galle, Niere</b> Gall Bladder, Kidney Vesicule biliaire, Rein Vesicula biliar, Riñón Vesicola biliare, Rene</p>	62	
<p><b>Darm, Magen</b> Intestines and Stomach Intestin, Estomac Intestines, Estómago Intestini, Stomaco</p>	64	
<p><b>Urologie</b> Urology Urologie Urología Urologia</p>	66	
<p><b>Mastdarm</b> Rectum Rectum Recto Retto</p>	68	
<p><b>Gynäkologie</b> Gynecology Gynécologie Ginecología Ginecologia</p>	70	

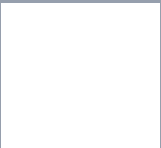
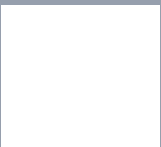
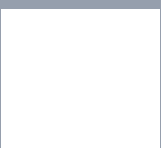
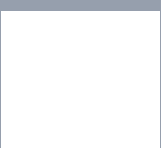

<p><b>Geburtshilfe</b>          Obstetrics          Obstétrique          Obstetricia          Ostetricia</p>	<p>72</p>	
<p><b>Dermatologie, Hygiene</b>          Dermatology, Hygiene          Dermatologie, Hygiène          Dermatología, Higiene          Dermatologia, Igiene</p>	<p>74</p>	
<p><b>Verschiedene Behälter</b>          Different Containers          Boîtes diverses          Contenedores varios          Vassoi diversi</p>	<p>88</p>	
<p><b>Inhaltsverzeichnis</b>          Alphabetic Index          Index          Índice alfabético          Indice</p>		
		
		
		
		
		
		



Diagnostik  
Diagnostics  
Diagnostic  
Diagnóstico  
Diagnostica

## Diagnostik

Diagnosics  
Diagnostic  
Diagnóstico  
Diagnostica



02.102.00  
compl.



Econom  
02.110.00  
02.112.00  
compl.



02.122.00  
compl.



02.132.00  
compl.

**Diagnostik**

Diagnosics  
Diagnostic  
Diagnóstico  
Diagnostica



**COLLIN**  
02.140.01 Erwachsene · Adult  
02.140.02 Kinder · Child · enfant  
niños · bambini



02.147.00



**VARIFOCAL**  
02.160.00



**MAY**  
02.162.00

## Diagnostik

Diagnosics  
Diagnostic  
Diagnóstico  
Diagnostica



02.170.00  
Combination



02.173.00  
Econom Universal



02.174.00  
Otoskop · Oscope · Otoscopio



**Diagnostik**

Diagnosics  
Diagnostic  
Diagnóstico  
Diagnostica

Stirnlampen  
Head Lights  
Lampes frontales  
Lámparas frontales  
Lampade frontali



02.180.91



ZIEGLER  
02.180.90  
compl.



02.180.92



CLAR  
02.190.00  
compl.  
6 V.



02.190.01



02.195.00  
compl.  
6 V.

02.200.00  
compl.  
Halogen



02.195.01



6 Volt  
02.199.06

**Diagnostik**

Diagnosics  
Diagnostic  
Diagnóstico  
Diagnostica



BOWLES  
02.240.00



DUPLEX  
02.246.00



PINARD  
02.260.15  
15 cm

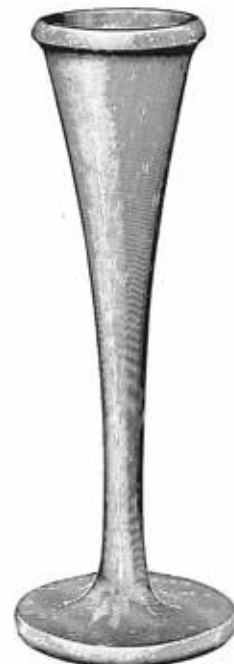

PINARD  
02.262.18  
18 cm

**Diagnostik**

Diagnosics  
Diagnostic  
Diagnóstico  
Diagnostica



cm	TAYLOR
17	02.288.17
20	02.288.20



TRAUBE  
02.290.16



BABINSKY  
02.292.22  
22 cm



TROEMNER  
02.294.24  
24 cm



DEJERINE  
02.302.20



DEJERINE  
02.304.20



BERLINER  
02.306.17

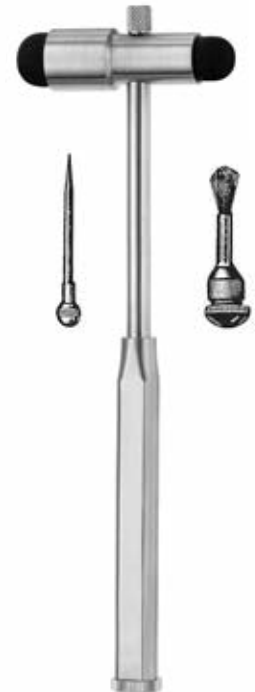

BUCK  
02.308.18

Diagnostik / Diagnosics / Diagnostic / Diagnóstico / Diagnostica

## Diagnostik

Diagnosics

Diagnostic

Diagnóstico

Diagnostica

Schädel-Messzirkel  
Cephalometer  
Céphalomètre  
Cefalómetro  
Cefalometro



BERTILLON  
02.310.01

Winkelmesser  
Goniometer  
Goniomètre  
Goniómetro  
Goniometro



MOELTGEN  
02.312.01

Nadelrad  
Pinwheel  
Algesimetre  
Rueda de espigas  
Algesimetro



WARTENBERG  
02.320.19  
19 cm

Metall-Meßstäbe  
Rulers, metal  
Règles en métal  
Reglas de metal  
Regoli in acciaio

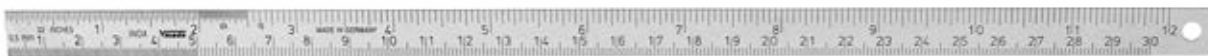

cm	inch.	
10	4	02.340.10
20	8	02.340.20
30	12	02.340.30
50	20	02.340.50



02.344.15  
15 cm



Sauger  
Suction Tubes  
Tubes d'aspiration  
Tubos de aspiración  
Tubi d'aspirazione



## Sauger

Suction Tubes  
Tubes d'aspiration  
Tubos de aspiración  
Tubi d'aspirazione



POOLE  
**04.130.10**  
ø 10 mm (30 Charr.)



POOLE  
**04.140.06** ø 6 mm (18 Charr.)  
**04.140.08** ø 8 mm (23 Charr.)

### 04.150.98

Saugspitze  
Suction Tip  
Pointe de suction  
Cabezal para aspiración  
Punta per aspirazione



komplett mit Saugspitze und  
Schlaucholive

complete with suction tip and con-  
nector

complet avec pointe de suction et  
raccord

completo con punta de succión y  
conector

completi con punte d'aspirazione  
e raccordo

### 04.150.99

Schlaucholive  
Olive  
Oliva  
Oliva

YANKAUER  
**04.150.27**  
27 cm



ANDREW-PYNCHON  
**04.153.24**  
ø 6 mm (18 Charr.)  
23 cm



WALTON-YANKAUER  
**04.152.33**  
ø 10 mm (30 Charr.)  
32 cm

mit Absperrventil und  
abschraubbarem Rohr

with stopcock and tube  
to be screwed off

avec robinet et canule  
extérieure démontable

con interruptor y tubo  
desenroscable

con interruttore e tubo  
svitabile

**Sauger**  
 Suction Tubes  
 Tubes d'aspiration  
 Tubos de aspiración  
 Tubi d'aspirazione

Saugkanülen mit Unterbrecher und Mandrin  
 Suction Cannulae with finger cut-off and stylet  
 Canules d'aspiration avec interrupteur à doigt  
 Cánulas para aspiración con interruptor y estilete  
 Cannule per aspirazione con interruttore e stiletto

Saugspitze ø 5 mm  
 Suction Tip ø 5 mm  
 Pointe de succion ø 5 mm  
 Cabezal para aspiración ø 5 mm  
 Punta per aspirazione ø 5 mm



Schlaucholive ø 9 mm  
 Olive ø 9 mm  
 Olive ø 9 mm  
 Oliva ø 9 mm  
 Oliva ø 9 mm

cm	DE BAKEY
16	<b>04.154.16</b>
26	<b>04.154.26</b>



cm	DE BAKEY
28	<b>04.154.27</b>



**04.155.99**  
 Mandrin  
 Stylet  
 Doigt  
 Estilete  
 Stiletto

cm	MAGILL	
24,5	<b>04.155.30</b>	Fig. 1, ø 3,0 mm
24,5	<b>04.155.35</b>	Fig. 2, ø 3,5 mm
24,5	<b>04.155.40</b>	Fig. 3, ø 4,0 mm

Saug- und Spülkanüle  
Suction and Irrigation Cannula  
Canules d'aspiration et d'irrigation  
Cánulas para aspiración e irrigación  
Cannule per aspirazione e irrigazione



FINSTERER  
**04.158.00**  
32 cm

runde Öffnung  
round opening  
ouverture ronde  
abertura redonda  
apertura retonda



NUBOER  
**04.160.21**  
21 cm

ovale Öffnung  
oval opening  
ouverture ovale  
abertura ovalada  
apertura ovale



NUBOER  
**04.161.21**  
21 cm

## Kathetereinführzangen

Catheter Introduction Forceps  
 Pinces pour introduire les sondes  
 Pinzas para catéteres  
 Pinze per introdurre le sonde



1/2

ADSON  
**40.290.21**  
 21 cm/8 1/4"  
 ø 4 mm

Saugkanülen mit Unterbrecher und Mandrin  
 Suction Cannulae with finger cut-off and stylet  
 Canules d'aspiration avec interrupteur à doigt  
 Cánulas para aspiración con interruptor y estilete  
 Cannule per aspirazione con interruttore e stiletto

F.G. Charr.	Ø mm	30°	75°
6	2,0	<b>40.295.06</b>	<b>40.297.06</b>
7	2,3	<b>40.295.07</b>	<b>40.297.07</b>
8	2,7	<b>40.295.08</b>	<b>40.297.08</b>
9	3,0	<b>40.295.09</b>	<b>40.297.09</b>
10	3,3	<b>40.295.10</b>	<b>40.297.10</b>
11	3,7	<b>40.295.11</b>	<b>40.297.11</b>
12	4,0	<b>40.295.12</b>	<b>40.297.12</b>
15	5,0	<b>40.295.15</b>	<b>40.297.15</b>



1/2

FRAZIER  
 19 cm/7 1/2"



cm	MAGILL
17	<b>04.190.17</b>
20	<b>04.190.20</b>
25	<b>04.190.25</b>



**04.190.17**  
 für Kleinkinder  
 for babies  
 pour nourrissons  
 para neonatales  
 per neonati



**04.190.20**  
 für Kinder  
 for children  
 pour enfants  
 para niños  
 per bambini



**04.190.25**  
 für Erwachsene  
 for adults  
 pour adultes  
 para adultos  
 per adulti





Laryngoskope  
Laryngoscopes  
Laryngoscopes  
Laringoscopios  
Laringoscopi

**Spezialkatalog**

Special catalog  
Catalogue spécial  
Catálogo especial  
Catalog speciale

***dimed***<sup>®</sup>  
SURGICAL INSTRUMENTS



Laryngoskope  
Laryngoscopes  
Laryngoscopes  
Laringoscopios  
Laringoscopi



Skalpelle, Messer  
Scalpels, Knives  
Bistouris, Couteaux  
Bisturías, Cuchillos  
Bistruí, Coltelli

**Skalpellgriffe**  
 Scalpel Handles  
 Manches de bistouris  
 Mangos de bisturís  
 Manici per bisturi

**Fig.  
3**

Skalpellgriffe, passend für  
 auswechselbare Skalpellklingen  
 Fig. 10, 11, 12, 13, 15

Scalpel Handles for scalpel  
 blades fig. 10, 11, 12, 13, 15

Manches pour bistouris, allant  
 avec les lames de bistouris  
 interchangeables  
 fig. 10, 11, 12, 13, 15

Mangos de bisturí para  
 hojas intercambiables  
 fig. 10, 11, 12, 13, 15

Manici per bisturi, per fissare  
 le lame intercambiabili  
 fig. 10, 11, 12, 13, 15



lang  
 long  
 long  
 largo  
 lungo

abgewinkelt, lang  
 angled, long  
 coudé, long  
 angulado, largo  
 angolare, lungo



Heftprofil wie Griff Fig. 4  
 handle style as fig. 4  
 manche selon fig. 4  
 mango como fig. 4  
 manico come fig. 4

mit Zentimeter-Graduierung  
 cm-graduation  
 gradué en cm  
 graduado en cm  
 graduato in cm



**06.103.00**  
 Fig. 3  
 12,0 cm

**06.103.10**  
 Fig. 3  
 12,0 cm

**06.103.01**  
 Fig. 3  
 12,0 cm

**06.103.02**  
 Fig. 3 L  
 21,5 cm

**06.103.06**  
 Fig. 3 L  
 21,0 cm

Skalpellegriffe, passend für  
auswechselbare Skalpellklingen  
Fig. 10, 11, 12, 13, 15

Scalpel Handles for scalpel  
blades fig. 10, 11, 12, 13, 15

Manches pour bistouris, allant  
avec les lames de bistouris  
interchangeables  
fig. 10, 11, 12, 13, 15

Mangos de bisturí para  
hojas intercambiables  
fig. 10, 11, 12, 13, 15

Manici per bisturi, per fissare  
le lame intercambiabili  
fig. 10, 11, 12, 13, 15

**Fig.  
3**

rund  
round  
rond  
redondo  
rotondo



**06.103.03**  
Fig. 3  
14,5 cm

rund, abgewinkelt  
round, angled  
rond, coudé  
redondo, angulado  
rotondo, angolare



**06.103.33**  
Fig. 3  
14,0 cm

rund  
round  
rond  
redondo  
rotondo



**06.103.15**  
Fig. 3  
15,0 cm

**Skalpellgriffe**  
 Scalpel Handles  
 Manches de bistouris  
 Mangos de bisturías  
 Manici per bisturi

**Fig.  
3**

Skalpellgriffe, passend für  
 auswechselbare Skalpellklingen  
 Fig. 10, 11, 12, 13, 15

Scalpel Handles for scalpel  
 blades fig. 10, 11, 12, 13, 15

Manches pour bistouris, allant  
 avec les lames de bistouris  
 interchangeables  
 fig. 10, 11, 12, 13, 15

Mangos de bisturí para  
 hojas intercambiables  
 fig. 10, 11, 12, 13, 15

Manici per bisturi, per fissare  
 le lame intercambiabili  
 fig. 10, 11, 12, 13, 15

mit rundem Hohlheft  
 with round hollow handle  
 avec manche creux rond  
 con mango hueco redondo  
 con manico vuoto, rotondo

lang  
 long  
 long  
 largo  
 lungo

lang  
 long  
 long  
 largo  
 lungo

mit Kunststoffheft  
 with plastic handle  
 avec manche en  
 matière plastique  
 con mango plástico  
 con manico di materia plastica

kurz  
 short  
 corto  
 court  
 corto

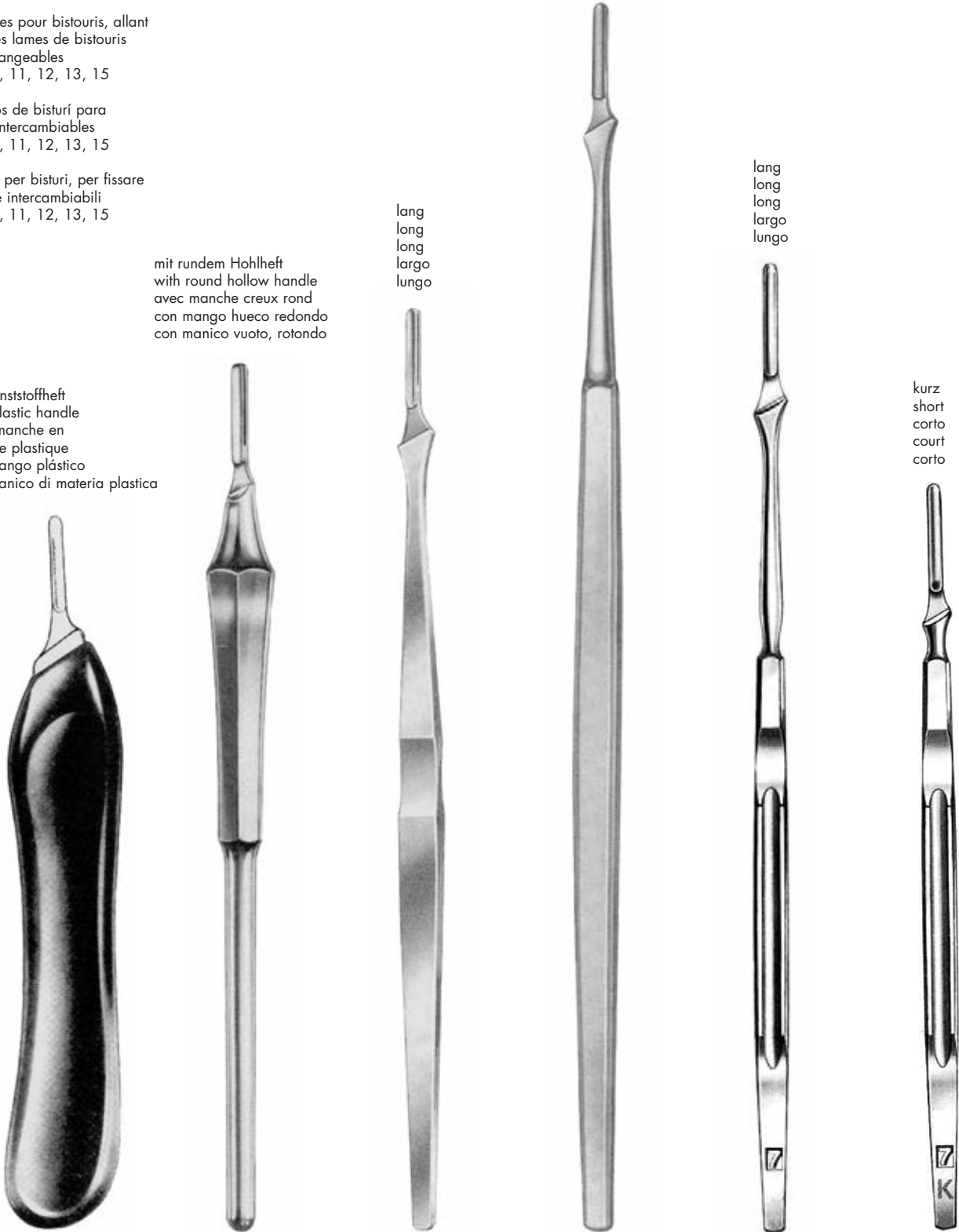

**06.103.08**  
 Fig. 3  
 12,5 cm

**06.103.09**  
 Fig. 3  
 15,5 cm

**06.105.00**  
 Fig. 5  
 16,0 cm

**06.106.00**  
 Fig. 5  
 21,5 cm

**06.107.00**  
 Fig. 7  
 16,0 cm

**06.107.01**  
 Fig. 7 K  
 12,5 cm

Skalpellegriffe, passend für  
 auswechselbare Skalpelleklingen  
 Fig. 10, 11, 12, 13, 15

Scalpel Handles for scalpel  
 blades fig. 10, 11, 12, 13, 15

Manches pour bistouris, allant  
 avec les lames de bistouris  
 interchangeables  
 fig. 10, 11, 12, 13, 15

Mangos de bisturí para  
 hojas intercambiables  
 fig. 10, 11, 12, 13, 15

Manici per bisturi, per fissare  
 le lame intercambiabili  
 fig. 10, 11, 12, 13, 15



**06.109.00**  
 21,0 cm



**06.109.16**  
 Fig. 3 + 4  
 16,0 cm

Skalpellegriff, passend für  
 auswechselbare Skalpelleklingen  
 Fig. 10 - 36

Scalpel Handle for scalpel  
 blades fig. 10 - 36

Manche pour bistouri, allant  
 avec les lames de bistouris  
 interchangeables  
 fig. 10 - 36

Mango de bisturí para  
 hojas intercambiables  
 fig. 10 - 36

Manico per bisturi, per fissare  
 le lame intercambiabili  
 fig. 10 - 36

Doppelgriff Fig. 3 + 4  
 double handle fig. 3 + 4  
 manche double fig. 3 + 4  
 mango doble fig. 3 + 4  
 manico doppio fig. 3 + 4

**Fig.**  
**3**



**Skalpellgriffe**  
Scalpel Handles  
Manches de bistouris  
Mangos de bisturís  
Manici per bisturi

Fig.  
3



**06.110.00**



**06.111.00**



**06.112.00**

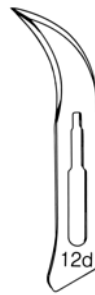

**06.112.02**



**06.115.00**



**06.115.01**



In Packungen à 100  
in packages of 100 ea  
en boîtes de 100 pieces  
en cajas de 100 c/u  
in scatole di 100 pezzi



**06.199.00**

Skalpellklingen-Entferner  
Scalpel Blade Remover  
Enlève-lame  
Quita hojas  
Distributore lame

**Skalpellgriffe**  
 Scalpel Handles  
 Manches de bistouris  
 Mangos de bisturí  
 Manici per bisturi

**Fig. 4**

Skalpellgriffe, passend für  
 auswechselbare Skalpellklingen  
 Fig. 18, 19, 20, 21, 22, 23, 24, 25, 36

Scalpel Handles for scalpel  
 blades fig. 18, 19, 20, 21, 22, 23, 24, 25, 36

Manches pour bistouris, allant  
 avec les lames de bistouris  
 interchangeables  
 fig. 18, 19, 20, 21, 22, 23, 24, 25, 36

Mangos de bisturí para  
 hojas intercambiables  
 fig. 18, 19, 20, 21, 22, 23, 24, 25, 36

Manici per bisturi, per fissare  
 le lame intercambiabili  
 fig. 18, 19, 20, 21, 22, 23, 24, 25, 36

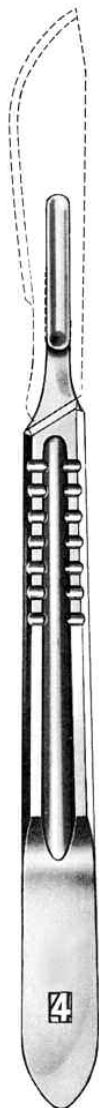

mit Zentimeter-Graduierung  
 cm-graduation  
 gradué en cm  
 graduado en cm  
 graduato in cm



lang  
 long  
 long  
 largo  
 lungo



abgewinkelt, lang  
 angled, long  
 coudé, long  
 angulado, largo  
 angolaro, lungo

**06.104.00**  
 Fig. 4  
 13,5 cm

**06.104.01**  
 Fig. 4  
 13,5 cm

**06.104.03**  
 21,5 cm

**06.104.02**  
 Fig. 4 L  
 21,0 cm

**06.104.06**  
 Fig. 4 L  
 21,0 cm

**Skalpellgriffe**  
Scalpel Handles  
Manches de bistouris  
Mangos de bisturís  
Manici per bisturi

**Fig.  
4**

Skalpellgriffe, passend für  
auswechselbare Skalpellklingen  
Fig. 18, 19, 20, 21, 22, 23, 24, 25, 36

Scalpel Handles for scalpel  
blades fig. 18, 19, 20, 21, 22, 23, 24, 25, 36

Manches pour bistouris, allant  
avec les lames de bistouris  
interchangeables  
fig. 18, 19, 20, 21, 22, 23, 24, 25, 36

Mangos de bisturí para  
hojas intercambiables  
fig. 18, 19, 20, 21, 22, 23, 24, 25, 36

Manici per bisturi, per fissare  
le lame intercambiabili  
fig. 18, 19, 20, 21, 22, 23, 24, 25, 36

mit Kunststoffheft  
with plastic handle  
avec manche en matière plastique  
con mango plástico  
con manico di materia plastica



**06.104.08**  
Fig. 4  
13,5 cm

mit Hohlheft  
with hollow handle  
avec manche creux  
con mango hueco  
con manico vuoto



COLLIN  
**06.108.00**  
Fig. 8  
13,5 cm

mit Hohlheft  
with hollow handle  
avec manche creux  
con mango hueco  
con manico vuoto



COLLIN  
**06.108.09**  
Fig. 9  
14,5 cm

**Fig.  
4**



**06.118.00**



**06.119.00**



**06.120.00**



**06.121.00**



**06.122.00**



**06.123.00**



**06.124.00**



**06.125.00**



**06.136.00**



In Packungen à 100  
 in packages of 100 ea  
 en boîtes de 100 pieces  
 en cajas de 100 c/u  
 in scatole di 100 pezzi



**06.199.00**

Skalpelligingen-Entferner  
 Scalpel Blade Remover  
 Enlève-lame  
 Quita hojas  
 Distributore lame

## Einmalskalpelle, steril

Disposable Scalpels, sterile  
Bistouris usage unique, stériles  
Bisturías uso único, estériles  
Bisturi monouso, sterili

In Packungen à 10 Stück  
in packages of 10 ea  
en boîtes de 10 pièces  
en cajas de 10 c/u  
in scatole di 10 pezzi



**06.210.00**  
Fig. 10



**06.211.00**  
Fig. 10



**06.212.00**  
Fig. 12



**06.212.02**  
Fig. 12 d



**06.215.00**  
Fig. 15



**06.215.01**  
Fig. 15 c

**Einmalskalpelle, steril**  
Disposable Scalpels, sterile  
Bistouris usage unique, stériles  
Bisturías uso único, estériles  
Bisturi monouso, sterili

**dimeda**<sup>®</sup>  
SURGICAL INSTRUMENTS

In Packungen à 10 Stück  
in packages of 10 ea  
en boîtes de 10 pieces  
en cajas de 10 c/u  
in scatole di 10 pezzi



**06.218.00**  
Fig. 18



**06.219.00**  
Fig. 19



**06.220.00**  
Fig. 20



**06.221.00**  
Fig. 21



**06.222.00**  
Fig. 22



**06.223.00**  
Fig. 23



**06.224.00**  
Fig. 24

Skalpelle, Messer / Scalpels, Knives / Bistouris, Couteaux / Bisturías, Cuchillos / Bisturi, Coltelli

## Skalpellgriffe, Mikro

Scalpel Handles, Micro  
Manches pour bistouris, Micro  
Mangos de bisturi, Micro  
Manici per bisturi, Micro

für Mikro-Skalpellklingen  
for micro scalpel blades  
pour micro-lame de bisturis  
para micro hojas  
per micro lame



**06.302.13**  
13,5 cm



**06.304.15**  
15,5 cm



CASPAR  
**06.306.18**  
18,0 cm



**06.308.20**  
20,0 cm



## Skalpelligriffe, Mikro-Skalpelliglingen

Scalpel Handles, Micro Scalpel Blades

Manches pour bistouris, Micro lame de bistouris

Mangos de bisturí, Micro hojas de bisturí

Manici per bisturi, Micro lame per bisturi

**dimeda**<sup>®</sup>  
SURGICAL INSTRUMENTS

In Packungen à 10 Stück, steril  
in packages of 10 ea, sterile  
en boîtes de 10 pièces, stériles  
en cajas de 10 c/u, estériles  
in scatole di 10 pezzi, sterili

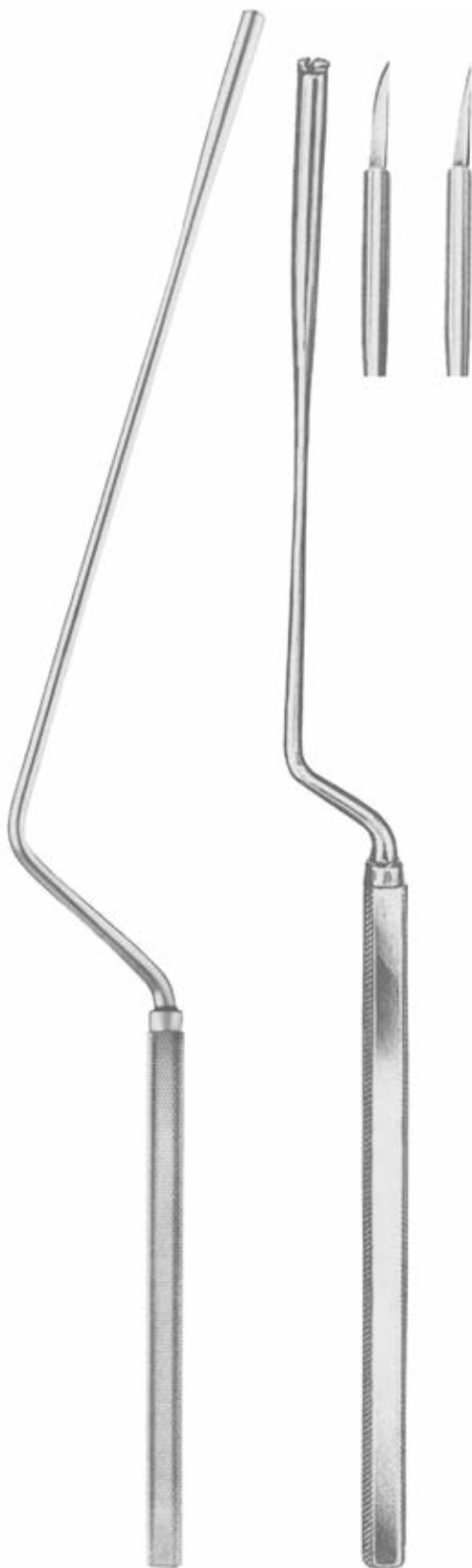

**40.859.01**  
# 61



**40.859.02**  
# 62



**40.859.04**  
# 64



**40.859.05**  
# 65



**40.859.07**  
# 67



**40.859.09**  
# 69

LANDOLT  
**40.857.25**  
25,0 cm

LANDOLT  
**40.858.21**  
21,0 cm

Skalpelle, Messer / Scalpels, Knives / Bistouris, Couteaux / Bisturris, Cuchillos / Bisturi, Coltelli

## Klingenbrecher, Rasierklingen

Blade Breakers, Razor Blades

Casse-lames, rasoirs

Rompe-hojas, hojas de afeitar

Pinze rompe-lamette, lamette



**06.295.00**  
11,0 cm

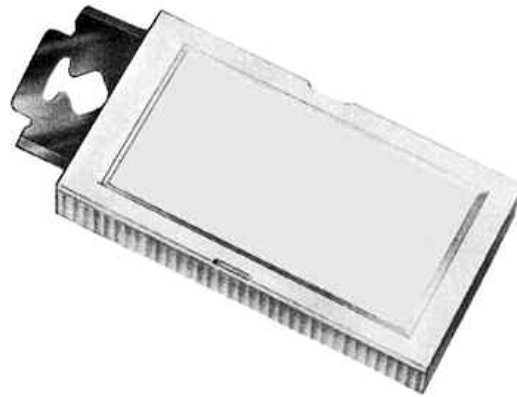

**06.296.00**  
Packung = 10  
Package = 10 ea  
Boîte = 10  
Cajita = 10 c/u  
Scatola = 10



TROUTMAN-CHRIS  
**06.290.09**  
9,0 cm



DIMEDA  
**06.291.11**  
11,0 cm



CASTROVIEJO  
**06.294.13**  
13,0 cm

## Anatomische Skalpelle

Dissecting Knives  
Bistouris à dissection  
Bisturías para disección  
Bisturi per dissezione

**dimeda**<sup>®</sup>  
SURGICAL INSTRUMENTS

mit Metallheft  
with metal handle  
avec manche en métal  
con mango metálico  
con manico di metallo

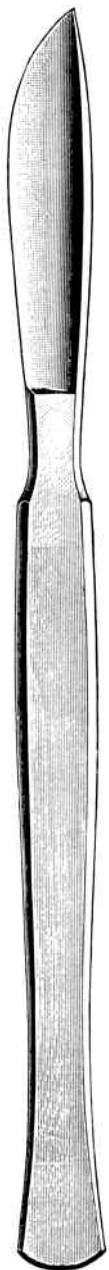

**06.402.01**  
Fig. 1  
15,0 cm



**06.402.02**  
Fig. 2  
15,0 cm



**06.402.03**  
Fig. 3  
15,5 cm



**06.402.04**  
Fig. 4  
16,0 cm



**06.402.05**  
Fig. 5  
16,0 cm



**06.402.06**  
Fig. 6  
15,0 cm



**06.402.07**  
Fig. 7  
15,0 cm



**06.402.08**  
Fig. 8  
16,0 cm



**06.402.09**  
Fig. 9  
16,0 cm



**06.402.10**  
Fig. 10  
17,0 cm



PARKER  
**06.408.01**  
Fig. 1  
14,0 cm



**06.408.02**  
Fig. 2

Skalpelle, Messer / Scalpels, Knives / Bistouris, Couteaux / Bisturías, Cuchillos / Bisturi, Coltelli

## Amputationsmesser

Amputating knives

Couteaux à amputation

Cuchillos para amputación

Coltelli per amputazione

L = Klingenlänge  
length of blade  
longueur tranchant  
largo de corte  
lunghezza di taglio

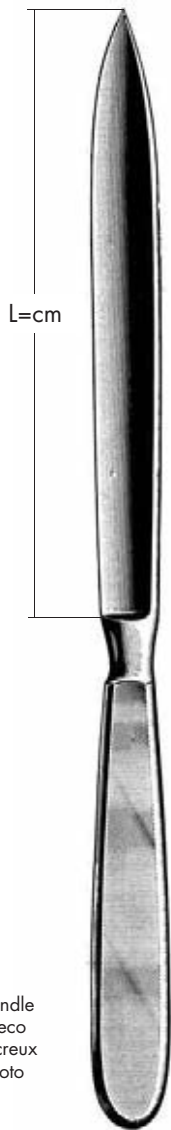

mit Hohlheft  
with hollow handle  
con mango hueco  
avec manche creux  
con manico vuoto

L	
13,0 cm	<b>06.420.13</b>
16,0 cm	<b>06.420.16</b>
19,0 cm	<b>06.420.19</b>
22,0 cm	<b>06.420.22</b>
28,0 cm	<b>06.420.28</b>

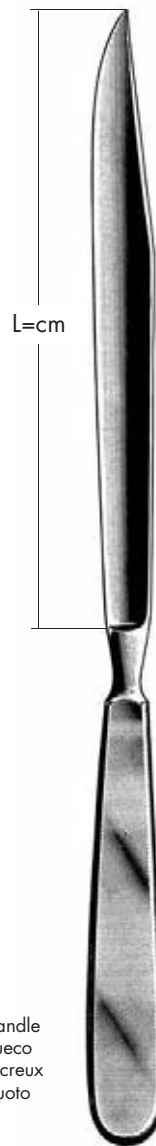

mit Hohlheft  
with hollow handle  
con mango hueco  
avec manche creux  
con manico vuoto

L	LISTON
17,0 cm	<b>06.430.17</b>
20,0 cm	<b>06.430.20</b>

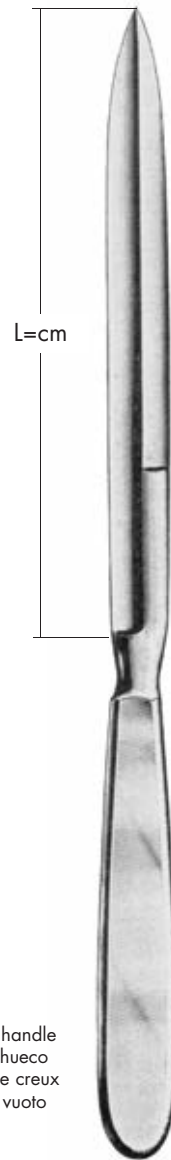

mit Hohlheft  
with hollow handle  
con mango hueco  
avec manche creux  
con manico vuoto

L	CATLIN
16,0 cm	<b>06.432.16</b>
19,0 cm	<b>06.432.19</b>
22,0 cm	<b>06.432.22</b>

## Resektionsmesser

Resection knives

Couteaux à résection

Cuchillos p. resección

Coltelli per resezione

**dimeda**<sup>®</sup>  
SURGICAL INSTRUMENTS

L = Klingenlänge  
length of blade  
longueur tranchant  
largo de corte  
lunghezza di taglio

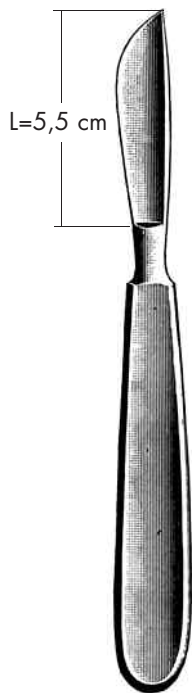

LANGENBECK  
**06.410.05**  
18,0 cm



LANGENBECK  
**06.412.05**  
18,0 cm



LANGENBECK  
**06.414.05**  
18,0 cm

massives Heft mit Schaber-Ende  
solid handle, dissecting end  
manche solide à rugine  
mango macizo, con periostótomo  
con manico pieno con raschino

## Knorpel-, Hirnmesser

Cartilage, brain knife

Couteaux à cartilage, à cerveau

Cuchillo para cartilagos y p. cerebro

Coltelli per cartilagini e per il cervello

mit Holzheft  
with wooden handle  
avec manche en bois  
con mango de madera  
con manico di legno

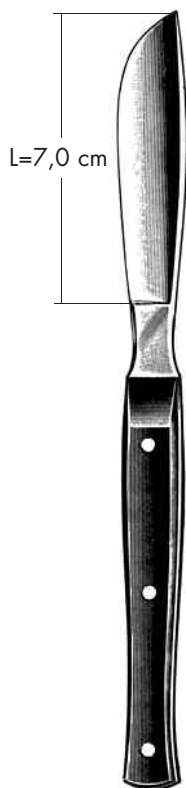

VIRCHOW  
**06.960.25**  
25,0 cm

mit Schaber  
with raspatory  
avec râpe  
con periostótomo  
con raschiatoio



**06.970.55**



**06.971.55**



**06.972.70**



L VIRCHOW  
16,0 cm **06.980.16**  
20,0 cm **06.980.20**  
24,0 cm **06.980.24**

## Rasiermesser

Razor  
Rasoir  
Navaja  
Rasoio

**dimeda**<sup>®</sup>  
SURGICAL INSTRUMENTS

In Packungen à 10 Stück, steril  
in packages of 10 ea, sterile  
en boîtes de 10 pièces, stériles  
en cajas de 10 c/u, estériles  
in scatole di 10 pezzi, sterili

Klinge flach/hohl  
blade flat/hollow  
lame à faces plane/ concave  
hoja cóncava/convexa  
lama piana/concava

Klinge beidseitig hohl  
hollow blades on both sides  
lame deux faces concaves  
ambos lados cóncavos  
lama concava/concava



**06.494.01**

**06.494.00**



**06.496.00**



**06.497.00**

Abziehstein  
Oil stone  
Pierre à repasser  
Piedra afiladora  
Pietra per affilare

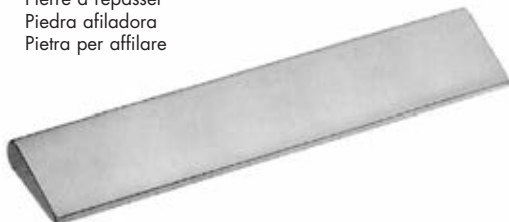

RECORD-ARKANSAS  
**06.498.00**

im Holzkasten  
in wooden case  
en boîte bois  
en caja de madera  
in astuccio di legno



ARKANSAS  
**06.499.00**

Skalpelle, Messer / Scalpels, Knives / Bistouris, Couteaux / Bisturii, Cuchillos / Bistruii, Coltelli



## Dermatome

Dermatomes  
Dermatomes  
Dermátomos  
Dermatomi

komplett mit Klinge  
complete with blade  
complet avec lame  
completo con hoja  
completo con lama



HUMBY  
**06.480.00**  
32,0 cm

Ersatzklinge  
Spare Blade  
Lame de rechange, seule  
Hoja de repuesto  
Lama die ricambio sola



HUMBY  
**06.480.01**

für handelsübliche Rasierklingen  
for usual razor blades  
pour lames de rasoir modèle standard  
para hojas de afeitar usuales  
per lamette da barba normali



SILVER  
**06.482.19**  
19,0 cm

## Dermatome

Dermatomes  
Dermatomes  
Dermátomos  
Dermatomi

**dimeda**<sup>®</sup>  
SURGICAL INSTRUMENTS

einstellbar von 0,1 bis 2,0 mm  
adjustable from 0,1 to 2,0 mm  
réglable en épaisseur de 0,1 à 2,0 mm  
ajustable de 0,1 hasta 2,0 mm  
regolabile da 0,1 a 2,0 mm



komplett  
mit 2 Spannplatten  
und einer Klinge

complete  
with 2 skin fixing  
plates and one  
blade

complet  
avec deux plaque  
pour tendre la peau  
et lame

completo  
con 2 placas para  
extender la piel y  
una hoja

completo  
con 2 placche per  
stendere la pelle es  
una lama

SCHINK  
**06.490.00**  
31,0 cm

Ersatzklinge  
Spare Blade  
Lame de rechange, seule  
Hoja de repuesto  
Lama di ricambio sola



**06.490.01**

Spannplatte  
Skin Fixing Plate  
Plaque pour tendre la peau  
Placa para extender la piel  
Placca per stendere la pelle

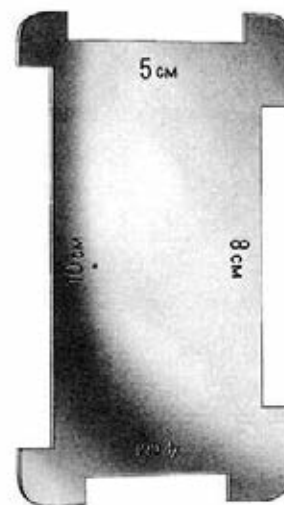

**06.490.02**

## Dermatome

Dermatomes  
Dermatomes  
Dermátomos  
Dermatomi

komplett mit Klinge  
complete with blade  
complet avec lame  
completo con hoja  
completo con lama



### 06.484.01

Ersatzklinge  
Spare Blade  
Lame de rechange, seule  
Hoja de repuesto  
Lama di ricambio sola

WATSON  
**06.482.30**  
30,0 cm



Scheren  
Scissors  
Ciseaux  
Tijeras  
Forbici

## Chirurgische Scheren

Operating Scissors  
Ciseaux à chirurgie  
Tijeras para cirugía  
Forbici per chirurgia

# SUPERCUT

TC-Schneiden  
TC Cutting Edges  
Tranchant TC  
Filos de corte TC  
Taglio TC

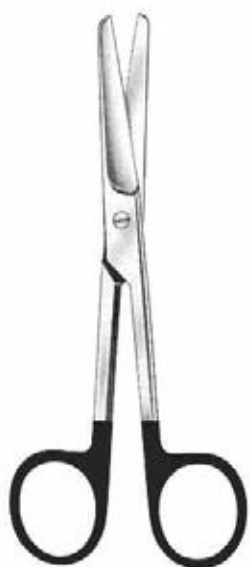

Standard

10,5 cm **07.102.10**  
11,5 cm **07.102.11**  
13,0 cm **07.102.13**  
14,5 cm **07.102.14**  
15,5 cm **07.102.15**  
16,5 cm **07.102.16**  
18,5 cm **07.102.18**  
20,0 cm **07.102.20**



Standard

10,5 cm **07.103.10**  
11,5 cm **07.103.11**  
13,0 cm **07.103.13**  
14,5 cm **07.103.14**  
15,5 cm **07.103.15**  
16,5 cm **07.103.16**  
18,5 cm **07.103.18**  
20,0 cm **07.103.20**



Standard

14,5 cm **07.104.14**  
16,5 cm **07.104.16**



Standard

14,5 cm **07.105.14**  
16,5 cm **07.105.16**

## Chirurgische Scheren

Operating Scissors  
Ciseaux à chirurgie  
Tijeras para cirugía  
Forbici per chirurgia

**dimeda**<sup>®</sup>  
SURGICAL INSTRUMENTS

**SUPERCUT**

Scheren / Scissors / Ciseaux / Tijeras / Forbici

TC-Schneiden  
TC Cutting Edges  
Tranchant TC  
Filos de corte TC  
Taglio TC



Standard

11,5 cm **07.110.11**  
13,0 cm **07.110.13**  
14,5 cm **07.110.14**  
15,5 cm **07.110.15**  
16,5 cm **07.110.16**  
18,5 cm **07.110.18**  
20,0 cm **07.110.20**



Standard

11,5 cm **07.111.11**  
13,0 cm **07.111.13**  
14,5 cm **07.111.14**  
15,5 cm **07.111.15**  
16,5 cm **07.111.16**  
18,5 cm **07.111.18**  
20,0 cm **07.111.20**



Standard

14,5 cm **07.114.14**  
16,5 cm **07.114.16**



Standard

14,5 cm **07.115.14**  
16,5 cm **07.115.16**

## Chirurgische Scheren

Operating Scissors  
Ciseaux à chirurgie  
Tijeras para cirugía  
Forbici per chirurgia

# SUPERCUT

TC-Schneiden  
TC Cutting Edges  
Tranchant TC  
Filos de corte TC  
Taglio TC



Standard

10,5 cm	<b>07.120.10</b>
11,5 cm	<b>07.120.11</b>
13,0 cm	<b>07.120.13</b>
14,5 cm	<b>07.120.14</b>
15,5 cm	<b>07.120.15</b>
16,5 cm	<b>07.120.16</b>
18,5 cm	<b>07.120.18</b>
20,0 cm	<b>07.120.20</b>



Standard

10,5 cm	<b>07.121.10</b>
11,5 cm	<b>07.121.11</b>
13,0 cm	<b>07.121.13</b>
14,5 cm	<b>07.121.14</b>
15,5 cm	<b>07.121.15</b>
16,5 cm	<b>07.121.16</b>
18,5 cm	<b>07.121.18</b>
20,0 cm	<b>07.121.20</b>



Standard

14,5 cm	<b>07.124.14</b>
16,5 cm	<b>07.124.16</b>



Standard

14,5 cm	<b>07.125.14</b>
16,5 cm	<b>07.125.16</b>



## Chirurgische Scheren

Operating Scissors  
Ciseaux à chirurgie  
Tijeras para cirugía  
Forbici per chirurgia

**dimed**<sup>®</sup>  
SURGICAL INSTRUMENTS

**SUPERCUT**

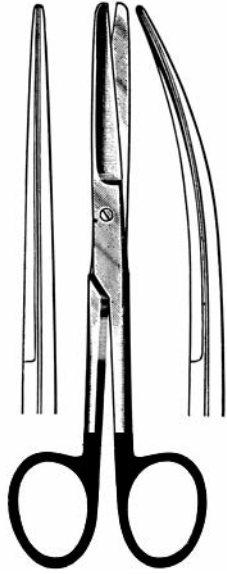

DEAVER

14,0 cm **07.130.14 07.131.14**

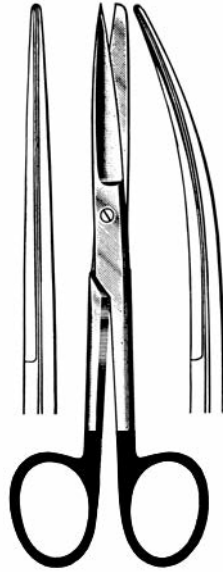

DEAVER

14,0 cm **07.140.14 07.141.14**

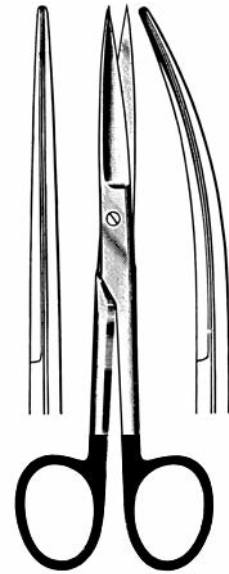

DEAVER

14,0 cm **07.150.14 07.151.14**

TC-Schneiden  
TC Cutting Edges  
Tranchant TC  
Filos de corte TC  
Taglio TC



DEAVER

14,0 cm **07.134.14 07.135.14**

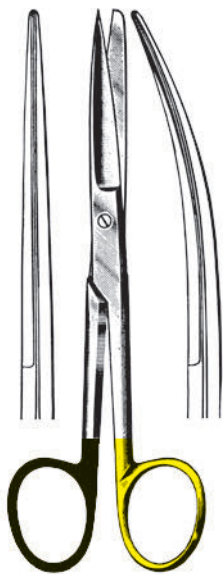

DEAVER

14,0 cm **07.144.14 07.145.14**



DEAVER

14,0 cm **07.154.14 07.155.14**

Scheren / Scissors / Ciseaux / Tijeras / Forbici

## Chirurgische Scheren

Operating Scissors  
Ciseaux à chirurgie  
Tijeras para cirugía  
Forbici per chirurgia

# SUPERCUT

TC-Schneiden  
TC Cutting Edges  
Tranchant TC  
Filos de corte TC  
Taglio TC



MAYO

14,5 cm **07.160.14**  
17,0 cm **07.160.17**  
23,0 cm **07.160.23**



MAYO

14,5 cm **07.161.14**  
17,0 cm **07.161.17**  
23,0 cm **07.161.23**



MAYO

14,5 cm **07.164.14**  
17,0 cm **07.164.17**  
23,0 cm **07.164.23**



MAYO

14,5 cm **07.165.14**  
17,0 cm **07.165.17**  
23,0 cm **07.165.23**

## Chirurgische Scheren

Operating Scissors  
Ciseaux à chirurgie  
Tijeras para cirugía  
Forbici per chirurgia

**dimeda**<sup>®</sup>  
SURGICAL INSTRUMENTS

**SUPERCUT**

Scheren / Scissors / Ciseaux / Tijeras / Forbici

TC-Schneiden  
TC Cutting Edges  
Tranchant TC  
Filos de corte TC  
Taglio TC

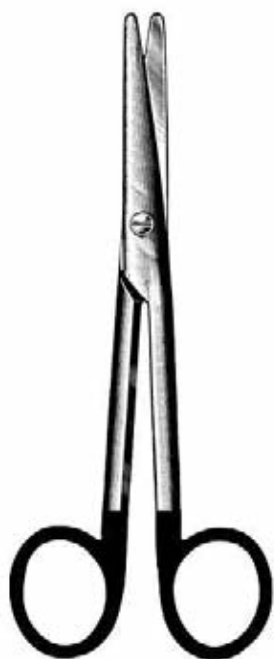

MAYO-STILLE  
15,0 cm **07.170.15**  
17,0 cm **07.170.17**

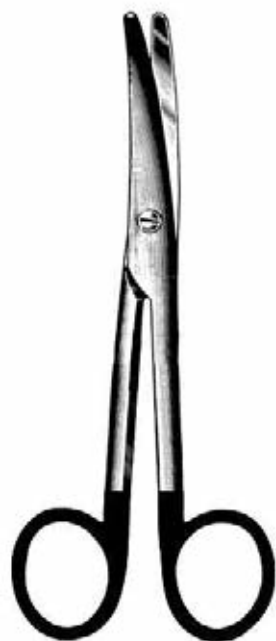

MAYO-STILLE  
15,0 cm **07.171.15**  
17,0 cm **07.171.17**



MAYO-STILLE  
15,0 cm **07.174.15**  
17,0 cm **07.174.17**



MAYO-STILLE  
15,0 cm **07.175.15**  
17,0 cm **07.175.17**

## Chirurgische Scheren

Operating Scissors  
Ciseaux à chirurgie  
Tijeras para cirugía  
Forbici per chirurgia

# SUPERCUT

TC-Schneiden  
TC Cutting Edges  
Tranchant TC  
Filos de corte TC  
Taglio TC

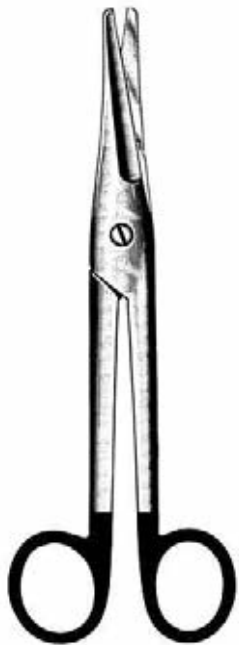

MAYO-NOBLE  
17,0 cm **07.180.17**

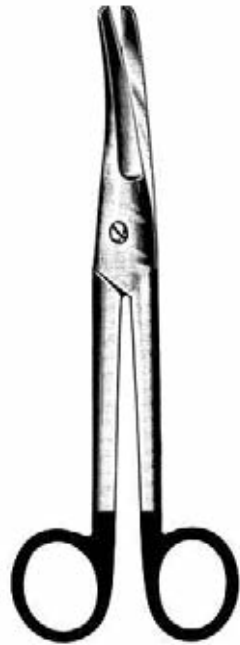

MAYO-NOBLE  
17,0 cm **07.181.17**



MAYO-NOBLE  
17,0 cm **07.184.17**



MAYO-NOBLE  
17,0 cm **07.185.17**

**SUPERCUT**

TC-Schneiden  
 TC Cutting Edges  
 Tranchant TC  
 Filos de corte TC  
 Taglio TC

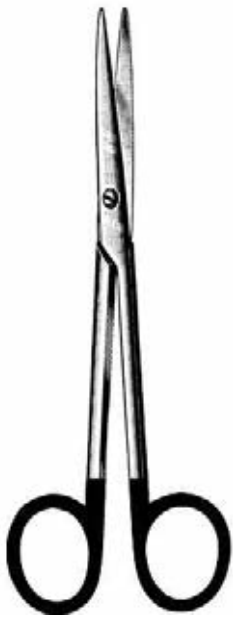

LEXER  
 16,0 cm **07.190.16**  
 21,0 cm **07.190.21**

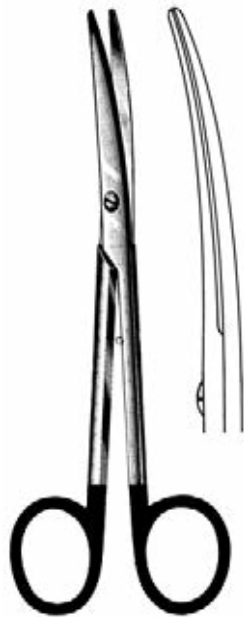

LEXER  
 16,0 cm **07.191.16**  
 21,0 cm **07.191.21**



LEXER  
 16,0 cm **07.194.16**  
 21,0 cm **07.194.21**



LEXER  
 16,0 cm **07.195.16**  
 21,0 cm **07.195.21**

**Präparierscheren**  
Dissecting Scissors  
Ciseaux à dissection  
Tijeras de disección  
Forbici per dissezione

**SUPERCUT**

TC-Schneiden  
TC Cutting Edges  
Tranchant TC  
Filos de corte TC  
Taglio TC



LEXER-BABY  
10,0 cm **07.202.10**



LEXER-BABY  
10,0 cm **07.203.10**



LEXER-BABY  
10,0 cm **07.206.10**



LEXER-BABY  
10,0 cm **07.207.10**

**SUPERCUT**

TC-Schneiden  
 TC Cutting Edges  
 Tranchant TC  
 Filos de corte TC  
 Taglio TC



**METZENBAUM**  
 11,5 cm **07.280.11**  
 15,0 cm **07.280.15**  
 18,0 cm **07.280.18**  
 20,0 cm **07.280.20**  
 23,0 cm **07.280.23**  
 25,0 cm **07.280.25**  
 28,0 cm **07.280.28**  
 30,0 cm **07.280.30**



**METZENBAUM**  
 11,5 cm **07.281.11**  
 15,0 cm **07.281.15**  
 18,0 cm **07.281.18**  
 20,0 cm **07.281.20**  
 23,0 cm **07.281.23**  
 25,0 cm **07.281.25**  
 28,0 cm **07.281.28**  
 30,0 cm **07.281.30**



**METZENBAUM**  
 11,5 cm **07.284.11**  
 15,0 cm **07.284.15**  
 18,0 cm **07.284.18**  
 20,0 cm **07.284.20**  
 23,0 cm **07.284.23**  
 25,0 cm **07.284.25**  
 28,0 cm **07.284.28**  
 30,0 cm **07.284.30**



**METZENBAUM**  
 11,5 cm **07.285.11**  
 15,0 cm **07.285.15**  
 18,0 cm **07.285.18**  
 20,0 cm **07.285.20**  
 23,0 cm **07.285.23**  
 25,0 cm **07.285.25**  
 28,0 cm **07.285.28**  
 30,0 cm **07.285.30**

**Präparierscheren**  
 Dissecting Scissors  
 Ciseaux à dissection  
 Tijeras de disección  
 Forbici per dissezione

**SUPERCUT**

TC-Schneiden  
 TC Cutting Edges  
 Tranchant TC  
 Filos de corte TC  
 Taglio TC



METZENBAUM FINO  
 15,0 cm **07.282.15**  
 18,0 cm **07.282.18**  
 20,0 cm **07.282.20**  
 23,0 cm **07.282.23**  
 25,0 cm **07.282.25**  
 28,0 cm **07.282.28**

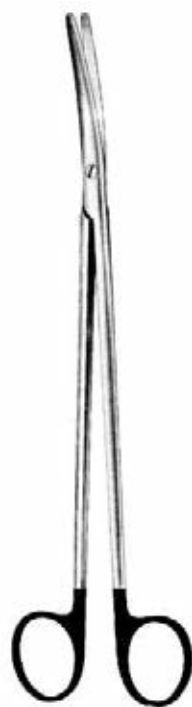

METZENBAUM FINO  
 15,0 cm **07.283.15**  
 18,0 cm **07.283.18**  
 20,0 cm **07.283.20**  
 23,0 cm **07.283.23**  
 25,0 cm **07.283.25**  
 28,0 cm **07.283.28**



METZENBAUM FINO  
 15,0 cm **07.286.15**  
 18,0 cm **07.286.18**  
 20,0 cm **07.286.20**  
 23,0 cm **07.286.23**  
 25,0 cm **07.286.25**  
 28,0 cm **07.286.28**



METZENBAUM FINO  
 15,0 cm **07.287.15**  
 18,0 cm **07.287.18**  
 20,0 cm **07.287.20**  
 23,0 cm **07.287.23**  
 25,0 cm **07.287.25**  
 28,0 cm **07.287.28**



**Chirurgische Scheren**

Operating Scissors  
Ciseaux à chirurgie  
Tijeras para cirugía  
Forbici per chirurgia

**SUPERCUT**



METZENBAUM "S"  
18,0 cm **07.291.18**



SANVENERO  
14,0 cm **07.302.14**



SANVENERO  
14,0 cm **07.303.14**

TC-Schneiden  
TC Cutting Edges  
Tranchant TC  
Filos de corte TC  
Taglio TC



METZENBAUM "S"  
18,0 cm **07.295.18**



SANVENERO  
14,0 cm **07.306.14**



SANVENERO  
14,0 cm **07.307.14**

## Chirurgische Scheren

Operating Scissors  
Ciseaux à chirurgie  
Tijeras para cirugía  
Forbici per chirurgia

Plastik  
Plastic  
Plastique  
Plástica  
Plastica

# SUPERCUT



JOSEPH  
14,0 cm **07.304.14**

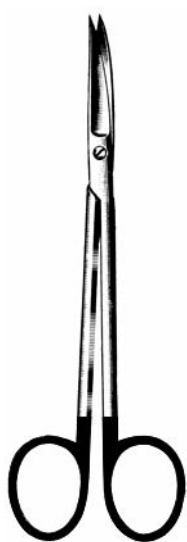

JOSEPH  
14,0 cm **07.305.14**



KILNER  
12,0 cm **07.310.12**  
15,0 cm **07.310.15**

TC-Schneiden  
TC Cutting Edges  
Tranchant TC  
Filos de corte TC  
Taglio TC



JOSEPH  
14,0 cm **07.308.14**



JOSEPH  
14,0 cm **07.309.14**



KILNER  
12,0 cm **07.314.12**  
15,0 cm **07.314.15**

**Chirurgische Scheren**

Operating Scissors  
Ciseaux à chirurgie  
Tijeras para cirugía  
Forbici per chirurgia

**dimeda**<sup>®</sup>  
SURGICAL INSTRUMENTS

**SUPERCUT**

Scheren / Scissors / Ciseaux / Tijeras / Forbici

TC-Schneiden  
TC Cutting Edges  
Tranchant TC  
Filos de corte TC  
Taglio TC



REYNOLDS  
15,0 cm **07.320.15**



REYNOLDS  
15,0 cm **07.321.15**



REYNOLDS  
15,0 cm **07.324.15**



REYNOLDS  
15,0 cm **07.325.15**

## Chirurgische Scheren

Operating Scissors  
Ciseaux à chirurgie  
Tijeras para cirugía  
Forbici per chirurgia

# SUPERCUT

rund  
round  
ron  
redondo  
retondo



IRIS-Standard

9,0 cm **07.340.09**  
10,5 cm **07.340.10**  
11,5 cm **07.340.11**



IRIS-Standard

9,0 cm **07.341.09**  
10,5 cm **07.341.10**  
11,5 cm **07.341.11**



IRIS-Standard

9,0 cm **07.342.09**  
10,5 cm **07.342.10**  
11,5 cm **07.342.11**



IRIS-Standard

9,0 cm **07.343.09**  
10,5 cm **07.343.10**  
11,5 cm **07.343.11**



IRIS-Standard

9,0 cm **07.344.09**  
10,5 cm **07.344.10**  
11,5 cm **07.344.11**



IRIS-Standard

9,0 cm **07.345.09**  
10,5 cm **07.345.10**  
11,5 cm **07.345.11**

TC-Schneiden  
TC Cutting Edges  
Tranchant TC  
Filos de corte TC  
Taglio TC

**SUPERCUT**



STEVENS  
 11,0 cm **07.362.11**



STEVENS  
 11,0 cm **07.363.11**

Strabismus Scheren  
 Strabismus Scissors  
 Ciseaux à strabisme  
 Tijeras para estrabismo  
 Forbici per strabismo

TC-Schneiden  
 TC Cutting Edges  
 Tranchant TC  
 Filos de corte TC  
 Taglio TC



11,0 cm **07.370.11**



11,0 cm **07.371.11**



11,0 cm **07.374.11**



11,0 cm **07.375.11**

**Scheren, Ophthal., Nase**

Scissors, Ophthal., Nasal  
Ciseaux, ophtal., nasaux  
Tijeras, oftalmología, nasales  
Forbici, oftalmologia, nasali

**SUPERCUT**



HEYMANN  
18,0 cm **07.401.18**



FOMON  
15,0 cm **07.403.15**



COTTLE  
16,0 cm **07.405.16**

**Tonsillen-, Gefäß-Scheren**

Tonsil, Vascular Scissors  
Ciseaux amygdal., vasculaires  
Tijeras, amígdal., vasculares  
Forbici, tonsill., vascolari

**SUPERCUT**



POTTS-SMITH

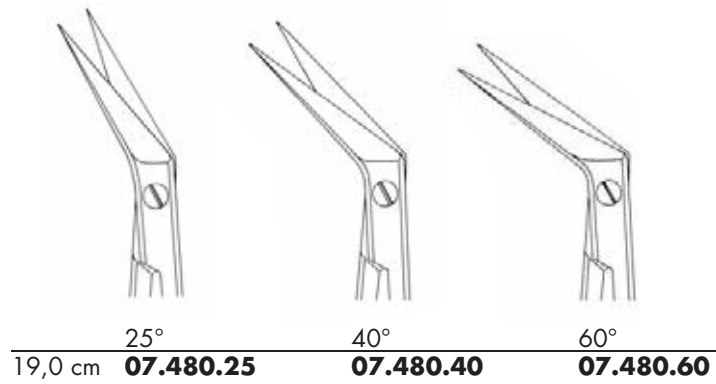

POTTS-SMITH

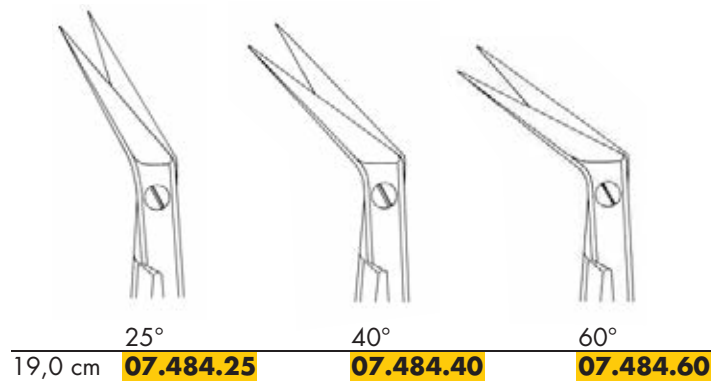

**Gefäß-Scheren**  
Vascular Scissors  
Ciseaux vasculaires  
Tijeras vasculares  
Forbici vascolari

**SUPERCUT**

Parametrium



22,0 cm **07.505.22**



23,0 cm **07.505.23**

TC-Schneiden  
TC Cutting Edges  
Tranchant TC  
Filos de corte TC  
Taglio TC



## Gynäkologische Scheren

Gynaecological Scissors  
Ciseaux gynécologiques  
Tijeras ginecológicas  
Forbici ginecologiche

**dimeda**<sup>®</sup>  
SURGICAL INSTRUMENTS

**SUPERCUT**



SIMS  
20,0 cm **07.510.20**  
23,0 cm **07.510.23**



SIMS  
20,0 cm **07.511.20**  
23,0 cm **07.511.23**



SIEBOLD  
24,0 cm **07.523.24**



SIMS  
20,0 cm **07.514.20**  
23,0 cm **07.514.23**



SIMS  
20,0 cm **07.515.20**  
23,0 cm **07.515.23**

TC-Schneiden  
TC Cutting Edges  
Tranchant TC  
Filos de corte TC  
Taglio TC

## Gynäkologische Scheren

Gynaecological Scissors  
Ciseaux gynécologiques  
Tijeras ginecológicas  
Forbici ginecologiche

**SUPERCUT**

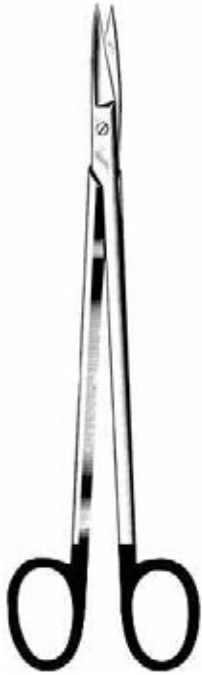

KELLY  
16,0 cm **07.540.16**  
18,0 cm **07.540.18**



KELLY  
16,0 cm **07.541.16**  
18,0 cm **07.541.18**



Episiotomie  
Episiotomy  
Episiotomia  
Episiotmía  
Episiotomia

BRAUN-STADLER  
14,5 cm **07.560.14**  
22,0 cm **07.560.22**



WAGNER  
12,0 cm **07.824.12**



WAGNER  
12,0 cm **07.825.12**

## Verband Scheren

Bandage Scissors  
Ciseaux à bandages  
Tijeras para vendajes  
Forbici per bendaggi

**dimeda**<sup>®</sup>  
SURGICAL INSTRUMENTS

**SUPERCUT**



LISTER

14,0 cm **07.901.14**  
18,0 cm **07.901.18**  
20,0 cm **07.901.20**



LISTER

14,0 cm **07.905.14**  
18,0 cm **07.905.18**  
20,0 cm **07.905.20**

TC-Schneiden  
TC Cutting Edges  
Tranchant TC  
Filos de corte TC  
Taglio TC

Scheren / Scissors / Ciseaux / Tijeras / Forbici





Scheren  
Scissors  
Ciseaux  
Tijeras  
Forbici

## Chirurgische Scheren

Operating Scissors  
Ciseaux à chirurgie  
Tijeras para cirugía  
Forbici per chirurgia

TC-Schneiden  
TC Cutting Edges  
Tranchant TC  
Filos de corte TC  
Taglio TC



Standard

10,5 cm	<b>08.102.10</b>
11,5 cm	<b>08.102.11</b>
13,0 cm	<b>08.102.13</b>
14,5 cm	<b>08.102.14</b>
15,5 cm	<b>08.102.15</b>
16,5 cm	<b>08.102.16</b>
18,5 cm	<b>08.102.18</b>
20,0 cm	<b>08.102.20</b>
30,0 cm	<b>08.102.30</b>



Standard

10,5 cm	<b>08.103.10</b>
11,5 cm	<b>08.103.11</b>
13,0 cm	<b>08.103.13</b>
14,5 cm	<b>08.103.14</b>
15,5 cm	<b>08.103.15</b>
16,5 cm	<b>08.103.16</b>
18,5 cm	<b>08.103.18</b>
20,0 cm	<b>08.103.20</b>
30,0 cm	<b>08.103.30</b>



Standard

14,5 cm	<b>08.104.14</b>
16,5 cm	<b>08.104.16</b>
18,5 cm	<b>08.104.18</b>



Standard

14,5 cm	<b>08.105.14</b>
16,5 cm	<b>08.105.16</b>
18,5 cm	<b>08.105.18</b>

## Chirurgische Scheren

Operating Scissors  
Ciseaux à chirurgie  
Tijeras para cirugía  
Forbici per chirurgia

**dimeda**<sup>®</sup>  
SURGICAL INSTRUMENTS

L = Für Linkshänder  
For left-handed  
Pour la main gauche  
Para zurdo  
Per mancini

TC-Schneiden  
TC Cutting Edges  
Tranchant TC  
Filos de corte TC  
Taglio TC



Standard

10,5 cm	<b>08.110.10</b>
11,5 cm	<b>08.110.11</b>
13,0 cm	<b>08.110.13</b>
13,0 cm	<b>08.110.13L</b>
14,5 cm	<b>08.110.14</b>
14,5 cm	<b>08.110.14L</b>
15,5 cm	<b>08.110.15</b>
16,5 cm	<b>08.110.16</b>
18,5 cm	<b>08.110.18</b>
20,0 cm	<b>08.110.20</b>
30,0 cm	<b>08.110.30</b>



Standard

10,5 cm	<b>08.111.10</b>
11,5 cm	<b>08.111.11</b>
13,0 cm	<b>08.111.13</b>
13,0 cm	<b>08.111.13L</b>
14,5 cm	<b>08.111.14</b>
14,5 cm	<b>08.111.14L</b>
15,5 cm	<b>08.111.15</b>
16,5 cm	<b>08.111.16</b>
18,5 cm	<b>08.111.18</b>
20,0 cm	<b>08.111.20</b>
30,0 cm	<b>08.111.30</b>



Standard

14,5 cm	<b>08.114.14</b>
16,5 cm	<b>08.114.16</b>
18,5 cm	<b>08.114.18</b>



Standard

14,5 cm	<b>08.115.14</b>
16,5 cm	<b>08.115.16</b>
18,5 cm	<b>08.115.18</b>

## Chirurgische Scheren

Operating Scissors  
Ciseaux à chirurgie  
Tijeras para cirugía  
Forbici per chirurgia

TC-Schneiden  
TC Cutting Edges  
Tranchant TC  
Filos de corte TC  
Taglio TC



Standard

10,5 cm	<b>08.120.10</b>
11,5 cm	<b>08.120.11</b>
13,0 cm	<b>08.120.13</b>
14,5 cm	<b>08.120.14</b>
15,5 cm	<b>08.120.15</b>
16,5 cm	<b>08.120.16</b>
18,5 cm	<b>08.120.18</b>
20,0 cm	<b>08.120.20</b>
30,0 cm	<b>08.120.30</b>



Standard

10,5 cm	<b>08.121.10</b>
11,5 cm	<b>08.121.11</b>
13,0 cm	<b>08.121.13</b>
14,5 cm	<b>08.121.14</b>
15,5 cm	<b>08.121.15</b>
16,5 cm	<b>08.121.16</b>
18,5 cm	<b>08.121.18</b>
20,0 cm	<b>08.121.20</b>
30,0 cm	<b>08.121.30</b>



Standard

14,5 cm	<b>08.124.14</b>
16,5 cm	<b>08.124.16</b>
18,5 cm	<b>08.124.18</b>



Standard

14,5 cm	<b>08.125.14</b>
16,5 cm	<b>08.125.16</b>
18,5 cm	<b>08.125.18</b>



## Chirurgische Scheren

Operating Scissors  
Ciseaux à chirurgie  
Tijeras para cirugía  
Forbici per chirurgia

**dimeda**<sup>®</sup>  
SURGICAL INSTRUMENTS

schlanke Modelle  
slender patterns  
modèles fins  
modelos fins  
modelli fini



12,0 cm **08.124.12**



12,0 cm **08.125.12**



12,0 cm **08.126.12**  
13,0 cm **08.126.13**



12,0 cm **08.127.12**  
13,0 cm **08.127.13**



Inzisionsscheren  
Incision scissors  
Ciseaux à incision  
Tijeras para incision  
Forbici incisione

14,0 cm **08.128.14**

## Chirurgische Scheren

Operating Scissors  
Ciseaux à chirurgie  
Tijeras para cirugía  
Forbici per chirurgia

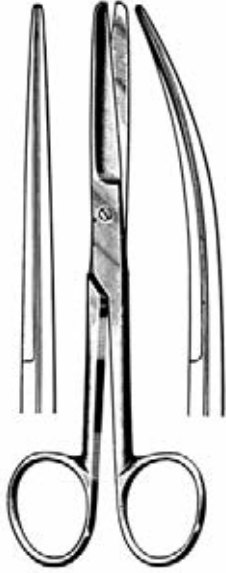

DEAVER

14,0 cm **08.130.14** **08.131.14**

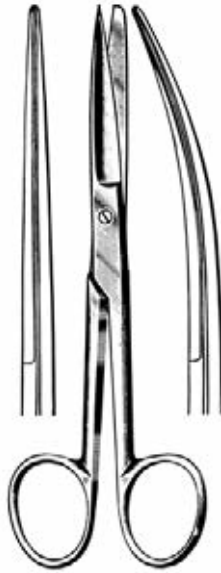

DEAVER

14,0 cm **08.140.14** **08.141.14**



DEAVER

14,0 cm **08.150.14** **08.151.14**

TC-Schneiden  
TC Cutting Edges  
Tranchant TC  
Filos de corte TC  
Taglio TC



DEAVER

14,0 cm **08.134.14** **08.135.14**



DEAVER

14,0 cm **08.144.14** **08.145.14**



DEAVER

14,0 cm **08.154.14** **08.155.14**

## Chirurgische Scheren

Operating Scissors  
Ciseaux à chirurgie  
Tijeras para cirugía  
Forbici per chirurgia

**dimeda**<sup>®</sup>  
SURGICAL INSTRUMENTS

L = Für Linkshänder  
For left-handed  
Pour la main gauche  
Para zurdo  
Per mancini

TC-Schneiden  
TC Cutting Edges  
Tranchant TC  
Filos de corte TC  
Taglio TC



MAYO

14,5 cm	<b>08.160.14</b>
14,5 cm	<b>08.160.14L</b>
17,0 cm	<b>08.160.17</b>
17,0 cm	<b>08.160.17L</b>
19,0 cm	<b>08.160.19</b>
23,0 cm	<b>08.160.23</b>
28,0 cm	<b>08.160.28</b>

MAYO

14,5 cm	<b>08.161.14</b>
14,5 cm	<b>08.161.14L</b>
17,0 cm	<b>08.161.17</b>
17,0 cm	<b>08.161.17L</b>
19,0 cm	<b>08.161.19</b>
23,0 cm	<b>08.161.23</b>
28,0 cm	<b>08.161.28</b>

MAYO

14,5 cm	<b>08.164.14</b>
17,0 cm	<b>08.164.17</b>
23,0 cm	<b>08.164.23</b>

MAYO

14,5 cm	<b>08.165.14</b>
17,0 cm	<b>08.165.17</b>
23,0 cm	<b>08.165.23</b>

## Chirurgische Scheren

Operating Scissors  
Ciseaux à chirurgie  
Tijeras para cirugía  
Forbici per chirurgia

schlanke Modelle  
slender patterns  
modèles fins  
modelos fins  
modelli fini

mit abgeschägten Schneiden  
with chamfered blades  
avec tranchant biais  
filos en declive  
con lame inclinate



MAYO-STILLE  
16,0 cm **08.166.16**  
19,0 cm **08.166.19**  
21,5 cm **08.166.21**



MAYO-STILLE  
16,0 cm **08.167.16**  
19,0 cm **08.167.19**  
21,5 cm **08.167.21**



MAYO-STILLE  
14,0 cm **08.172.14**  
17,0 cm **08.172.17**



MAYO-STILLE  
14,0 cm **08.173.14**  
17,0 cm **08.173.17**

TC-Schneiden  
 TC Cutting Edges  
 Tranchant TC  
 Filos de corte TC  
 Taglio TC



MAYO-STILLE  
 15,0 cm **08.170.15**  
 17,0 cm **08.170.17**

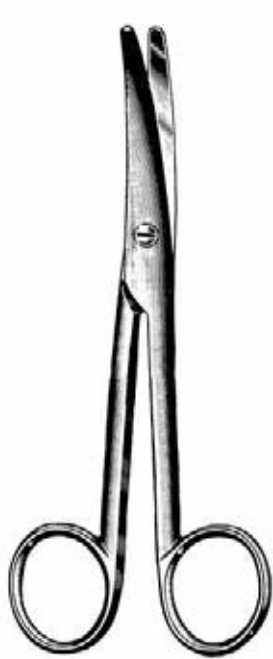

MAYO-STILLE  
 15,0 cm **08.171.15**  
 17,0 cm **08.171.17**



MAYO-STILLE  
 15,0 cm **08.174.15**  
 17,0 cm **08.174.17**



MAYO-STILLE  
 15,0 cm **08.175.15**  
 17,0 cm **08.175.17**

## Chirurgische Scheren

Operating Scissors  
Ciseaux à chirurgie  
Tijeras para cirugía  
Forbici per chirurgia

TC-Schneiden  
TC Cutting Edges  
Tranchant TC  
Filos de corte TC  
Taglio TC



MAYO-NOBLE  
17,0 cm **08.180.17**



MAYO-NOBLE  
17,0 cm **08.181.17**



MAYO-NOBLE  
17,0 cm **08.184.17**

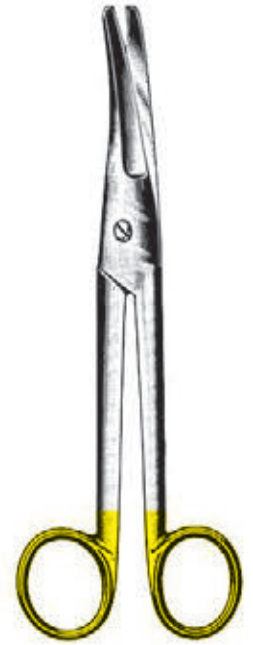

MAYO-NOBLE  
17,0 cm **08.185.17**

TC-Schneiden  
 TC Cutting Edges  
 Tranchant TC  
 Filos de corte TC  
 Taglio TC

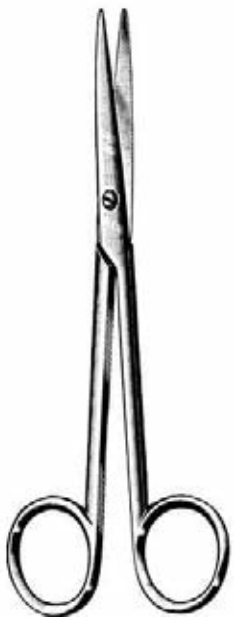

LEXER  
 16,0 cm **08.190.16**  
 21,0 cm **08.190.21**

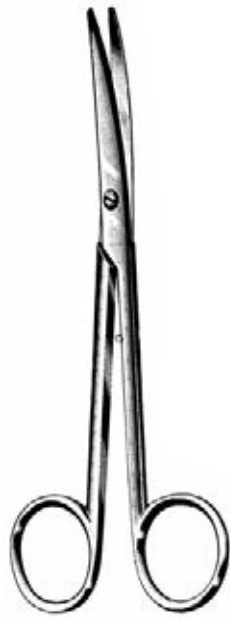

LEXER  
 16,0 cm **08.191.16**  
 21,0 cm **08.191.21**



LEXER  
 16,0 cm **08.194.16**  
 21,0 cm **08.194.21**



LEXER  
 16,0 cm **08.195.16**  
 21,0 cm **08.195.21**

**Präparierscheren**  
Dissecting Scissors  
Ciseaux à dissection  
Tijeras de disección  
Forbici per dissezione



LEXER-FINO  
16,0 cm **08.197.16**

TC-Schneiden  
TC Cutting Edges  
Tranchant TC  
Filos de corte TC  
Taglio TC



LEXER-BABY  
10,0 cm **08.202.10**



LEXER-BABY  
10,0 cm **08.203.10**



LEXER-BABY  
10,0 cm **08.206.10**



LEXER-BABY  
10,0 cm **08.207.10**



**Präparierscheren**  
 Dissecting Scissors  
 Ciseaux à dissection  
 Tijeras de disección  
 Forbici per dissezione

mit Fadenbohrung in der Spitze  
 tips with eye for suture  
 avec chas  
 con ojal en las puntas  
 con foro per il filo alla punta



LITTLER  
 12,0 cm **08.205.12**  
 14,0 cm **08.205.14**



METZENBAUM  
 11,5 cm **08.210.11**  
 15,5 cm **08.210.15**



METZENBAUM  
 11,5 cm **08.211.11**  
 15,5 cm **08.211.15**



GORNEY  
 12,0 cm **08.212.12**  
 19,0 cm **08.212.19**



GORNEY  
 19,0 cm **08.213.19**

**Präparierscheren**  
 Dissecting Scissors  
 Ciseaux à dissection  
 Tijeras de disección  
 Forbici per dissezione

L = Für Linkshänder  
 For left-handed  
 Pour la main gauche  
 Para zurdo  
 Per mancini

TC-Schneiden  
 TC Cutting Edges  
 Tranchant TC  
 Filos de corte TC  
 Taglio TC

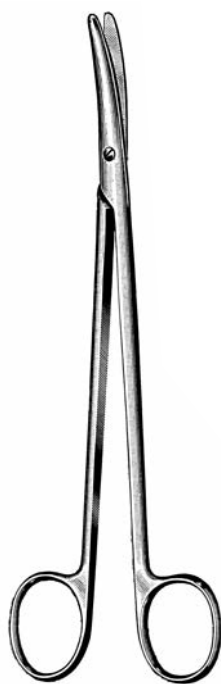

**METZENBAUM**

15,0 cm	<b>08.280.15</b>
15,0 cm	<b>08.280.15L</b>
18,0 cm	<b>08.280.18</b>
18,0 cm	<b>08.280.18L</b>
20,0 cm	<b>08.280.20</b>
23,0 cm	<b>08.280.23</b>
23,0 cm	<b>08.280.23L</b>
25,0 cm	<b>08.280.25</b>
28,0 cm	<b>08.280.28</b>
30,0 cm	<b>08.280.30</b>

**METZENBAUM**

15,0 cm	<b>08.281.15</b>
15,0 cm	<b>08.281.15L</b>
18,0 cm	<b>08.281.18</b>
18,0 cm	<b>08.281.18L</b>
20,0 cm	<b>08.281.20</b>
23,0 cm	<b>08.281.23</b>
23,0 cm	<b>08.281.23L</b>
25,0 cm	<b>08.281.25</b>
28,0 cm	<b>08.281.28</b>
30,0 cm	<b>08.281.30</b>

**METZENBAUM**

15,0 cm	<b>08.284.15</b>
18,0 cm	<b>08.284.18</b>
20,0 cm	<b>08.284.20</b>
23,0 cm	<b>08.284.23</b>
25,0 cm	<b>08.284.25</b>
28,0 cm	<b>08.284.28</b>
30,0 cm	<b>08.284.30</b>

**METZENBAUM**

15,0 cm	<b>08.285.15</b>
18,0 cm	<b>08.285.18</b>
20,0 cm	<b>08.285.20</b>
23,0 cm	<b>08.285.23</b>
25,0 cm	<b>08.285.25</b>
28,0 cm	<b>08.285.28</b>
30,0 cm	<b>08.285.30</b>

TC-Schneiden  
 TC Cutting Edges  
 Tranchant TC  
 Filos de corte TC  
 Taglio TC



METZENBAUM FINO  
 15,0 cm **08.282.15**  
 18,0 cm **08.282.18**  
 20,0 cm **08.282.20**  
 23,0 cm **08.282.23**  
 25,0 cm **08.282.25**  
 28,0 cm **08.282.28**



METZENBAUM FINO  
 15,0 cm **08.283.15**  
 18,0 cm **08.283.18**  
 20,0 cm **08.283.20**  
 23,0 cm **08.283.23**  
 25,0 cm **08.283.25**  
 28,0 cm **08.283.28**



METZENBAUM FINO  
 15,0 cm **08.286.15**  
 18,0 cm **08.286.18**  
 20,0 cm **08.286.20**  
 23,0 cm **08.286.23**  
 25,0 cm **08.286.25**  
 28,0 cm **08.286.28**



METZENBAUM FINO  
 15,0 cm **08.287.15**  
 18,0 cm **08.287.18**  
 20,0 cm **08.287.20**  
 23,0 cm **08.287.23**  
 25,0 cm **08.287.25**  
 28,0 cm **08.287.28**

**Präparierscheren**  
 Dissecting Scissors  
 Ciseaux à dissection  
 Tijeras de disección  
 Forbici per dissezione

TC-Schneiden  
 TC Cutting Edges  
 Tranchant TC  
 Filos de corte TC  
 Taglio TC



METZENBAUM "S"  
 18,0 cm **08.291.18**



METZENBAUM "S"  
 18,0 cm **08.295.18**  
 23,0 cm **08.295.23**



SANVENERO  
 14,0 cm **08.302.14**



SANVENERO  
 14,0 cm **08.303.14**



JOSEPH  
 14,0 cm **08.304.14**

Plastik  
 Plastic  
 Plastique  
 Plástica  
 Plastica

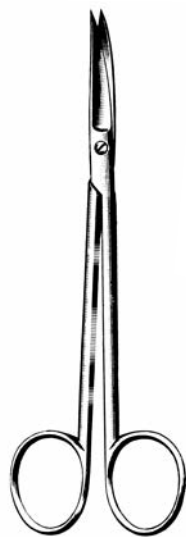

JOSEPH  
 14,0 cm **08.305.14**

Plastik  
Plastic  
Plastique  
Plástica  
Plastica

TC-Schneiden  
TC Cutting Edges  
Tranchant TC  
Filos de corte TC  
Taglio TC



KILNER  
12,0 cm **08.308.12**



KILNER  
12,0 cm **08.310.12**  
15,0 cm **08.310.15**



KILNER  
12,0 cm **08.314.12**  
15,0 cm **08.314.15**

## Chirurgische Scheren

Operating Scissors  
Ciseaux à chirurgie  
Tijeras para cirugía  
Forbici per chirurgia

eine Schneide gezahnt  
one toothed cutting edge  
une lame dentelée  
una hoja dentada  
una lama dentata



LOCKLIN  
16,0 cm **08.315.16**



LOCKLIN  
16,0 cm **08.317.16**

TC-Schneiden  
TC Cutting Edges  
Tranchant TC  
Filos de corte TC  
Taglio TC

Plastik  
Plastic  
Plastique  
Plástica  
Plastica



REYNOLDS  
15,0 cm **08.320.15**



REYNOLDS  
15,0 cm **08.321.15**  
18,0 cm **08.321.18**



REYNOLDS  
15,0 cm **08.324.15**



REYNOLDS  
15,0 cm **08.325.15**

## Chirurgische Scheren

Operating Scissors  
Ciseaux à chirurgie  
Tijeras para cirugía  
Forbici per chirurgia

**dimeda**<sup>®</sup>  
SURGICAL INSTRUMENTS



IRIS  
9,5 cm **08.322.09**



IRIS  
9,5 cm **08.323.09**



IRIS  
10,5 cm **08.326.10**



IRIS  
10,5 cm **08.327.10**



IRIS  
10,0 cm **08.328.10**



IRIS  
10,0 cm **08.329.10**



IRIS  
9,5 cm **08.331.09**



IRIS  
9,5 cm **08.333.09**

Scheren / Scissors / Ciseaux / Tijeras / Forbici

## Chirurgische Scheren

Operating Scissors  
Ciseaux à chirurgie  
Tijeras para cirugía  
Forbici per chirurgia



KNAPP  
10,5 cm **08.336.10**



KNAPP  
10,5 cm **08.337.10**



KNAPP  
10,5 cm **08.338.10**



KNAPP  
10,5 cm **08.339.10**



## Chirurgische Scheren

Operating Scissors  
Ciseaux à chirurgie  
Tijeras para cirugía  
Forbici per chirurgia

**dimed**<sup>®</sup>  
SURGICAL INSTRUMENTS

L = Für Linkshänder  
For left-handed  
Pour la main gauche  
Para zurdo  
Per mancini

rund  
round  
rond  
redondo  
retondo



IRIS-Standard  
9,0 cm **08.340.09**  
10,5 cm **08.340.10**  
10,5 cm **08.340.10L**  
11,5 cm **08.340.11**  
12,5 cm **08.340.12**



IRIS-Standard  
9,0 cm **08.341.09**  
10,5 cm **08.341.10**  
10,5 cm **08.341.10L**  
11,5 cm **08.341.11**  
12,5 cm **08.341.12**



IRIS-Standard  
10,5 cm **08.342.10**  
11,5 cm **08.342.11**



IRIS-Standard  
10,5 cm **08.343.10**  
11,5 cm **08.343.11**



IRIS-Standard  
11,5 cm **08.344.11**



IRIS-Standard  
11,5 cm **08.345.11**

TC-Schneiden  
TC Cutting Edges  
Tranchant TC  
Filos de corte TC  
Taglio TC

**Scheren, Ophthal., Nase**

Scissors, Ophthal., Nasal  
Ciseaux, ophtal., nasaux  
Tijeras, oftalmología, nasales  
Forbici, oftalmologia, nasali

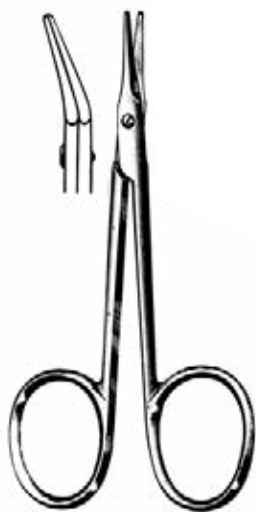

AEBLI  
9,0 cm **08.347.09**

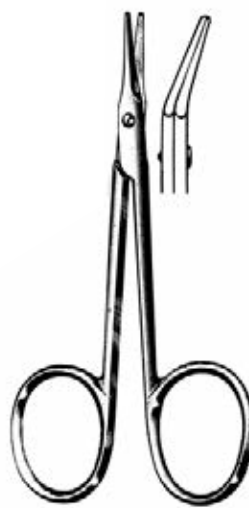

AEBLI  
9,0 cm **08.349.09**



IRIS  
11,5 cm **08.351.11**



IRIS  
11,5 cm **08.354.11**

**Scheren, Ophthal., Nase**

Scissors, Ophthal., Nasal  
Ciseaux, ophthal., nasaux  
Tijeras, oftalmología, nasales  
Forbici, oftalmologia, nasali

TC-Schneiden  
TC Cutting Edges  
Tranchant TC  
Filos de corte TC  
Taglio TC

spitz  
pointed  
pointus  
agudas  
acute

stumpf  
blunt  
mousses  
romas  
smusse

gerade  
straight  
droites  
rectas  
rette

gebogen  
curved  
courbes  
curvas  
curve

gerade  
straight  
droites  
rectas  
rette

gebogen  
curved  
courbes  
curvas  
curve

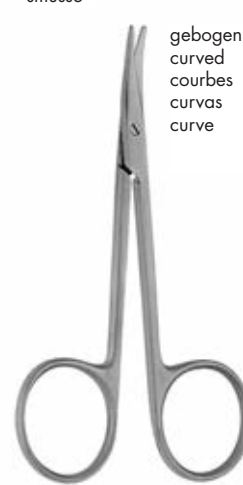
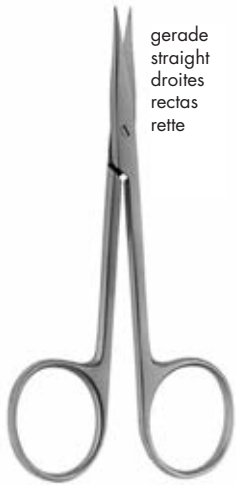

STEVENS

10,5 cm **08.360.11**  
10,5 cm **08.360.10**

STEVENS

10,5 cm **08.361.11**  
10,5 cm **08.361.10**

STEVENS

10,5 cm **08.362.11**  
10,5 cm **08.362.10**

STEVENS

10,5 cm **08.363.11**  
10,5 cm **08.363.10**



STEVENS

10,5 cm **08.364.10**

STEVENS

10,5 cm **08.365.10**

STEVENS

10,5 cm **08.366.10**

STEVENS

10,5 cm **08.367.10**

## Scheren, Ophthal., Nase

Scissors, Ophthal., Nasal  
Ciseaux, ophtal., nasaux  
Tijeras, oftalmología, nasales  
Forbici, oftalmologia, nasali



10,0 cm **08.369.10**



12,5 cm **08.369.12**

Strabismusscheren  
Strabismus scissors  
Ciseaux à strabisme  
Tijeras para estrabismo  
Forbici per strabismo

TC-Schneiden  
TC Cutting Edges  
Tranchant TC  
Filos de corte TC  
Taglio TC



11,0 cm **08.370.11**

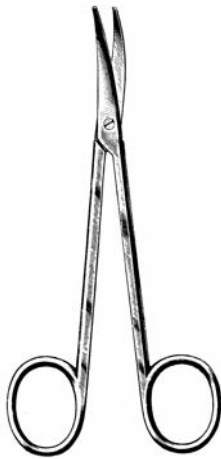

11,0 cm **08.371.11**



11,0 cm **08.374.11**



11,0 cm **08.375.11**

**Scheren, Ophthal., Nase**

Scissors, Ophthal., Nasal  
Ciseaux, ophtal., nasaux  
Tijeras, oftalmología, nasales  
Forbici, oftalmologia, nasali

Enucleationsscheren  
Enucleation scissors  
Ciseaux à enucléation  
Tijeras para enucleación  
Forbici per enucleazione



LANDOLT  
11,0 cm **08.381.11**  
13,0 cm **08.381.13**



LANDOLT  
13,0 cm **08.383.13**



HEYMANN  
18,0 cm **08.401.18**



FOMON  
14,0 cm **08.403.14**  
15,0 cm **08.403.15**



COTTLE  
16,0 cm **08.405.16**



COTTLE  
16,0 cm **08.407.16**

TC-Schneiden  
TC Cutting Edges  
Tranchant TC  
Filos de corte TC  
Taglio TC

## Tonsillen-, Gefäß-Scheren

Tonsil, Vascular Scissors  
Ciseaux amygdal., vasculaires  
Tijeras, amígdal., vasculares  
Forbici, tonsill., vascolari



BEUSE  
14,0 cm **08.420.14**  
18,0 cm **08.420.18**



BEUSE  
14,0 cm **08.421.14**  
18,0 cm **08.421.18**



aufgewinkelt  
angled upwards  
coudée en haut  
angulada  
angolari sul piatto

DEAN  
17,0 cm **08.425.17**



gezahnt, aufgewinkelt  
toothed, angled upwards  
dentelés, coudée en haut  
dentada, angulada  
dentate, angolari sul piatto

DEAN  
17,0 cm **08.427.17**

**Tonsillen-, Gefäß-Scheren**

Tonsil, Vascular Scissors

Ciseaux amygdal., vasculaires

Tijeras, amígdal., vasculares

Forbici, tonsill., vascolari

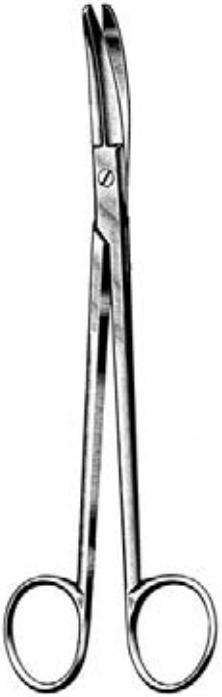

**BOETTCHER**  
18,0 cm **08.435.18**

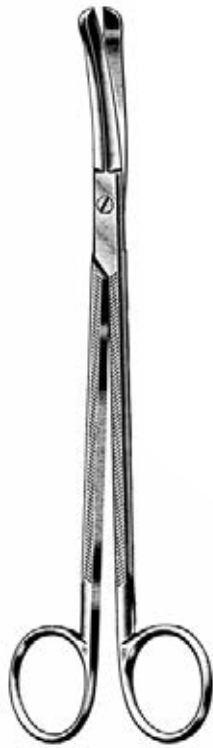

**GOOD**  
19,0 cm **08.437.19**



**PRINCE**  
17,0 cm **08.439.17**



**08.468.15**



**08.470.11**



**POTTS-DE MARTEL**  
21,0 cm **08.473.21**  
24,0 cm **08.473.24**



**MILLS**  
22,0 cm **08.475.22**

## Gefäß-Scheren

Vascular Scissors  
Ciseaux vasculaires  
Tijeras vasculares  
Forbici vascolari



POTTS-SMITH

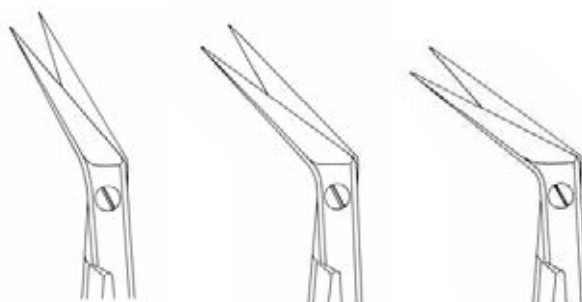

19,0 cm **08.480.25** **08.480.40** **08.480.60**



POTTS-SMITH

TC-Schneiden  
TC Cutting Edges  
Tranchant TC  
Filos de corte TC  
Taglio TC

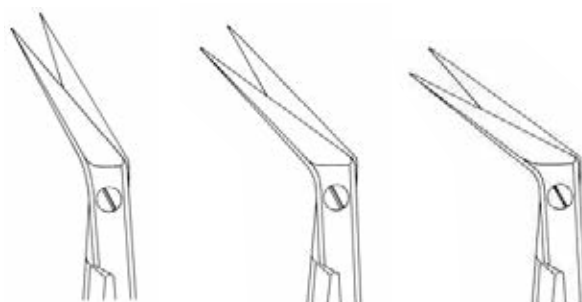

19,0 cm **08.484.25** **08.484.40** **08.484.60**



**Gefäß-Scheren**  
Vascular Scissors  
Ciseaux vasculaires  
Tijeras vasculares  
Forbici vascolari



25°

DIETHRICH  
18,0 cm **08.486.25**



45°

DIETHRICH  
18,0 cm **08.486.45**



60°

DIETHRICH  
18,0 cm **08.486.60**



90°

DIETHRICH  
18,0 cm **08.486.90**



125°

DIETHRICH  
18,0 cm **08.487.25**



125°

DIETHRICH  
18,0 cm **08.488.25**

## Gefäß-Scheren

Vascular Scissors  
Ciseaux vasculaires  
Tijeras vasculares  
Forbici vascolari

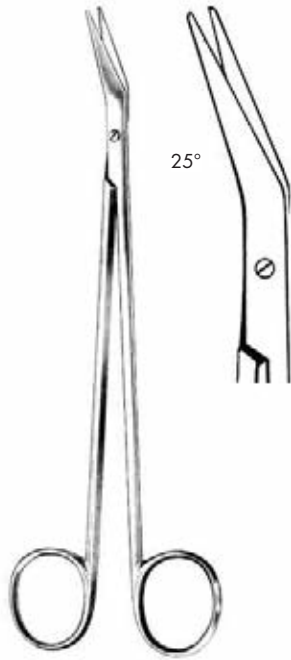

DE BAKEY

16,0 cm **08.490.16**  
23,0 cm **08.490.23**  
28,0 cm **08.490.28**

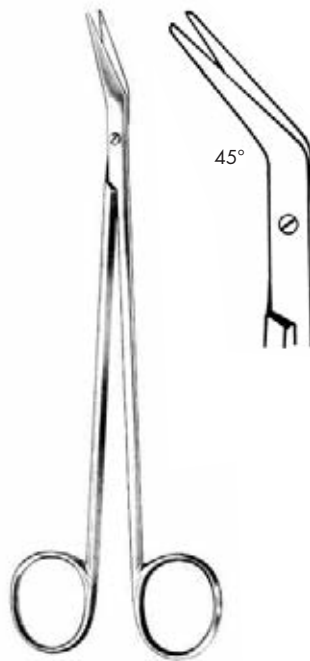

DE BAKEY

16,0 cm **08.491.16**  
23,0 cm **08.491.23**  
28,0 cm **08.491.28**

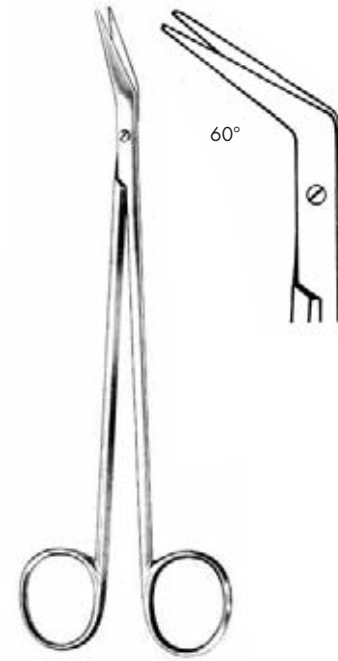

DE BAKEY

16,0 cm **08.492.16**  
23,0 cm **08.492.23**  
28,0 cm **08.492.28**

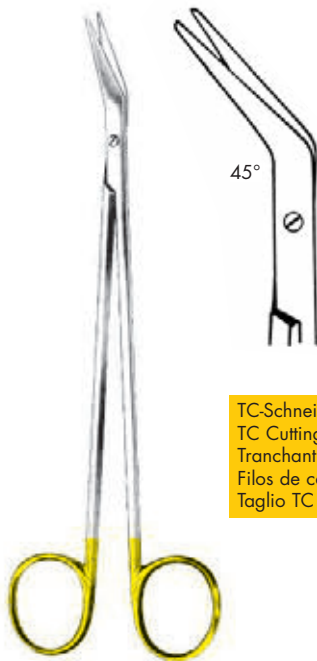

TC-Schneiden  
TC Cutting Edges  
Tranchant TC  
Filos de corte TC  
Taglio TC

DE BAKEY

23,0 cm **08.493.23**

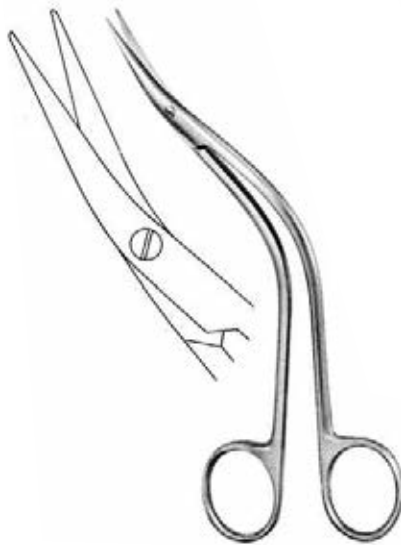

DE BAKEY

15,5 cm **08.495.15**

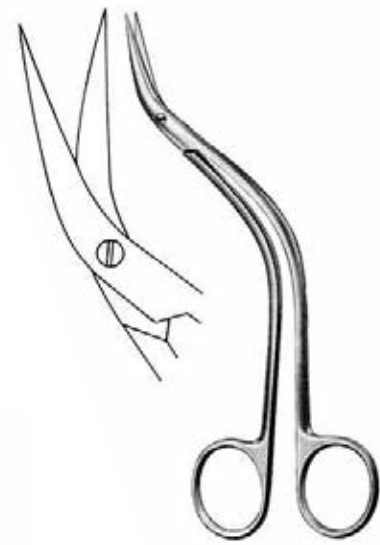

DE BAKEY

15,5 cm **08.497.15**

Parametrium



22,5 cm **08.501.22**



22,5 cm **08.501.23**

TC-Schneiden  
TC Cutting Edges  
Tranchant TC  
Filos de corte TC  
Taglio TC



22,5 cm **08.505.22**



22,5 cm **08.505.23**

## Gynäkologische Scheren

Gynaecological Scissors  
Ciseaux gynécologiques  
Tijeras ginecológicas  
Forbici ginecologiche



SIMS

20,0 cm **08.510.20**  
23,0 cm **08.510.23**



SIMS

20,0 cm **08.511.20**  
23,0 cm **08.511.23**



SIMS

23,0 cm **08.514.23**



SIMS

20,0 cm **08.515.20**  
23,0 cm **08.515.23**

TC-Schneiden  
TC Cutting Edges  
Tranchant TC  
Filos de corte TC  
Taglio TC



SIEBOLD

24,0 cm **08.523.24**



WERTHEIM

22,5 cm **08.525.22**



WERTHEIM

22,5 cm **08.527.22**

TC-Schneiden  
TC Cutting Edges  
Tranchant TC  
Filos de corte TC  
Taglio TC

## Gynäkologische Scheren

Gynaecological Scissors  
Ciseaux gynécologiques  
Tijeras ginecológicas  
Forbici ginecologiche

**dimeda**<sup>®</sup>  
SURGICAL INSTRUMENTS



DOYEN  
18 cm **08.530.17**

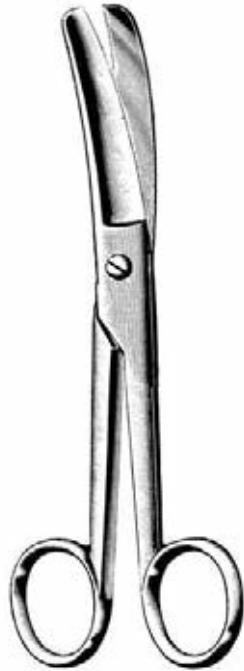

DOYEN  
18 cm **08.531.17**



DUBOIS  
27,0 cm **08.536.27**



DUBOIS  
27,0 cm **08.537.27**



KELLY  
16,0 cm **08.540.16**  
18,0 cm **08.540.18**



KELLY  
16,0 cm **08.541.16**  
18,0 cm **08.541.18**

Scheren / Scissors / Ciseaux / Tijeras / Forbici

## Chirurgische Scheren

Operating Scissors  
Ciseaux à chirurgie  
Tijeras para cirugía  
Forbici per chirurgia

Nabelschnur-Scheren  
Umbilical Scissors  
Ciseaux ombilicaux  
Tijeras umbilicales  
Forbici ombelicali



U.S.A Mod.  
10,5 cm **08.550.10**



BUSCH  
16,0 cm **08.551.16**



SCHUMACHER  
14,0 cm **08.553.16**



WALDMANN  
18,0 cm **08.555.18**



Episiotomie  
Episiotomy  
Episiotomia  
Episiotomía  
Episiotomia

BRAUN-STADLER  
14,5 cm **08.560.14**  
20,0 cm **08.560.20**  
22,0 cm **08.560.22**

Nerv-Präparierscheren  
Nerve dissecting Scissors  
Ciseaux pour nerfs  
Tijeras para nervios  
Forbici per nervi



11,0 cm **08.580.11**



11,0 cm **08.581.11**

## Chirurgische Scheren

Operating Scissors  
Ciseaux à chirurgie  
Tijeras para cirugía  
Forbici per chirurgia

**dimeda**<sup>®</sup>  
SURGICAL INSTRUMENTS

Neurochirurgie  
Neurosurgery  
Neurochirurgie  
Neurocirugía  
Neurochirurgia



15,0 cm **08.582.15**



15,0 cm **08.583.15**

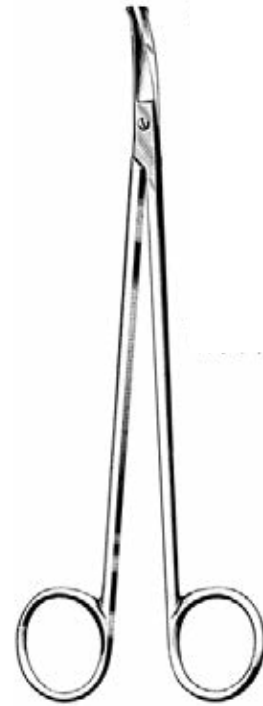

STRULLY  
22,0 cm **08.601.22**



TOENNIS-ADSON  
18,0 cm **08.610.18**



TOENNIS-ADSON  
18,0 cm **08.611.18**



MC INDOE  
19,0 cm **08.614.19**

Scheren / Scissors / Ciseaux / Tijeras / Forbici

## Chirurgische Scheren

Operating Scissors  
Ciseaux à chirurgie  
Tijeras para cirugía  
Forbici per chirurgia



DANDY  
17,0 cm **08.617.17**



SCHMIEDEN-TAYLOR  
17,0 cm **08.619.17**

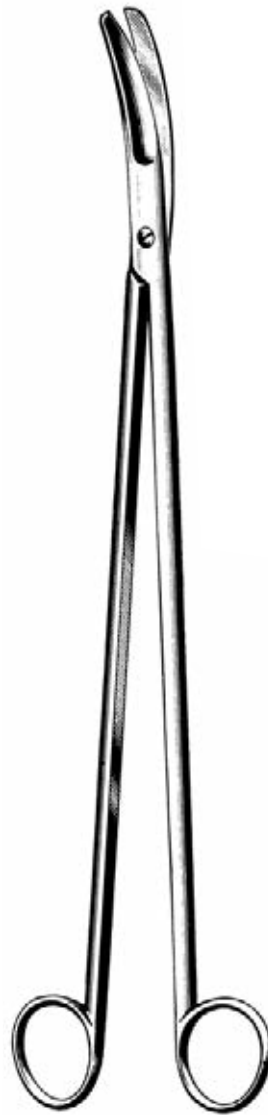

CRAFOORD  
30,0 cm **08.641.30**



THOREK  
19,0 cm **08.643.18**  
25,0 cm **08.643.25**



## Chirurgische Scheren

Operating Scissors  
Ciseaux à chirurgie  
Tijeras para cirugía  
Forbici per chirurgia

**dimeda**<sup>®</sup>  
SURGICAL INSTRUMENTS

Scheren / Scissors / Ciseaux / Tijeras / Forbici



SATINSKY  
21,0 cm **08.650.21**

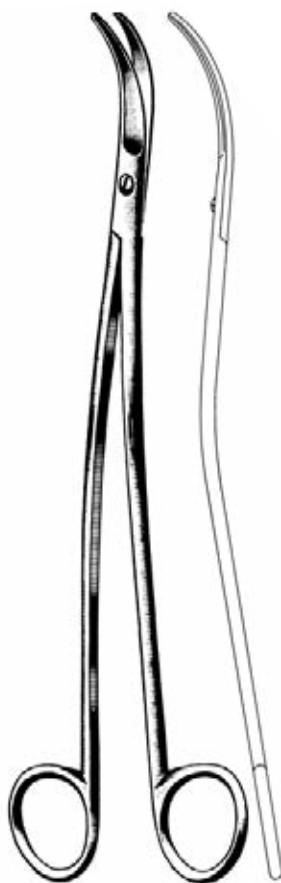

SATINSKY  
24,5 cm **08.651.24**

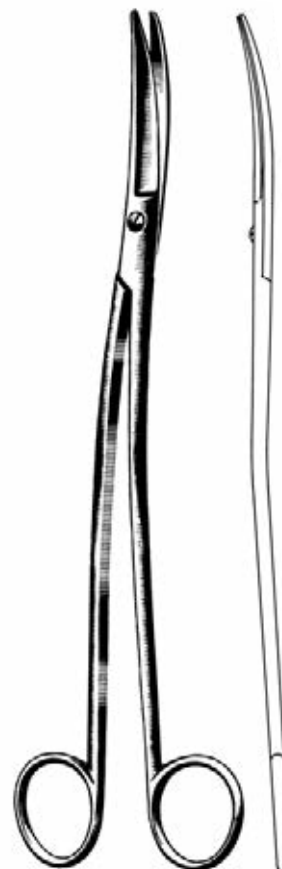

KLINKENBERG-LOTH  
23,0 cm **08.661.23**

## Chirurgische Scheren

Operating Scissors  
Ciseaux à chirurgie  
Tijeras para cirugía  
Forbici per chirurgia

Lungenlappen- und Rektumscheren  
Lobectomy and rectal scissors  
Ciseaux à lobectomie et pour le rectum  
Tijera para lobectomía y recto  
Forbici per lobo polmonare e per il retto



FINOCHIETTO  
27,0 cm **08.663.27**



STELZNER  
30,0 cm **08.664.30**



STELZNER  
30,0 cm **08.665.30**

## Chirurgische Scheren

Operating Scissors  
Ciseaux à chirurgie  
Tijeras para cirugía  
Forbici per chirurgia

**dimeda**<sup>®</sup>  
SURGICAL INSTRUMENTS

Scheren / Scissors / Ciseaux / Tijeras / Forbici

Darmscheren  
Enterotomy Scissors  
Ciseaux à entérotomie  
Enterótomos  
Forbici per enterotomia

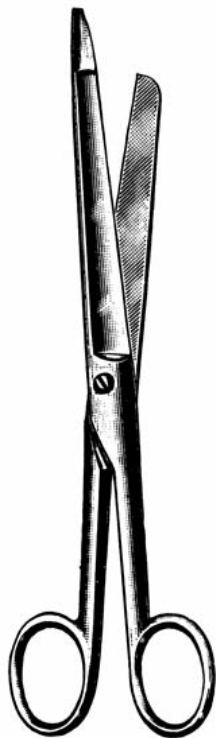

21,0 cm **08.770.21**

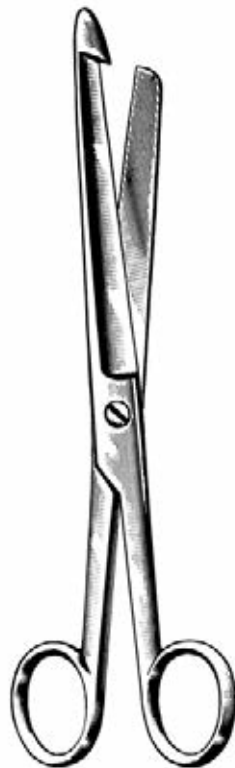

21,0 cm **08.772.21**

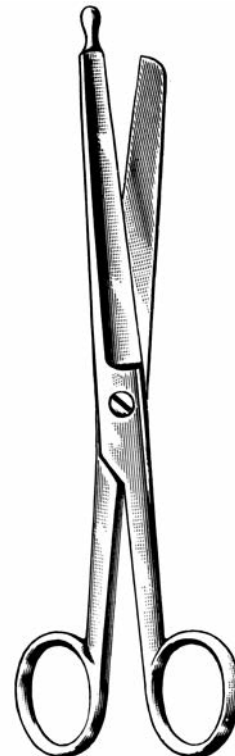

21,0 cm **08.774.21**

## Chirurgische Scheren

Operating Scissors  
Ciseaux à chirurgie  
Tijeras para cirugía  
Forbici per chirurgia

Ligaturscheren  
Stitch Scissors  
Ciseaux à ligatures  
Tijeras para puntas  
Forbici per legature



SPENCER

9,0 cm **08.802.09**  
11,0 cm **08.802.11**  
12,0 cm **08.802.12**  
15,0 cm **08.802.15**



SHORTBENT

9,0 cm **08.803.09**



NORTHBENT

13,0 cm **08.803.13**



LITTAUER

14,0 cm **08.804.14**



BUCK

14,5 cm **08.806.14**  
18,0 cm **08.806.18**



HEATH

15,0 cm **08.809.15**

## Chirurgische Scheren

Operating Scissors  
Ciseaux à chirurgie  
Tijeras para cirugía  
Forbici per chirurgia

**dimeda**<sup>®</sup>  
SURGICAL INSTRUMENTS

Zahnfleischscheren  
Gum Scissors  
Ciseaux à gencives  
Tijeras para encías  
Forbici gengivali

gezahnt  
serrated  
dentelé  
dentada  
dentellate



11,5 cm **08.815.11**



LAGRANGE  
11,5 cm **08.817.11**



LAGRANGE  
11,5 cm **08.819.11**



GOLDMANN-FOX  
13,0 cm **08.820.13**



GOLDMANN-FOX  
13,0 cm **08.821.13**

gezahnt  
serrated  
dentelé  
dentada  
dentellate



GOLDMANN-FOX  
13,0 cm **08.822.13**

TC-Schneiden  
TC Cutting Edges  
Tranchant TC  
Filos de corte TC  
Taglio TC



GOLDMANN-FOX  
13,0 cm **08.823.13**

Scheren / Scissors / Ciseaux / Tijeras / Forbici

## Chirurgische Scheren

Operating Scissors  
Ciseaux à chirurgie  
Tijeras para cirugía  
Forbici per chirurgia

Zahnfleischscheren  
Gum Scissors  
Ciseaux à gencives  
Tijeras para encías  
Forbici gengivali



WAGNER  
12,0 cm **08.824.12**



WAGNER  
12,0 cm **08.825.12**



QUINBY  
12,0 cm **08.827.12**

Draht, Blehscheren  
Wire and plate shears  
Ciseaux à fils et plaques métalliques  
Tijeras para alambre y chapas  
Forbice per filo metallo lamiera



UNIVERSAL  
12,0 cm **08.831.12**



UNIVERSAL  
12,0 cm **08.835.12**

TC-Schneiden  
TC Cutting Edges  
Tranchant TC  
Filos de corte TC  
Taglio TC

## Chirurgische Scheren

Operating Scissors  
Ciseaux à chirurgie  
Tijeras para cirugía  
Forbici per chirurgia

**dimeda**<sup>®</sup>  
SURGICAL INSTRUMENTS

Draht, Blehscheren  
Wire and plate shears  
Ciseaux à fils et plaques métalliques  
Tijeras para alambre y chapas  
Forbice per filo metallo lamiera

spitz  
pointed  
pointus  
agudas  
acute

stumpf  
blunt  
mousses  
romas  
smusse



gerade  
straight  
droites  
rectas  
rette



gebogen  
curved  
courbes  
curvas  
curve



gerade  
straight  
droites  
rectas  
rette



gebogen  
curved  
courbes  
curvas  
curve

BEEBE  
10,5 cm **08.850.10**

BEEBE  
10,5 cm **08.851.10**

BEEBE  
10,5 cm **08.852.10**

BEEBE  
10,5 cm **08.853.10**

gerade  
straight  
droites  
rectas  
rette



gezahnt  
serrated  
dentelé  
dentada  
dentellate



gebogen  
curved  
courbes  
curvas  
curve

BEEBE  
12,0 cm **08.854.12**

BEEBE  
12,0 cm **08.855.12**

## Chirurgische Scheren

Operating Scissors  
Ciseaux à chirurgie  
Tijeras para cirugía  
Forbici per chirurgia



LANGE  
18,0 cm **08.896.18**



Gaze  
Gauze  
Gaze  
Gaza  
Garza

SMITH US ARMY  
15,0 cm **08.898.15**  
16,0 cm **08.898.16**  
18,0 cm **08.898.18**  
20,0 cm **08.898.20**  
23,0 cm **08.898.23**



## Verband-Scheren

Bandage Scissors  
Ciseaux à bandages  
Tijeras para vendajes  
Forbici per bendaggi

**dimeda**<sup>®</sup>  
SURGICAL INSTRUMENTS

L = Für Linkshänder  
For left-handed  
Pour la main gauche  
Para zurdo  
Per mancini

Scheren / Scissors / Ciseaux / Tijeras / Forbici



LISTER

9,5 cm **08.901.09**  
11,0 cm **08.901.11**  
14,0 cm **08.901.14**  
14,0 cm **08.901.14L**  
16,0 cm **08.901.16**  
16,0 cm **08.901.16L**  
18,0 cm **08.901.18**  
18,0 cm **08.901.18L**  
20,0 cm **08.901.20**  
25,0 cm **08.901.25**  
30,0 cm **08.901.30**



LISTER

14,0 cm **08.902.14**



LISTER

18,0 cm **08.903.18**  
20,0 cm **08.903.20**



TC-Schneiden  
TC Cutting Edges  
Tranchant TC  
Filos de corte TC  
Taglio TC

LISTER

14,0 cm **08.905.14**  
18,0 cm **08.905.18**  
20,0 cm **08.905.20**

**Verband-Scheren**  
Bandage Scissores  
Ciseaux à bandages  
Tijeras para vendajes  
Forbici per bendaggi



BERGMANN  
23,0 cm **08.911.23**



ESMARCH  
20,0 cm **08.913.20**  
22,0 cm **08.913.22**



DIMEDA Excenter  
16,0 cm **08.921.16**  
19,0 cm **08.921.19**

**Verband-Scheren**

Bandage Scissors  
Ciseaux à bandages  
Tijeras para vendajes  
Forbici per bendaggi

**dimeda**<sup>®</sup>  
SURGICAL INSTRUMENTS

Scheren / Scissors / Ciseaux / Tijeras / Forbici



ROTES KREUZ  
17,0 cm **08.927.17**



KNOWLES  
14,0 cm **08.930.14**



KNOWLES  
14,0 cm **08.931.14**



LORENZ  
23,0 cm **08.933.23**

**Verband-Scheren**  
Bandage Scissores  
Ciseaux à bandages  
Tijeras para vendajes  
Forbici per bendaggi

eine Schneide gezahnt  
one serrated cutting edge  
une lame dentelé  
una hoja cortante dentada  
una lama dentada

TC-Schneiden  
TC Cutting Edges  
Tranchant TC  
Filos de corte TC  
Taglio TC



BRUNS  
23,0 cm **08.935.23**



BRUNS  
23,0 cm **08.937.23**



BRUNS  
23,0 cm **08.939.23**

**Verband-Scheren**

Bandage Scissors  
Ciseaux à bandages  
Tijeras para vendajes  
Forbici per bendaggi

Gipsschere  
Plaster Shear  
Ciseaux pour plâtre  
Tijera para yeso  
Forbice per gesso



20,0 cm **08.941.20**



FERGUSSON  
18,0 cm **08.942.18**

## Verband-Scheren

Bandage Scissores  
Ciseaux à bandages  
Tijeras para vendajes  
Forbici per bendaggi



14,5 cm **08.952.14**



UNIVERSAL

schwarz  
black  
noir  
negro  
nero

blau  
blue  
bleu  
azul  
blu

grün  
green  
vert  
verde  
verde

rot  
red  
rouge  
rojo  
rosso

gelb  
yellow  
jaune  
amarillo  
giallo

weiß  
white  
blanc  
blanco  
bianco

15 cm	<b>08.950.15</b>	<b>08.950.15B</b>	<b>08.950.15G</b>	<b>08.950.15R</b>	<b>08.950.15Y</b>	<b>08.950.15W</b>
18 cm	<b>08.950.18</b>	<b>08.950.18B</b>	<b>08.950.18G</b>	<b>08.950.18R</b>	<b>08.950.18Y</b>	<b>08.950.18W</b>

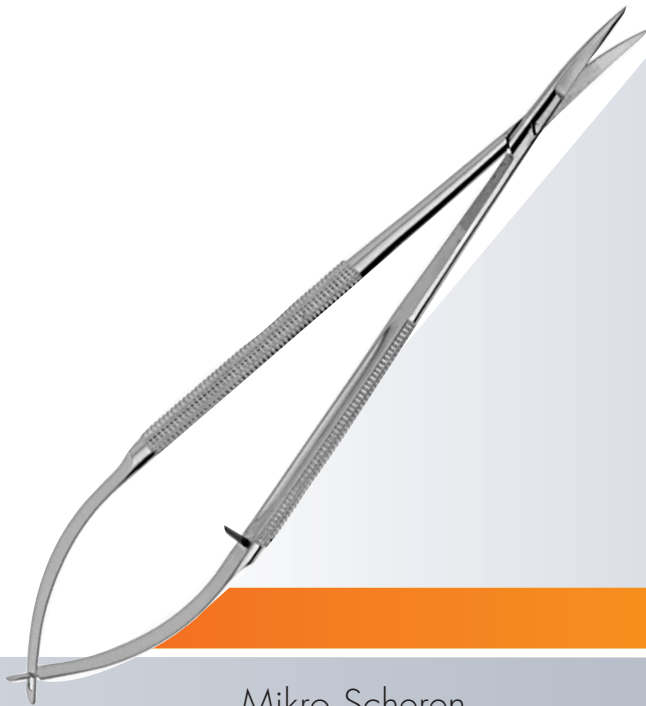

Mikro Scheren  
Micro Scissors  
Micro Ciseaux  
Micro Tijeras  
Micro Forbici

**Augen Scheren**  
 Ophthalmic Scissors  
 Ciseaux oculaires  
 Tijeras oculares  
 Forbici oculistiche

Sehnen-Scheren  
 Tendon Scissors  
 Ciseaux tendons  
 Tijeras tendones  
 Forbici tendini

Iridektomiescheren  
 Iridectomy Scissors  
 Ciseaux à iridectomie  
 Tijeras para iridectomia  
 Forbici per iridectomia



spitz  
 sharp  
 pointu  
 agudo  
 appuntato



stumpf  
 blunt  
 mousse  
 romo  
 smusso



gerade  
 straight  
 droits  
 rectas  
 rette



gebogen  
 curved  
 courbes  
 curvas  
 curve

WESTCOTT  
 11,0 cm **09.102.11**

WESTCOTT  
 11,0 cm **09.104.11**

WESTCOTT  
 11,0 cm **09.106.11**

WESTCOTT  
 11,0 cm **09.107.11**





Sehnen-, Iris-Scheren  
 Tendon, Iris Scissors  
 Ciseaux à iris et tendons  
 Tijeras iris y para tendones  
 Forbici per iride e tendini

NOYES  
 13,0 cm **09.109.13**  
 16,0 cm **09.109.16**



spitz/spitz  
 sharp/sharp  
 pointu/pointu  
 agudo/agudo  
 appuntato/appuntato



Fig. 1

NOYES  
 12,0 cm **09.110.12**

spitz/stumpf  
 sharp/blunt  
 pointu/mousse  
 agudo/romo  
 appuntato/smusso



Fig. 2

NOYES  
 12,0 cm **09.111.12**

stumpf/stumpf  
 blunt/blunt  
 mousse/mousse  
 romo/romo  
 smusso/smusso



Fig. 3

NOYES  
 12,0 cm **09.112.12**

**Augen Scheren**  
 Ophthalmic Scissors  
 Ciseaux oculaires  
 Tijeras oculares  
 Forbici oculistiche

Sehnen-, Iris-Scheren  
 Tendon, Iris Scissors  
 Ciseaux à iris et tendons  
 Tijeras iris y para tendones  
 Forbici per iride e tendini



WECKER  
 11,0 cm **09.113.11**

spitz/spitz  
 sharp/sharp  
 pointu/pointu  
 agudo/agudo  
 appuntato/appuntato



NOYES  
 12,0 cm **09.110.12**

spitz/stumpf  
 sharp/blunt  
 pointu/mousse  
 agudo/romo  
 appuntato/smusso



NOYES  
 12,0 cm **09.111.12**

stumpf/stumpf  
 blunt/blunt  
 mousse/mousse  
 romo/romo  
 smusso/smusso



NOYES  
 12,0 cm **09.112.12**



McPherson-Westcott  
 10,0 cm **09.118.01**



spitz  
 sharp  
 pointu  
 agudo  
 appuntato



McPherson-Westcott  
 10,0 cm **09.118.02**



stumpf  
 blunt  
 mousse  
 romo  
 smusso

Blattlänge 10 mm  
 length of blades 10 mm  
 longueur des lames 10 mm  
 largo de hojas 10 mm  
 lunghezza della lama 10 mm



BARRAQUER  
 5,5 cm **09.119.10**

Iridektomie, Hornhaut  
 Iridectomy, corneal  
 Iridectomie, cornéens  
 Iridectomía, corneal  
 Iridectomia, corneale



McGUIRE  
 10,0 cm **09.121.10**

spitz  
 sharp  
 pointu  
 agudo  
 appuntato



CASTROVIEJO  
 10,0 cm **09.133.10**

stumpf  
 blunt  
 mousse  
 romo  
 smusso



CASTROVIEJO  
 10,0 cm **09.135.10**

gerade  
 straight  
 droits  
 rectas  
 rette



VANNAS  
 8,0 cm **09.140.08**

gebogen  
 curved  
 courbes  
 curvas  
 curve



VANNAS  
 8,0 cm **09.141.08**

kniegebogen  
 angular  
 coudés  
 acodadas  
 angolate



VANNAS  
 8,0 cm **09.143.08**

## Augen-, Mikro-Scheren

Ophthalmic, Micro Scissors

Ciseaux oculaires, micro-ciseaux

Tijeras oculares, microquirúrgicas

Forbici oculistiche, micro-chirurg.

Iridektomie, Hornhaut

Iridectomy, corneal

Iridectomie, cornéens

Iridectomía, corneal

Iridectomia, corneale



links  
left  
gauche  
izquierda  
sinistra

CASTROVIEJO  
10,0 cm **09.147.10**



rechts  
right  
droite  
derecha  
destra

CASTROVIEJO  
10,0 cm **09.149.10**



stumpf  
blunt  
mousse  
romo  
smusso

CASTROVIEJO  
11,0 cm **09.151.11**



stumpf  
blunt  
mousse  
romo  
smusso

CASTROVIEJO  
11,0 cm **09.153.11**



stumpf  
blunt  
mousse  
romo  
smusso

CASTROVIEJO  
11,0 cm **09.155.11**



Mikrochirurgie  
Micro Surgery  
Microchirurgie  
Microcirugía  
Microchirurgia

10,0 cm **09.157.10**

**Augen-, Mikro-Scheren**  
 Ophthalmic, Micro Scissors  
 Ciseaux oculaires, micro-ciseaux  
 Tijeras oculares, microquirúrgicas  
 Forbici oculistiche, micro-chirurg.



links  
 left  
 gauche  
 izquierda  
 sinistra

TROUTMAN-CASTROVIEJO  
 11,0 cm **09.161.11**



rechts  
 right  
 droite  
 derecha  
 destra

TROUTMAN-CASTROVIEJO  
 11,0 cm **09.163.11**



gerade  
 straight  
 droits  
 rectas  
 rette

14,0 cm **09.202.14**  
 18,0 cm **09.202.18**



gebogen  
 curved  
 courbes  
 curvas  
 curve

14,0 cm **09.203.14**  
 18,0 cm **09.203.18**



gerade  
 straight  
 droits  
 rectas  
 rette

18,0 cm **09.204.18**



stumpf  
 blunt  
 mousse  
 romo  
 smusso

18,0 cm **09.205.18**

## Augen-, Mikro-Scheren

Ophthalmic, Micro Scissors

Ciseaux oculaires, micro-ciseaux

Tijeras oculares, microquirúrgicas

Forbici oculistiche, micro-chirurg.

spitz  
sharp  
pointu  
agudo  
appuntato



14,5 cm **09.220.14**  
18,0 cm **09.220.18**  
23,0 cm **09.220.23**

spitz  
sharp  
pointu  
agudo  
appuntato



14,5 cm **09.221.14**  
18,0 cm **09.221.18**  
23,0 cm **09.221.23**

stumpf  
blunt  
mousse  
romo  
smusso



14,5 cm **09.223.14**  
18,0 cm **09.223.18**

## Augen-, Mikro-Scheren

Ophthalmic, Micro Scissors

Ciseaux oculaires, micro-ciseaux

Tijeras oculares, microquirúrgicas

Forbici oculistiche, micro-chirurg.

**dimeda**<sup>®</sup>  
SURGICAL INSTRUMENTS

spitz  
sharp  
pointu  
agudo  
appuntato



18 cm



**09.224.25**  
25°



**AJ.224.45**  
45°



**09.224.60**  
60°



**AJ.224.90**  
90°



**AJ.225.00**  
125°

1 Blatt geknöpft  
1 probe-pointed blade  
1 lame boutonnée  
1 hoja botonada  
1 lama bottonnta



18 cm



**09.225.25**  
25°



**AJ.225.45**  
45°



**09.225.60**  
60°



**AJ.225.90**  
90°



**AJ.226.00**  
125°

Mikro Scheren / Micro Scissors / Micro Ciseaux / Micro Tijeras / Micro Forbici

## Augen-, Mikro-Scheren

Ophthalmic, Micro Scissors

Ciseaux oculaires, micro-ciseaux

Tijeras oculares, microquirúrgicas

Forbici oculistiche, micro-chirurg.

aufgebogen  
upwards curved  
courbe vers le haut  
curvada hacia arriba  
curvato verso l'alto

abwärts gebogen  
upwards curved  
courbe en bas  
curvada hacia abajo  
curvato verso il basso

gerade  
straight  
droits  
rectas  
rette

stumpf  
blunt  
mousse  
romo  
smusso



YASARGIL  
16,5 cm **09.250.16**  
20,0 cm **09.250.20**  
22,5 cm **09.250.22**



YASARGIL  
16,5 cm **09.251.16**  
20,0 cm **09.251.20**  
22,5 cm **09.251.22**  
24,5 cm **09.251.24**



YASARGIL  
20,0 cm **09.253.20**  
22,5 cm **09.253.22**



YASARGIL  
20,0 cm **09.254.20**  
22,5 cm **09.254.22**



**Augen-, Mikro-Scheren**  
 Ophthalmic, Micro Scissors  
 Ciseaux oculaires, micro-ciseaux  
 Tijeras oculares, microquirúrgicas  
 Forbici oculistiche, micro-chirurg.

stumpf  
 blunt  
 mousse  
 romo  
 smusso



**YASARGIL**  
 20,0 cm **09.255.20**  
 22,5 cm **09.255.22**

gebogen  
 curved  
 courbes  
 curvas  
 curve



**JACOBSON**  
 19,0 cm **09.257.19**

gerade  
 straight  
 droits  
 rectas  
 rette



**YASARGIL**  
 12,0 cm **09.260.12**  
 16,0 cm **09.260.16**  
 18,0 cm **09.260.18**

gebogen  
 curved  
 courbes  
 curvas  
 curve



**YASARGIL**  
 12,0 cm **09.261.12**  
 16,0 cm **09.261.16**  
 18,0 cm **09.261.18**

## Augen-, Mikro-Scheren

Ophthalmic, Micro Scissors

Ciseaux oculaires, micro-ciseaux

Tijeras oculares, microquirúrgicas

Forbici oculistiche, micro-chirurg.

gerade  
straight  
droits  
rectas  
rette



VANNAS  
12,0 cm **09.262.12**  
16,0 cm **09.262.16**

gebogen  
curved  
courbes  
curvas  
curve



VANNAS  
12,0 cm **09.263.12**  
16,0 cm **09.263.16**

**Augen-, Mikro-Scheren**

Ophthalmic, Micro Scissors  
Ciseaux oculaires, micro-ciseaux  
Tijeras oculares, microquirúrgicas  
Forbici oculistiche, micro-chirurg.

gerade  
straight  
droits  
rectas  
rette



18,5 cm **09.266.18**

gebogen  
curved  
courbes  
curvas  
curve



18,5 cm **09.267.18**

gerade  
straight  
droits  
rectas  
rette



VANNAS  
18,5 cm **09.268.18**

gebogen  
curved  
courbes  
curvas  
curve



VANNAS  
18,5 cm **09.269.18**



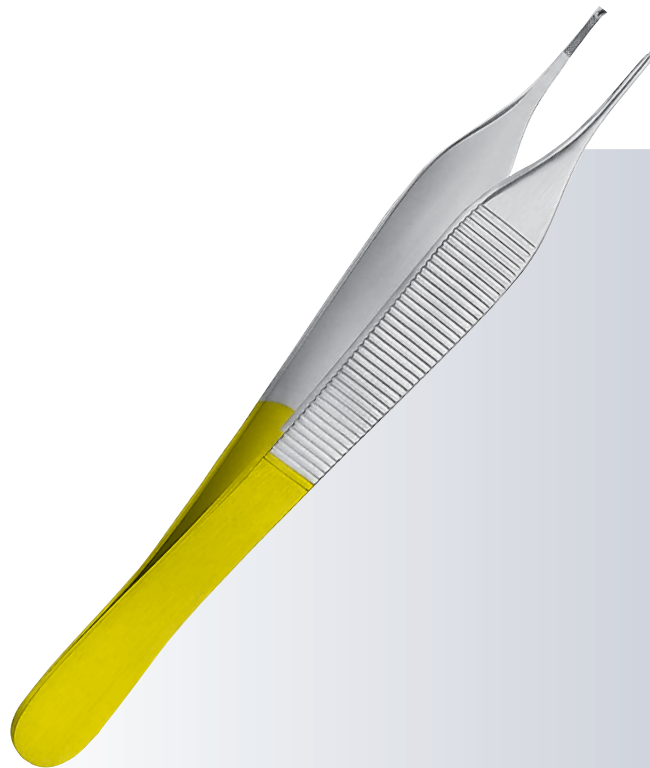

Pinzetten  
Thumb and Tissue Forceps  
Pinces à dissection  
Pinzas de disección  
Pinze per dissezione

## Pinzetten

Thumb and Tissue Forceps

Pinces à dissection

Pinzas de disección

Pinze per dissezione

cm		USA	STILLE				
11,5	10.102.11						
12,0		10.104.12					
13,0	10.102.13	10.104.13	10.106.13	10.110.13			
14,5	10.102.14	10.104.14		10.110.14	10.114.14		
15,0			10.106.15				
15,5		10.104.15					
16,0	10.102.16			10.110.16	10.114.16		
18,0	10.102.18	10.104.18		10.110.18		10.112.18	10.116.18
20,0	10.102.20		10.106.20	10.110.20			10.126.18
21,0		10.104.21				10.112.21	10.116.21
25,0	10.102.25	10.104.25		10.110.25		10.112.25	10.116.25
30,0	10.102.30			10.110.30		10.112.30	10.126.25

cm		USA	STILLE				
11,5	10.120.11				10.130.11	10.140.11	
12,0		10.122.12					
13,0	10.120.13	10.122.13			10.130.13	10.140.13	10.150.13
14,5	10.120.14	10.122.14			10.130.14	10.140.14	10.150.14
15,0			10.124.15				10.160.13
15,5		10.122.15					10.160.14
16,0	10.120.16				10.130.16	10.140.16	10.150.16
18,0	10.120.18	10.122.18			10.130.18	10.140.18	
20,0	10.120.20				10.130.20	10.140.20	10.150.20
21,0		10.122.21	10.124.21				10.160.20
25,0	10.120.25	10.122.25			10.130.25	10.140.25	
30,0	10.120.30				10.130.30		

**Pinzette**

Thumb and Tissue Forceps  
 Pincès à dissection  
 Pinzas de disección  
 Pinze per dissezione

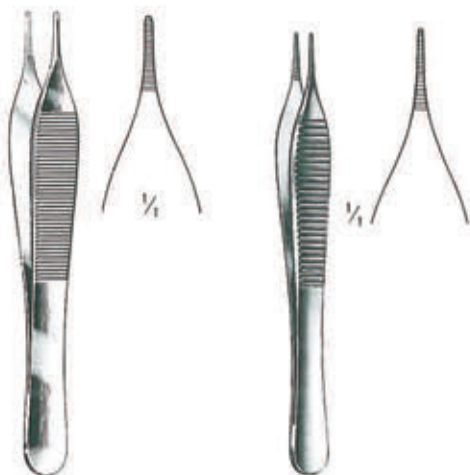

cm	ADSON	ADSON micro
12,0	10.170.12	10.176.12
12,0	10.174.12	
15,0	10.170.15	10.176.15
15,0	10.174.15	



CUSHING  
 10.220.17  
 10.224.17  
 17 cm

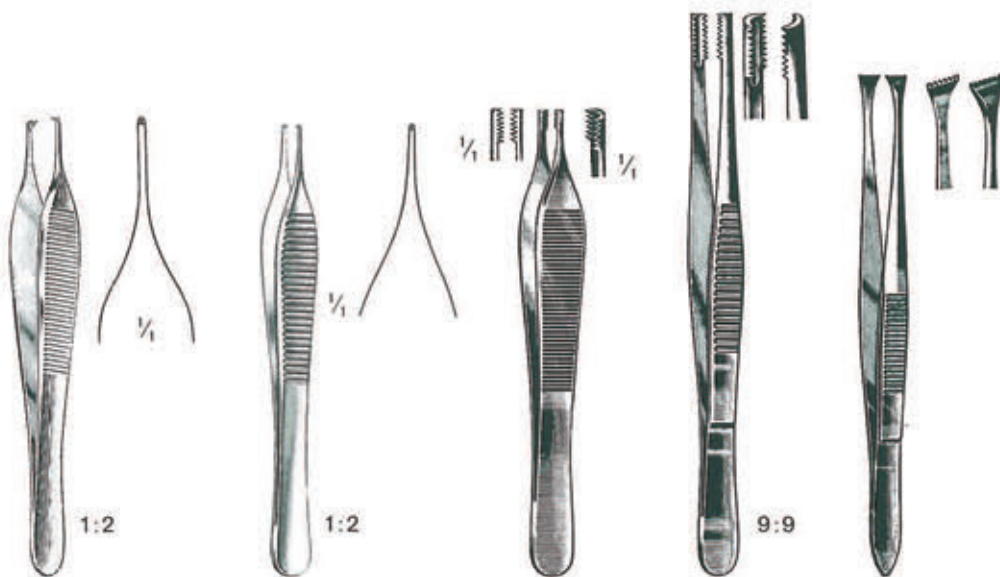

cm	ADSON	ADSON micro	ADSON-BROWN	BROWN	GRAEFE
10,5					10.190.10
12,0	10.180.12	10.186.12	10.188.12 7:7		
12,0			10.189.12 9:9		
15,0	10.180.15	10.186.15			
16,0				10.189.16	
20,0				10.189.20	
25,0				10.189.25	



CUSHING  
 10.230.17  
 17 cm

Pinzette / Thumb and Tissue Forceps / Pincès à dissection / Pinzas de disección / Pinze per dissezione



## Pinzetten

Thumb and Tissue Forceps

Pinces à dissection

Pinzas de disección

Pinze per dissezione

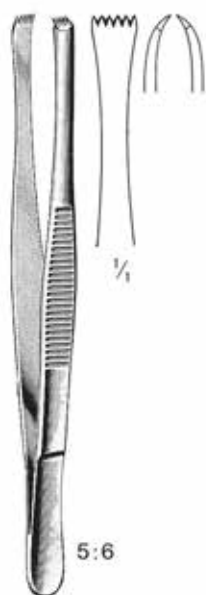

5:6

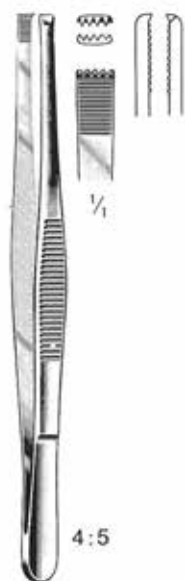

4:5



1:2



2:3



1:2



2:3

cm	LERCHE	ADLERKREUTZ	LANE	LANE	FERRIS-SMITH	FERRIS-SMITH
14,5			10.240.14	10.242.14		
15,0	10.232.15	10.236.15				
18,0			10.240.18	10.242.18	10.246.18	10.248.18
20,0		10.236.20	10.240.20			



DUVAL

10.250.14

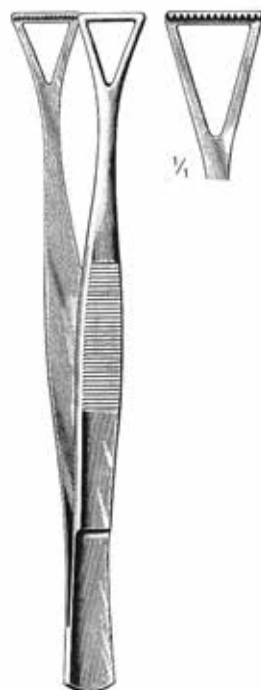

1/4

COLLIN-DUVAL

10.252.14



1/4

Russ. Mod.

10.256.15

10.256.20

10.256.25



1/4

McINDOE

10.258.15

cm  
14,5  
15,0  
20,0  
25,0



**Pinzetten**

Thumb and Tissue Forceps  
 Pincès à dissection  
 Pinzas de disección  
 Pinze per dissezione

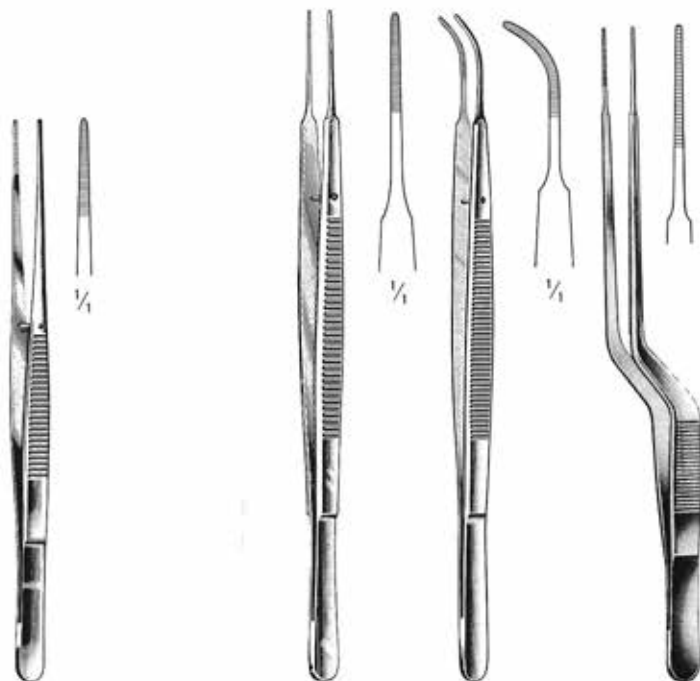

cm	SEMKEN	GERALD	GERALD	GERALD
12,5	10.260.12			
15,5	10.260.15			
18,0		10.302.18	10.303.18	10.305.18

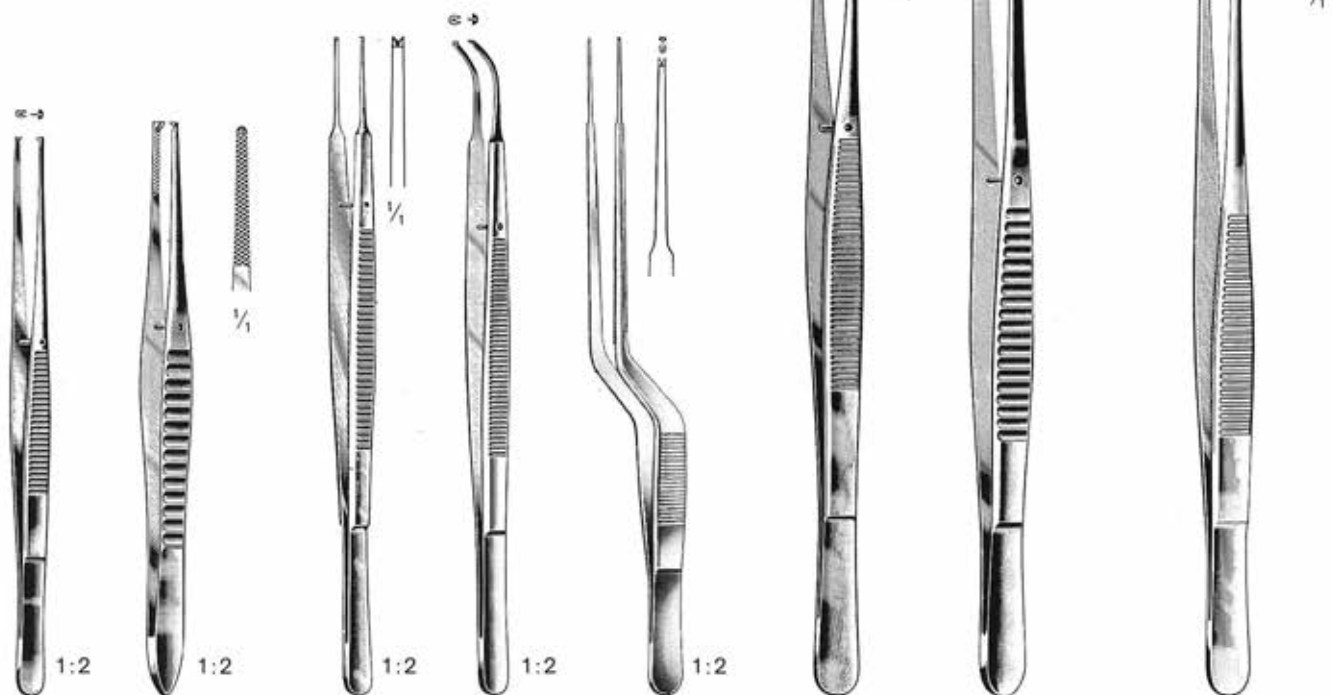

cm	SEMKEN	GILLIES	GERALD	GERALD	GERALD	SINGLEY	NELSON	WANGENSTEEN
12,5	10.270.12							
15,5	10.270.15	10.272.15						
18,0			10.310.18	10.311.18	10.313.18	10.320.18	10.322.18	
23,0			10.310.23			10.320.23	10.322.23	10.324.23

Pinzetten / Thumb and Tissue Forceps / Pincès à dissection / Pinzas de disección / Pinze per dissezione

## Splinterpinzetten, -zangen

Splinter Forceps  
Pincès à écharde  
Pinzas para espinas  
Pinze per schegge

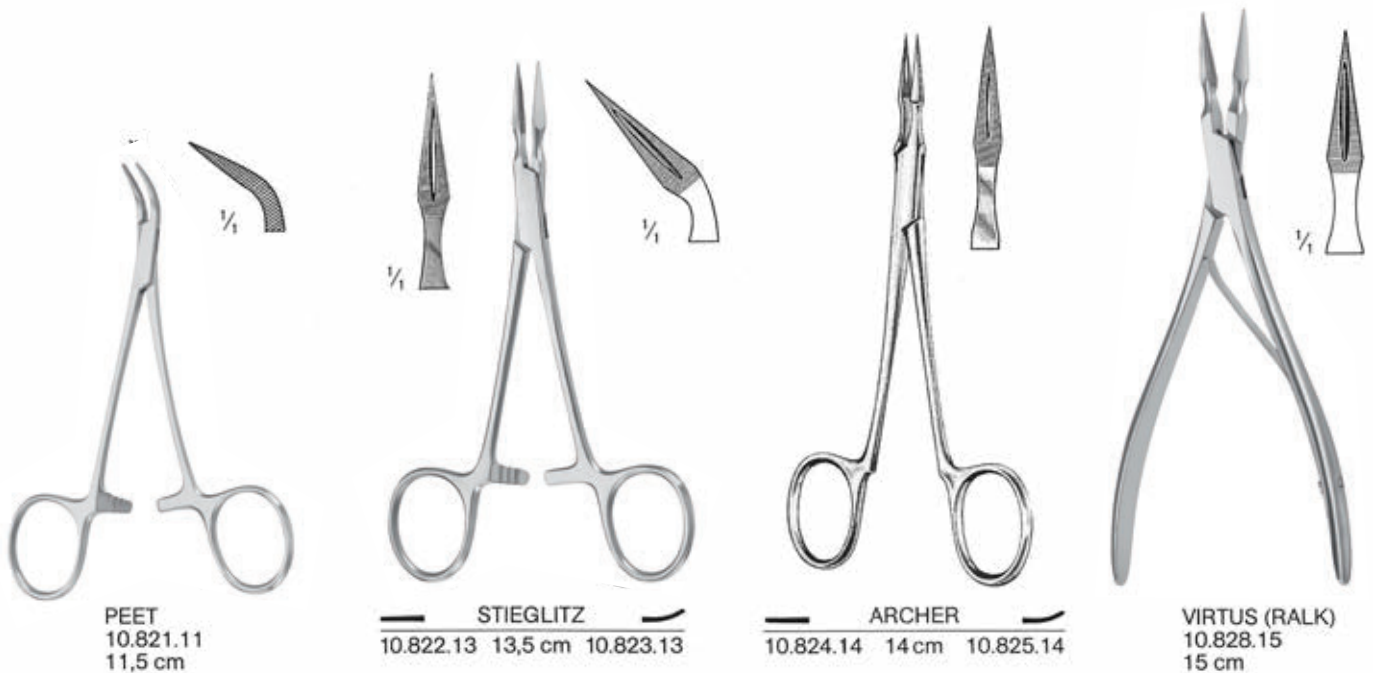
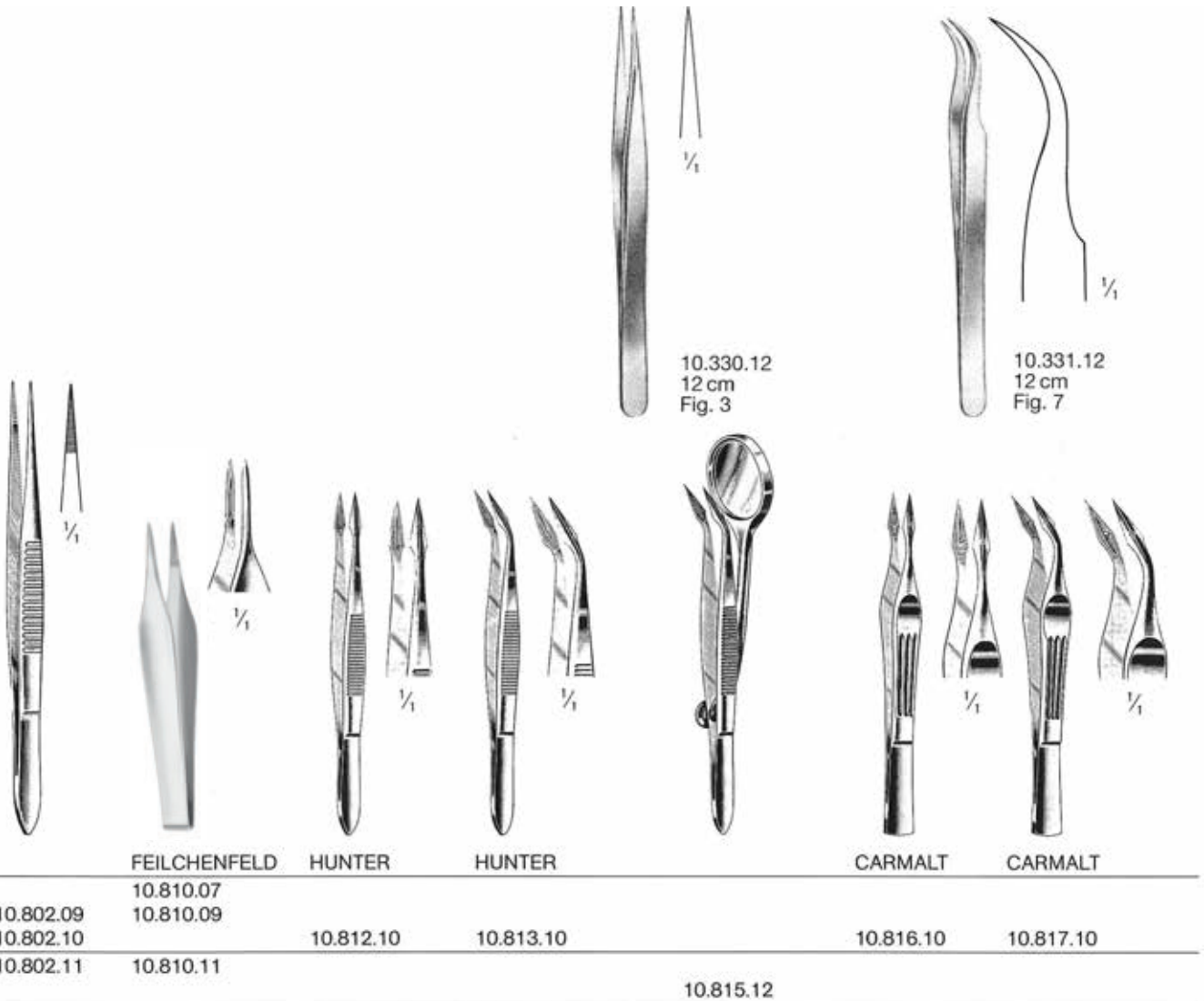

## Mikrochirurgie-Pinzetten

Microsurgery Forceps  
Pinces à microchirurgie  
Pinzas para microcirugía  
Pinze per microchirurgia

**dimeda**<sup>®</sup>  
SURGICAL INSTRUMENTS

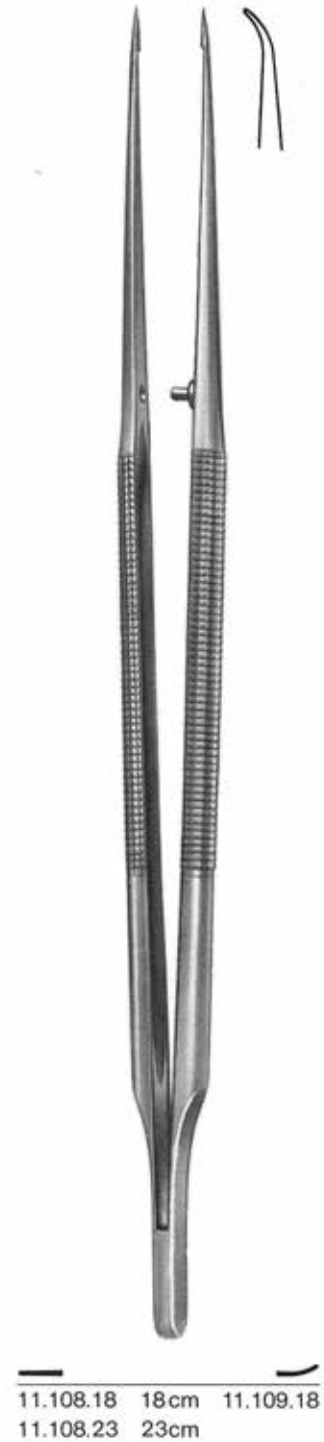
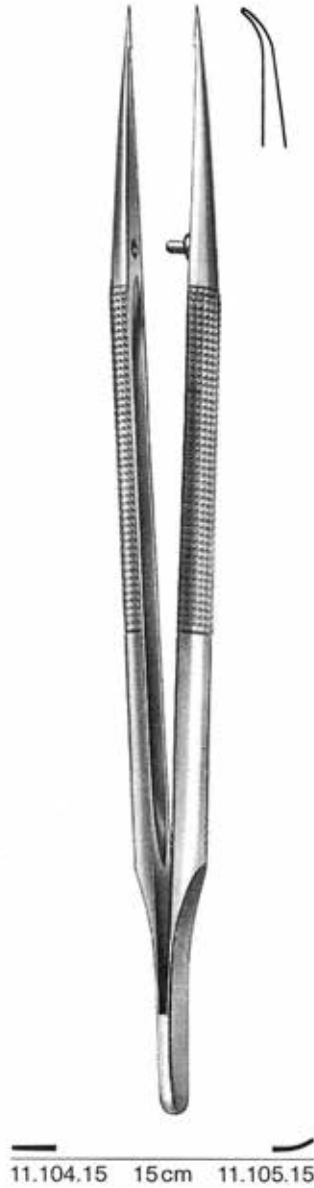

Pinzetten / Thumb and Tissue Forceps / Pinces à dissection / Pinzas de disección / Pinze per dissezione

## Mikrochirurgie-Pinzetten

Microsurgery Forceps  
 Pinces à microchirurgie  
 Pinzas para microcirugía  
 Pinze per microchirurgia



cm	DE BAKEY
16	11.304.16
20	11.304.20
24	11.304.24
30	11.304.30

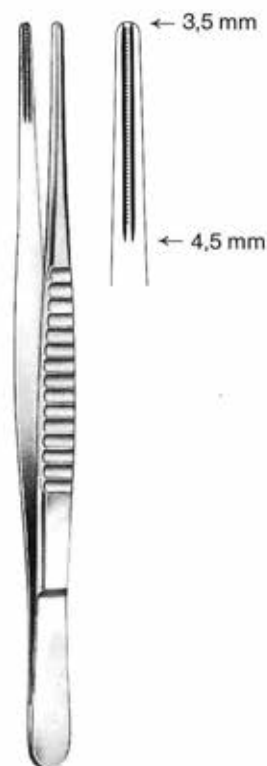
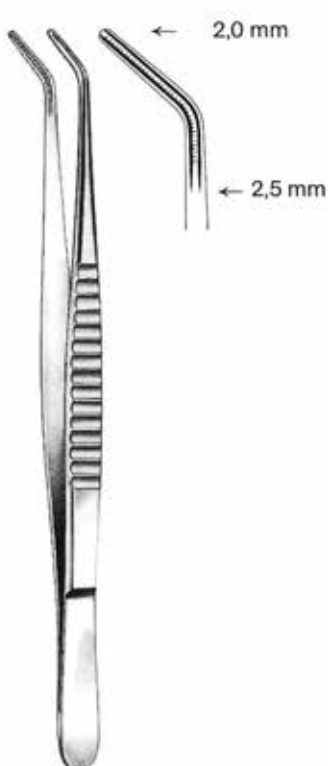
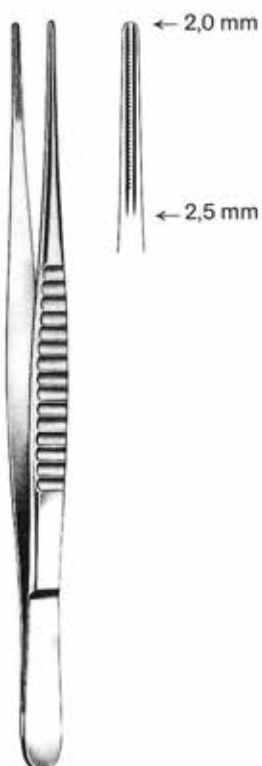

cm	DE BAKEY	DE BAKEY	DE BAKEY	COOLEY
16	11.308.16	11.309.16	11.310.16	11.314.16
20	11.308.20	11.309.20	11.310.20	11.314.20
24	11.308.24	11.309.24	11.310.24	11.314.24
30	11.308.30	11.309.30	11.310.30	

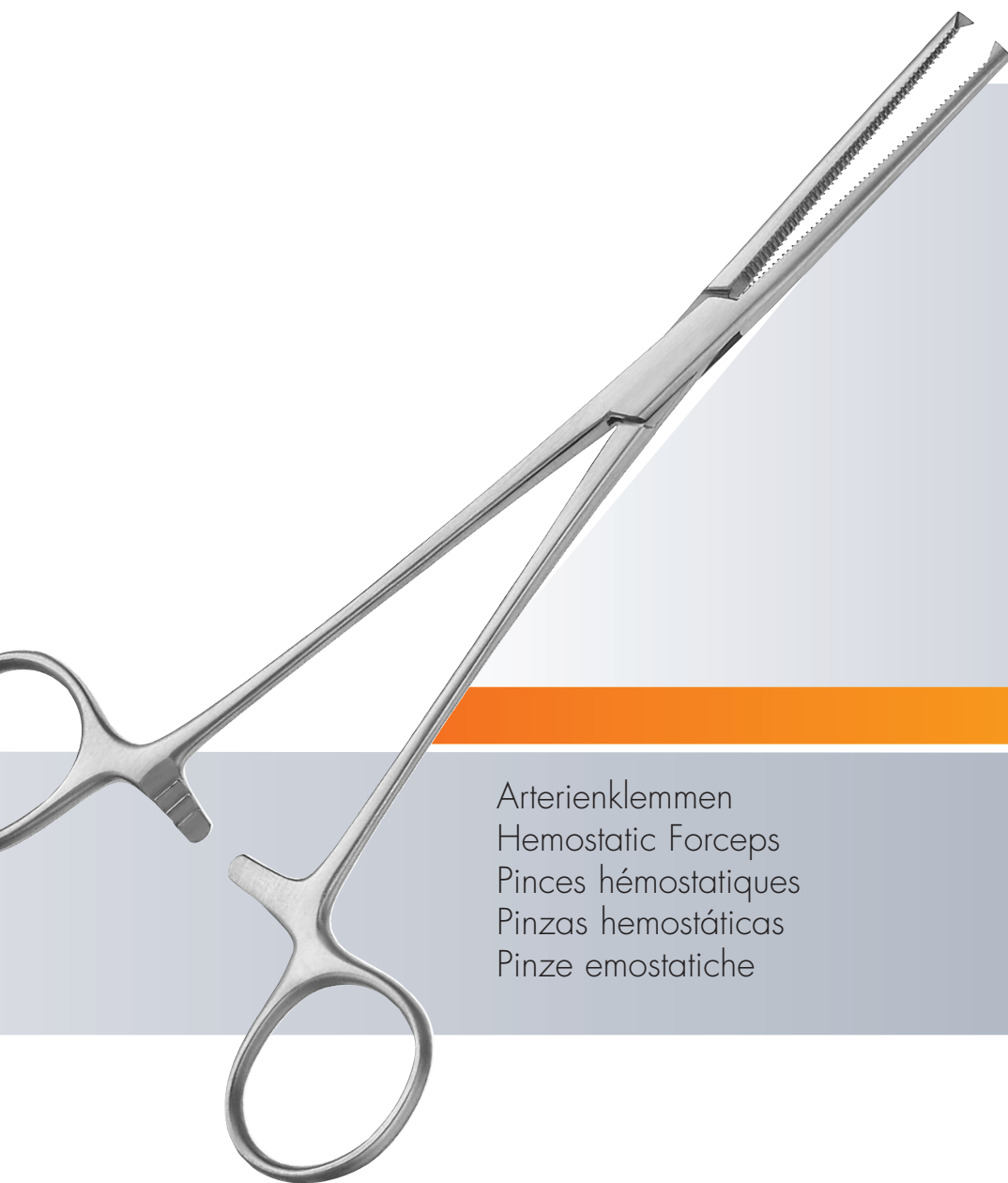

Arterienklemmen  
Hemostatic Forceps  
Pincas hémostatiques  
Pinzas hemostáticas  
Pinze emostatiche

## Atrauma-Bulldogklemmen

Atrauma Bulldog Clamps  
Clamps Bulldog Atrauma  
Clamps Atrauma Bulldog  
Pinze Atrauma Bulldog



DE BAKEY  
12.092.07-12.093.12

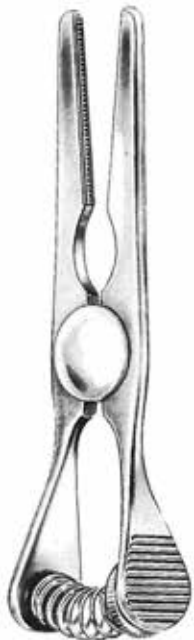
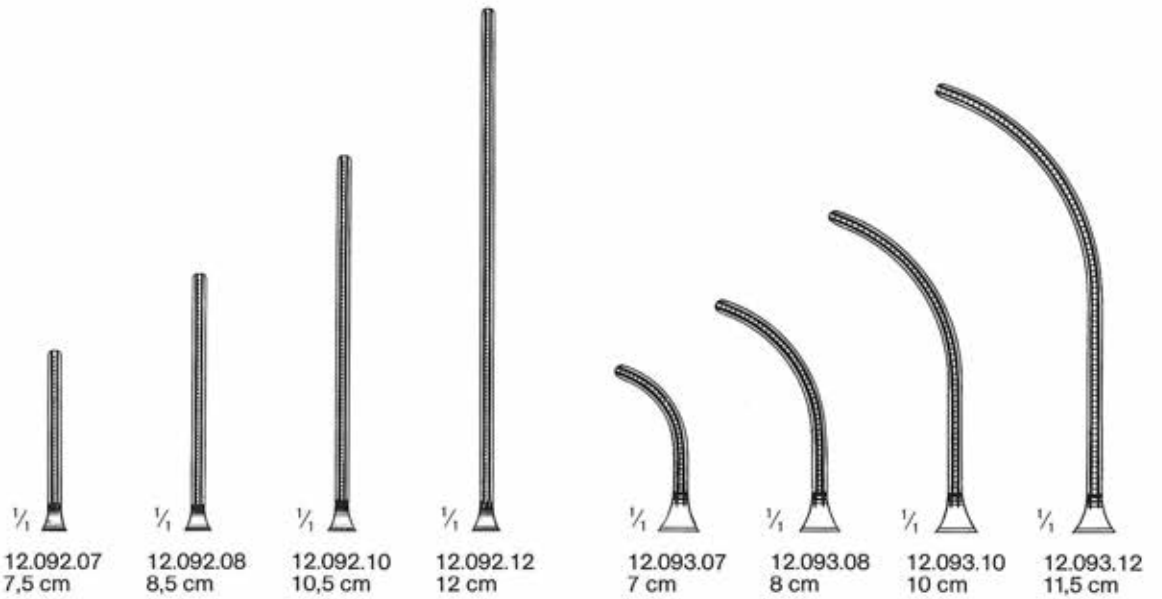

GLOVER  
12.096.06-12.097.11

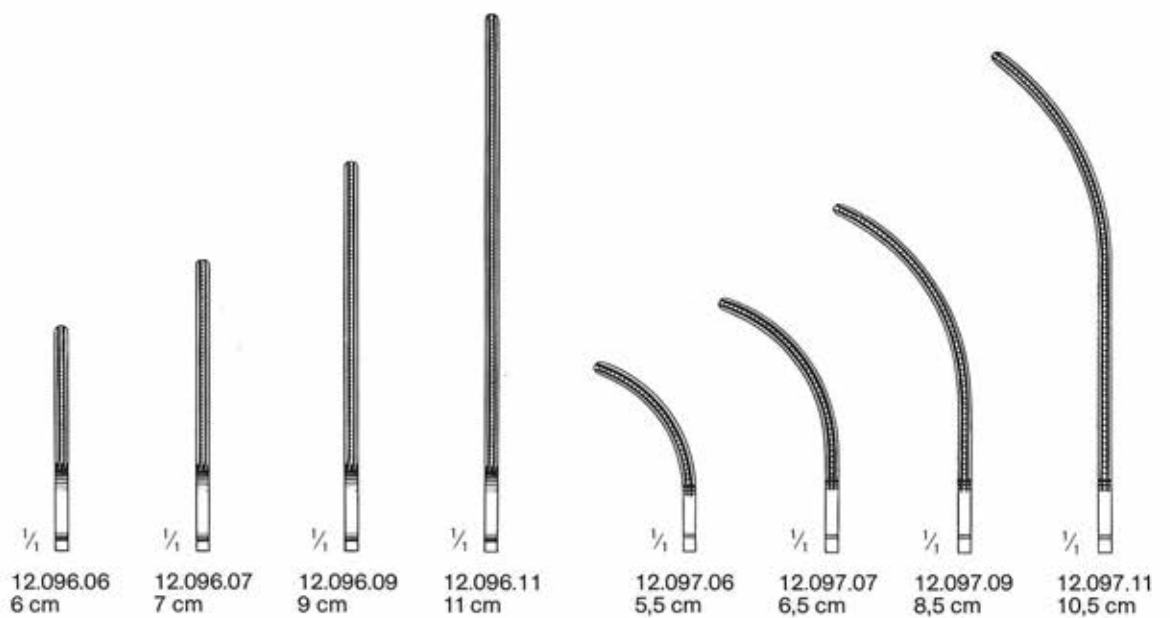



## Arterienklemmen

Hemostatic Forceps  
Pinces hémostatiques  
Pinzas hemostáticas  
Pinze emostatiche

Gefäßklemmen  
Serrefines  
Serre-fines  
Serra-finas  
Serrefine

cm	DIEFFENBACH		JOHNS-HOPKINS	
3,5	12.102.04	12.103.04	12.110.50	12.111.50
5,0	12.102.05	12.103.05	12.110.55	12.111.55
5,5			12.110.65	12.111.65
6,5			12.110.70	12.111.70
7,0			12.110.75	12.111.75
7,5			12.110.90	12.111.90
9,0				

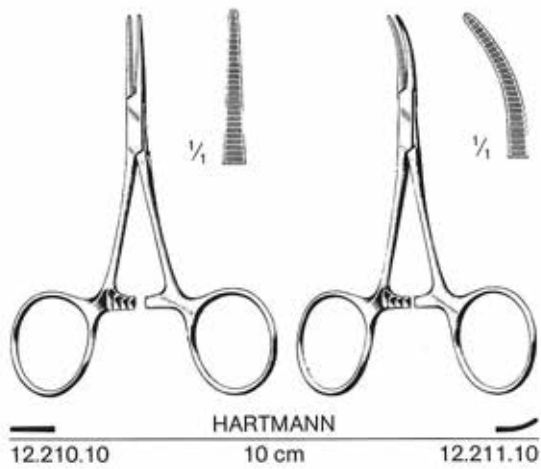

## Arterienklemmen

Hemostatic Forceps  
Pinces hémostatiques  
Pinzas hemostáticas  
Pinze emostatiche

Titan  
Titanium  
Titane  
Titanio

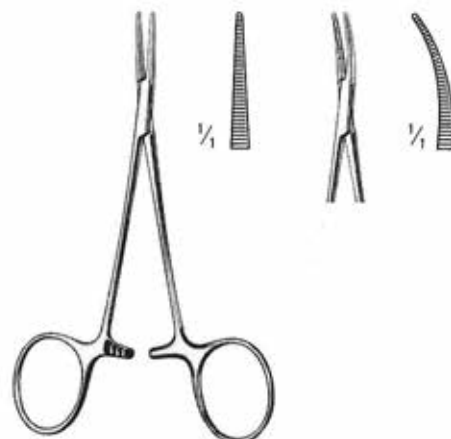
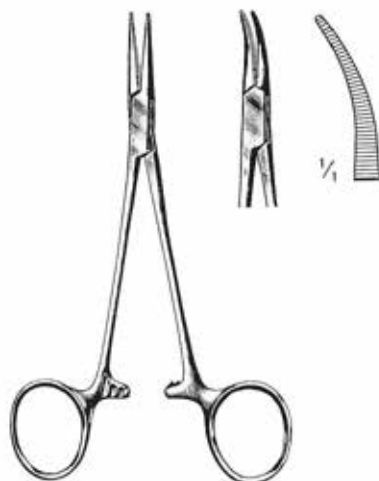

cm	— HALSTED-MOSQUITO —			— HALSTED-MOSQUITO micro —	
12,5	<u>12.224.12</u>	12.220.12	12.221.12	<u>12.225.12</u>	12.222.12
14,0		12.220.14	12.221.14		12.223.12
18,0		12.220.18	12.221.18		
21,0		12.220.21	12.221.21		

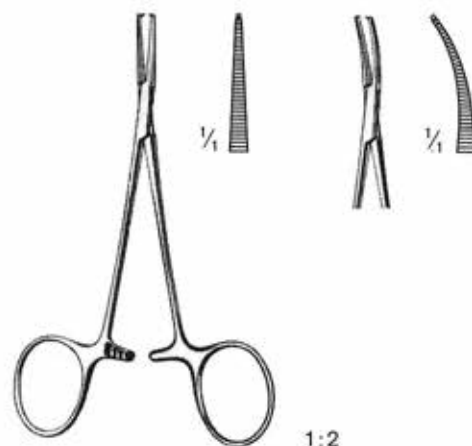

cm	— HALSTED-MOSQUITO —			— HALSTED-MOSQUITO micro —	
12,5	<u>12.234.12</u>	12.230.12	12.231.12	<u>12.235.12</u>	12.232.12
14,0		12.230.14	12.231.14		12.233.12
18,0		12.230.18	12.231.18		
21,0		12.230.21	12.231.21		



**Arterienklemmen**

Hemostatic Forceps  
 Pinces hémostatiques  
 Pinzas hemostáticas  
 Pinze emostatiche

Titan  
 Titanium  
 Titane  
 Titanio

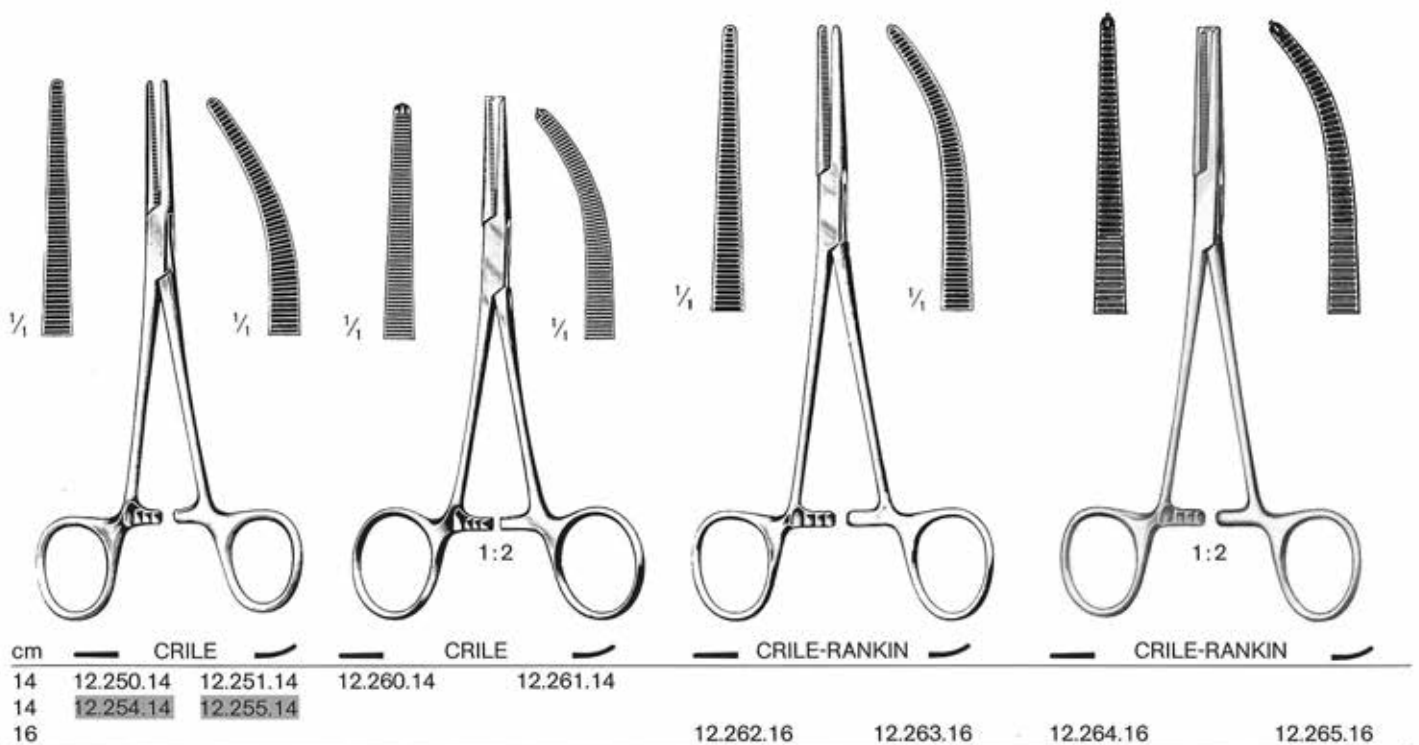
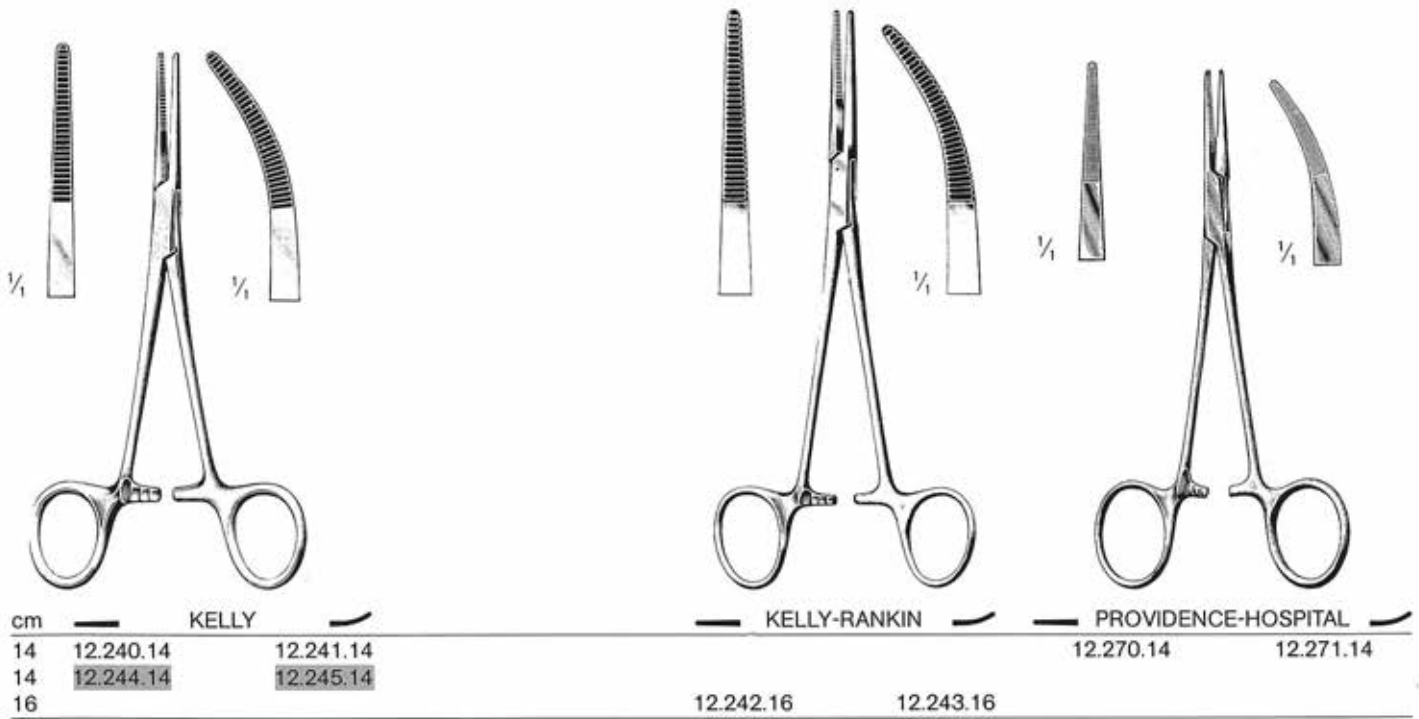

Arterienklemmen / Hemostatic Forceps / Pinces hémostatiques / Pinzas hemostáticas / Pinze emostatiche

## Arterienklemmen

Hemostatic Forceps  
 Pincas hémostatiques  
 Pinzas hemostáticas  
 Pinze emostatiche

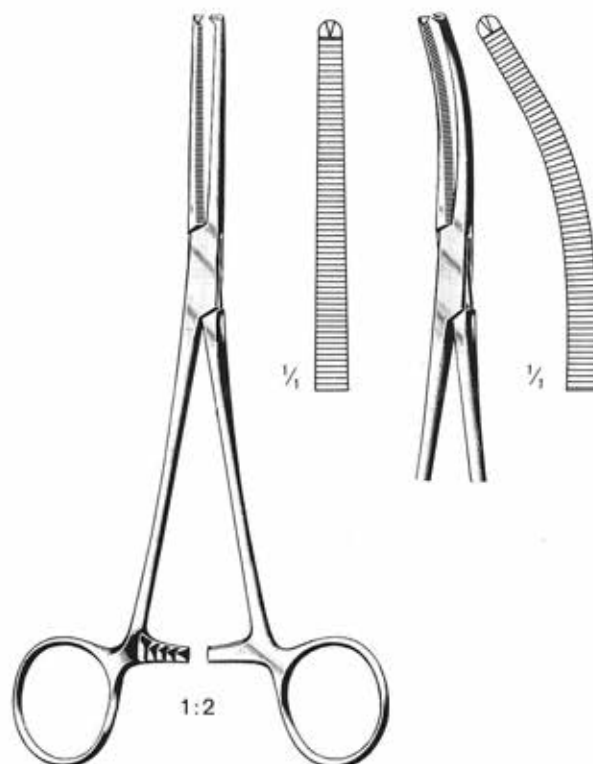
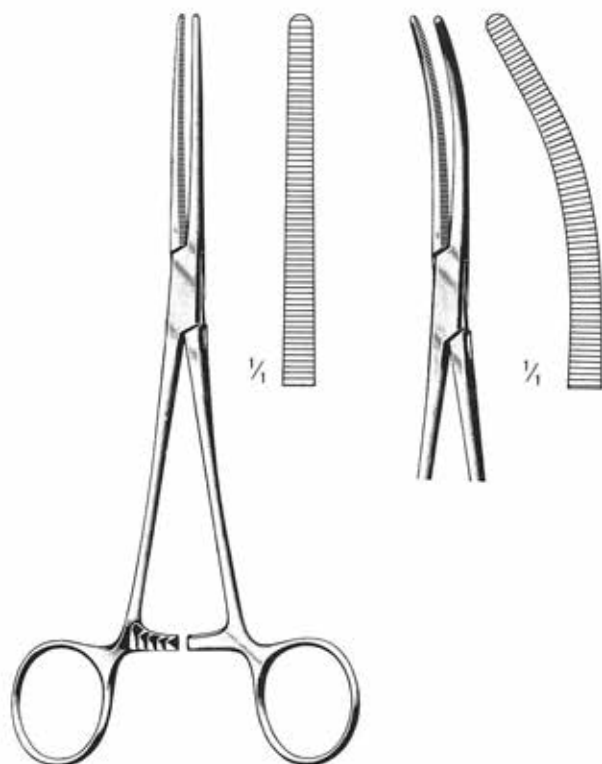

cm	ROCHESTER-PEAN	
13	12.310.13	12.311.13
14	12.310.14	12.311.14
16	12.310.16	12.311.16
18	12.310.18	12.311.18
20	12.310.20	12.311.20
22	12.310.22	12.311.22
24	12.310.24	12.311.24
26	12.310.26	12.311.26
30	12.310.30	12.311.30

cm	ROCHESTER-OCHSNER	
13	12.320.13	12.321.13
14	12.320.14	12.321.14
16	12.320.16	12.321.16
18	12.320.18	12.321.18
20	12.320.20	12.321.20
22	12.320.22	12.321.22
24	12.320.24	12.321.24
26	12.320.26	12.321.26
30	12.320.30	12.321.30

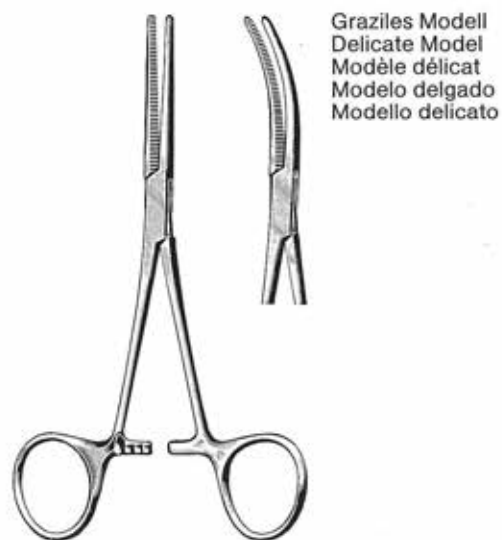

Graziles Modell  
 Delicate Model  
 Modèle délicat  
 Modelo delgado  
 Modello delicato

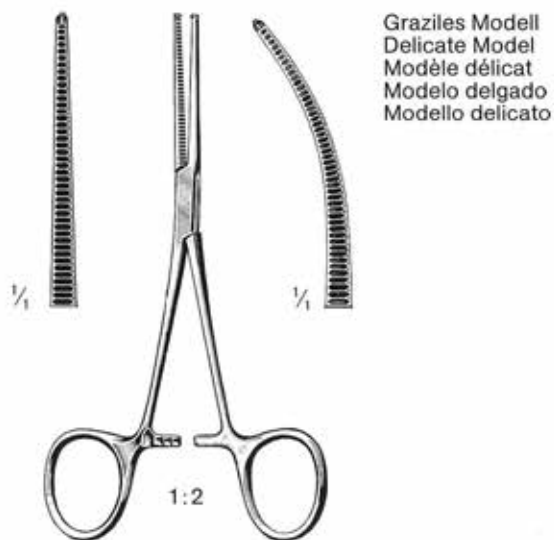

Graziles Modell  
 Delicate Model  
 Modèle délicat  
 Modelo delgado  
 Modello delicato

cm	PEAN	
12.312.14	14 cm	12.313.14
12.312.16	16 cm	12.313.16

cm	KOCHER	
12.322.14	14 cm	12.323.14
12.322.16	16 cm	12.323.16

## Arterienklemmen

Hemostatic Forceps  
Pinces hémostatiques  
Pinzas hemostáticas  
Pinze emostatiche

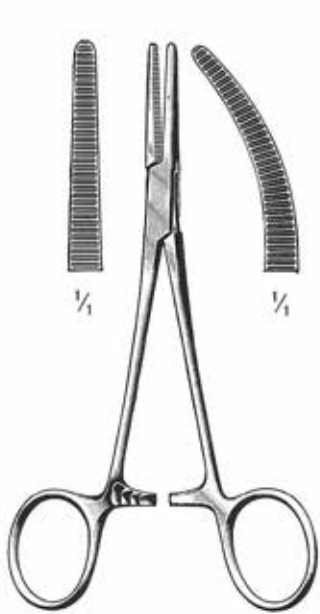

SPENCER-WELLS		
12.330.13	13 cm	12.331.13
12.330.15	15 cm	12.331.15
12.330.18	18 cm	12.331.18
12.330.20	20 cm	12.331.20

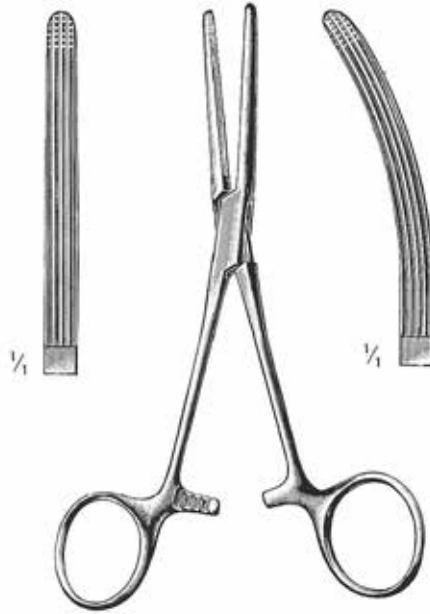

ROCHESTER-CARMALT		
12.340.16	16 cm	12.341.16
12.340.20	20 cm	12.341.20

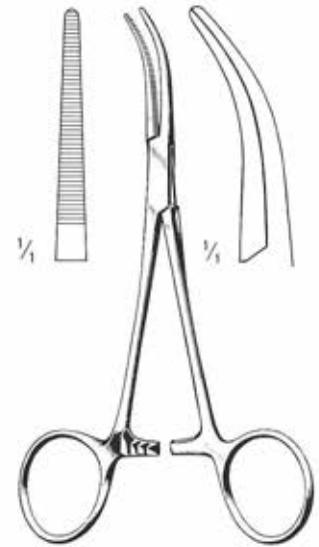

DANDY	
12.345.14	14 cm

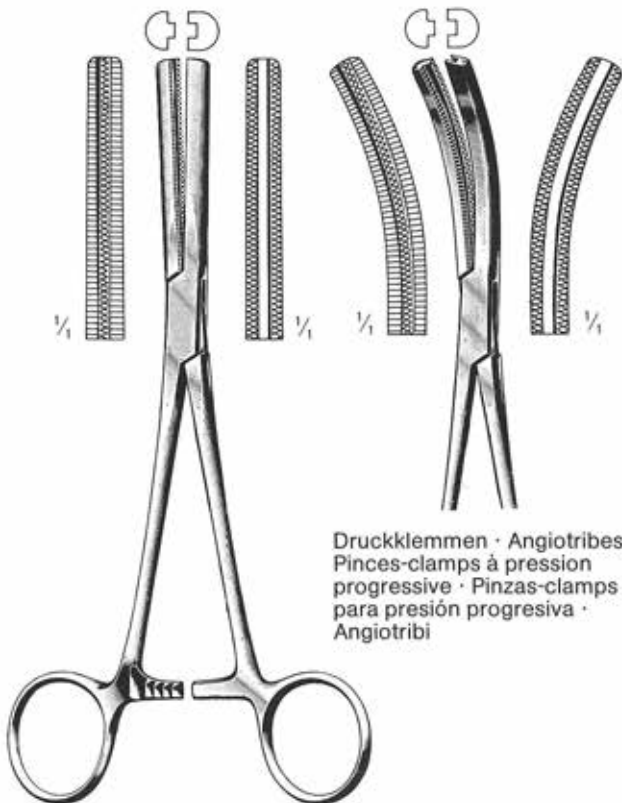

Druckklemmen · Angiotribes  
Pinces-clamps à pression  
progressive · Pinzas-clamps  
para presión progresiva ·  
Angiotribi

FERGUSSON		
12.350.16	16 cm	12.351.16
12.350.20	20 cm	12.351.20

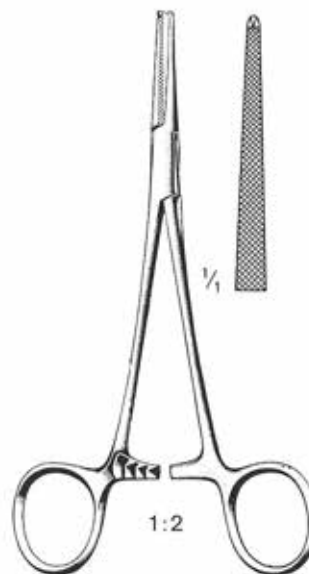

LOVELACE	
12.356.15	15,5 cm

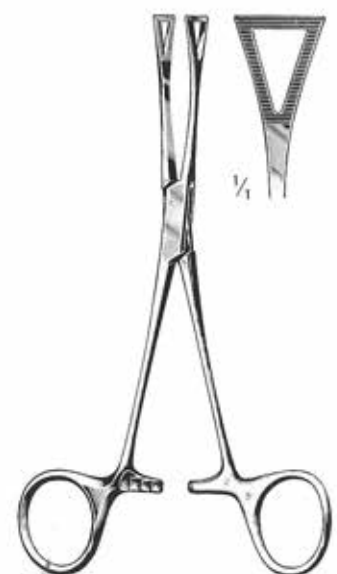

cm	PENNINGTON
15,5	12.358.15
20,0	12.358.20

## Arterienklemmen

Hemostatic Forceps  
Pinces hémostatiques  
Pinzas hemostáticas  
Pinze emostatiche

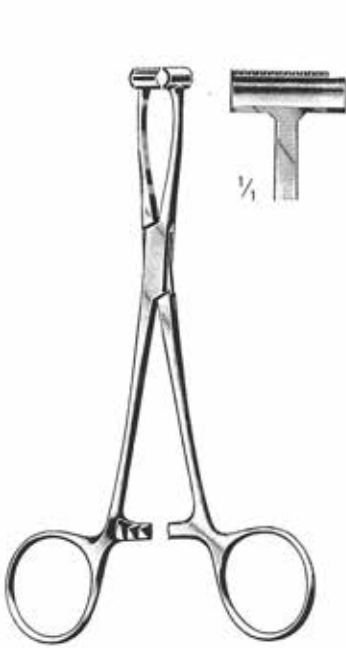

PRATT  
12.360.15  
15 cm



MARTEL  
12.364.14  
14 cm



WILLET-MARTEL  
12.366.19  
19 cm

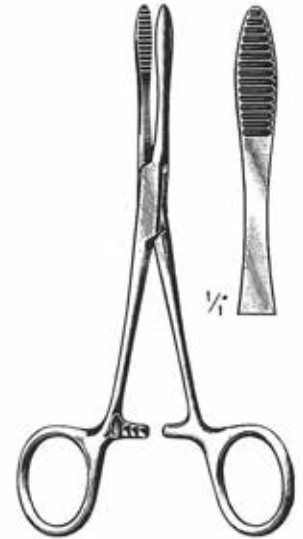

cm	PEAN
14	12.368.14
16	12.368.16

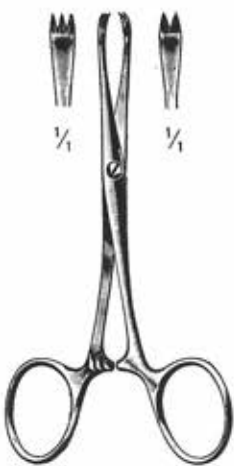

CHAPUT  
12.370.13  
13 cm

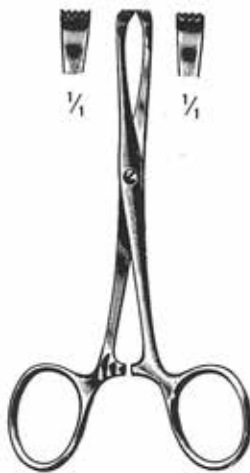

TUFFIER  
12.372.13  
13 cm

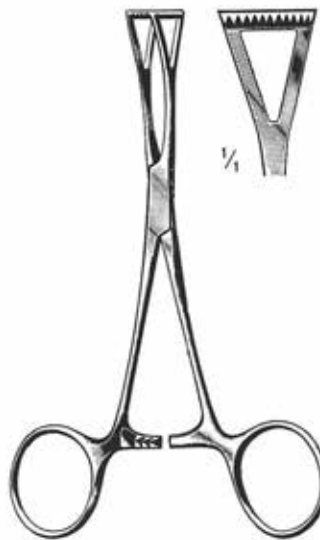

COLLIN  
12.374.14  
14 cm



COLLIN  
12.376.16  
16 cm



**Arterienklemmen**

Hemostatic Forceps  
 Pinces hémostatiques  
 Pinzas hemostáticas  
 Pinze emostatiche

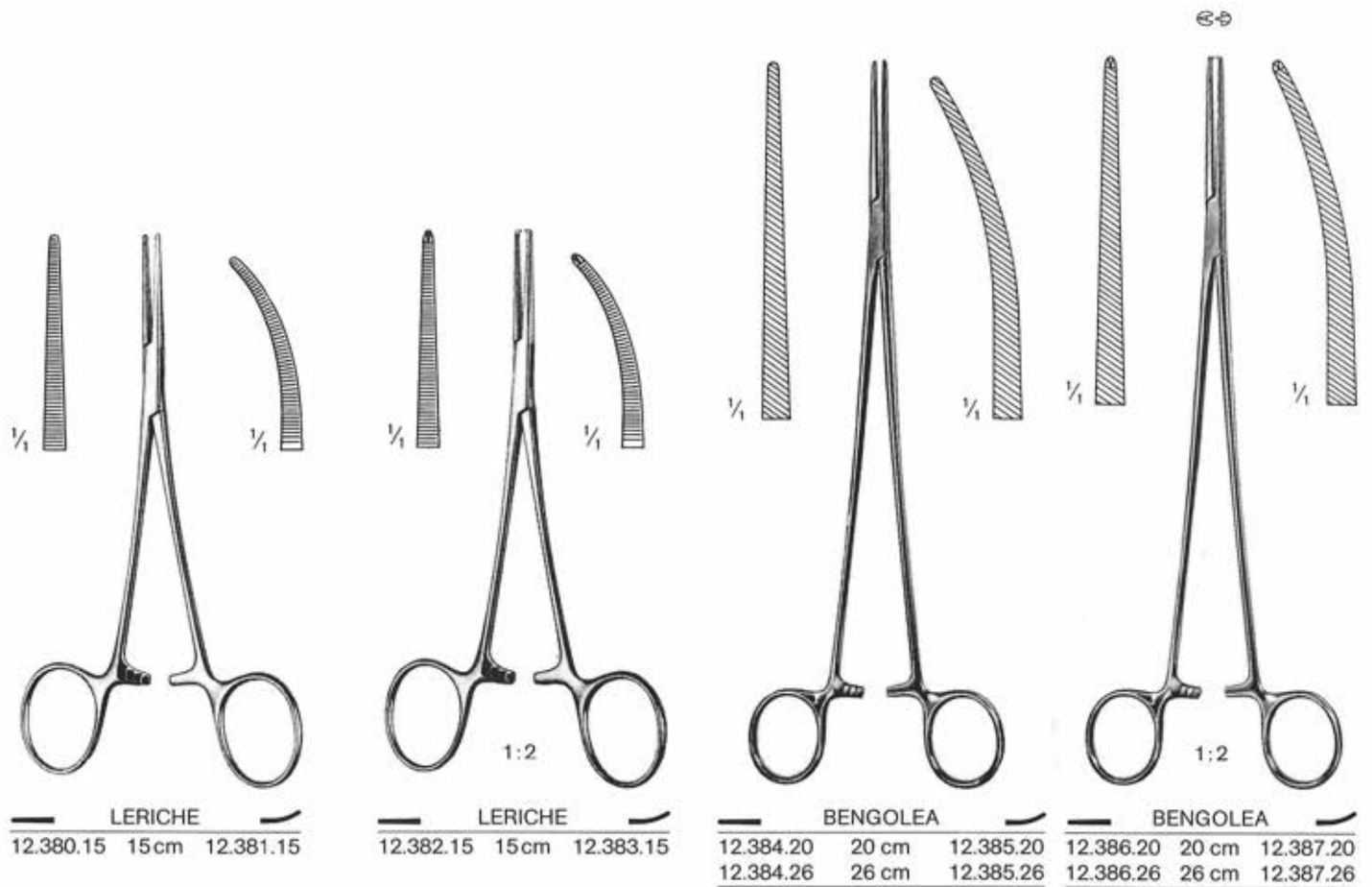

Arterienklemmen / Hemostatic Forceps / Pinces hémostatiques / Pinzas hemostáticas / Pinze emostatiche

## Arterienklemmen

Hemostatic Forceps  
Pincès hémostatiques  
Pinzas hemostáticas  
Pinze emostatiche



OVERHOLT-GEISSENDOERFER  
12.421.01 - 12.427.07

Präparier- und Ligaturklemmen  
Dissecting and Ligature Forceps  
Pincès à dissection et à ligatures  
Pinzas para disección y ligaduras  
Pinze per dissezione e per legature (Passafili)

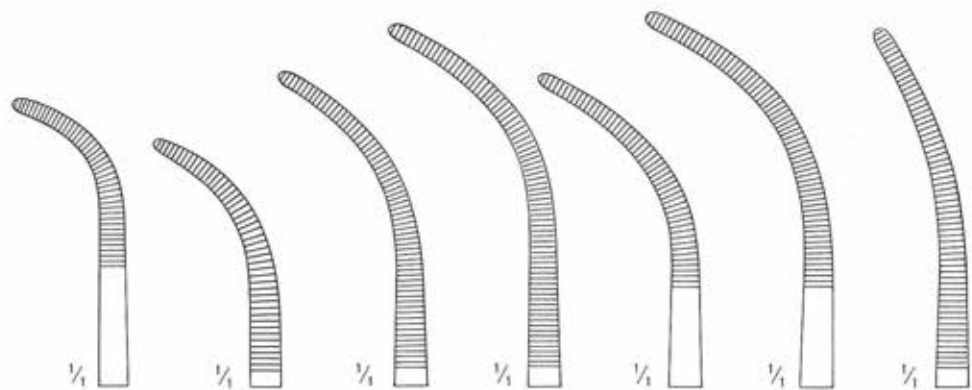

cm	Fig. 1	Fig. 2	Fig. 3	Fig. 4	Fig. 5	Fig. 6	Fig. 7
21	12.421.01	12.421.02	12.421.03	12.421.04	12.421.05	12.421.06	12.421.07
27	12.427.01	12.427.02	12.427.03	12.427.04	12.427.05	12.427.06	12.427.07



GEMINI  
GEMINI mini

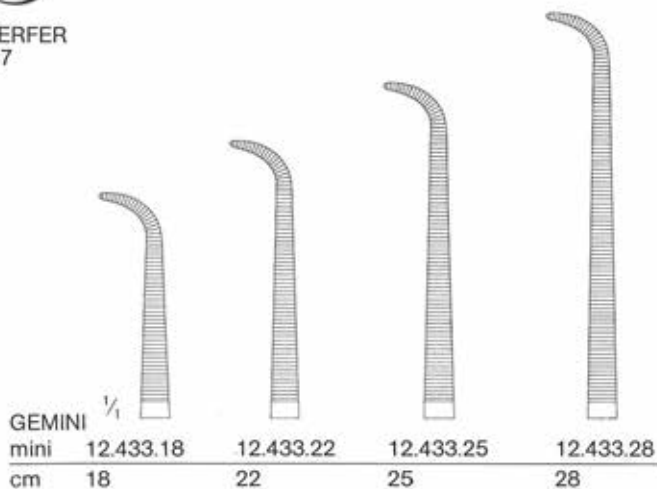

GEMINI mini	GEMINI
12.433.18	12.433.22
18 cm	22 cm
	12.433.25
	25 cm
	12.433.28
	28 cm

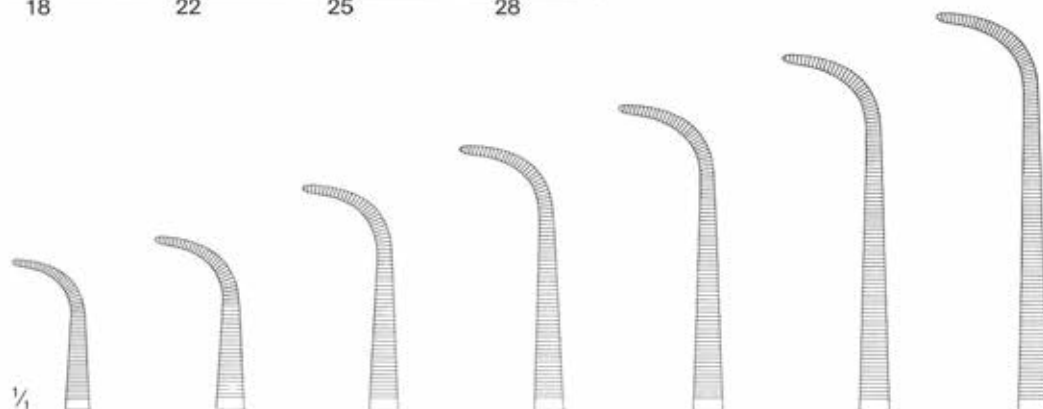

GEMINI	GEMINI mini
12.431.13	12.431.16
13 cm	16 cm
12.431.18	12.431.20
18 cm	20 cm
12.431.23	12.431.25
23 cm	25 cm
12.431.28	
28 cm	

**Arterienklemmen**

Hemostatic Forceps  
 Pinces hémostatiques  
 Pinzas hemostáticas  
 Pinze emostatiche

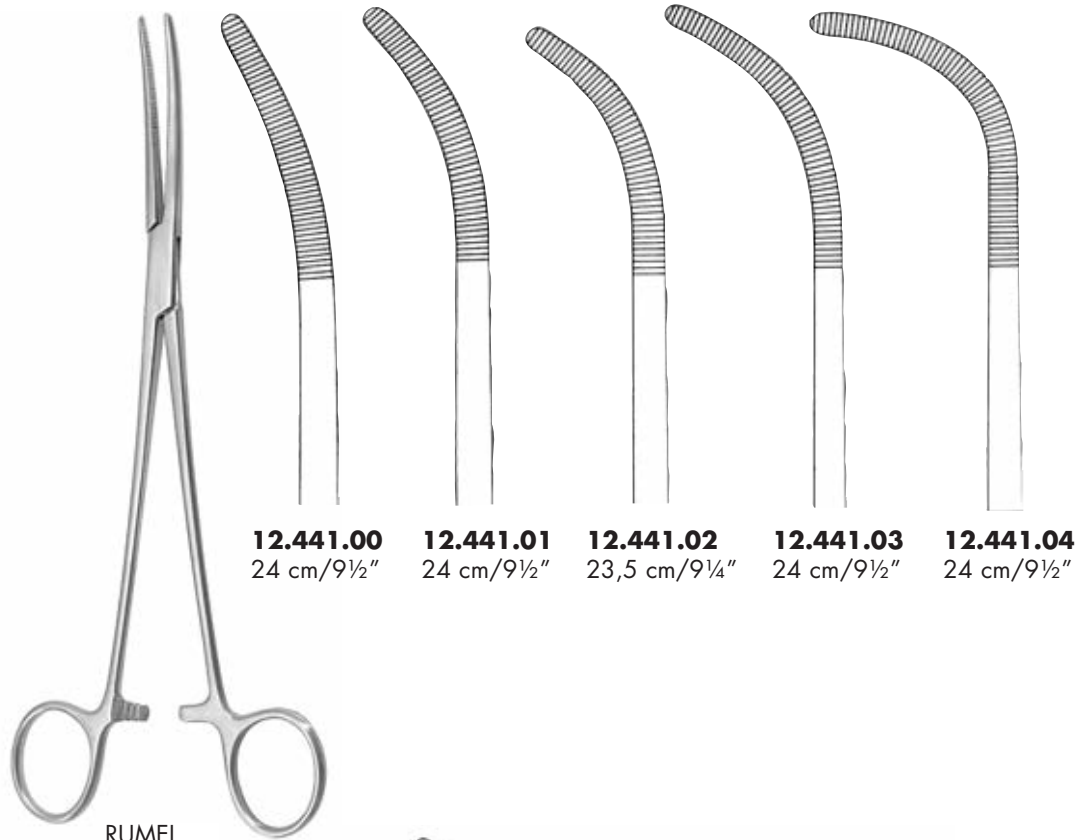

**12.441.00** 24 cm/9½"  
**12.441.01** 24 cm/9½"  
**12.441.02** 23,5 cm/9¼"  
**12.441.03** 24 cm/9½"  
**12.441.04** 24 cm/9½"

RUMEL



1/4 21 cm  
 12.442.21  
 12.442.26 26 cm



1/4 21 cm  
 12.443.21  
 26 cm 12.443.26



1/4 1:2 21 cm  
 12.444.21  
 12.444.26 26 cm



1/4 1:2 21 cm  
 12.445.21  
 26 cm 12.445.26



TOENNIS  
 12.442.21 - 12.445.26  
 21 cm 26 cm

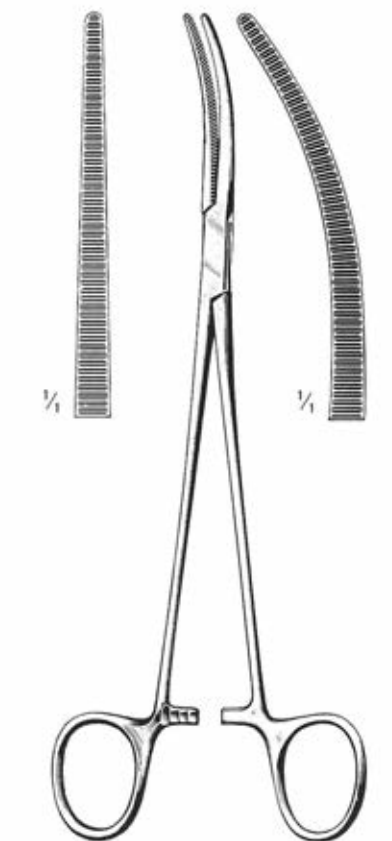

ROBERTS  
 12.448.22 22 cm 12.449.22

Arterienklemmen / Hemostatic Forceps / Pinces hémostatiques / Pinzas hemostáticas / Pinze emostatiche

## Arterienklemmen

Hemostatic Forceps  
Pinces hémostatiques  
Pinzas hemostáticas  
Pinze emostatiche

Bronchusklemmen  
Bronchus Forceps  
Pinces-Clamps à Bronches  
Pinzas clamps bronquiales  
Pinze per bronchi

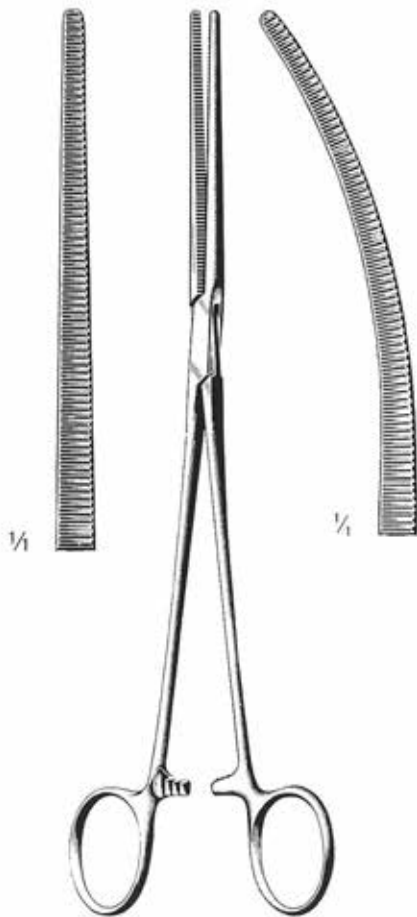

SAROT  
12.450.24 24 cm 12.451.24

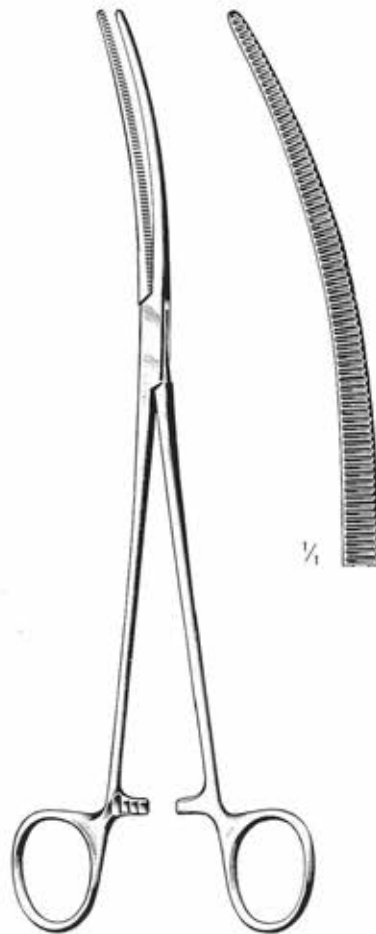

CRAFOORD  
12.453.24  
24 cm

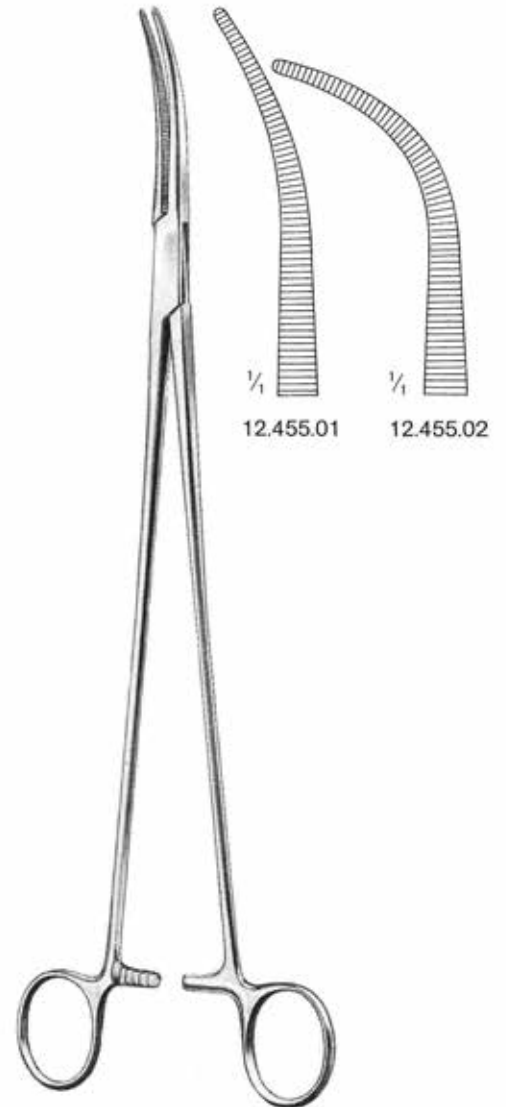

ZENKER  
12.455.01 - 12.455.02  
29,5 cm



**Arterienklemmen**

Hemostatic Forceps  
 Pincès hémostatiques  
 Pinzas hemostáticas  
 Pinze emostatiche

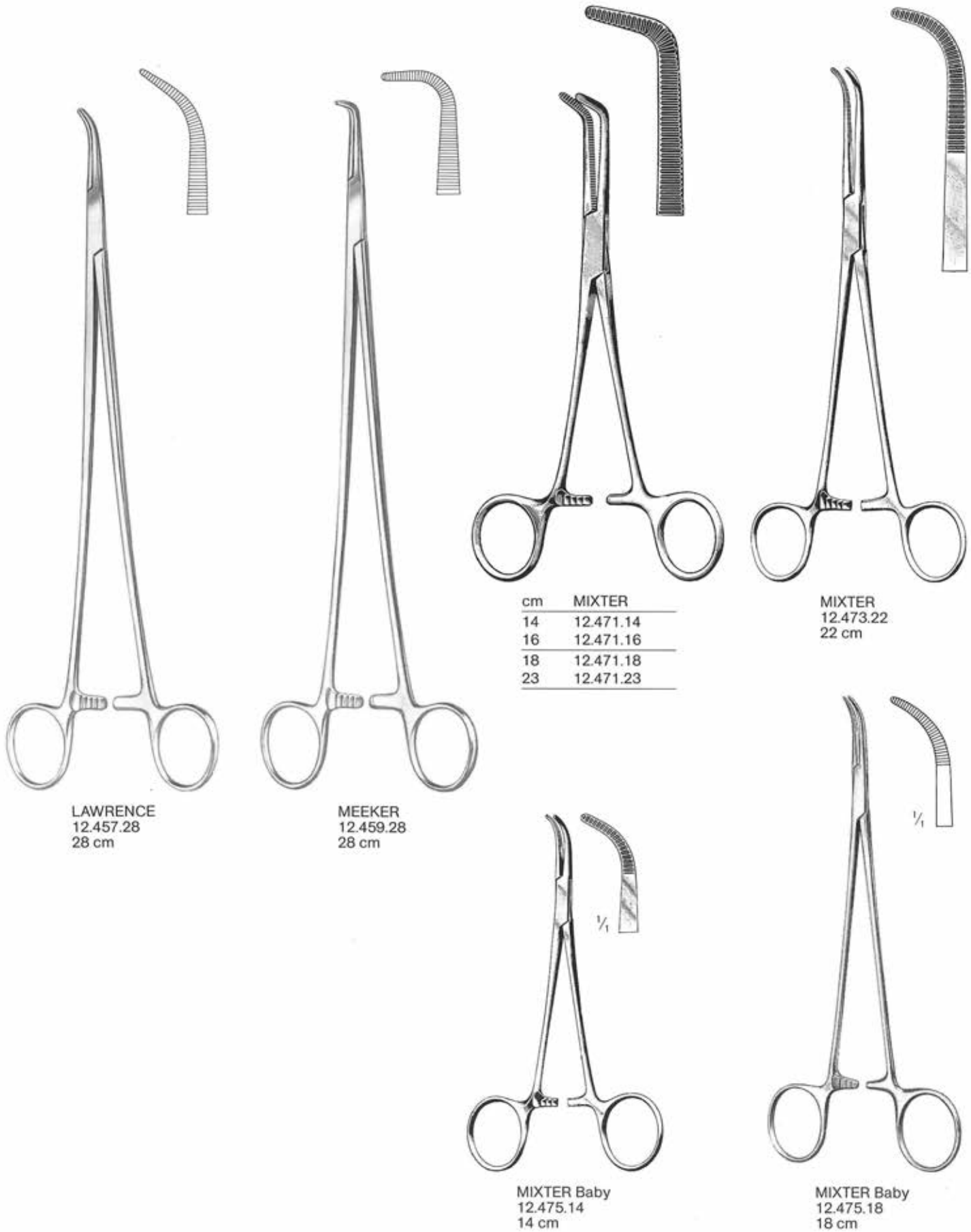

Arterienklemmen / Hemostatic Forceps / Pincès hémostatiques / Pinzas hemostáticas / Pinze emostatiche

## Arterienklemmen

Hemostatic Forceps  
Pinces hémostatiques  
Pinzas hemostáticas  
Pinze emostatiche

Arterien, Gallenkanal, Nierenstiel  
Hemostatic, Gall Duct, and Kidney Pedicle  
Hémostatiques, pédicule rénal et voies biliaires  
Hemostáticas, pedículo renal y vías biliares  
Emostatiche, pedunculo renale e vie biliari

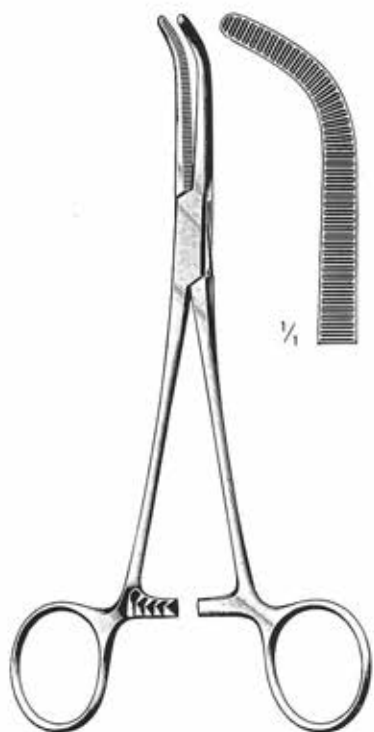

cm	MIXTER-O'SHAUGHNESSY
15,5	12.477.15
19,0	12.477.19



MIXTER  
12.479.22 - 12.479.28

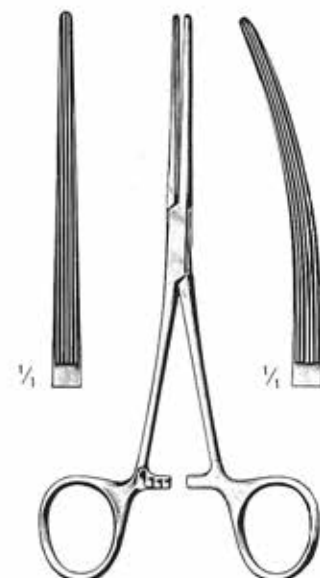

BAINBRIDGE  
12.480.15 15,0 cm 12.481.15  
12.480.18 18,5 cm 12.481.18

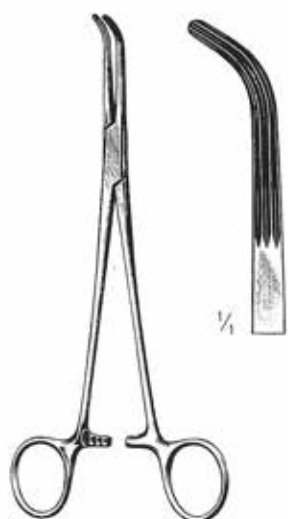

LAHEY  
12.491.19  
19 cm

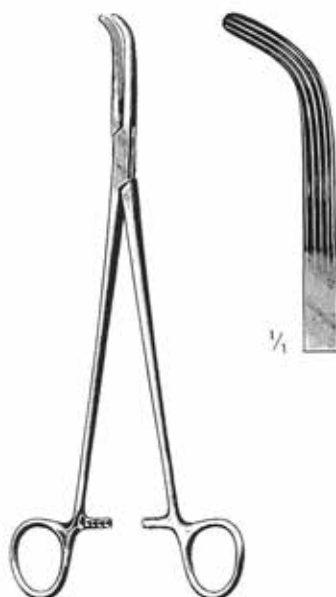

LAHEY  
12.493.23  
23 cm



LOWER  
12.495.18  
18 cm

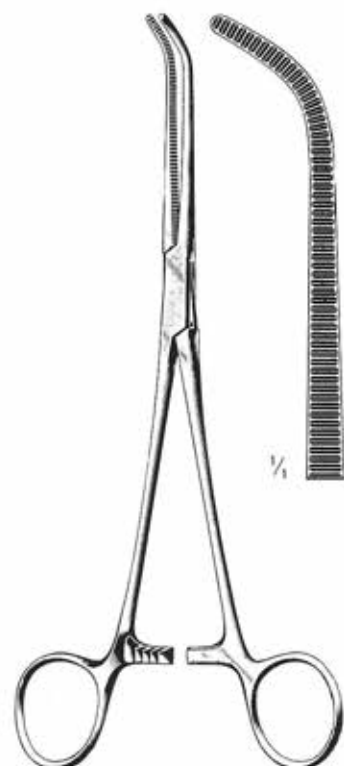

JOHNS-HOPKINS  
12.497.20  
20 cm

**Arterienklemmen**

Hemostatic Forceps  
 Pinces hémostatiques  
 Pinzas hemostáticas  
 Pinze emostatiche

Gallenkanal · Gall Duct ·  
 Voies biliaires · Vias  
 biliaries · Vie biliari

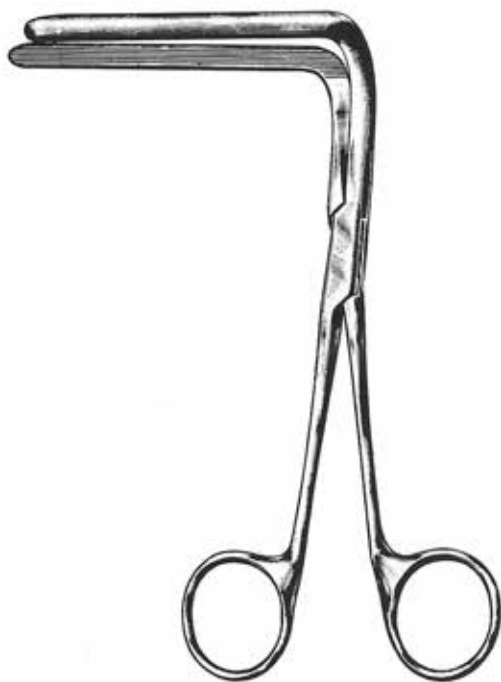

MIXTER  
 12.499.16  
 16,5 cm



MOYNIHAN  
 12.501.23  
 23 cm

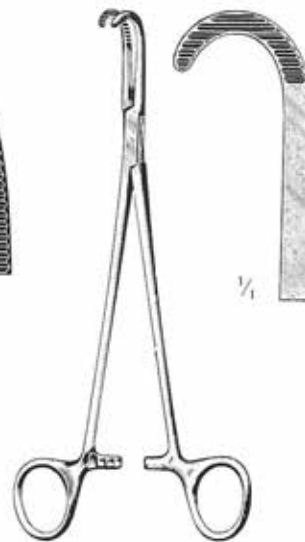

DESJARDINS  
 12.503.21  
 21 cm  
 (Cysticus)

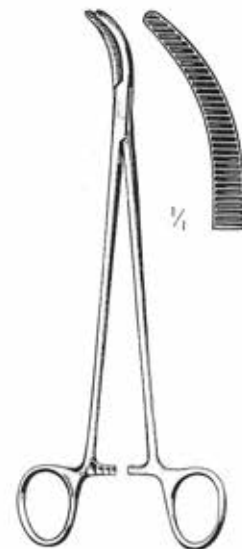

DESJARDINS  
 12.505.21  
 21 cm



GRAY  
 Cholecystectomie      12.507.22      12.507.23  
    22 cm              23 cm

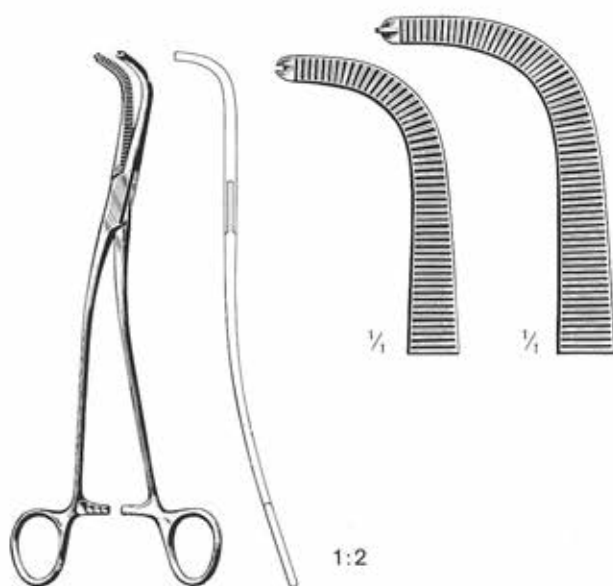

GRAY  
    1:2              12.509.22      12.509.23  
                         22 cm              23 cm

Arterienklemmen / Hemostatic Forceps / Pinces hémostatiques / Pinzas hemostáticas / Pinze emostatiche

## Arterienklemmen

Hemostatic Forceps  
 Pinces hémostatiques  
 Pinzas hemostáticas  
 Pinze emostatiche

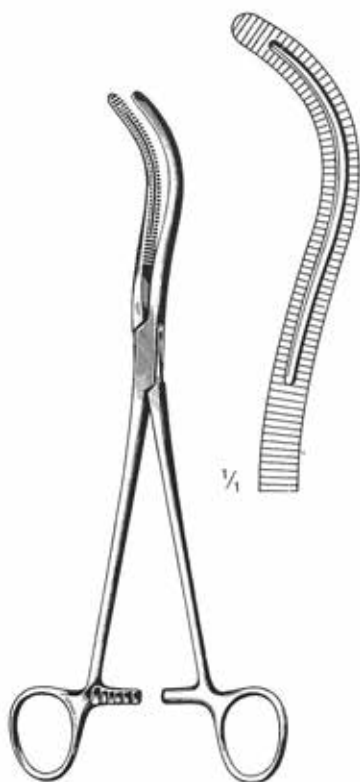

STILLE  
 12.513.23  
 23 cm

Nierenstiel, Gallenkanal  
 Kidney Pedicle, Gall Duct  
 Pédicule rénal, conduit biliaire  
 Pediculo renal, vias biliares  
 Pedunculo renale, vie biliari

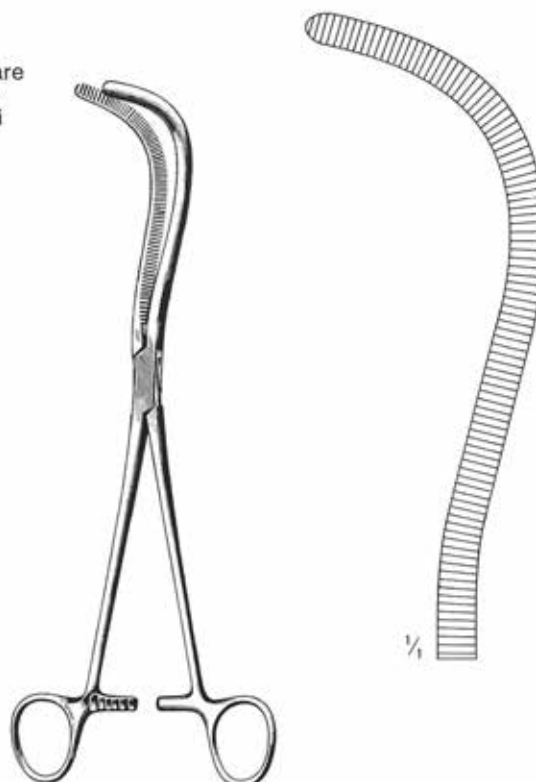

MAYO-GUYON  
 12.515.23  
 23 cm

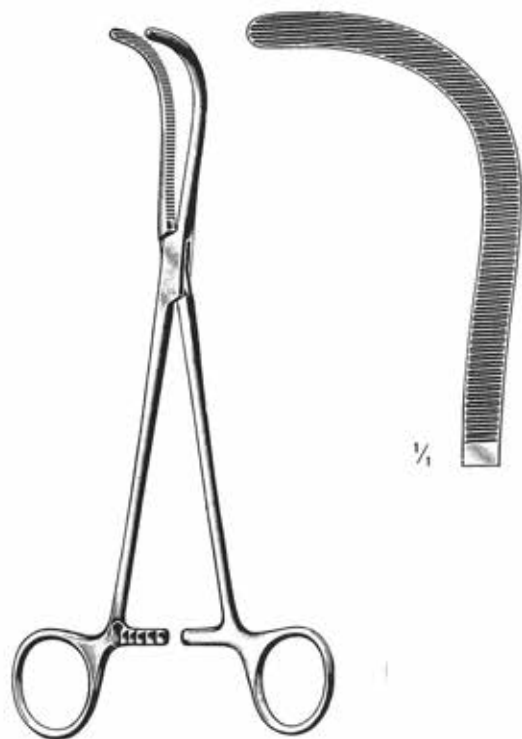

GUYON  
 12.517.23  
 23 cm



GUYON

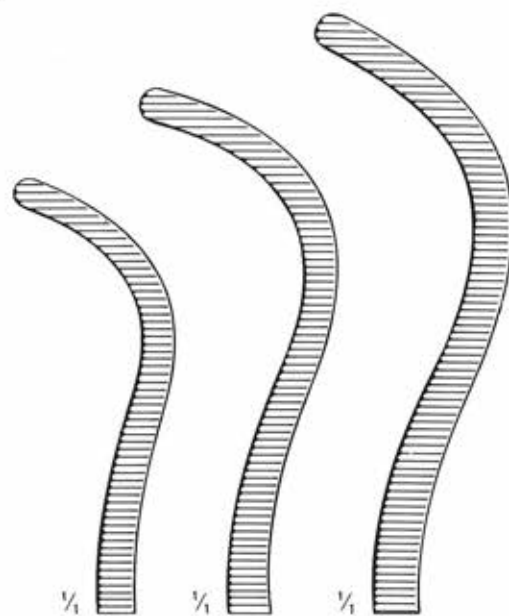

12.519.20  
 20 cm

12.519.22  
 22 cm

12.519.24  
 24 cm

**Arterienklemmen**

Hemostatic Forceps  
 Pincas hémostatiques  
 Pinzas hemostáticas  
 Pinze emostatiche

Nierenstiel  
 Kidney Pedicle  
 Pédicule rénal  
 Pediculo renal  
 Pedunculo renale

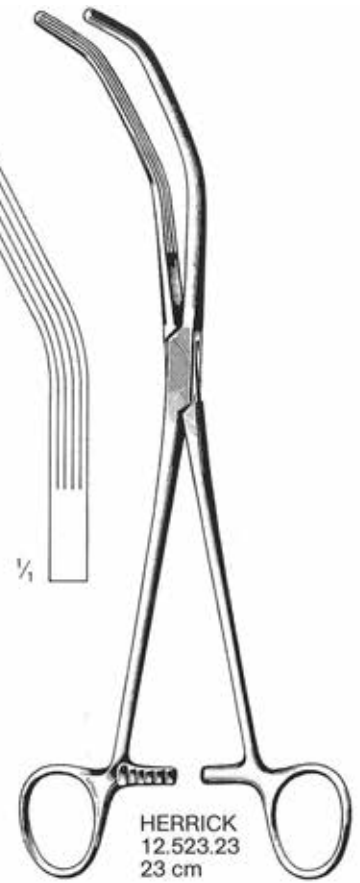

Peritoneum-Klemmen  
 Peritoneum Forceps  
 Pincas à péritoine  
 Pinzas para peritoneo  
 Pinze peritoneali

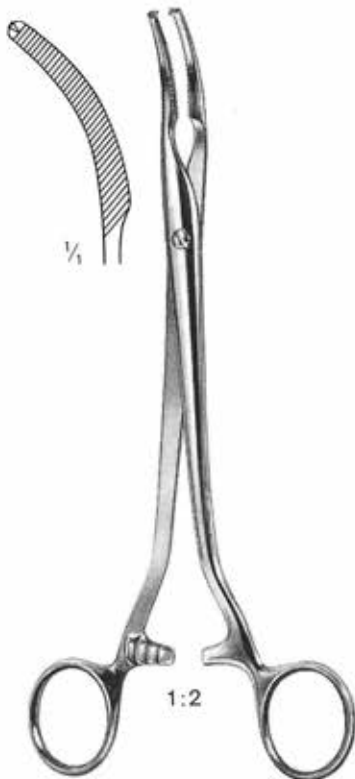

MIKULICZ  
 12.551.20  
 20 cm

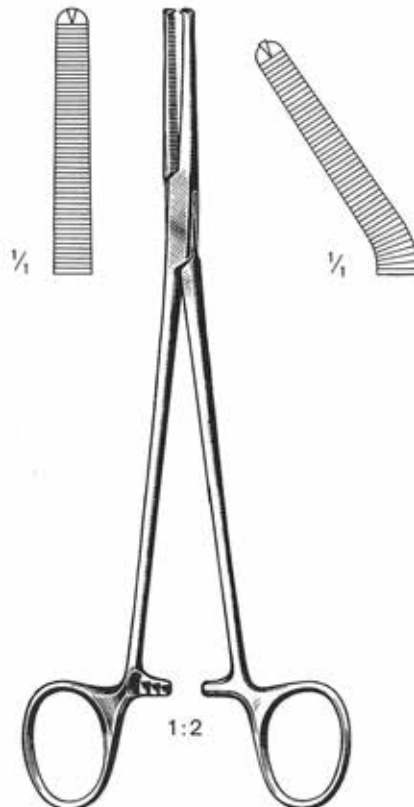

PHANEUF  
 12.554.21 21 cm 12.555.21

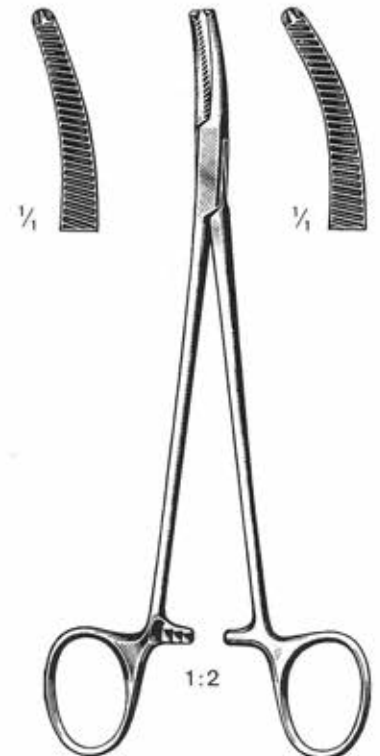

FAURE  
 12.561.20 20 cm 12.563.20

Arterienklemmen / Hemostatic Forceps / Pincas hémostatiques / Pinzas hemostáticas / Pinze emostatiche



## Hysterektomie-Klemmen

Hysterectomy Forceps

Pinces à hysterectomie

Pinzas para hysterectomía

Pinze per isterectomia

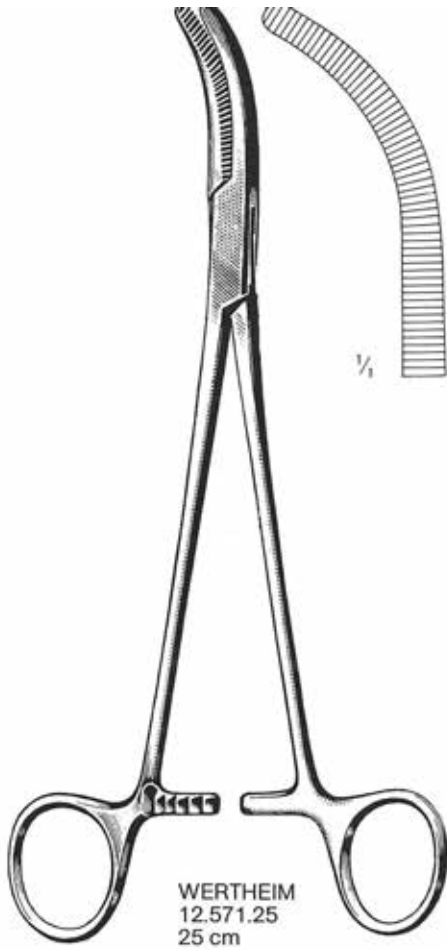

WERTHEIM  
12.571.25  
25 cm

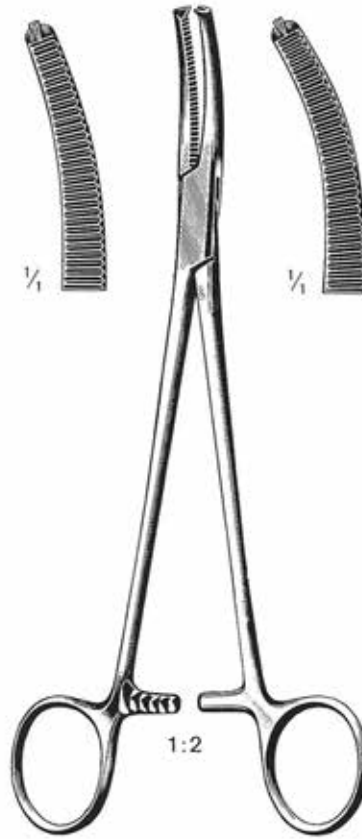

WERTHEIM  
12.573.22 22 cm  
12.575.23 23 cm

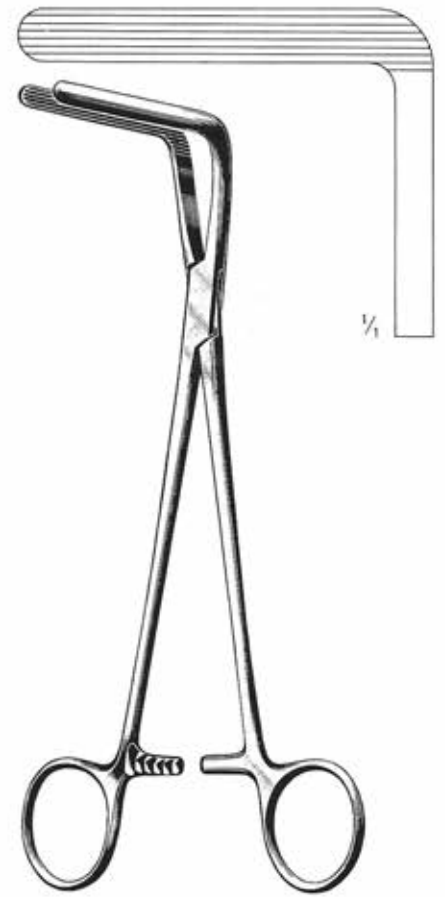

WERTHEIM-CULLEN  
12.579.21  
21,5 cm



HEANEY  
21,5 cm 12.591.20 12.593.20

**Schlauchklemmen**

Tubing Clamps  
 Pinces serre-tubes  
 Pinzas cierra-tubos  
 Pinze serretubi

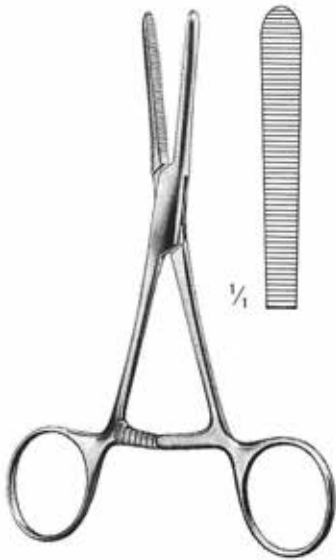

**WEISS**  
 12.702.14  
 14,5 cm

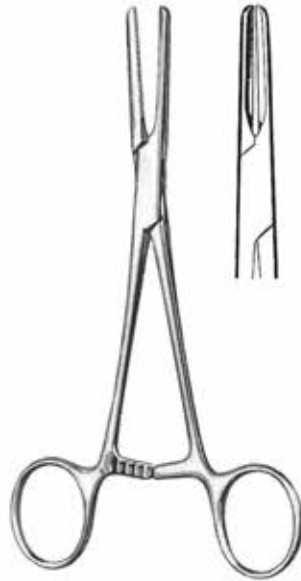

**MURPHY**  
 12.710.15 - 12.710.20



12.710.15  
 15 cm



12.710.18  
 18 cm



12.710.20  
 20 cm

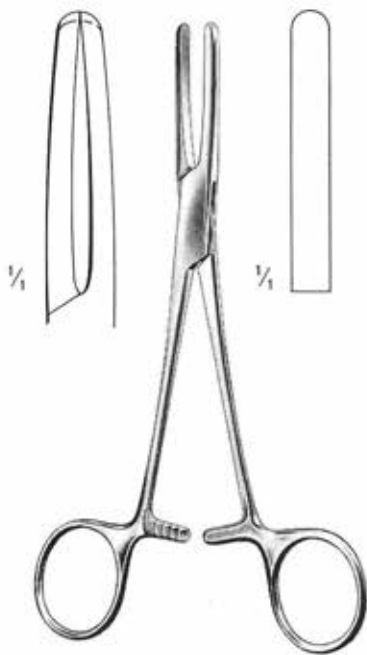

**PRESBYTERIAN HOSPITAL**  
 12.704.16 16 cm  
 12.704.18 18 cm

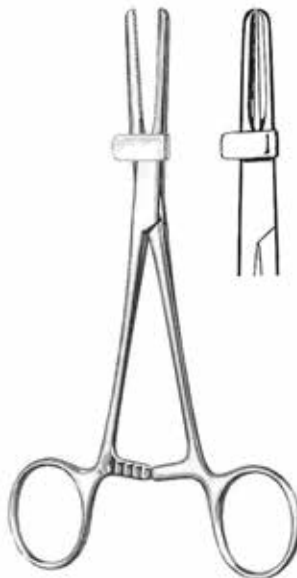

12.712.15 - 12.712.20



12.712.15  
 15 cm



12.712.18  
 18 cm



12.712.20  
 20 cm

Arterienklemmen / Hemostatic Forceps / Pincas hemostáticas / Pinzas hemostáticas / Pinze emostatiche

## **Rollenklemmen**

Tube milking rollers

Pince à rouleaux

Pinzas con rodillo

Pinze con rotoli



**GUNNER-HEY**  
**12.722.18**  
18,5 cm/7¼"



**BROMPTON**  
**12.724.15**  
15 cm/6"



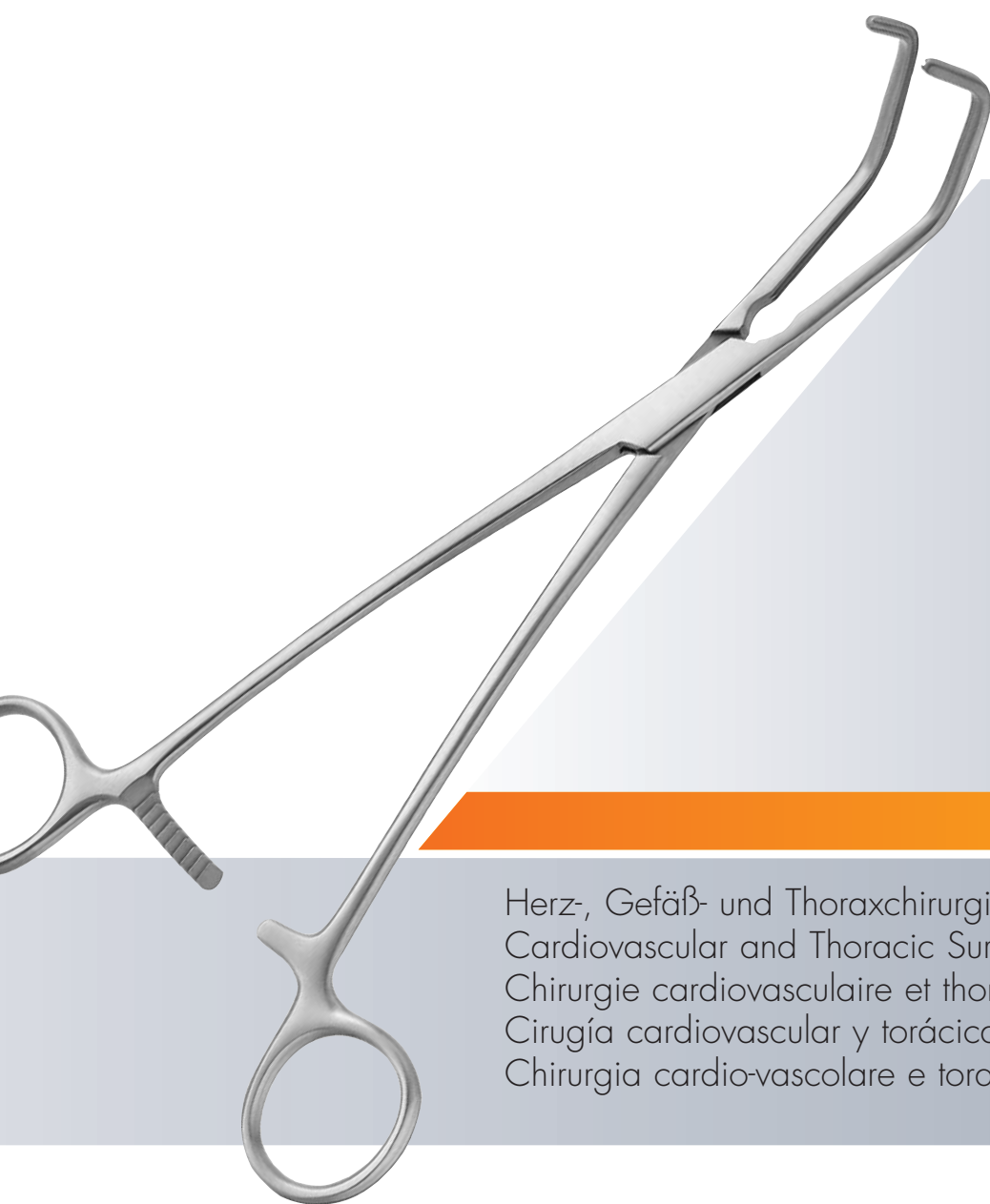

Herz-, Gefäß- und Thoraxchirurgie  
Cardiovascular and Thoracic Surgery  
Chirurgie cardiovasculaire et thoracique  
Cirugía cardiovascular y torácica  
Chirurgia cardio-vascolare e toracica

**Spezialkatalog**

Special catalog  
Catalogue spécial  
Catálogo especial  
Catalog speciale

**dimed**a®  
SURGICAL INSTRUMENTS



Herz-, Gefäß- und Thoraxchirurgie  
Cardiovascular and Thoracic Surgery  
Chirurgie cardiovasculaire et thoracique  
Cirugía cardiovascular y torácica  
Chirurgia cardio-vascolare e toracica



Tuchklemmen  
Towel Clamps  
Pincés à champs  
Pinzas para campos  
Pinze fissateli

## Tuchklemmen

Towel Clamps  
Pincès à champs  
Pinzas para campos  
Pinze fissateli

scharf  
sharp  
aigüe  
aguda  
acute



SCHAEDEL  
9,0 cm **14.101.09**

scharf  
sharp  
aigüe  
aguda  
acute



JONES  
5,0 cm **14.103.05**  
9,0 cm **14.103.09**

scharf  
sharp  
aigüe  
aguda  
acute



JONES-CLIP  
9,0 cm **14.105.09**

mit Schlauchhalter  
with tube holder  
avec clamp porte-tube  
con porta-tubo  
con porta tubo



BACKHAUS  
9,0 cm **14.111.09**  
11,0 cm **14.111.11**  
13,0 cm **14.111.13**  
15,0 cm **14.111.15**



11,0 cm **14.112.11**  
13,0 cm **14.112.13**

graziles Modell  
delicate model  
modèle gracile  
modelo delicato  
modello delicato



BACKHAUS KOCHER  
13,0 cm **14.113.13**

## Tuchklemmen

Towel Clamps  
Pinces à champs  
Pinzas para campos  
Pinze fissateli

**dimeda**<sup>®</sup>  
SURGICAL INSTRUMENTS



mit Schlauchhalter  
with tube holder  
avec clamp porte-tube  
con porta-tubo

### BACKHAUS-Clip

11,0 cm **14.115.11**  
13,0 cm **14.115.13**  
15,0 cm **14.115.15**



### ROEDER

13,0 cm **14.117.13**  
15,0 cm **14.117.15**

weites Maul zur Schlauchfixierung  
wide jaw for tube fixation  
mors large pour fixation de tube  
boca ancha para fijación de tubos  
morso spalancato per fissare il tubo



### PEERS BERTRAM

14,0 cm **14.118.14**

für Papierabdeckung  
for paper clothes  
pour couverture en papier  
para paños de papel  
per copertura di carta



### HOFF

10,0 cm **14.119.10**  
12,0 cm **14.119.12**  
14,0 cm **14.119.14**

## Tuchklemmen

Towel Clamps  
Pinces à champs  
Pinzas para campos  
Pinze fissateli

fein gezahnt, breites Maul  
fine serrated, wide jaw  
cuors large avec deuts fins  
boca anca, delicadamente dentada  
marso largo, con denti fini

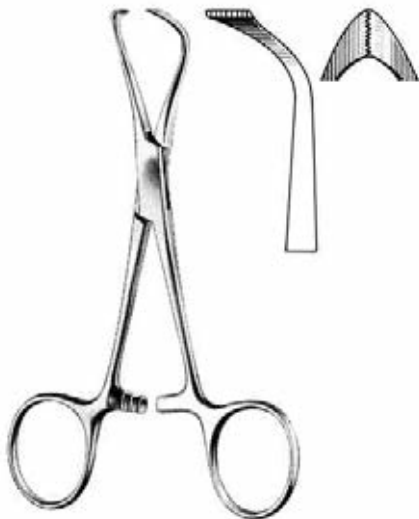

LORNA

9,0 cm **14.121.09**  
10,0 cm **14.121.10**  
11,0 cm **14.121.11**  
13,0 cm **14.121.13**

für Papierabdeckung  
for paper clothes  
pour couverture en papier  
para paños de papel  
per copertura di carta



BALL AND SOCKET

9,0 cm **14.123.09**  
10,0 cm **14.123.10**  
11,0 cm **14.123.11**  
13,0 cm **14.123.13**  
14,0 cm **14.123.14**  
16,0 cm **14.123.16**

stumpf  
blunt  
moussée  
roma  
smusse



TOHOKU

10,0 cm **14.127.10**  
13,0 cm **14.127.13**



BERNHARD  
16,5 cm **14.140.16**  
18,0 cm **14.140.18**

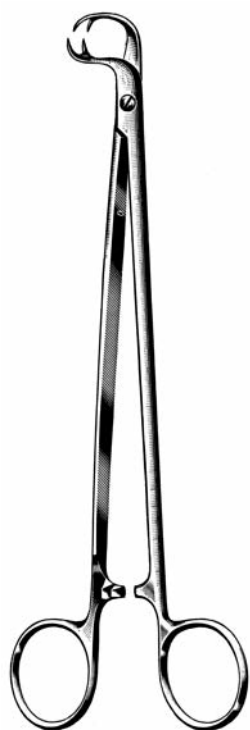

MOYNIHAN  
19,0 cm **14.150.19**



DOYEN  
14 cm **14.161.14**  
18 cm **14.161.18**



LANE  
13,0 cm **14.164.13**  
15,0 cm **14.164.15**  
20,0 cm **14.164.20**





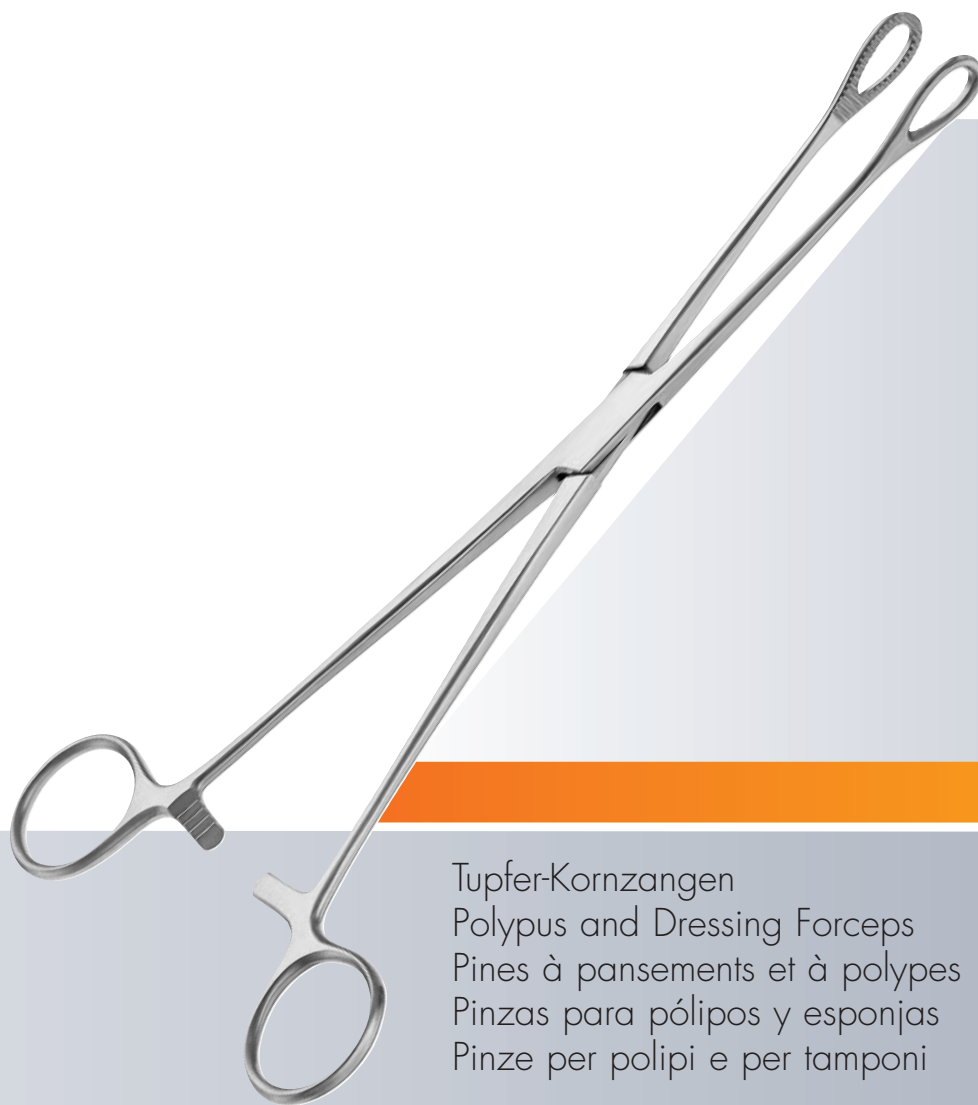

Tupfer-Kornzangen  
Polypus and Dressing Forceps  
Pines à pansements et à polypes  
Pinzas para pólipos y esponjas  
Pinze per polipi e per tamponi

## Tupferzangen

Dressing Forceps

Pinces à pansements

Pinzas para tapones

Pinze per medicatura



mit Sperre  
with ratchet  
avec crémaillère  
con cremallera  
con cremagliera

MARTIN

25,5 cm **16.100.25** **16.101.25**



ohne Sperre  
without ratchet  
sans crémaillère  
sin cremallera  
senza cremagliera

GROSS-MAIER

18,0 cm **16.104.18** **16.105.18**  
20,0 cm **16.104.20** **16.105.20**  
25,0 cm **16.104.25** **16.105.25**

## Tupferzangen

Dressing Forceps  
Pincès à pansements  
Pinzas para tapones  
Pinze per medicatura

**dimeda**<sup>®</sup>  
SURGICAL INSTRUMENTS



mit Sperre  
with ratchet  
avec crémaillère  
con cremallera  
con cremagliera

— GROSS-MAIER —

18,0 cm	<b>16.106.18</b>	<b>16.107.18</b>
20,0 cm	<b>16.106.20</b>	<b>16.107.20</b>
25,0 cm	<b>16.106.25</b>	<b>16.107.25</b>



ohne Sperre  
without ratchet  
sans crémaillère  
sin cremallera  
senza cremagliera

— GROSS-MAIER —

13,0 cm	<b>16.108.13</b>	<b>16.109.13</b>
14,0 cm	<b>16.108.14</b>	<b>16.109.14</b>

## Tupferzangen

Dressing Forceps

Pinces à pansements

Pinzas para tapones

Pinze per medicatura



mit Sperre  
with ratchet  
avec crémaillère  
con cremallera  
con cremagliera

— GROSS-MAIER —

14,0 cm	<b>16.110.14</b>	<b>16.111.14</b>
18,0 cm	<b>16.110.18</b>	<b>16.111.18</b>
20,0 cm	<b>16.110.20</b>	<b>16.111.20</b>
22,0 cm	<b>16.110.22</b>	<b>16.111.22</b>
25,0 cm	<b>16.110.25</b>	<b>16.111.25</b>
27,0 cm	<b>16.110.27</b>	<b>16.111.27</b>
36,0 cm	<b>16.110.36</b>	<b>16.111.36</b>
40,0 cm	<b>16.110.40</b>	<b>16.111.40</b>



ohne Sperre  
without ratchet  
sans crémaillère  
sin cremallera  
senza cremagliera

— GROSS-MAIER —

20,0 cm	<b>16.112.20</b>	<b>16.113.20</b>
25,0 cm	<b>16.112.25</b>	<b>16.113.25</b>

## Tupferzangen

Dressing Forceps  
Pinces à pansements  
Pinzas para tapones  
Pinze per medicatura

**dimeda**<sup>®</sup>  
SURGICAL INSTRUMENTS



mit Sperre  
with ratchet  
avec crémaillère  
con cremagliera

— GROSS —

18,0 cm **16.114.18** **16.115.18**



mit Sperre  
with ratchet  
avec crémaillère  
con cremagliera

— SIMS-MAIER —

28,0 cm **16.120.28** **16.121.28**

## Schwammzangen

Sponge Holding Forceps

Pinces porte-éponges

Pinzas porta esponjas

Pinze per tamponi e spugne

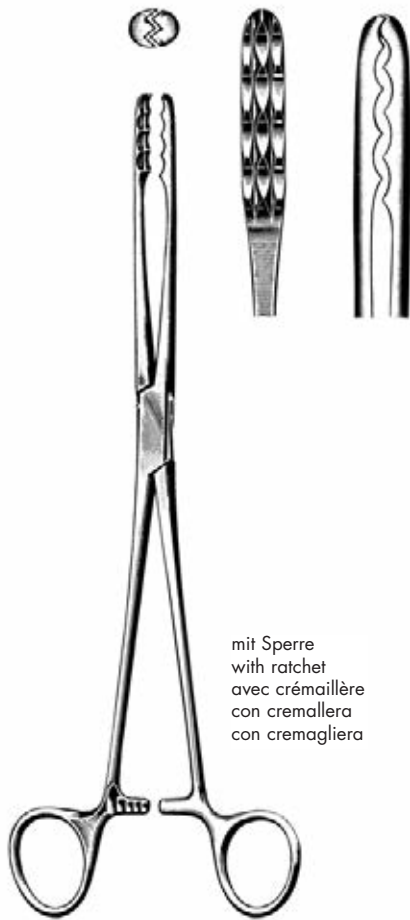

mit Sperre  
with ratchet  
avec crémaillère  
con cremallera  
con cremagliera

— ULRICH —

22,0 cm	<b>16.160.22</b>	<b>16.161.22</b>
25,0 cm	<b>16.160.25</b>	<b>16.161.25</b>
27,0 cm	<b>16.160.27</b>	<b>16.161.27</b>

**Schwammzangen**  
 Sponge Holding Forceps  
 Pincès porte-éponges  
 Pinzas porta esponjas  
 Pinze per tamponi e spugne

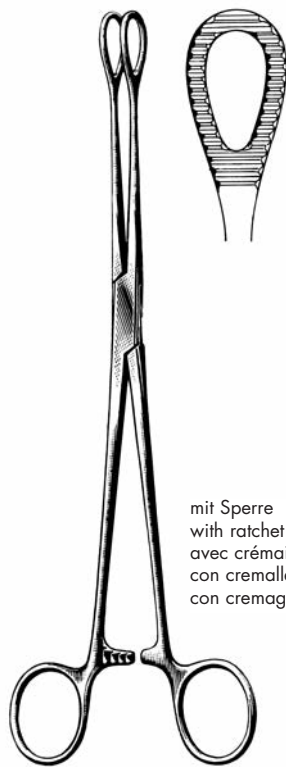

mit Sperre  
 with ratchet  
 avec crémaillère  
 con cremallera  
 con cremagliera

— FOERSTER —

18,0 cm	<b>16.170.18</b>	<b>16.171.18</b>
20,0 cm	<b>16.170.20</b>	<b>16.171.20</b>
25,0 cm	<b>16.170.25</b>	<b>16.171.25</b>
30,0 cm	<b>16.170.30</b>	<b>16.171.30</b>



mit Sperre  
 with ratchet  
 avec crémaillère  
 con cremallera  
 con cremagliera

— FOERSTER —

18,0 cm	<b>16.172.18</b>	<b>16.173.18</b>
20,0 cm	<b>16.172.20</b>	<b>16.173.20</b>
25,0 cm	<b>16.172.25</b>	<b>16.173.25</b>
30,0 cm	<b>16.172.30</b>	<b>16.173.30</b>

## Schwammzangen

Sponge Holding Forceps

Pinces porte-éponges

Pinzas porta esponjas

Pinze per tamponi e spugne

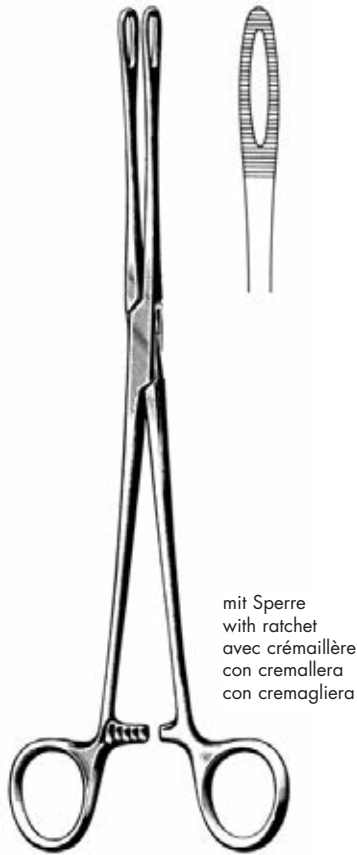

mit Sperre  
with ratchet  
avec crémaillère  
con cremallera  
con cremagliera

— FORESTER —

25,0 cm **16.174.25** **16.175.25**



mit Sperre  
with ratchet  
avec crémaillère  
con cremallera  
con cremagliera

BONNEY

24,0 cm **16.176.24**



**Schwammzangen**  
Sponge Holding Forceps  
Pincès porte-éponges  
Pinzas porta esponjas  
Pinze per tamponi e spugne

**dimeda**<sup>®</sup>  
SURGICAL INSTRUMENTS



mit Sperre  
with ratchet  
avec crémaillère  
con cremallera  
con cremagliera

RAMPLEY  
18,0 cm **16.178.18**  
25,0 cm **16.178.25**



mit Sperre  
with ratchet  
avec crémaillère  
con cremallera  
con cremagliera

RAMPLEY  
25,0 cm **16.180.25**

Tupfer-Kornzangen / Polypus and Dressing Forceps / Pines à pansements et à polypes / Pinzas para pólipos y esponjas / Pinze per polipi e per tamponi

## Schwammzangen

Sponge Holding Forceps

Pinces porte-éponges

Pinzas porta esponjas

Pinze per tamponi e spugne

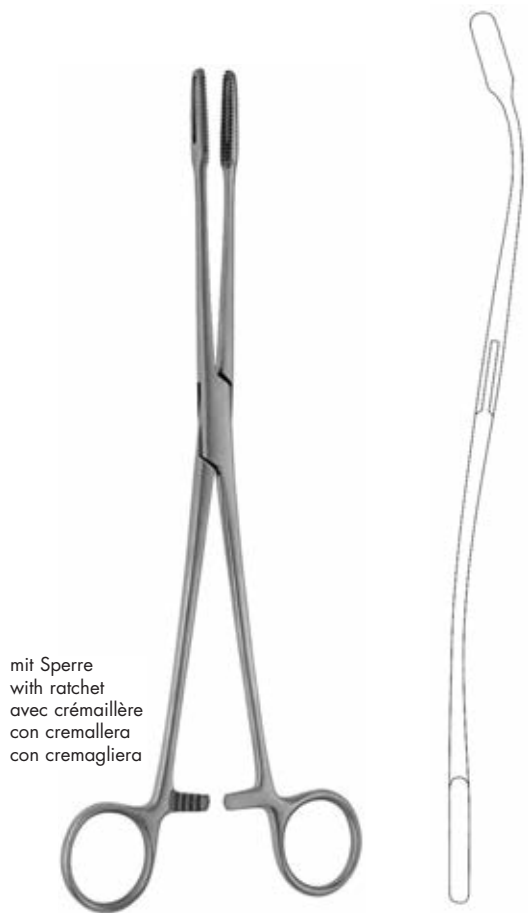

FLETCHER JAVERS

25,0 cm **16.182.25** **16.183.25**



— BERGMANN FOERSTER —

24,0 cm **16.186.24** **16.187.24**

## Tupferzangen

Dressing Forceps  
Pincès à pansements  
Pinzas para tapones  
Pinze per medicatura

**dimeda**<sup>®</sup>  
SURGICAL INSTRUMENTS



ohne Sperre  
without ratchet  
sans crémaillère  
sin cremallera  
senza cremagliera

BRYANT  
13,0 cm **16.207.13**



Sinusklemme  
Sinus forceps  
Pincès à sinus  
Pinzas para seno  
Pinze sinus

LISTER  
13,0 cm **16.210.13**  
16,0 cm **16.210.16**  
18,0 cm **16.210.18**

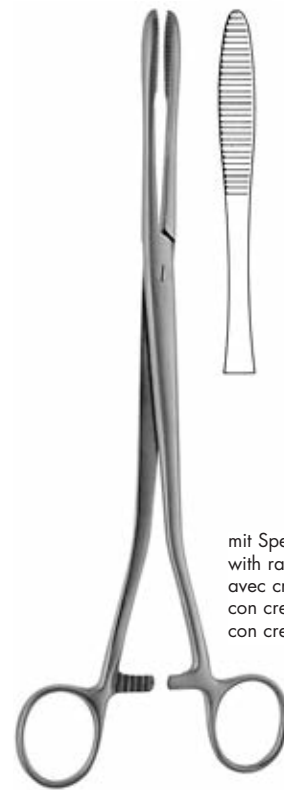

mit Sperre  
with ratchet  
avec crémaillère  
con cremallera  
con cremagliera

COLLIN  
25,0 cm **16.220.25**

## Tupferzangen

Dressing Forceps

Pinces à pansements

Pinzas para tapones

Pinze per medicatura



mit Sperre  
with ratchet  
avec crémaillère  
con cremallera  
con cremagliera

— PELKMANN —

25,0 cm **16.226.25** **16.227.25**



mit Sperre  
with ratchet  
avec crémaillère  
con cremallera  
con cremagliera

CHERON

25,0 cm **16.229.25**



mit Sperre  
with ratchet  
avec crémaillère  
con cremallera  
con cremagliera

MAIER

25,0 cm **16.230.25**

## Tupferzangen

Dressing Forceps

Pinces à pansements

Pinzas para tapones

Pinze per medicatura

**dimeda**<sup>®</sup>  
SURGICAL INSTRUMENTS

mit Sperre  
with ratchet  
avec crémaillère  
con cremallera  
con cremagliera

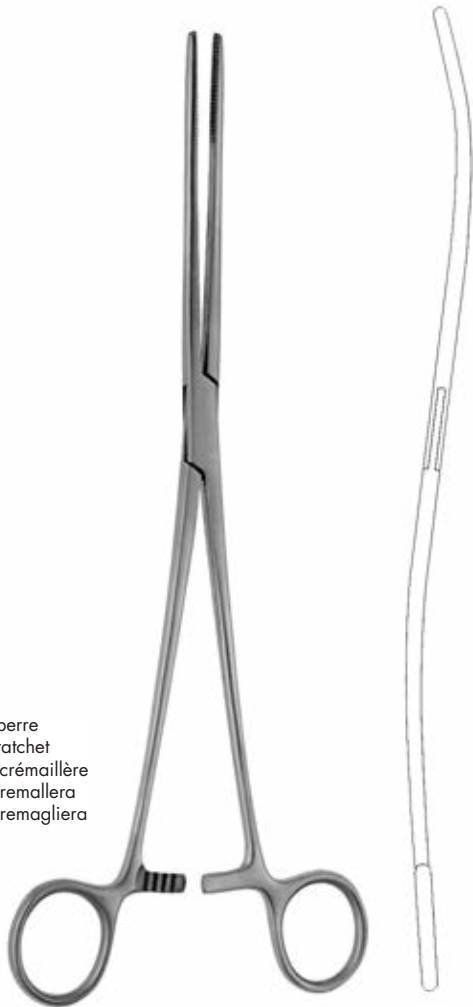

BOZEMANN  
26,0 cm **16.230.26** **16.231.26**

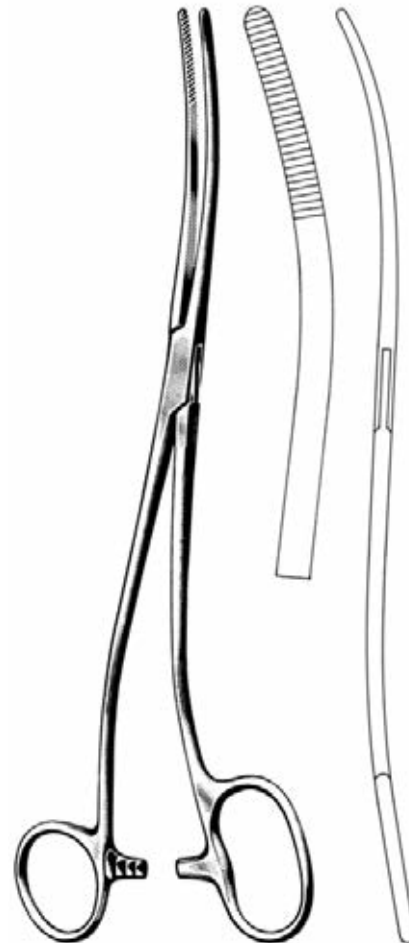

BOZEMANN-DOUGLAS  
26,0 cm **16.233.26**

Tupfer-Kornzangen / Polypus and Dressing Forceps / Pines à pansements et à polypes / Pinzas para pólipos y esponjas / Pinze per polipi e per tamponi

## Tupferzangen

Dressing Forceps

Pinces à pansements

Pinzas para tapones

Pinze per medicatura



mit Sperre  
with ratchet  
avec crémaillère  
con cremallera  
con cremagliera

— MARTIN —

17,0 cm **16.244.17** **16.245.17**



mit Sperre  
with ratchet  
avec crémaillère  
con cremallera  
con cremagliera

— DUPLAY —

20,0 cm **16.246.20** **16.247.20**



Wundhaken  
Retractors  
Ecarteurs  
Separadores  
Divaricatori

## Wundhaken

Retractors  
Ecarteurs  
Separadores  
Divaricatori

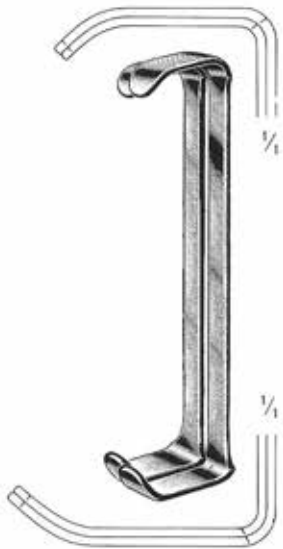

FARABEUFF  
18.102.12  
12 cm

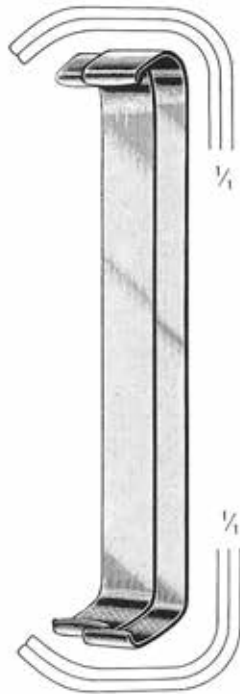

FARABEUFF  
18.102.15  
15 cm

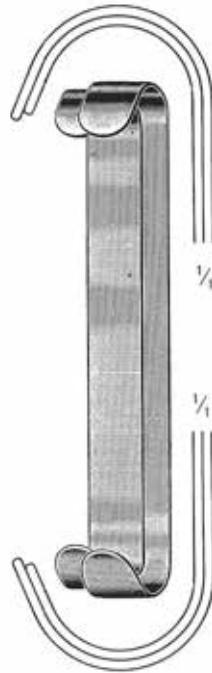

PARKER  
18.110.13  
13,5 cm



PARKER  
18.110.18  
18 cm

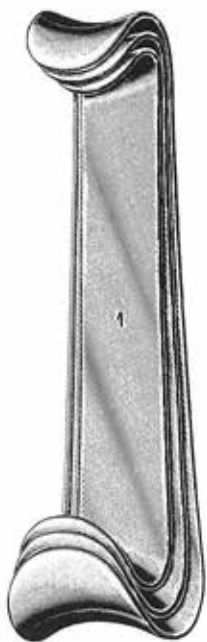

ROUX  
18.120.00

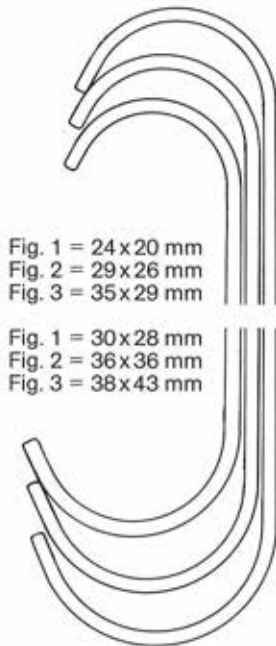
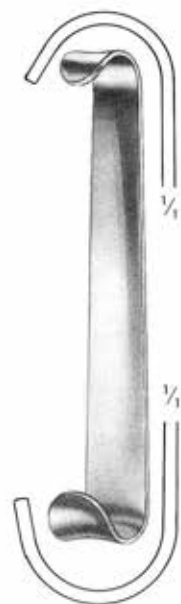
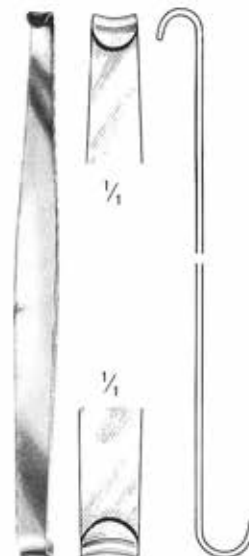

Fig. 1 = 24 x 20 mm  
Fig. 2 = 29 x 26 mm  
Fig. 3 = 35 x 29 mm

Fig. 1 = 30 x 28 mm  
Fig. 2 = 36 x 36 mm  
Fig. 3 = 38 x 43 mm



ROUX Baby  
18.122.13  
13 cm



ROUX mini  
18.124.15  
15 cm



CRILE  
18.127.11  
11,5 cm

ROUX	Fig.	cm
18.120.14	1	14
18.120.15	2	15
18.120.17	3	17



**Wundhaken**

Retractors  
Ecarteurs  
Separadores  
Divaricatori

Wundhaken / Retractors / Ecarteurs / Separadores / Divaricatori



Fig. 2 = 25 x 15 mm  
Fig. 1 = 21 x 15 mm



Fig. 2 = 47 x 13 mm  
Fig. 1 = 42 x 13 mm

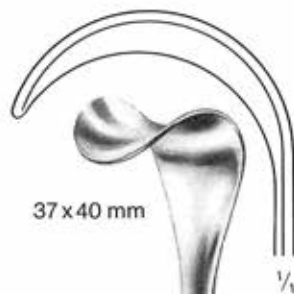

37 x 40 mm

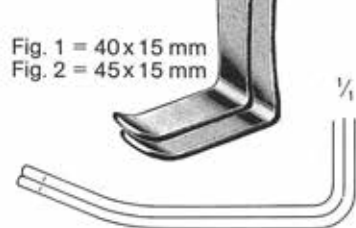

Fig. 1 = 40 x 15 mm  
Fig. 2 = 45 x 15 mm



Fig. 1 = 42 x 26 mm  
Fig. 2 = 46 x 26 mm

US Army (PARKER-LANGENBECK)  
18.131.21  
21 cm

MATHIEU  
18.134.20  
20 cm

GOELET  
18.135.19  
19 cm



52 x 33 mm

30 x 21 mm

COLLIN-HARTMANN  
18.137.16  
16 cm

## Wundhaken

Retractors  
Ecarteurs  
Separadores  
Divaricatori

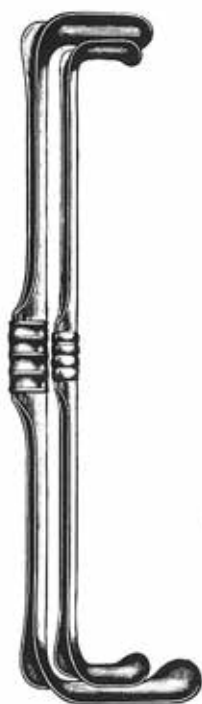

RICHARDSON-EASTMAN  
18.140.00



18.150.01  
28x20 mm



18.150.02  
36x28 mm



18.150.03  
44x38 mm



RICHARDSON



RICHARDSON Grip  
18.152.25 20x25 mm  
18.152.31 25x31 mm  
18.152.38 38x38 mm  
18.152.51 19x51 mm (Append.)  
18.152.64 41x64 mm

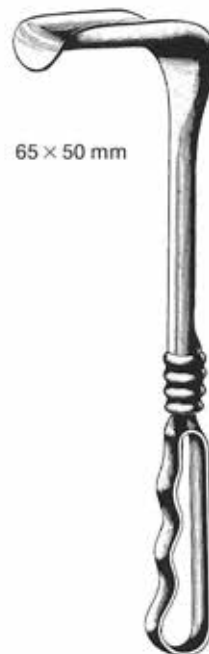

65 x 50 mm

KELLY  
18.156.26  
26 cm

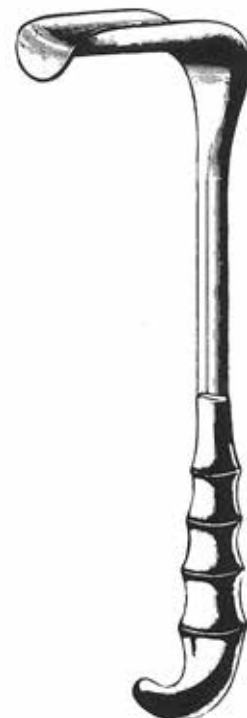

KELLY Grip  
18.158.51 38x51 mm  
18.158.64 51x64 mm  
18.158.76 64x76 mm  
18.158.82 70x82 mm

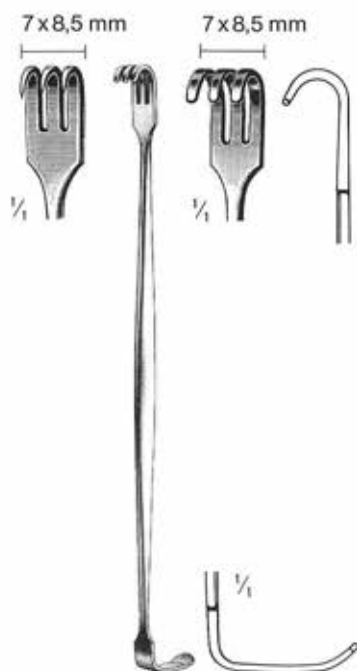

7x8,5 mm  
7x8,5 mm  
1/4  
1/4  
1/4  
SENN  
18.160.17 17 cm 18.161.17



RIBBON  
18.168.12 12x200 mm  
18.168.17 17x200 mm  
18.168.25 25x250 mm



RIBBON  
18.170.25 25x330  
18.170.32 32x330  
18.170.40 40x330  
18.170.50 50x330



HABERER  
18.174.17 17/25x200 mm  
18.174.25 25/30x250 mm  
18.174.37 37/45x300 mm



REVERDIN  
18.175.28  
28 cm

**Wundhaken**

Retractors  
Ecarteurs  
Separadores  
Divaricatori

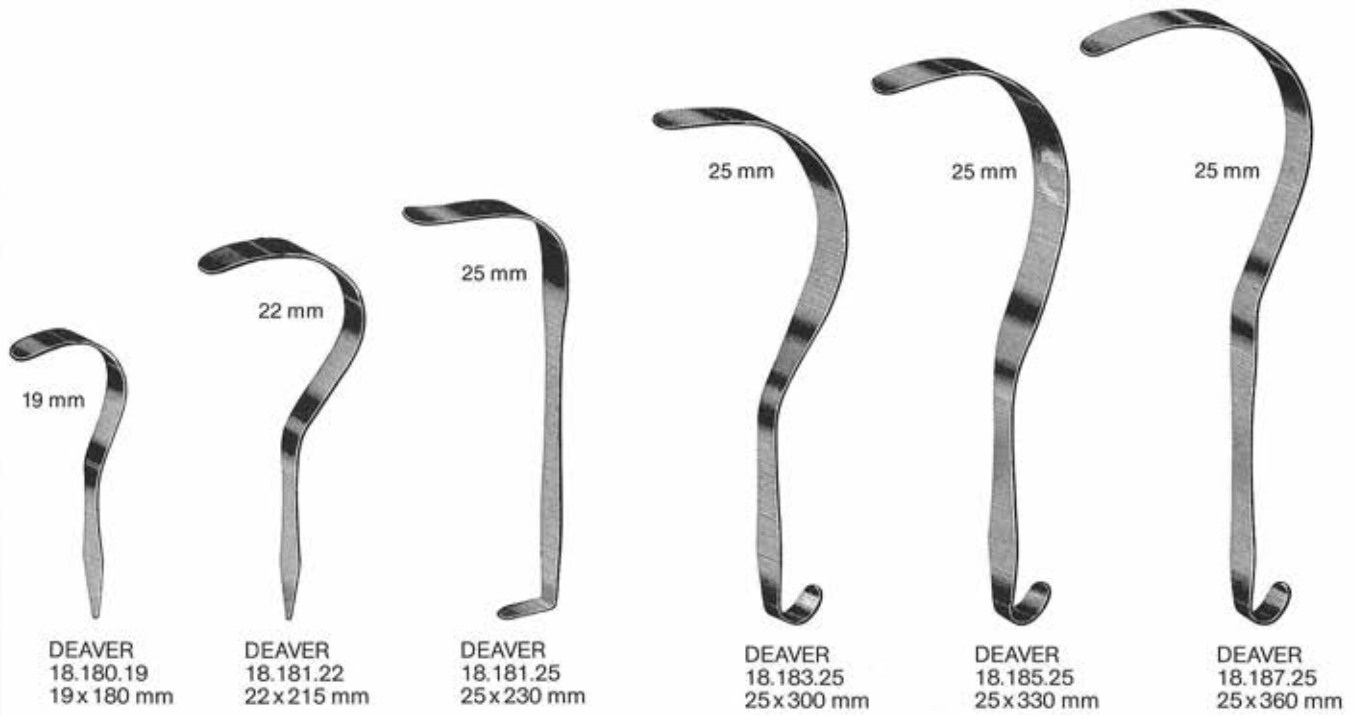

Wundhaken / Retractors / Ecarteurs / Separadores / Divaricatori

## Wundhaken

Retractors  
Ecarteurs  
Separadores  
Divaricatori

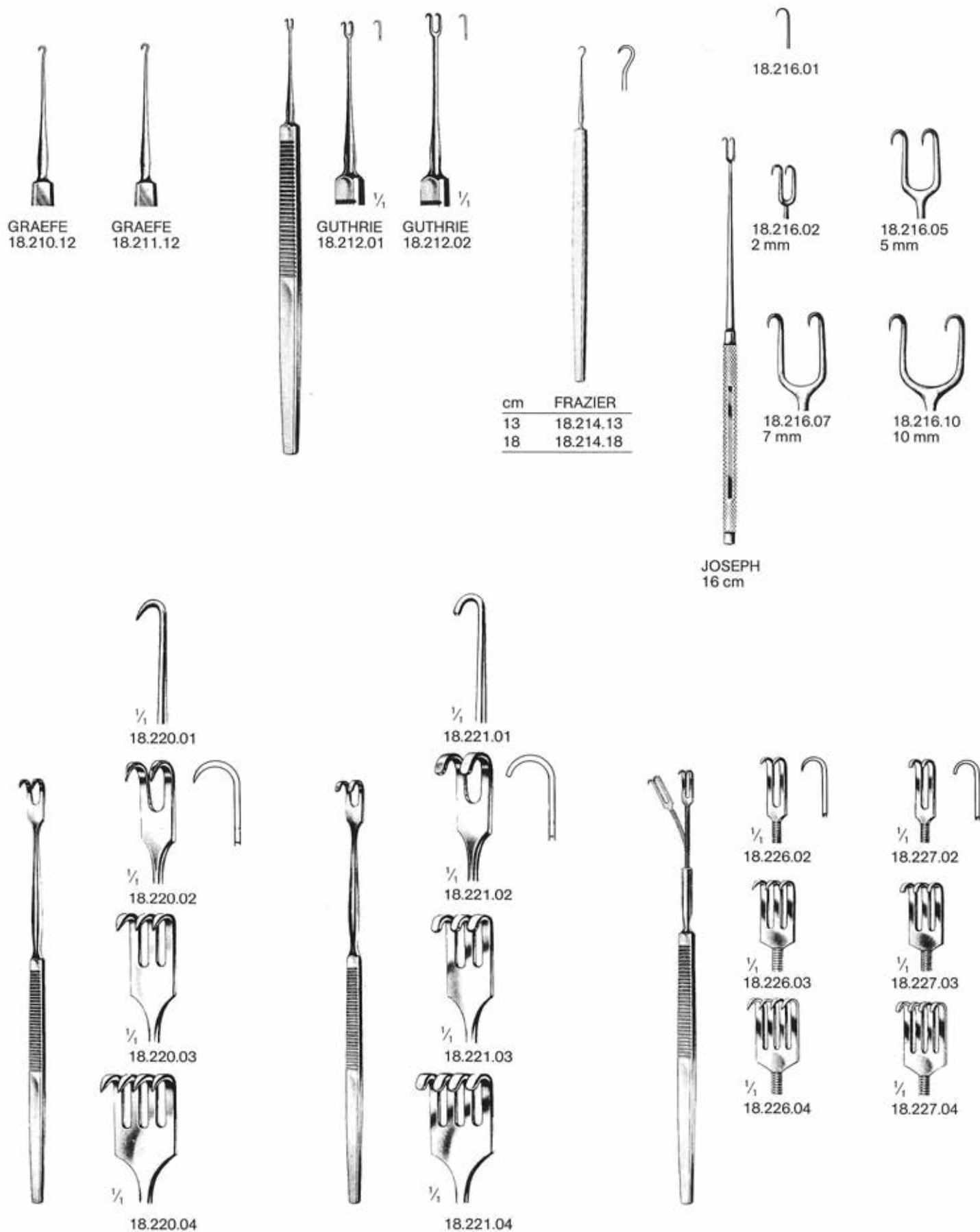

**Wundhaken**

Retractors  
Ecarteurs  
Separadores  
Divaricatori

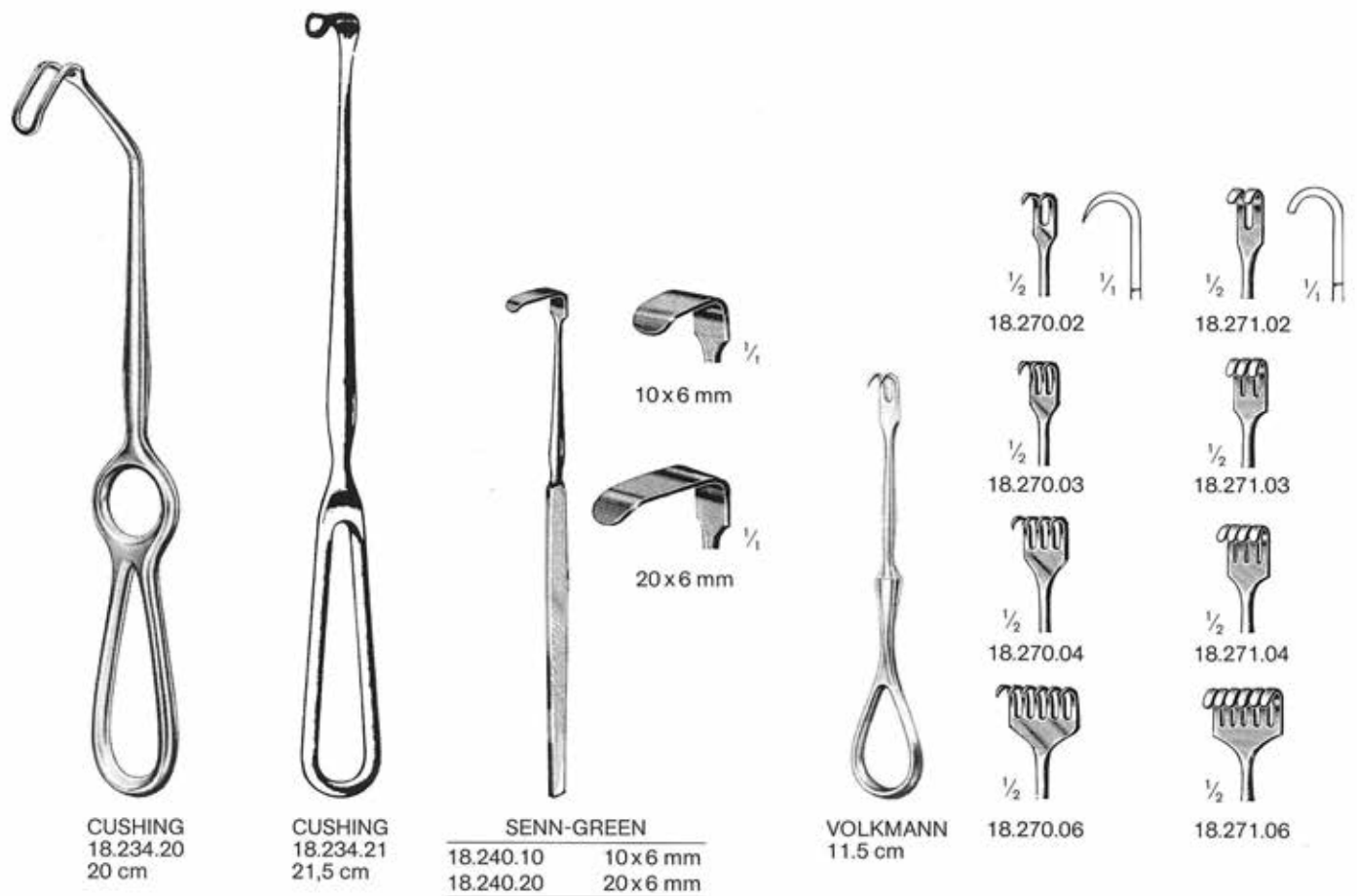
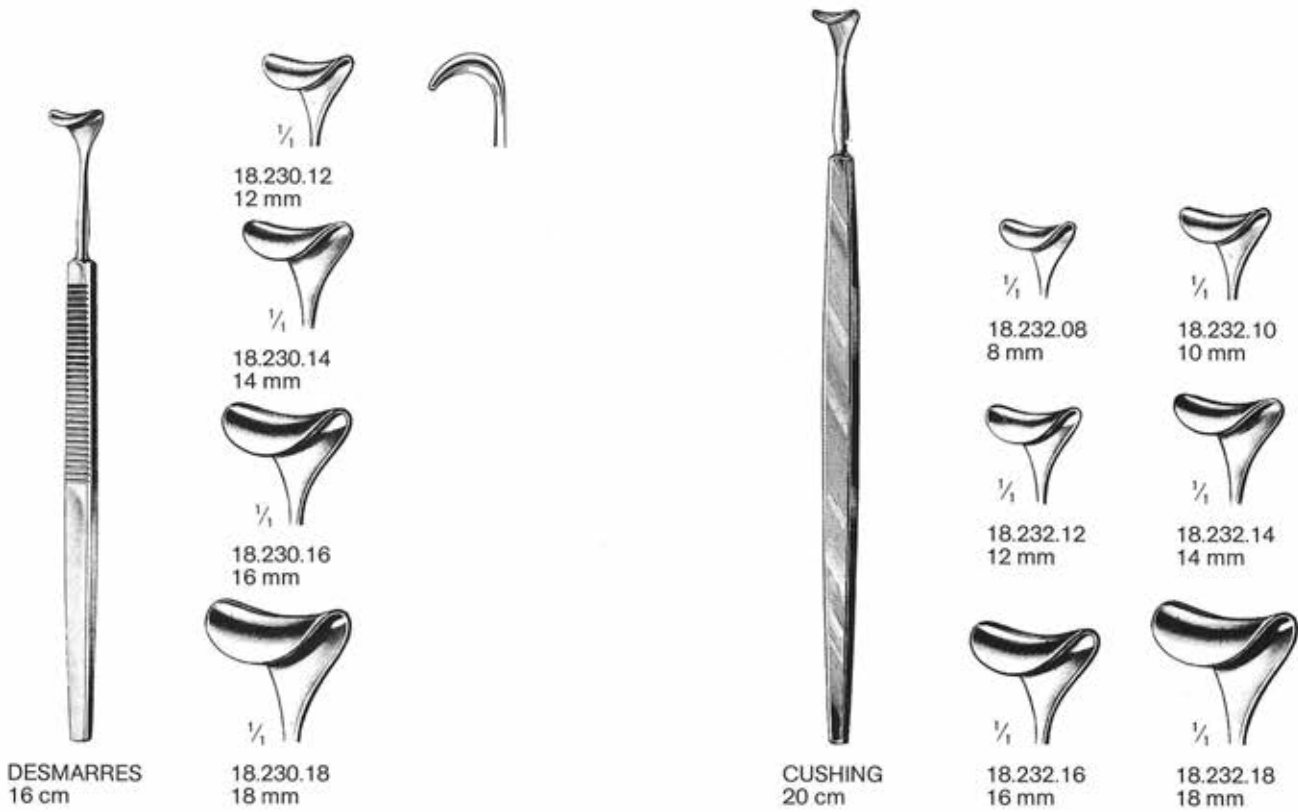



## Wundhaken

Retractors  
Ecarteurs  
Separadores  
Divaricatori



VOLKMANN  
21.5 cm



1/4



1/2

18.280.01



1/2

18.280.02



1/2

18.280.03



1/2

18.280.04



1/2

18.280.06



1/4



1/2

18.281.01



1/2

18.281.02



1/2

18.281.03



1/2

18.281.04



1/2

18.281.06



1/4

18x7 mm 18.302.01



1/4

16x5 mm 18.302.02



1/4

7x4 mm 18.302.03



1/4

7x4 mm 18.302.04



1/4

10x3 mm 18.302.05



1/4

10x4 mm 18.302.06



1/4

28x6 mm



LAHEY  
18.304.19  
19 cm

12x14 mm



1/4



LITTLE  
18.306.20  
20 cm



MEYERDING  
18 cm

**Wundhaken**

Retractors  
Ecarteurs  
Separadores  
Divaricatori



18.310.01  
- 18.310.05  
22 cm

18.312.01  
- 18.312.05  
21 cm

LANGENBECK

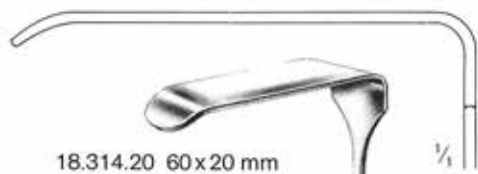
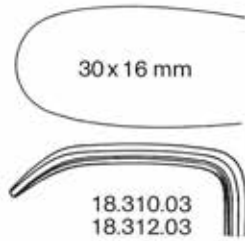
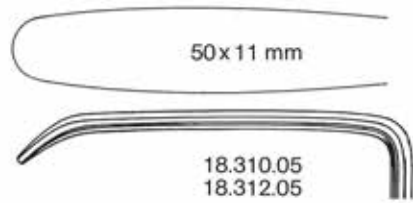
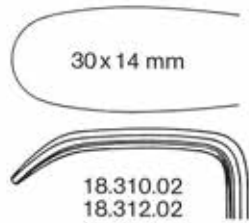
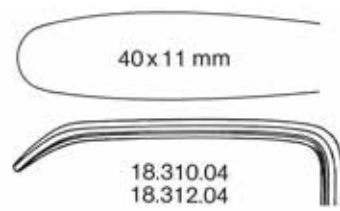
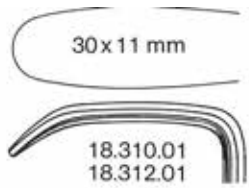

18.314.20 60x20 mm



60x20 mm

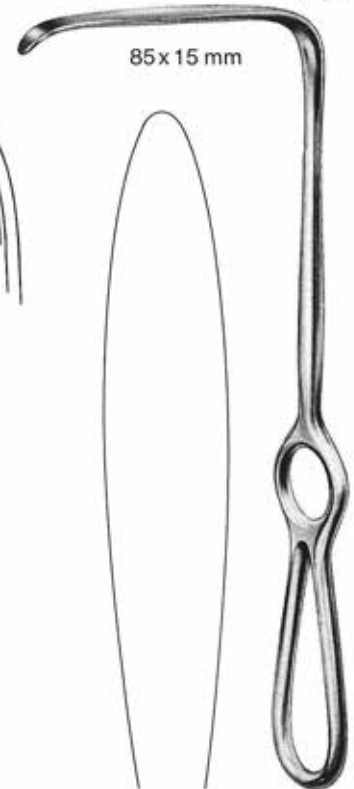

85x15 mm



18.314.07 35x7 mm



18.314.10 35x10 mm



18.314.15 35x15 mm



LANGENBECK  
18.314.07 - 18.314.20  
21 cm

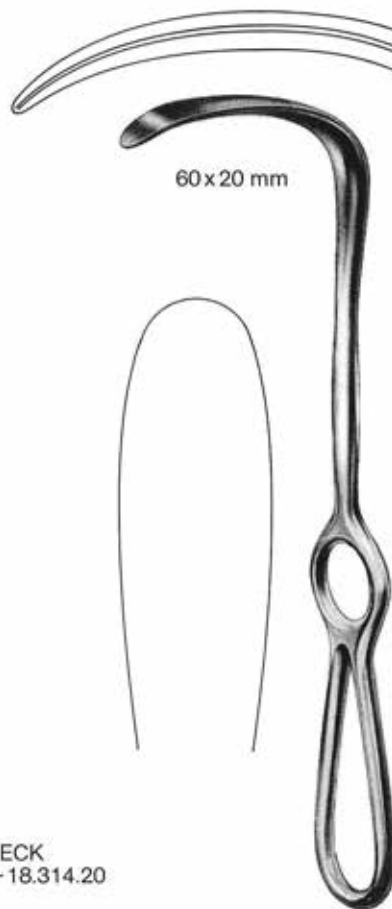

LANGENBECK  
18.315.21  
21 cm

LANGENBECK  
18.317.21  
21 cm

## Wundhaken

Retractors  
Ecarteurs  
Separadores  
Divaricatori

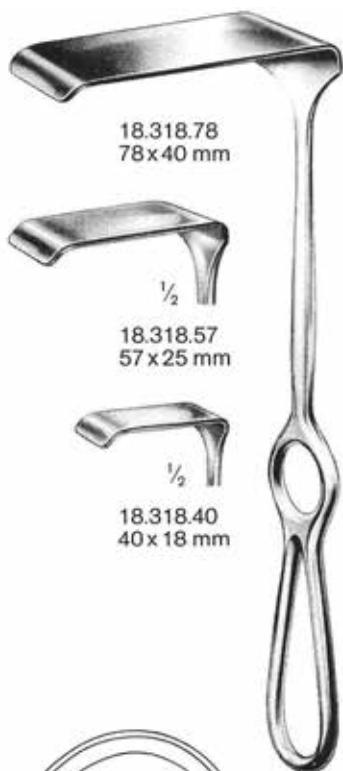

18.318.78  
78x40 mm

18.318.57  
57x25 mm

18.318.40  
40x18 mm

KOCHER  
18.318.40-18.318.78  
23 cm

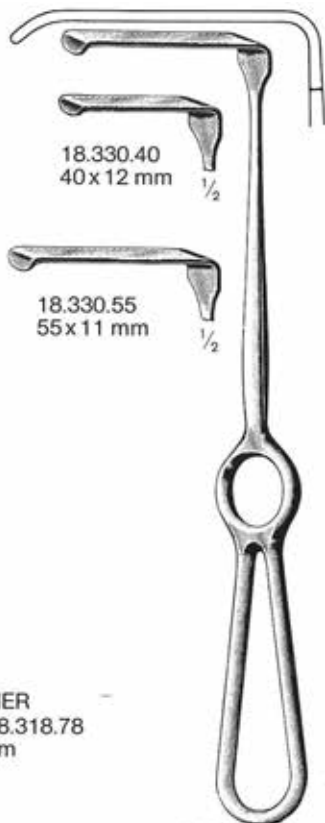

18.330.40  
40x12 mm

18.330.55  
55x11 mm

KOCHER  
18.330.40-18.330.55  
19 cm

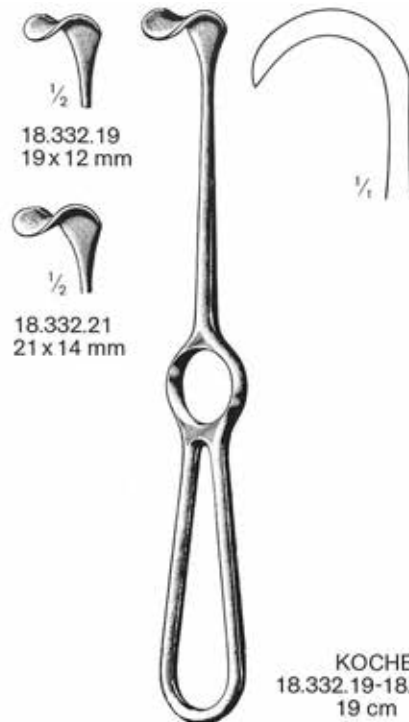

18.332.19  
19x12 mm

18.332.21  
21x14 mm

KOCHER  
18.332.19-18.332.21  
19 cm



KOCHER	mm
18.340.10	40x10
18.340.15	40x15
18.340.20	40x20
22 cm	

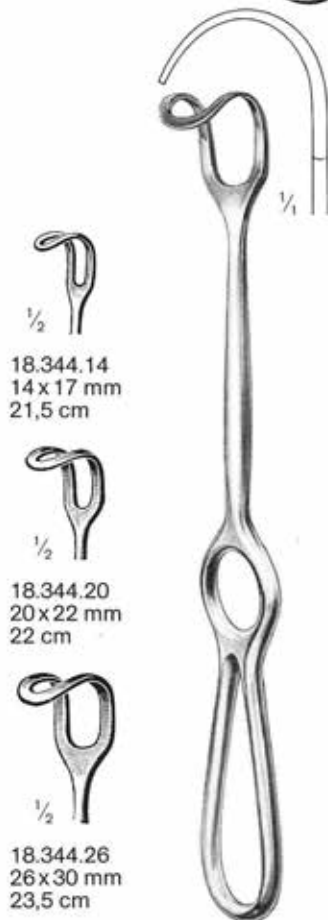

18.344.14  
14x17 mm  
21,5 cm

18.344.20  
20x22 mm  
22 cm

18.344.26  
26x30 mm  
23,5 cm

MIDDELDORPF  
18.344.14-18.344.26



GREEN  
18.348.22  
22 cm



OLLIER  
18.360.04  
22,5 cm



**Wundhaken**

Retractors  
Ecarteurs  
Separadores  
Divaricatori



18.364.40 40x40 mm



18.364.50 45x50 mm



18.364.60 50x60 mm

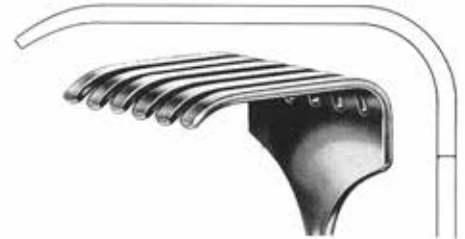

18.364.70 70x70 mm

ISRAELRUMEL  
25 cm



40x30 mm

— KOERTE —  
18.366.08 23,5 cm 18.367.08



FRITSCH	mm
18.370.40	45x40
18.370.50	45x50
18.370.60	45x60
18.370.75	45x75
24 cm	



70x25 mm

KOCHER  
18.372.22  
22,5 cm

KOCHER	mm
18.374.45	80x45
18.374.55	80x55
18.374.65	80x65
25 cm	

## Wundhaken

Retractors  
Ecarteurs  
Separadores  
Divaricatori



50 x 85 mm

DOYEN  
18.378.25  
25 cm



90 x 50 mm

18.380.35  
95 x 35 mm

18.380.50  
120 x 50 mm

18.381.50  
150 x 50 mm

MIKULICZ  
26 cm

MIKULICZ  
26 cm



18.482.82  
82 x 28 mm

18.482.73  
73 x 28 mm

1/2

18.482.45  
45 x 25 mm

1/2

MIKULICZ  
18.382.50  
26 cm

mm	KELLY
160 x 38	18.385.38
160 x 57	18.385.57
	27 cm

SIMON	mm
18.480.22	115 x 22
18.480.27	115 x 27
	28 cm

HEANEY
18.482.45-18.482.82
27 cm

**Wundhaken**

Retractors  
Ecarteurs  
Separadores  
Divaricatori



18.490.65  
115x65 mm

18.490.43  
108x43 mm

18.490.22  
82x22 mm

125x37 mm

**CORYLLOS (Thorax)**  
18.490.22-18.490.65  
24 cm



18.494.45  
45x15 mm

18.494.60  
60x23 mm

18.494.75  
75x20 mm

**SAUERBRUCH**  
18.494.45-18.494.75  
22,5 cm



**SAUERBRUCH**  
18.492.25  
25 cm

**DAVIDSON (Scapula)**  
18.496.50  
75x50 mm



**DAVIDSON (Scapula)**  
18.496.90  
75x90 mm

## Wundsperrer

Retractors  
Ecarteurs  
Separadores  
Divaricatori

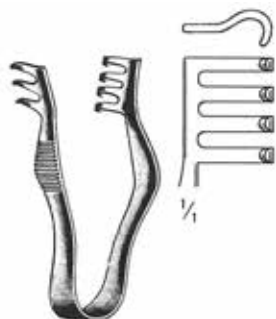

**FINSEN**  
18.610.07 7 cm 18.611.07

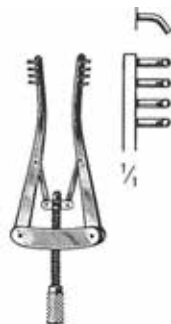

**ALM**  
18.620.07 7 cm 18.621.07  
18.620.10 10 cm 18.621.10



**JANSEN**  
18.630.10  
10 cm



**JANSEN**  
18.631.10  
10 cm



**DIMEDA**  
18.634.10 10cm 18.635.10

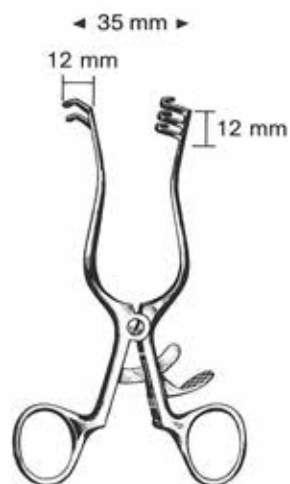

**WEITLANER**  
18.650.10 11,5cm 18.651.10

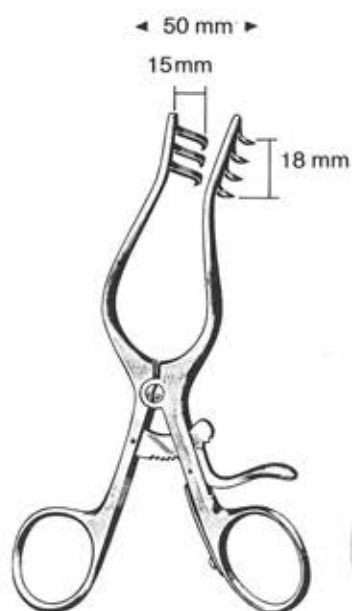

**WEITLANER-WULLSTEIN**  
18.654.13 13 cm 18.655.13



**PLESTER**  
18.657.11  
11 cm



**PLESTER**  
18.659.11  
11 cm

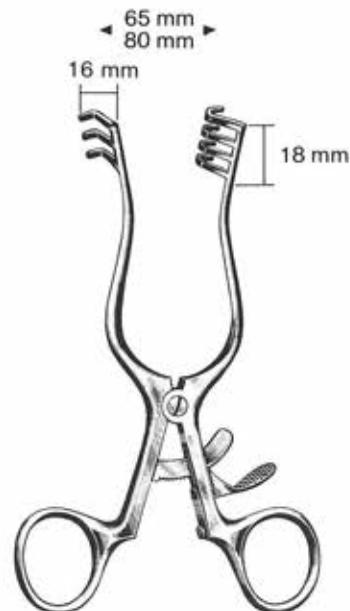

**WEITLANER**  
18.670.14 14,0 cm 18.671.14  
18.670.16 16,5 cm 18.671.16  
18.670.20 20,0 cm 18.671.20



**Wundsperrer**

Retractors  
Ecarteurs  
Separadores  
Divaricatori



ADSON  
18.682.26-18.683.26  
26,5 cm

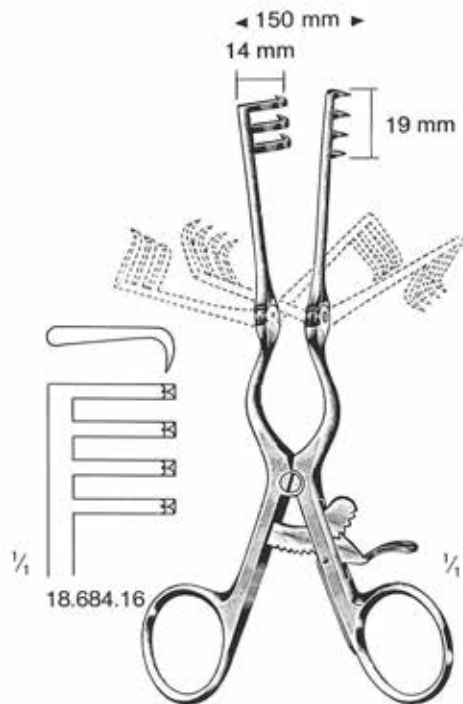

ADSON Baby  
18.684.16-18.685.16  
16 cm



BECKMANN-ADSON  
18.686.32  
32 cm

## Wundsperrer

Retractors  
Ecarteurs  
Separadores  
Divaricatori

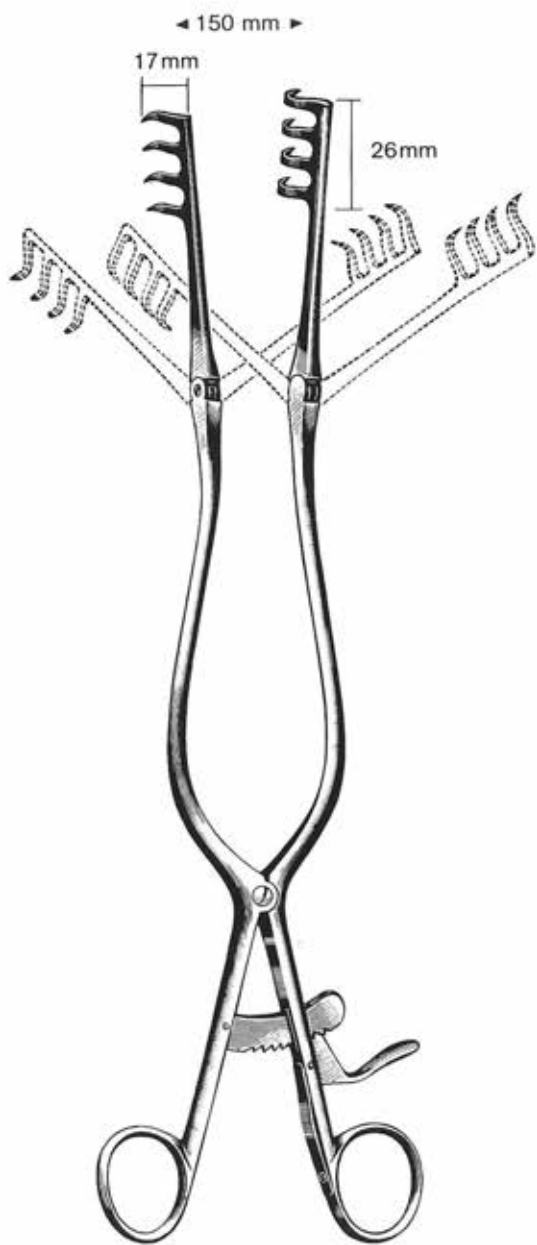

BECKMANN  
18.690.31  
31 cm



BECKMANN-EATON  
18.692.32  
32 cm

**Wundsperrer**

Retractors  
Ecarteurs  
Separadores  
Divaricatori

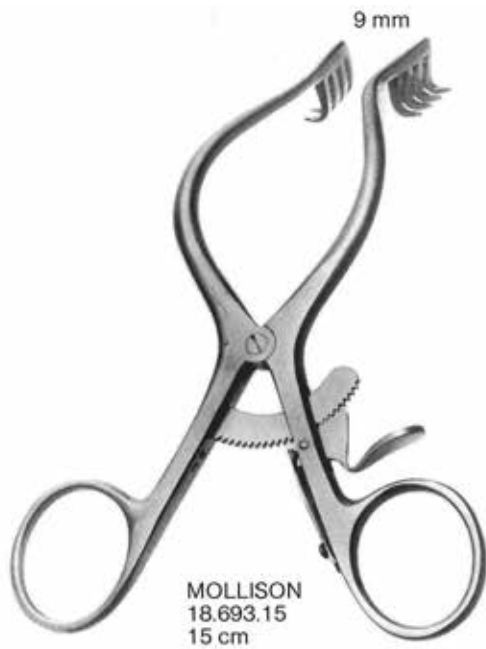

MOLLISON  
18.693.15  
15 cm



DARLING  
18.696.18  
18 cm

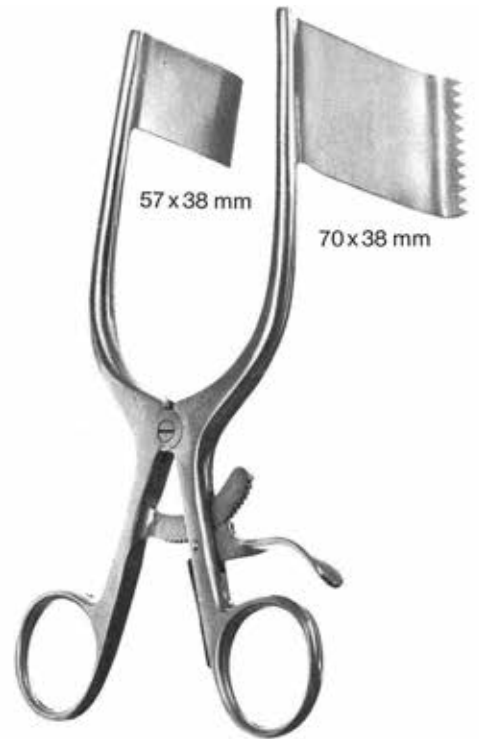

DARLING  
18.698.18  
18 cm

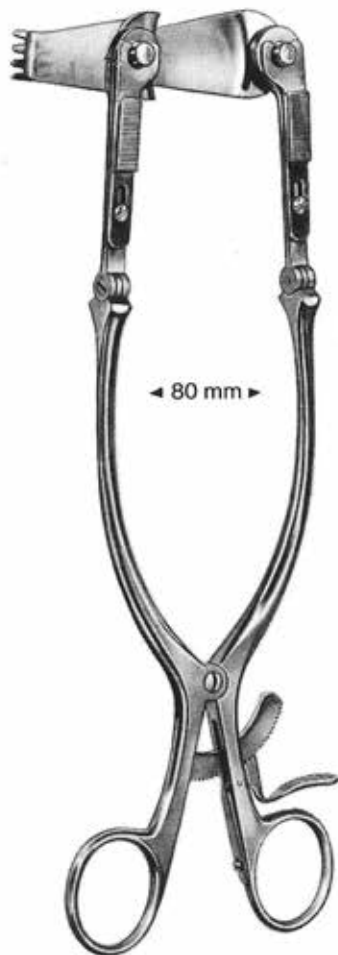

◀ 80 mm ▶

CLOWARD  
18.710.00  
18.710.01

ohne Valven · without blades  
sans valves · sin valvas · senza valve

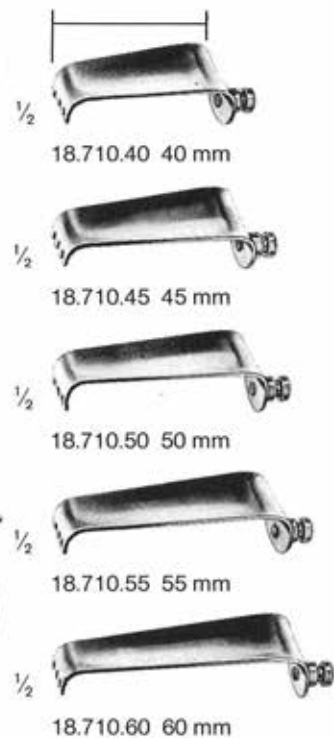

18.710.40 40 mm  
18.710.45 45 mm  
18.710.50 50 mm  
18.710.55 55 mm  
18.710.60 60 mm



◀ 55 mm ▶

CLOWARD  
18.711.00  
18.711.01

ohne Valven · without blades  
sans valves · sin valvas · senza valve

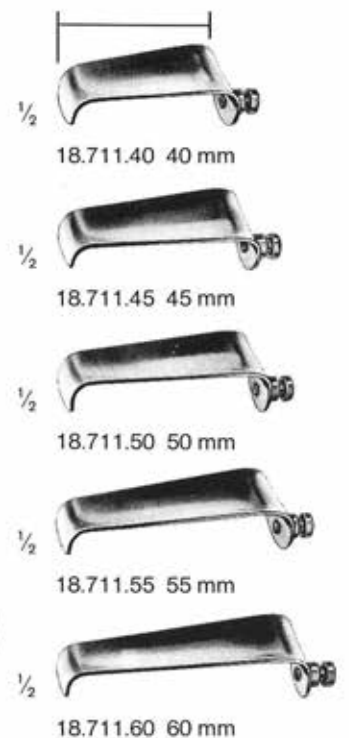

18.711.40 40 mm  
18.711.45 45 mm  
18.711.50 50 mm  
18.711.55 55 mm  
18.711.60 60 mm

## Wundsperrer, ges. Wirbelsäule

Retractors, vertebral Column

Ecarteurs, colonne vertébrale

Separadores, columna vertebral

Divaricatori, colonna vertebrale



CASPAR  
18.720.00 compl.  
18.720.15 ohne Valven · without blades  
sans valves · sin valvas · senza valve



CASPAR  
18.724.00 compl.  
18.724.11



stumpf  
blunt  
mousse  
roma  
smussa

mm	CASPAR
45x23	18.716.45
50x23	18.716.50
55x23	18.716.55
60x23	18.716.60
65x23	18.716.65



CASPAR  
18.721.00 compl.  
18.721.15 ohne Valven · without blades · sans valves · sin valvas · senza valve



medial

mm	CASPAR
40x23	18.718.40
45x23	18.718.45
50x23	18.718.50
55x23	18.718.55
60x23	18.718.60



lateral

mm	CASPAR
40x23	18.719.40
45x23	18.719.45
50x23	18.719.50
55x23	18.719.55
60x23	18.719.60



**Wundsperrer, ges. Wirbelsäule**

Retractors, vertebral Column  
Ecarteurs, colonne vertébrale  
Separadores, columna vertebral  
Divaricatori, colonna vertebrale

18.745.40  
40 mm



18.745.45  
45 mm



18.745.50  
50 mm



18.745.55  
55 mm



18.745.60  
60 mm



18.745.65  
65 mm



18.745.70  
70 mm



CASPAR

18.744.00 compl incl. 5 Valven · blades  
valves · valvas · valve

18.744.17 ohne Valven · without blades · sans valves · sin valvas · senza valve

## Bauchdeckenhalter

Abdominal Retractors  
Ecarteurs abdominales  
Separadores abdominales  
Divaricatori addominali

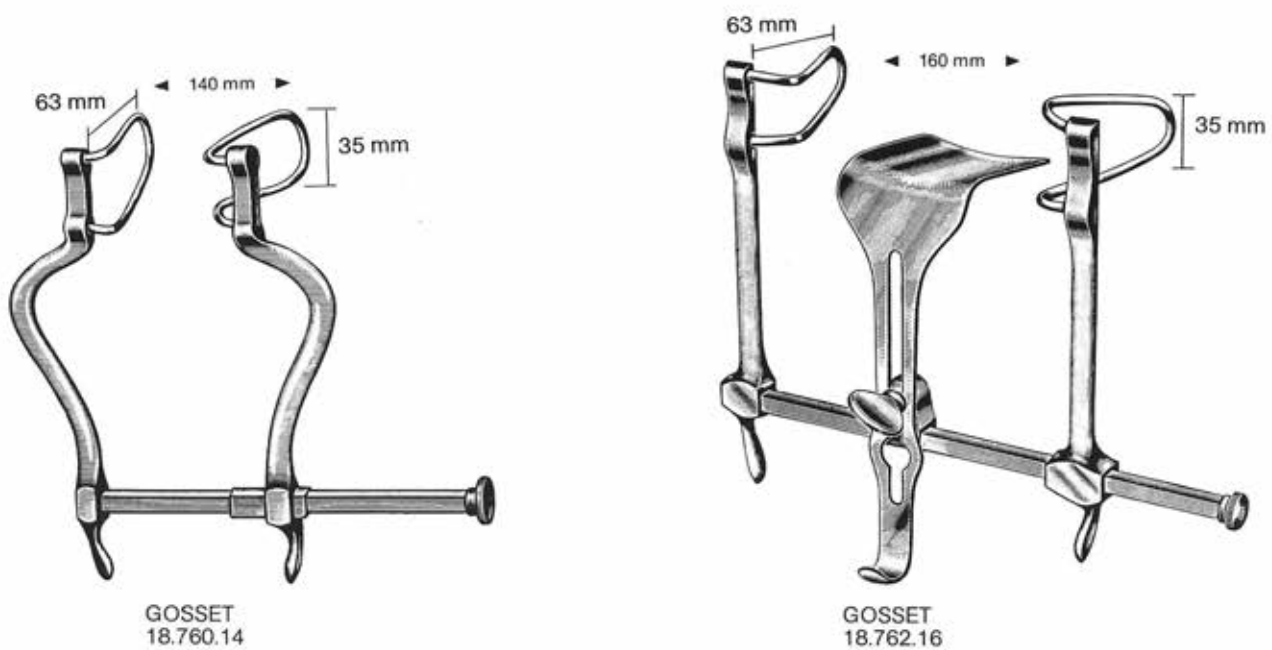
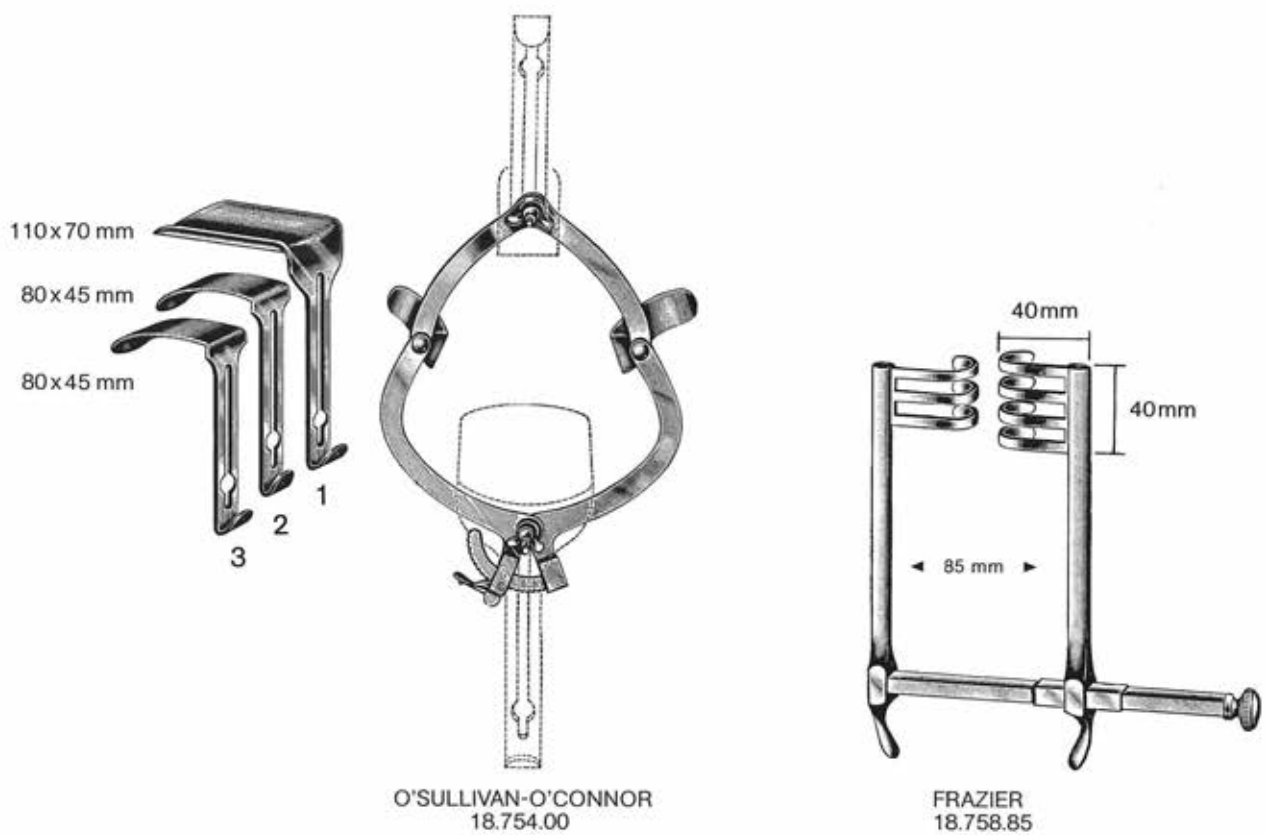

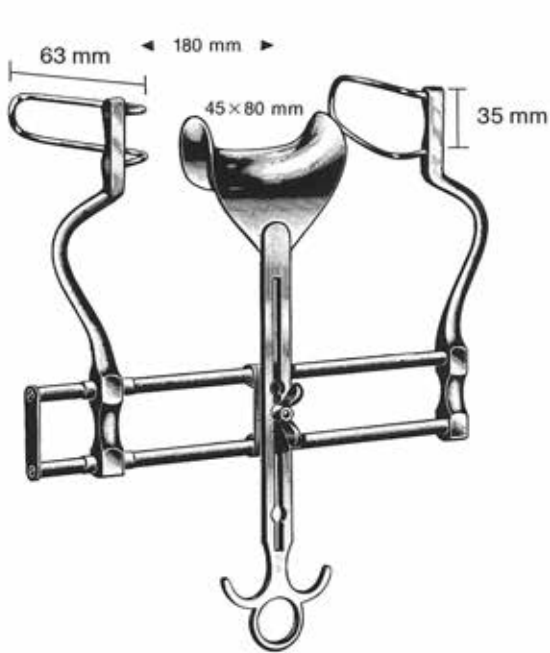

**BALFOUR**  
 18.764.18  
 18 cm

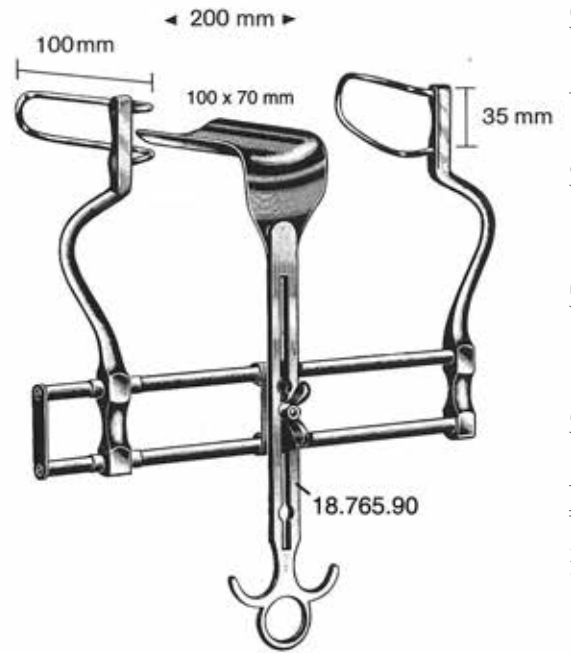

**BALFOUR**  
 18.765.90  
 20 cm

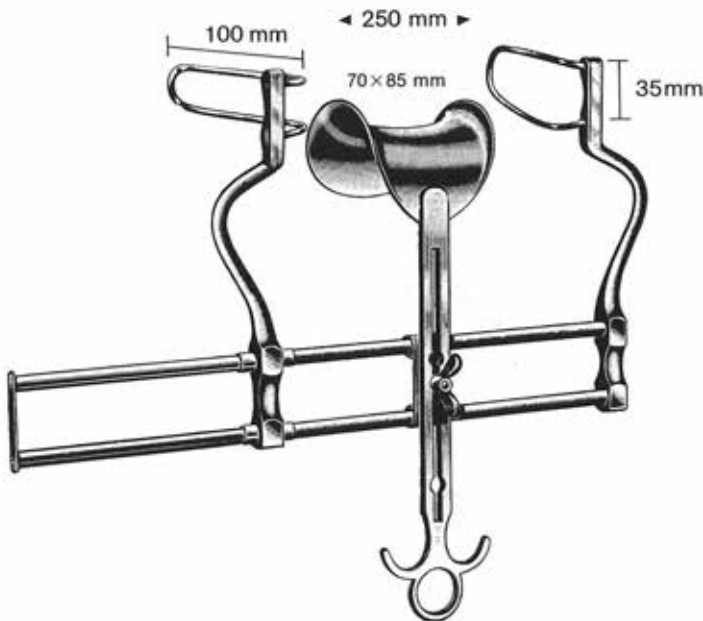

**BALFOUR**  
 18.764.25  
 25 cm

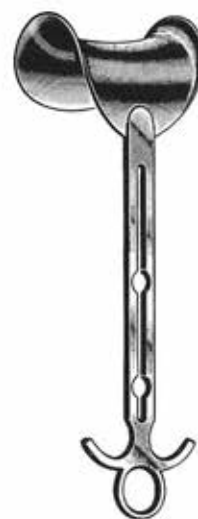

mm	BALFOUR
45 x 80	18.765.45
70 x 85	18.765.70
80 x 90	18.765.80

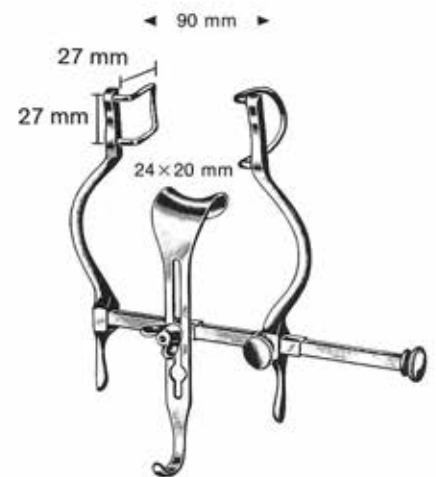

**BALFOUR Baby**  
 18.766.90  
 9 cm

## Bauchdeckenhalter

Abdominal Retractors  
Ecarteurs abdominales  
Separadores abdominales  
Divaricatori addominali

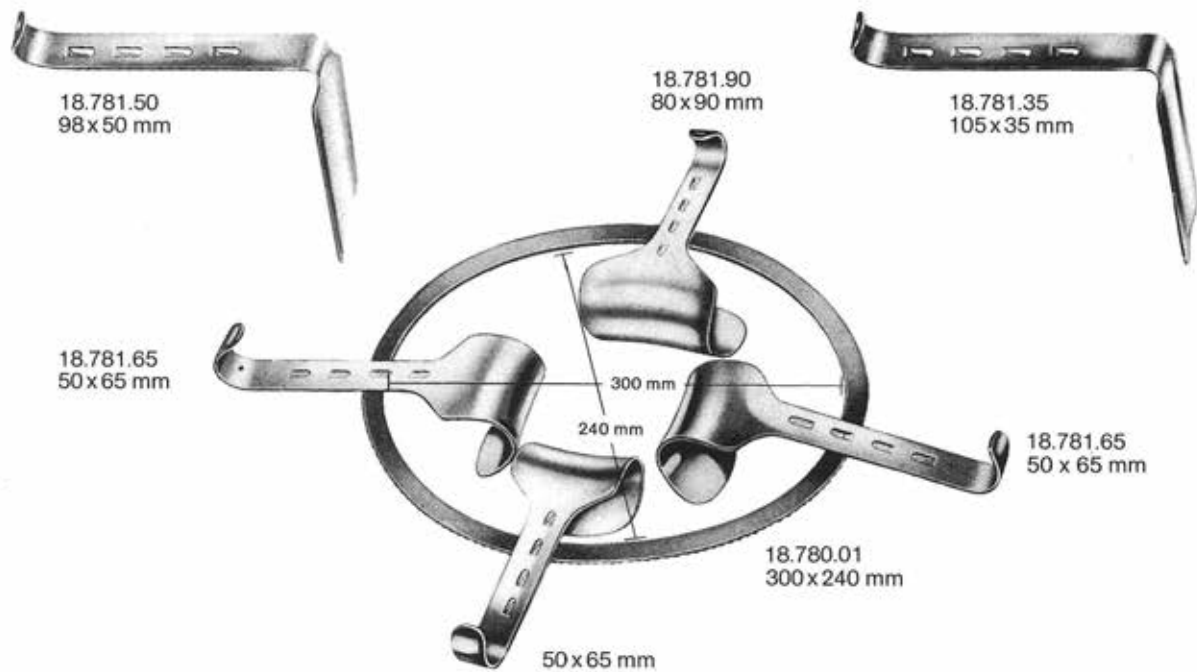

KIRSCHNER

18.780.00 compl.

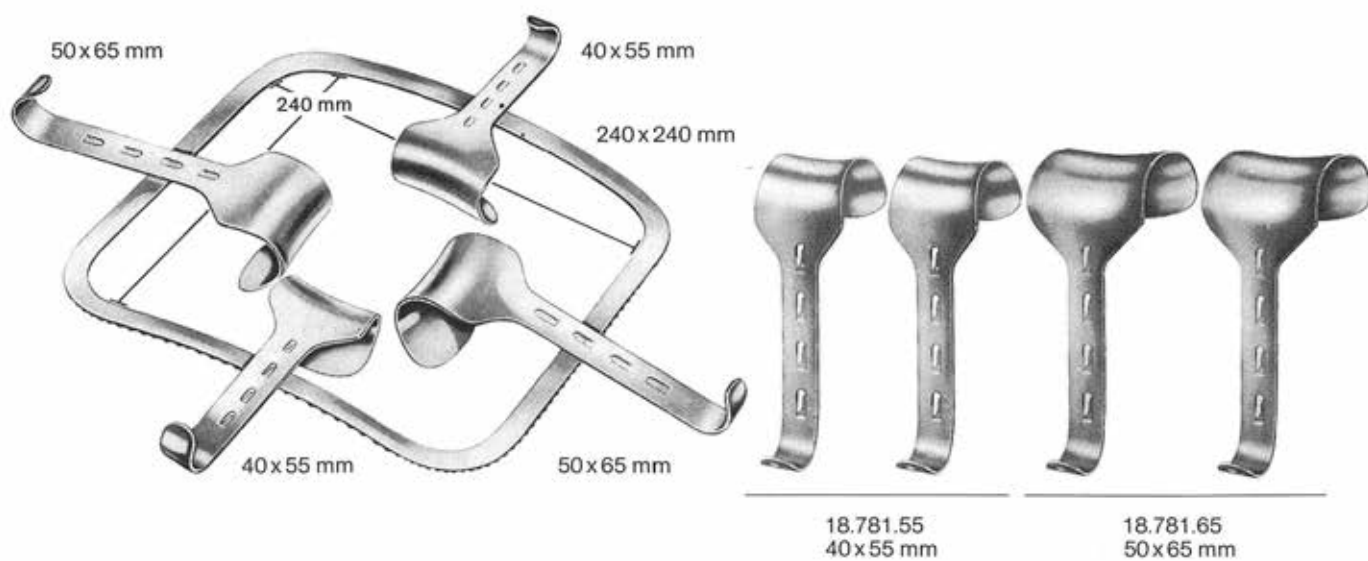

KIRSCHNER

18.782.00 compl.

**Bauchdeckenhalter**  
 Abdominal Retractors  
 Ecarteurs abdominales  
 Separadores abdominales  
 Divaricatori addominali



cm	GELPI
9	18.802.09
14	18.802.14
16	18.802.16
18	18.802.18



GELPI  
 18.804.18  
 18 cm

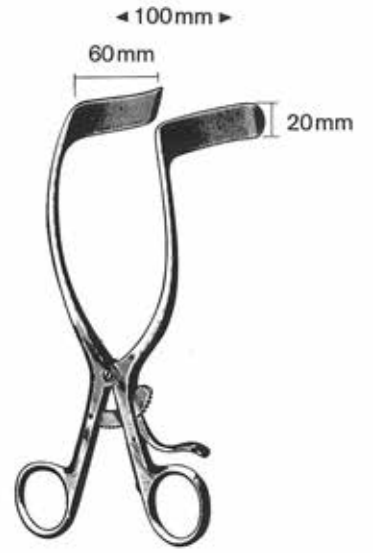

RIGBY  
 18.806.18  
 18 cm

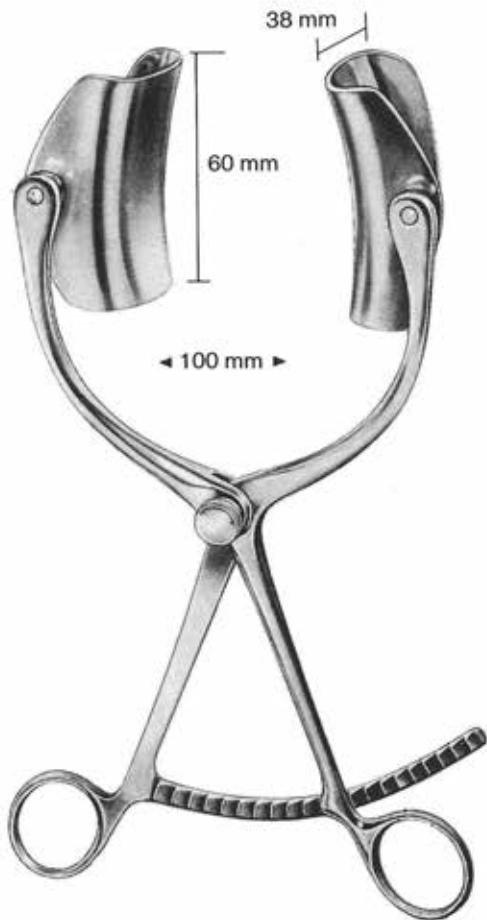

COLLIN  
 18.810.22



Central/mm	COLLIN
38x55	18.812.60
50x75	18.812.80

## Bauchdeckenhalter

Abdominal Retractors  
Ecarteurs abdominales  
Separadores abdominales  
Divaricatori addominali

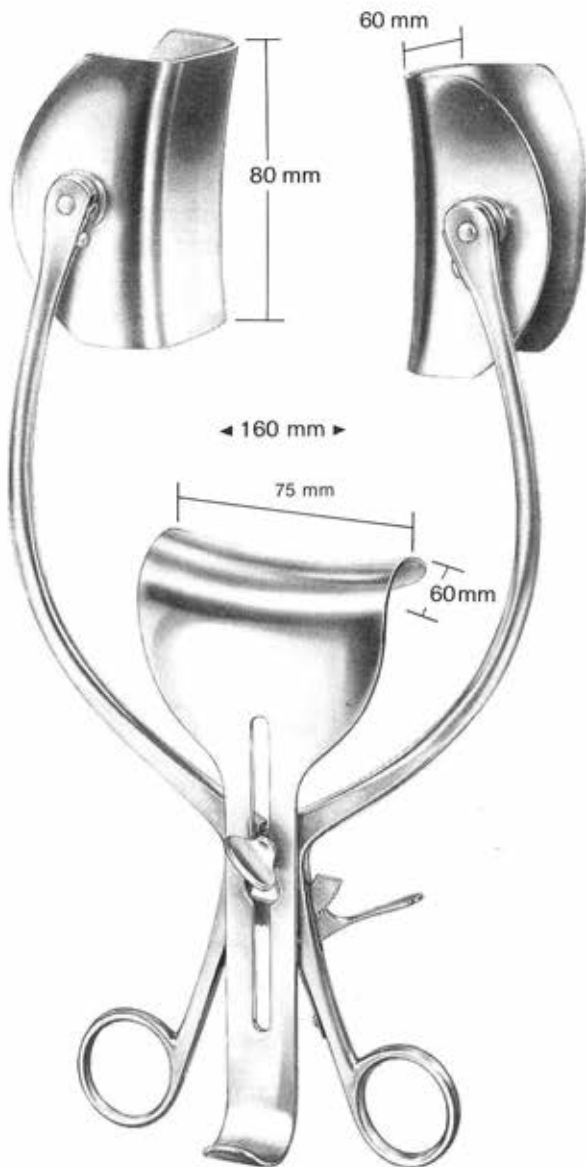

COLLIN Loktite  
18.816.00

Muskelhaken  
Muscle Retractors (Hooks)  
Ecarteurs musculaires  
Separadores (ganchos) musculares  
Divaricatori (unicini) muscolari



18.902.10  
10 cm



18.903.00





Sonden, Spatel, Watteträger  
Probes, Spatulas, Applicators  
Sondes, Spatules, porte-coton  
Sondas, Espátulas, porta-algodón  
Sonde, Spatole, portacotone

## Sonden

Probes, Directors  
Sondes, Stylets  
Sondas, estiletes  
Sonde, specilli

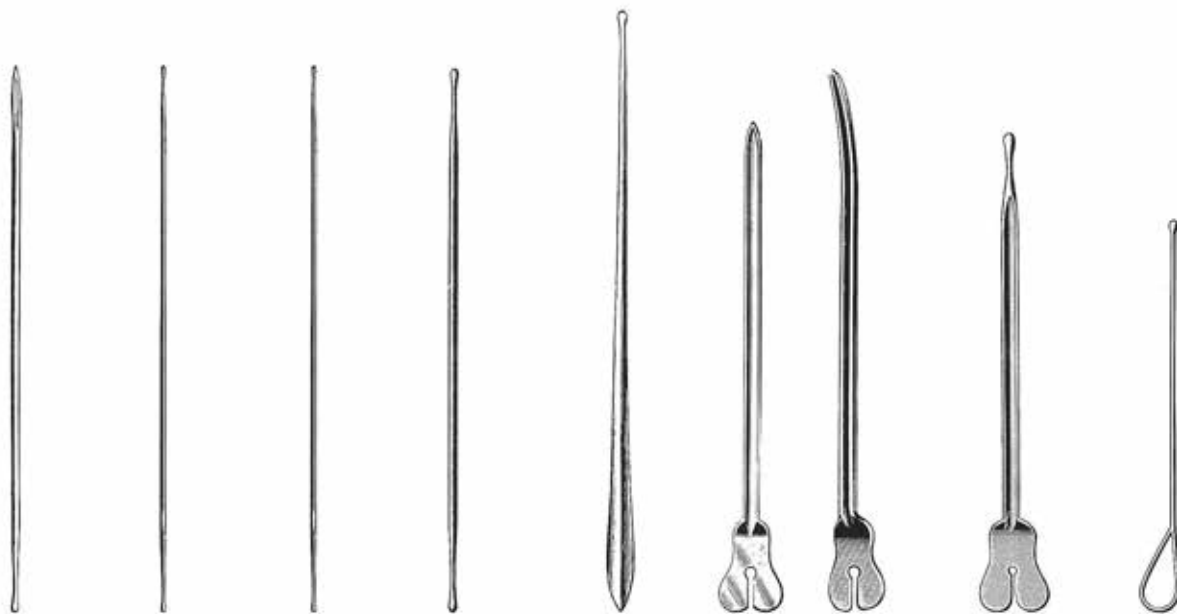

cm	2 mm Ø	1 mm Ø	1,5 mm Ø	2 mm Ø		DOYEN		STACKE
10,5					20.108.10			20.115.10
11,5	20.102.11	20.104.11	20.105.11	20.106.11		20.110.11		
13,0	20.102.13	20.104.13	20.105.13	20.106.13	20.108.13	20.110.13		20.112.13
14,0							20.111.14	
14,5	20.102.14	20.104.14	20.105.14	20.106.14	20.108.14	20.110.14		20.112.14
16,0	20.102.16	20.104.16	20.105.16	20.106.16	20.108.16	20.110.16		20.112.16
18,0	20.102.18	20.104.18	20.105.18	20.106.18	20.108.18	20.110.18		20.112.18
20,0	20.102.20	20.104.20	20.105.20	20.106.20	20.108.20	20.110.20		
25,0	20.102.25	20.104.25	20.105.25	20.106.25				

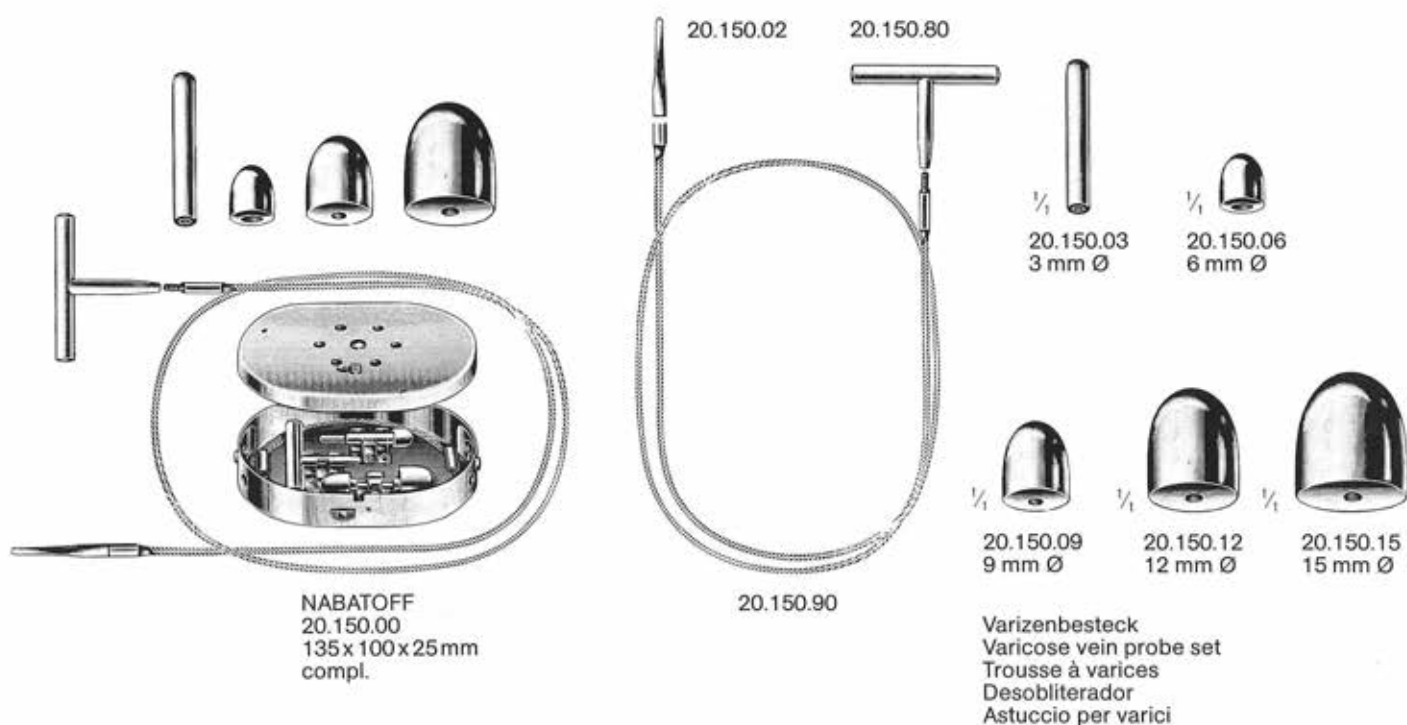



### Spatel, Watteträger

Spatulas, Cotton-Applicators  
 Spatules, porte-coton  
 Espátulas, porta-algodón  
 Spatole, portacotone

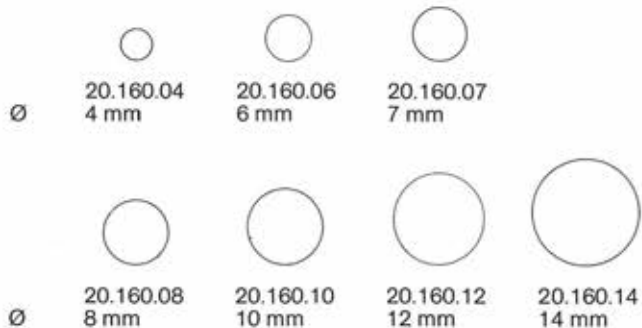

Pflasterspatel  
 Plaster spatula  
 Spatules  
 Espátulas  
 Spatole



cm	
13,0	20.190.13
14,5	20.190.14

cm	FARRELL	FARRELL	DIMEDA	UCKERMANN	JOBSON-HORNE	JOBSON-HORNE	JOBSON-HORNE
12,0	20.270.12	20.272.12	20.290.12	20.292.12		20.320.12	
14,0	20.270.14	20.272.14	20.290.14	20.292.14			
15,0					20.310.15		
16,0			20.290.16	20.292.16			
16,5	20.270.16	20.272.16					
18,0	20.270.18	20.272.18	20.290.18	20.292.18		20.320.18	
23,0	20.270.23	20.272.23					
25,0							
45,0							20.340.45

**Spritzen**  
Hypodermic Syringes  
Seringues  
Jeringas  
Siringhe

Glaszylinder mit Luer Ansatz  
Glass Barrel with Luer connection  
Cylindre en verre avec raccord Luer  
Cilindro de vidrio con conexión Luer  
Cilindro di vetro con raccordo Luer



1 ml	<b>20.500.01</b>
2 ml	<b>20.500.02</b>
5 ml	<b>20.500.05</b>
10 ml	<b>20.500.10</b>
20 ml	<b>20.500.20</b>
50 ml	<b>20.500.50</b>

Ersatzzylinder mit Luer Ansatz  
Spare Barrel with Luer connection  
Cylindres de rechange avec raccord Luer  
Cilindros de reposito con conexión Luer  
Cilindri di ricambio con raccordo Luer



1 ml	<b>20.501.01</b>
2 ml	<b>20.502.02</b>
5 ml	<b>20.502.05</b>
10 ml	<b>20.502.10</b>
20 ml	<b>20.502.20</b>
50 ml	<b>20.502.50</b>

Glaszylinder Luer-Lock Ansatz  
Glass Barrel Luer Lock connection  
Cylindre en verre avec raccord Luer-Lock  
Cilindro de vidrio conexión Luer-Lock  
Cilindro di vetro con raccordo Luer-Lock



<b>RECORD</b>	
1 ml	<b>20.510.01</b>
2 ml	<b>20.510.02</b>
5 ml	<b>20.510.05</b>
10 ml	<b>20.510.10</b>
20 ml	<b>20.510.20</b>
50 ml	<b>20.510.50</b>

Ersatzzylinder Luer-Lock Ansatz  
Spare Barrels Luer Lock connection  
Cylindres de rechange avec raccord Luer-Lock  
Cilindros de reposito conexión Luer-Lock  
Cilindri di ricambio con raccordo Luer-Lock



1 ml	<b>20.512.01</b>
2 ml	<b>20.512.02</b>
5 ml	<b>20.512.05</b>
10 ml	<b>20.512.10</b>
20 ml	<b>20.512.20</b>
50 ml	<b>20.512.50</b>



Trokare, Punktionsnadeln  
Trocars, Puncture Needles  
Trocarts, Aiguilles à ponction  
Trócares, Agujas para punción  
Trequarti, Aghi da punzione

## Trokare

Trocars  
Trocarts  
Trócares  
Trequarti

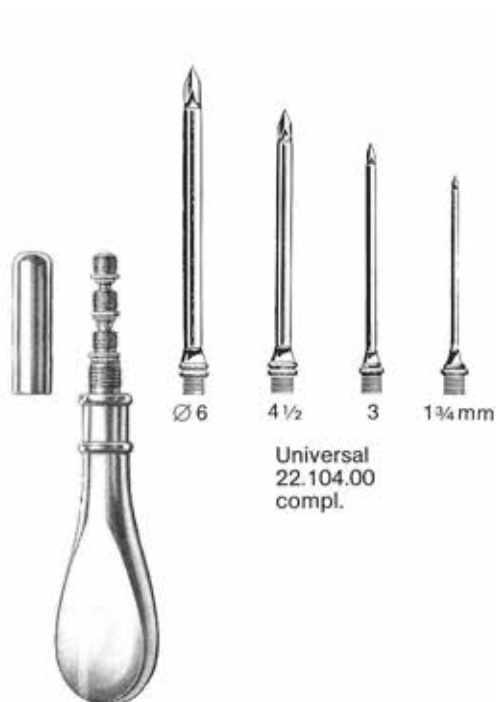

Universal  
22.104.00  
compl.

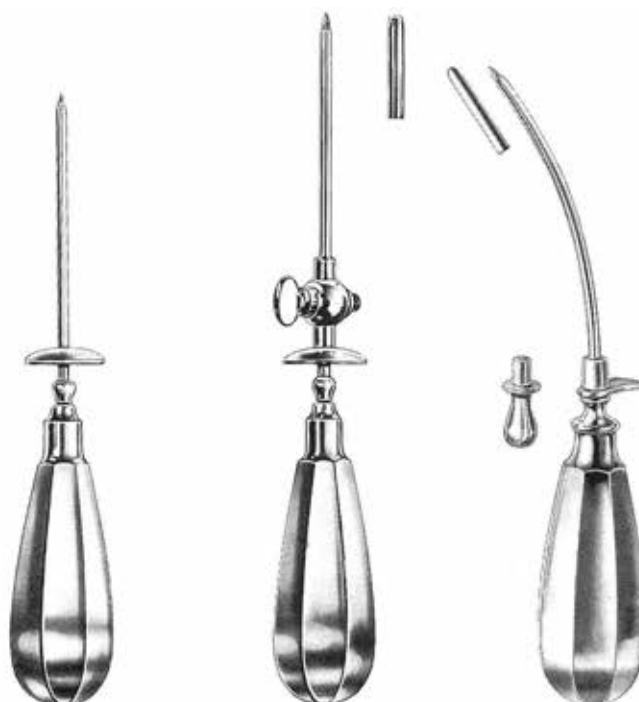

mm	Standard	Standard	PIERCE
3,0	22.110.30	22.120.30	22.123.30
3,5	22.110.35	22.120.35	
4,0	22.110.40	22.120.40	22.123.40
4,5	22.110.45	22.120.45	
5,0	22.110.50	22.120.50	22.123.50
5,5	22.110.55	22.120.55	
6,0	22.110.60	22.120.60	



DOUGLAS  
22.125.11  
3 mm Ø



FLEURANT  
22.127.23  
23 cm  
5 mm Ø



LICHTWITZ  
22.128.20  
1,70 mm Ø

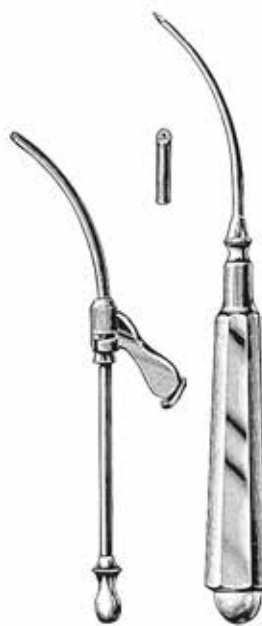

COAKLEY  
22.140.02  
2,25 mm Ø



Charr./ F.G.	OCHSNER
10	22.150.10
12	22.150.12
14	22.150.14
16	22.150.16
18	22.150.18
20	22.150.20



Charr./ F.G.	NELSON
25	22.170.25
30	22.170.30
33	22.170.33
35	22.170.35

## Trokare, Punktionsnadeln

Trocars, Puncture Needles  
Trocarts, Aiguilles à ponction  
Trócares, Agujas para punción  
Trequarti, Aghi da punzione

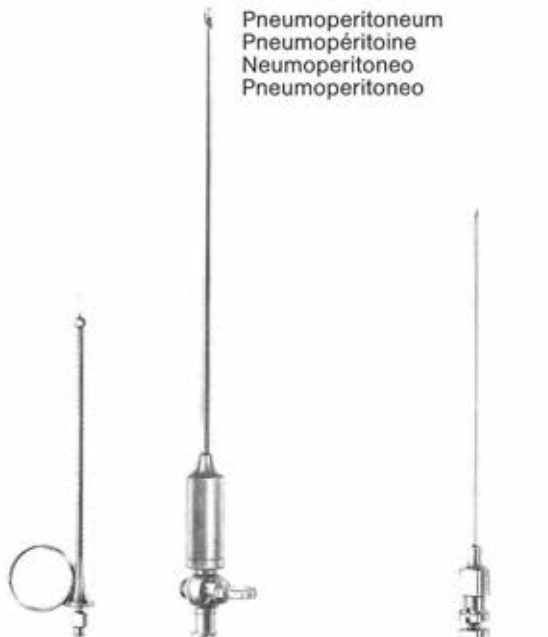

Pneumoperitoneum  
Pneumopéritoine  
Neumoperitoneo  
Pneumoperitoneo

22.210.00  
compl.

VERRES  
22.250.20  
2,0 x 100 mm

mm	QUINKE
1,2 x 76	22.230.12
1,2 x 89	22.232.12
1,0 x 76	22.230.10
1,0 x 89	22.232.10
0,7 x 76	22.230.07
0,7 x 89	22.232.07

Pudendus Anesthesia  
anesthesia

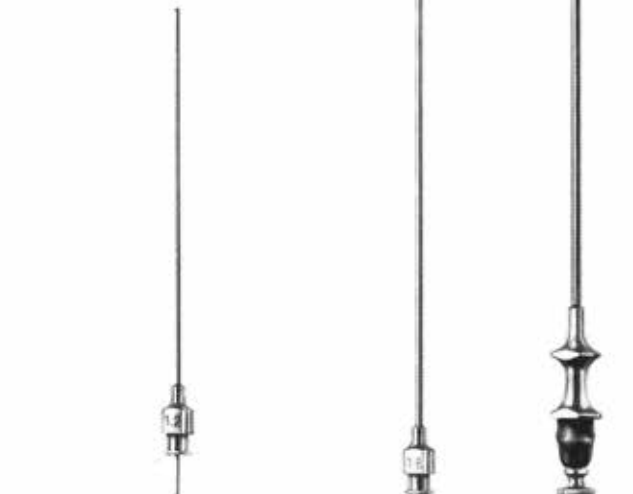

mm	MENGHINI
1,0 x 35	22.302.01
1,0 x 70	22.302.02
1,2 x 70	22.302.03
1,2 x 100	22.302.04
1,4 x 70	22.302.05
1,4 x 100	22.302.06
1,6 x 70	22.302.07
1,8 x 100	22.302.08

mm	MENGHINI	MENGHINI
1,4 x 168	22.310.14	22.312.14
1,8 x 168	22.310.18	22.312.18



Ø ext. x L. mm	Ø int. x L. mm	FRANKLIN-SILVERMANN
2,0 x 105	1,5 x 155	22.330.20
2,0 x 130	1,5 x 180	22.330.14
compl.		



A Ø x L. mm	B Ø x L. mm	A + B	B
2,0 x 100	1,5 x 150	22.350.20	22.352.15
2,5 x 145	2,0 x 195	22.350.30	22.352.20
2,0 x 100	1,5 x 150	22.354.20	22.356.15
2,5 x 145	2,0 x 195	22.354.25	22.356.20

## Führungsnadeln

Guide Needles  
Aiguilles d'introduction  
Agujas de guía  
Aghi conduttori



8 Charr.	<b>22.400.08</b>
10 Charr.	<b>22.400.10</b>
12 Charr.	<b>22.400.12</b>
14 Charr.	<b>22.400.14</b>
16 Charr.	<b>22.400.16</b>
18 Charr.	<b>22.400.18</b>

leicht gebogen,  
Messerschliff, mit Schraubgewinde

slightly curved,  
knife tip, threaded end

légèrement courbé,  
pointe affûtée, filetée

ligeramente curva,  
punta de cuchillo, roscada

leggermente curvo,  
filo da coltello, con filetto

REDON  
19,5 cm/7¾"

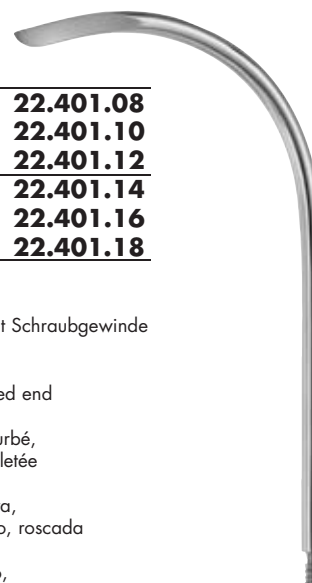

8 Charr.	<b>22.401.08</b>
10 Charr.	<b>22.401.10</b>
12 Charr.	<b>22.401.12</b>
14 Charr.	<b>22.401.14</b>
16 Charr.	<b>22.401.16</b>
18 Charr.	<b>22.401.18</b>

stark gebogen,  
Messerschliff, mit Schraubgewinde

fully curved,  
knife tip, threaded end

extrêmement courbé,  
pointe affûtée, filetée

fuertemente curva,  
punta de cuchillo, roscada

fortemente curvo,  
filo da coltello, con filetto

REDON  
19,5 cm/7¾"



8 Charr.	<b>22.402.08</b>
10 Charr.	<b>22.402.10</b>
12 Charr.	<b>22.402.12</b>
14 Charr.	<b>22.402.14</b>
16 Charr.	<b>22.402.16</b>
18 Charr.	<b>22.402.18</b>

leicht gebogen,  
Dreikantspitze, mit Schraubgewinde

slightly curved,  
trocar tip, threaded end

légèrement courbé,  
pointe à trocart, filetée

ligeramente curva,  
punta de trocart, roscada

leggermente curvo,  
punta da trequarti, con filetto

REDON  
19,5 cm/7¾"

8 Charr.	<b>22.403.08</b>
10 Charr.	<b>22.403.10</b>
12 Charr.	<b>22.403.12</b>
14 Charr.	<b>22.403.14</b>
16 Charr.	<b>22.403.16</b>
18 Charr.	<b>22.403.18</b>

leicht gebogen,  
Lanzettspitze, mit Schraubgewinde

slightly curved,  
lancet tip, threaded end

légèrement courbé,  
pointe à lancette, filetée

ligeramente curva,  
punta de lanceta, roscada

leggermente curvo,  
filo da lancetta, con filetto

REDON  
19,5 cm/7¾"



Nadelhalter  
Needle Holders  
Porte-aiguilles  
Porta-agujas  
Port'aghi



**Nadelhalter**  
 Needle Holders  
 Porte-aiguilles  
 Porta-agujas  
 Port'aghi



DERF  
 24.110.12 12 cm 24.114.12

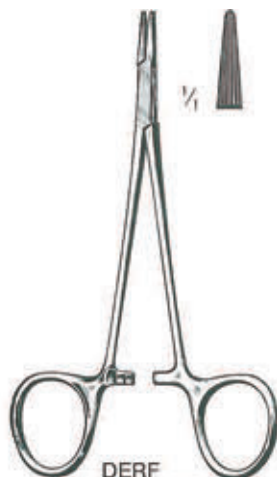

DERF  
 24.120.12  
 12,5 cm

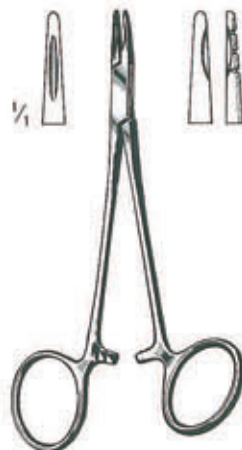

NEIVERT  
 24.146.13



BAUMGARTNER  
 24.150.12 12,5 cm 24.154.12  
 24.150.14 14,0 cm 24.154.14



COLLIER  
 24.122.12  
 12,5 cm

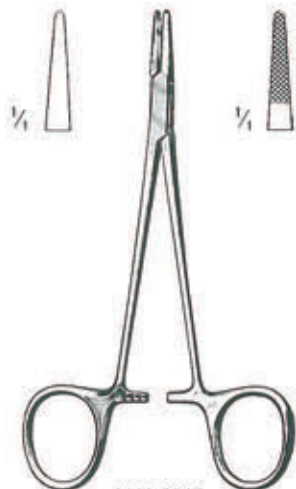

HALSEY  
 24.130.13 13 cm 24.140.13  
 24.134.13 13 cm 24.144.13

Mit TC-Einsätzen  
 TC Lined  
 A mors TC  
 Con bocas TC  
 Con morso TC



CRILE-WOOD  
 24.160.15 15 cm 24.164.15  
 24.160.18 18 cm 24.164.18  
 24.160.20 20 cm 24.164.20



CRILE-MURRAY  
 24.170.15 15 cm 24.174.15

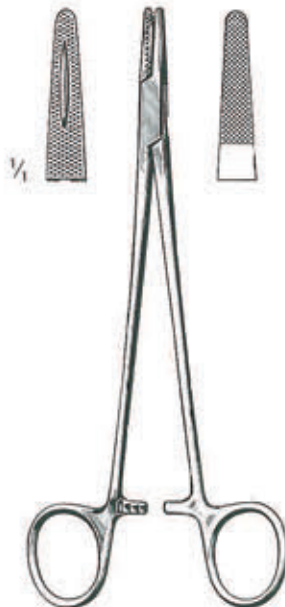

MAYO-HEGAR  
 24.180.14 14 cm 24.184.14  
 24.180.16 16 cm 24.184.16  
 24.180.18 18 cm 24.184.18  
 24.180.20 20 cm 24.184.20  
 24.180.24 24 cm 24.184.24  
 24.180.26 26 cm 24.184.26  
 24.180.30 30 cm 24.184.30



MAYO-HEGAR  
 24.190.16 16 cm 24.194.16  
 24.190.18 18 cm 24.194.18  
 24.190.20 20 cm 24.194.20



**Nadelhalter**  
Needle Holders  
Porte-aiguilles  
Porta-agujas  
Port'aghi

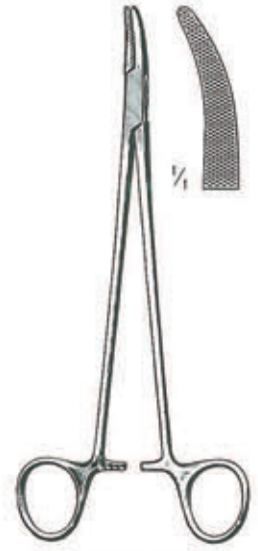

cm	DE BAKEY	RYDER
13		24.224.13
15	24.214.15	24.224.15
18	24.214.18	24.224.18
20	24.214.20	24.224.20
23	24.214.23	24.224.23
26	24.214.26	24.224.26
31	24.214.31	
37	24.214.37	

JAMISON  
24.230.23 23,5cm 24.234.23

HEANEY  
24.241.21 21cm 24.245.21

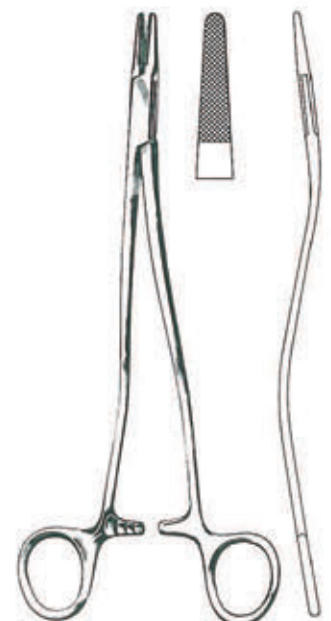
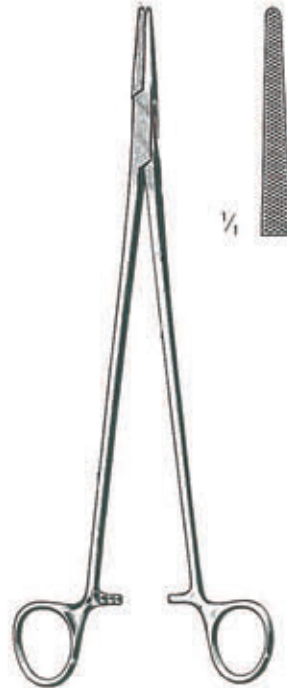

MASSON  
24.250.27 27 cm 24.254.27

WANGENSTEEN  
24.260.27 27 cm 24.264.27

WANGENSTEEN  
24.270.27 27 cm 24.274.27

BOZEMANN  
20 24.285.20  
24 24.285.24  
26 24.285.26

**Nadelhalter**  
 Needle Holders  
 Porte-aiguilles  
 Porta-agujas  
 Port'aghi



**METZENBAUM**  
 24.290.18  
 18 cm



**ADSON**  
 24.292.18  
 18 cm

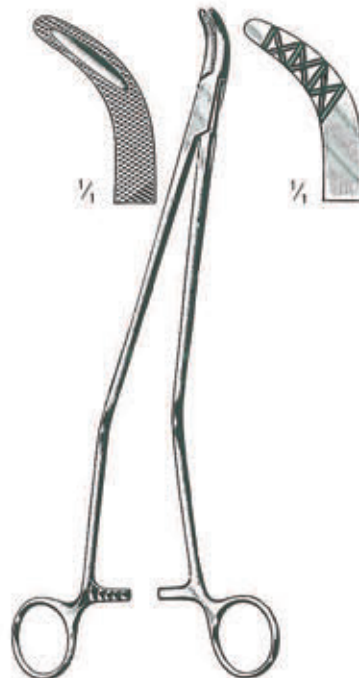

**JOHNSON**  
 24.293.27  
 27 cm



**FINOCHIETTO**  
 24.311.20 20 cm 24.315.20  
 24.311.27 27 cm 24.315.27

Mit TC-Einsätzen  
 TC Lined  
 A mors TC  
 Con bocas TC  
 Con morso TC



**SAROT**  
 24.320.18 18 cm 24.324.18  
 24.320.26 26 cm 24.324.26

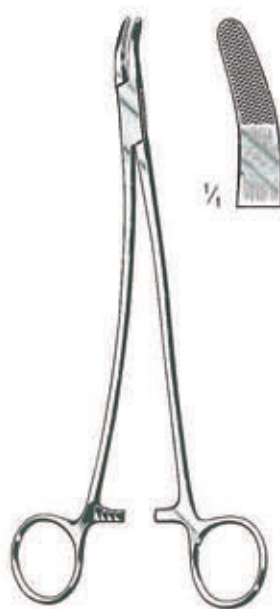

**STRATTE**  
 24.330.23 23 cm 24.334.23



**CRILE**  
 24.350.15  
 15 cm



**TOENNIS**  
 24.360.18 18cm 24.364.18

**Nadelhalter**  
Needle Holders  
Porte-aiguilles  
Porta-agujas  
Port'aghi



**HOESEL**  
24.366.25  
25 cm



cm	MATHIEU		MATHIEU		MATHIEU	
14	24.370.14	24.374.14			24.390.14	24.394.14
17	24.370.17	24.374.17	24.380.17	24.384.17	24.390.17	24.394.17
20	24.370.20	24.374.20	24.380.20	24.384.20		
24	24.370.24	24.374.24				



**OLSEN-HEGAR**

24.410.14	14 cm	24.414.14
24.410.18	18 cm	24.414.18



**OLSEN-HEGAR**

24.420.17	17 cm	24.424.17
-----------	-------	-----------



**GILLIES**

24.430.16	16 cm	24.434.16
-----------	-------	-----------





## Mikro-Nadelhalter

Micro Needle Holders

Micro Porte-aiguilles

Micro Porta-agujas

Micro Port'aghi

Gefäß-Chirurgie  
Vascular surgery  
Chirurgie vasculaire  
Cirugia vascular  
Chirurgia vascolare



Mit TC-Einsätzen  
TC Lined  
A mors TC  
Con bocas TC  
Con morso TC

cm	DIETRICH
16	24.444.16
18	24.444.18
20	24.444.20
23	24.444.23
26	24.444.26

Ophthalmologie  
Ophthalmology  
Ophtalmologie  
Oftalmologia  
Oftalmologia



STEVENS  
24.610.11  
11 cm



cm	STEVENS
13	24.612.13
15	24.612.15



BOYNTON  
24.614.12  
12 cm



cm	ARRUGA
24.620.16	16 cm
24.624.16	

**Mikro-Nadelhalter**

Micro Needle Holders

Micro Porte-aiguilles

Micro Porta-agujas

Micro Port'aghi



**KALT-ARRUGA**  
24.627.14  
14 cm



**KALT**  
24.628.14  
**24.632.14**  
14 cm



**BARRAQUER**  
24.650.10  
10 cm



**BARRAQUER**  
24.651.10  
10 cm



**BARRAQUER**  
24.661.13 13 cm **24.665.13**



**CASTROVIEJO**  
24.670.14 14 cm 24.671.14  
**24.674.14** 14 cm **24.675.14**



**CASTROVIEJO**  
24.680.13 13 cm **24.684.13**

## Mikro-Nadelhalter

Micro Needle Holders

Micro Porte-aiguilles

Micro Porta-agujas

Micro Port'aghi

diamantiertes Maul  
diamond-coated jaw  
mors diamanté  
boca diamantada  
morso diamantato



Streamlined

mit Sperre  
with catch  
avec le blocage  
con cerradura  
con serratura

ohne Sperre  
without catch  
sans le blocage  
sin cerradura  
senza serratura



11 x 0,8 mm

11 x 0,8 mm

11 x 0,8 mm

11 x 0,8 mm

15 cm/6"	<b>24.920.15</b>	<b>24.921.15</b>	<b>24.922.15</b>	<b>24.923.15</b>
18 cm/7"	<b>24.920.18</b>	<b>24.921.18</b>	<b>24.922.18</b>	<b>24.923.18</b>
21 cm/8¼"	<b>24.920.21</b>	<b>24.921.21</b>	<b>24.922.21</b>	<b>24.923.21</b>

Titan  
Titanium  
Titane  
Titanio  
Titanio

11 x 1,2 mm

11 x 1,2 mm

11 x 1,2 mm

11 x 1,2 mm

21 cm/8¼"	<b>24.924.21</b>	<b>24.925.21</b>	<b>24.926.21</b>	<b>24.927.21</b>
-----------	------------------	------------------	------------------	------------------



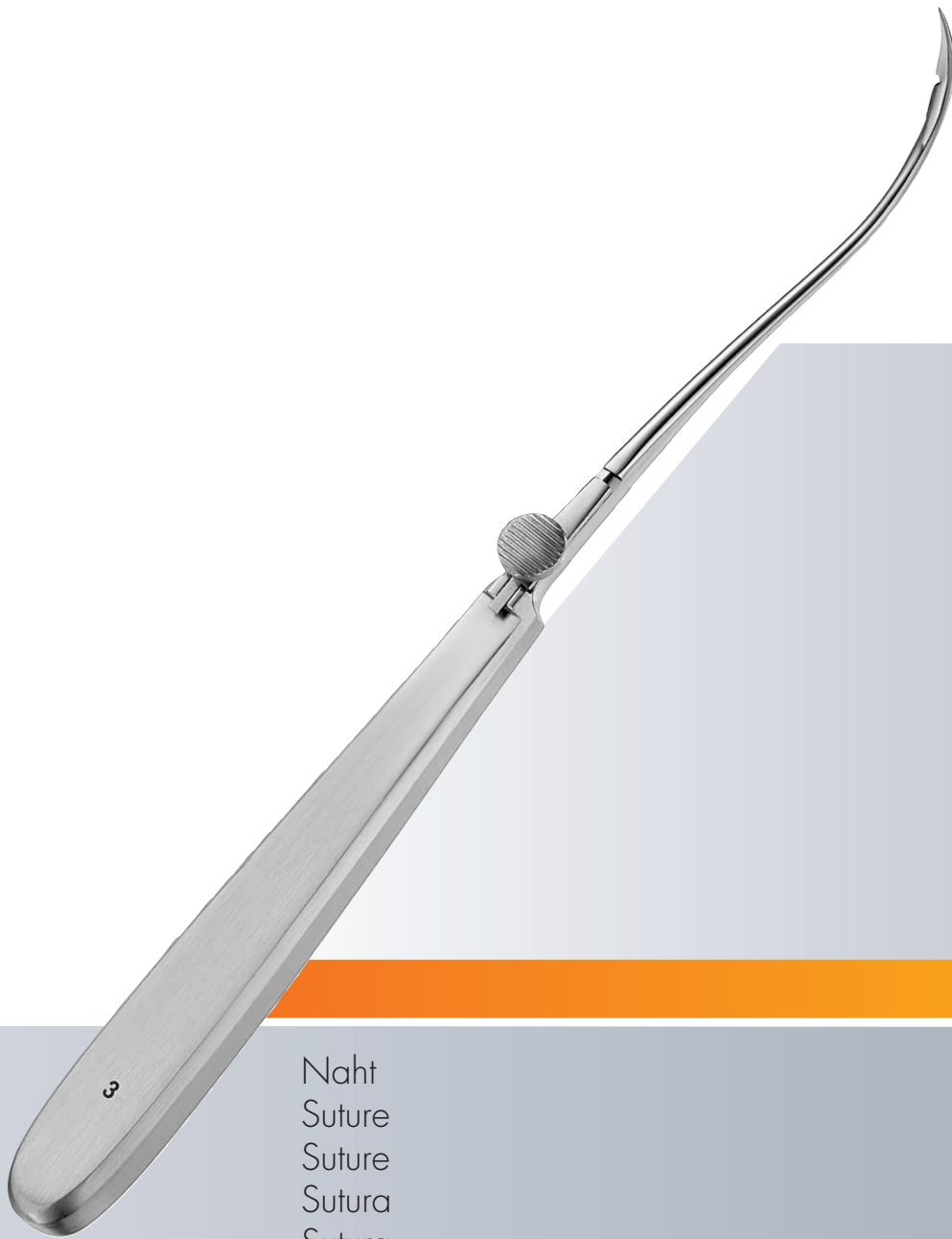

Naht  
Suture  
Suture  
Sutura  
Sutura

## Unterbindungsnadeln

Ligature Needles  
Aiguilles à ligatures  
Agujas para ligaduras  
Aghi per legature

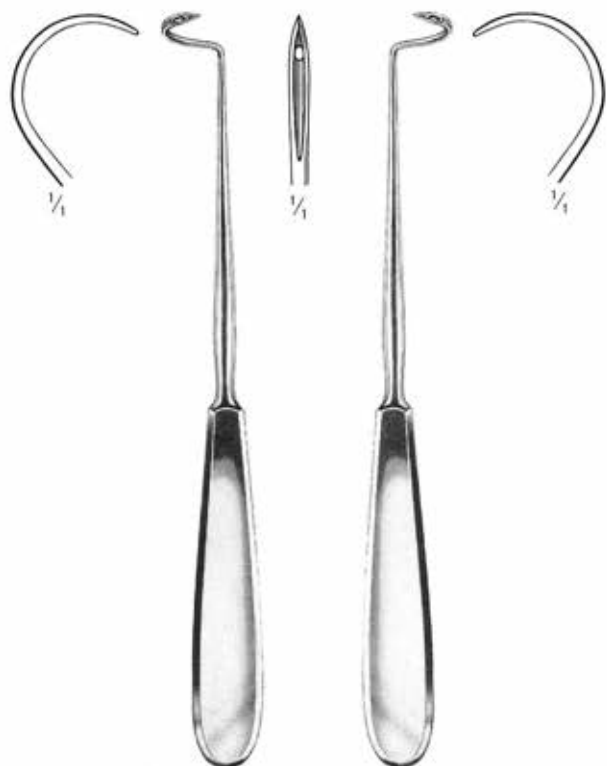

R	DESCHAMPS	L
26.110.21	21 cm	26.111.21
26.110.24	24 cm	26.111.24
26.110.27	27 cm	26.111.27

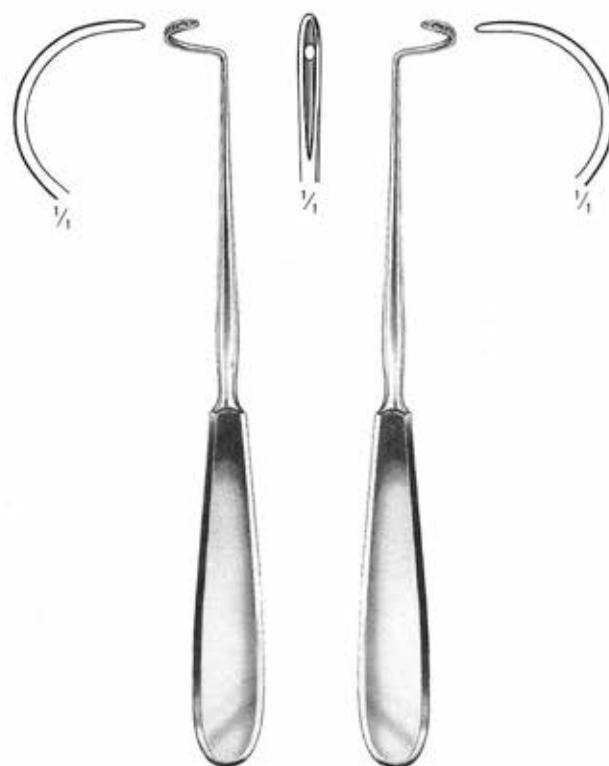

R	DESCHAMPS	L
26.120.21	21 cm	26.121.21
26.120.24	24 cm	26.121.24
26.120.27	27 cm	26.121.27

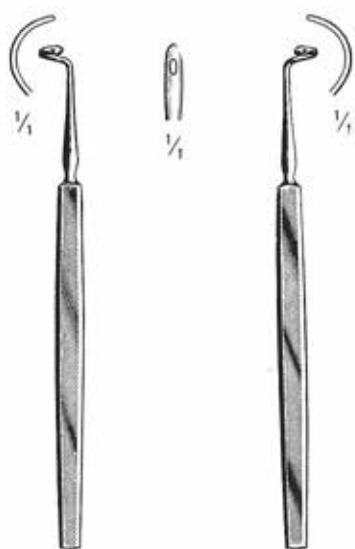

R	KRONECKER	L
26.130.13	13 cm	26.131.13

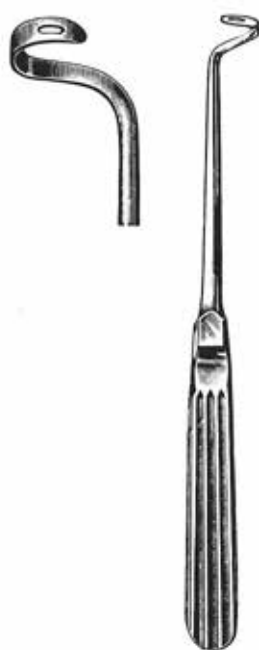

R	NELSON	L
26.133.24	24,5 cm	26.135.24

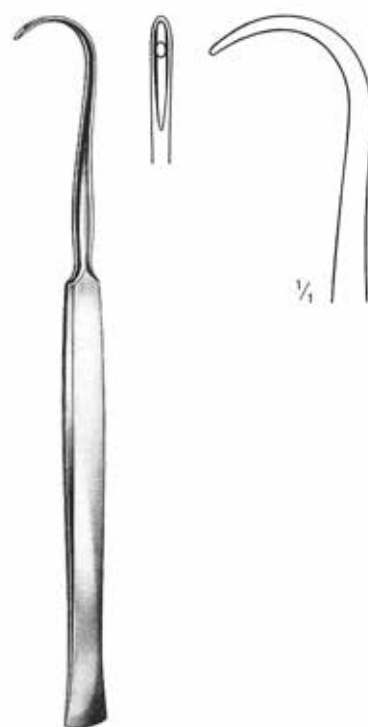

R	COOPER
26.139.19	19 cm



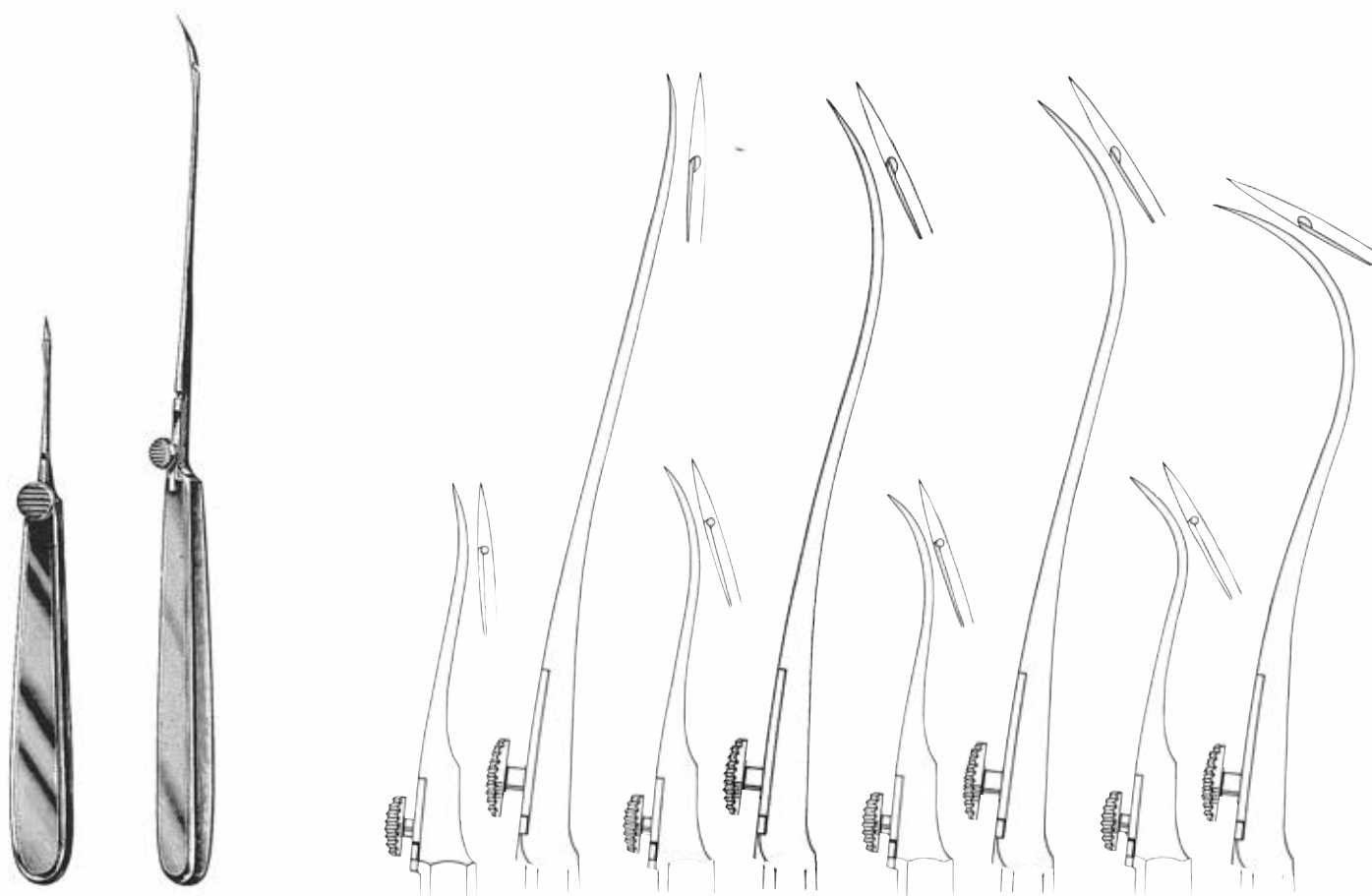

REVERDIN	cm	Fig. 1	Fig. 2	Fig. 3	Fig. 4
26.201.15-26.204.23	15	26.201.15	26.202.15	26.203.15	26.204.15
	19	26.201.19	26.202.19	26.203.19	26.204.19
	21	26.201.21	26.202.21	26.203.21	26.204.21
	23	26.201.23	26.202.23	26.203.23	26.204.23



**YOUNG Boomerang**  
 26.240.00  
 25 cm



Fig. 1  
 26.240.01



Fig. 2  
 26.240.02



Fig. 3  
 26.240.03

## Führungs-Hohlsonden

Ligature Conductors  
 Sondes conductrices  
 Sondas conductoras  
 Sonde conduttrici

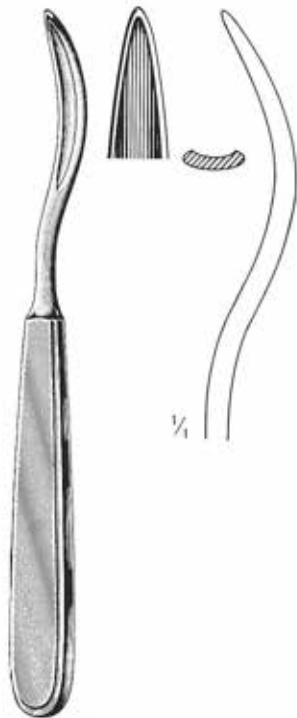

SCHMIEDEN  
 26.271.19  
 19 cm



SCHMIEDEN-PAYR  
 26.273.19  
 19 cm



BRUNNER  
 26.275.30  
 30 cm

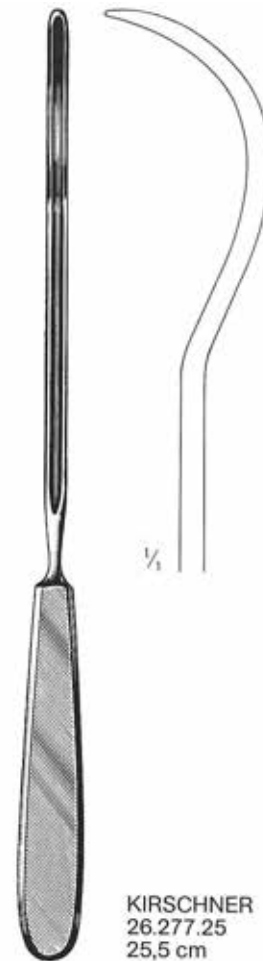

KIRSCHNER  
 26.277.25  
 25,5 cm



KOENIG  
 26.285.20  
 20 cm



PAYR  
 26.288.22  
 22 cm

PAYR  
 26.289.22  
 22 cm



Plastik  
 from plastic material  
 matière plastique  
 de materia plástica  
 in plastica

cm	BRUNNER
18	26.291.18
27	26.291.27

**Nähnadeln**

Suturing Needles  
Aiguilles à sutures  
Agujas para suturas  
Aghi per suture

In Packungen zu 1 Dutzend  
in packages of 1 dozen  
en enveloppes de 1 douzaine  
en sobres de 1 dozena  
bustine di 1 dozzina

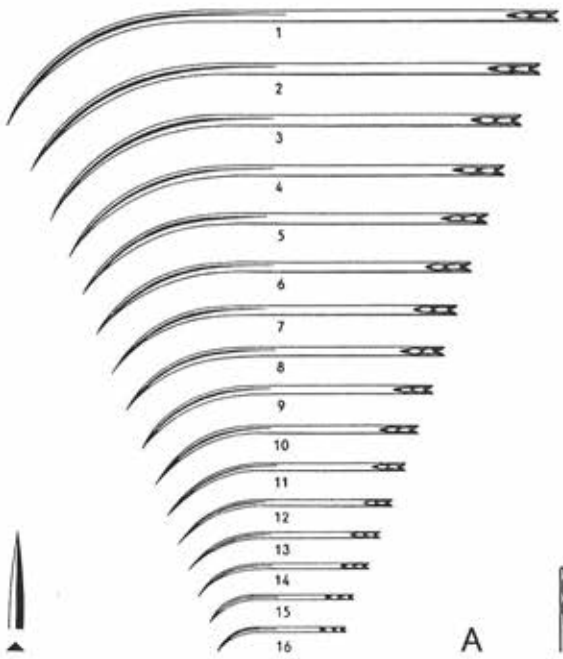

26.403.01 - 26.403.16

A

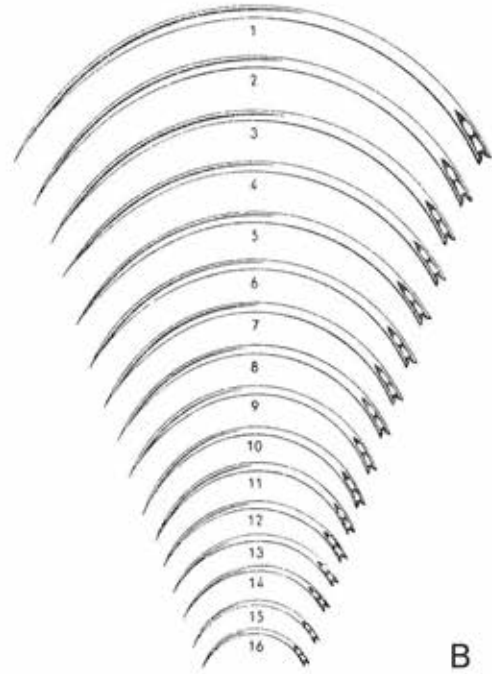

26.413.01 - 26.413.16

B

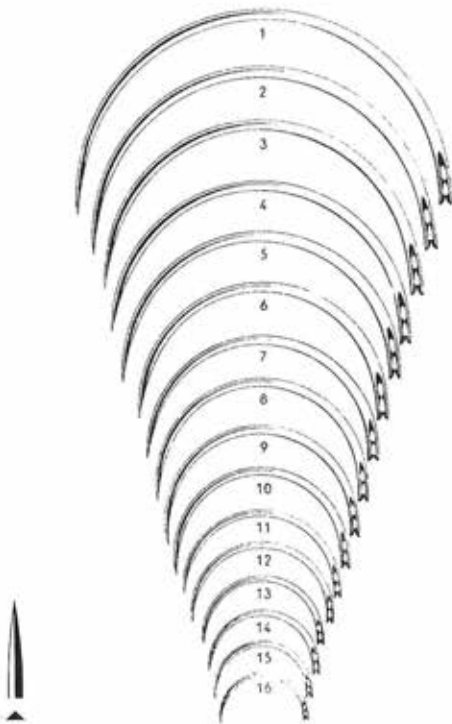

26.423.01 - 26.423.16

G

Alle Nadeln mit Federöhr  
all the needles with spring eye  
toutes les aiguilles à chas à ressort  
todas las agujas con ojo de resorte  
tutti gli aghi con cruna aperta

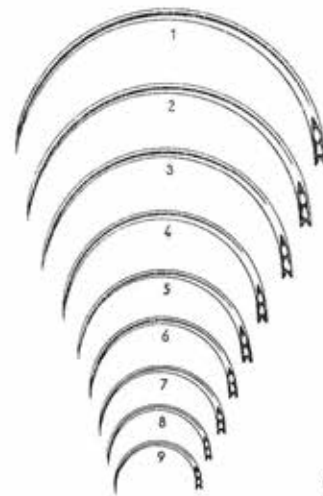

26.433.01 - 26.433.09

Ga

Fig.	1	2	3	4	5	6	7	8	9	10	11	12	13	14	15	16
A	26.403.01	26.403.02	26.403.03	26.403.04	26.403.05	26.403.06	26.403.07	26.403.08	26.403.09	26.403.10	26.403.11	26.403.12	26.403.13	26.403.14	26.403.15	26.403.16
B	26.413.01	26.413.02	26.413.03	26.413.04	26.413.05	26.413.06	26.413.07	26.413.08	26.413.09	26.413.10	26.413.11	26.413.12	26.413.13	26.413.14	26.413.15	26.413.16
G	26.423.01	26.423.02	26.423.03	26.423.04	26.423.05	26.423.06	26.423.07	26.423.08	26.423.09	26.423.10	26.423.11	26.423.12	26.423.13	26.423.14	26.423.15	26.423.16
Ga	26.433.01	26.433.02	26.433.03	26.433.04	26.433.05	26.433.06	26.433.07	26.433.08	26.433.09							

**Nähnadeln**  
 Suturing Needles  
 Aiguilles à sutures  
 Agujas para suturas  
 Aghi per suture

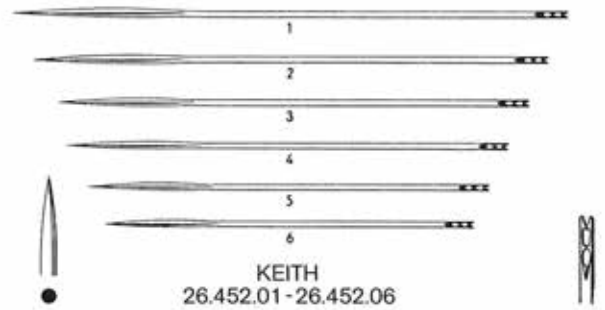
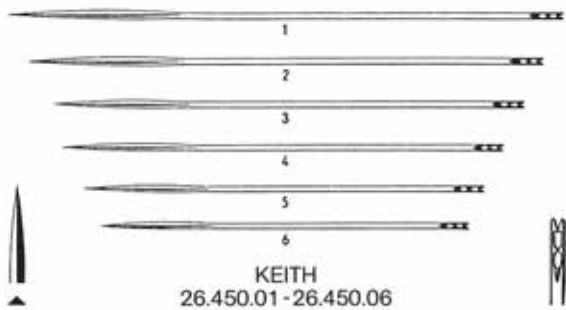
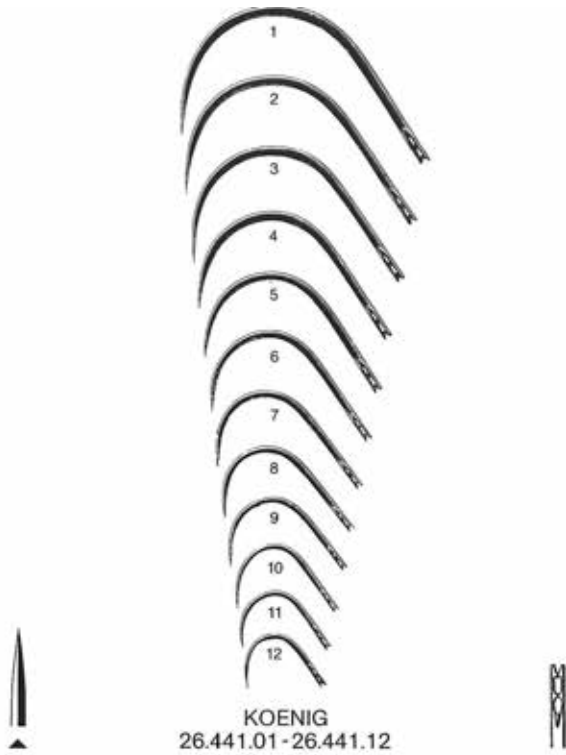

Alle Nadeln mit Federrohr  
 all the needles with spring eye  
 toutes les aiguilles à chas à ressort  
 todas las agujas con ojo de resorte  
 tutti gli aghi con cruna aperta

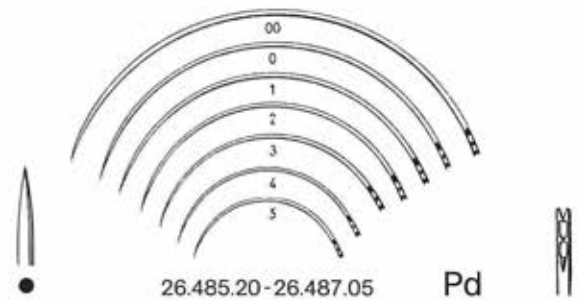
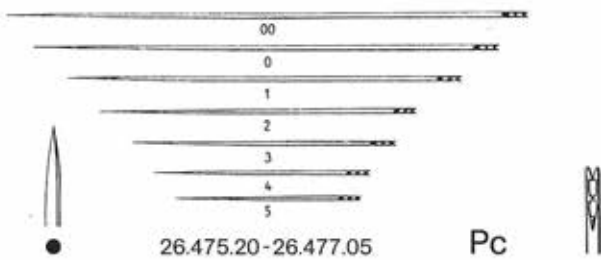
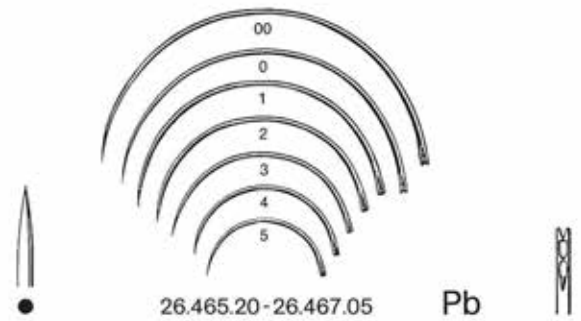

Fig.	000	00	0	1	2	3	4	5	6	7	8	9	10	11	12
KOENIG				26.441.01	26.441.02	26.441.03	26.441.04	26.441.05	26.441.06	26.441.07	26.441.08	26.441.09	26.441.10	26.441.11	26.441.12
E	26.443.30	26.443.20	26.443.10	26.443.01	26.443.02	26.443.03	26.443.04	26.443.05							
KEITH				26.450.01	26.450.02	26.450.03	26.450.04	26.450.05	26.450.06						
KEITH				26.452.01	26.452.02	26.452.03	26.452.04	26.452.05	26.452.06						
Pb				26.465.20	26.465.10	26.467.01	26.467.02	26.467.03	26.467.04	26.467.05	26.467.06	26.467.07	26.467.08		
Pc				26.475.20	26.475.10	26.477.01	26.477.02	26.477.03	26.477.04	26.477.05					
Pd				26.485.20	26.485.10	26.487.01	26.487.02	26.487.03	26.487.04	26.487.05					



## Wundklammern,-instrumente

Clips and Instruments  
Agrafes et instruments  
Agrafes e instrumentos  
Agrafes e strumenti



MICHEL  
26.610.12  
12 cm



WACHENFELDT  
26.612.12  
12,5 cm



WACHENFELDT  
26.614.12  
12,5 cm



HEGENBARTH  
26.616.12  
12,5 cm



CHILDE  
26.620.18  
18 cm



MICHEL  
26.630.12  
12 cm



MICHEL  
26.631.13  
13 cm

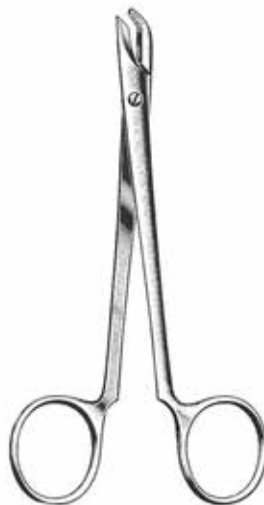

COLLIN  
26.640.13  
13 cm



RICHTER-HEATH  
26.642.14  
14 cm



MICHEL

	mm
26.660.07	7,5x1,75
26.660.11	11x2
26.660.12	12x3
26.660.14	14x3
26.660.16	16x3
26.660.18	18x3
26.660.20	20x3
26.660.22	22x3

### **Taschen-, Nahtbesteck**

Pocket, Suturing Kits

Trousses à poche et à suture

Estuche de bolsillo y de sutura

Astucci tascabili e per sutura

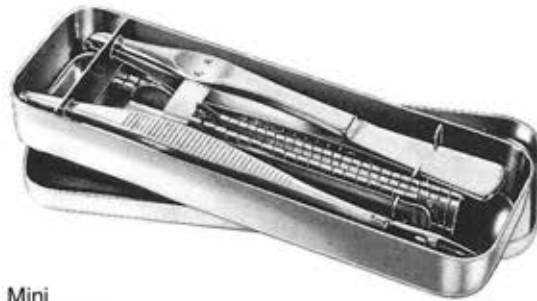

Mini  
26.670.00  
130x45x18 mm



Standard  
26.680.00  
165x90x28 mm



Sterilisierhilfen  
Sterilizing Aids  
Instrumente pour Sterilisation  
Auxilios para la esterilización  
Utensili per las sterilizzazione

## Sterilisationsinstrumente

Sterilization Instruments

Instrumenti à stérilisation

Instrumentos para esterilización

Strumenti per la sterilizzazione



DAVIS  
16,0 cm **28.102.16**  
20,0 cm **28.102.20**  
24,0 cm **28.102.24**



CHEATE  
**28.110.27**  
27,0 cm



Universal  
**28.120.20** 20,0 cm **28.121.20**  
**28.120.28** 28,0 cm **28.121.28**



ROGGE  
**28.130.23**  
23,0 cm



20,0 cm **28.140.20**  
30,0 cm **28.140.30**



BUNT  
**28.150.12**  
12,0 cm



MAYO  
**28.152.14**  
14,0 cm



## Abfallzangen

Waste Bucket

Pinces pour déchets

Pinzas para desechos

Pinze per rifiuti

**dimeda**<sup>®</sup>  
SURGICAL INSTRUMENTS



SAUERBRUCH  
**28.160.55**  
55,0 cm



SAUERBRUCH  
**28.162.55**  
55,0 cm



DIMEDA  
**28.170.58**  
58,0 cm

## Reinigungsbürsten

Cleaning Brushes  
Brosses à lavement  
Cepillos de limpieza  
Spazzole per pulire



<b>28.315.13</b>	215x 60x13 mm
<b>28.315.15</b>	215x 65x15 mm
<b>28.315.20</b>	215x 95x20 mm
<b>28.315.25</b>	215x 95x25 mm
<b>28.315.28</b>	215x100x28 mm

### 28.315.00

Satz mit 5 Bürsten 28.315.13 - 28.315.28  
set of 5 brushes 28.315.13 - 28.315.28  
jeu de 5 brosses 28.315.13 - 28.315.28  
juego de 5 cepillos 28.315.13 - 28.315.28  
set a 5 spazzole 28.315.13 - 28.315.28



**28.318.12**  
275x65x12mm



**28.318.15**  
275x80x15mm



**28.318.30**  
300x120x30mm



**28.318.50**  
320x130x50mm



**28.324.35**  
360x140x35mm



**28.326.40**  
420x180x40mm



**28.327.60**  
500x180x60mm

## Nähnadeln

Suturing Needles  
Aiguilles à sutures  
Agujas para suturas  
Aghi per suture

**dimeda**<sup>®</sup>  
SURGICAL INSTRUMENTS



**28.333.80**  
490x180x80 mm



**28.335.60**  
450x180x60 mm



**28.340.75**  
420x130x75 mm



**28.351.50**  
330x130x50 mm

konisch  
conical  
conique  
cónico  
conico



**28.356.15**  
400x190x8/20 mm



**28.359.18**  
300x110x18/33 mm



**28.361.15**  
320x70x15/25 mm



**28.365.08**  
420x60x8/15 mm



**28.367.15**  
1000x180x16 mm



**28.370.95**  
210x95 mm

Sterilizerhilfen / Sterilizing Aids / Instrumente pour Sterilisation / Auxilios para la esterilización / Utensili per la sterilizzazione





Gipsverband  
Plaster of Paris  
Bandages plâtrés  
Vendajes enyesados  
Bendaggi gessati

## Gipsverband

Plaster of Paris  
Appareils plâtrés  
Vendajes enyesados  
Bendaggi gessati

Gipsscheren  
Plaster Shears  
Ciseaux pour plâtre  
Cizallas para yeso  
Forbici per gesso



STILLE  
**30.101.24**  
24,0 cm



STILLE  
18,0 cm **30.103.18**  
20,0 cm **30.103.20**  
23,0 cm **30.103.23**  
26,0 cm **30.103.26**  
37,0 cm **30.103.37**



SEUTIN  
**30.104.23**  
23,0 cm



WIGMORE  
**30.120.19**  
19,0 cm

Gipssägen  
Plaster Saws  
Scies pour plâtre  
Sierra para yeso  
Seghe per gesso



ENGEL  
**30.130.14**



BERGMANN  
**30.134.18**

Gipsspreizer  
Plaster Spreaders  
Pince pour plâtre  
Separadores para yeso  
Pinze per gesso



**HENNIG**  
**30.350.28**  
28,0 cm



**HERMANN**  
**30.350.48**  
48,0 cm



**QUATTRO**  
**30.352.23**  
23,0 cm

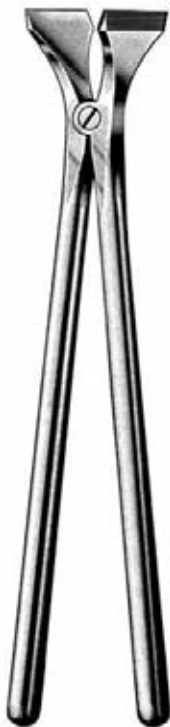

**BEESON**  
**30.360.30**  
30,0 cm

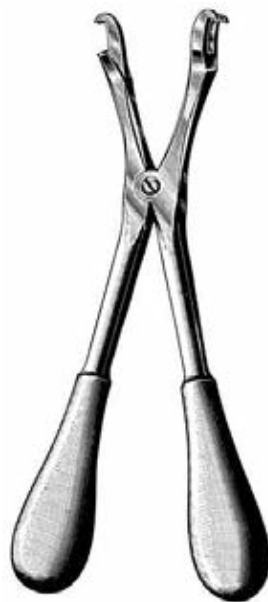

**HAGLUND-STILLE**  
**30.362.28**  
28,0 cm



**30.366.23**  
23,0 cm



## Gipsverband

Plaster of Paris  
Appareils plâtrés  
Vendajes enyesados  
Bendaggi gessati

Gipsmesser  
Plaster Knives  
Couteaux pour plâtre  
Cuchillos para yeso  
Coltelli per gesso



HOPKINS  
**30.370.20**  
20,0 cm



ESMARCH  
**30.380.18**  
18,0 cm



REINER  
**30.390.18**  
18,0 cm



**30.390.21**  
21,0 cm

Gipsabreißzangen  
Plaster Breakers  
Pince pour rompre plâtre  
Pinzas para romper yeso  
Pinze per rompere gesso



WOLFF  
**30.395.18**  
18,0 cm



WOLFF  
**30.397.24**  
24,0 cm

## Oszillierende Gipssäge

Oscillating Plaster Saw

Scie oscillante

Sierra oscilante

Sega oscillante

**dimeda**<sup>®</sup>  
SURGICAL INSTRUMENTS

Stufenlos regelbar  
Fully adjustable  
Réglable sans arrêt  
Regular con progresión  
Regolabile con processione continua

komplett mit 2 Sägeblättern 30.210.50, 30.210.65 und 2 Schraubenschlüsseln 30.210.02  
complete with 2 saw blades 30.210.50, 30.210.65 and 2 wrenches 30.210.02  
complet avec 2 lames de scie 30.210.50, 30.210.65 et clé à écrou 30.210.02  
completo con 2 hojas de sierra 30.210.50, 30.210.65 y 2 llaves de tuercas 30.210.02  
completa con 2 lame 30.210.50, 30.210.65 e 2 chiavi 30.210.02



**30.200.10**  
110 Volt

**30.200.20**  
230 Volt

Kreissägeblätter  
Circular saw blades  
Lames de scie circulaires  
Hojas de sierra circular  
Lame circolari per fasciature



**30.210.02**

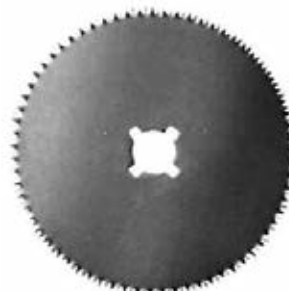

		Typ
45 mm Ø	<b>30.210.45</b>	normal
50 mm Ø	<b>30.210.50</b>	normal
65 mm Ø	<b>30.210.65</b>	normal
45 mm Ø	<b>30.211.45</b>	hart
50 mm Ø	<b>30.211.50</b>	hart
65 mm Ø	<b>30.211.65</b>	hart
50 mm Ø	<b>30.212.50</b>	Teflon
65 mm Ø	<b>30.212.65</b>	Teflon

**Spezialkatalog**

Special catalog  
Catalogue spécial  
Catálogo especial  
Catalog speciale

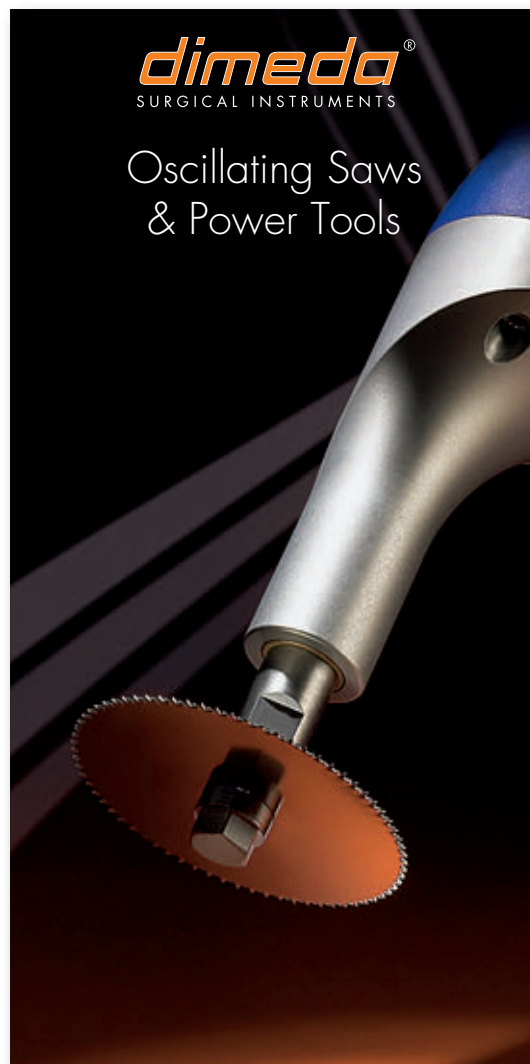

99.999.30



Orthopädie, Osteosynthese  
Bone Surgery, Osteosynthesis  
Chirurgie osseuse, Ostéosynthèse  
Cirugía ósea, Osteosíntesis  
Chirurgia ossea, Osteosintesi

## Hohlmeißelzangen

Bone Rongeurs  
Pinces-gouges  
Pinzas-gubias  
Pinze sgorbie



FRIEDMAN Mini  
32.101.12  
12 cm



FRIEDMAN  
32.101.14  
14 cm



CLEVELAND  
32.105.17  
17 cm Fig. 4 A



MEAD  
32.107.16  
16,5 cm Fig. 1 A



FRIEDMAN  
32.102.14  
14 cm



CLEVELAND  
32.103.14  
14 cm Fig. 4

FRIEDMAN  
32.102.15  
15 cm



MEAD  
32.109.16  
16,5 cm



BLUMENTHAL  
32.115.15  
15,5 cm



BLUMENTHAL  
32.117.15  
15,5 cm

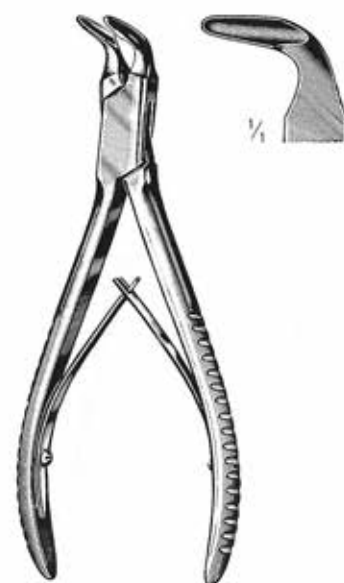

BLUMENTHAL  
32.119.15  
15,5 cm

## Hohlmeißelzangen

Bone Rongeurs  
Pincés-gouges  
Pinzas-gubias  
Pinze sgorbie



LUER  
32.131.15  
15 cm



LUER  
32.133.15  
15 cm

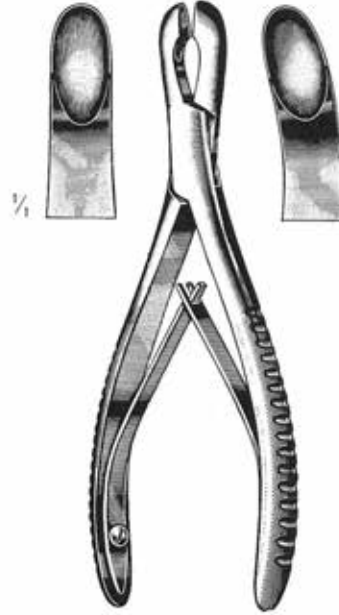

LUER  
32.136.17 17 cm 32.137.17



ADSON  
32.142.20 20 cm 32.143.20



OLIVECRONA  
32.147.20  
20 cm



LEMPERT  
32.150.16 16 cm 32.151.16



LEMPERT  
32.154.18 18,5cm 32.155.18



## Hohlmeißelzangen

Bone Rongeurs  
Pinces-gouges  
Pinzas-gubias  
Pinze sgorbie



BEYER  
32.201.18  
18 cm



ZAUFAL-JANSEN  
32.205.18  
18 cm



BÖHLER  
32.210.15 15 cm/2 mm 32.211.15  
32.212.15 15 cm/3 mm 32.213.15



RUSKIN  
32.216.18 18 cm 32.217.18



RUSKIN  
32.218.23 23 cm 32.219.23

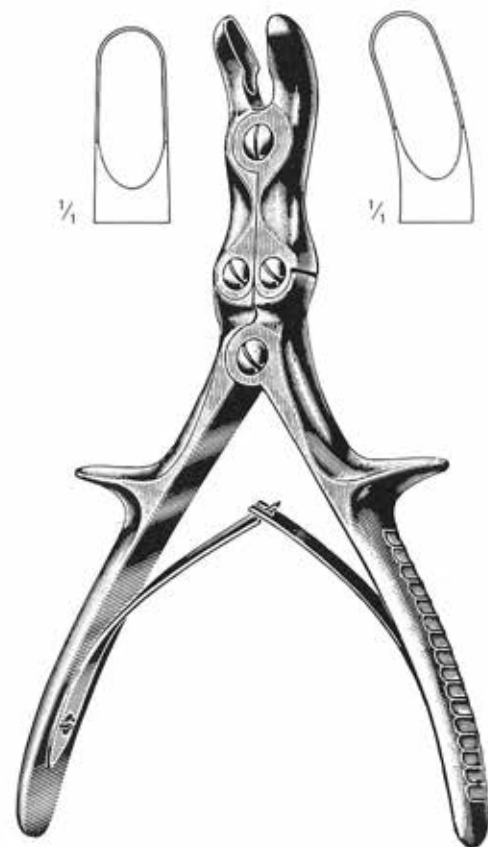

STILLE-LUER  
22 cm 32.231.22  
32.230.26 26 cm 32.231.26



STILLE-LUER  
32.235.23  
23 cm

**Hohlmeißelzangen**

Bone Rongeurs  
Pincas-gouges  
Pinzas-gubias  
Pinze sgorbie



**STILLE-RUSKIN**  
32.237.23  
23 cm

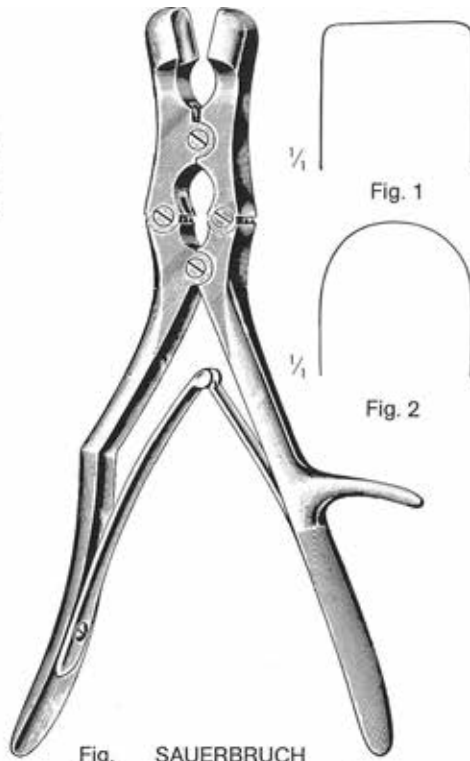

Fig. SAUERBRUCH  
1 32.241.30  
2 32.243.30  
30 cm

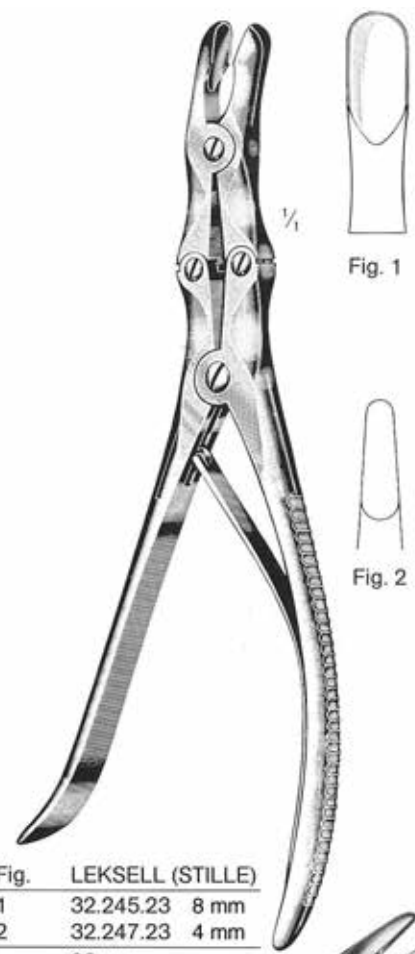

Fig. LEKSELL (STILLE)  
1 32.245.23 8 mm  
2 32.247.23 4 mm  
23 cm



R	SCAGLIETTI	L
32.251.26	26 cm	32.253.26
à droite		à gauche
derecha		izquierda
a destra		a sinistra



**FRYKHOLM**  
32.255.24  
24 cm



mm	ECHLIN
2	32.259.02
3	32.259.03
4	32.259.23
	23 cm



## Knochensplitterzangen

Bone Cutting Forceps

Pinces coupantes à os

Pinzas cortantes para huesos

Cesoie per ossa

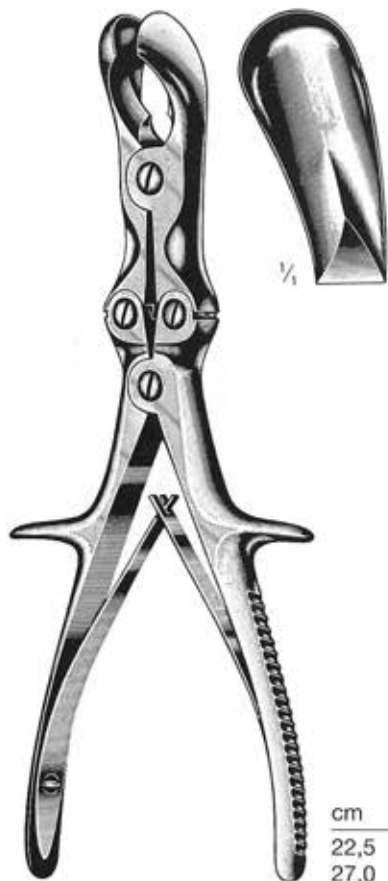

cm	SEMB
22,5	32.261.22
27,0	32.261.27

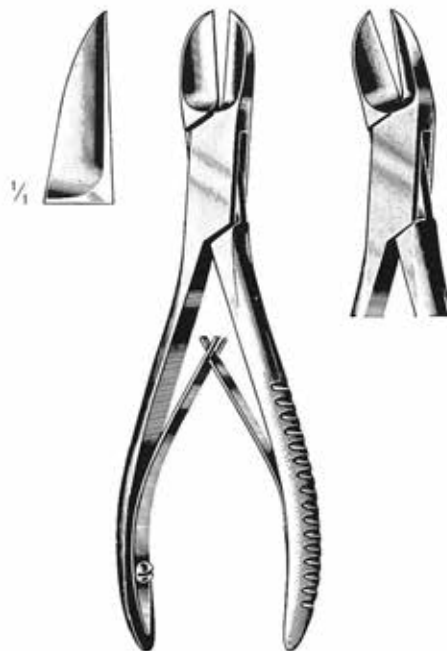

LISTON		
32.274.14	14 cm	32.275.14
32.274.17	17 cm	32.275.17
32.274.19	19 cm	32.275.19
32.274.22	22 cm	32.275.22



BÖHLER		
32.280.15	15 cm	32.281.15



COTTLE-KAZANJIAN  
32.282.19  
19 cm



RUSKIN-LISTON		
32.286.18	18,5cm	32.289.18

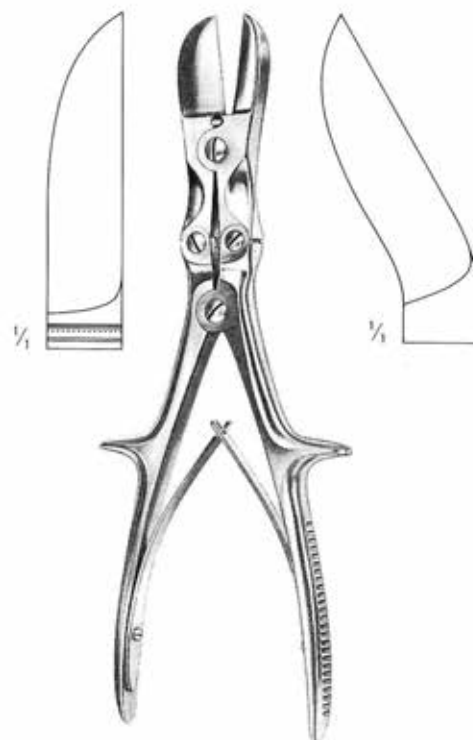

STILLE-LISTON		
32.290.27	27 cm	32.291.27

**Knochensplitterzangen**

Bone Cutting Forceps  
 Pinces coupantes à os  
 Pinzas cortantes para huesos  
 Cesioie per ossa



**STILLE-HORSLEY**  
 32.293.27  
 27 cm

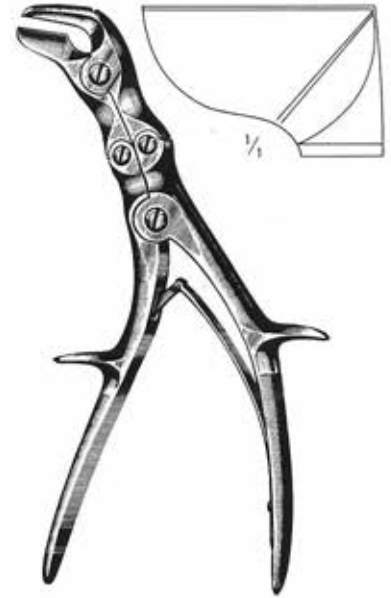

**SEMB**  
 32.295.24  
 24 cm

**Knochenhalte-zangen**  
 Bone Holding Forceps  
 Daviers porte-os  
 Pinzas para huesos  
 Tenaglie per ossa

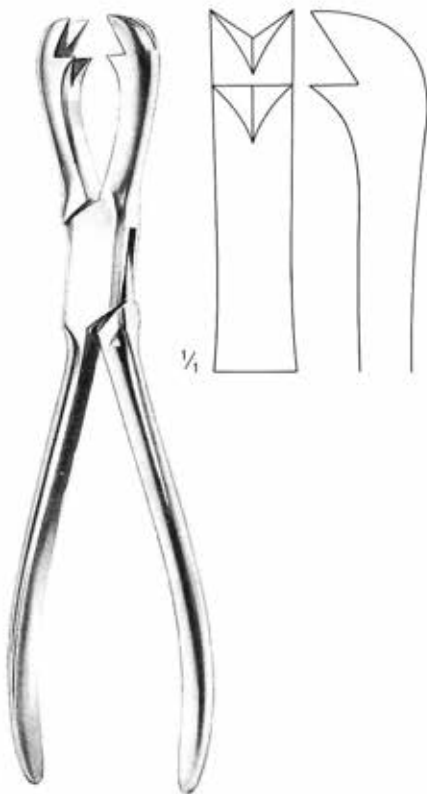

**FERGUSON**  
 32.360.21  
 21 cm



**LANGENBECK**  
 32.362.21  
 21 cm

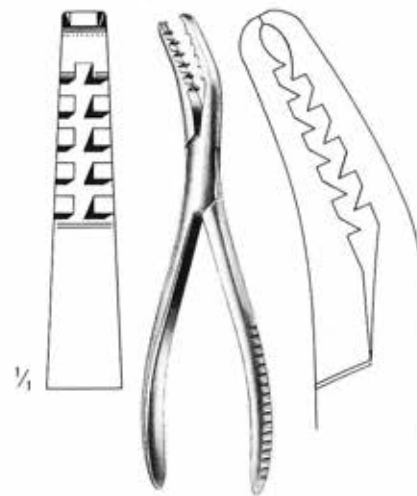

**SEMB**  
 32.365.19  
 19 cm



cm	FARABEUFF
23	32.366.23
26	32.366.26

Orthopädie, Osteosynthese / Bone Surgery, Osteosynthesis / Chirurgie osseuse, Ostéosynthèse / Chirurgia ósea, Osteosíntesis / Chirurgia ossea, Osteosintesi

## Knochenhaltezangen

Bone Holding Forceps

Daviers porte os

Pinzas para huesos

Tenaglie per ossa



FARABEU-F-LAMBOTTE  
32.368.26  
26 cm



cm	LAMBOTTE
22	32.370.22
27	32.370.27
30	32.370.30



cm	LAMBOTTE
22	32.372.22
26	32.372.26
33	32.372.33



cm	LAMBOTTE
19	32.373.19
23	32.373.23
26	32.373.26

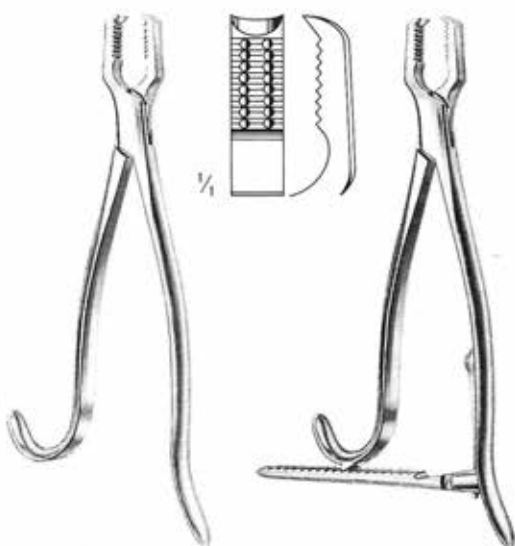

cm	KERN	KERN
15	32.378.15	32.380.15
17	32.378.17	32.380.17
21	32.378.21	32.380.21

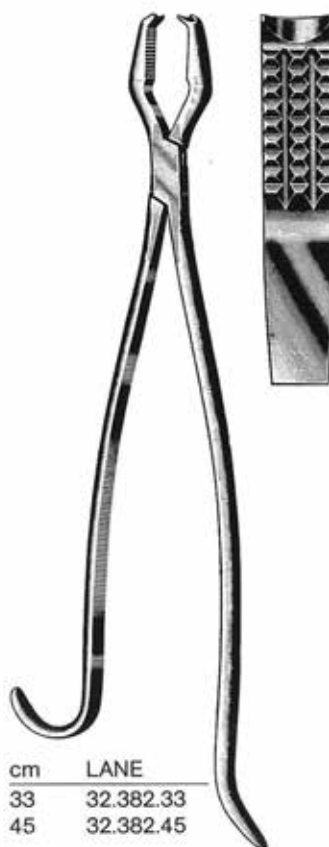

cm	LANE
33	32.382.33
45	32.382.45

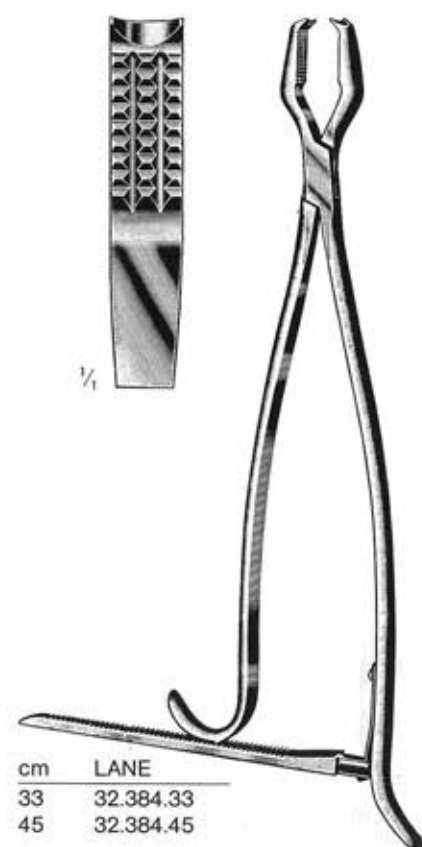

cm	LANE
33	32.384.33
45	32.384.45

**Knochenhaltezangen**

Bone Holding Forceps  
 Daviers porte os  
 Pinzas para huesos  
 Tenaglie per ossa



32.391.15-32.391.28

Selbstzentrierend  
 self-centering  
 autocentrant  
 autocentrantes  
 autocentranti



32.391.15  
 15 cm



32.391.19  
 19 cm



32.391.24  
 24 cm



32.391.26  
 26 cm



32.391.28  
 28 cm

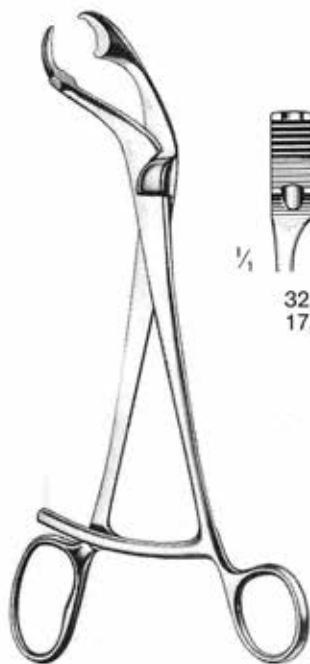

VERBRUGGE  
 32.395.17-32.395.27



32.395.17  
 17,5 cm

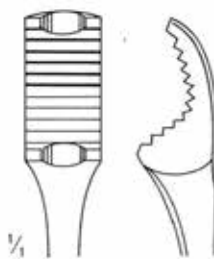

32.395.25  
 25 cm

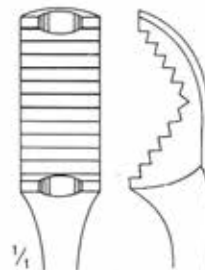

32.395.26  
 26 cm

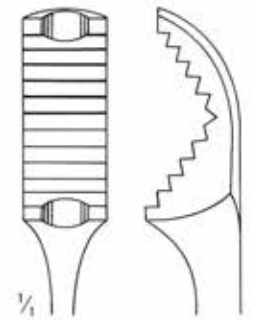

32.395.27  
 27 cm



## Knochenhalte-, Sequesterzangen

Bone Holding, Sequester Forceps

Pinces à os, à séquestres

Pinzas para huesos y secuestros

Pinze per ossa e sequestri

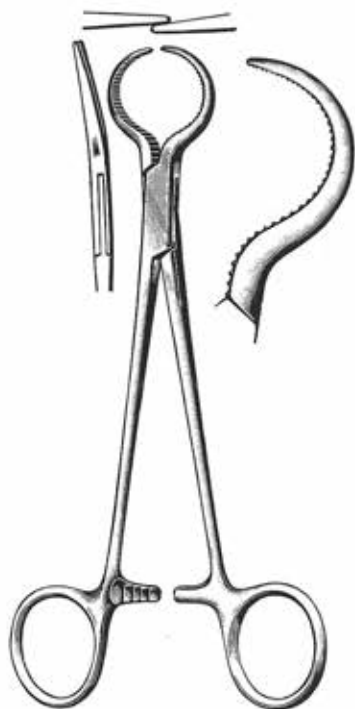

LEWIN  
32.402.17  
17,5 cm

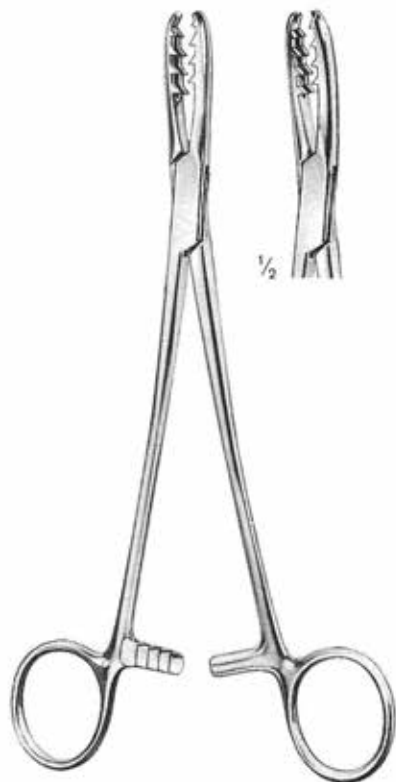

BIRCHER-GANSKE  
32.404.20 20 cm 32.405.20

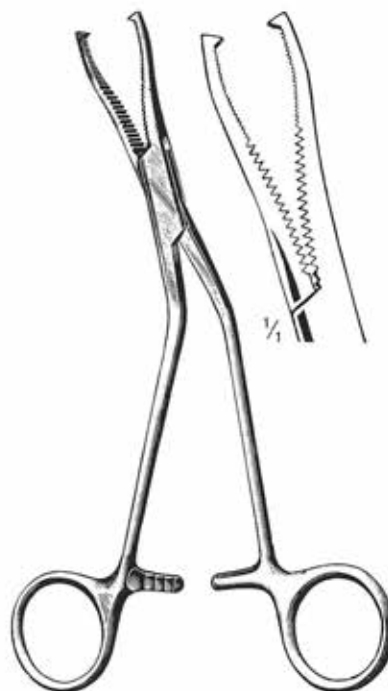

DINGMANN  
32.407.19  
19 cm



32.409.13  
13,5 cm



MARTIN  
32.410.19  
19 cm

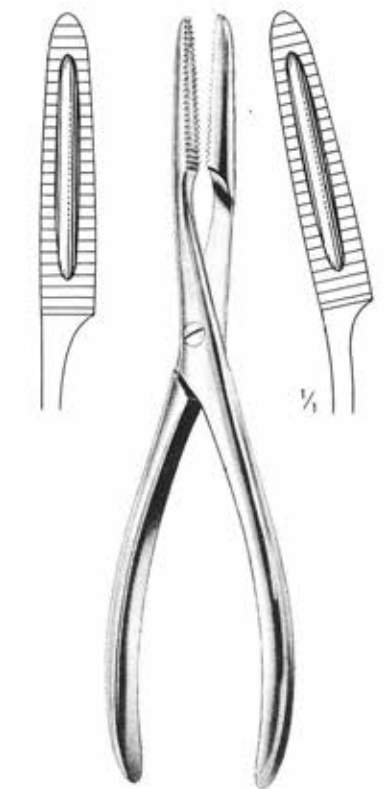

32.420.20 20 cm 32.421.20

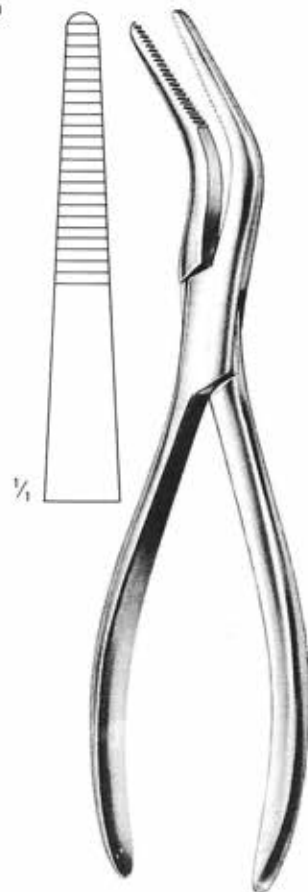

VAN BUREN  
32.423.23  
23 cm

**Knochenchirurgie**

Bone Surgery  
Chirurgie osseuse  
Cirugía ósea  
Chirurgia ossa



cm	LOWMAN
13	32.441.13
18,5	32.441.18
20	32.441.20

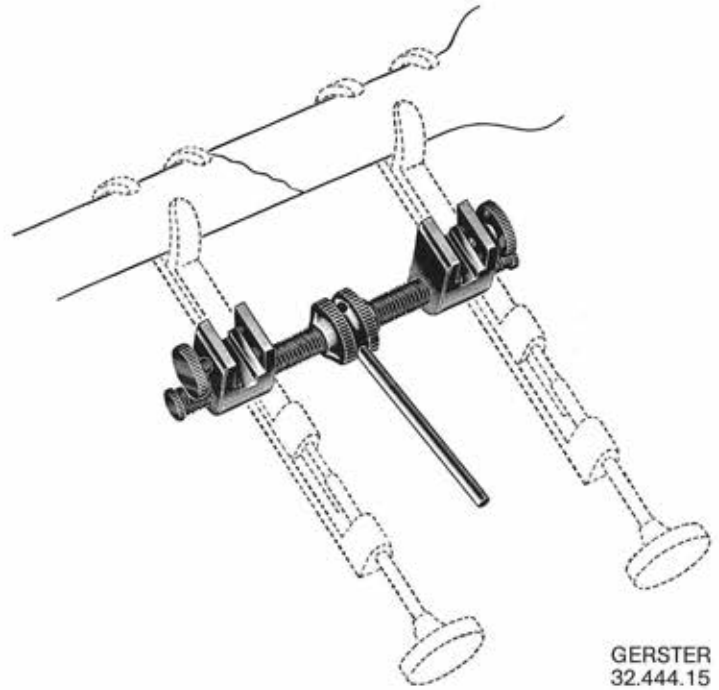

GERSTER  
32.444.15



cm	PARHAM
18	32.448.18
30	32.448.30

PARHAM  
32.446.24



- 32.450.01 f. Erwachsene  
adult size  
p. adultes  
p. adultos  
p. adulti
- 32.450.02 f. Kinder  
child size  
p. enfants  
p. niños  
p. bambini

Orthopädie, Osteosynthese / Bone Surgery, Osteosynthesis / Chirurgie osseuse, Ostéosynthèse / Cirugía ósea, Osteosíntesis / Chirurgia ossea, Osteosintesi

## Scharfe Löffel

Bone Curettes  
Curettes à os  
Cucharillas cortantes  
Curette taglianti

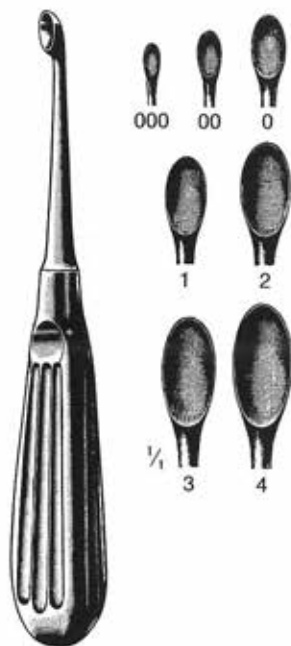

SCHEDE  
32.467.97-32.468.04

SCHEDE	Fig.	VOLKMANN
	0000	32.469.96
32.467.97	000	32.469.97
32.467.98	00	32.469.98
32.468.00	0	32.470.00
32.468.01	1	32.470.01
32.468.02	2	32.470.02
32.468.03	3	32.470.03
32.468.04	4	32.470.04
	5	32.470.05
	6	32.470.06

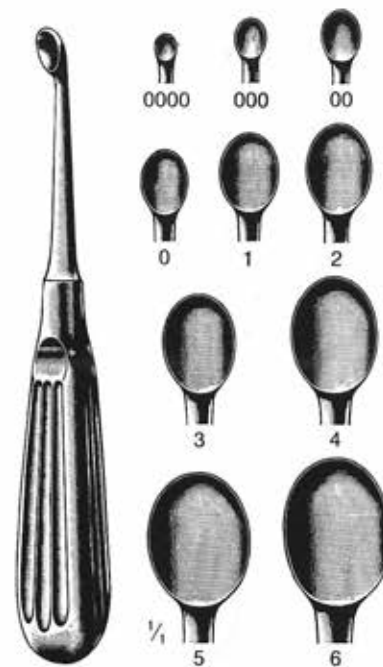

VOLKMANN  
32.469.96-32.470.06

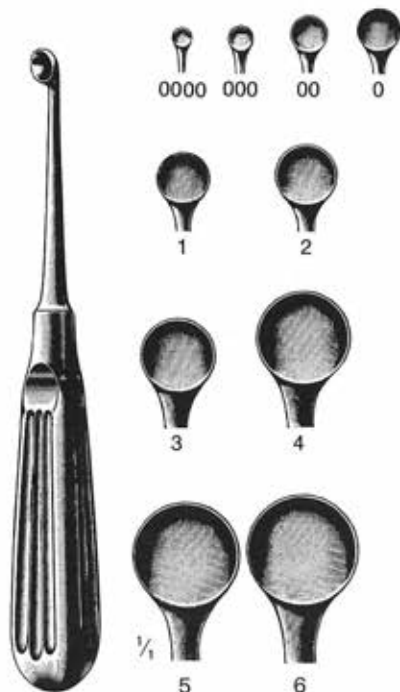

BRUNS  
32.471.96-32.472.06

BRUNS	Fig.	SPRATT
32.471.96	0000	32.474.96
32.471.97	000	32.474.97
32.471.98	00	32.474.98
32.472.00	0	32.475.00
32.472.01	1	32.475.01
32.472.02	2	32.475.02
32.472.03	3	32.475.03
32.472.04	4	32.475.04
32.472.05	5	32.475.05
32.472.06	6	

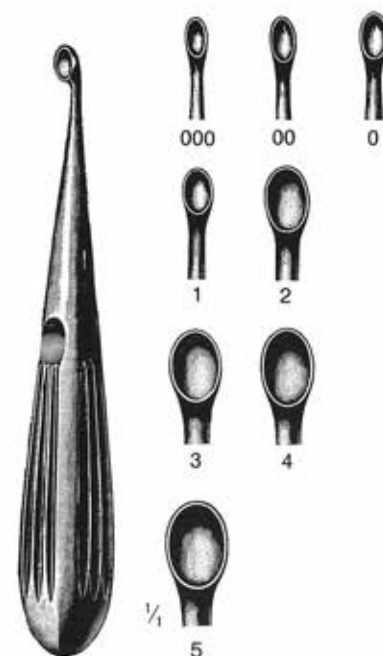

SPRATT  
32.474.97-32.475.05



**Scharfe Löffel**

Bone Curettes  
Curettes à os  
Cucharillas cortantes  
Curette taglianti

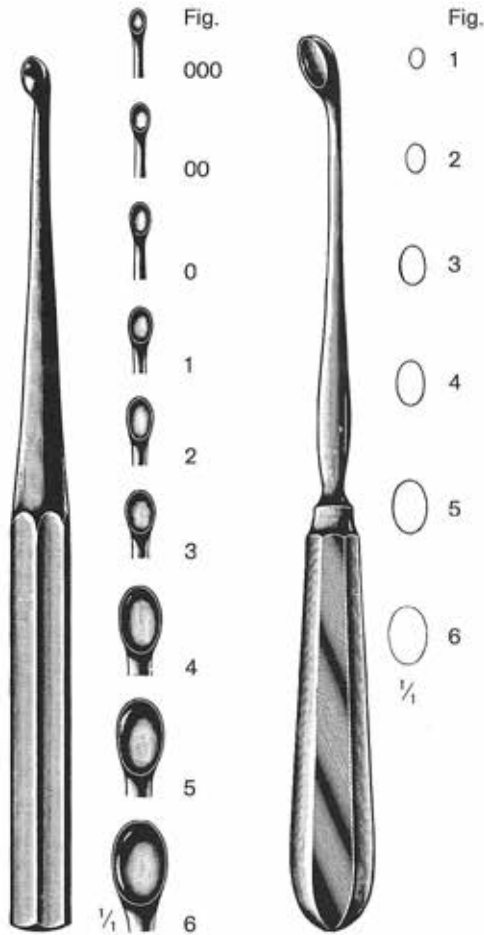

BRUNS 23 cm		SIMON 24 cm	
Fig.			
000	32.480.97		
00	32.480.98		
0	32.481.00		
1	32.481.01	32.485.01	
2	32.481.02	32.485.02	
3	32.481.03	32.485.03	
4	32.481.04	32.485.04	
5	32.481.05	32.485.05	
6	32.481.06	32.485.06	

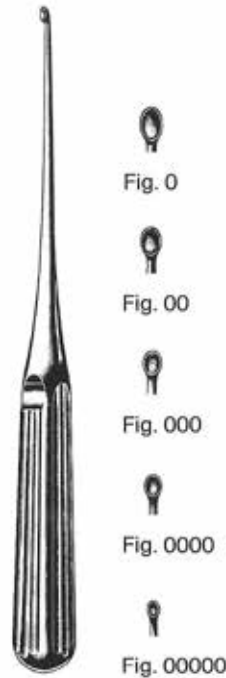

LEMPERT 21,5 cm	
Fig.	
0	32.490.10
00	32.490.20
000	32.490.30
0000	32.490.40
00000	32.490.50

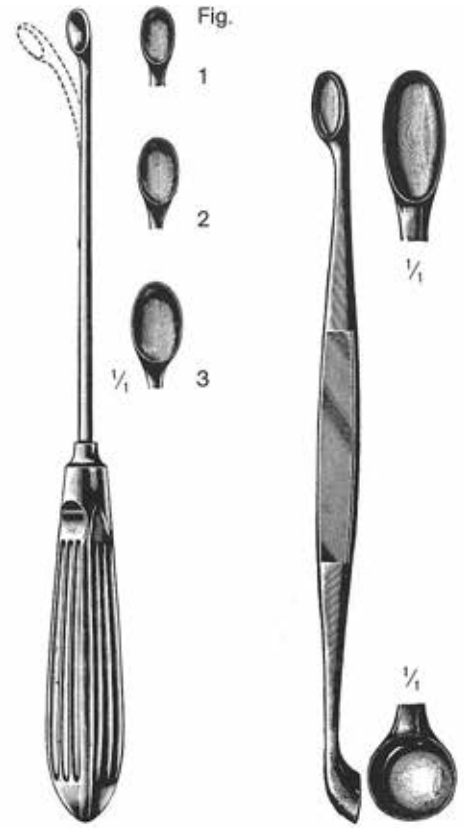

HALLE 21 cm		VOLKMANN	
Fig.		cm	
1	32.491.01	13	32.492.13
2	32.491.02	16	32.492.16
3	32.491.03	20	32.492.20



VOLKMANN	
cm	
13	32.494.13
14	32.494.14
17	32.494.17

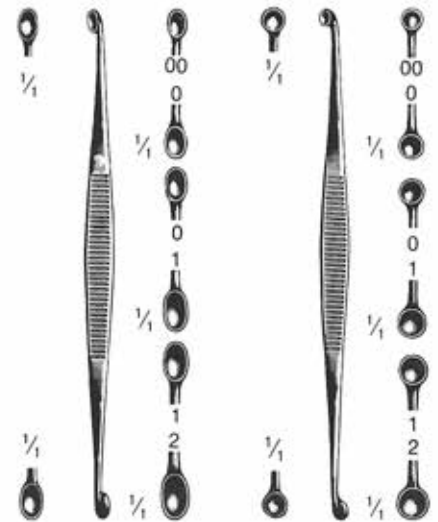

WILLIGER 13,5 cm		MARTINI 13,5 cm	
Fig.			
00/0	32.496.00	00	32.498.00
0/1	32.496.01	0/1	32.498.01
1/2	32.496.12	1/2	32.498.12

## Knochenmeißel

Bone Chisels and Gouges

Ciseaux-burins, gouges

Cinceles, gubias

Scalpelli, sgorbie

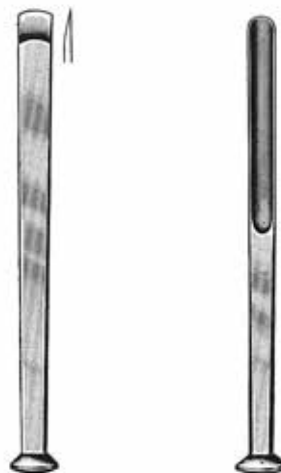

mm	13,5 cm	13,5 cm	13,5 cm	ALEXANDER 17 cm	ALEXANDER 17 cm
4	32.602.04	32.604.04	32.605.04	32.610.04	32.611.04
6		32.604.06		32.610.06	32.611.06
8	32.602.08	32.604.08	32.605.08	32.610.08	32.611.08
10	32.602.10	32.604.10	32.605.10	32.610.10	32.611.10
12	32.602.12	32.604.12	32.605.12	32.610.12	32.611.12
14	32.602.14	32.604.14	32.605.14	32.610.14	32.611.14
16	32.602.16	32.604.16	32.605.16		

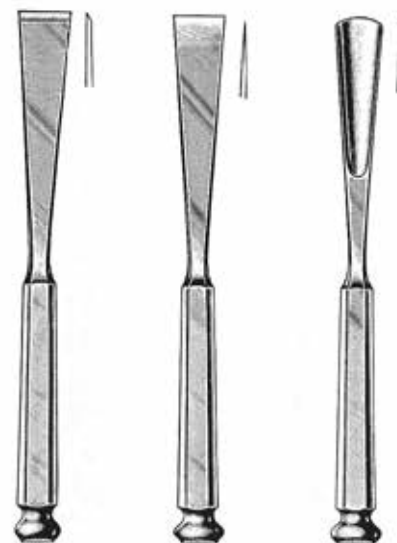
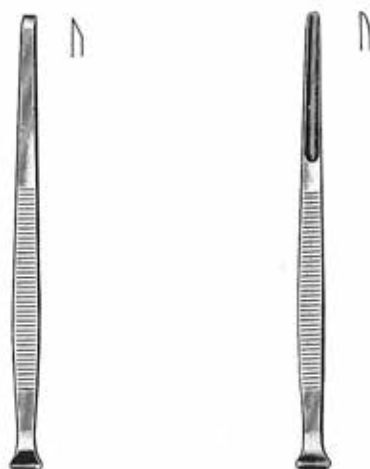

mm	PARTSCH		PARTSCH	
	13,5 cm	17 cm	13,5 cm	17 cm
2	32.620.02	32.622.02	32.623.02	32.625.02
3	32.620.03	32.622.03	32.623.03	32.625.03
4	32.620.04	32.622.04	32.623.04	32.625.04
5	32.620.05	32.622.05	32.623.05	32.625.05
6	32.620.06	32.622.06	32.623.06	32.625.06
7	32.620.07	32.622.07	32.623.07	32.625.07
8	32.620.08	32.622.08	32.623.08	32.625.08

mm	STILLE		
	20 cm	20 cm	20 cm
10	32.630.10	32.632.10	32.633.10
15	32.630.15	32.632.15	32.633.15
20	32.630.20	32.632.20	32.633.20
25	32.630.25	32.632.25	32.633.25

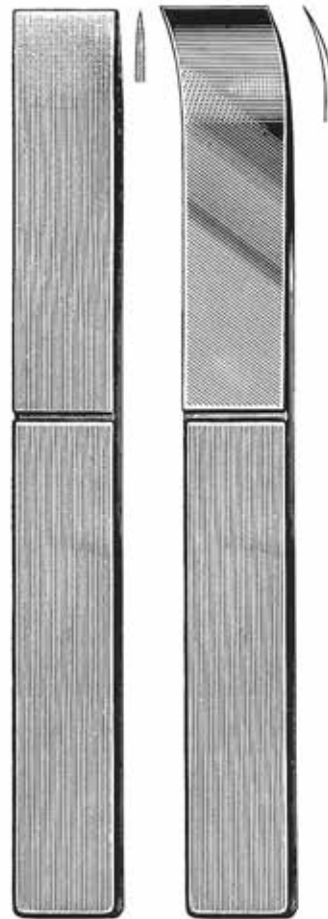

mm	SMITH-PETERSEN			
6	32.634.06	32.635.06	32.637.06	32.639.06
9	32.634.09	32.635.09	32.637.09	32.639.09
13	32.634.13	32.635.13	32.637.13	32.639.13
16	32.634.16	32.635.16	32.637.16	32.639.16
19	32.634.19	32.635.19	32.637.19	32.639.19
25	32.634.25	32.635.25	32.637.25	32.639.25
32	32.634.32	32.635.32	32.637.32	32.639.32
	20 cm	20 cm	20 cm	20 cm

mm	LAMBOTTE		LAMBOTTE mini	
6,5	32.650.06	32.651.06	3	32.654.03
15,0	32.650.15	32.651.15	4	32.654.04
20,0	32.650.20	32.651.20	6	32.654.06
25,0	32.650.25	32.651.25	8	32.654.08
30,0	32.650.30	32.651.30	10	32.654.10
38,0	32.650.38	32.651.38	12	32.654.12
44,0	32.650.44	32.651.44	15	32.654.15
	24 cm	23 cm		12,5 cm



mm	LEXER	LEXER
7	32.660.07	32.661.07
10	32.660.10	32.661.10
15	32.660.15	32.661.15
20	32.660.20	32.661.20
25	32.660.25	32.661.25
30	32.660.30	32.661.30
	22 cm	22 cm



mm	LEXER mini	LEXER mini
4	32.664.04	32.665.04
6	32.664.06	32.665.06
8	32.664.08	32.665.08
10	32.664.10	32.665.10
12	32.664.12	32.665.12



mm	HOKE
3	32.668.03
5	32.668.05
6	32.668.06
8	32.668.08
9	32.668.09
	17 cm

mm	HIBBS				
6	32.670.06	32.672.06	32.671.06	32.673.06	32.675.06
13	32.670.13	32.672.13	32.671.13	32.673.13	32.675.13
19	32.670.19	32.672.19	32.671.19	32.673.19	32.675.19
25	32.670.25	32.672.25	32.671.25	32.673.25	32.675.25
32	32.670.32	32.672.32	32.671.32	32.673.32	32.675.32
	24 cm	24 cm	24 cm	24 cm	24 cm



**Knochenmeißel**  
 Bone Chisels and Gouges  
 Ciseaux-burins, gouges  
 Cinceles, gubias  
 Scalpelli, sgorbie

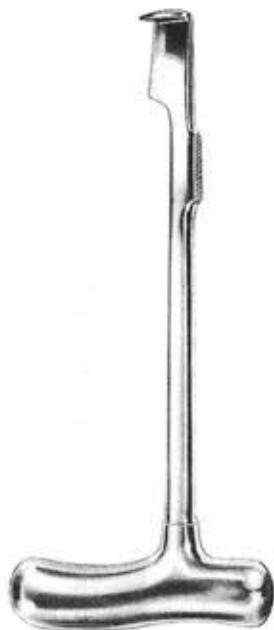

**LEBSCHE**  
 32.678.24  
 24,5 cm



32.679.22  
 22 cm



**VIRCHOW**  
 32.680.12



**BRUNETTI**  
 32.681.28  
 28 cm



**BRUNETTI**  
 32.683.28  
 28 cm

**Autopsie-Besteck**  
 Post Mortem Set  
 Set à autopsie  
 Juego de autopsia  
 Set per autopsia



32.684.00

Orthopädie, Osteosynthese / Bone Surgery, Osteosynthesis / Chirurgie osseuse, Ostéosynthèse / Chirurgia ósea, Osteosintesi

## Hämmer

Bone Hammers and Mallets

Maillets

Martillos y mazos

Martelli



GERZOG  
32.686.25  
18 cm 250 g



KIRK  
32.688.75  
19 cm 750 g



g	
450	32.690.45
900	32.690.90
26,5 cm	



COLLIN  
32.692.22  
20 cm 220 g



WILLIGER  
32.694.34  
24 cm 340 g

32.697.02  
Paar Ersatzbacken  
Pair of Spare Faces  
Paire de faces de rechange  
Pareja de tapas intercambiables  
Coppia di teste di ricambio



LUCAE  
32.696.26  
19 cm 260 g



MEAD  
32.696.32  
17 cm 320 g



g	
250	32.698.25
400	32.698.40
26 cm	



QUISLING  
32.698.75



32.699.00  
23,5 cm

**Raspatorien**  
 Periosteal Elevators  
 Rugines-raspatoires  
 Periostótomos  
 Periostotomi

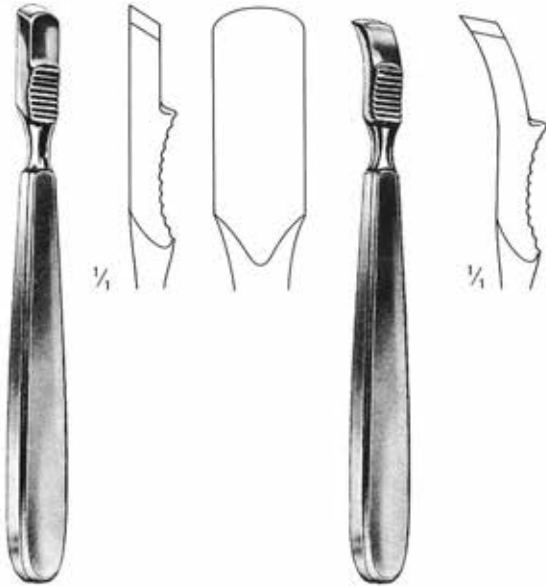

**FARABEU**  
 32.702.15  
 15 cm

**FARABEU**  
 32.703.15  
 15 cm

mm	LAMBOTTE
10	32.705.10
15	32.705.15
20	32.705.20
25	32.705.25
	21 cm

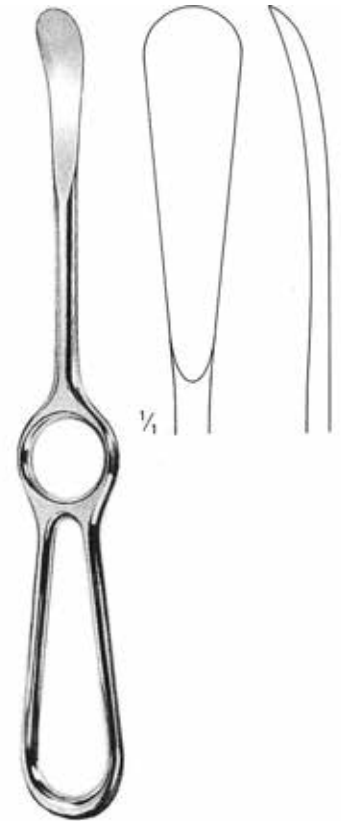

**SEDILLOT**  
 32.709.21  
 21 cm

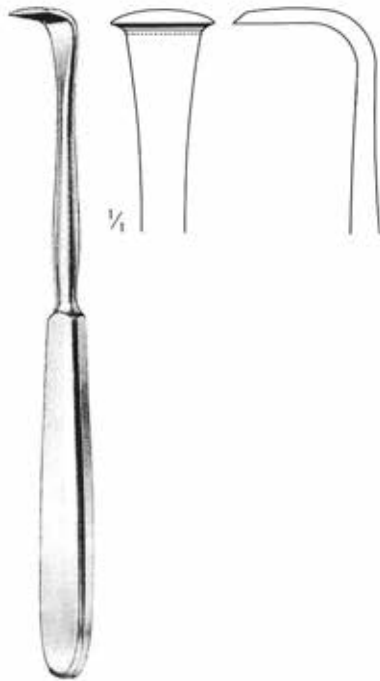

**LANGENBECK**  
 32.711.18  
 18 cm



**WILLIGER**  
 32.713.16  
 16 cm

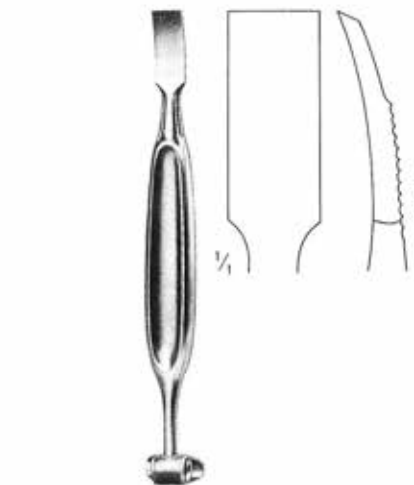

cm	ALEXANDER
16	32.715.16
20	32.715.20



**Raspatorien**  
 Periosteal Elevators  
 Rugines-raspatoires  
 Periostótomos  
 Periostotomi

Für Rippen  
 Rib  
 Pour les côtes  
 Para costillas  
 Costali

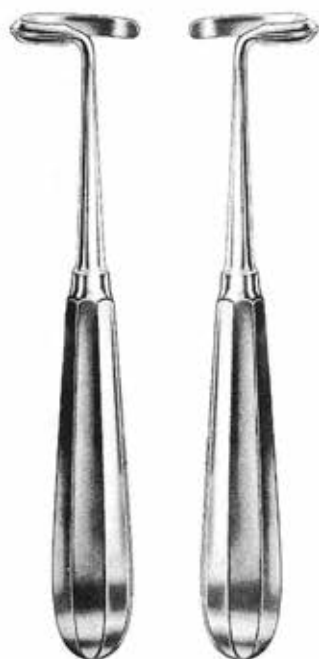

DOYEN DOYEN  
 32.721.17-32.727.17  
 17 cm

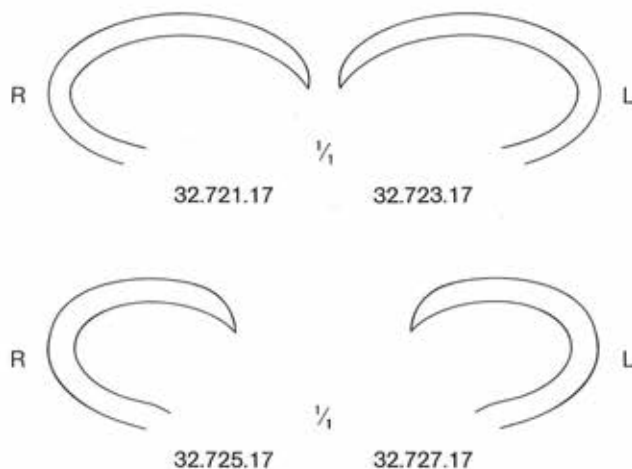

32.721.17

32.723.17

32.725.17

32.727.17



SEMB  
 32.729.01 -  
 32.729.07



1/2  
 32.729.01  
 17,5 cm



32.729.02  
 21,0 cm



32.729.03  
 17,5 cm



32.729.04  
 21,0 cm



32.729.05  
 20,5 cm



32.729.06  
 20,5 cm



32.729.07  
 22,5 cm

**Elevatoren**

Elevators  
 Élévateurs  
 Elevadores  
 Elevatori



**MATSON**  
 32.733.22  
 22 cm

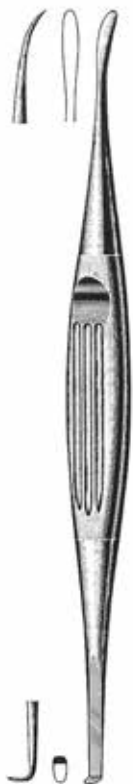

**OVERHOLT**  
 32.735.29  
 29,5 cm



**OVERHOLT**  
 32.737.29  
 29,5 cm



**OVERHOLT**  
 32.739.28  
 28,5 cm



**LANGENBECK**  
 32.751.20  
 20 cm



**LANGENBECK**  
 32.753.20  
 20 cm



**ADSON**  
 32.754.17 -  
 32.757.17  
 17 cm



32.754.17



32.755.17



32.756.17



32.757.17



**KEY**  
 32.759.06 -  
 32.759.25  
 19 cm



mm	
6	32.759.06
12	32.759.12
19	32.759.19
25	32.759.25

## Elevatoren, Knochenheber

Elevators, Bone Levers

Élévateurs, Leviers à os

Elevadores, E, para huesos

Elevatori, Elevatori per ossa



WATSON-CHEYNE  
32.765.17  
17,5 cm



McDONALD  
32.767.19  
19 cm



MURPHY-LANE  
32.769.30  
30 cm



BENNETT  
32.771.71  
65x260 mm



BENNETT  
32.771.73  
45x260 mm

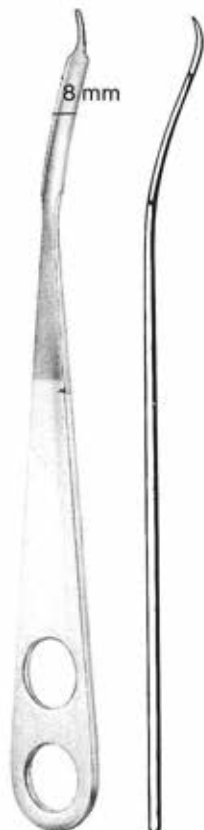

HOHMANN  
32.801.08  
8 mm

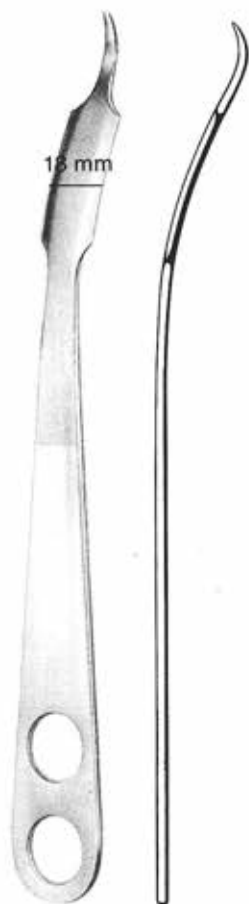

HOHMANN  
32.801.18  
18 mm



HOHMANN  
32.801.43  
43 mm



HOHMANN  
32.801.70  
70 mm

## Knochenhebel

Bone Levers

Leviers à os

Elevadores para huesos

Elevatori per ossa

**dimeda**<sup>®</sup>  
SURGICAL INSTRUMENTS

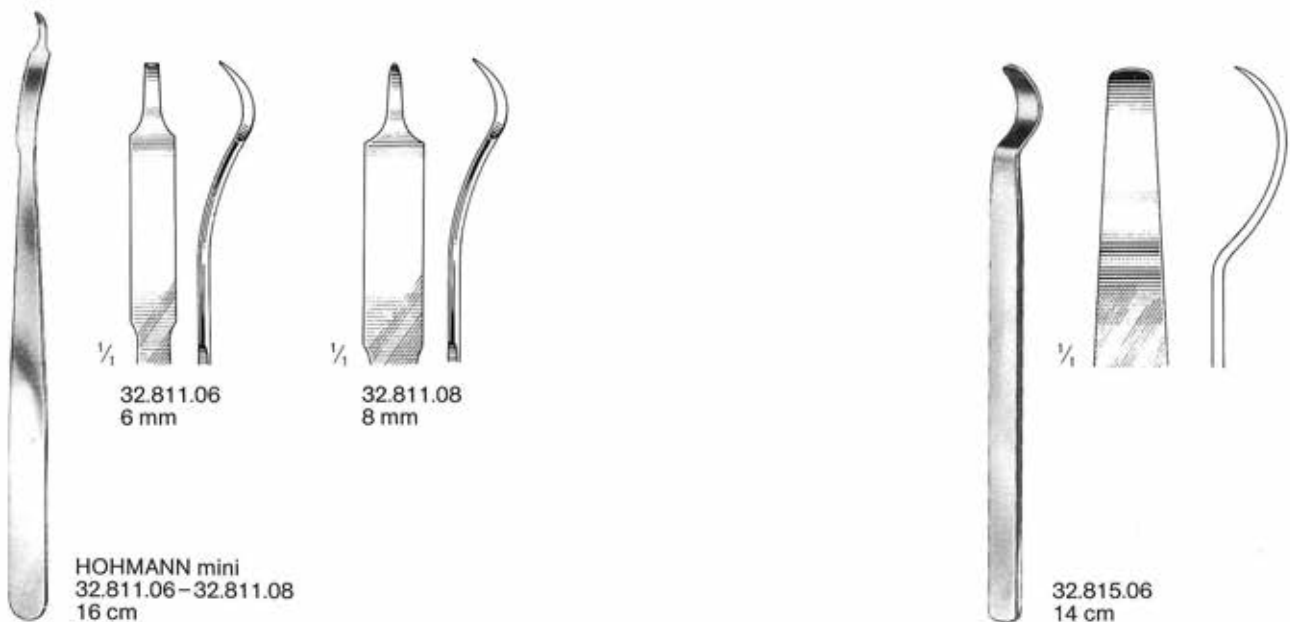
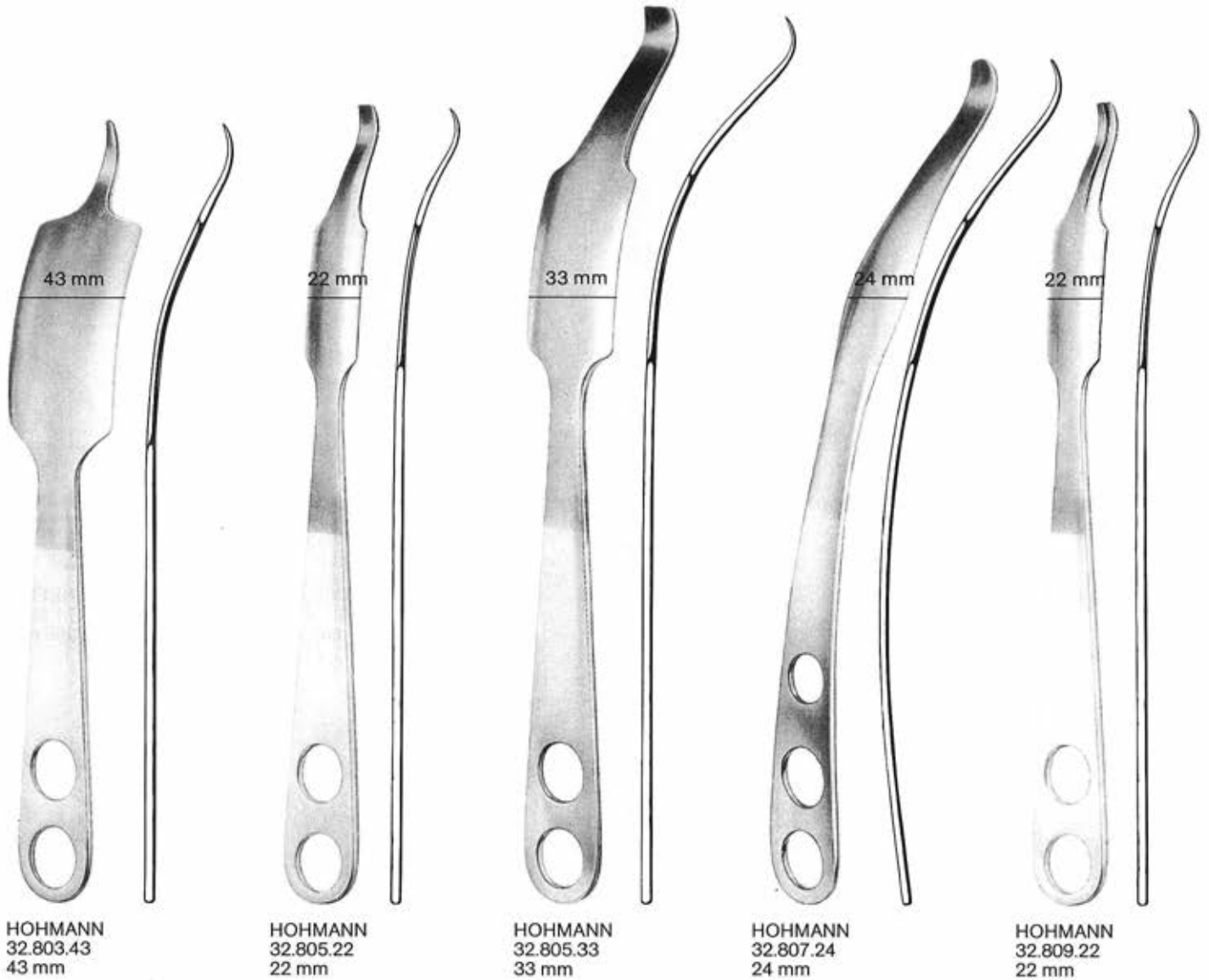

Orthopädie, Osteosynthese / Bone Surgery, Osteosynthesis / Chirurgie osseuse, Ostéosynthèse / Chirurgia ósea, Osteosíntesi

## Knochenchirurgie

Bone Surgery  
Chirurgie osseuse  
Cirugía ósea  
Chirurgia ossa

Knochenhebel  
Bone Levers  
Leviers à os  
Elevadores para huesos  
Elevatori per ossa



BLOUNT  
32.823.26  
26 cm

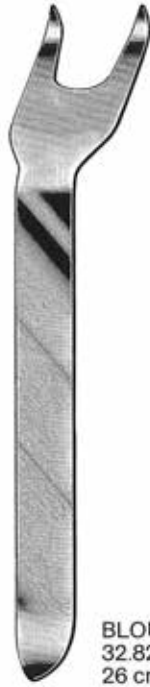

BLOUNT  
32.825.26  
26 cm

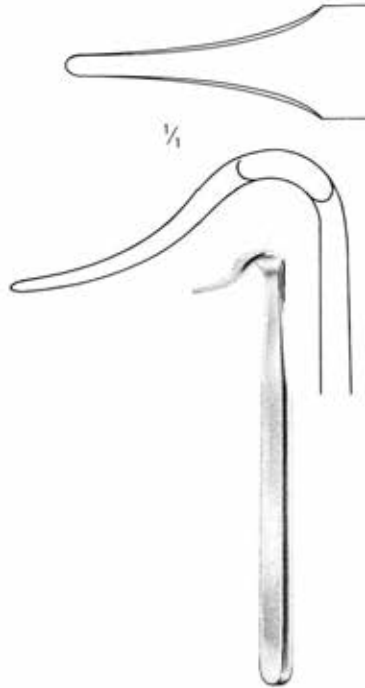

BLOUNT  
32.827.17  
17,5 cm



mm x mm	TAYLOR
75 x 30	32.831.16
100 x 30	32.833.16
16,5 cm	

Meniskotome · Meniscotomes  
Meniscotomes · Meniscótomos  
Meniscotomi

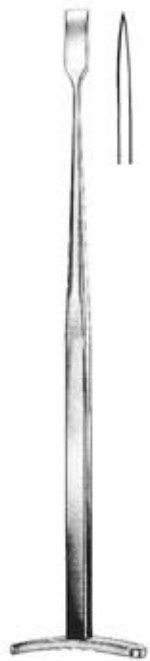

SMILLIE  
32.910.17  
17 cm

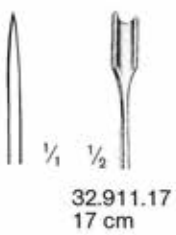

32.911.17  
17 cm



32.913.17  
17 cm



BIRCHER  
32.915.19  
19 cm



BIRCHER  
32.917.19  
19 cm

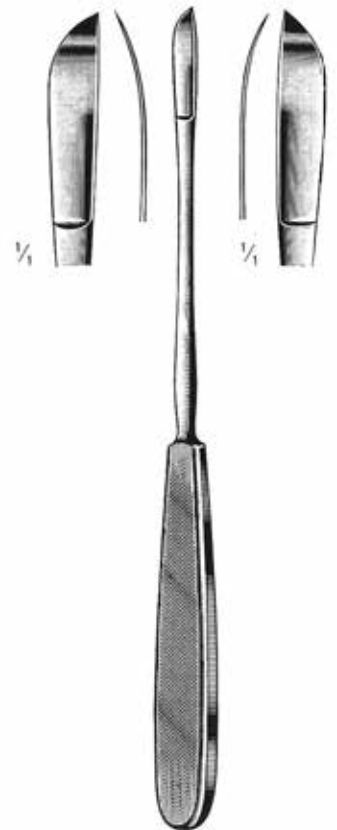

NEFF  
32.921.22 22 cm 32.923.22



## Knochenchirurgie

Bone Surgery  
Chirurgie osseuse  
Cirugía ósea  
Chirurgia ossa

**dimeda**<sup>®</sup>  
SURGICAL INSTRUMENTS

Sehnenstripper, Knochenfeilen  
Tendon Strippers, Bone Files  
Instruments à écorcher les tendons, limes à os  
Separadores para tendones, limas para huesos  
Scollatendini, lime per ossa

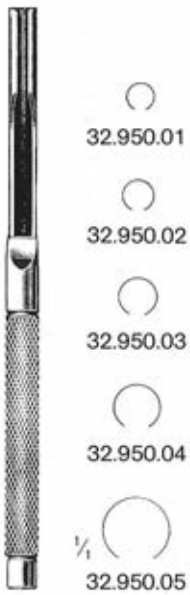

**BUNNELL**  
32.950.01 - 32.950.05  
15 cm



**32.971.24**  
24,5 cm



**32.972.22**  
22 cm



**PUTTI**  
32.973.27  
27 cm



**PUTTI**  
32.975.30  
30 cm

## Komprimeter

Comprimeter

Comprimètre

Torniquete

Apparechio per vuoto di sangue

Komprimeter zur Erzeugung von Blutleere in den Gliedern  
Compression Apparatus for producing blood vacuum in limbs  
Appareil compressif permettant d'obtenir un milieu exsangue des membres  
Aparato de compresión para producir el vacío de sangre en los miembros  
Vacumetro per determinare vuoti di sangue nelle membra



33.101.01  
compl.



**Amputation, Finger**

Amputation, Fingers  
Amputation, doigts  
Amputación, dedos  
Amputazione, dita

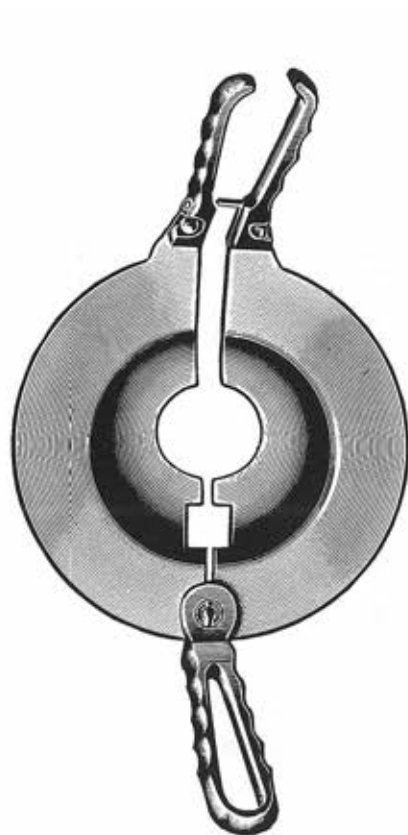

PERCY  
33.110.00

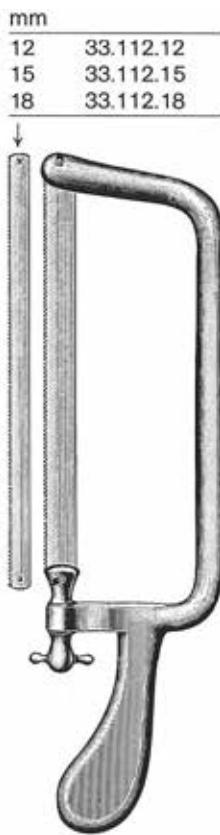

CHARRIERE  
33.112.00



CHARRIERE  
33.116.30  
30 cm



SATTERLEE  
33.118.31  
31 cm



LANGENBECK  
33.120.23  
23 cm



33.160.01



33.160.00  
Compl. incl.  
33.160.01



RADOLF  
33.162.13  
13,5 cm



DIMEDA  
33.173.00  
17 cm



33.175.00

Orthopädie, Osteosynthese / Bone Surgery, Osteosynthesis / Chirurgie osseuse, Ostéosynthèse / Chirurgia ósea, Osteosíntesi

## Handbohrapparate

Bone Hand Drills  
Perforateurs à main  
Perforadores a mano  
Perforatori a mano

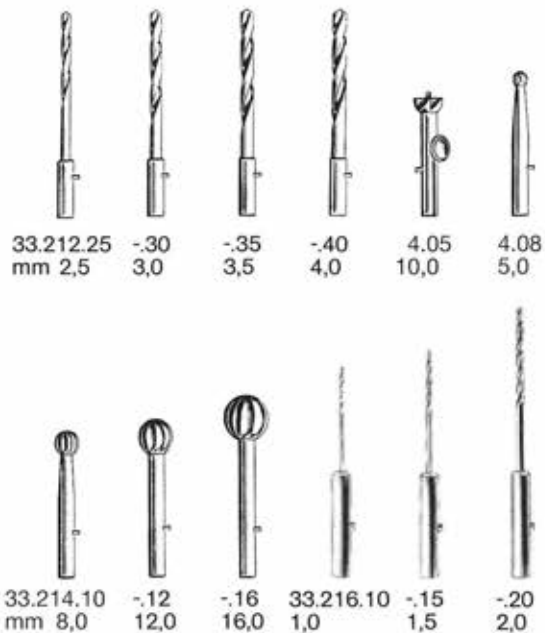

33.212.25 -30  
mm 2,5 3,0

-35  
3,5

-40  
4,0

4.05  
10,0

4.08  
5,0

33.214.10 -12  
mm 8,0 12,0

-16  
16,0

33.216.10 -15  
1,0 1,5

-20  
2,0

STILLE

33.210.20  
Compl. 20 cm

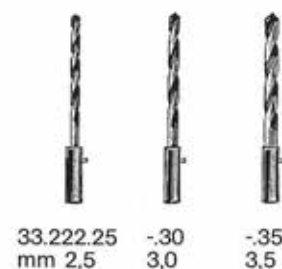
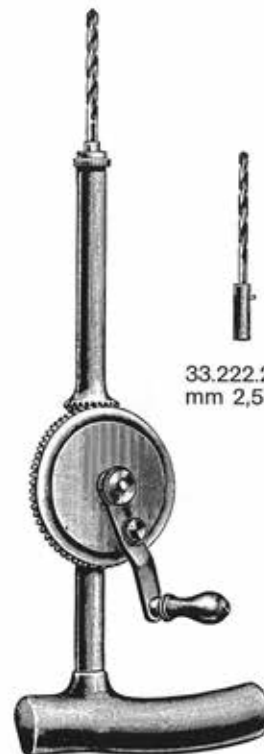

33.222.25 -30  
mm 2,5 3,0

-35  
3,5

STILLE-SHERMAN

33.220.24  
Compl. 24 cm

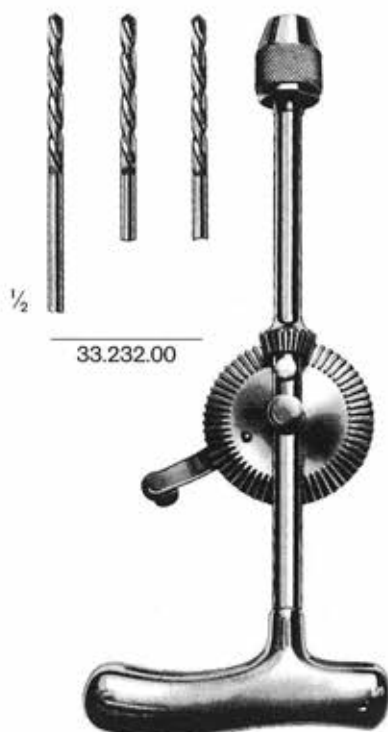

1/2

33.232.00

MOORE

33.230.28  
Compl. 28 cm

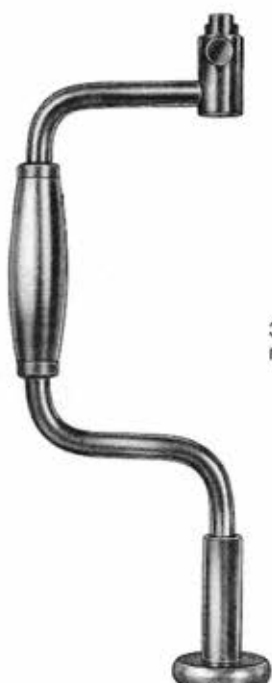

1/3  
33.242.09  
mm 9

1/3  
33.242.14  
14

1/3  
33.242.16  
16

1/3  
33.242.22  
22

1/3  
CUSHING  
33.244.14

33.246.00

McKENZIE  
33.248.00

HUDSON

33.240.27  
Compl. incl. 33.242.09, -14, -16, -22, 33.246.00  
27 cm

## Handbohrapparate

Bone Hand Drills  
Perforateurs à main  
Perforadores a mano  
Perforatori a mano

**dimeda**<sup>®</sup>  
SURGICAL INSTRUMENTS

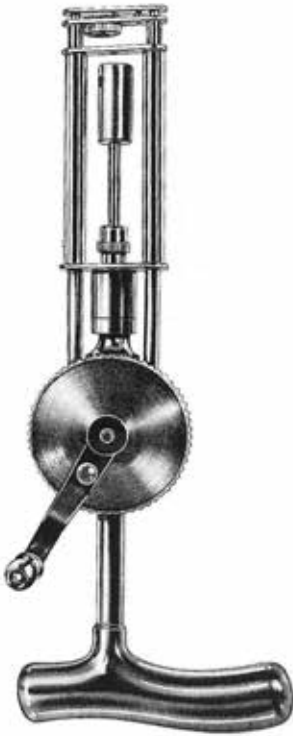

KIRSCHNER  
33.250.00  
Compl.



33.252.00



33.260.00  
Compl.



33.262.00

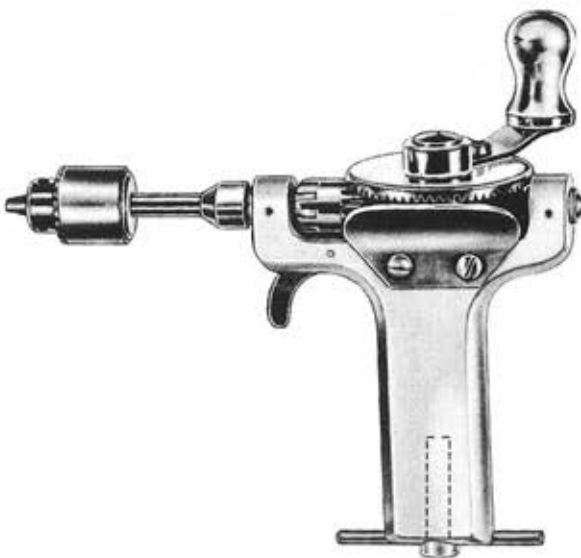

BUNNELL  
33.270.00  
16 cm



RALK  
33.280.00

Orthopädie, Osteosynthese / Bone Surgery, Osteosynthesis / Chirurgie osseuse, Ostéosynthèse / Chirurgia ósea, Osteosíntesi / Chirurgia ossea, Osteosintesi

## Bohrapparate

Bone Drills

Perforateurs à os

Perforadores para huesos

Perforatori per ossa

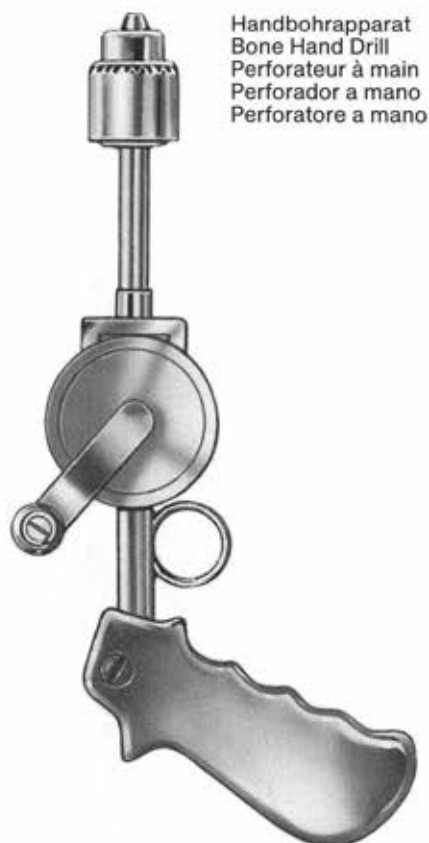

Handbohrapparat  
Bone Hand Drill  
Perforateur à main  
Perforador a mano  
Perforatore a mano

33.290.00



33.296.00

## Bohrer, Fräser, Trephinen

Burrs, Drills, Trephines  
 Mèches, fraises, trépan  
 Taladros, fresas, trefinas  
 Trapani, frese, trefine



mm			
1,0		33.352.10	33.354.10
1,2		33.352.12	
1,5		33.352.15	33.354.15
1,8		33.352.18	
2,0	33.350.20	33.352.20	33.354.20
2,2		33.352.22	
2,5	33.350.25	33.352.25	33.354.25
2,8		33.352.28	33.354.28
3,0	33.350.30	33.352.30	33.354.30
3,2	33.350.32	33.352.32	33.354.32
3,5	33.350.35	33.352.35	33.354.35
4,0	33.350.40	33.352.40	33.354.40
5,0	33.350.50	33.352.50	33.354.50
6,0	33.350.60		33.354.60
7,0	33.350.70		



mm Ø	DOYEN	DOYEN	DOYEN	DOYEN	ALBEE	ALBEE	BORCHARDT	TOTI
4	33.362.04	33.364.04						
6	33.362.06	33.364.06						
7						33.374.07		
8	33.362.08	33.364.08		33.368.08	33.372.08			33.378.08
10	33.362.10	33.364.10		33.368.10	33.372.10			
12	33.362.12	33.364.12	33.366.12		33.370.12	33.372.12		
13							33.376.13	
14	33.362.14	33.364.14						
15					33.370.15			
16	33.362.16	33.364.16						
25								33.377.25

## Bohrinstrumente, Pfrieme

Boring Instruments, Awls

Instrumentos á percer, poinçons

Instrumental para perforar, Escariadores

Strumenti per perforazione, Lesine

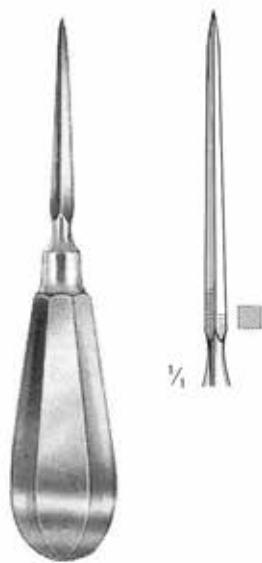

33.392.14  
14 cm

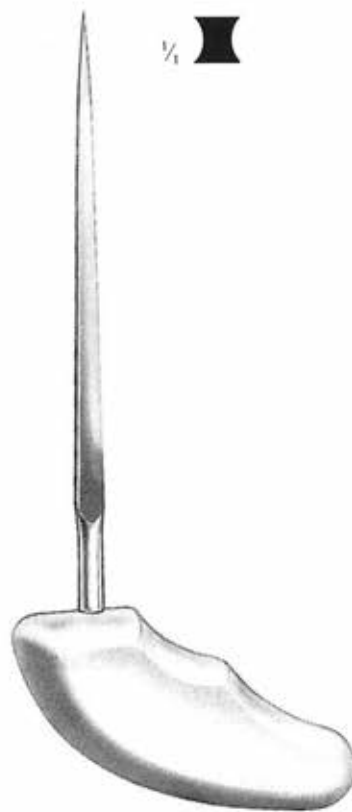

PERTHES  
33.395.21  
21 cm



**Bohrdrähte**

Wire Drills

Broches de KIRSCHNER

Taladros filiformes

Fili KIRSCHNER



Trokarspitze  
 Trocar tip  
 Pointe trocart  
 Punta en forma de trócar  
 Punte a tre quarti

mm Ø	L = 60 mm	L = 120 mm	L = 140 mm	L = 160 mm	L = 310 mm
1,0	33.406.10	33.412.10	33.414.10	33.416.10	33.431.10
1,2	33.406.12	33.412.12	33.414.12	33.416.12	33.431.12
1,4	33.406.14	33.412.14	33.414.14	33.416.14	33.431.14
1,5	33.406.15	33.412.15	33.414.15	33.416.15	33.431.15
1,6	33.406.16	33.412.16	33.414.16	33.416.16	33.431.16
1,8	33.406.18	33.412.18	33.414.18	33.416.18	33.431.18
2,0	33.406.20	33.412.20	33.414.20	33.416.20	33.431.20
2,2	33.406.22	33.412.22	33.414.22	33.416.22	33.431.22
2,5				33.416.25	33.431.25

KIRSCHNER  
 33.406.10 - 33.431.25



Lanzenspitze  
 Lancet tip  
 Pointe lancéolaire  
 Punta lanceolar  
 Punte lanceolari

mm Ø	L = 310mm
1,0	33.432.10
1,2	33.432.12
1,5	33.432.15
1,6	33.432.16
1,8	33.432.18
2,0	33.432.20
2,2	33.432.22
2,5	33.432.25

KIRSCHNER  
 33.432.10 - 33.432.25



STEINMANN Nägel  
 STEINMANN Pins  
 STEINMANN clous à os  
 STEINMANN clavos p. huesos  
 STEINMANN chiodi per ossa

L cm	
13	33.490.13
14	33.490.14
15	33.490.15
16	33.490.16
18	33.490.18
20	33.490.20
21	33.490.21

STEINMANN  
 33.490.13 - 33.490.21



## Exentionsbügel

Extension Bow  
Etriers à exention  
Estribos para extensión  
Archi per estensione

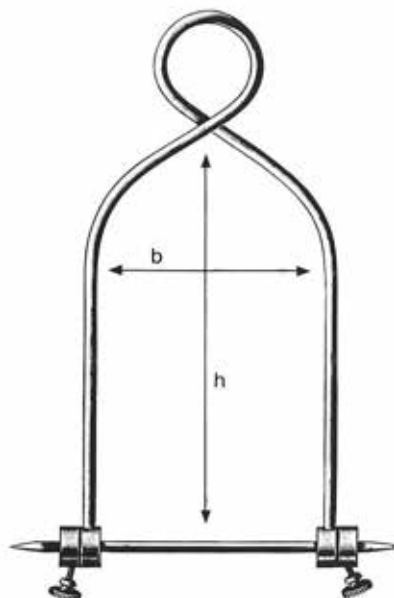

hxb cm	BOEHLER
16x 9	33.502.16
16x 11	33.502.21

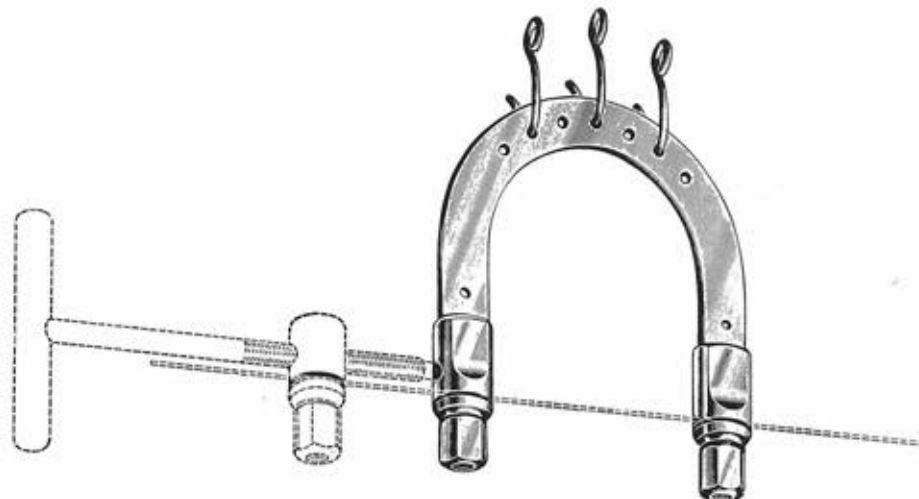

hxb cm	KIRSCHNER
6,0x 5,0	33.512.06
9,5x 7,0	33.512.09
10,5x 10,5	33.512.10
9,5x 11,0	33.512.11
12,0x 12,0	33.512.12
13,5x 13,0	33.512.13
15,5x 15,5	33.512.15
20,0x 15,5	33.512.20



hxb cm	
18x 10	33.514.18
27x 16	33.514.27



33.515.01



33.515.02



KIRSCHNER U.S.  
33.518.01  
klein · small · petit  
pequeño · piccolo  
33.518.02  
groß · large size  
grand · grande  
33.518.03  
extra groß · extra large size  
extra grand · extra grande



33.519.01



33.519.02

## Knochendraht und -Instrumente

Bone Wire and Instruments

Fil à os et instruments

Hilo para huesos e instrumentos

Filo per ossa e strumenti

**dimeda**<sup>®</sup>  
SURGICAL INSTRUMENTS



10 m

weich  
soft  
souple  
blando  
morbido

mm Ø

0,2	33.530.02
0,3	33.530.03
0,4	33.530.04
0,5	33.530.05
0,6	33.530.06
0,7	33.530.07
0,8	33.530.08
0,9	33.530.09
1,0	33.530.10
1,2	33.530.12
1,5	33.530.15



LOUTE  
33.531.21  
21 cm



33.532.17  
17 cm

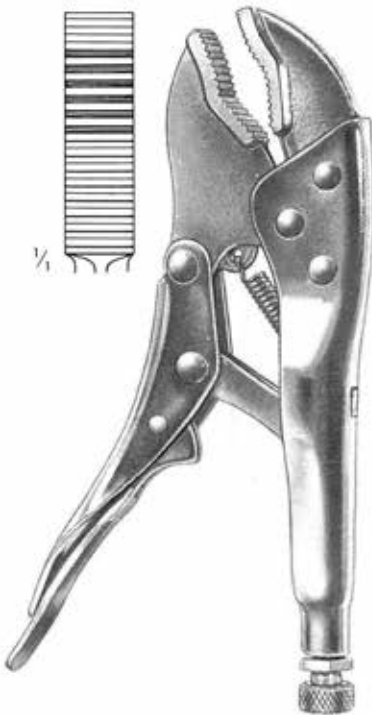

Grip  
33.533.18  
18 cm



33.534.15  
15 cm



33.536.14  
14 cm

## Knochenchirurgie

Bone Surgery  
Chirurgie osseuse  
Ciurgia ósea  
Chirurgia ossea



33.540.16  
16 cm

33.542.15  
15 cm

33.545.22  
22 cm

mm Ø	
2,4	33.560.24
3,2	33.560.32
4,8	33.560.48
6,4	33.560.64

	33.562.24	33.562.32	33.562.48	33.562.64
f./p. Ø	2,4 mm	3,2 mm	4,8 mm	6,4 mm

**Knochennagelung**  
 Bone Nailing  
 Enclouage des os  
 Enclavamiento de huesos  
 Inchiodamento di ossa



KUENTSCHER  
 33.571.26  
 26 cm



KUENTSCHER  
 33.573.35  
 35 cm



33.581.35-  
 33.585.60

mm Ø	L = 35 cm	L = 46 cm	L = 60 cm
2,5	33.581.35	33.581.46	
3,0	33.582.35	33.582.46	
3,5	33.583.35	33.583.46	33.583.60
4,0	33.584.35	33.584.46	33.584.60
5,0	33.585.35	33.585.46	33.585.60



KUENTSCHER  
 33.586.21  
 21 cm



KUENTSCHER  
 33.588.21  
 21 cm



1/3  
 33.590.01



1/3  
 33.590.02



1/3  
 33.590.03



33.590.04



KUENTSCHER  
 33.590.00  
 63 cm

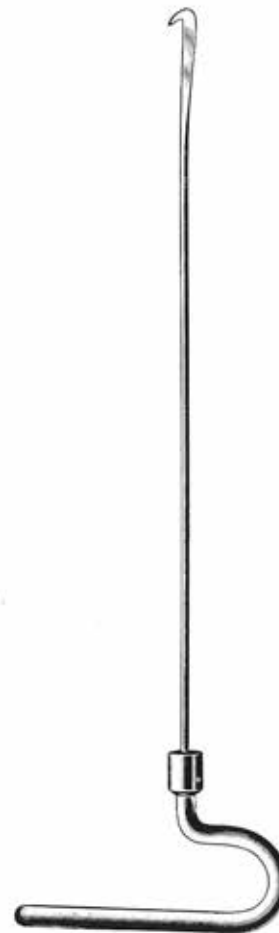

cm	
29	33.596.29
37	33.596.37
42	33.596.42
49	33.596.49



33.598.30

Orthopädie, Osteosynthese / Bone Surgery, Osteosynthesis / Chirurgie osseuse, Ostéosynthèse / Chirurgia ósea, Osteosíntesi / Chirurgia ossea, Osteosintesi



## Instrumente zur Osteosynthese

Osteosynthesis Instruments  
 Instruments pour ostéosynthèse  
 Instrumentos para osteosíntesis  
 Strumenti per osteosintesi



LLOYD  
 33.602.20  
 20 cm



LANE  
 33.620.25  
 25 cm



WILLIAMS  
 33.624.24  
 24 cm



mm	
2,5	33.628.25
3,5	33.628.35



LANE  
 33.632.25  
 25 cm



LANE  
 33.635.18  
 18 cm



LANE  
 33.637.23  
 23 cm



LANE  
 33.639.22  
 22 cm



LANE  
 33.640.18  
 18 cm

## Instrumente zur Osteosynthese

Osteosynthesis Instruments  
Instruments pour ostéosynthèse  
Instrumentos para osteosíntesis  
Strumenti per osteosintesi

**dimeda**<sup>®</sup>  
SURGICAL INSTRUMENTS



**33.645.00**



**33.642.00**  
13 cm/5"



**33.643.01**  
14,5 cm/5½"



**33.643.01**  
14,5 cm/5½"



**33.650.14**  
13,5 cm/5¼"



**33.670.00**

## Instrumente zur Osteosynthese

Osteosynthesis Instruments  
Instruments pour ostéosynthèse  
Instrumentos para osteosíntesis  
Strumenti per osteosintesi

Instrumentarium zum Einbringen von Hohlschrauben  
Instrument Set for Cannulated Screws  
Instrumentation pour l'application des vis à perforation longitudinale  
Instrumental para la aplicación de tornillos de perforación longitudinal  
Strumentario per viti cannulate



Ø mm	
4,5	33.802.45
7,0	33.802.70



33.810.05  
5 mm

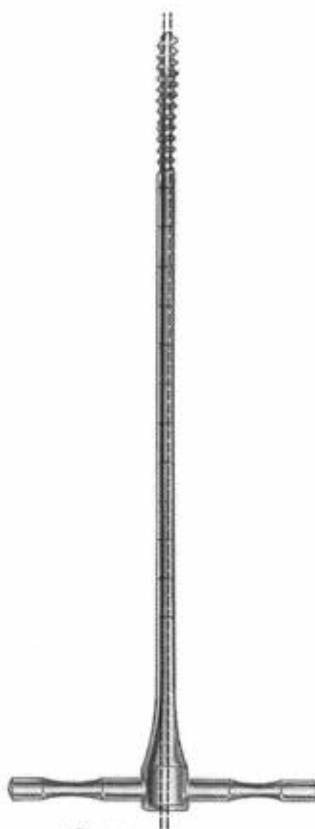

Ø mm	
4,5	33.812.45
7,0	33.812.70

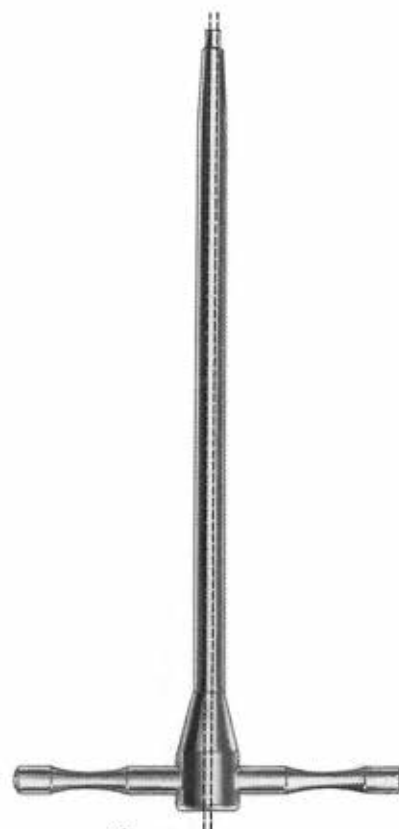

Ø mm	
2,5	33.816.25
3,5	33.816.35
5,0	33.816.50



33.820.00





Neurochirurgie  
Neurosurgery  
Neurochirurgie  
Neurocirugía  
Neurochirurgia

**Spezialkatalog**

Special catalog  
Catalogue spécial  
Catálogo especial  
Catalog speciale

***dimeda***<sup>®</sup>  
SURGICAL INSTRUMENTS



Neurochirurgie  
Neurosurgery  
Neurochirurgie  
Neurocirugía  
Neurochirurgia



Ophthalmologie  
Ophthalmology  
Ophtalmologie  
Oftalmología  
Oftalmologia

## Ophthalmologie

Ophthalmology  
Ophthalmologie  
Ofthalmología  
Ofthalmologia

Sperrelevatoren  
Eye Specula  
Blépharostats  
Blefarostatos  
Blefarostati

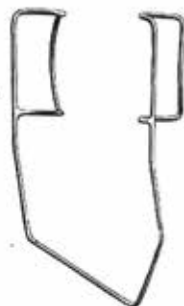

cm BARRAQUER (Colibri)  
3 42.101.03  
4 42.101.04



BOWMAN  
42.104.07  
7 cm

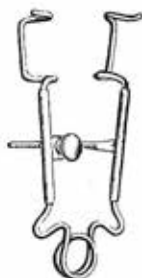

CRITCHETT  
42.105.06  
7 cm



SMITH  
42.106.05  
5 cm



CLARK  
42.107.08  
8 cm



cm GRAEFE  
7 42.109.06  
9 42.109.07



WEEK  
42.110.08  
8 cm

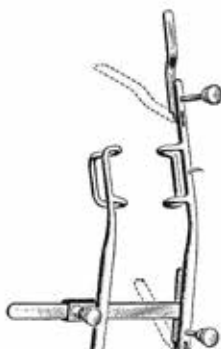

ARRUGA  
42.111.07  
7 cm · rechts ·  
right · à droite ·  
a la derecha ·  
destro

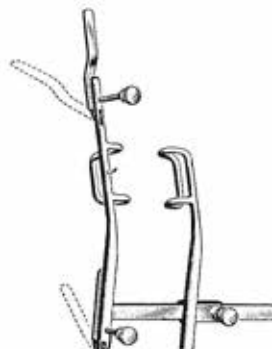

ARRUGA  
42.113.07  
7 cm · links ·  
left · à gauche ·  
a la izquierda ·  
sinistro



MURDOCK  
42.115.05  
5 cm



MELLINGER-AXENFELD  
42.121.07  
7 cm



MELLINGER-AXENFELD  
42.123.07  
7 cm



cm MELLINGER  
5 42.125.05  
7 42.125.07



LISTER-BURCH  
42.127.08  
8 cm



WILLIAMS  
42.128.08  
8 cm

**Ophthalmologie**

Ophthalmology  
Ophthalmologie  
Ofthalmología  
Ofthalmologia

Sperrelevatoren  
Eye Specula  
Blépharostats  
Blefarostatos  
Blefarostati



LANCASTER  
42.129.07  
7 cm



ZIEGLER  
42.130.07  
7 cm



CASTROVIEJO  
42.132.08  
8 cm



PARK  
42.133.08  
8 cm



MUELLER  
42.135.07  
7 cm



GOLDSTEIN  
42.137.07  
3 cm



STEVENSON  
42.139.07  
7 cm



Lidplatte  
Lid Plate  
Plaque à paupières  
Placa para párpados  
Placca per palpebre

JAEGER  
42.150.11  
11 cm

Starmesser  
Cataract Knives  
Couteaux à cataracte  
Cuchillos para catarata  
Coltelli per cataratta



GRAEFE  
42.170.00-42.170.03



1/4  
42.170.00  
Fig. 0



42.170.01  
Fig. 1



42.170.02  
Fig. 2



42.170.03  
Fig. 3



DEUTSCHMANN  
42.172.13  
13 cm

## Verschiedene Augenmesser

Various Eye Knives

Couteaux oculaires divers

Cuchillos oculares varios

Coltelli diversi per oculistica



42.180.01-42.218.12

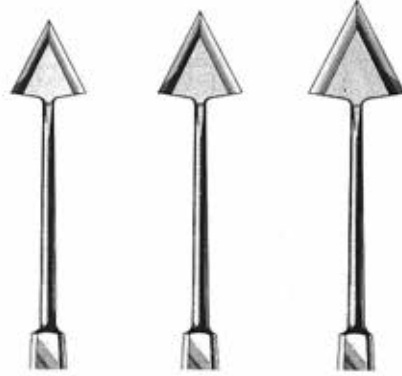

JAEGER

42.180.01  
Fig. 1

42.180.02  
Fig. 2

42.180.03  
Fig. 3



JAEGER 45°

42.181.01  
Fig. 1

42.181.02  
Fig. 2

42.181.03  
Fig. 3



BERENS  
42.183.13  
13 cm



CASTROVIEJO  
42.185.13  
4 x 13 mm  
13 cm



GRAEFE  
42.187.13  
13 cm

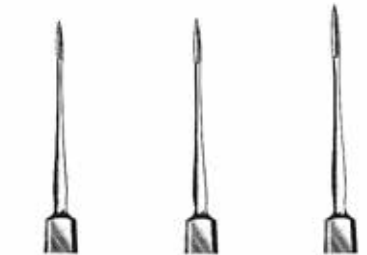

KNAPP

42.202.01  
Fig. 1

42.202.02  
Fig. 2

42.202.03  
Fig. 3



ZIEGLER

42.210.01  
Fig. 1  
5 mm

42.210.02  
Fig. 2  
6 mm

42.210.03  
Fig. 3  
7 mm



DEAN  
42.213.12  
12,5 cm



BOWMAN

42.214.04  
0,4 mm  
13 cm



42.214.08  
0,8 mm  
13 cm



WHEELER  
42.218.12  
12 cm



ZIEGLER  
42.221.11  
11 cm, 3,5 mm



SATO  
42.226.12  
12,5 cm



TOOK  
42.228.12  
12 cm



GILL  
42.231.12  
12 cm



ELSCHNIG  
42.233.13  
13 cm



KUHNT  
42.240.01  
Fig. 1



KUHNT  
42.240.02  
Fig. 2



KUHNT  
42.240.03  
Fig. 3



KUHNT  
42.240.04  
Fig. 4



PATON  
42.245.12  
12 cm



LUNDSGAARD  
42.251.12  
12 cm



GUYTON-  
LUNDSGAARD  
42.253.12



BARRKAN  
42.256.12



SCHEIE  
42.258.12



BURCH  
42.262.12



PAUFIQUE  
42.271.11



BARRAQUER  
42.273.13



42.304.12



42.305.12



BOWMAN  
42.308.12



BOWMAN  
42.309.12



42.310.13



42.311.13



LEVINSON  
42.314.13



FRANCIS  
42.321.12



DAVIS  
42.325.13  
13 cm



# Ophthalmologie

Ophthalmology  
 Ophthalmologie  
 Oftalmología  
 Oftalmologia



LA FORCE  
42.327.12



DIX  
42.330.13



ELLIS  
42.331.11



WALTON  
42.332.12



WALTON  
42.334.12



ALVIS  
42.336.12



GREEN  
42.340.13



ROLLET  
42.342.12



42.351.01  
Fig. 1



GRAEFE  
42.351.02  
Fig. 2



42.351.03  
Fig. 3



JAMESON  
42.353.13



GREEN  
42.355.13



STEVENS  
42.357.13



ARRUGA  
42.363.01  
Fig. 1



42.363.02  
Fig. 2



O'CONNOR  
42.370.12



WIENER  
42.372.13



WIENER  
42.373.13



ROLLET  
42.376.13



KNAPP  
42.377.13



42.380.13



GRAEFE  
42.381.13



42.383.13



BECKER  
42.386.13

**Ophthalmologie**

Ophthalmology  
 Ophthalmologie  
 Oftalmología  
 Oftalmologia

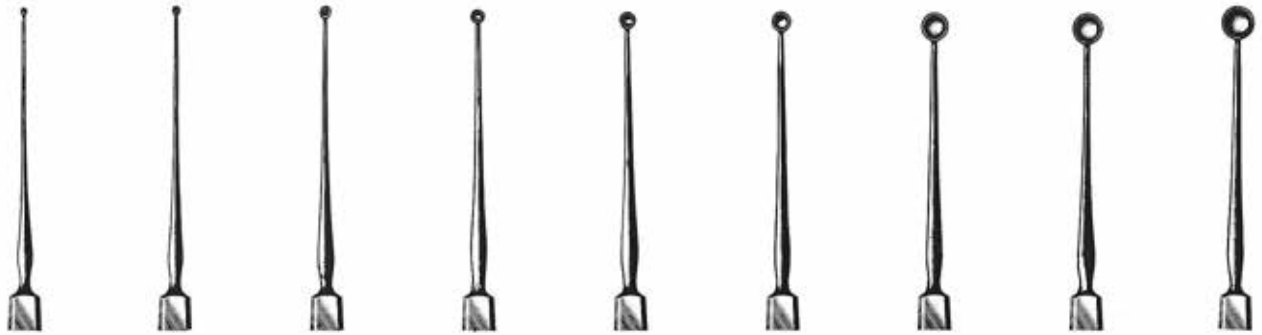

MEYHOEFER

	42.402.05	42.402.10	42.402.15	42.402.18	42.402.20	42.402.25	42.402.35	42.402.40	42.402.45
Ø mm	0,5	1,0	1,5	1,8	2,0	2,5	3,5	4,0	4,5

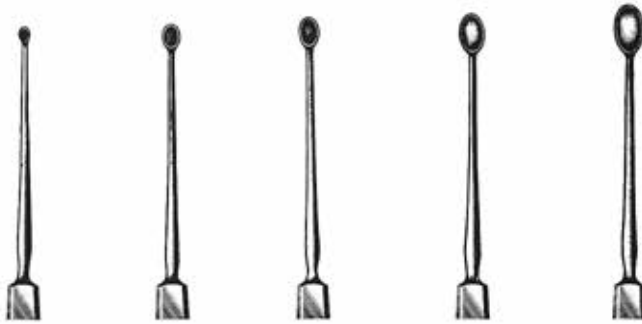

HEBRA

	42.404.10	42.404.20	42.404.25	42.404.30	42.404.35
Ø mm	1,0	2,0	2,5	3,0	3,5



AXENFELD  
 42.407.13



GRAEFE

42.410.01	42.410.02
-----------	-----------



DAVIEL

42.412.01	42.412.02
-----------	-----------



KNAPP  
 42.414.02

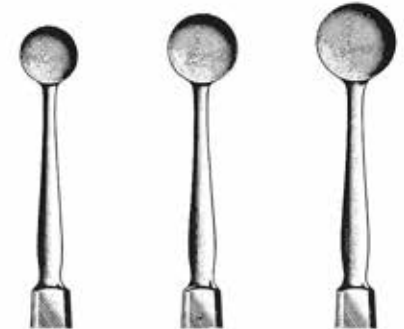

BUNGE

42.420.01	42.420.02	42.420.03
-----------	-----------	-----------

Ophthalmologie / Ophthalmology / Ophthalmologie / Oftalmología / Oftalmologia

## Drahtschlingen

Wire Loops  
Anses  
Asas  
Anse



LANG  
42.424.13



WEBER  
42.441.01 Fig. 1    42.441.02 Fig. 2



SNELLEN  
42.443.13

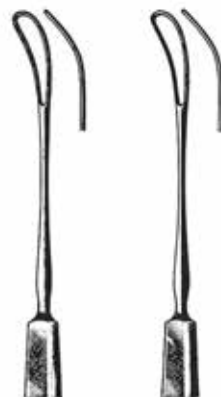

WILDER  
42.445.13 Fig. 1    42.447.13 Fig. 2



ARLT  
42.449.01    42.449.02

Iris · Iride

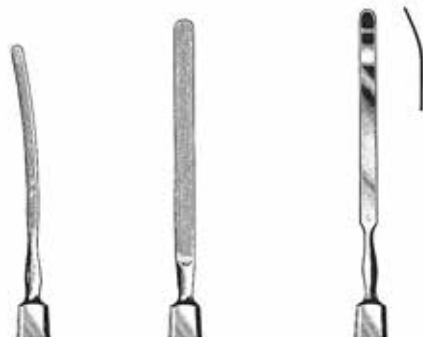

WECKER  
42.461.13    42.462.13

CULLER  
42.467.13



WELLS  
42.482.20

Schützer  
Protector  
Protecteur  
Protettore



ARRUGA  
42.485.13

Kauter · Cauter ·  
Cautère · Cauterio



WADSWORTH-TODD  
42.487.14

Zyklodialyse · Cyclodialysis · Cyclodialyse · Ciclodialisi · Ciclodialisi

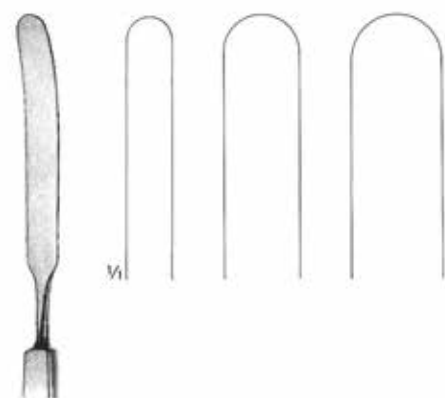

BANGERTER  
42.501.06 6 mm    42.501.10 10 mm    42.501.12 12 mm



42.511.13-42.517.09



CASTROVIEJO  
42.511.13 1,2x10 mm    42.513.14 1,5x15 mm



ELSCHNIG  
42.515.14 1,2x12 mm



CASTROVIEJO  
42.517.09 0,8x15 mm

**Zyklodialyse-Spatel, Fremdkörper-Instrumente**

Cyclodialysis Spatulae, Foreign Body Instruments  
 Spatules à cyclodialyse, Instruments à corps étranger  
 Espátulas para ciclodiálisis, Instrumentos para cuerpos extraños  
 Spatole per ciclodialisi, Strumenti per corpi estranei



CASTROVIEJO  
42.521.12



WHEELER  
42.523.12



mm	CASTROVIEJO
0,5	42.525.05
0,75	42.525.07
1,0	42.525.10



DIX  
42.542.12



DIX  
42.544.12

**Markier-Instrumente**  
 Markers  
 Marqueurs  
 Marcadores  
 Marcatori



DIX  
42.546.13



DIX  
42.548.13



CASTROVIEJO  
42.583.07  
0-20 mm



CONNIN-AMSLER  
42.589.13



DASTOOR  
42.590.06  
6 cm



HOLTH  
42.593.09

## Ophthalmologie

Ophthalmology  
Ophthalmologie  
Ofthalmología  
Ofthalmologia

Tränenang-Dilatatoren  
Lachrymal Dilators  
Dilatateurs pour canal lacrymal  
Dilatadores para canal lacrimal  
Dilatatori per canale lacrimale



WILDER  
42.602.01 42.602.02 42.602.03



Fig. ZIEGLER  
1/2 42.605.12  
3/4 42.605.34  
5/6 42.605.56



CASTROVIEJO  
42.608.12

Tränenkanal-Sonden  
Lachrymal Probes  
Stylets pour le canal lacrymal  
Estiletos para canal lacrimal  
Specilli per canale lacrimale



BOWMAN	Fig.	BOWMAN
42.614.00	00/0	42.616.00
42.614.01	0/1	42.616.01
42.614.12	1/2	42.616.12
42.614.23	2/3	42.616.23
42.614.34	3/4	42.616.34
42.614.45	4/5	42.616.45
42.614.56	5/6	42.616.56
42.614.67	6/7	42.616.67
42.614.78	7/8	42.616.78

Iris-Pinzetten · Iris Forceps ·  
Pincas à iris · Pinzas para iris · Pinze per iride



GRAEFE  
42.802.07  
7 cm/1 mm



GRAEFE  
42.803.07  
7 cm/1 mm



GRAEFE  
42.804.07  
7 cm/1 mm



GRAEFE  
42.805.07  
7 cm/1 mm

Fig.	00	0	1	2	3	4	5	6	7	8
Ø mm	0,7	0,8	0,9	1,1	1,3	1,4	1,5	1,6	1,8	1,9

## Iris Pinzetten

Iris Forceps  
Pincès à iris  
Pinzas para iris  
Pinze per iride



GRAEFE  
42.810.10  
10 cm



GRAEFE  
42.811.10  
10 cm

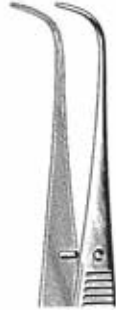

GRAEFE  
42.813.10  
10 cm



GRAEFE  
42.820.10  
10 cm



GRAEFE  
42.821.10  
10 cm



GRAEFE  
42.823.10  
10 cm



STEVENS  
42.830.10  
10,5 cm



STEVENS  
42.831.10  
10,5 cm



STEVENS  
42.833.10  
10,5 cm



STEVENS  
42.840.10  
10,5 cm



STEVENS  
42.841.10  
10,5 cm



STEVENS  
42.843.10  
10,5 cm



## Ophthalmologie

Ophthalmology  
Ophthalmologie  
Oftalmología  
Oftalmologia



FOERSTER  
42.850.08  
8,5 cm



FOERSTER  
42.851.08  
8,5 cm



FOERSTER  
42.852.08  
8,5 cm



FOERSTER  
42.853.08  
8,5 cm



HESS  
42.855.07  
7 cm/0,3 mm



HESS  
42.857.07  
7 cm/0,3 mm



GILL  
42.861.07  
7,5 cm/0,3 mm



GILL-HESS  
42.863.07  
7,5 cm/0,3 cm

Zähne unten  
teeth below  
dents en bas  
dientes abajo  
denti in basso

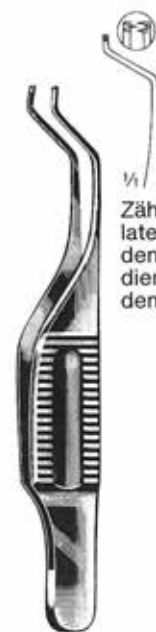

GILL-HESS  
42.865.07  
7,5 cm/0,3 mm

Zähne seitwärts  
lateral teeth  
dents laterales  
dientes laterales  
denti laterali



**Iris-, Strabismus-Pinzetten**

Iris, Strabismus Forceps  
 Pinces à iris et à strabisme  
 Pinzas para iris y para estrabismo  
 Pinze per iride e per strabismo

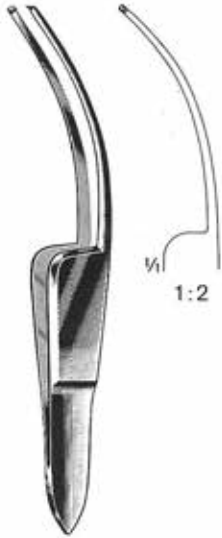

FISCHER  
 42.869.07  
 7 cm



BARRAQUER-KATZIN  
 42.881.07  
 7 cm/0,4 mm



TROUTMAN (Colibri)  
 42.883.07  
 7 cm/0,12 mm

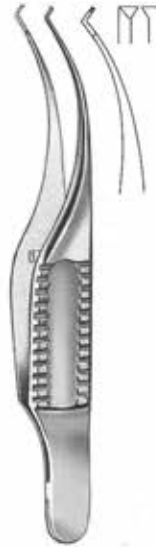

BARRAQUER (Colibri)  
 42.885.07  
 7 cm/0,12 mm

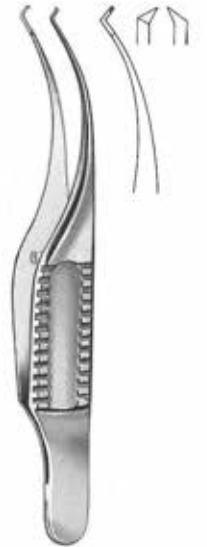

BARRAQUER (Colibri)  
 42.887.07  
 7 cm/0,12 mm

Ophthalmologie / Ophthalmology / Oftalmologia / Oftalmologia



KIRBY-ARTHUR  
 42.891.09  
 9 cm/0,2 mm



KIRBY-ARTHUR  
 42.893.09  
 9 cm/0,2 mm



McCULLOUGH  
 42.902.09  
 9,5 cm



McCULLOUGH  
 42.904.09  
 9,5 cm

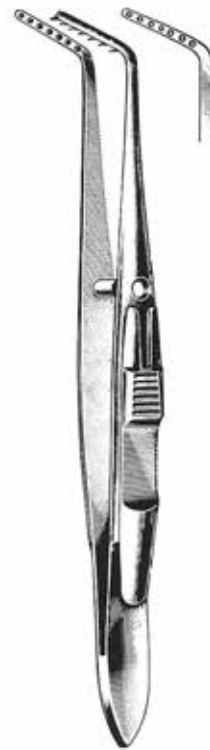

JAMESON  
 42.907.10  
 L, 10 cm



JAMESON  
 42.909.10  
 R, 10 cm

## Strabismus-Pinzetten

Strabismus Forceps  
Pincès à strabisme  
Pinzas para estrabismo  
Pinze per strabismo



BONACCOLTO  
42.914.10  
10 cm



BONACCOLTO  
42.916.10  
10 cm



BONACCOLTO  
42.920.11  
11 cm



DASTOOR  
42.924.11  
11 cm



DASTOOR  
42.926.11  
11 cm



BISHOP-HARMAN  
42.940.05  
8,5 cm/0,5 mm



BISHOP-HARMAN  
42.940.08  
8,5 cm/0,8 mm



BISHOP-HARMAN  
42.942.05  
8,5 cm/0,5 mm



BISHOP-HARMAN  
42.942.08  
8,5 cm/0,8 mm

Iris-Pinzetten · Iris Forceps · Pincès à iris ·  
Pinzas para iris · Pinze per iride



Mod. Bonn  
42.944.07  
7 cm/0,12 mm



Mod. Bonn  
42.946.07  
7 cm/0,12 mm

## Ophthalmologie

Ophthalmology  
Ophtalmologie  
Ofthalmología  
Ofthalmologia

**dimeda**<sup>®</sup>  
SURGICAL INSTRUMENTS

Iris-, Muskel-Pinzetten · Iris,  
Muscle Forceps · Pincès à iris, mus-  
culaires · Pinzas para iris, muscu-  
lares · Pinze per iride, muscolari



Mod. Bonn  
42.946.10  
10 cm/0,12 mm



Mod. Tübingen  
42.950.10  
42.954.10  
10 cm



Mod. Bonn  
42.952.10  
42.956.10  
10 cm/0,12 mm



Mod. Tübingen  
42.953.10  
42.957.10  
10 cm

Ophthalmologie / Ophthalmology / Ophtalmologie / Ofthalmologia / Ofthalmologia

## Ophthalmologie

Ophthalmology  
Ophthalmologie  
Ofthalmología  
Ofthalmologia



PRINCE  
43.011.10  
10 cm



PRINCE  
43.013.10  
10 cm



BERKE  
43.015.20-43.015.27



43.015.20

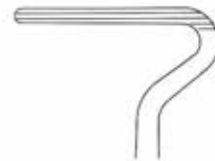

43.015.27

Rectus



TROUTMAN  
43.017.08  
8,5 cm/0,8 mm

Vorderkammer-Pinzette  
Anterior Chamber Forceps  
Pince à chambre antérieure  
Pinza para cámara anterior  
Pinza per camera anteriore

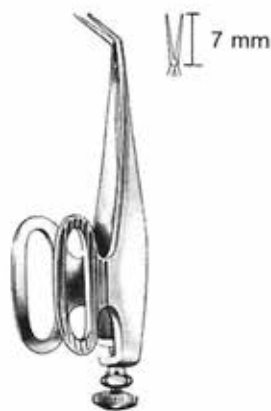

BARRAQUER  
43.021.05  
5,5 cm/7 mm

**Fixierpinzetten, Kapsel-Pinzetten**

Fixation Forceps, Capsular Forceps  
 Pincès à fixation, Pincès capsulaires  
 Pinzas para fijación, Pinzas capsulares  
 Pinza per fissaggio, Pinze capsulare



ELSCHNIG  
 43.046.11  
 11 cm



GRAEFE  
 43.050.11-43.052.11



LESTER  
 43.054.09  
 9 cm



CASTROVIEJO  
 43.066.09

1:1



CASTROVIEJO  
 43.067.09

1:1

Ophthalmology / Ophthalmologie / Oftalmologia / Oftalmologia



CASTROVIEJO  
 43.068.09

2:2



CASTROVIEJO  
 43.069.09

2:2



BARRAQUER  
 43.074.10  
 10 cm



GREEN  
 43.076.05-43.078.10  
 10 cm



43.076.05 43.076.10  
 5 mm 10 mm  
 ohne/without/sans  
 sin/senza



43.078.05 43.078.10  
 5 mm 10 mm  
 mit/with/avec/con

Schloß / catch /  
 crémaillère /  
 cierre/cremagliera



GILL-ARRUGA  
 43.101.07  
 7,5 cm



## Kapsel-Pinzetten

Capsular Forceps  
Pinces capsulaires  
Pinzas capsulares  
Pinze capsulare



TERSON  
43.103.09  
9 cm



KALT  
43.106.10  
10 cm



ELSCHNIG  
43.109.10  
10 cm



ARRUGA  
43.111.10  
10 cm



ARRUGA  
43.114.10  
10 cm



CASTROVIEJO  
43.115.10  
10 cm



SCHWEIGGER  
43.117.10  
10 cm



SCHWEIGGER  
43.119.10  
10 cm



ELSCHNIG  
43.121.10  
10 cm



HESS  
43.125.06  
6 cm



HESS  
43.127.06  
6,5 cm



FUCHS  
43.129.07  
7 cm

**Naht-, Faden-Pinzetten**

Suturing, Ligature Forceps  
 Pincès à sutures et à ligature  
 Pinzas para suturas y para ligaduras  
 Pinze per sutura e per legatura



**CASTROVIEJO**

Zahn  
tooth  
dent  
diente  
dente

0,12 mm	43.150.01	
0,3 mm	43.150.03	
0,5 mm	43.150.05	43.151.05
1,0 mm	43.150.10	43.151.10
1,5 mm	43.150.15	43.151.15



**MOORFIELD**  
 43.164.10  
 10 cm



**St. MARTIN**  
 43.166.07  
 7 cm



**Mod. Tübingen**  
 43.181.10  
 43.185.10  
 10 cm



**PAUFIQUE**  
 43.190.08  
 43.194.08  
 8,5 cm



**PAUFIQUE**  
 43.202.08  
 43.206.08  
 8,5 cm



**McPHERSON**  
 43.210.10  
 43.214.10  
 10 cm



**McPHERSON**  
 43.220.10  
 43.224.10  
 10 cm

Ophthalmologie / Ophthalmology / Ophthalmologie / Oftalmologia / Oftalmologia



**Pinzetten für Chalazion, Entropium, Trachom**

Forceps for Chalazio, Entropium, Trachoma

Pinces à chalazion, à entropion, à granulations du trachome

Pinzas de chalazión, de entropión y para tracoma

Pinze per calazio, per entropio e per trichiasi



AYER  
43.240.09  
9 cm



AYER  
43.242.09  
9 cm



LAMBERT  
43.246.09  
9 cm



DESMARRES  
43.254.09-43.258.09  
9 cm



43.254.09  
Fig. 1



43.256.09  
Fig. 2



43.258.09  
Fig. 3

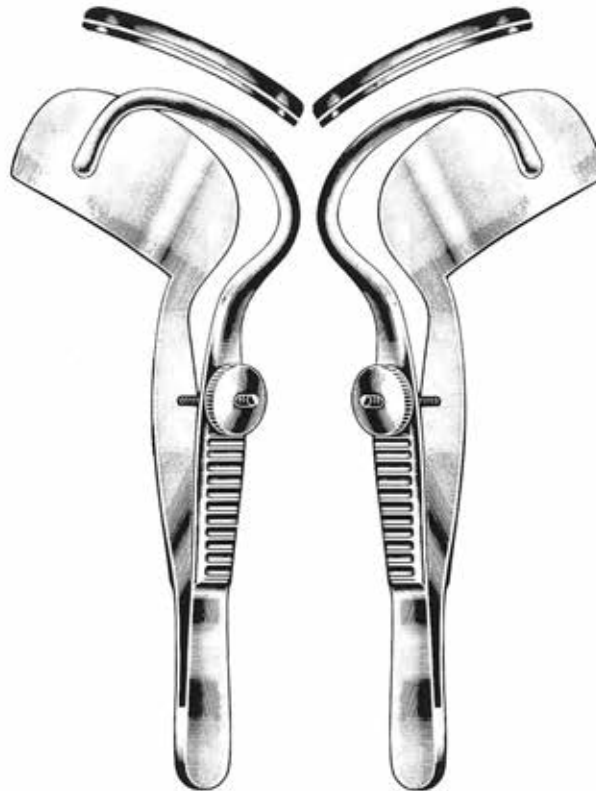

SNELLEN  
43.265.10  
10 cm

SNELLEN  
43.267.10  
10 cm

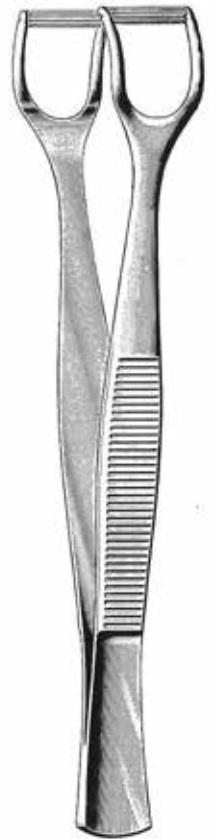

KNAPP-LUER  
43.274.11  
11 cm

**Augenkanülen**  
 Eye Cannula  
 Canules oculaires  
 Cánulas oculares  
 Cannule oculistiche



SCHEIE  
 43.302.28  
 1,0 x 28 mm



SCHEIE  
 43.302.33  
 1,5 x 33 mm



Mod. Tübingen  
 43.303.45



Mod. Hamburg  
 43.305.00



SIMCOE  
 43.306.00



Mod. Bonn  
 43.307.00



Mod. Bonn  
 43.309.00

**Hornhaut-Trephinen · Corneal Trephines**  
 Trépan cornéens · Trépanos corneales  
 Trefine corneali



CASTROVIEJO  
 43.310.50-43.311.01

Ø mm	CASTROVIEJO
5,0	43.310.50
5,5	43.310.55
6,0	43.310.60
6,5	43.310.65
7,0	43.310.70
8,0	43.310.80
9,0	43.310.90
10,0	43.311.00
11,0	43.311.01



FRANCESCETTI  
 43.320.50-43.321.00

Ø mm	FRANCESCETTI
5,0	43.320.50
5,1	43.320.51
6,0	43.320.60
6,1	43.320.61
7,0	43.320.70
7,1	43.320.71
8,0	43.320.80
8,1	43.320.81
9,0	43.320.90
9,1	43.320.91
10,0	43.321.00

## Ophthalmologie

Ophthalmology  
Ophthalmologie  
Ofthalmología  
Ofthalmologia



ELLIOT  
43.340.00  
compl. = 4

Tonometer · Tonómetro  
Tonometre



	SCHIOETZ	43.404.00	43.406.00
Skala	gerade	schräg	
scale	straight	oblique	
échelle	droite	oblique	
escala	recta	oblicua	
scala	retta	obliqua	



43.408.00

Augen-Magnet  
Eye Magnet  
Aimant à corps étrangers  
Imán para cuerpos extranjerros  
Calamita per corpi estranei

Cilien-Pinzetten · Cilia Forceps  
Pincas à épiler les cils · Pinzas  
depilatorias · Pinze depilatorie

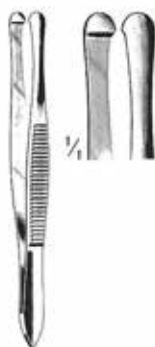

BEER  
43.420.09  
9 cm

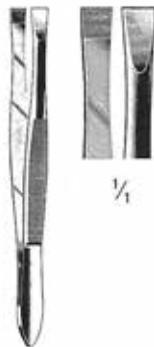

DOUGLAS  
43.422.09  
9 cm

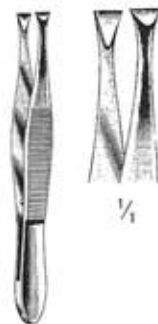

LITTAUER  
43.424.08  
8,5 cm



BARRAQUER  
43.425.10  
10,5 cm



43.426.09  
9 cm



GRADLE  
43.428.09  
9,5 cm



Otologie  
Otology  
Otologie  
Otología  
Otologia

## Ohr-Spekula

Ear Specula  
Spéculums auriculaires  
Espéculos auriculares  
Specoli auricolari

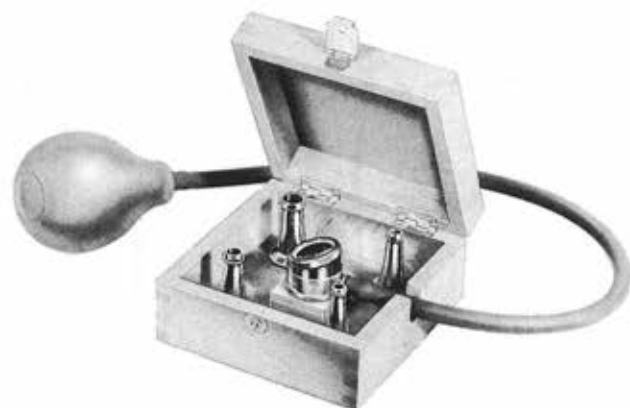
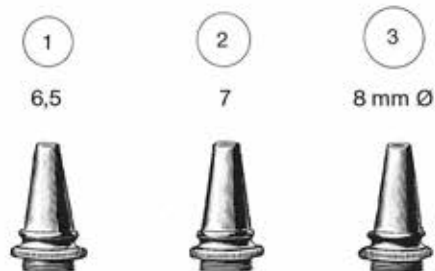
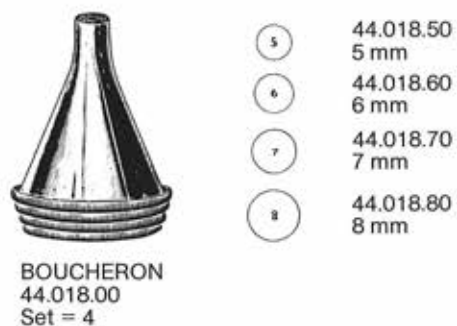
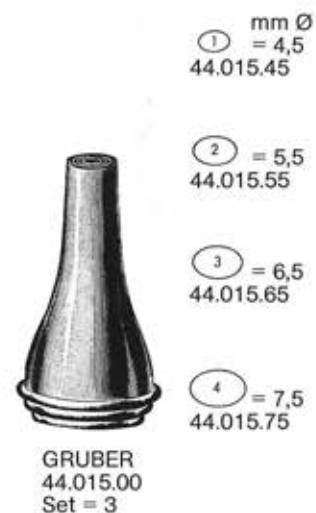
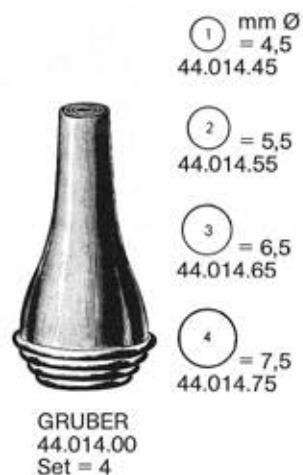



## Stimmgabeln

Tuning Forks  
Diapasons  
Diapasones  
Diapason

**dimeda**<sup>®</sup>  
SURGICAL INSTRUMENTS



DIMEDA Alu

44.060.01  
C 128

44.060.02  
C<sup>1</sup> 256

44.060.03  
C<sup>2</sup> 512

44.060.04  
C<sup>3</sup> 1024

44.060.05  
C<sup>4</sup> 2048



DIMEDA Alu  
44.061.00  
compl.

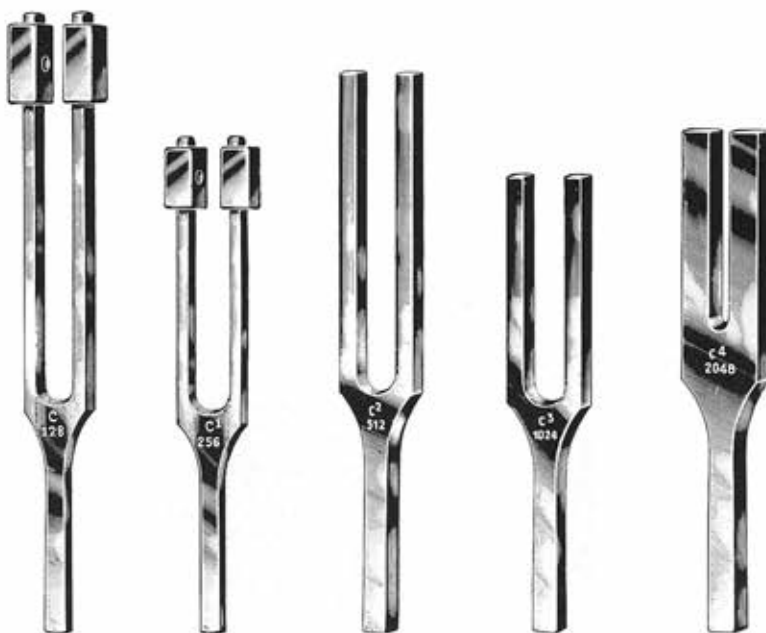

HARTMANN

44.070.01  
C 128

44.070.02  
C<sup>1</sup> 256

44.070.03  
C<sup>2</sup> 512

44.070.04  
C<sup>3</sup> 1024

44.070.05  
C<sup>4</sup> 2048



HARTMANN  
44.071.00  
compl.

Otologie / Otorlogie / Otorlogie / Otorlogie / Otorlogia

## Stimmgabeln

Tuning Forks  
Diapasons  
Diapasones  
Diapason



LUCAE  
44.074.01  
C 128



44.075.00  
neurolog.

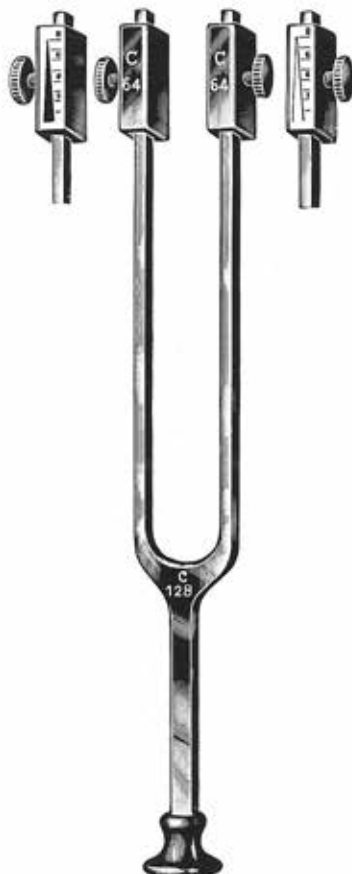

RYDEL-SEIFFER  
44.076.01  
C 64/c 128

Lärmapparat  
Noise Apparatus  
Assourdisseur  
Ensordecedor  
Assordatore



BARANY  
44.080.00

Pulverbläser  
Powder Blowers  
Lance-Poudre  
Lanzapolvero  
Insuffiatoi per polvere

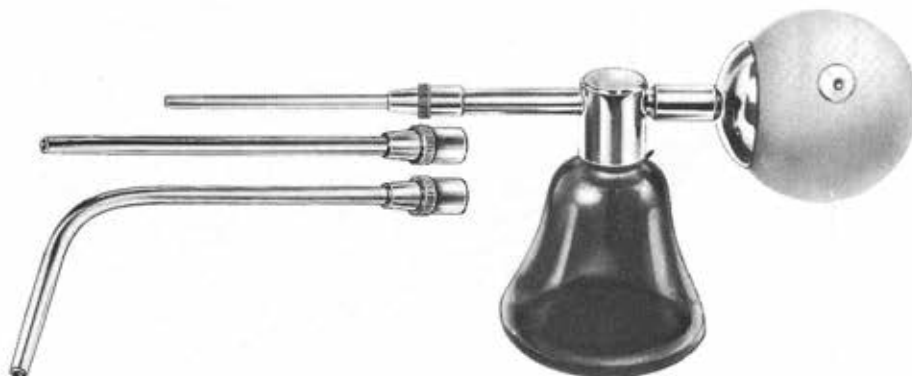

KABIERSKE  
44.090.00  
30 cc

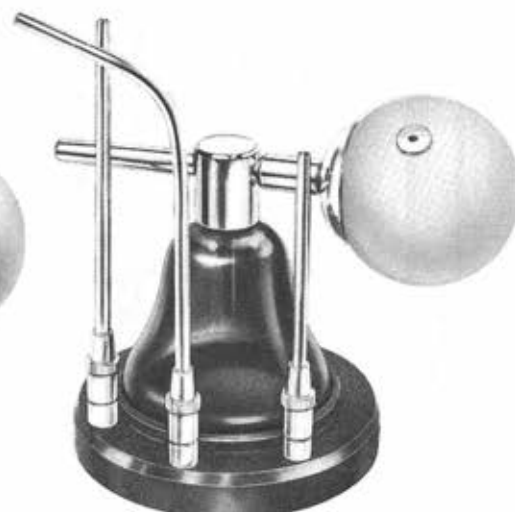

KABIERSKE  
44.090.01  
30 cc



**Luftdusche, Ohrspritze**

Air Bag, Ear Syringe  
 Insufflateur d'air, Seringue  
 Insuflador de aire, Jeringa  
 Insoffiatore d'aria, Siringa



44.091.03



44.091.04  
4 mm Ø



44.091.15  
15 mm Ø



44.091.17  
17 mm Ø



44.091.22  
22 mm Ø

**POLITZER**

44.091.00 = incl. 44.091.15, 44.091.17, 44.091.22, 44.091.03  
 44.091.01 = incl. 44.091.15, 44.091.17, 44.091.22, 44.091.03, 44.091.04

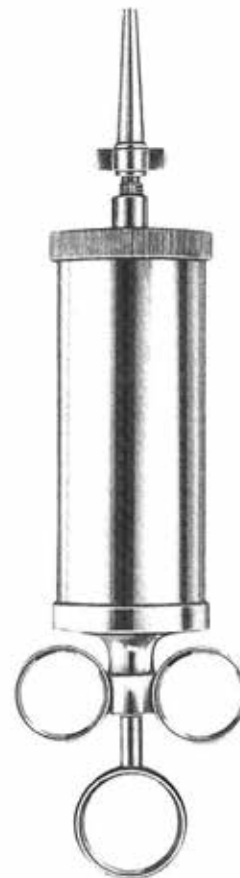

ml	REINER
50	44.096.50
75	44.096.75
100	44.097.10
150	44.097.15

**Küretten · Curettes ·  
 Curettes · Curetas ·  
 Curette**



	Fig. 00	0	1	2	3	4	5
stumpf · blunt mousses romas smusse	 44.109.00	 44.110.00	 44.110.01	 44.110.02	 44.110.03	 44.110.04	 44.110.05
scharf · sharp tranchantes cortantes taglianti	 44.111.00	 44.112.00	 44.112.01	 44.112.02	 44.112.03	 44.112.04	 44.112.05
stumpf · blunt mousses romas smusse	 44.114.00	 44.115.00	 44.115.01	 44.115.02	 44.115.03	 44.115.04	 44.115.05
scharf · sharp tranchantes cortantes taglianti	 44.116.00	 44.117.00	 44.117.01	 44.117.02	 44.117.03	 44.117.04	 44.117.05

### Katheter, Parazentesenadeln, Ohrmesser, Ohrlöffel

Catheters, Paracentesis Needles, Ear Knives, Ear Spoons  
 Sondes, Aiguilles à paracentèse, Couteaux auriculaires, Cuillers  
 Cateteres, Aguja para paracentesis, Cuchillos auriculares, Cucharas  
 Cateteri, Aghi per paracentesi, Coltelli auricolari, Cucchiari

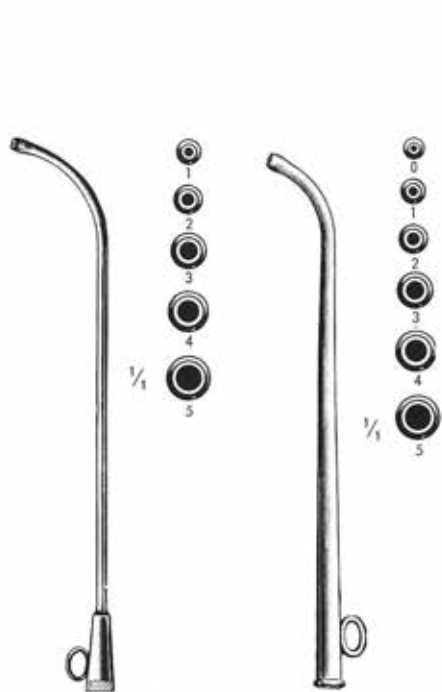

Fig.	HARTMANN	ITARD
0	44.131.00	
1	44.131.01	44.133.01
2	44.131.02	44.133.02
3	44.131.03	44.133.03
4	44.131.04	44.133.04
5	44.131.05	44.133.05



POLITZER  
44.150.18  
18 cm



POLITZER  
44.151.16  
16,5 cm



POLITZER  
44.153.16



POLITZER  
44.160.15  
15 cm



SEXTON  
44.162.18  
18 cm



SEXTON  
44.164.17  
17 cm



SEXTON  
44.165.17  
17 cm



GROSS  
44.170.12  
12 cm



GROSS  
44.171.12  
12 cm

**Schlingen, Häkchen, Pinzetten, Schnürer**

Loops, Hooklets, Dressing Forceps, Snares  
 Anses, Crochets, Pinces, Serrenoed  
 Asas, Granchitos, Pinzas, Cierranudos  
 Anse, Uncinetti, Pinze, Serranodi

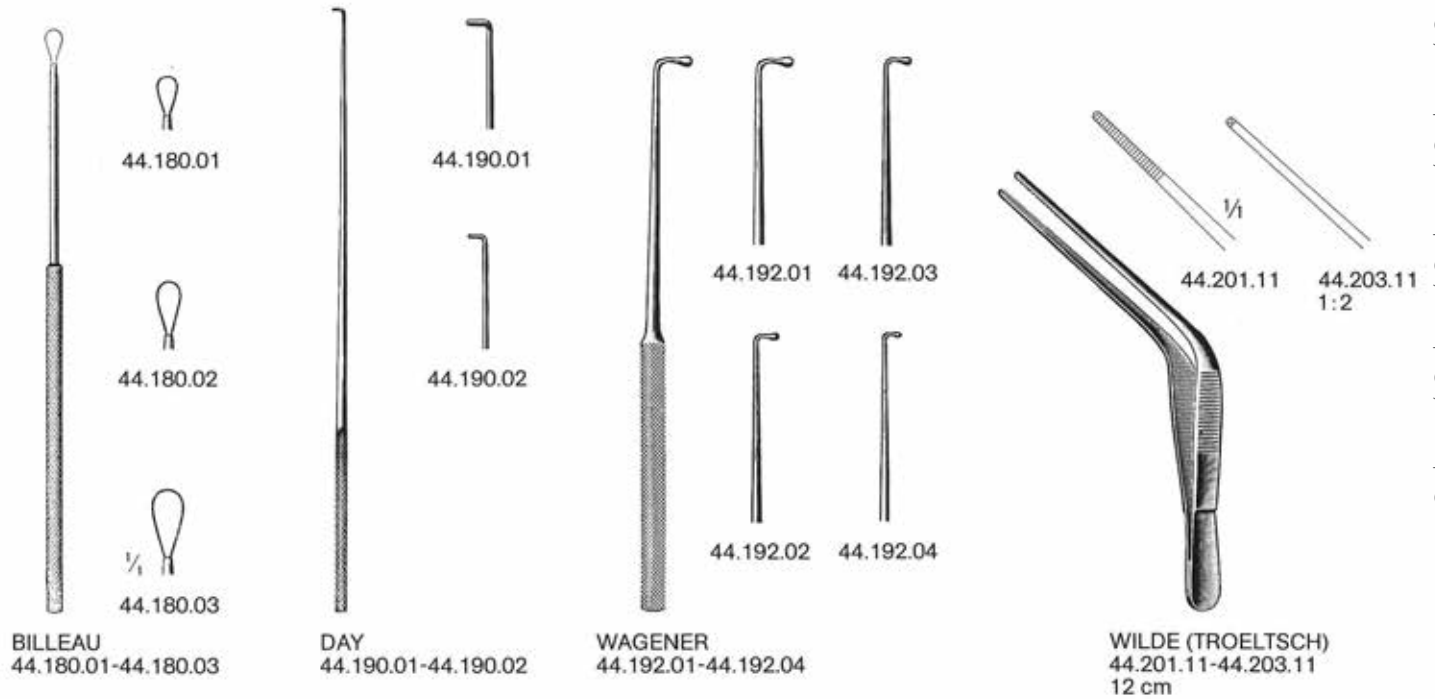

**BILLEAU**  
 44.180.01-44.180.03

**DAY**  
 44.190.01-44.190.02

**WAGENER**  
 44.192.01-44.192.04

**WILDE (TROELTSCH)**  
 44.201.11-44.203.11  
 12 cm

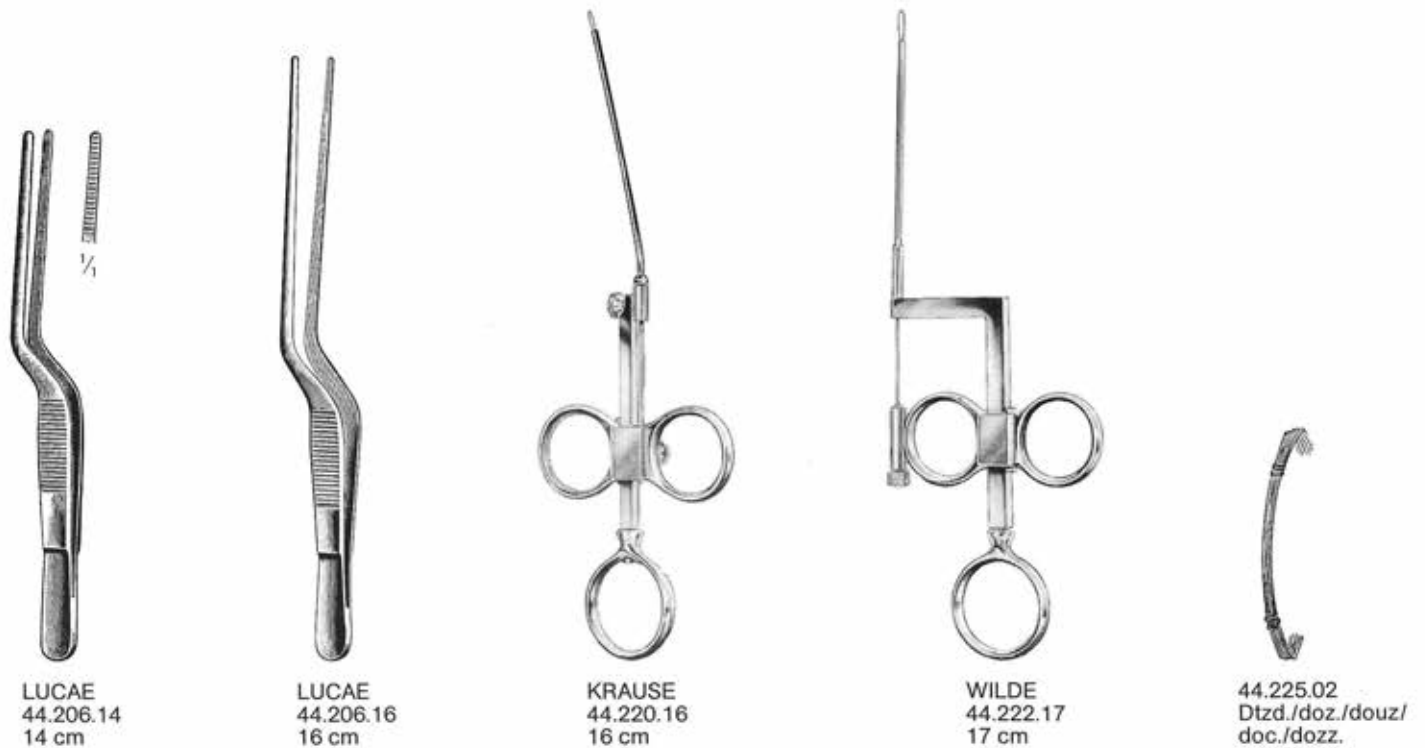

**LUCAE**  
 44.206.14  
 14 cm

**LUCAE**  
 44.206.16  
 16 cm

**KRAUSE**  
 44.220.16  
 16 cm

**WILDE**  
 44.222.17  
 17 cm

**44.225.02**  
 Dtzd./doz./douz/  
 doc./dozz.

## Ohrzängchen

Ear Forceps  
Pincès auriculaires  
Pinzas auriculares  
Pinze auricolari



TILLEY  
44.243.14  
14 cm



LITTAUER  
44.245.12  
12 cm

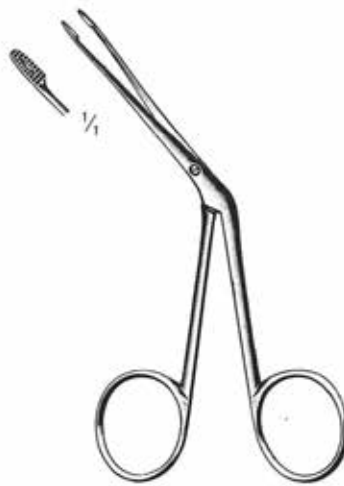

HARTMANN  
44.241.12  
12 cm



HARTMANN  
44.241.14  
14 cm



QUIRE  
44.251.10  
10 cm

Fremdkörperheber  
Foreign Body Levers  
Leviers pour corps étrangers  
Elevadores para cuerpos extranjeros  
Leve per corpi estranei



BUCK  
44.253.11  
11 cm



44.255.08-44.275.08



HARTMANN-WULLSTEIN  
44.255.08  
8,5 cm



HARTMANN-WULLSTEIN  
44.257.08  
8,5 cm



cm	HARTMANN
8,5	44.261.08
14,0	44.261.14
16,0	44.261.16



cm	HARTMANN
8,5	44.263.08
14,0	44.263.14



HARTMANN  
44.265.08  
8,5 cm



Ø mm	HARTMANN
2,0	44.267.20
2,5	44.267.25
3,0	44.267.30

8,5 cm

○ 3 mm



HARTMANN  
44.269.30  
8,5 cm



STRUEMPEL  
44.271.08  
8,5 cm



HARTMANN  
44.273.08  
8,5 cm

○ 2 mm



HARTMANN-HOFFMANN  
44.275.08  
8,5 cm

**Otologie**

Otology  
Otologie  
Otología  
Otologia

Mikro-Ohrscherchen  
Micro Ear Scissors  
Ciseaux auriculaires micro  
Tijeras auriculares micro  
Forbici auricolari micro



44.310.40-44.322.70



BELLUCCI  
44.310.40  
micro mini  
4 mm



BELLUCCI  
44.312.55  
micro standard  
5,5 mm



BELLUCCI  
44.313.55  
micro standard  
5,5 mm



BELLUCCI  
44.315.55  
micro standard  
5,5 mm



BELLUCCI  
44.317.55  
micro standard  
5,5 mm



SHEA  
44.320.70  
7,0 mm



SHEA  
44.321.70  
7,0 mm



SHEA  
44.322.70  
7,0 mm

Mikro-Ohrzängchen  
Micro Ear Forceps  
Pinces auriculaires micro  
Pinzas auriculares micro  
Pinze auricolari micro



44.350.40-44.360.35



44.350.40  
4 mm



44.350.70  
7 mm



44.352.40  
4 mm



44.353.60  
6 mm



44.355.60  
6 mm



44.357.40  
4 mm



44.359.40  
4 mm



44.360.35  
3,5 mm

## Mikro-Ohrzängchen

Micro Ear Forceps  
Pinces auriculaires micro  
Pinzas auriculares micro  
Pinze auricolari micro



44.362.45  
4,5 mm



44.363.45  
4,5 mm



44.365.45  
4,5 mm



44.367.50  
5,0 mm



44.369.50  
5,0 mm



44.362.45-44.371.40



McGEE  
44.370.50  
0,8x3,5 mm



McGEE  
44.371.40  
0,8x4,0 mm



DIETER  
44.385.01-44.387.02

Hammerkopf-Zwickzängchen  
Malleus Nippers  
Pinces pour la tête du marteau  
Pinzas para la cabeza del martillo  
Pinze per la testa del martello

micro



44.385.01

aufwärts  
upward  
en haut  
arriba  
in alto

mini



44.387.01



44.385.02

abwärts  
downward  
en bas  
abajo  
in basso



44.387.02



Modelle mit Ringgriff  
 Ring Handle Patterns  
 Modèles manches à anneaux  
 Modelos mangos con anillos  
 Modelli manici con anelli

Modelle mit Bleistiftgriff  
 Pencil Handle Patterns  
 Modèles manches crayon  
 Modelos mango en forma de lapiz  
 Modelli manico forma matita



44.410.00-44.419.00  
 micro  
 RG

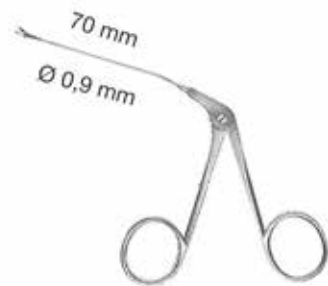

44.420.00-44.429.00  
 micro-mini  
 RG

44.410.00		44.430.00
44.412.00		44.432.00
44.413.00		44.433.00
44.415.00		44.435.00
44.417.00		44.437.00
44.419.00		44.439.00
		44.439.08
44.420.00		44.440.00
44.422.00		44.442.00
44.423.00		44.443.00
44.425.00		44.445.00
44.427.00		44.447.00
44.429.00		44.449.00

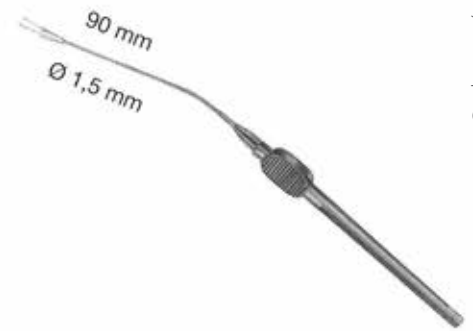

44.430.00-44.439.08  
 micro  
 BG

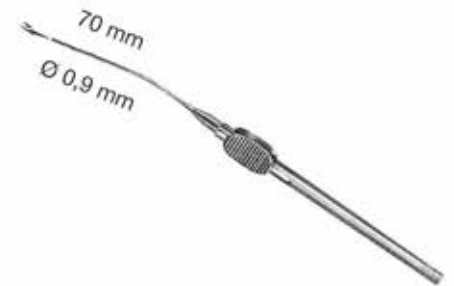

44.440.00-44.449.00  
 micro-mini  
 BG



## Mikro-Ohrzängchen

Micro Ear Forceps  
Pincès auriculaires micro  
Pinzas auriculares micro  
Pinze auricolari micro



Modelle mit Ringgriff  
Ring handle Patterns  
Modèles manches à anneaux  
Modelos mangos con anillos  
Modelli manici con anelli

44.510.00-44.549.00  
micro  
RG

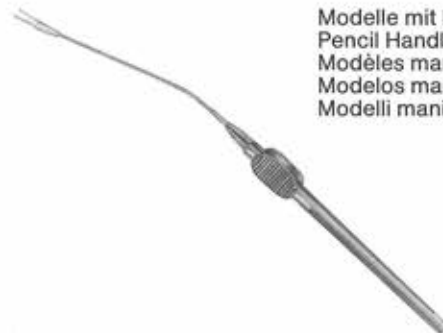

Modelle mit Bleistiftgriff  
Pencil Handle Patterns  
Modèles manches crayon  
Modelos mango en forma de lapiz  
Modelli manico forma matita

44.610.00-44.649.00  
micro  
BG

44.510.00		44.610.00
44.511.00		44.611.00
44.513.00		44.613.00
44.514.00		44.614.00
44.515.00		44.615.00
44.516.00		44.616.00
44.517.00		44.617.00
44.519.00		44.619.00
44.520.00		44.620.00
44.521.00		

Ø 1 mm    Ø 1,5 mm    Ø 2 mm    Ø 2,5 mm

44.522.00    44.528.00    44.534.00    44.540.00

44.523.00    44.529.00    44.535.00    44.541.00

44.525.00    44.531.00    44.537.00    44.543.00

44.527.00    44.533.00    44.539.00    44.545.00

44.546.00 44.646.00

44.547.00 44.647.00

44.548.00 44.648.00

44.549.00 44.649.00

Ø 1 mm    Ø 1,5 mm    Ø 2 mm    Ø 2,5 mm

44.622.00    44.628.00    44.634.00    44.640.00

44.623.00    44.629.00    44.635.00    44.641.00

44.625.00    44.631.00    44.637.00    44.643.00

44.627.00    44.633.00    44.639.00    44.645.00

## Mikro-Ohrzangchen

Micro Ear Forceps  
Pinces auriculaires micro  
Pinzas auriculares micro  
Pinze auricolari micro

Modelle mit Ringgriff  
Ring Handle Patterns  
Modèles manches à anneaux  
Modelos mangos con anillos  
Modelli manici con anelli

Modelle mit Bleistiftgriff  
Pencil Handle Patterns  
Modèles manches crayon  
Modelos mango en forma de lapiz  
Modelli manico forma matita



44.550.00-44.589.00  
micro-mini  
RG



44.650.00-44.689.00  
micro-mini  
BG

44.550.00		44.650.00
44.551.00		44.651.00
44.553.00		44.653.00
44.554.00		44.654.00
44.555.00		44.655.00
44.556.00		
44.557.00		44.657.00
44.559.00		44.659.00
44.560.00		44.660.00
44.561.00		
44.562.00		44.662.00
44.563.00		44.663.00
44.565.00		44.665.00
44.567.00		44.667.00
44.586.00		44.686.00
44.587.00		44.687.00
44.588.00		44.688.00
44.589.00		44.689.00

# Otologie

Otology  
Otologie  
Otología  
Otologia



SCHUKNECHT  
44.701.01



SCHUKNECHT  
44.701.02



SCHUKNECHT  
44.703.15  
15,5 cm



WULLSTEIN  
44.704.15  
15,5 cm



TABB  
44.705.15  
15,5 cm



PLESTER  
44.706.35  
15,5 cm/3,5 mm Ø



ROSEN  
44.709.10-44.709.30



44.709.10  
1,0 mm



44.709.14  
1,4 mm



44.709.16  
1,6 mm



44.709.20  
2,0 mm



44.709.26  
2,6 mm



44.709.28  
2,8 mm



44.709.30  
3,0 mm



44.710.15-44.725.10



BARBARA  
44.710.15



BARBARA  
44.711.15



BARBARA  
44.713.15

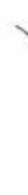

ROSEN  
44.715.15



25°



45°



90°



BARBARA

mm	BARBARA	BARBARA	BARBARA	BARBARA
0,3	44.720.03	44.722.03	44.724.03	44.725.05 = 0,5 mm
0,6	44.720.06	44.722.06	44.724.06	44.725.10 = 1,0 mm
1,0	44.720.10	44.722.10	44.724.10	
1,2		44.722.12	44.724.12	
1,5		44.722.15	44.724.15	
2,0		44.722.20	44.724.20	
2,5		44.722.25	44.724.25	

**Otologie**

Otology  
Otologie  
Otología  
Otologia



mm	90°	90°	mm	McGEE	McGEE	BARBARA
0,3	44.730.03	44.732.03	0,5	44.733.05	44.735.05	44.736.15
0,6	44.730.06	44.732.06	1,0	44.733.10	44.735.10	15,5 cm
1,0	44.730.10	44.732.10				

ROSEN  
44.737.15  
15,5 cm

mm	25°	25°	45°	45°
0,3	44.741.03	44.743.03	44.745.03	44.747.03
0,6	44.741.06	44.743.06	44.745.06	44.747.06
1,0	44.741.10	44.743.10	44.745.10	44.747.10

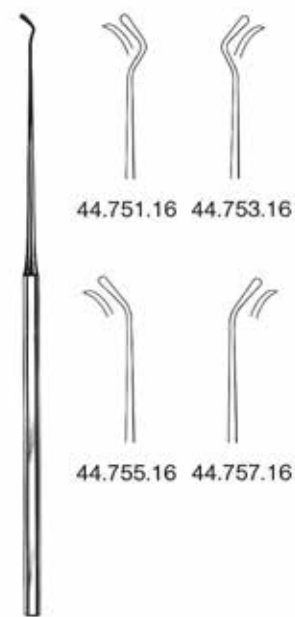

FISCH  
44.751.16-44.757.16

44.751.16 44.753.16  
44.755.16 44.757.16

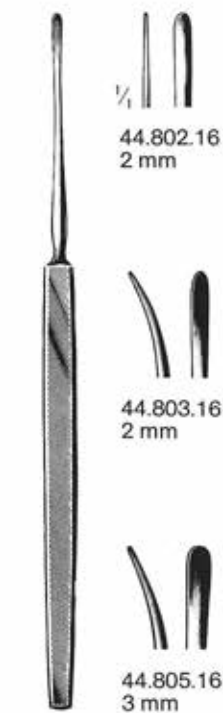

LEMPERT  
44.802.16-44.805.16

1/4  
44.802.16  
2 mm

44.803.16  
2 mm

44.805.16  
3 mm



mm		
1,0/1,2	44.760.01	
1,5/1,8	44.760.02	

mm		
1,0/1,2	44.762.01	
1,5/1,8	44.762.02	

HOUSE  
44.760.01-44.762.02

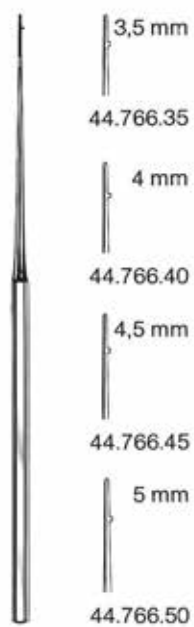

HOUSE  
44.766.35-44.766.50

3,5 mm  
44.766.35

4 mm  
44.766.40

4,5 mm  
44.766.45

5 mm  
44.766.50



LEMPERT  
44.807.20  
20,5 cm



mm	PASSOW
2x2	44.810.02
3x3	44.810.03



MUCK  
44.812.13  
13 cm

Otologie / Otology / Otología / Otologia





Rhinologie  
Rhinology  
Rhinologie  
Rinología  
Rinologia

## Nasenspekula

Nasal Specula  
Spéculums nasaux  
Especulos nasales  
Specoli nasali

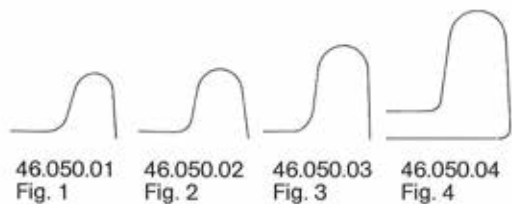

46.050.01  
Fig. 1

46.050.02  
Fig. 2

46.050.03  
Fig. 3

46.050.04  
Fig. 4

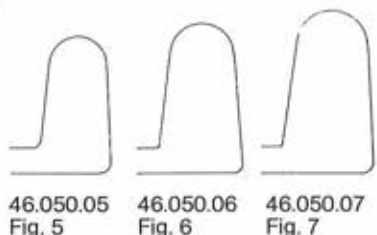

46.050.05  
Fig. 5

46.050.06  
Fig. 6

46.050.07  
Fig. 7

THUDICHUM  
46.050.01-46.050.07



46.060.01  
Fig. 1



46.060.02  
Fig. 2



46.060.03  
Fig. 3



VOLTOLINI  
46.060.01-46.060.03

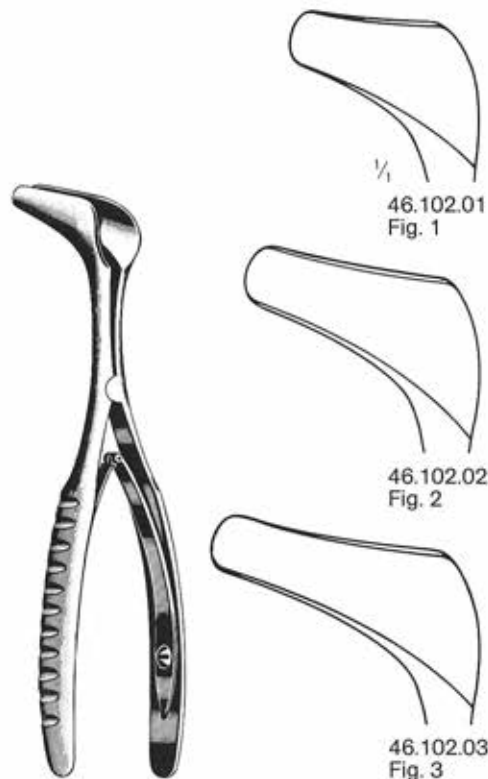

46.102.01  
Fig. 1

46.102.02  
Fig. 2

46.102.03  
Fig. 3

HARTMANN-HALLE  
46.102.01-46.102.03  
15 cm



Mod. Wien · Vienna ·  
Vienne · Viena

Baby · Bébé	46.112.01
Kind · child · enf. · niño · bamb.	46.112.02
Erw. · Adult.	46.112.03



Mod. Wien · Vienna  
Vienne · Viena  
46.113.03  
leichtes Modell  
lightweight  
mod. léger  
mod. ligero  
mod. leggero



## Nasenspekula

Nasal Specula  
Spécum nasaux  
Espéculos nasales  
Specoli nasali



**TIECK-HALLE**  
46.116.13  
13,5 cm



**KILLIAN**  
46.120.35-46.120.90  
13 cm

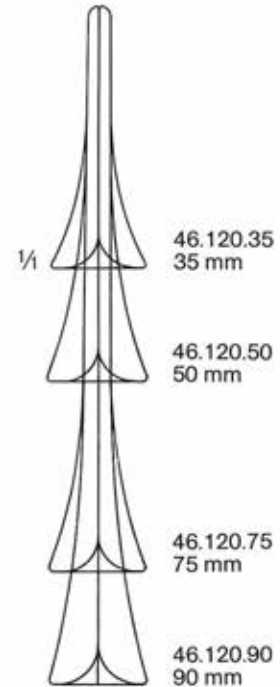

**COTTLE**  
46.124.35-46.124.90  
14 cm



**COTTLE**  
46.126.35-46.126.90  
schwarz · black · noirs  
negros · neri  
14 cm

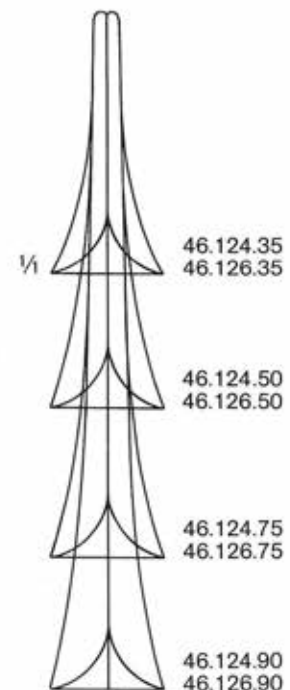

## Rhinologie

Rhinology  
Rhinologie  
Rinología  
Rinologia



YANKAUER  
46.131.19  
19 cm



MICHEL  
46.139.12-46.139.18  
25 cm



46.139.12  
12 mm



46.139.14  
14 mm



46.139.16  
16 mm



46.139.18  
18 mm



TROELTSCH  
46.151.15  
15 cm

TROELTSCH  
46.151.18  
18 cm



JANSEN  
46.154.20  
20 cm

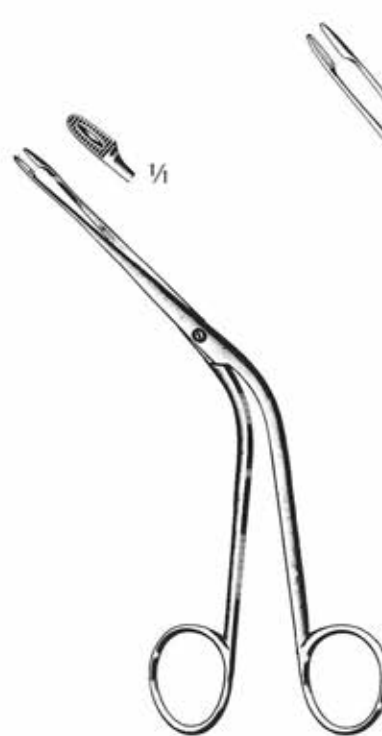

HARTMANN  
46.161.16  
16 cm



HARTMANN  
46.161.20  
20 cm

**Rhinologie**

Rhinology  
Rhinologie  
Rinología  
Rinologia



LUBET-BARBON  
46.165.20  
20 cm



LITTAUER  
46.167.18  
18 cm

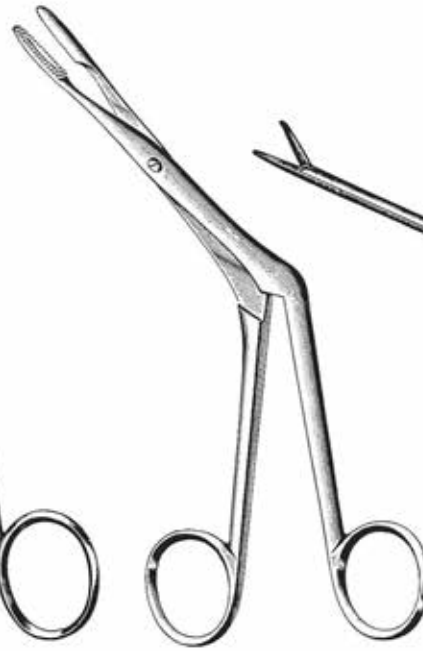

HEYMANN-KNIGHT  
46.169.18  
18 cm

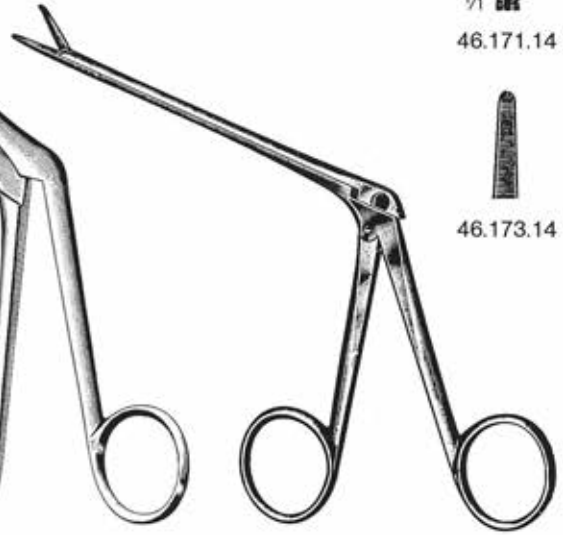

NOYES  
46.171.14-46.173.14  
14,5 cm

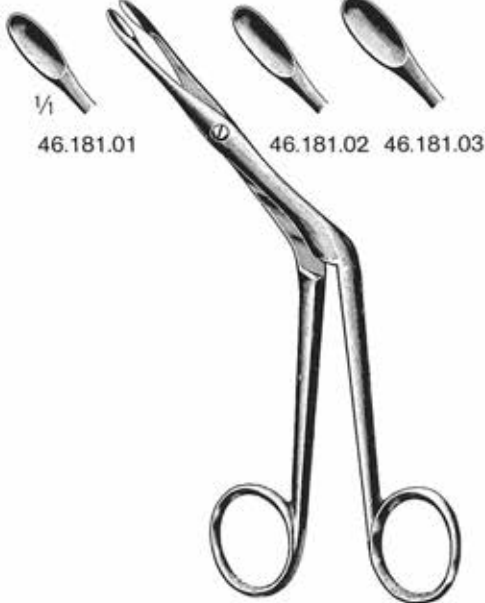

HEYMANN  
46.181.01-46.181.03  
18 cm

1/2  
46.181.01

46.181.02 46.181.03



KNIGHT  
46.185.18  
18 cm

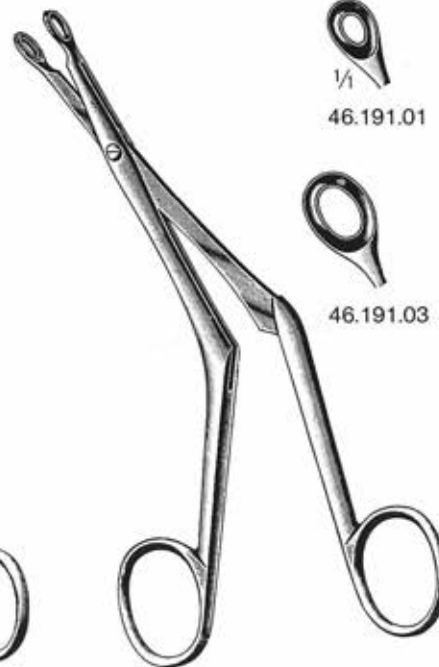

BRUENINGS  
46.191.01-46.191.04  
19 cm



**Scharfe Nasenzangen**

Nasal Cutting Forceps  
 Pincès coupantes nasales  
 Pinzas cortantes nasales  
 Pinze taglianti nasali



LUC  
 46.195.01-46.195.02  
 19 cm

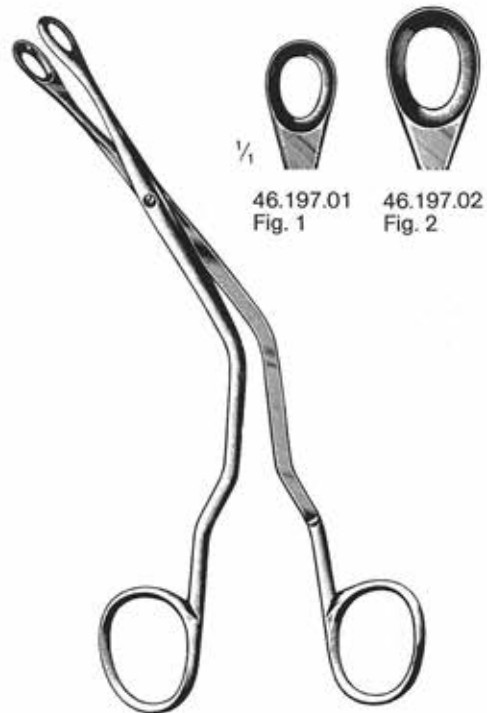

LUC  
 46.197.01-46.197.02  
 19 cm

ohne Hals  
 without neck  
 sans cou  
 sin cuello  
 senza collo



mit Hals  
 with neck  
 avec cou  
 con cuello  
 con collo

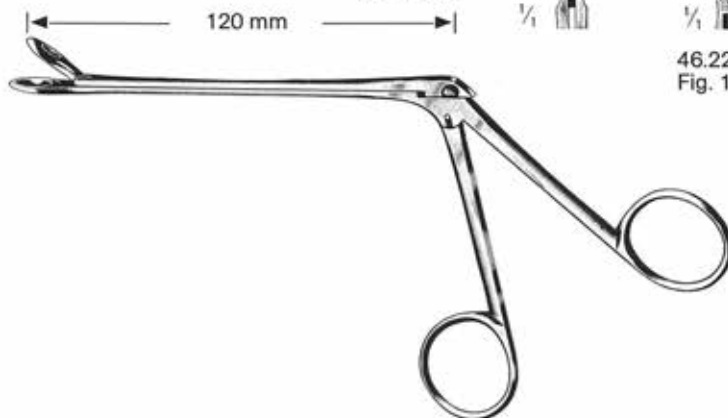

WEIL-BLAKESLEY  
 46.221.01-46.223.05

**Rhinologie**

Rhinology  
Rhinologie  
Rinología  
Rinologia

Scharfe Nasenzangen  
Nasal Cutting Forceps  
Pincès coupantes nasales  
Pinzas cortantes nasales  
Pinze taglienti nasali



46.231.01-46.237.03  
19 cm



STRUYCKEN  
46.231.01  
Fig. 1



STRUYCKEN  
46.231.02  
Fig. 2

- 46.237.01  
5 mm
- 46.237.02  
7 mm
- 46.237.03  
9 mm



MYLES



46.235.05



46.235.07

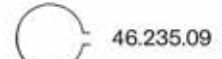

46.235.09



46.235.11



HARTMANN



Septum-Quetschzange  
Septum Crushing Forceps  
Pince à écraser la cloison  
Pinza para magullar tabique  
Pinza per ammaccare il setto

RUBIN  
46.251.21  
21 cm



## Rhinologie

Rhinology  
Rhinologie  
Rinología  
Rinologia



mm x mm	KERRISON
3x3	46.303.03
4x4	46.303.04
5x5	46.303.05
6x6	46.303.06
	17 cm

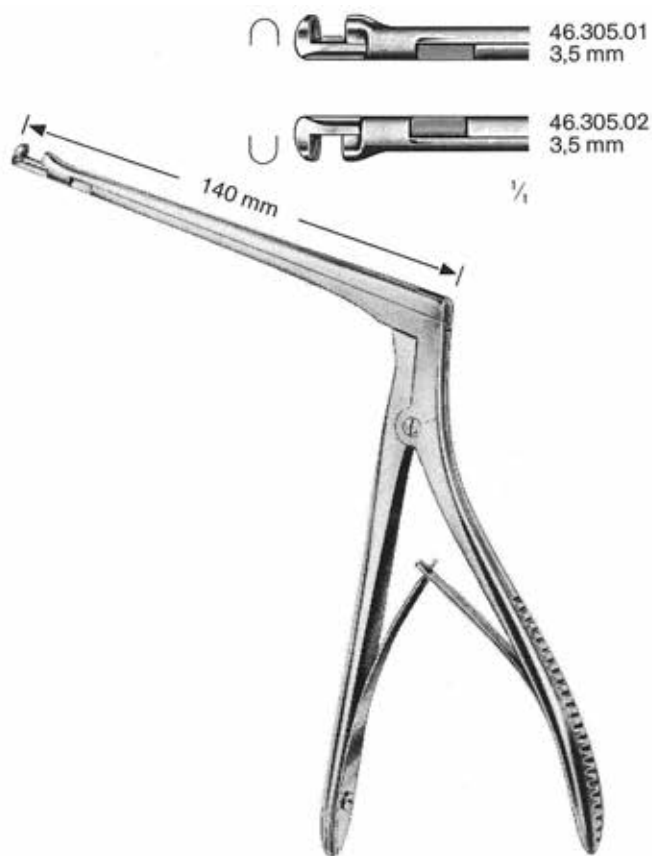

HAJEK-KOFLER  
46.305.01-46.305.02



mm	CITELLI
1,0	46.311.10
2,5	46.311.25
4,0	46.311.40



BEYER  
46.315.20  
2,0 mm



HAJEK-CLAUS  
46.320.20  
20 cm

**Rhinologie**

Rhinology  
Rhinologie  
Rinología  
Rinologia



MIDDLETON-JANSEN  
46.323.19  
19 cm



MIDDLETON-JANSEN  
46.325.19  
19 cm



Ø mm	LICHTWITZ
1,5	46.340.15
1,8	46.340.18
2,0	46.340.20

Luer-Lock  
10 cm



KILLIAN  
46.341.03  
14 cm/3 mm Ø



KRAUSE  
46.351.26  
26 cm



WILDE  
46.352.24  
24 cm



46.355.03  
0,3 mm

Rhinologie / Rhinology / Rhinologie / Rinología / Rinologia



## Nasenmesser

Nasal Knives  
Bistouris nasaux  
Bisturías nasales  
Coltelli nasali



JOSEPH  
46.370.16-46.373.16



46.370.16  
stumpf · blunt · mousses  
romos · smussi



46.371.16



46.372.16  
spitz · pointed · pointus  
puntiagudos · acuti



46.373.16



FREER  
46.374.15  
15 cm



FREER  
46.375.19  
19 cm



JOSEPH  
46.376.16  
16 cm



1/4

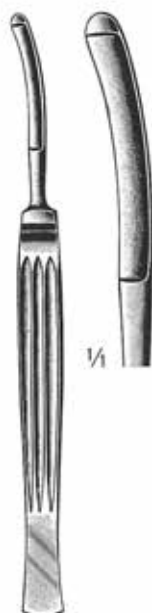

CONVERSE  
46.379.16  
16 cm



1/4



COTTLE  
46.380.15  
15 cm



46.382.15



COTTLE  
46.384.15



46.385.15

**Septum-Messer**  
 Septum Knives  
 Couteaux pour la cloison  
 Cuchillos para tabique  
 Coltelli per setto

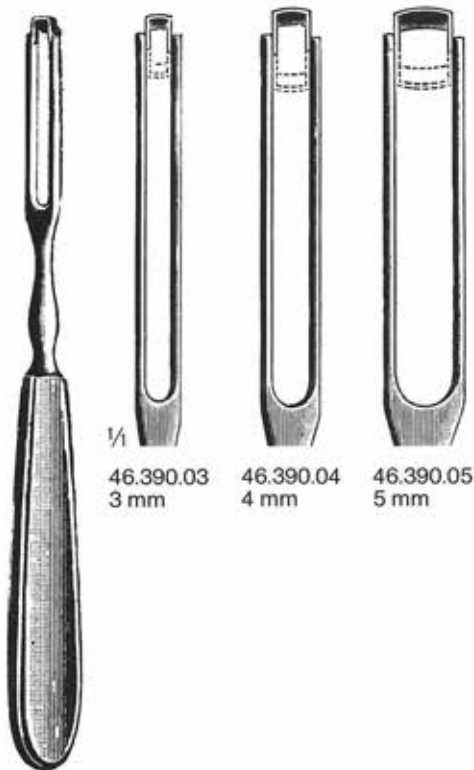

1/1  
 46.390.03 3 mm  
 46.390.04 4 mm  
 46.390.05 5 mm

**BALLENGER**  
 46.390.03-46.392.05  
 20 cm

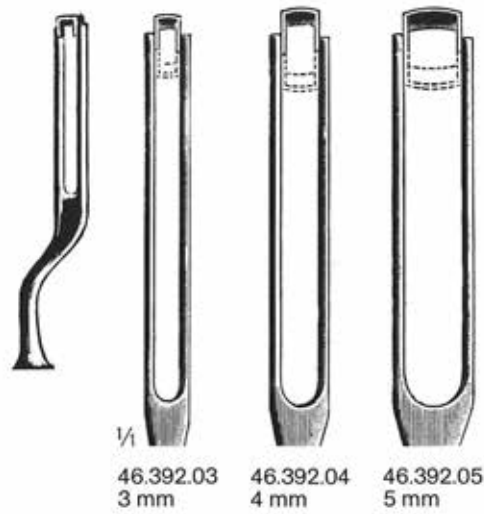

1/1  
 46.392.03 3 mm  
 46.392.04 4 mm  
 46.392.05 5 mm



**BRUENINGS**  
 46.398.16  
 16,5 cm

**Septum-Elevatorien**  
 Septum Elevators  
 Élévateurs pour la cloison nasale  
 Elevadores para tabique  
 Elevatori per setto

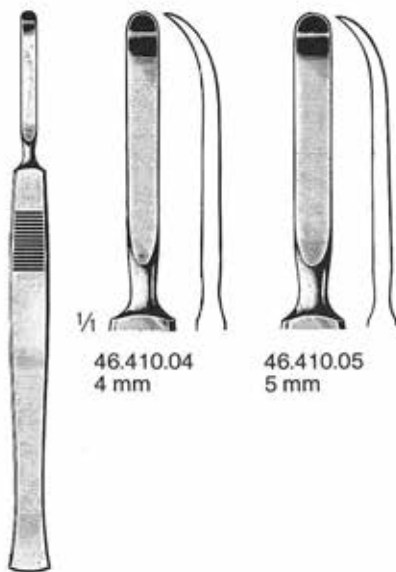

1/1  
 46.410.04 4 mm  
 46.410.05 5 mm

**McKENY**  
 46.410.04-46.410.05  
 15 cm



**ROGER**  
 46.413.19  
 19 cm



**FREER**  
 46.415.18  
 18 cm



**FREER**  
 46.417.19  
 19 cm



**FREER**  
 46.419.19  
 19 cm

# Rhinologie

Rhinology  
Rhinologie  
Rinologia  
Rinologia

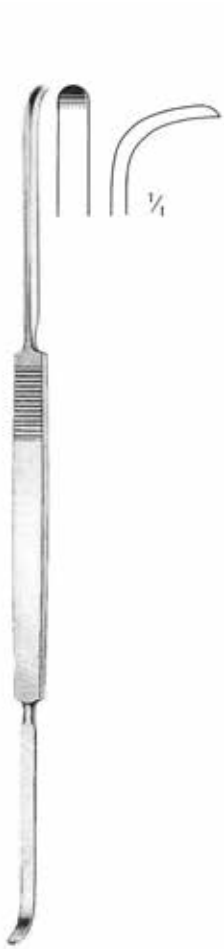

COTTLE  
46.421.23  
23 cm



COTTLE  
46.423.22  
22 cm



JOSEPH  
46.425.16  
16 cm



COTTLE  
46.425.19  
19 cm



KILLIAN  
46.426.22  
22 cm



HAJEK-BALLENGER  
46.428.21  
22 cm



BALLENGER  
46.430.22  
22 cm



FREER  
46.450.04  
4 mm



FREER  
46.451.04  
4 mm

**Nasenplastik-Meißel**

Rhinoplastic Chisels

Ciseaux-burins pour la plastique nasale

Cinceles para la plástica nasal

Scalpelli per plastica nasale

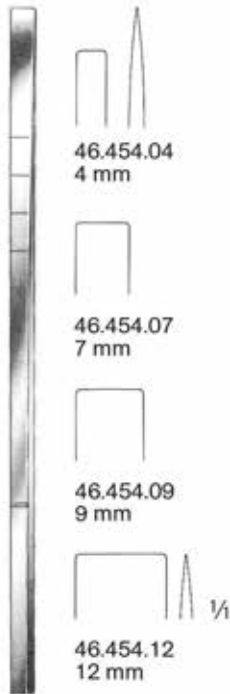

**COTTLE**  
46.454.04-46.454.12  
18 cm



**COTTLE**  
46.455.06  
18 cm/6 mm

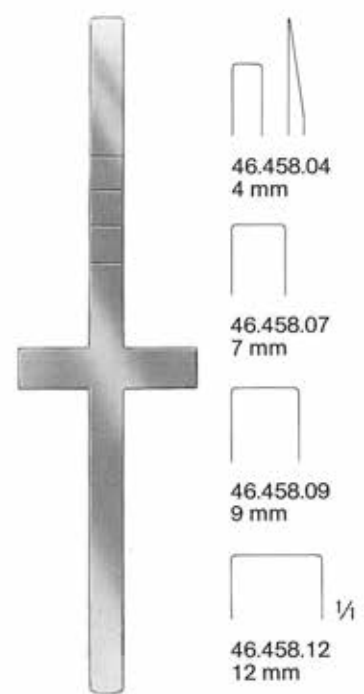

**COTTLE**  
46.458.04-46.458.12

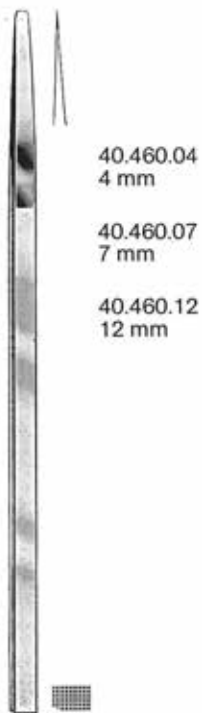

**COTTLE**  
40.460.04-40.460.12  
18 cm

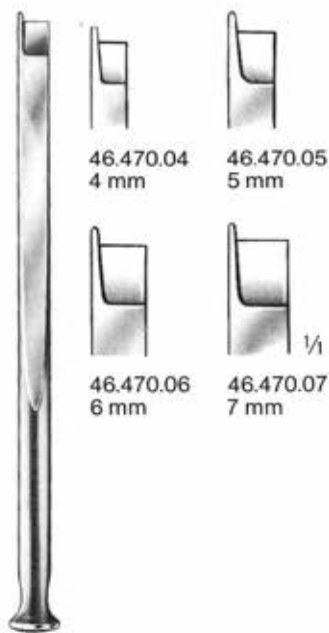

**FOMON**  
46.470.04-46.470.07  
17 cm

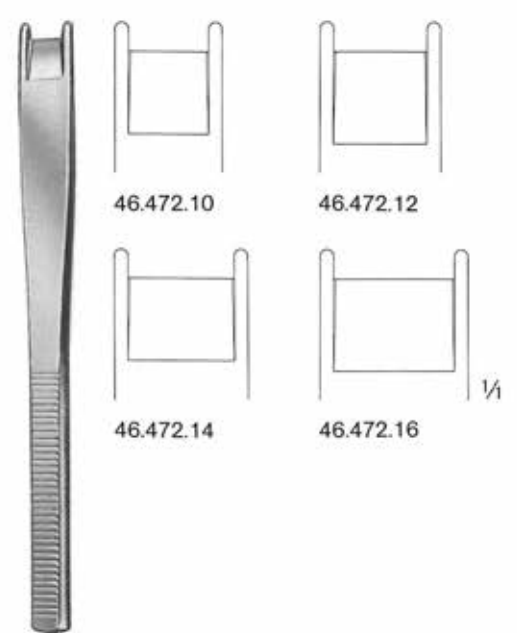

**CINELLI**  
46.472.10-46.472.16

# Rhinologie

Rhinology  
Rhinologie  
Rinología  
Rinologia

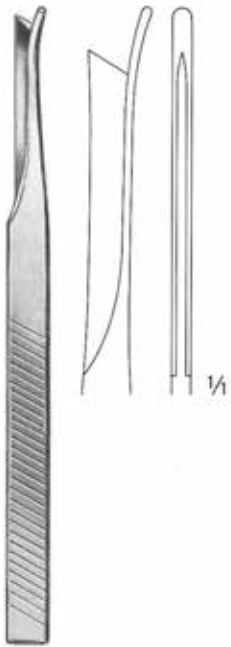

SILVER  
46.473.01  
18 cm

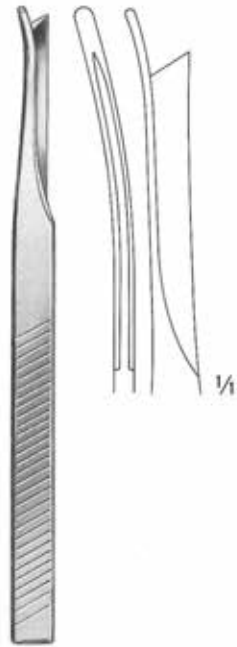

SILVER  
46.473.02  
18 cm

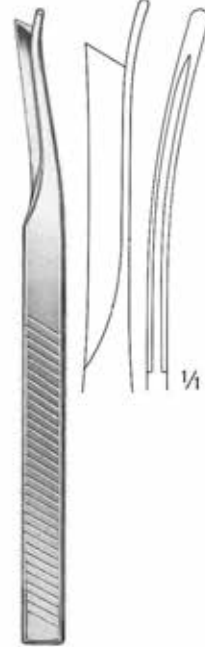

SILVER  
46.473.03  
18 cm



KILLIAN-CLAUS  
46.482.05  
17 cm/5 mm



mm	HAJEK
4	46.484.04
6	46.484.06
8	46.484.08



WEST  
46.486.16  
16 cm



WEST  
46.487.16  
16 cm



FREER  
46.489.16  
6 mm



JOSEPH  
46.502.16  
16 cm

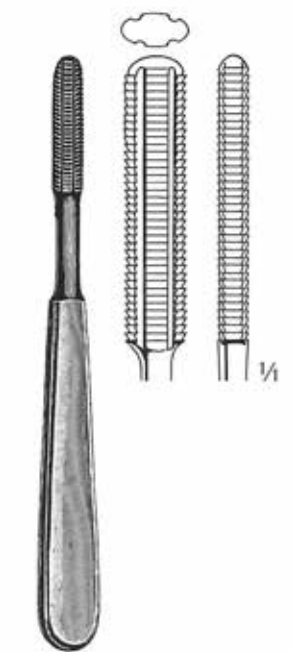
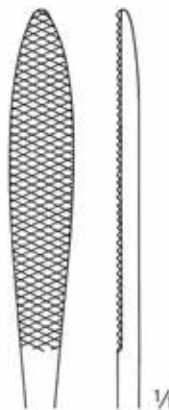

AUFRICHT  
46.504.18  
18 cm



**Rhinologie**

Rhinology  
Rhinologie  
Rinología  
Rinologia



WIENER  
46.507.18-46.507.19  
18 cm



46.507.18



46.507.19



WIENER (AUFRICHT)  
46.511.21-46.513.21  
21 cm



46.511.21



46.513.21



JOSEPH (LEWIS)  
46.514.16-46.516.16  
18 cm



46.514.16  
fein · fine  
fina



46.516.16  
grob · coarse · gruesa  
dentellure grosse  
dentellatura grossa



MALTZ (COTTLE)  
46.518.21  
21 cm

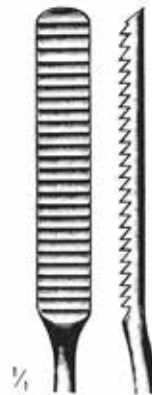

1/4

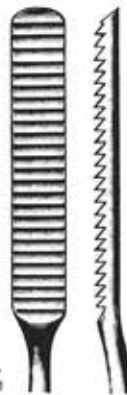

FOMON  
46.520.21  
21 cm

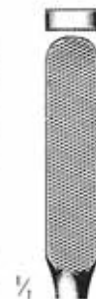

1/4

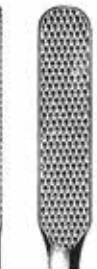

**Rhinologie**

Rhinology  
Rhinologie  
Rinologia  
Rinologia

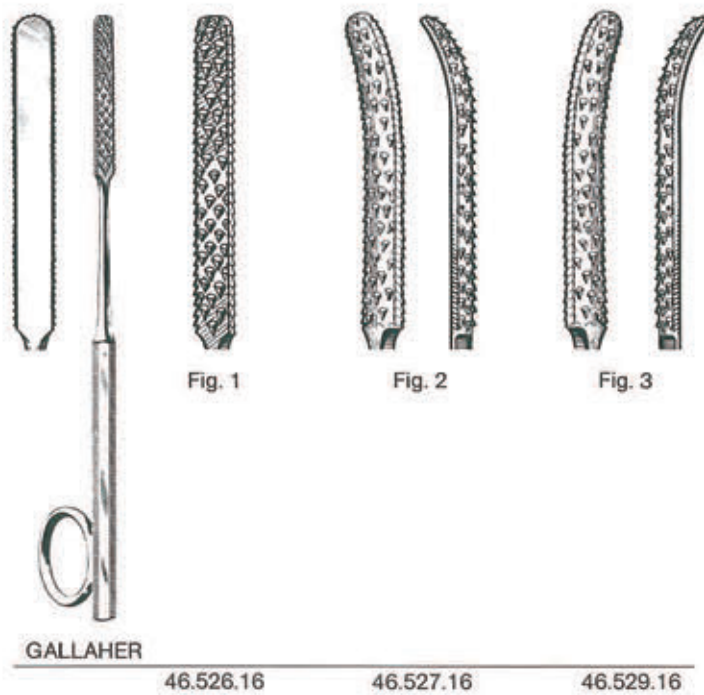
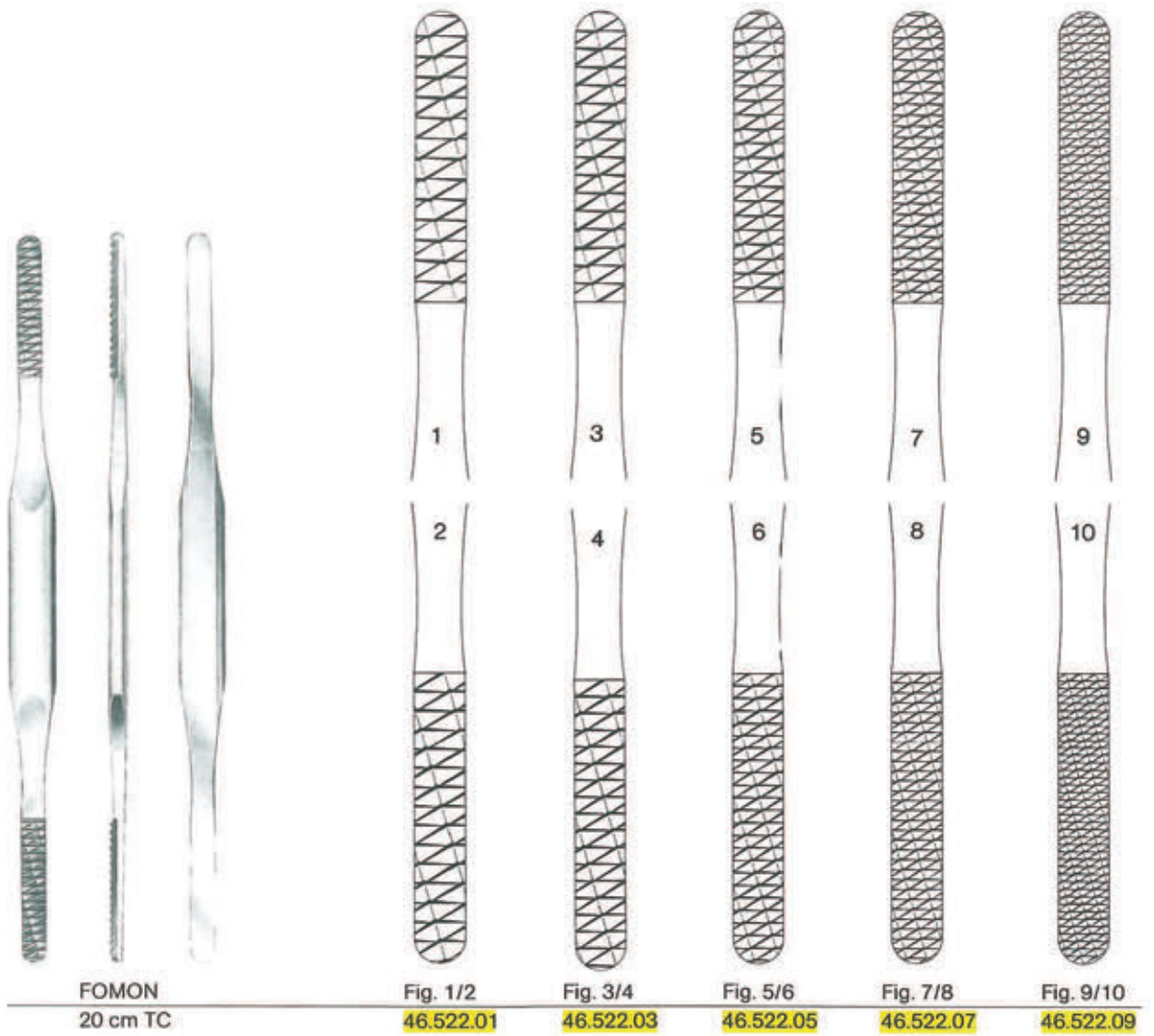



**Rhinologie**

Rhinology  
Rhinologie  
Rinología  
Rinologia

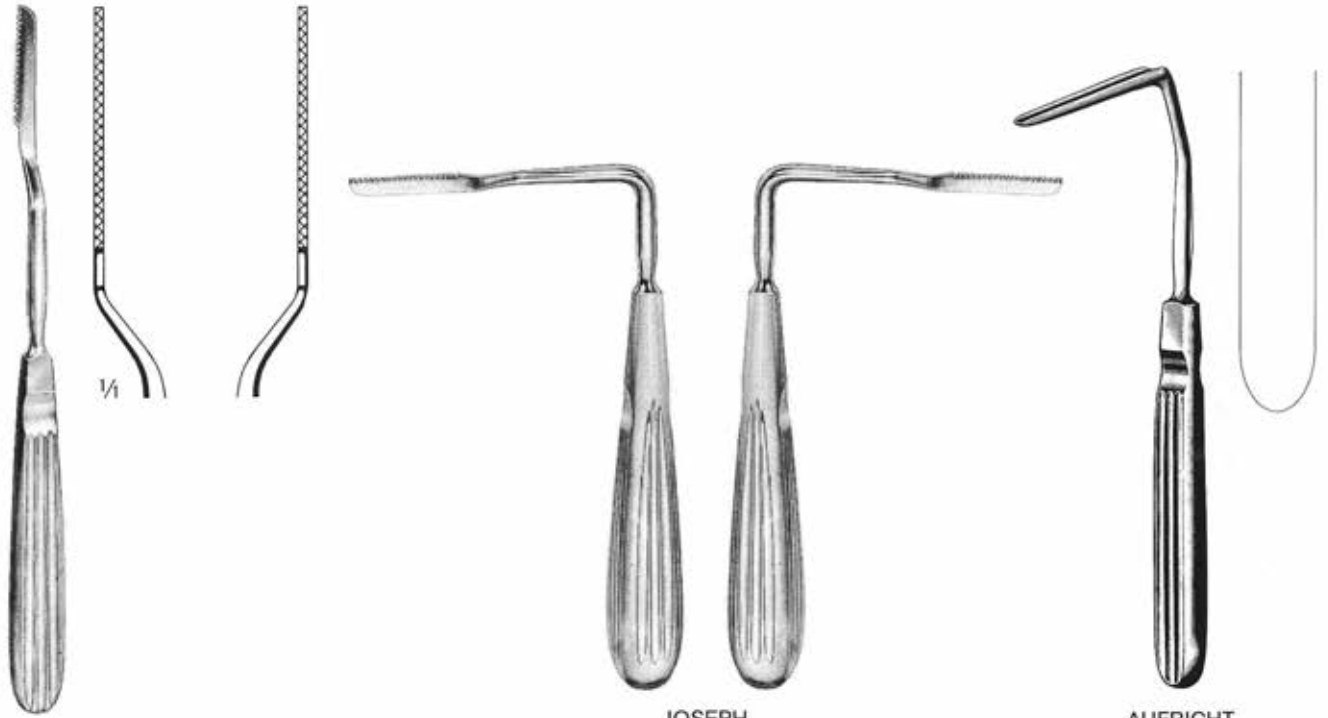

JOSEPH  
46.535.01 17 cm 46.535.02

AUFRICHT  
46.551.16  
19 cm

**JOSEPH**

19 cm	46.532.19	46.534.19
	links · left ·	rechts · right ·
	à gauche	à droite
	izquierda	derecha
	a sinistra	a destra

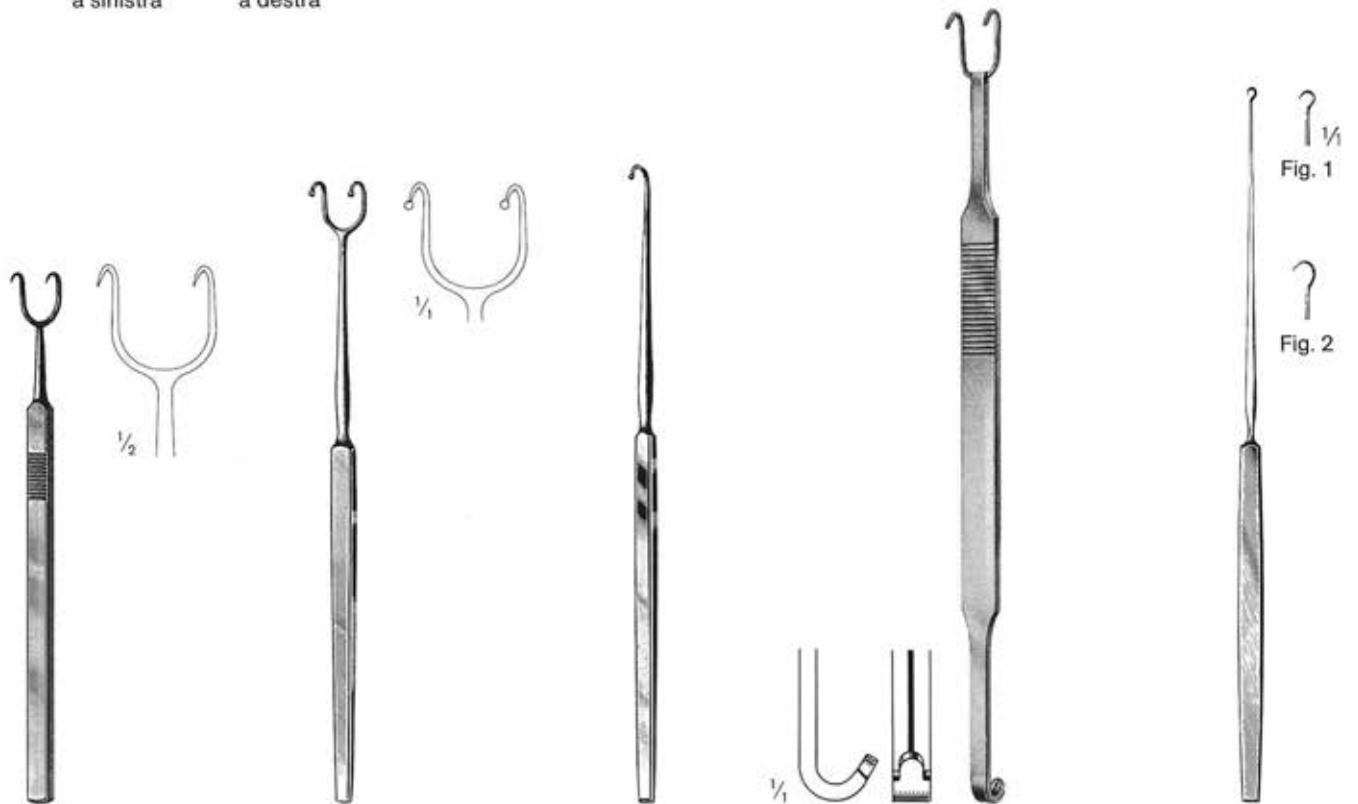

COTTLE  
46.556.14

FOMON  
46.556.16

FOMON  
46.557.17

COTTLE-NEIVERT  
46.559.20

Fig.	GILLIES
1	46.560.18
2	46.562.18
	18 cm

**Rhinologie**

Rhinology  
Rhinologie  
Rinología  
Rinologia



ASCH  
46.571.23  
23 cm



WALSHAM  
46.572.23-46.575.23  
23 cm



46.572.23  
gerade  
straight  
droite  
recta  
retta

46.573.23  
links  
left  
à gauche  
izquierda  
a sinistra

46.575.23  
rechts  
right  
à droite  
derecha  
a destra



JATHO  
46.595.15



FAULKNER  
46.601.21  
21 cm

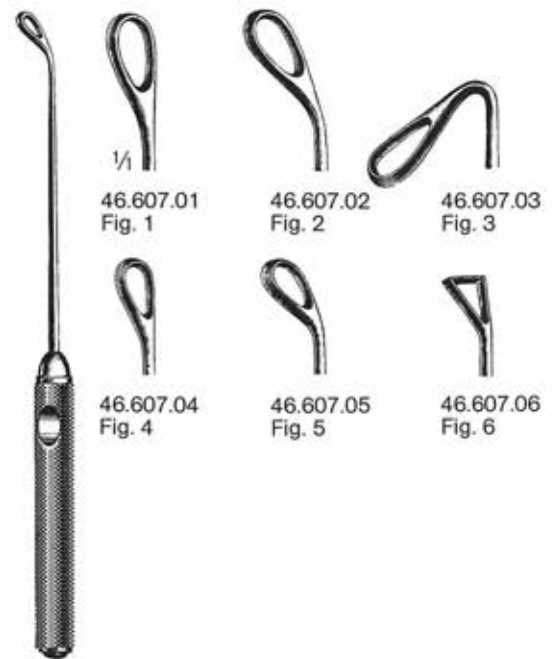

COAKLEY  
46.607.01-46.607.06  
17 cm

**Rhinologie**

Rhinology  
Rhinologie  
Rinología  
Rinologia

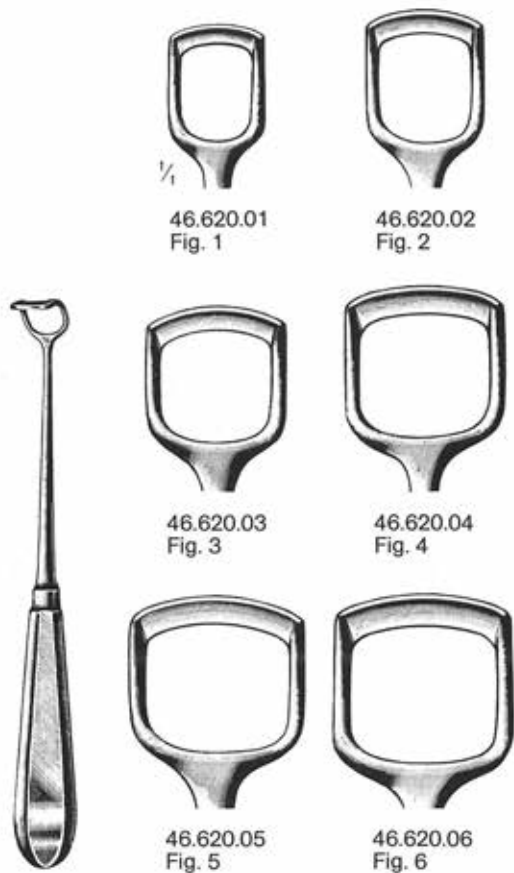

1/4

46.620.01  
Fig. 1



46.620.02  
Fig. 2



46.620.03  
Fig. 3



46.620.04  
Fig. 4



46.620.05  
Fig. 5



46.620.06  
Fig. 6

BECKMANN  
46.620.01-46.620.06  
22 cm



1/4



46.636.01  
Fig. 1



46.636.03  
Fig. 3



46.636.02  
Fig. 2



46.636.04  
Fig. 4

St. CLAIR-THOMSON  
46.636.01-46.636.04  
21 cm



1/4



46.630.01  
Fig. 1



46.630.02  
Fig. 2



46.630.03  
Fig. 3



46.630.04  
Fig. 4

BARNHILL  
46.630.01-46.630.04  
21 cm



1/4



46.641.01  
Fig. 1

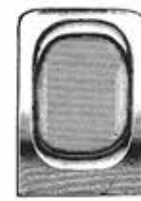

46.641.02  
Fig. 2

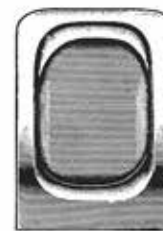

46.641.03  
Fig. 3

Ersatzklingen, gelocht  
Spare blades, perforated  
Lames de rechange, perforées  
Hojas de repuesto, perforadas  
Lame di ricambio, forate

Fig.	
1	46.642.01
2	46.642.02
3	46.642.03

LAFORCE  
46.641.01-46.641.03  
25 cm

**Rhinologie**

Rhinology  
Rhinologie  
Rinología  
Rinologia

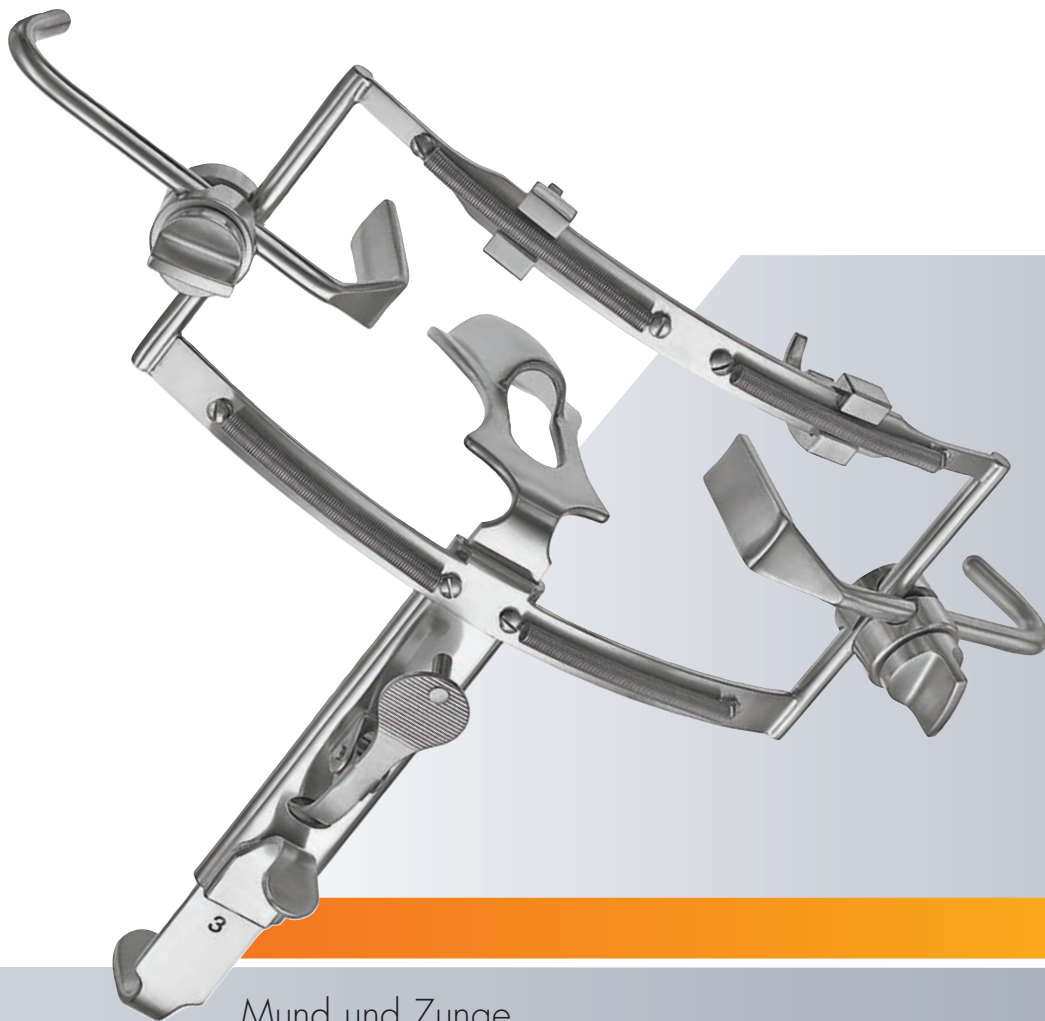

Mund und Zunge  
Mouth and Tongue  
Bouche et langue  
Boca y lengua  
Bocca e lingua

## Zungenspatel, Lippenhalter

Tongue Depressors, Lip Retractors  
 Abaisse-langue, écarteurs des lèvres  
 Abajalengua, Separadores de labios  
 Abbassalingua, Divaricatori di labbra



48.102.16  
 16 cm  
 Holz · wood ·  
 bois · madera · legno



FRENZEL  
 48.105.16  
 16,5 cm



BRUENINGS  
 48.107.19  
 19 cm



BUCHWALD  
 48.109.19  
 19 cm



HARTMANN  
 48.111.15  
 15 cm



48.115.01  
 Fig.1, 14 cm

48.115.02  
 Fig. 2, 15 cm

WIEDER  
 48.115.01-48.115.02



ANDREW  
 48.117.11  
 11 cm



TOBOLD  
 48.119.14  
 14,5 cm



cm	STERNBERG
14	48.227.14
16	48.227.16
18	48.227.18



cm	STERNBERG
12	48.229.12
14	48.229.14
16	48.229.16



**Mund und Zunge**

Mouth and Tongue  
Bouche et langue  
Boca y lengua  
Bocca e lingua

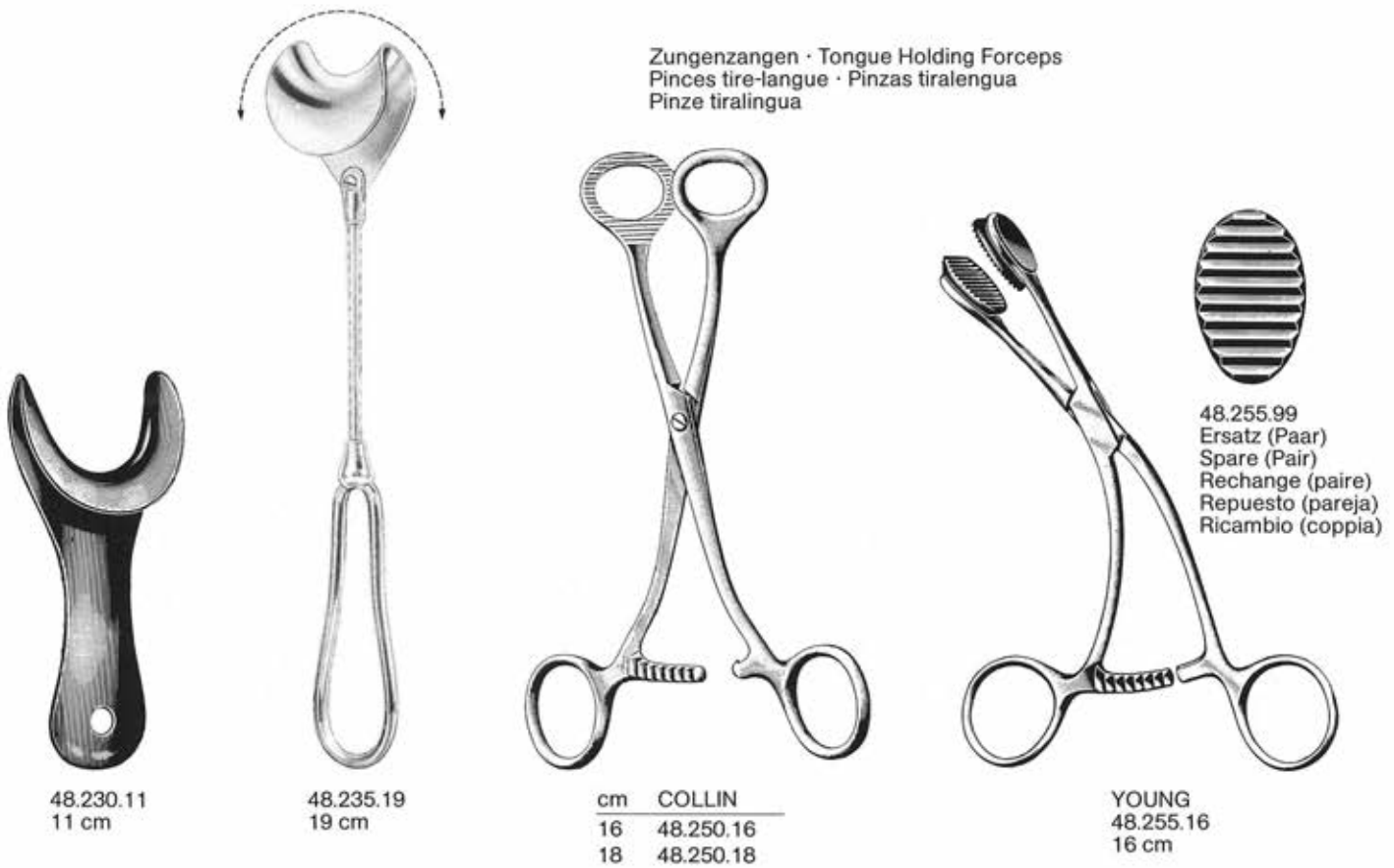

Mundsperrer · Mouth Gags  
Ouvre-bouche · Abre bocas  
Apribocca

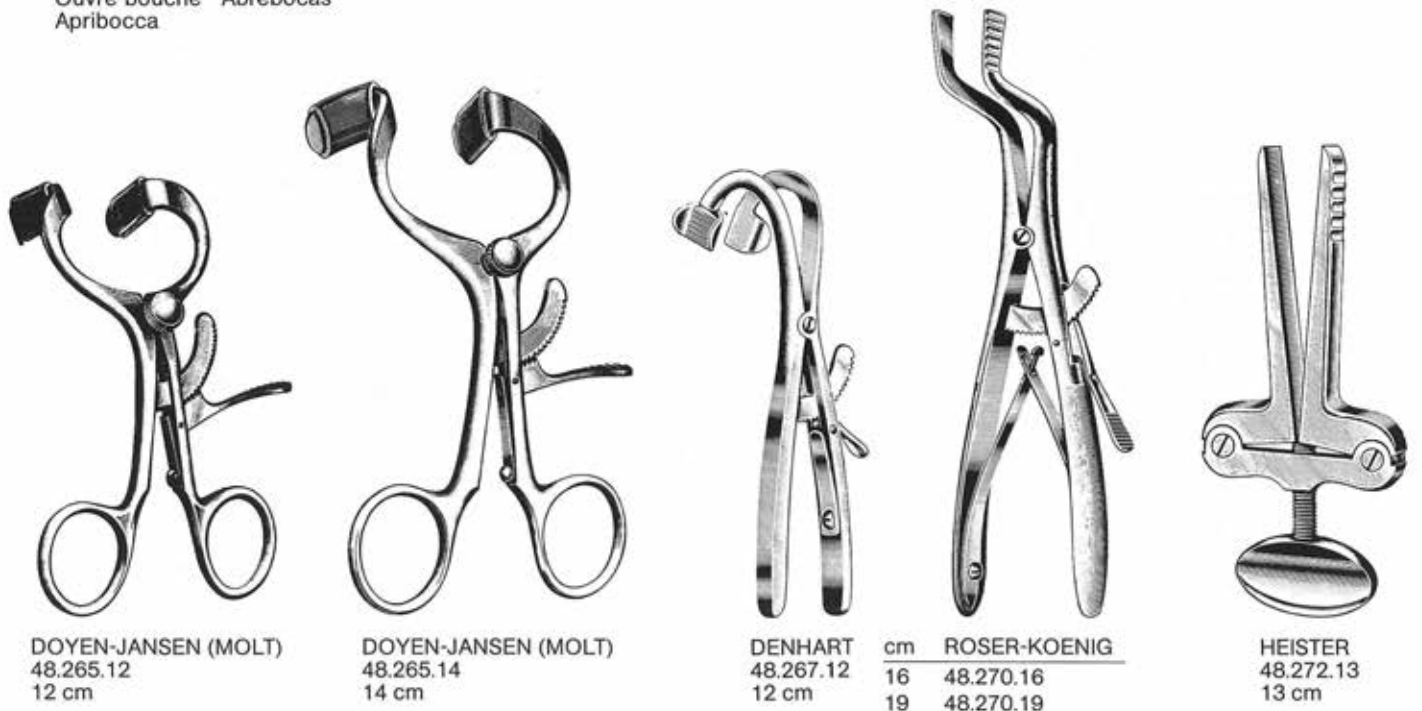



## Mundsperrer

Mouth Gags  
Ouvre-bouche  
Abrebocas  
Apribocca



cm	JENNINGS
9	48.274.09
11	48.274.11
13	48.274.13
15	48.274.15



cm	WHITEHEAD
11	48.280.11
13	48.280.13
15	48.280.15



cm	WHITEHEAD
11	48.281.11
13	48.281.13
15	48.281.15



cm	SEEMANN-SEIFFERT
9	48.285.09
11	48.285.11
13	48.285.13
15	48.285.15

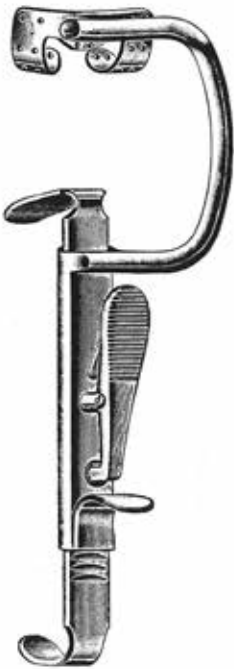

48.310.10



48.310.01  
27 x 105 mm Fig. 1

DAVIS-BOYLE  
48.310.00  
compl.



48.310.02  
25 x 90 mm Fig. 2



48.310.03  
25 x 75 mm Fig. 3



48.310.04  
22 x 60 mm Fig. 4



48.310.05  
20 x 25 mm Fig. 5

**Mundsperrer**

Mouth Gags  
Ouvre-bouche  
Abrebocas  
Apribocca



48.315.10



1/2  
48.315.01  
28 x 65 mm  
Fig. 1



48.315.02  
32 x 75 mm  
Fig. 2



48.315.03  
37 x 80 mm  
Fig. 3



48.315.99

KILNER-DOUGHTY  
48.315.00  
compl.



48.320.10

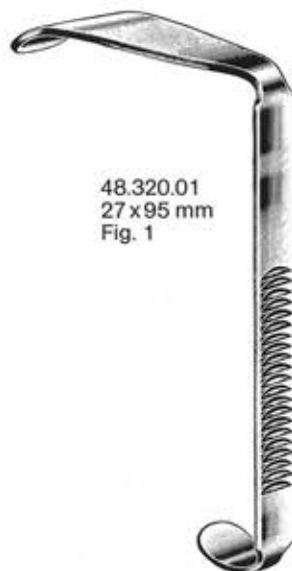

48.320.01  
27 x 95 mm  
Fig. 1



1/2  
48.320.02  
22 x 85 mm  
Fig. 2



48.320.03  
22 x 70 mm  
Fig. 3

McIVOR  
48.320.00  
compl.

**Mund**

Mouth  
Bouche  
Boca  
Bocca



MAUNDER  
48.360.10



PITHA  
48.365.10

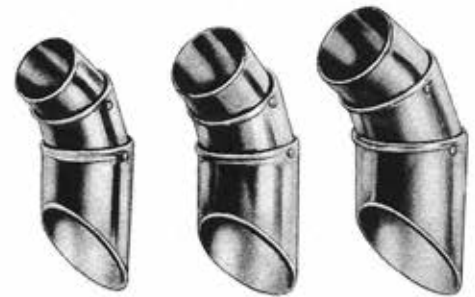

LANGENBECK  
48.371.01 Fig. 1      48.371.02 Fig. 2      48.371.03 Fig. 3



links  
left side  
côté gauche  
izquierda  
lato sinistro

rechts  
right side  
côté droit  
derecha  
lato destro

cm	ROWE	ROWE	
22,5	48.501.22	48.503.22	Säugling · baby · bébé · bebé · lattante
23,5	48.501.23	48.503.23	Kinder · child · enfant · niño · bambino
24,0	48.501.24	48.503.24	Erwachsene · adult



Tonsillen  
Tonsils  
Amygdales  
Amígdalas  
Tonsille

## Tonsillen

Tonsils  
Amygdales  
Amígdalas  
Tonsille



mm	LOVE
18	50.103.18
20	50.103.20
22	50.103.22



HOFER  
50.109.24  
24 cm



NAGER  
50.111.23  
23 cm



HURD  
50.131.22  
glatt · smooth · lisse  
liso · liscio  
22 cm  
50.133.22  
gezahnt · serrated  
dentelé · dentado  
dentellato  
22 cm

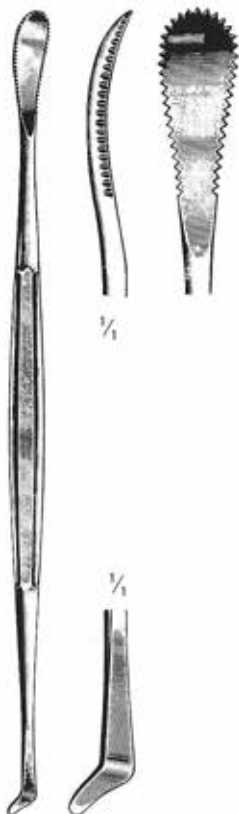

HENKE  
50.135.23  
23 cm



CARPENTER  
50.139.25  
25 cm



CARPENTER  
50.143.24  
24 cm



LUNIATSCHEK  
50.151.19  
19 cm



**Tonsillen**  
Tonsils  
Amygdales  
Amígdalas  
Tonsille

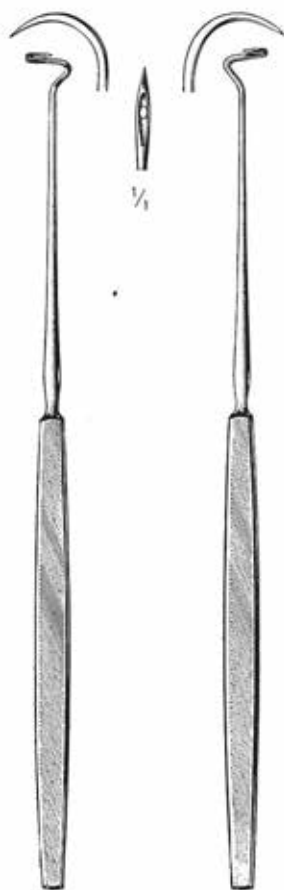

**DUPUY-WEISS**  
50.165.22    50.167.22  
22 cm

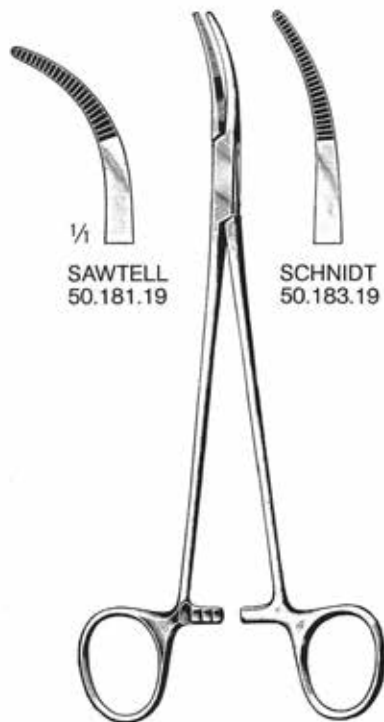

SAWTELL 50.181.19    SCHNIDT 50.183.19

50.181.19-50.183.19  
19 cm

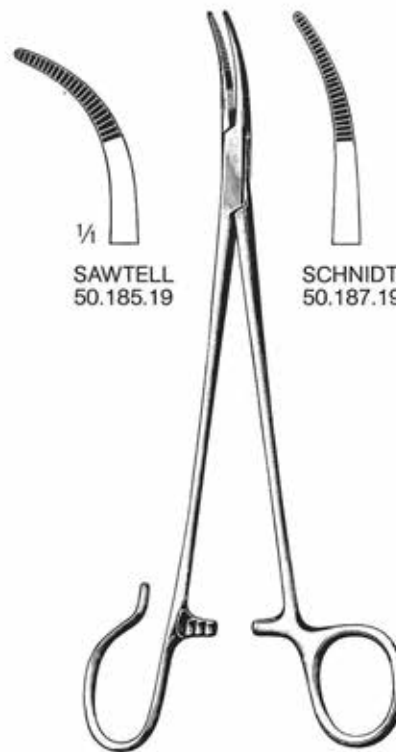

SAWTELL 50.185.19    SCHNIDT 50.187.19

50.185.19-50.187.19  
19 cm

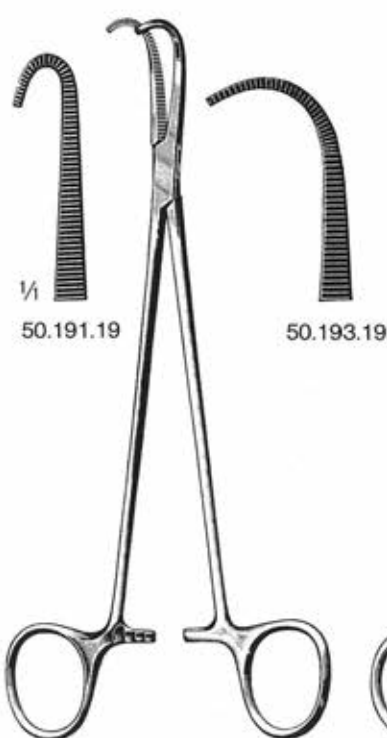

50.191.19    50.193.19

**NEGUS**  
50.191.19-50.193.19  
19 cm

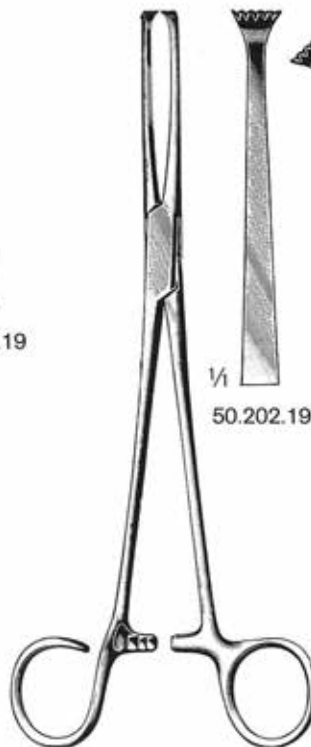

50.202.19    50.203.19

**COLVER**  
50.202.19-50.203.19  
19 cm

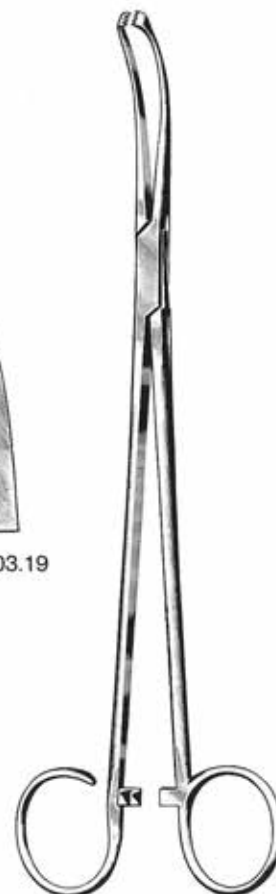

cm	WHITE
18	50.205.18
23	50.205.23

## Tonsillen

Tonsils  
Amygdales  
Amígdalas  
Tonsille



BALLENGER  
50.207.21  
21,5 cm



BLOHMKE  
50.209.20  
20 cm

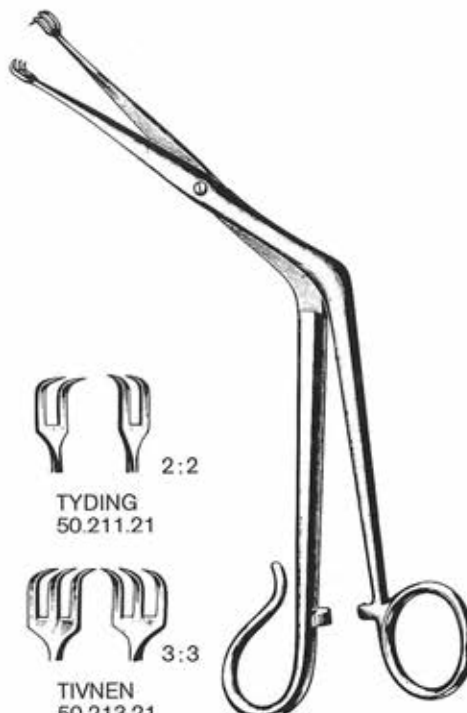

TYDING  
50.211.21



TIVNEN  
50.213.21

50.211.21-50.213.21  
21 cm



MARSCHIK  
50.219.22  
22 cm



EVES  
50.250.28  
28 cm



EVES  
50.252.28  
28 cm

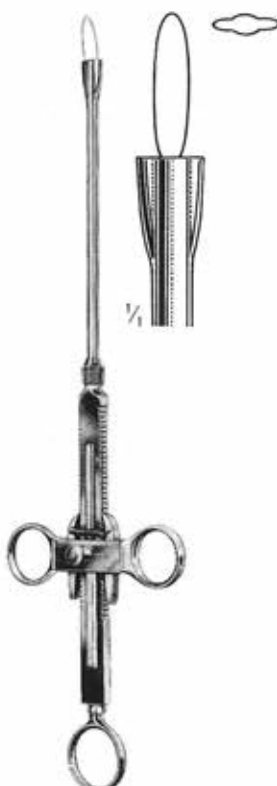

BRUENINGS  
50.256.28  
28 cm



mm	
40	50.257.40
50	50.257.50
	100 x



50.259.03  
0,3 mm  
12 x



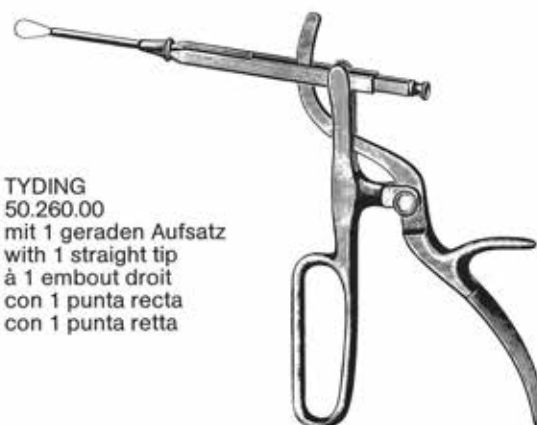

**TYDING**  
50.260.00  
mit 1 geraden Aufsatz  
with 1 straight tip  
à 1 embout droit  
con 1 punta recta  
con 1 punta retta

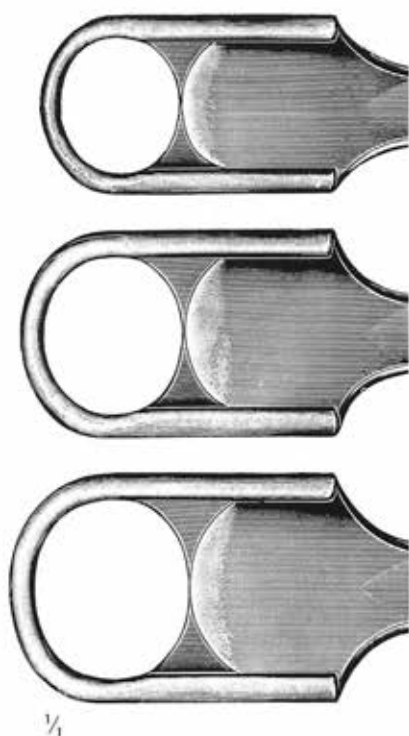

1/4

**SLUDER-BALLENGER**  
50.270.00  
mit 3 Aufsätzen  
with 3 blades  
avec 3 lames  
con 3 hojas  
con 3 lame



50.292.00



50.293.45  
45°

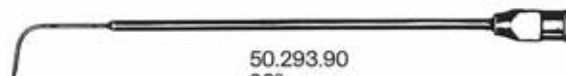

50.293.90  
90°

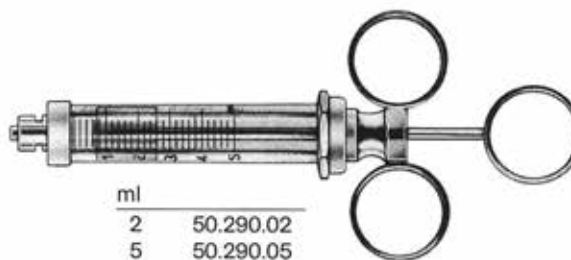

ml	
2	50.290.02
5	50.290.05
10	50.290.10

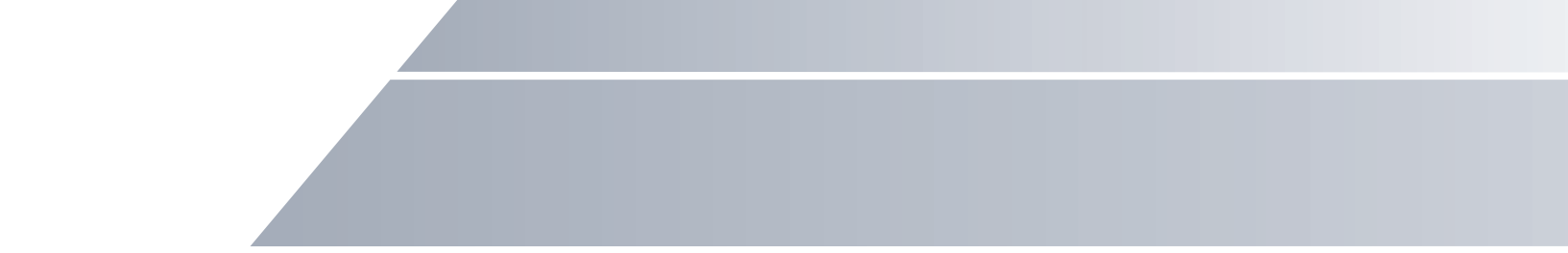

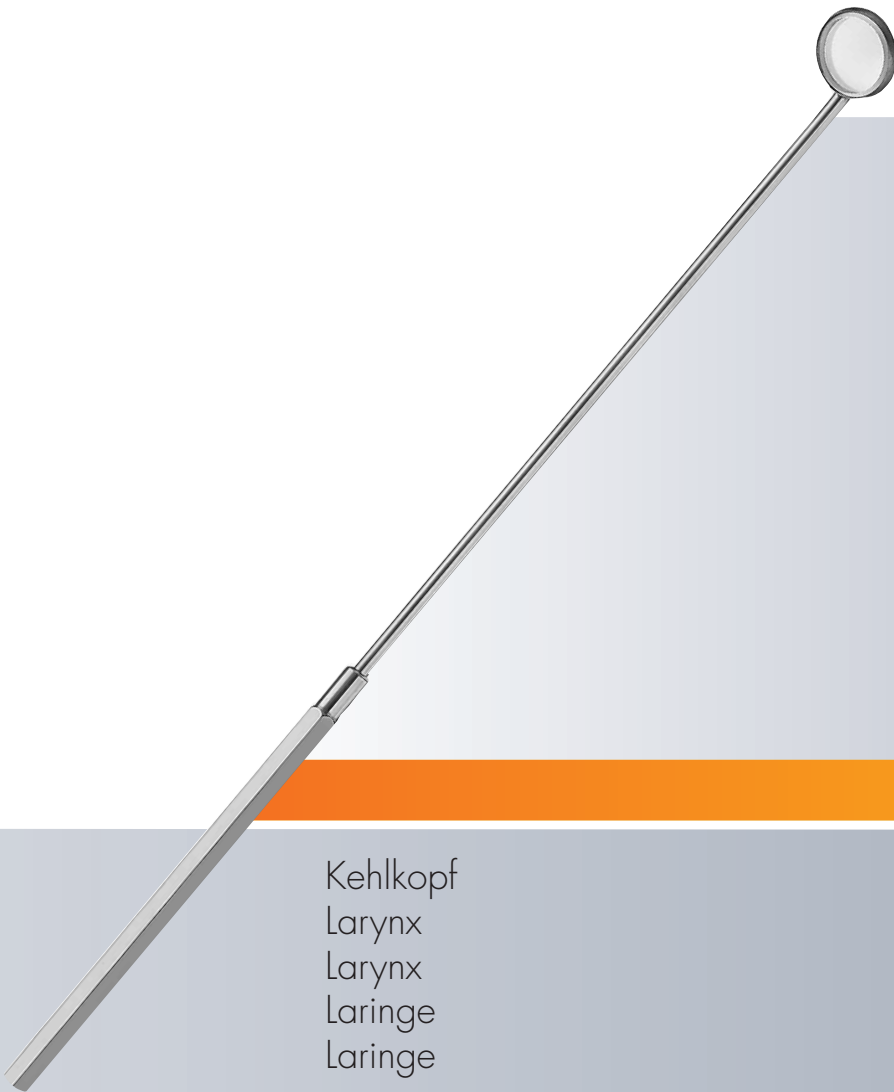

Kehlkopf  
Larynx  
Larynx  
Laringe  
Laringe

## Kehlkopf

Larynx  
Larynx  
Laringe  
Laringe



JACKSON  
52.101.22-52.103.22  
22 cm



52.101.22



52.103.22



FRAENKEL  
52.111.18  
18 cm

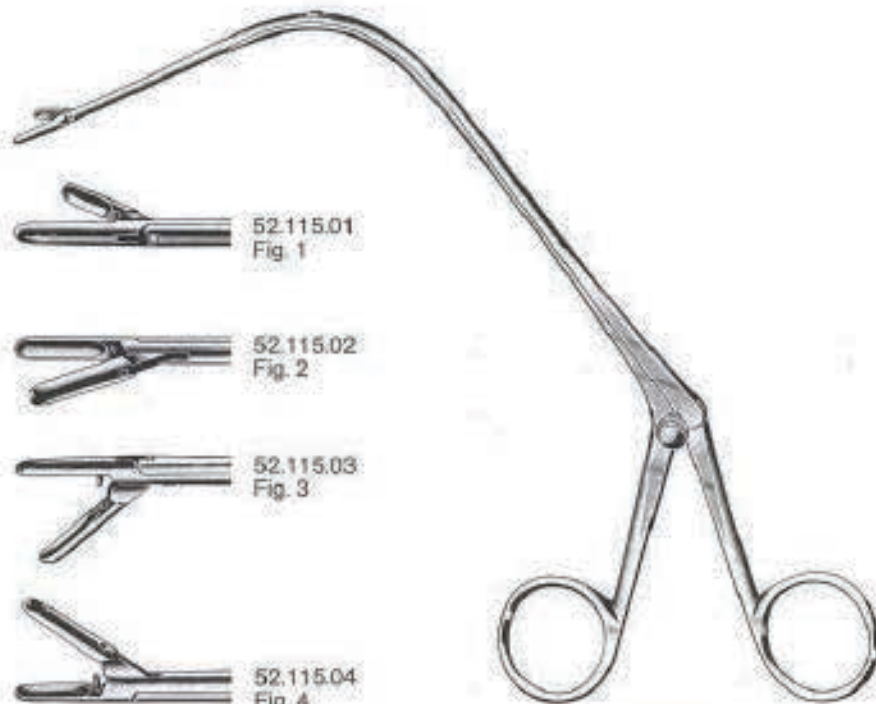

JURASZ  
52.115.01-52.115.04  
23 cm



52.115.01  
Fig. 1



52.115.02  
Fig. 2



52.115.03  
Fig. 3



52.115.04  
Fig. 4



REICHERT  
52.121.24  
24 cm

**Kehlkopf**

Larynx  
Larynx  
Laringe  
Laringe



HUBER  
52.130.00



cm	BRUENINGS
20	52.132.20
30	52.132.30
40	52.132.40
50	52.132.50
60	52.132.60



BRUENINGS  
52.131.20  
20 cm



FRAENKEL  
52.150.00



SEIFFERT  
52.152.00



FRAENKEL  
52.154.00



SCHEINMANN  
52.155.00



SCHEINMANN  
52.157.00



52.158.02  
52.158.03  
BRUENINGS  
52.158.02-52.158.03



52.160.02  
52.160.03  
BRUENINGS  
52.160.02-52.160.03



LANGE  
52.162.00



52.164.01  
52.164.02  
KRAUSE  
52.164.01-52.164.02



KRAUSE  
52.166.00

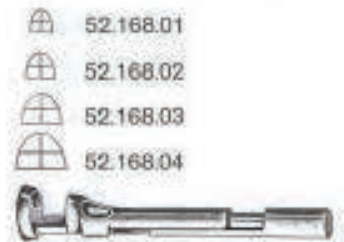

52.168.01  
52.168.02  
52.168.03  
52.168.04  
CORDES  
52.168.01-52.168.04



SCHUMACHER  
52.170.00



52.172.01  
52.172.02  
CORDES  
52.172.01-52.172.02



CORDES  
52.174.00



ROSENBERG  
52.176.00

# Kehlkopf

Larynx  
Larynx  
Laringe  
Laringe



CHEVALIER-JACKSON  
52.230.01-52.260.07

cm	Fig. 1	Fig. 2	Fig. 3	Fig. 4	Fig. 5	Fig. 6	Fig. 7
30	52.230.01	52.230.02	52.230.03	52.230.04	52.230.05	52.230.06	52.230.07
40	52.240.01	52.240.02	52.240.03	52.240.04	52.240.05	52.240.06	52.240.07
50	52.250.01	52.250.02	52.250.03	52.250.04	52.250.05	52.250.06	52.250.07
60	52.260.01	52.260.02	52.260.03	52.260.04	52.260.05	52.260.06	52.260.07

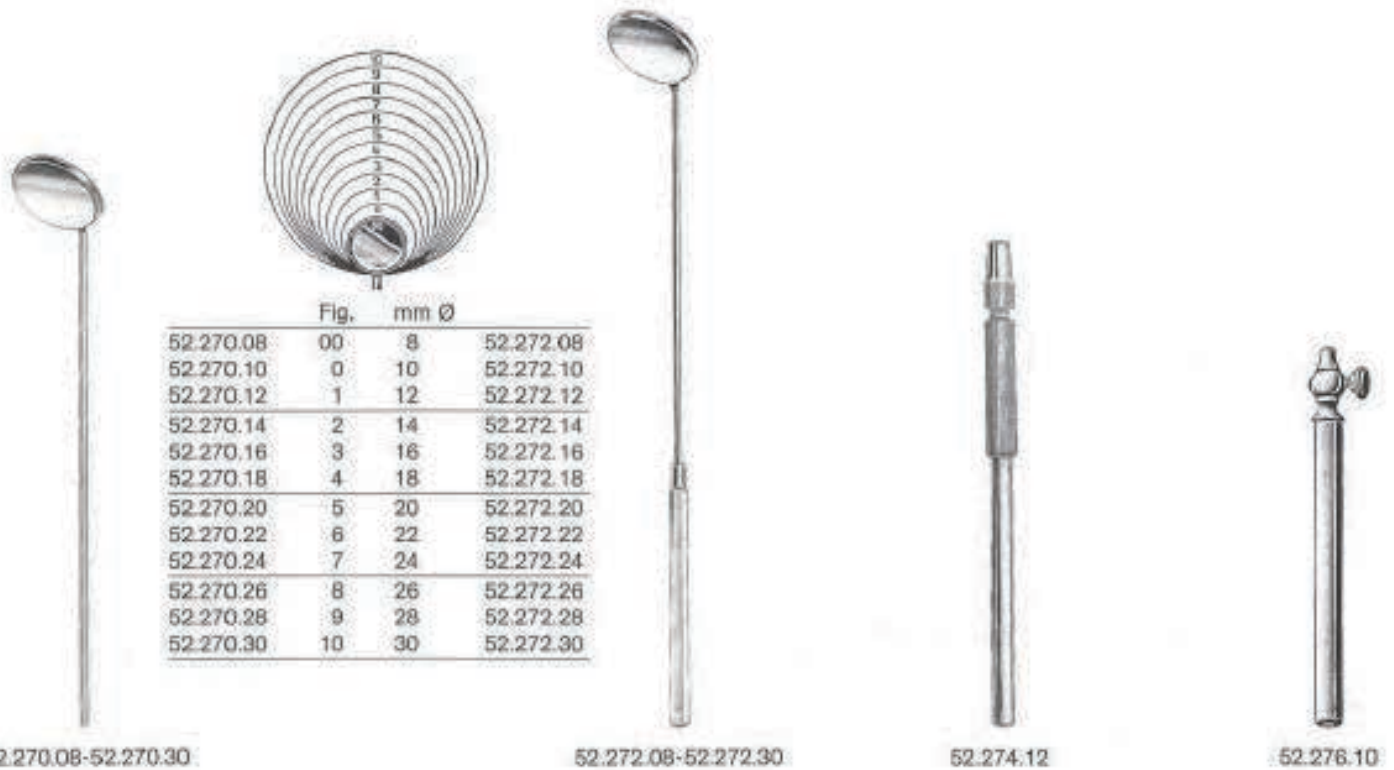

	Fig.	mm Ø	
52.270.08	00	8	52.272.08
52.270.10	0	10	52.272.10
52.270.12	1	12	52.272.12
52.270.14	2	14	52.272.14
52.270.16	3	16	52.272.16
52.270.18	4	18	52.272.18
52.270.20	5	20	52.272.20
52.270.22	6	22	52.272.22
52.270.24	7	24	52.272.24
52.270.26	8	26	52.272.26
52.270.28	9	28	52.272.28
52.270.30	10	30	52.272.30

52.270.08-52.270.30

52.272.08-52.272.30

52.274.12

52.276.10



Tracheotomie, Kropf  
Tracheostomy, Goitre  
Trachéotomie, Goitre  
Traqueotomía, Bocio  
Tracheotomia, Gozzo



## Tracheotomie

Tracheostomy  
Trachéotomie  
Traqueotomía  
Tracheotomia

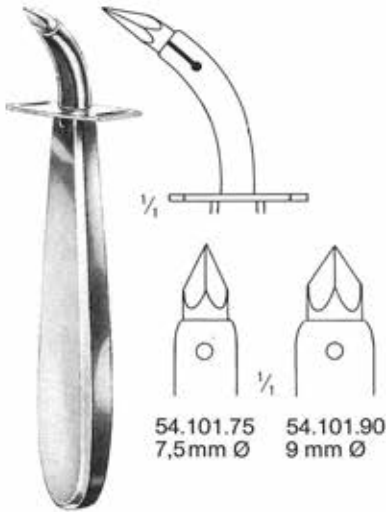

UCKERMANN  
54.101.75-54.101.90  
13 cm

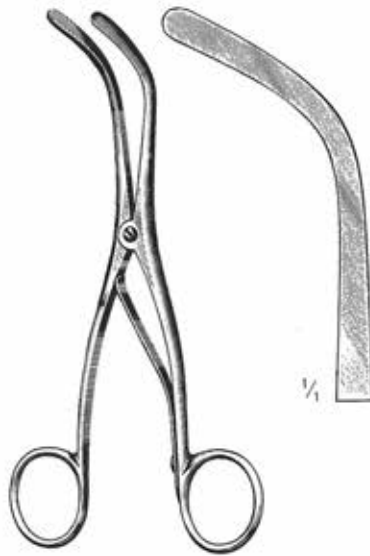

TROUSSEAU  
54.111.14  
14 cm

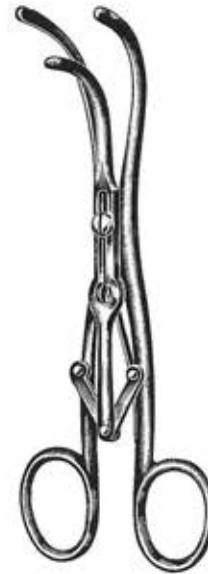

LABORDE  
54.113.14  
14 cm



BOSE  
54.115.07  
7 cm



JACKSON  
54.116.15  
15 cm



JACKSON  
54.117.17  
17 cm



ITERSON  
54.118.16-54.119.16  
16 cm

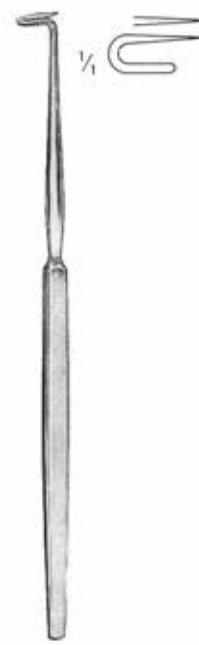

BOSE  
54.122.16  
16 cm



BOSE  
54.124.16  
16 cm

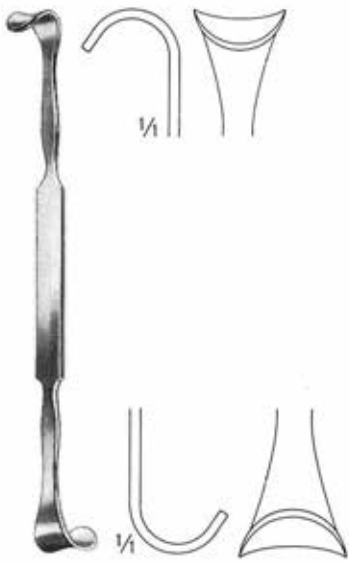

**ROSE**  
 54.130.13  
 13 cm



mm	WAGENER-MOSHER
5	54.151.05
7	54.151.07
9	54.151.09



54.270.00



Fig.	mm	LUER
0	4	54.220.04
1	5	54.220.05
2	6	54.220.06
3	7	54.220.07
4	8	54.220.08
5	9	54.220.09
6	10	54.220.10
7	11	54.220.11
8	12	54.220.12
9	13	54.220.13



Fig.	mm	JACKSON
0	4	54.240.04
1	5	54.240.05
2	6	54.240.06
3	7	54.240.07
4	8	54.240.08
5	9	54.240.09
6	10	54.240.10
7	11	54.240.11
8	12	54.240.12
9	13	54.240.13

## Tracheotomie

Tracheostomy  
Trachéotomie  
Traqueotomía  
Tracheotomia

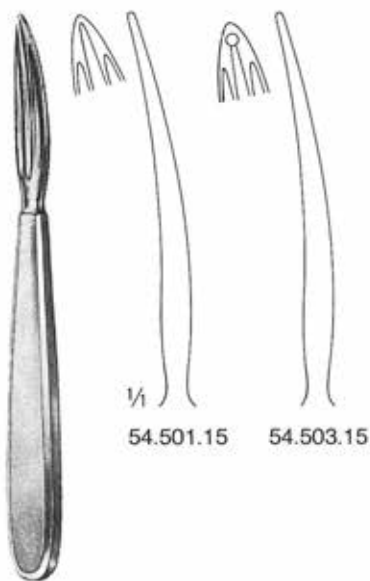

54.501.15

54.503.15

KOCHER  
54.501.15-54.503.15  
15 cm



SCHOENBORN  
54.511.21  
21 cm



cm	LAHEY
15	54.520.15
20	54.520.20



MASTIN  
54.523.17  
17 cm



Herz-, Gefäß- und Thoraxchirurgie  
Cardiovascular and Thoracic Surgery  
Chirurgie cardiovasculaire et thoracique  
Cirugía cardiovascular y torácica  
Chirurgia cardio-vascolare e toracica

**Spezialkatalog**

Special catalog  
Catalogue spécial  
Catálogo especial  
Catalog speciale

***dimed***<sup>®</sup>  
SURGICAL INSTRUMENTS



Herz-, Gefäß- und Thoraxchirurgie  
Cardiovascular and Thoracic Surgery  
Chirurgie cardiovasculaire et thoracique  
Cirugía cardiovascular y torácica  
Chirurgia cardio-vascolare e toracica

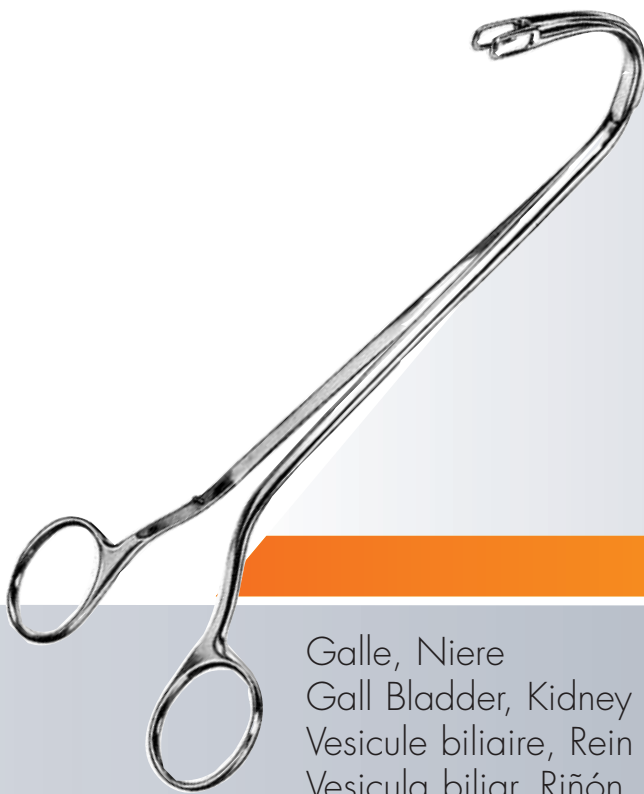

Galle, Niere  
Gall Bladder, Kidney  
Vesicule biliaire, Rein  
Vesicula biliar, Riñón  
Vesicola biliare, Rene

## Gallensteinzangen

Gall Stone Forceps

Pinces pour calculs biliaires

Pinzas para cálculos biliares

Pinze per calcoli biliari

sehr schlankes Modell  
very slender pattern  
modèle très fin  
modelo muy delgado  
modello molto delicato



**62.101.23**  
Fig.1



**62.103.23**  
Fig.2



**62.103.24**



**62.103.25**

DESJARDINS  
23,0 cm **62.101.23**  
23,0 cm **62.103.23**

DESJARDINS  
24,0 cm **62.103.24**  
22,5 cm **62.103.25**



**Gallensteinzangen**  
Gall Stone Forceps  
Pinces pour calculs biliaires  
Pinzas para cálculos biliares  
Pinze per calcoli biliari

**dimeda**<sup>®</sup>  
SURGICAL INSTRUMENTS



CZERNY  
25,0 cm **62.105.25**



BLAKE  
21,0 cm **62.106.20**

cm **62.107.20**  
cm **62.107.23**

Galle, Niere / Gall Bladder, Kidney / Vesicule biliaire, Rein / Vesicula biliar, Riñón / Vesicola biliare, Rene

## Gallensteinzangen

Gall Stone Forceps

Pinces pour calculs biliaires

Pinzas para cálculos biliares

Pinze per calcoli biliari



MAYO BLAKE  
20,0 cm **62.110.20**



MAYO BLAKE  
20,0 cm **62.111.20**



MIXTER  
22,0 cm **62.117.22**

## Gallenkanaldilatatoren

Gall Duct Dilators  
Dilatateurs pour les voies biliaires  
Dilatadores para conducto biliar  
Dilatatori per condotti biliari

**dimeda**<sup>®</sup>  
SURGICAL INSTRUMENTS

Gallensteinlöffel  
Gall Stone Scoops  
Curettes pour calculs biliaires  
Cucharillas para coger cálculos biliares  
Cuchhiai per calcoli biliari



MOORE  
28,0 cm **62.125.28**

federnd  
elastic  
élastic  
elásticas  
elastiche

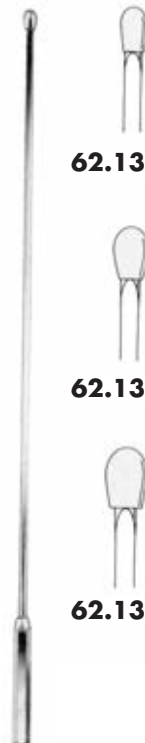

DESJARDINS  
28,0 cm **62.130.13**  
28,0 cm **62.130.18**  
28,0 cm **62.130.21**

Gallensteinsonde  
Gall Stone Probes  
Sondes à calculs biliaires  
Sondas-exploradoras para cálculos biliares  
Sonde per calcoli biliari



MOYNIHAN  
34,0 cm **62.142.34**

## Gallenkanaldilatatoren

Gall Duct Dilators

Dilatateurs pour les voies biliaires

Dilatadores para conducto biliar

Dilatatori per condotti biliari

biegsamer Schaft  
malleable shaft  
tige malléable  
vástago maleable  
gambo flessibile



BAKES  
32,0 cm



Fig. 1

**62.150.01**  
Ø 1 mm



Fig. 2

**62.150.02**  
Ø 2 mm



Fig. 3

**62.150.03**  
Ø 3 mm



Fig. 4

**62.150.04**  
Ø 4 mm



Fig. 5

**62.150.05**  
Ø 5 mm



Fig. 6

**62.150.06**  
Ø 6 mm



Fig. 7

**62.150.07**  
Ø 7 mm



Fig. 8

**62.150.08**  
Ø 8 mm



Fig. 9

**62.150.04**  
Ø 9 mm



Fig. 10

**62.150.10**  
Ø 10 mm



Fig. 11

**62.150.11**  
Ø 11 mm



Fig. 12

**62.150.12**  
Ø 12 mm



Fig. 13

**62.150.13**  
Ø 13 mm

BAKES

**62.150.00**

**62.150.03 - 62.150.11**

Satz à 9 Stück in Leinentuchtaschen  
set of 9 pieces in canvas pocket  
jeu de 9 pièces dans une poche en toile  
juego de 9 unidades en bolsa de tela  
set di 9 pezzi

## Gallensteinlöffel

Gall Stone Scoops

Curettes pour calculs biliaires

Cucharas para cálculos biliares

Pinze per calcoli biliari

**dimeda**<sup>®</sup>  
SURGICAL INSTRUMENTS

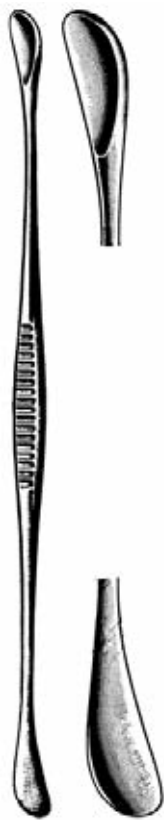

FERGUSSON  
21,5 cm **62.170.21**



MAYO  
28,0 cm **62.175.27**



MAYO  
27,0 cm **62.178.01**  
27,0 cm **62.178.02**  
27,0 cm **62.178.03**

Galle, Niere / Gall Bladder, Kidney / Vesicule biliaire, Rein / Vesicula biliar, Riñón / Vesicula biliar, Rene

## Gallensteinlöffel

Gall Stone Scoops  
Curettes pour calculs biliaires  
Cucharas para cálculos biliares  
Pinze per calcoli biliari

federnd  
elastic  
élastiques  
elásticas  
elastiche



DESJARDINS  
30,0 cm



**62.180.17**  
6 mm



**62.180.21**  
7 mm



**62.180.24**  
8 mm



**62.180.27**  
9 mm

## Gallensteinlöffel

Gall Stone Scoops

Curettes pour calculs biliaires

Cucharas para cálculos biliares

Pinze per calcoli biliari

**dimeda**<sup>®</sup>  
SURGICAL INSTRUMENTS



LUER-KOERTE  
32,0 cm



Fig. 000

**62.190.01**  
Ø 2,5 mm



Fig. 00

**62.190.02**  
Ø 3,2 mm



Fig. 0

**62.190.03**  
Ø 4,2 mm



Fig. 1

**62.190.03**  
Ø 5,5 mm



Fig. 2

**62.190.05**  
Ø 6,7 mm



Fig. 3

**62.190.06**  
Ø 8,0 mm



Fig. 4

**62.190.07**  
Ø 11,0 mm



Fig. 5

**62.190.08**  
Ø 15,0 mm

Galle, Niere / Gall Bladder, Kidney / Vesicule biliaire, Rein / Vesicula biliar, Riñón / Vesicola biliar, Rene



## Ureterklemmen

Ureter Clamps

Pinces-clapms uretère

Pinzas clamps para ureter

Pinze per uretere



MAYO  
32,0 cm **62.210.32**



LURZ  
21,0 cm **62.221.21**



LURZ  
21,0 cm **62.223.21**

## Nierensteinzangen

Kidney Stone Forceps  
Pinces pour les calculs du bassin  
Pinzas para cálculos renales  
Pinze per calcoli renali

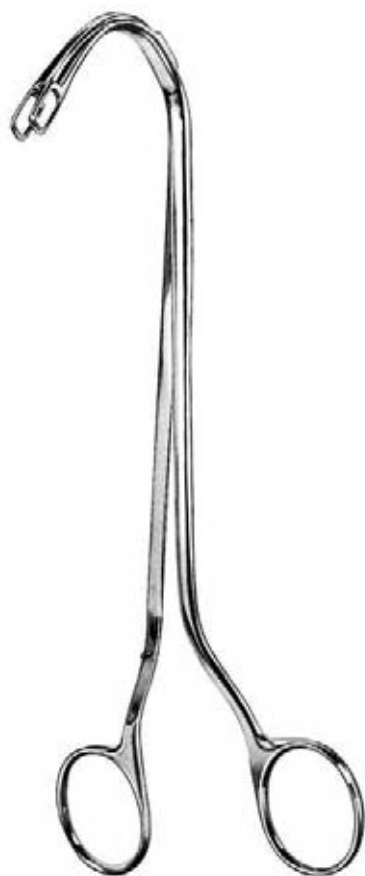

RANDALL



**62.231.01**

23,0 cm

Fig. 1

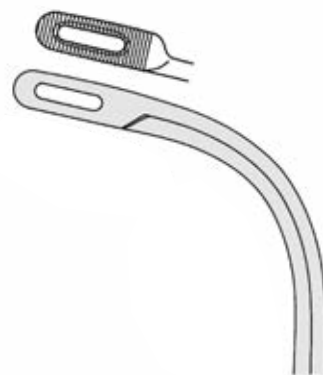

**62.231.02**

21,0 cm

Fig. 2

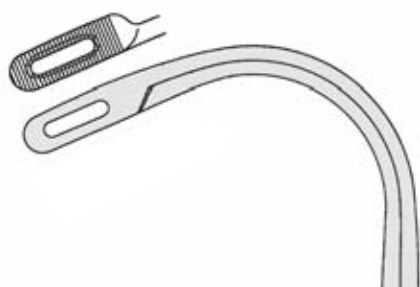

**62.231.03**

19,0 cm

Fig. 3

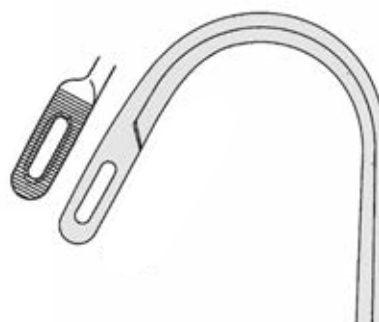

**62.231.04**

18,5 cm

Fig. 4

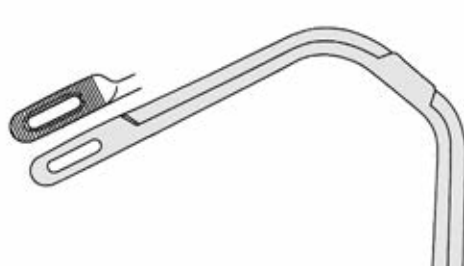

**62.231.05**

19,0 cm

Fig. 5



**62.231.06**

19,0 cm

Fig. 6

## Nierensteinzangen

Kidney Stone Forceps  
Pincés pour les calculs du bassin  
Pinzas para cálculos renales  
Pinze per calcoli renali

feines Modell  
delicate pattern  
modèle délicat  
modelo fino  
modello delicato



RANDALL

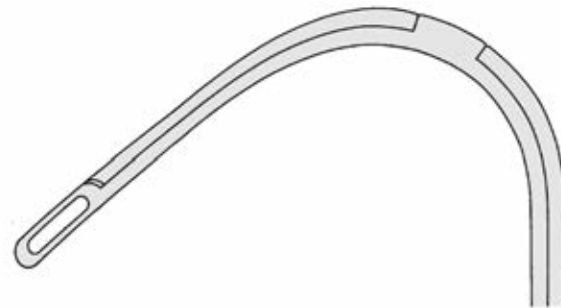

**62.231.23**  
23,0 cm  
Fig. 1

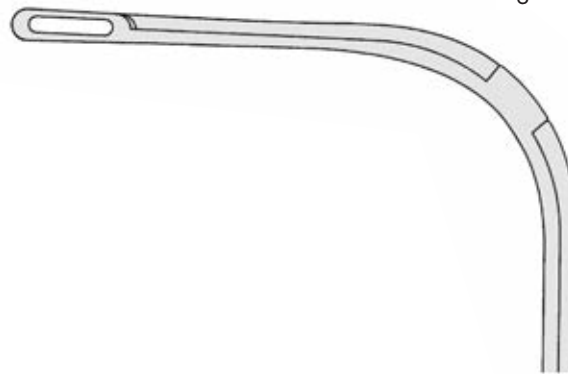

**62.231.24**  
24,5 cm  
Fig. 2

## Nierensteinzangen

Kidney Stone Forceps  
Pinces pour les calculs du bassin  
Pinzas para cálculos renales  
Pinze per calcoli renali

für Kinder  
for children  
pour enfants  
para niños  
per bambini



HEIMING

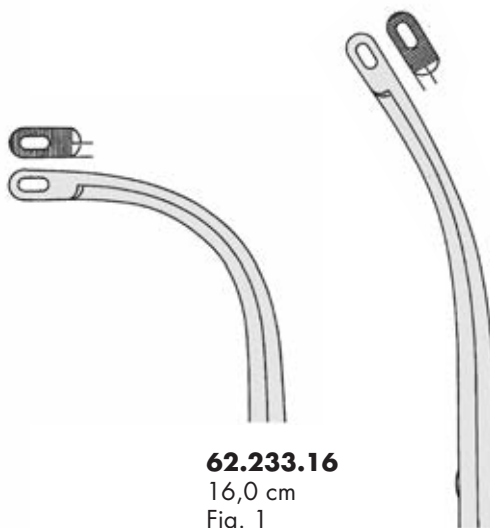

**62.233.16**  
16,0 cm  
Fig. 1



**62.233.17**  
17,0 cm  
Fig. 2

Nierenfistelzangen  
Nephrostomy Forceps  
Pinces à néphrostomie  
Pinzas para nefrostomia  
Pinze per nefrostomia



**ELSAESSER**  
21,0 cm

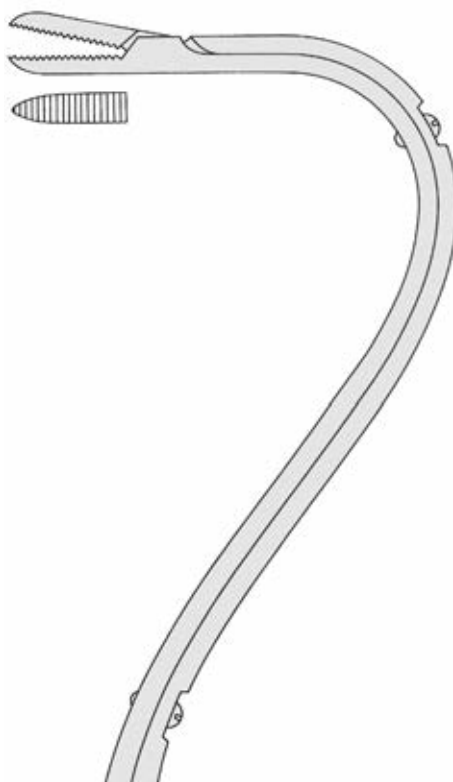

**62.235.01**  
Fig. 1

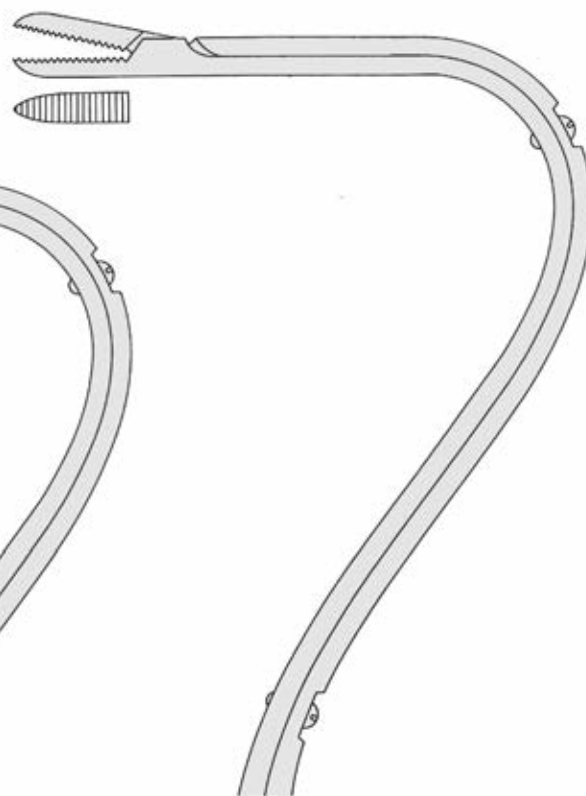

**62.235.02**  
Fig. 2



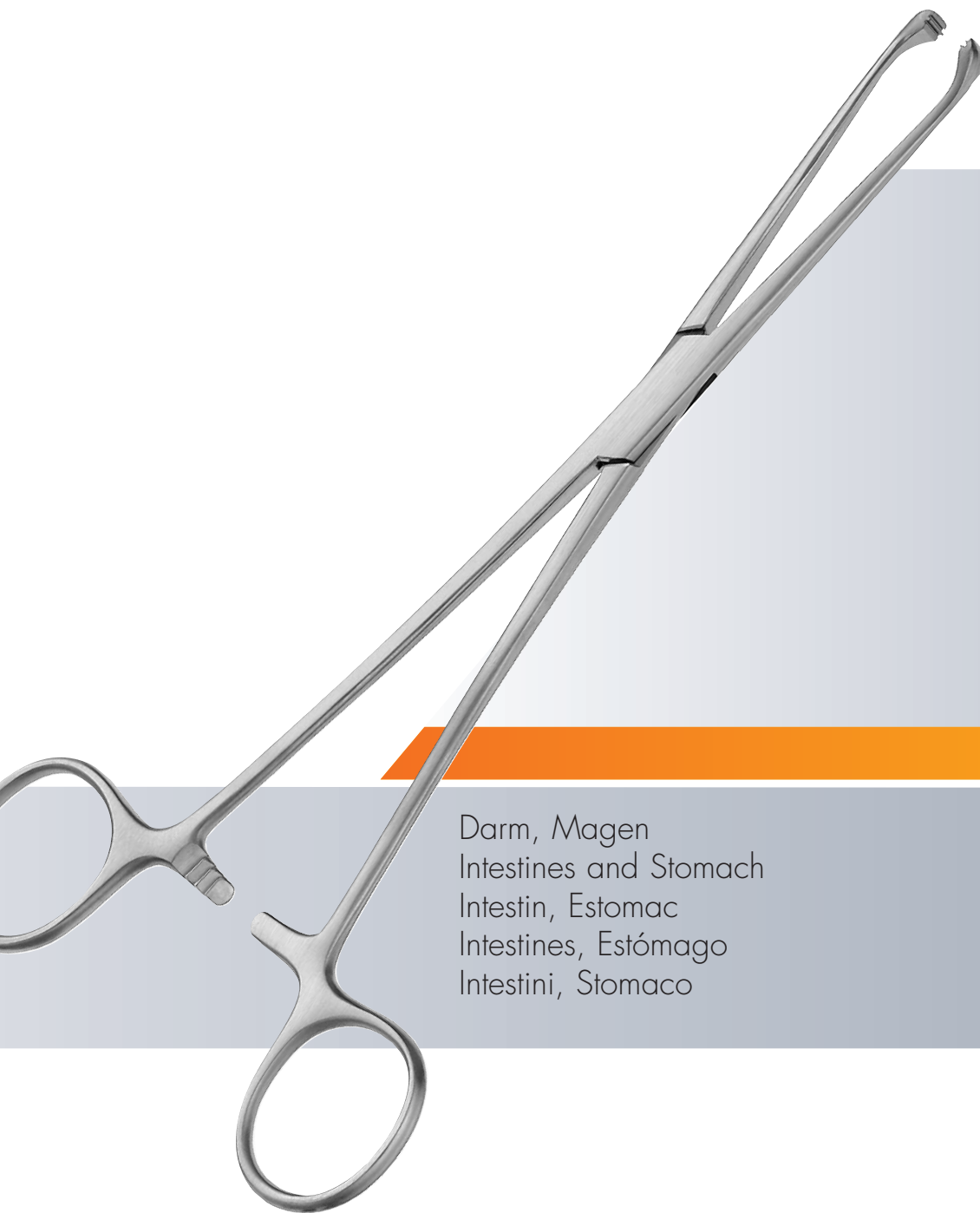

Darm, Magen  
Intestines and Stomach  
Intestin, Estomac  
Intestines, Estómago  
Intestini, Stomaco

## Darm- und Gewebefäßzangen

Bowel and Tissue Grasping Forceps  
 Pincés à saisir les intestins et les tissus  
 Pinzas para coger intestinos y tejidos  
 Pinze per afferrare intestini e tessuti



ALLIS-Baby  
64.102.14  
14 cm



4:5	ALLIS	5:6
64.110.15	15 cm	64.120.15
	19 cm	64.120.19
	22 cm	64.120.22
	24 cm	64.120.24

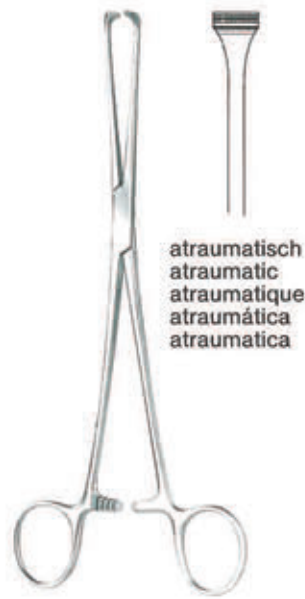

atraumatisch  
atraumatic  
atraumatique  
atraumática  
atraumatica

cm	ALLIS
16	64.124.16
20	64.124.20
25	64.124.25



ALLIS-ADAIR  
64.130.15  
15,5 cm



cm	JUDD-ALLIS
15	64.140.15
19	64.140.19

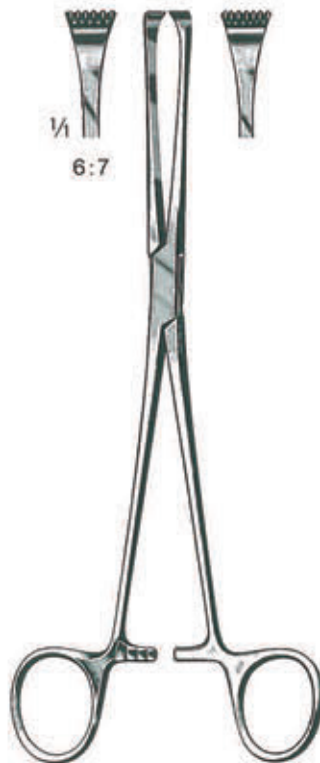

THOMS-ALLIS  
64.150.20  
20 cm

Mit TC-Einsätzen  
TC Lined  
A mors TC  
Con bocas TC  
Con morso TC

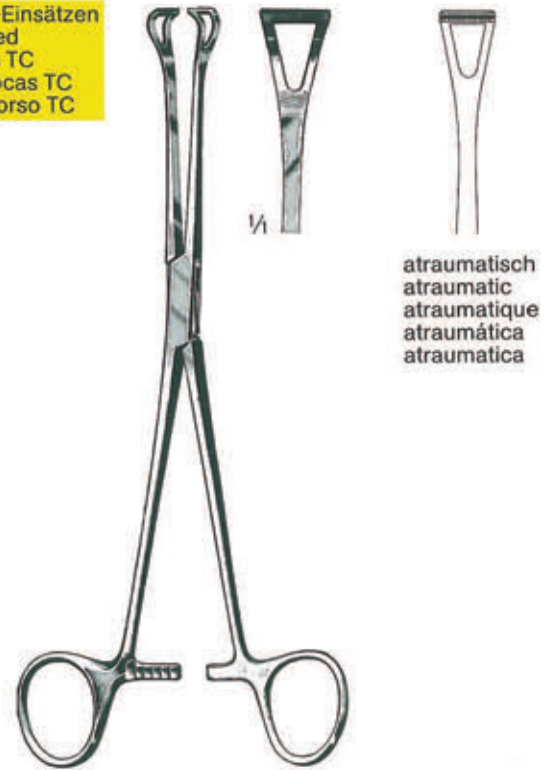

atraumatisch  
atraumatic  
atraumatique  
atraumática  
atraumatica

cm	BABCOCK	TC	
16	64.160.16	64.164.16	64.168.16
18	64.160.18		
20	64.160.20	64.164.20	64.168.20
24	64.160.24		



**Darm, Magen**  
 Intestines and Stomach  
 Intestin, Estomac  
 Intestines, Estómago  
 Intestini, Stomaco

Mit TC-Einsätzen  
 TC Lined  
 A mors TC  
 Con bocas TC  
 Con morso TC



DUVAL  
 13 mm



DUVAL  
 25 mm

cm	DUVAL 13 mm	DUVAL 25 mm
18	64.170.18	
20	64.170.20	64.172.20
20	64.174.20	
23		64.172.23



DUVAL  
 64.170.18-64.174.20



WILLIAMS  
 64.180.16  
 16,5 cm



SCHOENBURG  
 64.182.22  
 22 cm

Darmklemmen  
 Intestinal Forceps  
 Pinzas intestinales  
 Pinzas intestinales  
 Pinze intestinali



DOYEN  
 DOYEN-Baby  
 64.210.18-64.217.23

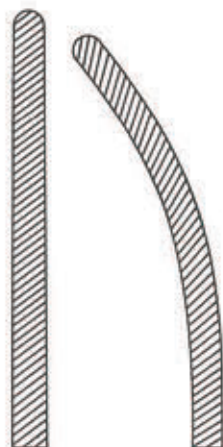

cm DOYEN-Baby

16		
18	64.210.18	64.211.18
21		
23		

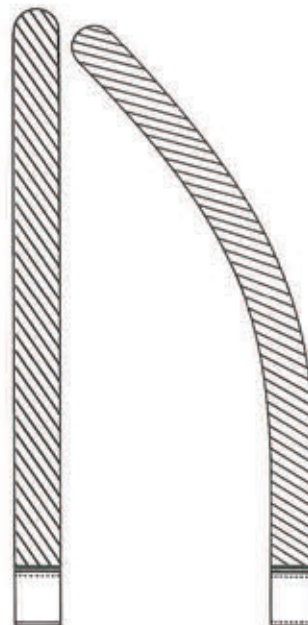

DOYEN

	64.210.21	64.211.21
	64.210.23	64.211.23

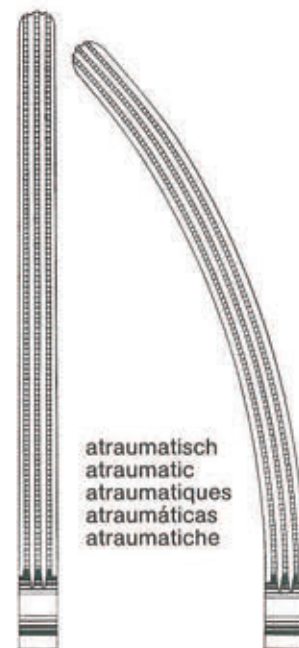

atraumatisch  
 atraumatic  
 atraumatiques  
 atraumáticas  
 atraumatiche

DOYEN

	64.216.16	64.217.16
	64.216.18	64.217.18
	64.216.21	64.217.21
	64.216.23	64.217.23

Darmklemmen  
 Intestinal Forceps  
 Pincas intestinales  
 Pinzas intestinales  
 Pinze intestinali



KOCHER  
 64.220.22-64.227.28

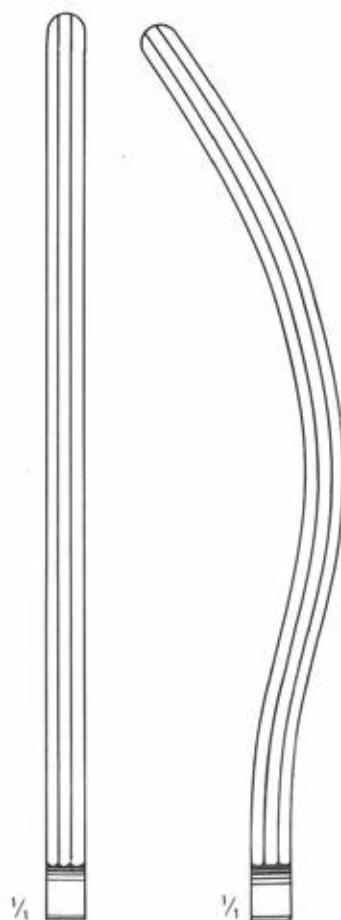

1/1

1/1

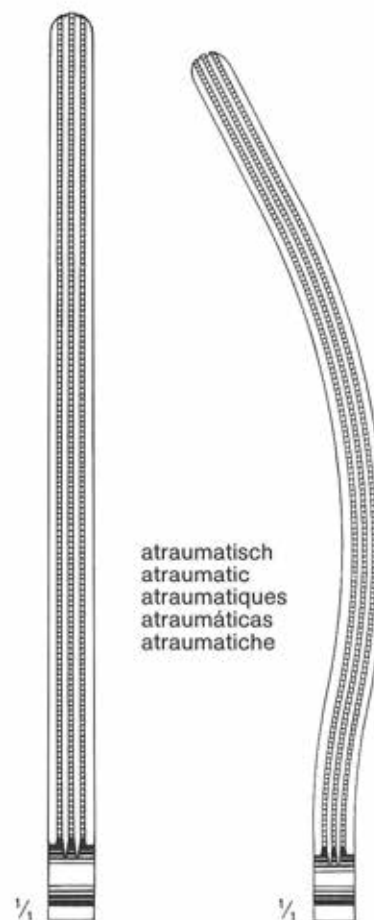

atraumatisch  
 atraumatic  
 atraumatiques  
 atraumáticas  
 atraumatiche

1/1

1/1

cm	KOCHER			
22	64.220.22	64.221.22	64.226.22	64.227.22
25	64.220.25	64.221.25	64.226.25	64.227.25
28	64.220.28	64.221.28	64.226.28	64.227.28

Darmklemmen  
Intestinal Forceps  
Pinces intestinales  
Pinzas intestinales  
Pinze intestinali

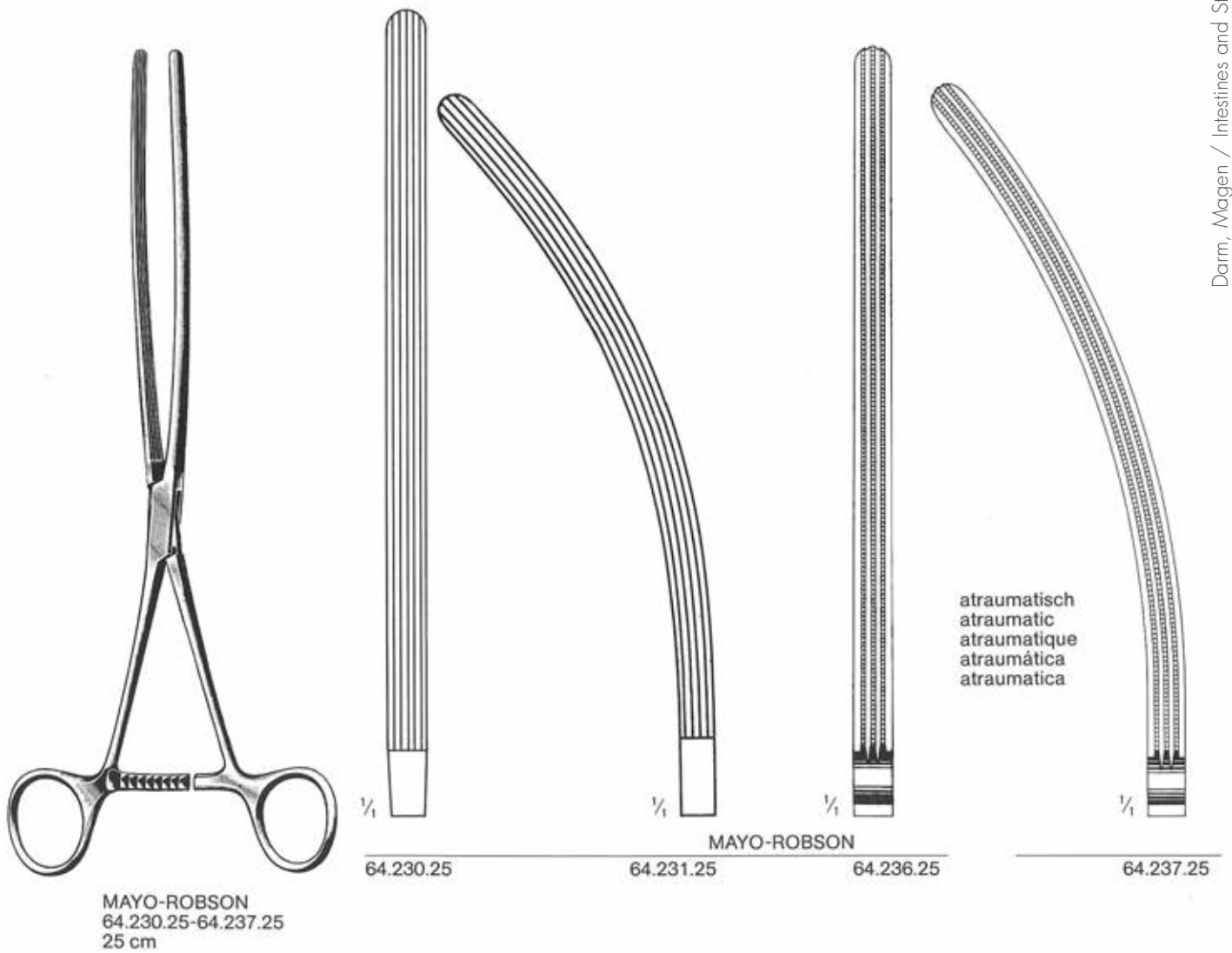

## Darm, Magen

Intestines and Stomach

Intestin, Estomac

Intestines, Estómago

Intestini, Stomaco



normal	FEHLAND	atraum.
64.241.23	23,5 cm	64.247.23

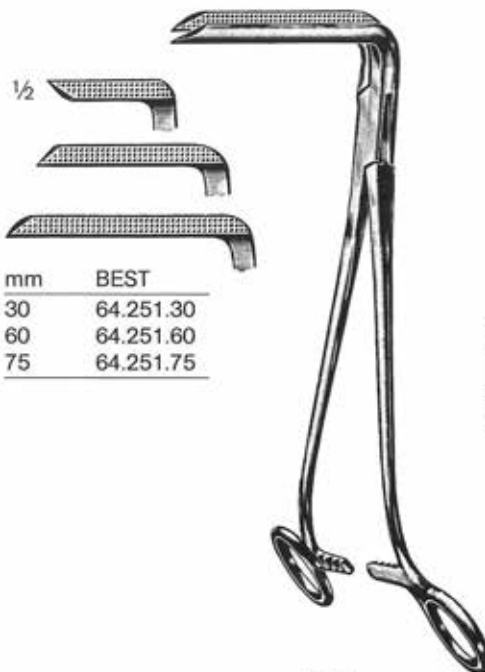

BEST  
64.251.30-64.251.75  
26,5 cm

Darm- und Magenklammern  
Intestinal and Stomach Clamps  
Pinzas-clamps intestinales  
Pinzas-clamps intestinales y estomacales  
Pinze intestinali e stomacali



BRUNNER  
64.260.24-64.266.24  
24 cm

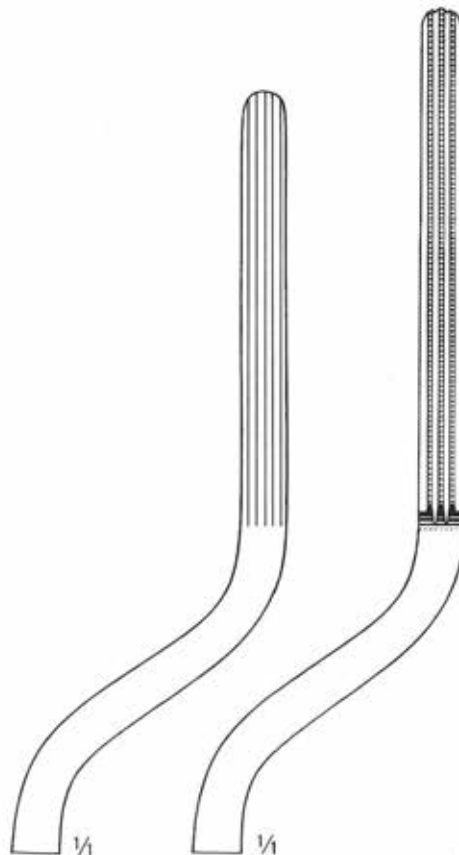

BRUNNER  
64.260.24 64.266.24

atraumatisch  
atraumatic  
atraumatique  
atraumática  
atraumatica



STONE  
64.270.15  
15,5 cm



STONE-WATT  
64.274.00



cm	STONE-WATT
7,5	64.272.07
10	64.272.10

Anastomosenklemmen und Zubehör  
 Anastomosis Clamps and Accessories  
 Clamps à anastomose et accessoires  
 Clamps para anastomosis y accesorios  
 Pinze per anastomosi e accessori

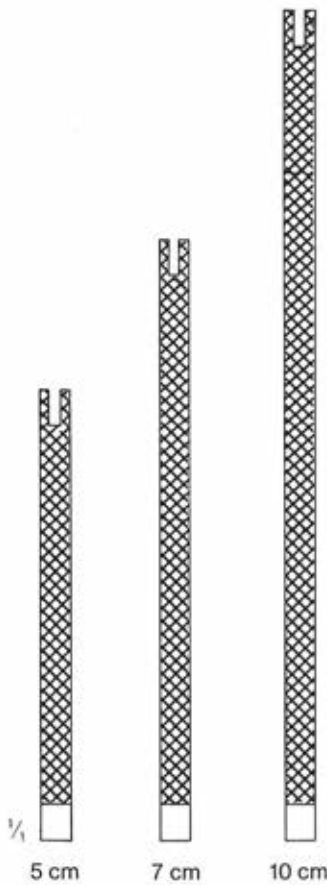

5 cm      7 cm      10 cm



cm	DE MARTEL-WOLFSON
5	64.280.05
7	64.280.07
10	64.280.10
Set/3	



DE MARTEL-WOLFSON  
 64.282.26  
 26 cm

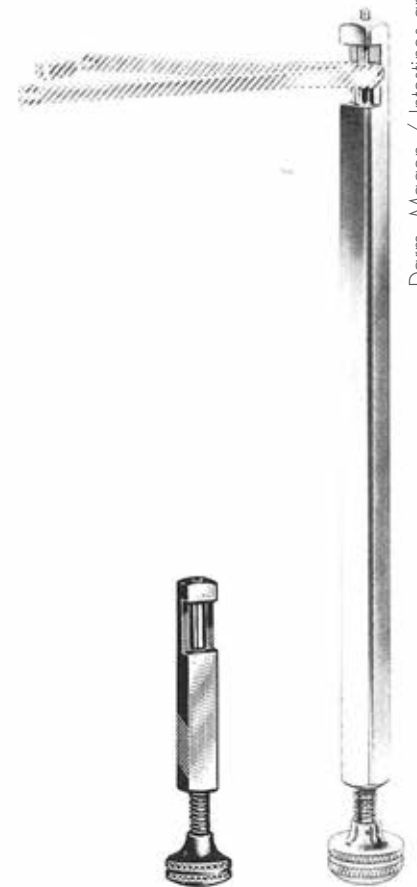

DE MARTEL-WOLFSON  
 64.284.08      64.284.23  
 8,5 cm      23 cm

Darm, Magen / Intestines and Stomach / Intestin, Estomac / Intestines, Estómago / Intestini, Stomaco



**Darm, Magen**  
Intestines and Stomach  
Intestin, Estomac  
Intestines, Estómago  
Intestini, Stomaco

Magenklemmen  
Stomach Clamps  
Pincas-clamps stomacales  
Pinzas-clamps estomacales  
Pinze stomacali

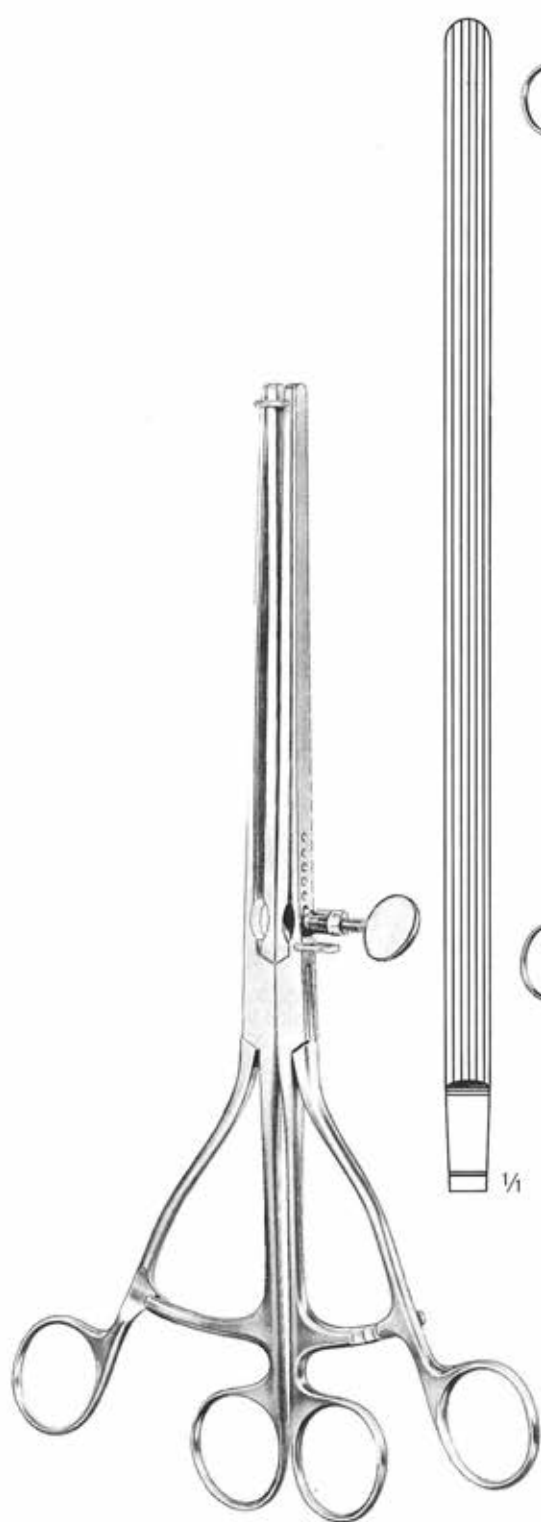

LANE  
64.290.30  
30 cm

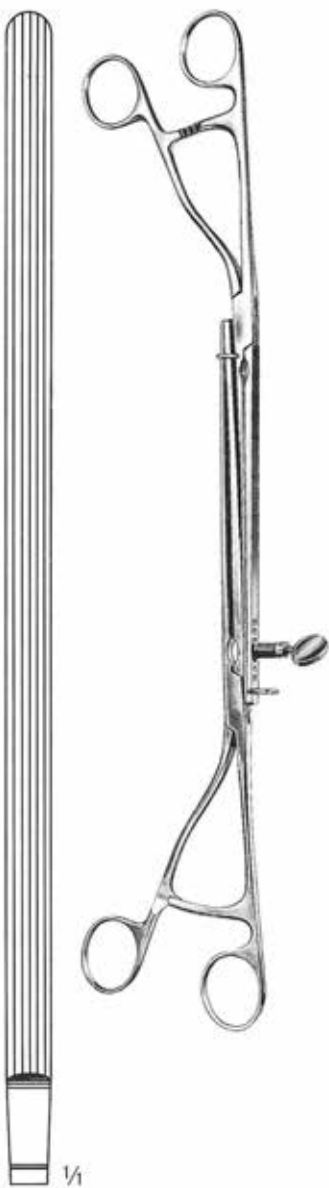

LANE  
64.291.30  
30 cm

Magenklemmen  
 Stomach Clamps  
 Pincas-clamps stomacales  
 Pinzas-clamps estomacales  
 Pinze stomacali



PAYR-Baby  
 64.310.15  
 15 cm



PAYR

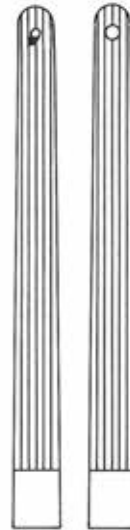

64.310.21  
 21 cm

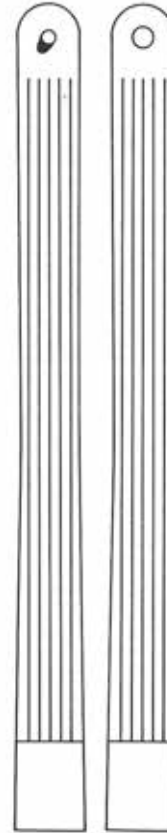

64.310.29  
 29 cm

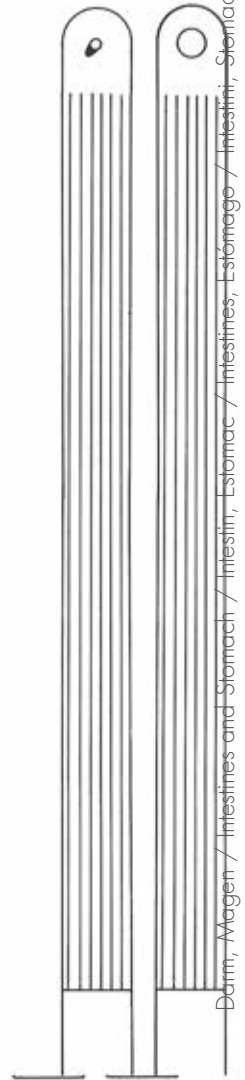

64.310.35  
 35 cm

Darm, Magen / Intestines and Stomach / Intestin, Estomac / Intestines, Estómago / Intestini, Stomaco







Urologie  
Urology  
Urologie  
Urología  
Urologia

## **Prostata Haken, -Faßzange**

Prostatic Retractors, Grasping Forceps

Ecarteurs à prostate, Pince à saisir la prostate

Separadores, Pinza para coger prostata

Divaricatori, Pinza per afferrare la prostata



YOUNG  
**66.101.21**  
21,5 cm



YOUNG  
**66.102.22**  
21,5 cm



YOUNG  
**66.103.22**  
20,5 cm



YOUNG  
**66.105.21**  
22,0 cm



YOUNG  
**66.106.20**  
20,0 cm

## Kapselfasszangen, Fadenführungszange

Capsule Forceps, Ligature Carrying Forceps  
Pincès pour saisir les capsules. Pince porte-fil  
Pinzas capsulares, Pinze porta ligaduras  
Pinze per afferrare capsule, Pinza porta-filo

**dimed**<sup>®</sup>  
SURGICAL INSTRUMENTS



MILLIN  
**66.111.23**  
24,5 cm



MILLIN  
**66.115.24**  
24,5 cm



MILLIN  
**66.117.23**  
22,0 cm



MILLIN  
**66.123.23**  
22,0 cm



Fasszange für vordere Lappen  
Lobe Holding Forceps  
Pince pour saisir les lobes  
Pinza para lóbulos anteriores  
Pinza per lobuli anteriori

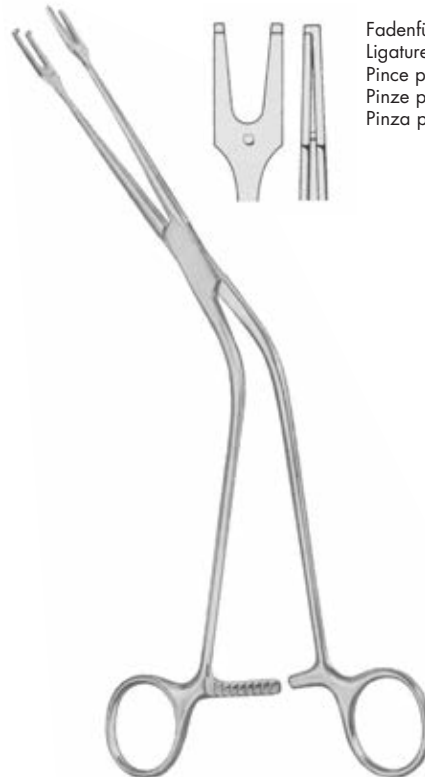

Fadenführungszange  
Ligature Carrying Forceps  
Pince porte-fil  
Pinze porta ligaduras  
Pinza porta-filo

MILLIN  
**66.125.24**  
24,5 cm

## Blasenwundsperrer, Blasenspatel

Bladder Retractors, Bladder Spatula  
Ecarteurs vésicaux, Spatule vésicale  
Separadores vesicales, Espátula vesical  
Divaricatore vesicale, Spatole vescicali



LEGUEU  
**66.147.27**  
27,0 cm



KOCHER  
**66.149.27**  
26,0 cm



JUDD-MASSON  
**66.150.00**

## Blasenwundsperrer

Bladder Retractors  
Ecarteurs vésicaux  
Separadores vesicales  
Divaricatore vescicale

**dimeda**<sup>®</sup>  
SURGICAL INSTRUMENTS



MILLIN  
**66.151.00**

komplett mit je 2 Seitenvalven  
57 x 25 mm und 80 x 25 mm,  
sowie 1 Mittelvalve 120 x 45 mm  
**ohne Kaltlichtaufsatz**

complete with 2 pairs of lateral  
blades 57 x 25 mm and 80 x 25 mm  
and 1 central blade 120 x 45 mm  
**without F.O. Carrier**

complet, avec 2 paires de valves laterales,  
57 x 25 mm et 80 x 25 mm,  
ainsi qu'une valve centrale 120 x 45 mm  
**sans support lumière froide**

completo, con 2 pares de valvas laterales  
57 x 25 mm y 80 x 25 mm  
y una valva central 120 x 45 mm  
**sin portador de luz fria**

completo, con 2 paia di valve laterali  
57 x 25 mm e 80 x 25 mm  
in piú 1 valva centrale 120 x 45 mm  
**senza supporto per luce fredda**

MILLIN  
**66.151.50**

komplett mit je 2 Seitenvalven  
57 x 25 mm und 80 x 25 mm,  
sowie 1 Mittelvalve 120 x 45 mm  
**mit Kaltlichtaufsatz**

complete with 2 pairs of lateral  
blades 57 x 25 mm and 80 x 25 mm  
and 1 central blade 120 x 45 mm  
**with F.O. Carrier**

complet, avec 2 paires de valves laterales,  
57 x 25 mm et 80 x 25 mm,  
ainsi qu'une valve centrale 120 x 45 mm  
**avec support lumière froide**

completo, con 2 pares de valvas laterales  
57 x 25 mm y 80 x 25 mm  
y una valva central 120 x 45 mm  
**con portador de luz fria**

completo, con 2 paia di valve laterali  
57 x 25 mm e 80 x 25 mm  
in piú 1 valva centrale 120 x 45 mm  
**con supporto per luce fredda**

MILLIN  
**66.151.51**

Kaltlichtaufsatz  
F.O. Light Carrier  
Supporto lumière froide  
Portador de luz fria  
Supporto per luce fredda

## Blasenwundsperrer

Bladder Retractors  
Ecarteurs vésicaux  
Separadores vesicales  
Divaricatore vesciale



THOMSON-WALKER  
**66.160.00**

komplett mit  
2 Paar Seitenvalven,  
1 Mittelvalve und  
1 Retraktor

complete with  
2 pairs of lateral blades  
1 central blade and  
1 retractor

complet avec  
2 paires de valves laterales  
1 valve centrale  
1 écarteur

completo con  
2 pares de valvas laterales  
1 valva central  
1 separador

completo con  
2 paia di valve laterali  
1 valva centrale e  
1 retrattore



LEGUEU  
**66.163.00**



## Gallensteinlöffel

Gall Stone Scoops  
Curettes pour calculs biliaires  
Cucharas para cálculos biliares  
Pinze per calcoli biliari

**dimeda**<sup>®</sup>  
SURGICAL INSTRUMENTS



MILLIN  
**66.165.00**  
29,0 cm



Fremdkörperzangen  
Foreign Body Forceps  
Pinceps à corps étrangers  
Pinzas para cuerpos extraños  
Pinze per corpi estranei

MATHIEU  
**66.168.20**

Schaftlänge 20 cm  
length of shaft 20 cm  
longueur du tige 20 cm  
longitud del vástago 20 cm  
lunghezza del gambo 20 cm

MATHIEU  
**66.168.28**

Schaftlänge 28 cm  
length of shaft 28 cm  
longueur du tige 28 cm  
longitud del vástago 28 cm  
lunghezza del gambo 28 cm

## Urethrotom

Urethrotome  
Urétrotome  
Uretrótomo  
Uretrotomi

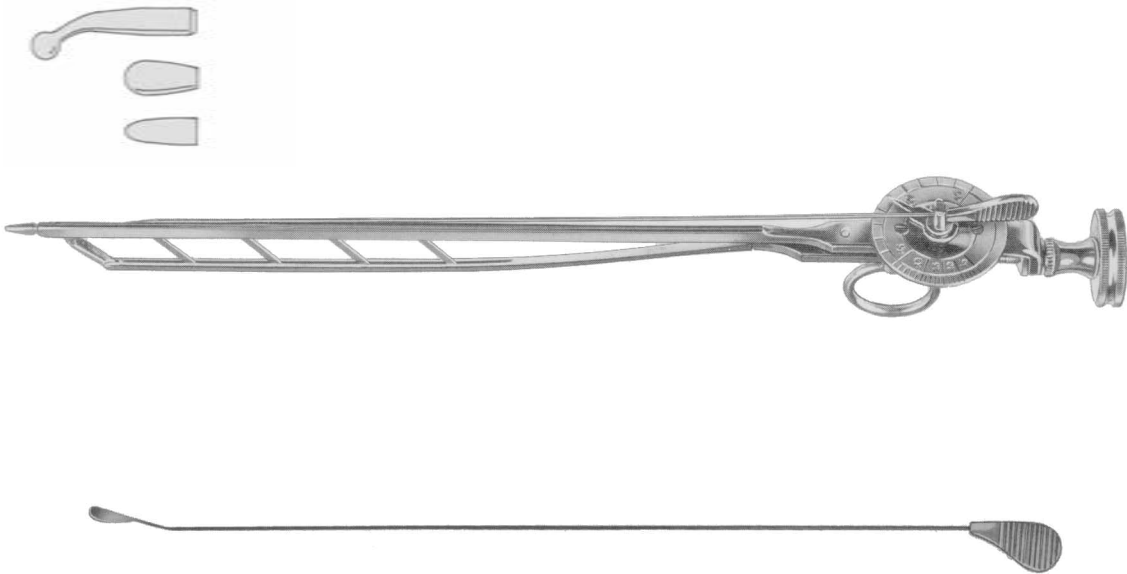

OTIS  
**66.169.01**

Ersatmesser  
Spare Blade  
Couteau de rechange  
Cuchillo de repuesto  
Lama die ricambio

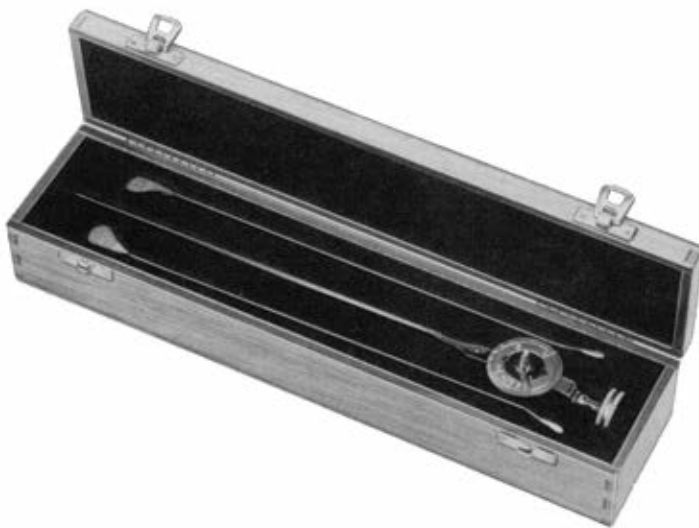

OTIS  
**66.169.00**

komplett mit Holzetui  
mit Dilator, 2 Messern und 3 Ansätzen

complete in wooden case  
with dilator, 2 knives and 3 tips

complet, en boîte métal  
avec dilataleur, 2 lames et 3 embouts

completo an caja de madera  
con dilatador, 2 cuchillos y 3 puntas

completo, in contenitore di legno  
con dilatatore, 2 bisturi e 3 punte

## Urethrographie- und Circumcisions-Instrumente

Urethrography- and Circumcision Instruments  
Instruments pour urétrographie et circoncision  
Instrumentos para uretrografia y circuncisión  
Strumenti per uretrografia e circoncisione

**dimeda**<sup>®</sup>  
SURGICAL INSTRUMENTS

Circumcisionsgerät  
Circumcision Instrument  
Instrument de circoncision  
Instrumento para circuncisión  
Strumento per circoncisione



<b>66.171.08</b>	Ø 8 mm
<b>66.171.11</b>	Ø 11 mm
<b>66.171.13</b>	Ø 13 mm
<b>66.171.14</b>	Ø 14,5 mm
<b>66.171.16</b>	Ø 16 mm
<b>66.171.21</b>	Ø 21 mm
<b>66.171.26</b>	Ø 26 mm
<b>66.171.32</b>	Ø 32 mm

Urethrographieinstrument  
Urethrography Instrument  
Instrument pour urétrographie  
Instrumento para uretrografia  
Strumento per uretrografia



66.172.01

KNUTSON-KOCH

**66.172.01**

Konus  
Cone  
Cône  
Cono  
Cono

KNUTSON  
**66.172.00**

Beschneidungsinstrument  
Circumcision Instrument  
Instrument de circoncision  
Instrumento para circuncisión  
Strumento per circoncisione



MOGAN

**66.174.01**

für Erwachsene  
for adults  
pour adultes  
para adultos  
per adulti

**66.174.02**

für Kinder  
for children  
pour enfants  
para niños  
per bambini

## Urologie-Instrumente

Urological Instruments  
Instruments pour l'urologie  
Instrumental para urologia  
Strumenti per l'urologia

Penisklemmen  
Meatus Clamps  
Compresseurs de l'urètre  
Compresores uretrales  
Serrapene



**STOCKMANN**  
**66.175.08**  
8,0 cm



**STRAUSS**  
**66.177.11**  
11,0 cm

Zange zum Erfassen der Glans und der Vorhaut  
Forceps for grasping the glans and the foreskin



**66.179.12**  
12,5 cm

Klemme zum Fixieren des Samenstranges  
Fixation clamp for the spermatic cord  
Pince pour fixer le cordon  
Pinza para fijar el cordón espermático  
Pinza per fissare il tronco spermatico



**66.179.15**  
14,5 cm

**Sekretlöffel, Katheterspanner**

Secretions Scoops, Catheter Introducer  
Cuiller à sécrétions, Introducteur de sondes  
Cucharillas p. secreciones, Introducer de catéres  
Cucchia per secrezioni, mandrini per sonda uretrali

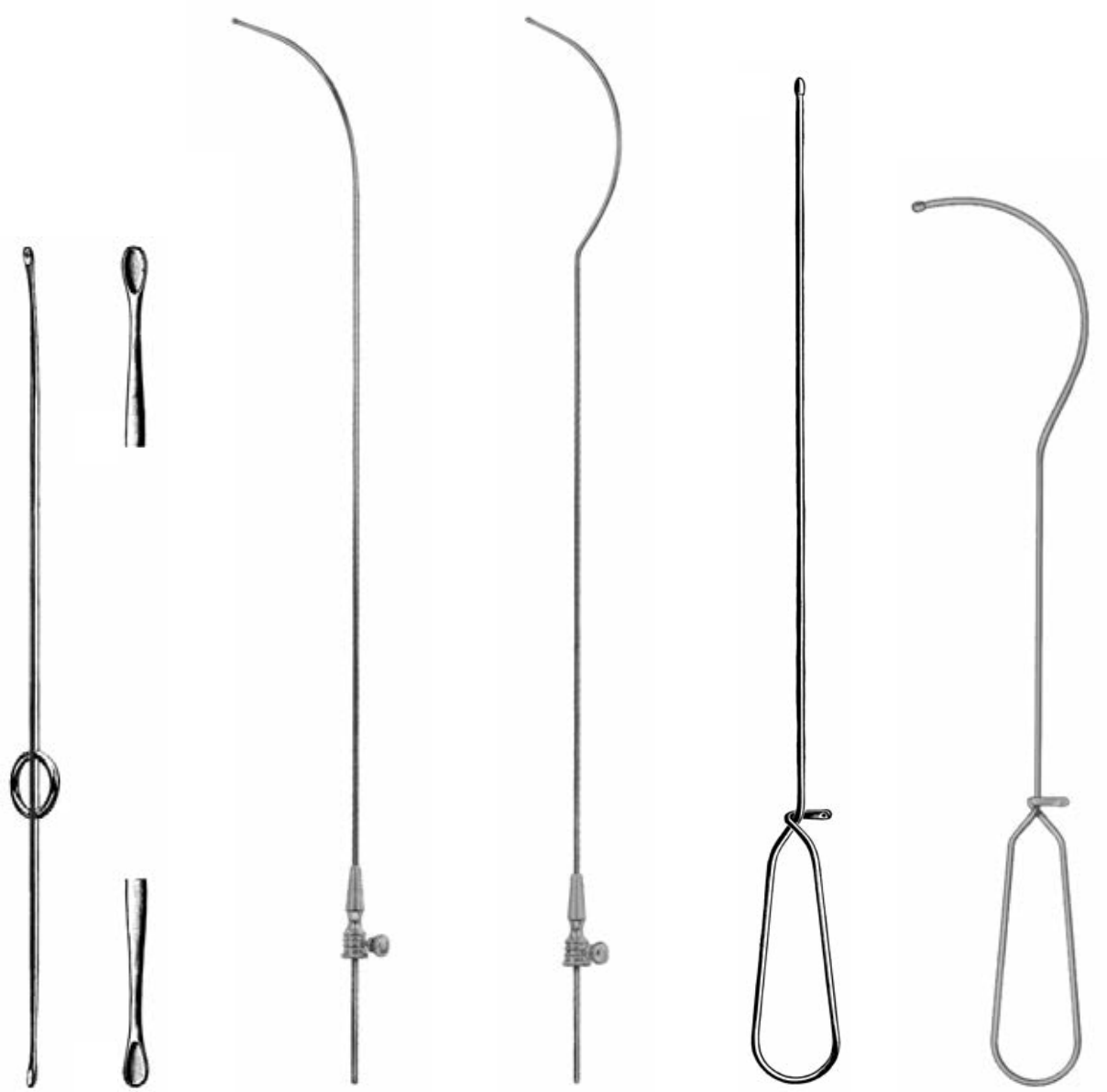

**GUTTMANN**  
**66.180.26**  
26,5 cm

**DITTEL**  
**66.182.46**  
46,0 cm

**GUYON**  
**66.183.46**  
46,0 cm

**GUYON**  
**66.184.39**  
39,0 cm

**GUYON**  
**66.185.35**  
35,0 cm

## Harnröhrenbougies

Urethral Sounds  
Bougies urétrales  
Bujias uretrales  
Candelette dilatatrici

mit Schraubgewinde-Ansatz  
with screw thread  
avec about fileté  
con rosca de tornillo  
con attacco filettato

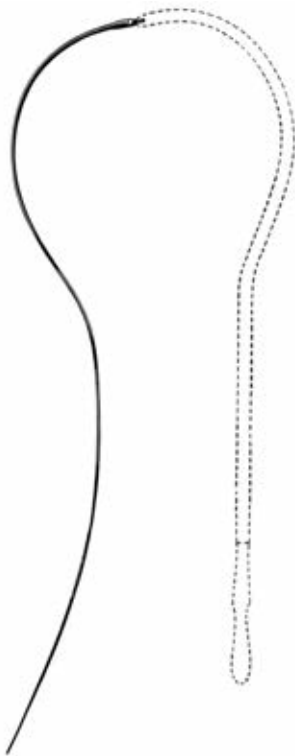

### FILIFORM

<b>66.199.03</b>	3 Ch.
<b>66.199.04</b>	4 Ch.
<b>66.199.05</b>	5 Ch.
<b>66.199.06</b>	6 Ch.

Satz mit 21 Bougies, Charr. 10 bis 30  
mit 4 Gleitsonden  
im Metalltui 42 x 17,5 x 4 cm

set with 21 bougies, Charr. 10 to 30  
with 4 filiform bougies  
in metal case 42 x 17,5 x 4 cm

jeu avec 21 bougies, Charr. 10 jusqu' à 30  
avec 4 bougies conductrices  
en boîte métal 42 x 17,5 x 4 cm

juego de 21 bujias, Charr. 10 a 30  
con 4 bujias filiformes  
en caja metálica 42 x 17,5 x 4 cm

set di 21 dilatatori, Charr. 10 fino a 30  
con 4 candelette dilatatrici  
in contenitore metallico 42 x 17,5 x 4 cm

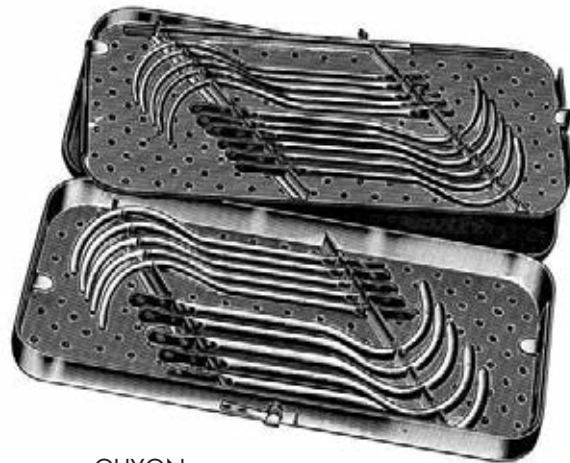

GUYON  
**66.200.00**  
compl.

## Harnröhrenbougies

Urethral Sounds  
Bougies urétrales  
Bujias uretrales  
Candelette dilatatrici



VAN BUREN  
**66.201.00**

Set compl.  
8-36 Charr.

van BUREN	mm Ø	Charrière (French)
<b>66.201.06</b>	2	6
<b>66.201.08</b>	2 <sup>2</sup> / <sub>3</sub>	8
<b>66.201.10</b>	3 <sup>1</sup> / <sub>3</sub>	10
<b>66.201.12</b>	4	12
<b>66.201.14</b>	4 <sup>2</sup> / <sub>3</sub>	14
<b>66.201.16</b>	5 <sup>1</sup> / <sub>3</sub>	16
<b>66.201.18</b>	6	18
<b>66.201.20</b>	6 <sup>2</sup> / <sub>3</sub>	20
<b>66.201.22</b>	7 <sup>1</sup> / <sub>3</sub>	22
<b>66.201.24</b>	8	24
<b>66.201.26</b>	8 <sup>2</sup> / <sub>3</sub>	26
<b>66.201.28</b>	9 <sup>1</sup> / <sub>3</sub>	28
<b>66.201.30</b>	10	30
<b>66.201.32</b>	10 <sup>2</sup> / <sub>3</sub>	32
<b>66.201.34</b>	11 <sup>1</sup> / <sub>3</sub>	34
<b>66.201.36</b>	12	36
<b>66.201.38</b>	12 <sup>2</sup> / <sub>3</sub>	38



## Harnröhrenbougies

Urethral Sounds

Bougies urétrales

Bujias uretrales

Candelette dilatatrici

mit Schraubgewinde-Ansatz  
with screw thread  
avec about fileté  
con rosca de tornillo  
con attacco filettato



GUYON  
**66.203.00**

Set compl.  
10-30 Charr.

GUYON	mm Ø	Charrière (French)
<b>66.203.10</b>	3 <sup>1</sup> / <sub>3</sub>	10
<b>66.203.11</b>	3 <sup>2</sup> / <sub>3</sub>	11
<b>66.203.12</b>	4	12
<b>66.203.13</b>	4 <sup>1</sup> / <sub>3</sub>	13
<b>66.203.14</b>	4 <sup>2</sup> / <sub>3</sub>	14
<b>66.203.15</b>	5	15
<b>66.203.16</b>	5 <sup>1</sup> / <sub>3</sub>	16
<b>66.203.17</b>	5 <sup>2</sup> / <sub>3</sub>	17
<b>66.203.18</b>	6	18
<b>66.203.19</b>	6 <sup>1</sup> / <sub>3</sub>	19
<b>66.203.20</b>	6 <sup>2</sup> / <sub>3</sub>	20
<b>66.203.21</b>	7	21
<b>66.203.22</b>	7 <sup>1</sup> / <sub>3</sub>	22
<b>66.203.23</b>	7 <sup>2</sup> / <sub>3</sub>	23
<b>66.203.24</b>	8	24
<b>66.203.25</b>	8 <sup>1</sup> / <sub>3</sub>	25
<b>66.203.26</b>	8 <sup>2</sup> / <sub>3</sub>	26
<b>66.203.27</b>	9	27
<b>66.203.28</b>	9 <sup>1</sup> / <sub>3</sub>	28
<b>66.203.29</b>	9 <sup>2</sup> / <sub>3</sub>	29
<b>66.203.30</b>	10	30

## Harnröhrenbougies

Urethral Sounds  
Bougies urétrales  
Bujias uretrales  
Candelette dilatatrici



GUYON

GUYON	mm Ø	Charrière (French)
<b>66.205.08</b>	2 <sup>2</sup> / <sub>3</sub>	8
<b>66.205.09</b>	3	9
<b>66.205.10</b>	3 <sup>1</sup> / <sub>3</sub>	10
<b>66.205.11</b>	3 <sup>2</sup> / <sub>3</sub>	11
<b>66.205.12</b>	4	12
<b>66.205.13</b>	4 <sup>1</sup> / <sub>3</sub>	13
<b>66.205.14</b>	4 <sup>2</sup> / <sub>3</sub>	14
<b>66.205.15</b>	5	15
<b>66.205.16</b>	5 <sup>1</sup> / <sub>3</sub>	16
<b>66.205.17</b>	5 <sup>2</sup> / <sub>3</sub>	17
<b>66.205.18</b>	6	18
<b>66.205.19</b>	6 <sup>1</sup> / <sub>3</sub>	19
<b>66.205.20</b>	6 <sup>2</sup> / <sub>3</sub>	20
<b>66.205.21</b>	7	21
<b>66.205.22</b>	7 <sup>1</sup> / <sub>3</sub>	22
<b>66.205.23</b>	7 <sup>2</sup> / <sub>3</sub>	23
<b>66.205.24</b>	8	24
<b>66.205.25</b>	8 <sup>1</sup> / <sub>3</sub>	25
<b>66.205.26</b>	8 <sup>2</sup> / <sub>3</sub>	26
<b>66.205.27</b>	9	27
<b>66.205.28</b>	9 <sup>1</sup> / <sub>3</sub>	28
<b>66.205.29</b>	9 <sup>2</sup> / <sub>3</sub>	29
<b>66.205.30</b>	10	30
<b>66.205.31</b>	10 <sup>1</sup> / <sub>3</sub>	31
<b>66.205.32</b>	10 <sup>2</sup> / <sub>3</sub>	32
<b>66.205.33</b>	11	33
<b>66.205.34</b>	11 <sup>1</sup> / <sub>3</sub>	34
<b>66.205.35</b>	11 <sup>2</sup> / <sub>3</sub>	35
<b>66.205.36</b>	12	36
<b>66.205.37</b>	12 <sup>1</sup> / <sub>3</sub>	37
<b>66.205.38</b>	12 <sup>2</sup> / <sub>3</sub>	38
<b>66.205.39</b>	13	39
<b>66.205.40</b>	13 <sup>1</sup> / <sub>3</sub>	40
<b>66.205.50</b>	16 <sup>2</sup> / <sub>3</sub>	50

## Metallkatheter

Metal Catheters  
Sondes métalliques  
Sondas metálicas  
Sonde metalliche

für Männer  
for men  
pour hommes  
para hombres  
per uomini



für Frauen  
for women  
pour femmes  
para mujeres  
per donne



	mm Ø	Charrière (French)
<b>66.211.08</b>	2 <sup>2</sup> / <sub>3</sub>	8
<b>66.211.10</b>	3 <sup>1</sup> / <sub>3</sub>	10
<b>66.211.12</b>	4	12
<b>66.211.14</b>	4 <sup>2</sup> / <sub>3</sub>	14
<b>66.211.16</b>	5 <sup>1</sup> / <sub>3</sub>	16
<b>66.211.18</b>	6	18
<b>66.211.20</b>	6 <sup>2</sup> / <sub>3</sub>	20
<b>66.211.22</b>	7 <sup>1</sup> / <sub>3</sub>	22
<b>66.211.24</b>	8	24

	mm Ø	Charrière (French)
<b>66.213.08</b>	2 <sup>2</sup> / <sub>3</sub>	8
<b>66.213.10</b>	3 <sup>1</sup> / <sub>3</sub>	10
<b>66.213.12</b>	4	12
<b>66.213.14</b>	4 <sup>2</sup> / <sub>3</sub>	14
<b>66.213.16</b>	5 <sup>1</sup> / <sub>3</sub>	16
<b>66.213.18</b>	6	18
<b>66.213.20</b>	6 <sup>2</sup> / <sub>3</sub>	20
<b>66.213.22</b>	7 <sup>1</sup> / <sub>3</sub>	22
<b>66.213.24</b>	8	24



**66.212.12 - 66.212.38**

Satz komplett  
 complete set  
 jeu complet  
 juego completo  
 set completo

WALTHER  
**66.221.00**  
 34,5 cm

COXETER	mm Ø	Charrière (French)
<b>66.219.08</b>	2 <sup>2</sup> / <sub>3</sub>	8
<b>66.219.10</b>	3 <sup>1</sup> / <sub>3</sub>	10
<b>66.219.12</b>	4	12
<b>66.219.14</b>	4 <sup>2</sup> / <sub>3</sub>	14
<b>66.219.16</b>	5 <sup>1</sup> / <sub>3</sub>	16
<b>66.219.18</b>	6	18
<b>66.219.20</b>	6 <sup>2</sup> / <sub>3</sub>	20
<b>66.219.22</b>	7 <sup>1</sup> / <sub>3</sub>	22
<b>66.219.24</b>	8	24

WALTHER	mm Ø	Charrière (French)
<b>66.221.12</b>	4	12
<b>66.221.14</b>	4 <sup>2</sup> / <sub>3</sub>	14
<b>66.221.16</b>	5 <sup>1</sup> / <sub>3</sub>	16
<b>66.221.18</b>	6	18
<b>66.221.20</b>	6 <sup>2</sup> / <sub>3</sub>	20
<b>66.221.22</b>	7 <sup>1</sup> / <sub>3</sub>	22
<b>66.221.24</b>	8	24
<b>66.221.26</b>	8 <sup>2</sup> / <sub>3</sub>	26
<b>66.221.28</b>	9 <sup>1</sup> / <sub>3</sub>	28
<b>66.221.30</b>	10	30
<b>66.221.32</b>	10 <sup>2</sup> / <sub>3</sub>	32
<b>66.221.34</b>	10 <sup>1</sup> / <sub>3</sub>	34
<b>66.221.36</b>	12	36
<b>66.221.38</b>	12 <sup>2</sup> / <sub>3</sub>	38

## Harnröhrenbougies

Urethral Sounds

Bougies urétrales

Bujias uretrales

Candelette dilatatrici



DITTEL  
**66.225.00**

**66.225.08 - 66.225.30**

Satz komplett (23)  
complet set (23)  
jeu complet (23)  
juego completo (23)  
set completo (23)

DITTEL	mm Ø	Charrière (French)
<b>66.225.08</b>	2 <sup>2</sup> / <sub>3</sub>	8
<b>66.225.09</b>	3	9
<b>66.225.10</b>	3 <sup>1</sup> / <sub>3</sub>	10
<b>66.225.11</b>	3 <sup>2</sup> / <sub>3</sub>	11
<b>66.225.12</b>	4	12
<b>66.225.13</b>	4 <sup>1</sup> / <sub>3</sub>	13
<b>66.225.14</b>	4 <sup>2</sup> / <sub>3</sub>	14
<b>66.225.15</b>	5	15
<b>66.225.16</b>	5 <sup>1</sup> / <sub>3</sub>	16
<b>66.225.17</b>	5 <sup>2</sup> / <sub>3</sub>	17
<b>66.225.18</b>	6	18
<b>66.225.19</b>	6 <sup>1</sup> / <sub>3</sub>	19
<b>66.225.20</b>	6 <sup>2</sup> / <sub>3</sub>	20
<b>66.225.21</b>	7	21
<b>66.225.22</b>	7 <sup>1</sup> / <sub>3</sub>	22
<b>66.225.23</b>	7 <sup>2</sup> / <sub>3</sub>	23
<b>66.225.24</b>	8	24
<b>66.225.25</b>	8 <sup>1</sup> / <sub>3</sub>	25
<b>66.225.26</b>	8 <sup>2</sup> / <sub>3</sub>	26
<b>66.225.27</b>	9	27
<b>66.225.28</b>	9 <sup>1</sup> / <sub>3</sub>	28
<b>66.225.29</b>	9 <sup>2</sup> / <sub>3</sub>	29
<b>66.225.30</b>	10	30
<b>66.225.32</b>	10 <sup>2</sup> / <sub>3</sub>	32

DITTEL  
**66.225.98**

**66.225.08/12/16/20/24/30**

Satz komplett (6)  
complet set (6)  
jeu complet (6)  
juego completo (6)  
set completo (6)

## Harnröhrenbougies

Urethral Sounds  
Bougies urétrales  
Bujias uretrales  
Candelette dilatatrici



DITTEL  
34,5 cm

DITTEL	mm Ø	Charrière (French)
<b>66.227.08</b>	2 <sup>2</sup> / <sub>3</sub>	8
<b>66.227.09</b>	3	9
<b>66.227.10</b>	3 <sup>1</sup> / <sub>3</sub>	10
<b>66.227.11</b>	3 <sup>2</sup> / <sub>3</sub>	11
<b>66.227.12</b>	4	12
<b>66.227.13</b>	4 <sup>1</sup> / <sub>3</sub>	13
<b>66.227.14</b>	4 <sup>2</sup> / <sub>3</sub>	14
<b>66.227.15</b>	5	15
<b>66.227.16</b>	5 <sup>1</sup> / <sub>3</sub>	16
<b>66.227.17</b>	5 <sup>2</sup> / <sub>3</sub>	17
<b>66.227.18</b>	6	18
<b>66.227.19</b>	6 <sup>1</sup> / <sub>3</sub>	19
<b>66.227.20</b>	6 <sup>2</sup> / <sub>3</sub>	20
<b>66.227.21</b>	7	21
<b>66.227.22</b>	7 <sup>1</sup> / <sub>3</sub>	22
<b>66.227.23</b>	7 <sup>2</sup> / <sub>3</sub>	23
<b>66.227.24</b>	8	24
<b>66.227.25</b>	8 <sup>1</sup> / <sub>3</sub>	25
<b>66.227.26</b>	8 <sup>2</sup> / <sub>3</sub>	26
<b>66.227.27</b>	9	27
<b>66.227.28</b>	9 <sup>1</sup> / <sub>3</sub>	28
<b>66.227.29</b>	9 <sup>2</sup> / <sub>3</sub>	29
<b>66.227.30</b>	10	30







Mastdarm  
Rectum  
Rectum  
Recto  
Retto

## Mastdarm

Rectum

Rectum

Recto

Retto

Mastdarm-Spekula  
Rectal Specula  
Spéculum rectaux  
Espéculos rectales  
Specoli rettali



CZERNY  
68.105.22  
22 cm



SIMS  
68.110.15  
15 cm



BODENHAMMER  
68.115.15  
68.117.15 = Kaltlicht · Cold Light  
15 cm Lumière froide  
Luz fría · Luce fredda

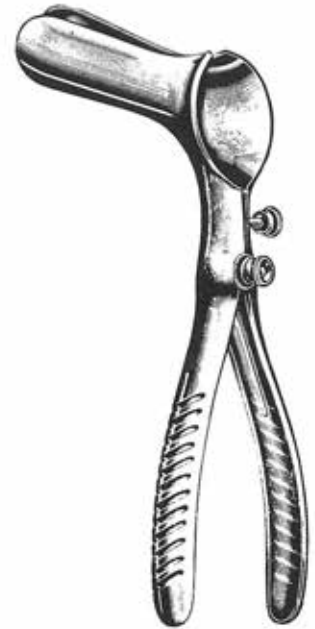

PRATT  
68.121.00



BARR  
68.125.17  
70 x 22 mm  
17 cm



MATHIEU  
68.130.19  
19,5 cm

## Mastdarm

Rectum  
Rectum  
Recto  
Retto

Mastdarm-Spreizer  
Anal Retractors  
Dilatateurs p. anus et rectum  
Separadores rectales  
Dilatatori per l'ano e il retto

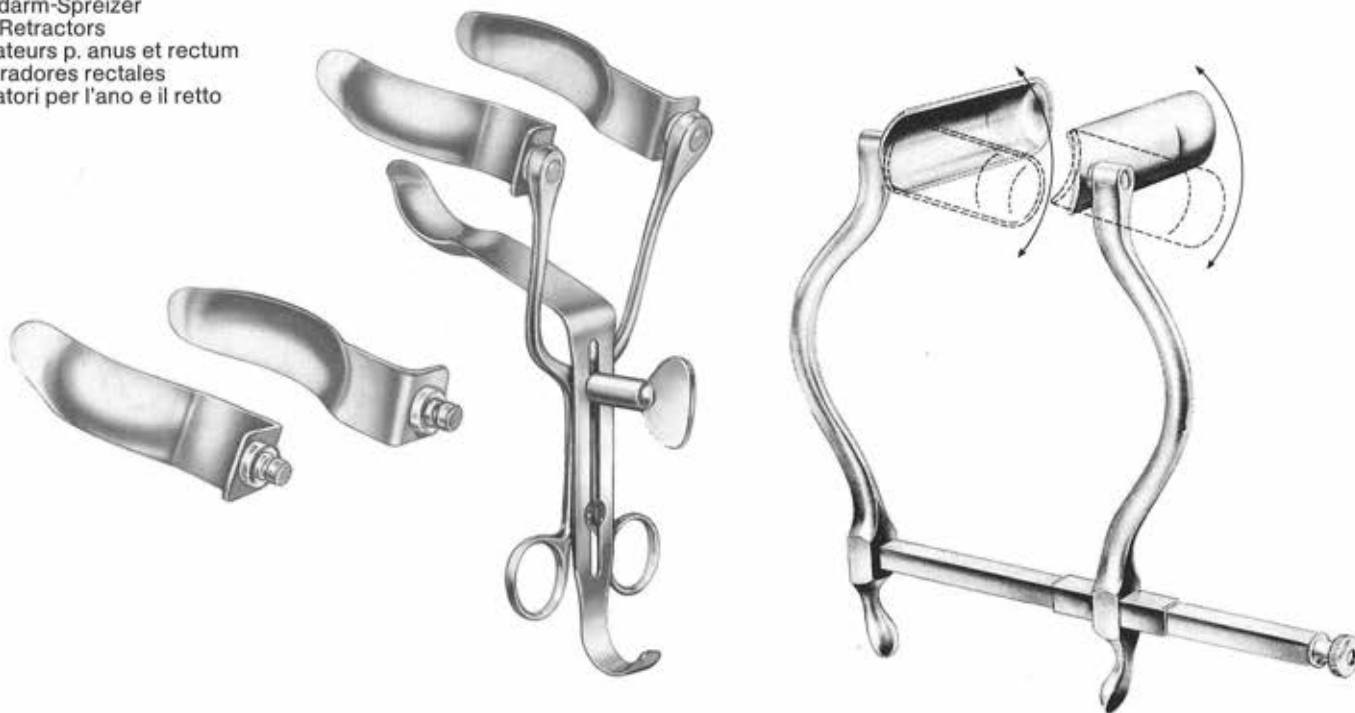

ALAN-PARKS  
68.147.00  
compl.  
13,5 cm

SMITH-BUIE  
68.150.15  
75 x 23 mm  
15 cm

68.148.00  
Kaltlicht-Adapter für 68.147.00  
Cold Light Attachment for 68.147.00  
Adaptateur lumière froide pour 68.147.00  
Adaptador luz fría para 68.147.00  
Adattatore luce fredda per 68.147.00

Rektoskop  
Rectoscope  
Rectoscope  
Rectoscopio  
Rettoscopio

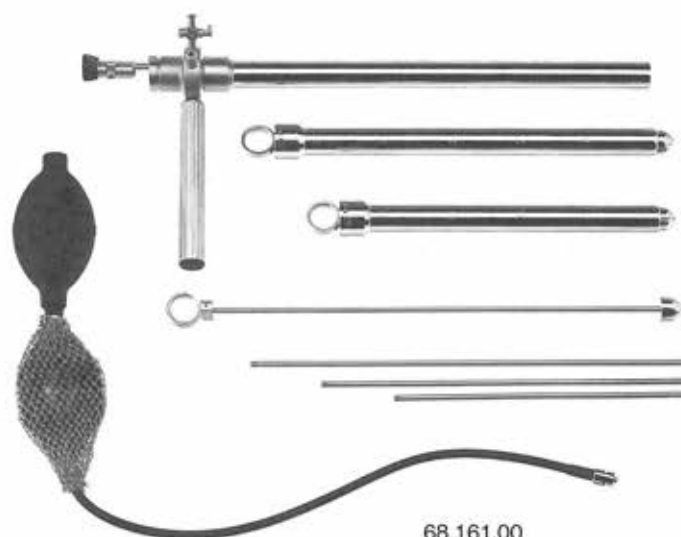

68.161.00  
compl.

Kaltlicht · Cold Light · Lumière froide  
Luz fría · Luce fredda

## Mastdarm

Rectum  
Rectum  
Recto  
Retto

Anoskope, Proktoskope  
Anoscopes, Proctoscopes  
Anusscopes, Proctoscopes  
Anoscopios, Proctoscopios  
Anoscopi, Protoscopi



IVES-FANSLER  
68.210.22  
22 mm Ø  
L = 80 mm



Ø mm	HIRSCHMANN
16	68.212.16
19	68.212.19
22	68.212.22
L = 65 mm	

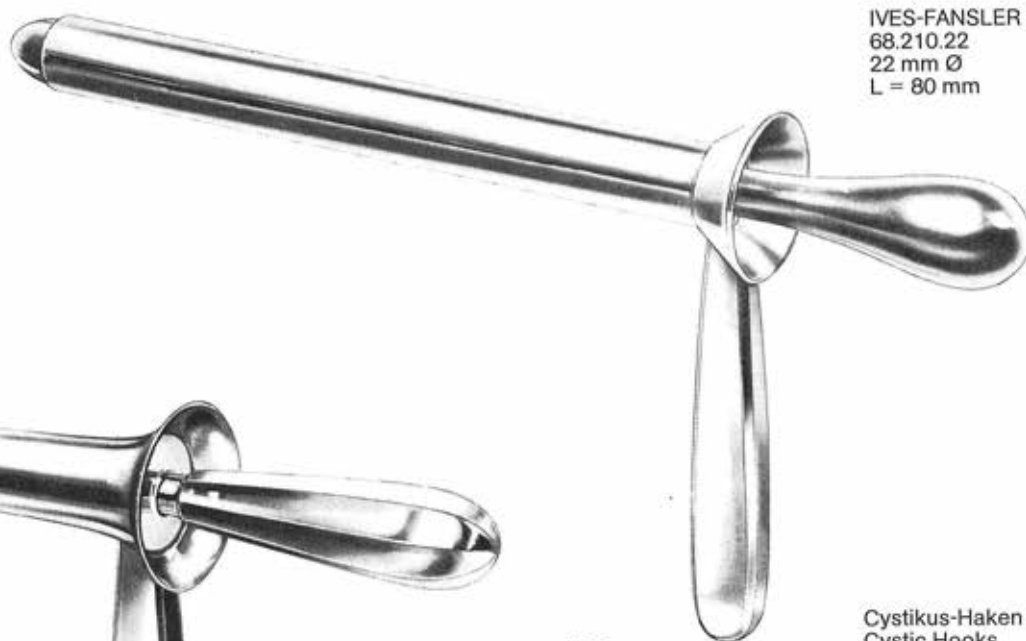

mm Ø x L	KELLY
22 x 50	68.220.05
22 x 100	68.220.10
22 x 140	68.220.14
22 x 200	68.220.20



Ø mm	KELLY
21	68.224.21
27	68.224.27
L = 50 mm	

Cystikus-Haken  
Cystic Hooks  
Ecarteurs rectaux  
Ganchos rectales  
Uncini rettali



68.251.01  
Fig. 1

68.251.02  
Fig. 2

68.251.03  
Fig. 3

PRATT  
68.251.01-68.251.03

**Mastdarm**

Rectum  
Rectum  
Recto  
Retto



**BUIE**  
68.261.41  
41 cm

Biopsie-Zangen  
Biopsy Specimen Forceps  
Pinces emporte-pièce à biopsie  
Pinzas sacabocado para biopsia  
Pinze per biopsia

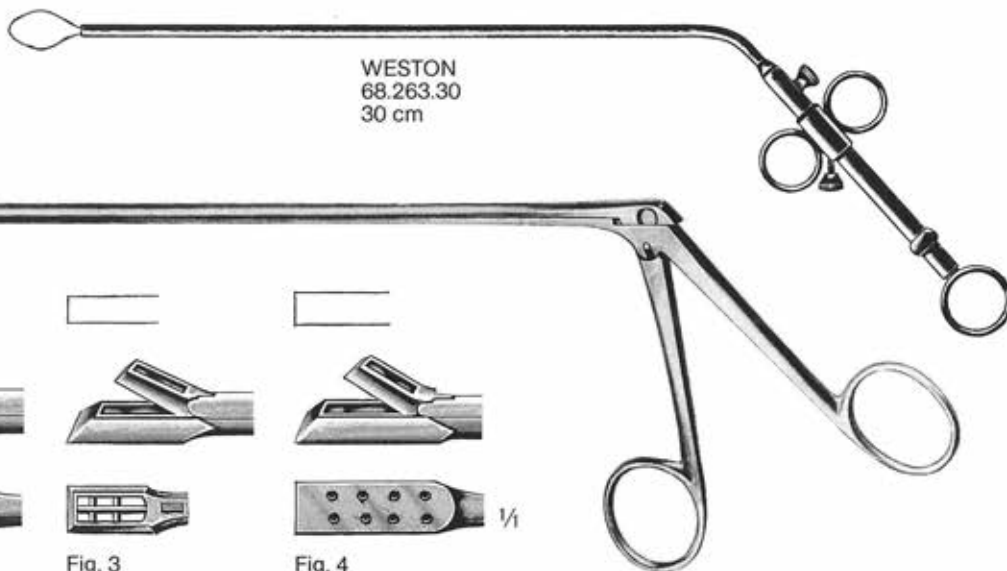

**WESTON**  
68.263.30  
30 cm

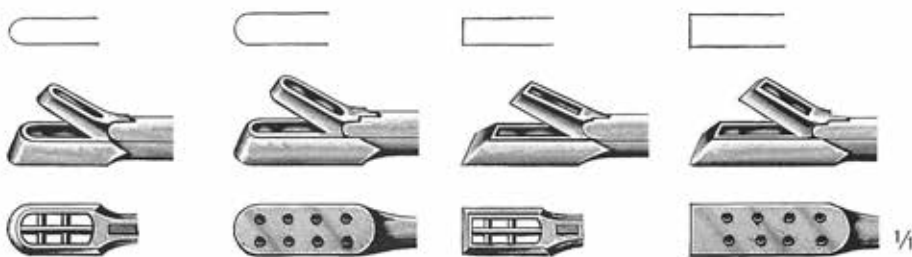

Fig. 1      Fig. 2      Fig. 3      Fig. 4

				cm	YEOMAN
68.301.28	68.302.28	68.303.28	68.304.28	28	
68.301.35	68.302.35	68.303.35	68.304.35	35	
68.301.42	68.302.42	68.303.42	68.304.42	42	



drehbar  
rotatable  
rotative  
giratoria  
girevole

cm	YEOMAN
23	68.311.23
33	68.311.33
40	68.311.40



drehbar  
rotatable  
rotative  
giratoria  
girevole

cm	TURREL
23	68.321.23
33	68.321.33
40	68.321.40

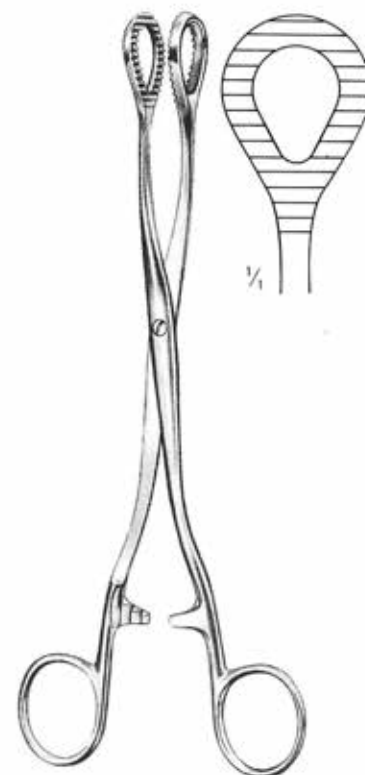

**HEYWOOD-SMITH**  
68.402.21  
21 cm





Gynäkologie  
Gynecology  
Gynécologie  
Ginecologia  
Ginecologia



**Vaginalspekula**  
 Vaginal Specula  
 Speculums vaginaux  
 Espécules vaginales  
 Specoli vaginali



Fig.	mm	GRAVE	
		Standard	Laser Mod.
1	75 x 20	<b>70.110.01</b>	<b>70.114.01</b>
2	95 x 35	<b>70.110.02</b>	<b>70.114.02</b>
3	115 x 35	<b>70.110.03</b>	<b>70.114.03</b>



mit Absaugung  
 with suction  
 avec aspiration  
 con aspiradoras  
 con aspirazione

Fig.	mm	GRAVE
		Standard
2	95 x 35	<b>70.111.02</b>



extra klein  
 extra small  
 extra petit  
 extra pequeno  
 extra piccolo

GRAVE  
**70.112.01**  
 76 x 12 mm



extra groß  
 extra large  
 extra grande  
 extra grande  
 extra grande

GRAVE  
**70.112.02**  
 120 x 38 mm



PEDERSON

Fig.	mm	
1	75 x 13	<b>70.120.01</b>
2	100 x 22	<b>70.120.02</b>
3	120 x 25	<b>70.120.03</b>



PEDERSON  
**70.122.10**  
100 x 16 mm

**Vaginalspekula**  
 Vaginal Specula  
 Speculums vaginaux  
 Espécules vaginales  
 Specoli vaginali

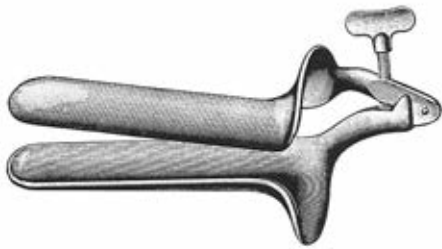

COLLIN			
Fig.	mm		
1	85 x 30	<b>70.130.01</b>	
2	100 x 35	<b>70.130.02</b>	
3	110 x 40	<b>70.130.03</b>	

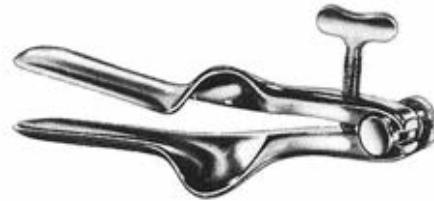

COLLIN  
**70.131.00**  
 65 x 20 mm



COLLIN  
**70.132.00**  
 65 x 10 mm



Seitl. Schraube  
 Lateral Screw  
 Vis latérale  
 Tornillo lateral  
 Vite laterale

		CUSCO	
Fig.	mm	Standard	Laser Mod.
0	80 x 24	<b>70.140.00</b>	
1	75 x 32	<b>70.140.01</b>	
2	85 x 35	<b>70.140.02</b>	<b>70.144.02</b>
3	100 x 35	<b>70.140.03</b>	<b>70.144.03</b>

**Vaginalspekula**  
Vaginal Specula  
Speculums vaginaux  
Espécules vaginales  
Specoli vaginali

**dimed**<sup>®</sup>  
SURGICAL INSTRUMENTS

Gynäkologie / Gynecology / Gynécologie / Ginecologia / Ginecologia



CUSCO  
**70.142.00**  
70 x 05 mm



Mittelschraube  
Central Screw  
Vis centrale  
Tornillo central  
Vite centrale

CUSCO	mm
<b>70.150.00</b>	80 x 24
<b>70.150.01</b>	75 x 32
<b>70.150.02</b>	85 x 36
<b>70.150.03</b>	95 x 37
<b>70.150.04</b>	110 x 37
<b>70.151.00</b>	75 x 17

## Vaginalspekula

Vaginal Specula  
Speculums vaginaux  
Espécules vaginales  
Specoli vaginali

flache Entenschnabelform  
flat duck beak



CUSCO	mm
<b>70.152.01</b>	80 x 32
<b>70.152.02</b>	90 x 37
<b>70.152.03</b>	115 x 37

Schweizer Modell  
Swiss Pattern  
Modèle suisse  
Modelo suizo  
Modello svizzero



Fig.	mm	CUSCO
1	90 x 23-25	<b>70.160.01</b>
2	100 x 25-27	<b>70.160.02</b>
3	110 x 27-30	<b>70.160.03</b>



FREEWAY GRAVE  
**70.162.01**  
100 x 32 mm



FREEWAY GRAVE  
**70.162.02**

**Vaginalspekula**  
Vaginal Specula  
Speculums vaginaux  
Espéculos vaginales  
Specoli vaginali

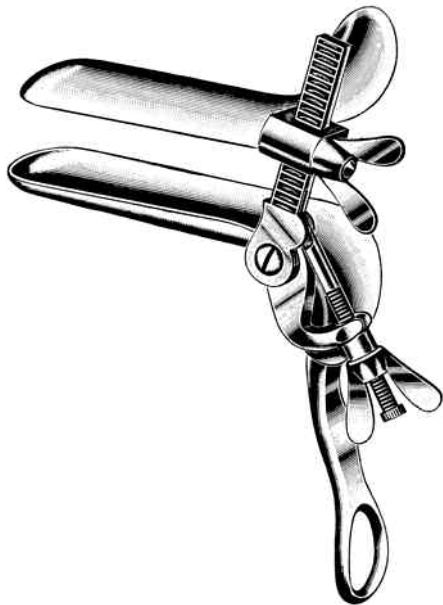

mm	TRELAT
85 x 33	<b>70.180.01</b>
95 x 35	<b>70.180.02</b>
115 x 43	<b>70.180.03</b>



mm	SEMM
90 x 14-18	<b>70.190.00</b>
100 x 17-20	<b>70.190.01</b>
100 x 25-30	<b>70.190.02</b>

## Vaginalspekula, Scheidenhalter

Vaginal Specula, Vaginal Retractors  
Speculums vaginaux, Velves vaginales  
Espéculos vaginales, Valvas vaginales  
Specoli vaginali, Valve vaginali



O`SULLIVAN O`CONNOR  
**70.196.00**

komplett  
complete  
complet  
completo  
completo



**70.196.01**

Fig. 1  
45 x 17 mm

**70.196.02**

Fig. 2  
90 x 37 mm

**70.196.03**

Fig. 3  
90 x 45mm



**Vaginalspekula, Scheidenhalter**

Vaginal Specula, Vaginal Retractors  
 Speculums vaginaux, Velves vaginales  
 Espécules vaginales, Valvas vaginales  
 Specoli vaginali, Valve vaginali



Satz Fig.  
 set no.  
 jeu no.  
 juego no.  
 serie no.

bestehend aus  
 consisting of  
 se composant de  
 consiste de  
 composto da

**KRISTELLER**

<b>70.210.00</b>	0	<b>70.211.00 + 70.212.00</b>
<b>70.210.01</b>	1	<b>70.211.01 + 70.212.01</b>
<b>70.210.02</b>	2	<b>70.211.02 + 70.212.02</b>
<b>70.210.03</b>	3	<b>70.211.03 + 70.212.03</b>

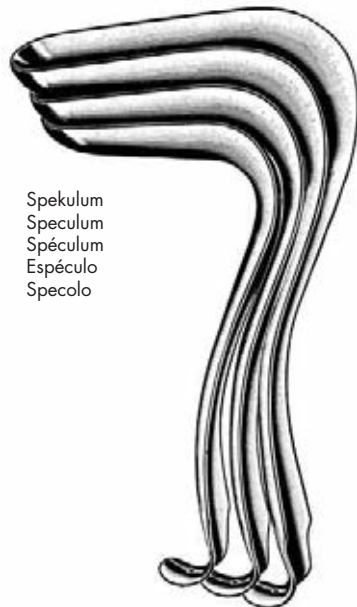

Spekulum  
 Speculum  
 Spéculum  
 Espéculo  
 Specolo



Halter  
 Retractor  
 Valve  
 Valva

Fig.	mm	KRISTELLER
0	70 x 15	<b>70.211.00</b>
1	70 x 27	<b>70.211.01</b>
2	80 x 30	<b>70.211.02</b>
3	90 x 36	<b>70.211.03</b>

Fig.	mm	KRISTELLER
0	75 x 10	<b>70.212.00</b>
1	75 x 23	<b>70.212.01</b>
2	85 x 26	<b>70.212.02</b>
3	100 x 32	<b>70.212.03</b>

## Vaginalspekula, Scheidenhalter

Vaginal Specula, Vaginal Retractors  
 Speculums vaginaux, Velves vaginales  
 Espécules vaginales, Valvas vaginales  
 Specoli vaginali, Valve vaginali

Mit konischen Blättern, für Jungfrauen  
 With taper blades, for virgins  
 A valves coniques, pour vierges  
 Con hojas cónicas, para vírgenes  
 Con valve coniche, per vergini



Satz Fig.  
 set no.  
 jeu no.  
 juego no.  
 serie no.

bestehend aus  
 consisting of  
 se compostant de  
 consiste de  
 composto da

KRISTELLER

<b>70.220.01</b>	1	<b>70.221.01 + 70.222.01</b>
<b>70.220.02</b>	2	<b>70.221.02 + 70.222.02</b>

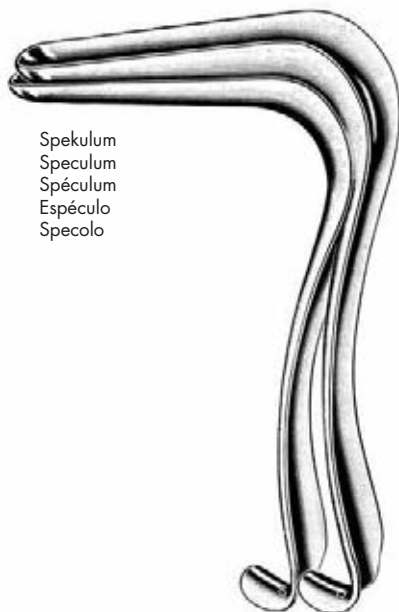

Spekulum  
 Speculum  
 Spéculum  
 Espéculo  
 Specolo

mm	KRISTELLER
105 x 18	<b>70.221.01</b>
105 x 21	<b>70.221.02</b>

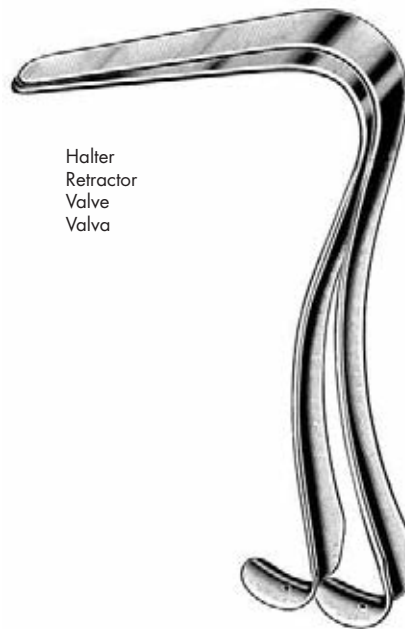

Halter  
 Retractor  
 Valve  
 Valva

mm	KRISTELLER
110 x 14	<b>70.222.01</b>
115 x 17	<b>70.222.02</b>

**Vaginalspekula, Scheidenhalter**

Vaginal Specula, Vaginal Retractors  
Speculum vaginaux, Velves vaginales  
Espéculos vaginales, Valvas vaginales  
Specoli vaginali, Valve vaginali



Satz Fig.  
set no.  
jeu no.  
juego no.  
serie no.

bestehend aus  
consisting of  
se composant de  
consiste de  
composto da

**KRISTELLER**

<b>70.230.01</b>	1	<b>70.231.01 + 70.232.01</b>
<b>70.230.02</b>	2	<b>70.231.02 + 70.232.02</b>
<b>70.230.03</b>	3	<b>70.231.03 + 70.232.03</b>

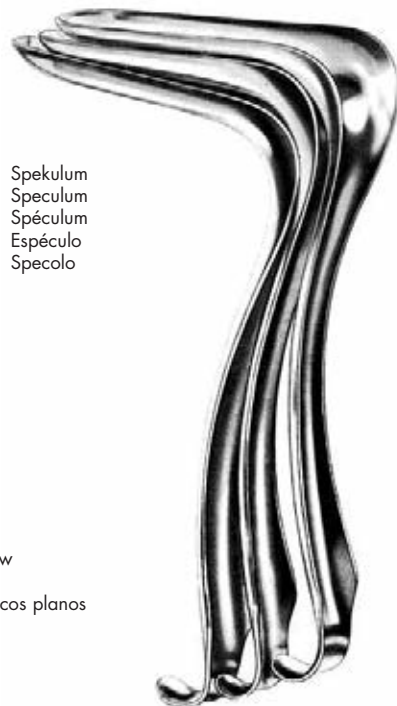

Spekulum  
Speculum  
Spéculum  
Espéculo  
Specolo

Flache Specula  
Specula Flat Hollow  
Spéculums plats  
Espéculos con huecos planos  
Specoli piatti

KRISTELLER	Fig.	mm
<b>70.231.01</b>	1	105 x 26
<b>70.231.02</b>	2	105 x 25
<b>70.231.03</b>	3	105 x 33

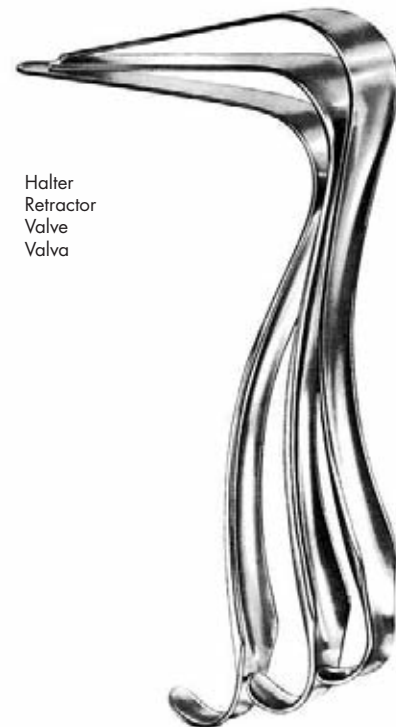

Halter  
Retractor  
Valve  
Valva

KRISTELLER	Fig.	mm
<b>70.232.01</b>	1	115 x 22
<b>70.232.02</b>	2	115 x 24
<b>70.232.03</b>	3	115 x 29

## Vaginalspekula, Scheidenhalter

Vaginal Specula, Vaginal Retractors  
 Speculums vaginaux, Velves vaginales  
 Espécules vaginales, Valvas vaginales  
 Specoli vaginali, Valve vaginali

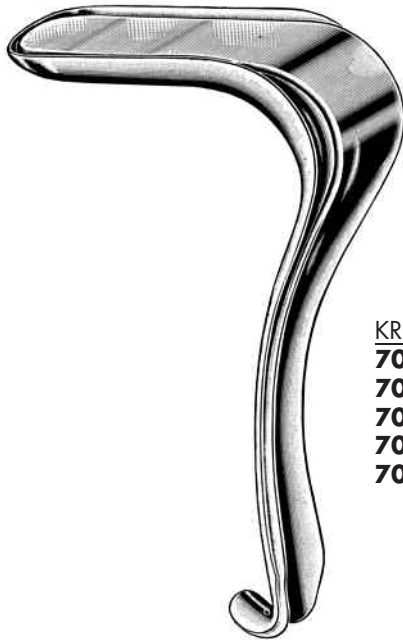

Satz Fig. bestehend aus  
 set no. consisting of  
 jeu no. se composant de  
 juego no. consiste de  
 serie no. composto da

### KRISTELLER

<b>70.239.99</b>	00	<b>70.239.97 + 70.239.98</b>
<b>70.240.00</b>	0	<b>70.241.00 + 70.242.00</b>
<b>70.240.01</b>	1	<b>70.241.01 + 70.242.01</b>
<b>70.240.02</b>	2	<b>70.241.02 + 70.242.02</b>
<b>70.240.03</b>	3	<b>70.241.03 + 70.242.03</b>

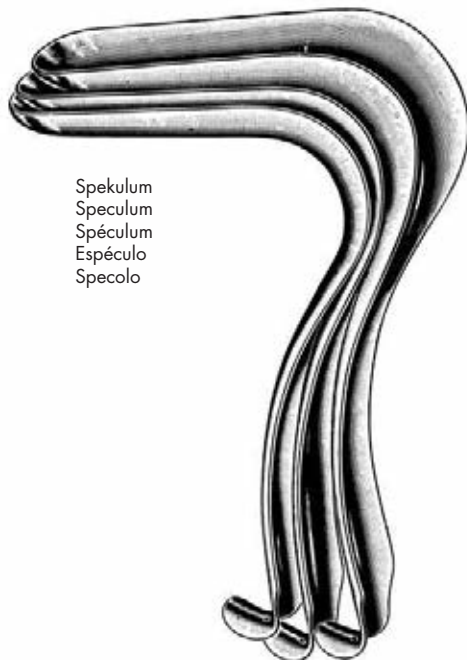

Spekulum  
 Speculum  
 Spéculum  
 Espéculo  
 Specolo

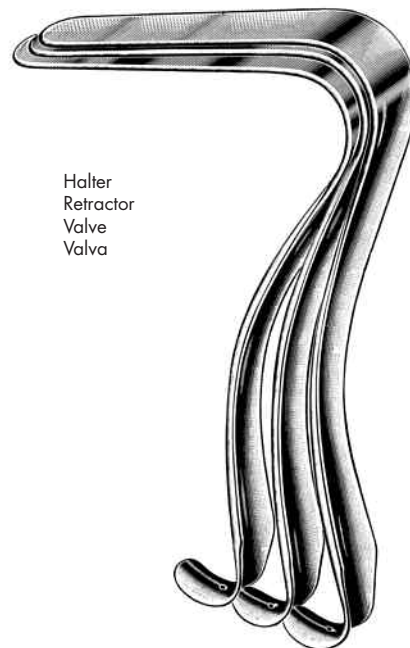

Halter  
 Retractor  
 Valve  
 Valva

Fig.	mm	KRISTELLER
00	110 x 18	<b>70.239.97</b>
0	110 x 20	<b>70.241.00</b>
1	110 x 27	<b>70.241.01</b>
2	110 x 30	<b>70.241.02</b>
3	110 x 36	<b>70.241.03</b>

Fig.	mm	KRISTELLER
00	115 x 14	<b>70.239.98</b>
0	115 x 17	<b>70.242.00</b>
1	115 x 23	<b>70.242.01</b>
2	115 x 26	<b>70.242.02</b>
3	115 x 32	<b>70.242.03</b>

## Vaginalspekula, Scheidenhalter

Vaginal Specula, Vaginal Retractors  
Speculums vaginaux, Velves vaginales  
Espéculos vaginales, Valvas vaginales  
Specoli vaginali, Valve vaginali

**dimeda**<sup>®</sup>  
SURGICAL INSTRUMENTS



Für Kinder  
For children  
Pour enfants  
Para niños  
Per bambini

Satz Fig.  
set no.  
jeu no.  
juego no.  
serie no.

bestehend aus  
consisting of  
se compostant de  
consiste de  
composto da

KRISTELLER

**70.244.00**

0

**70.245.00 + 70.246.00**



Spekulum  
Speculum  
Spéculum  
Espéculo  
Specolo



Halter  
Retractor  
Valve  
Valva

KRISTELLER

mm  
70 x 15 **70.245.00**

KRISTELLER

mm  
75 x 10 **70.246.00**

## Vaginalspekula, Scheidenhalter

Vaginal Specula, Vaginal Retractors  
Speculums vaginaux, Velves vaginales  
Espéculos vaginales, Valvas vaginales  
Specoli vaginali, Valve vaginali



Satz Fig.  
set no.  
jeu no.  
juego no.  
serie no.

bestehend aus  
consisting of  
se composant de  
consiste de  
composto da

KRISTELLER

**70.250.00**

0

**70.251.00 + 70.252.00**



Spekulum  
Speculum  
Spéculum  
Espéculo  
Specolo

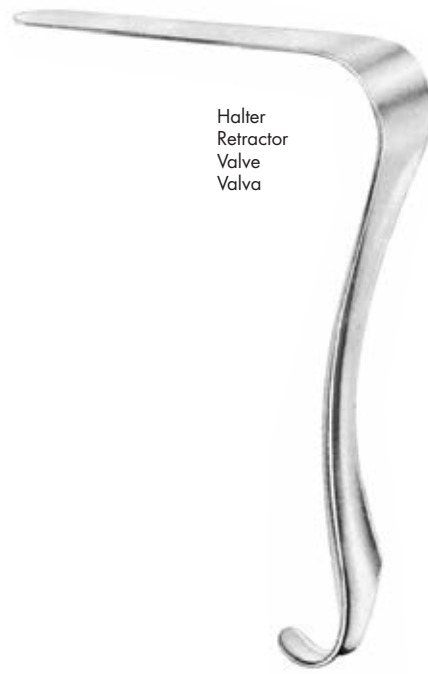

Halter  
Retractor  
Valve  
Valva

mm KRISTELLER  
135 x 36 **70.251.00**

mm KRISTELLER  
140 x 30 **70.252.00**

## Vaginalspekula, Scheidenhalter

Vaginal Specula, Vaginal Retractors  
Speculums vaginaux, Velves vaginales  
Espéculos vaginales, Valvas vaginales  
Specoli vaginali, Valve vaginali

**dimeda**<sup>®</sup>  
SURGICAL INSTRUMENTS



Satz Fig.  
set no.  
jeu no.  
juego no.  
serie no.

bestehend aus  
consisting of  
se compostant de  
consiste de  
composto da

### KALLMORGEN

<b>70.260.01</b>	1	<b>70.261.01</b>	<b>70.262.01</b>
<b>70.260.02</b>	2	<b>70.261.02</b>	<b>70.262.02</b>

Spekulum  
Speculum  
Spéculum  
Espéculo  
Specolo



Halter  
Retractor  
Valve  
Valva



mm	KALLMORGEN
70 x 40	<b>70.261.01</b>
90 x 40	<b>70.261.02</b>

mm	KALLMORGEN
70 x 33	<b>70.262.01</b>
90 x 33	<b>70.262.02</b>



**Präparierscheren**  
 Dissecting Scissors  
 Ciseaux à dissection  
 Tijeras de disección  
 Forbici per dissezione

56 x 13 mm



mm **BRAUN**  
 56 x 13 **70.263.01**

60 x 10 mm



mm **BRAUN**  
 60 x 10 **70.264.01**

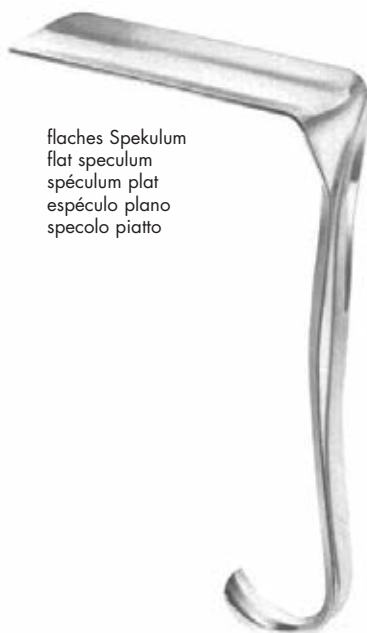

flaches Spekulum  
 flat speculum  
 spéculum plat  
 espéculo plano  
 specolo piatto

JACKSON



**70.271.01**  
 75 x 40 mm



**70.271.02**  
 90 x 40 mm



**70.271.03**  
 100 x 40 mm



SIMS

Fig. 1	Fig. 2	Fig. 3
klein	mittel	groß
small	medium	large
petit	moyen	grand
pequño	mediano	grande
piccolo	medio	

Fig.	mm	
1	70 x 25	<b>70.281.01</b>
2	85 x 30	<b>70.281.02</b>
3	100 x 40	<b>70.281.03</b>

Scheidenspekula, doppelendig  
 Vaginal specula, double-ended  
 Spéculums vaginaux, doubles  
 Espéculos vaginales, dobles  
 Speculi vaginali, doppi



**70.291.00**

bestehend aus  
 consisting of  
 consiste de  
 se composant de  
 composto da

**70.291.01 - 70.291.03**

Fig.	mm	SIMS
1	65 x 25, 70 x 30	<b>70.291.01</b>
2	70 x 30, 70 x 35	<b>70.291.02</b>
3	85 x 35, 90 x 40	<b>70.291.03</b>

## Vaginalspekula

Vaginal Specula  
Speculums vaginaux  
Espéculos vaginales  
Specoli vaginali

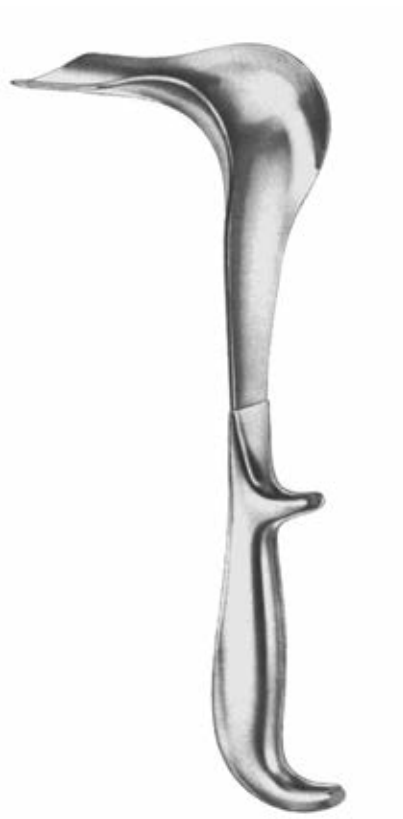

leicht hohl  
slightly concave  
légerement concave  
ligeramente cóncavo  
leggermente concavo



Fig.	mm	DOYEN
1	75x45	<b>70.300.01</b>
2	90x45	<b>70.300.02</b>
3	110x45	<b>70.300.03</b>

Fig.	mm	DOYEN
1	55x35	<b>70.301.01</b>
2	85x35	<b>70.301.02</b>
3	115x35	<b>70.301.03</b>
1	55x45	<b>70.303.01</b>
2	85x45	<b>70.303.02</b>
3	115x45	<b>70.303.03</b>
4	160x45	<b>70.303.04</b>
1	55x60	<b>70.305.01</b>
2	85x60	<b>70.305.02</b>
3	115x60	<b>70.305.03</b>
4	160x60	<b>70.305.04</b>

**Vaginalspekula**  
Vaginal Specula  
Speculums vaginaux  
Espéculos vaginales  
Specoli vaginali

**dimeda**<sup>®</sup>  
SURGICAL INSTRUMENTS



**70.307.00**  
83 x 38 mm

Loses Gewicht  
Detachable Weight  
Poids démontable  
Pessa desmontable  
Peso smontabile

**70.309.00**  
83 x 38 mm

Festes Gewicht  
Fixed Weight  
Poids fixe  
Pessa fija  
Peso fisso

AUVARD

Gynäkologie / Gynecology / Gynécologie / Ginecologia / Ginecologia

## Vaginalspekula

Vaginal Specula  
Speculums vaginaux  
Espéculos vaginales  
Specoli vaginali



70 x 30 mm



mm	BREISKY
100 x 20	<b>70.310.20</b>
100 x 25	<b>70.310.25</b>
100 x 30	<b>70.310.30</b>
100 x 35	<b>70.310.35</b>
100 x 40	<b>70.310.40</b>
130 x 20	<b>70.313.20</b>
130 x 25	<b>70.313.25</b>
130 x 30	<b>70.313.30</b>
130 x 35	<b>70.313.35</b>
130 x 40	<b>70.313.40</b>
155 x 40	<b>70.315.40</b>

DOYEN  
**70.317.24**  
25,0 cm

**SCHERBAK**  
**70.318.00**

Satz komplett mit Griff,  
 Gewicht (400 g) und 5 Blättern

complete Set with handle,  
 weight (400 g) and 5 blades

jeu complet avec manche,  
 poids (400 g) et 5 valves

juego completo con mango,  
 peso (400 g) y 5 valvas

Set completo con manico,  
 peso (400 g) e 5 valve

Blatt allein  
 Specula Blade only  
 Valve vaginale, seule  
 Valva vaginal, suelta  
 Valve vaginale, sola



SCHERBAK	
<b>70.318.01</b>	80 x 30 mm
<b>70.318.02</b>	85 x 35 mm
<b>70.318.03</b>	90 x 40 mm

SCHERBAK	
<b>70.318.04</b>	62 x 40-60 mm
<b>70.318.05</b>	81 x 45-70 mm

Gewicht zum Vaginalspekulum  
 Weight for Vaginal Speculum  
 Poids pour spéculum vaginal  
 Peso para especulo vaginal  
 Peso per specolo vaginale



SCHERBAK <b>70.318.10</b> 10,5 cm 400 g	SCHERBAK <b>70.318.12</b> 13,0 cm 800 g
--	--

Griff zum Vaginalspekulum  
 Handle for Vaginal Speculum  
 Manche pour spéculum vaginal  
 Mango para especulo vaginal  
 Manico per specolo vaginale



SCHERBAK <b>70.318.14</b> 20,0 cm
---

**Vaginalspekula**  
Vaginal Specula  
Speculums vaginaux  
Espécules vaginales  
Specoli vaginali



LANDAU

**70.319.28** 100 x 28 mm  
**70.319.38** 100 x 38 mm



**70.320.99**

Auffangsieb  
Strainer for Vaginal Speculum  
Tarmis pour spéculum vaginal  
Tamiz para especulo vaginal  
Crivello per specolo vaginale

WEISSBARTH

**70.320.24**  
80 x 42 mm

komplett, mit abnehmbarem Auffangkorb  
complete, with detachable strainer  
complet avec tamis demontable  
completo, con tamiz desmontable  
completo con crivello smontabile



**Endospekula**  
 Endocervical Specula  
 Endospéculums  
 Espécules endocervicales  
 Endospecoli



FRIEDMANN  
**70.351.10** 10,0 cm  
**70.351.15** 15,0 cm

mit skalierter Sperre und Fixierschraube  
 with graduated ratchet and fixing screw  
 avec crémaillère à échelle et vis à fixation  
 con cremallera graduada y tornillo de fijación  
 con cremagliera con scala e vite di fissaggio



KOGAN  
**70.359.24**  
 24,5 cm



Standard	KOGAN	Laser
<b>70.360.24</b>	24,0 cm	<b>70.364.24</b>

## Uterusdilatoren

Uterine Dilators  
Dilatateurs du col de l'utérus  
Dilatores uterinos  
Dilatatori uterini

### HEGAR 70.404.14

Satz mit 14 Stück (ganze Größen)  
von 4,0 - 17,0 mm ohne Etui

set of 14 pieces (full sizes)  
from 4,0 - 17,0 mm without case

jeu de 14 pièces (taille entière)  
de 4,0 - 17,0 mm sans boîte

juego de 14 piezas (tamaños enteros)  
de 4,0 - 17,0 mm sin caja

serie di 14 pezzi (grandezza intera)  
da 4,0 - 17,0 mm senza scatola



### HEGAR 70.404.26

Satz mit 26 Stück (ganze Größen)  
von 1,0 - 26,0 mm ohne Etui

set of 26 pieces (full sizes)  
from 1,0 - 26,0 mm without case

jeu de 26 pièces (taille entière)  
de 1,0 - 26,0 mm sans boîte

juego de 26 piezas (tamaños enteros)  
de 1,0 - 26,0 mm sin caja

serie di 26 pezzi (grandezza intera)  
da 1,0 - 26,0 mm senza scatola

HEGAR	mm	HEGAR	mm
70.410.01	1	70.415.01	1,5
70.410.02	2	70.415.02	2,5
70.410.03	3	70.415.03	3,5
70.410.04	4	70.415.04	4,5
70.410.05	5	70.415.05	5,5
70.410.06	6	70.415.06	6,5
70.410.07	7	70.415.07	7,5
70.410.08	8	70.415.08	8,5
70.410.09	9	70.415.09	9,5
70.410.10	10	70.415.10	10,5
70.410.11	11	70.415.11	11,5
70.410.12	12	70.415.12	12,5
70.410.13	13	70.415.13	13,5
70.410.14	14	70.415.14	14,5
70.410.15	15	70.415.15	15,5
70.410.16	16	70.415.16	16,5
70.410.17	17	70.415.17	17,5
70.410.18	18	70.415.18	18,5
70.410.19	19	70.415.19	19,5
70.410.20	20		
70.410.21	21		
70.410.22	22		
70.410.23	23		
70.410.24	24		
70.410.25	25		
70.410.26	26		
70.410.27	27		
70.410.28	28		
70.410.29	29		
70.410.30	30		

**Uterusdilatoren**  
Uterine Dilators  
Dilateurs du col de l'utérus  
Dilatores uterinos  
Dilatatori uterini

**dimeda**<sup>®</sup>  
SURGICAL INSTRUMENTS



HEGAR  
**70.405.14**  
4 - 17 mm

14 Stück/ea./pces./c./u./pezzi



in Metalletui  
in metal case  
en boîte metal  
en caja metalica  
in scatola metallica

HEGAR	mm	
<b>70.406.14</b>	4 - 17	14 Stück/ea./pces./c./u./pezzi
<b>70.406.26</b>	1 - 26	26 Stück/ea./pces./c./u./pezzi

## Uterusdilatoren

Uterine Dilators  
Dilatateurs du col de l'utérus  
Dilataores uternios  
Dilatatori uterini

### HEGAR 70.424.08

Satz mit 8 Stück von 3,0 / 4,0 - 17,0 / 18,0 mm  
ohne Etui

set of 8 pieces from 3,0 / 4,0 - 17,0 / 18,0 mm  
without case

jeu de 8 pièces de 3,0 / 4,0 - 17,0 / 18,0 mm  
sans boîte

juego de 8 piezas de 3,0 / 4,0 - 17,0 / 18,0 mm  
sin caja

serie di 8 pezzi da 3,0 / 4,0 - 17,0 / 18,0 mm  
senza scatola

### HEGAR 70.424.13

Satz mit 13 Stück von 1,0 / 2,0 - 25,0 / 26,0 mm  
ohne Etui

set of 13 pieces from 1,0 / 2,0 - 25,0 / 26,0 mm  
without case

jeu de 13 pièces de 1,0 / 2,0 - 25,0 / 26,0 mm  
sans boîte

juego de 13 piezas de 1,0 / 2,0 - 25,0 / 26,0 mm  
sin caja

serie di 13 pezzi da 1,0 / 2,0 - 25,0 / 26,0 mm  
senza scatola



HEGAR	mm
<b>70.420.01</b>	1/2
<b>70.420.03</b>	3/4
<b>70.420.05</b>	5/6
<b>70.420.07</b>	7/8
<b>70.420.09</b>	9/10
<b>70.420.11</b>	11/12
<b>70.420.13</b>	13/14
<b>70.420.15</b>	15/16
<b>70.420.17</b>	17/18
<b>70.420.19</b>	19/20
<b>70.420.21</b>	21/22
<b>70.420.23</b>	23/24
<b>70.420.25</b>	25/26

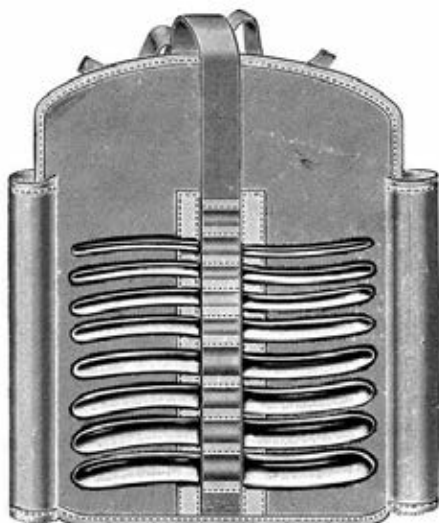

**HEGAR**  
**70.425.08**

Satz mit 8 Stück von 3,0 / 4,0 - 17,0 / 18,0 mm  
in auskochbarer Stoffrolltasche

set of 8 pieces from 3,0 / 4,0 - 17,0 / 18,0 mm  
in boilable canvas roll

jeu de 8 pièces de 3,0 / 4,0 - 17,0 / 18,0 mm  
en pochette en treillis stérilisable par ébullition

juego de 8 piezas de 3,0 / 4,0 - 17,0 / 18,0 mm  
en bolsa de tela esterilizable por ebullicion

serie di 8 pezzi da 3,0 / 4,0 - 17,0 / 18,0 mm  
in busta di tela sterilizzabile

**HEGAR**  
**70.426.08**

Satz mit 8 Stück von 3,0 / 4,0 - 17,0 / 18,0 mm  
im Metalletui mit Scharnierdeckel

set of 8 pieces from 3,0 / 4,0 - 17,0 / 18,0 mm  
in metal case with hinged lid

jeu de 8 pièces de 3,0 / 4,0 - 17,0 / 18,0 mm  
en boîte métal à charnière

juego de 8 piezas de 3,0 / 4,0 - 17,0 / 18,0 mm  
en caja metálica con tapa de bisagra

serie di 8 pezzi da 3,0 / 4,0 - 17,0 / 18,0 mm  
in scatola metallica con coperchio a cerniera



**HEGAR**  
**70.426.13**

Satz mit 13 Stück von 1,0 / 2,0 - 25,0 / 26,0 mm  
im Metalletui mit Scharnierdeckel

set of 13 pieces from 1,0 / 2,0 - 25,0 / 26,0 mm  
in metal case with hinged lid

jeu de 13 pièces de 1,0 / 2,0 - 25,0 / 26,0 mm  
en boîte métal à charnière

juego de 13 piezas de 1,0 / 2,0 - 25,0 / 26,0 mm  
en caja metálica con tapa de bisagra

serie di 13 pezzi da 1,0 / 2,0 - 25,0 / 26,0 mm  
in scatola metallica con coperchio a cerniera

## Uterusdilatoren

Uterine Dilators  
Dilateurs du col de l'utérus  
Dilatores uterinos  
Dilatatori uterini

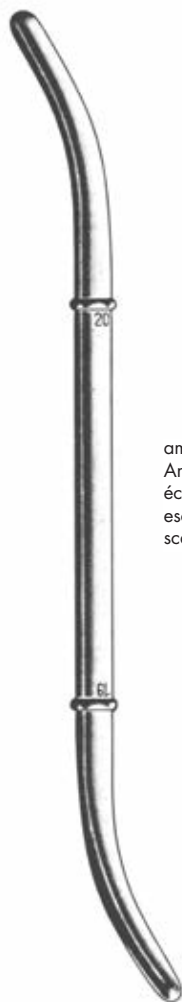

amerikanische Skala  
American scala  
échelle américaine  
escala americana  
scala americana

### HANK 70.435.06

Satz mit 6 Stück  
von 4,5 - 10,0 mm ohne Etui

set of 6 pieces  
from 4,5 - 10,0 mm without case

jeu de 6 pièces  
de 4,5 - 10,0 mm sans boîte

juego de 6 piezas  
de 4,5 - 10,0 mm sin caja

serie di 6 pezzi  
da 4,5 - 10,0 mm senza scatola

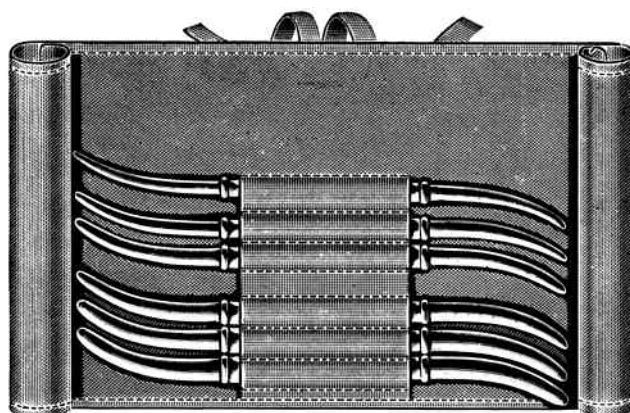

HANK	mm	Fig. US.
<b>70.430.08</b>	3,5/ 4	7/ 8
<b>70.430.10</b>	4,5/ 5	9/10
<b>70.430.12</b>	5,5/ 6	11/12
<b>70.430.14</b>	6,5/ 7	13/14
<b>70.430.16</b>	7,5/ 8	15/16
<b>70.430.18</b>	8,5/ 9	17/18
<b>70.430.20</b>	9,5/10	19/20
<b>70.430.22</b>	10,5/11	21/22
<b>70.430.24</b>	11,5/12	23/24
<b>70.430.26</b>	12,5/13	25/26
<b>70.430.28</b>	13,5/14	27/28

### HANK 70.436.08

Satz mit 6 Stück von 4,5 - 10,0 mm  
in auskochbarer Stoffrolltasche

set of 6 pieces from 4,5 - 10,0 mm  
in boilable canvas roll

jeu de 6 pièces de 4,5 - 10,0 mm  
en pochette en treillis stérilisable par ébullition

juego de 6 piezas de 4,5 - 10,0 mm  
en bolsa de tela esterilizable por ebullicion

serie di 6 pezzi da 4,5 - 10,0 mm  
in busta di tela sterilizzabile



## Uterusdilatoren

Uterine Dilators  
Dilateurs du col de l'utérus  
Dilatores uterinos  
Dilatatori uterini

**dimeda**<sup>®</sup>  
SURGICAL INSTRUMENTS



PRATT	Charr.	mm
<b>70.447.13</b>	13/15	4,5/ 5,0
<b>70.447.17</b>	17/19	5,6/ 6,3
<b>70.447.21</b>	21/23	7,0/ 7,6
<b>70.447.25</b>	25/27	8,3/ 9,0
<b>70.447.29</b>	29/31	9,6/10,3
<b>70.447.33</b>	33/35	11,0/11,6
<b>70.447.37</b>	37/39	12,3/13,0
<b>70.447.41</b>	41/43	13,6/14,3
<b>70.447.45</b>	45/47	14,9/15,6
<b>70.447.49</b>	49/51	16,3/16,9
<b>70.447.53</b>	53/55	17,6/18,3
<b>70.447.57</b>	57/59	19,9/19,6

### PRATT **70.447.08**

Satz mit 8 Stück von 4,5 / 5,0 - 13,6 / 14,3 mm  
in auskochbarer Stoffrolltasche

set of 8 pieces from 4,5 / 5,0 - 13,6 / 14,3 mm  
in boilable canvas roll

jeu de 8 pièces de 4,5 / 5,0 - 13,6 / 14,3 mm  
en pochette en treillis stérilisable par ébullition

juego de 8 piezas de 4,5 / 5,0 - 13,6 / 14,3 mm  
en bolsa de tela esterilizable por ebullición

serie di 8 pezzi da 4,5 / 5,0 - 13,6 / 14,3 mm  
in busta di tela sterilizzabile



## Uterusdilatoren

Uterine Dilators

Dilatateurs du col de l'utérus

Dilataores uterios

Dilatatori uterini



GOODELL  
**70.441.34**  
34,0 cm

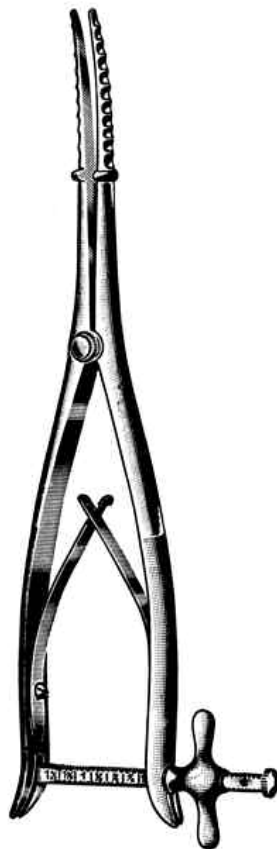

WYLIE  
**70.443.29**  
29,0 cm

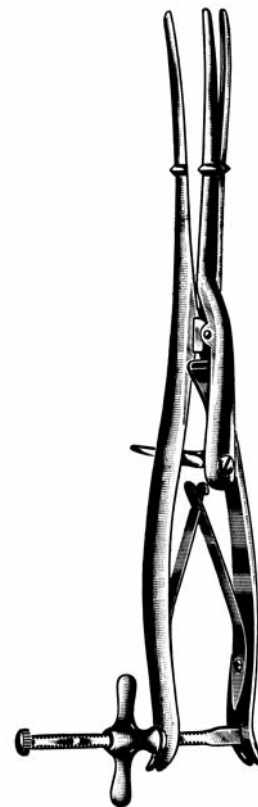

SIMS  
**70.445.29**  
29,0 cm

## Hakenzangen

Tenaculum Forceps

Pinces pour abaissement du col de l'utero

Pinzas para coger el cuello del útero

Pinze per abbassare il collo dell'utero

**dimeda**<sup>®</sup>  
SURGICAL INSTRUMENTS



SCHROEDER  
**70.502.23** 23,0 cm  
**70.502.25** 25,0 cm



BRAUN  
**70.504.25**  
25,0 cm



SKENE  
**70.505.24**  
24,0 cm



POZZI  
**70.506.25**  
25,0 cm



DUPLAY  
**70.507.28**  
28,0 cm

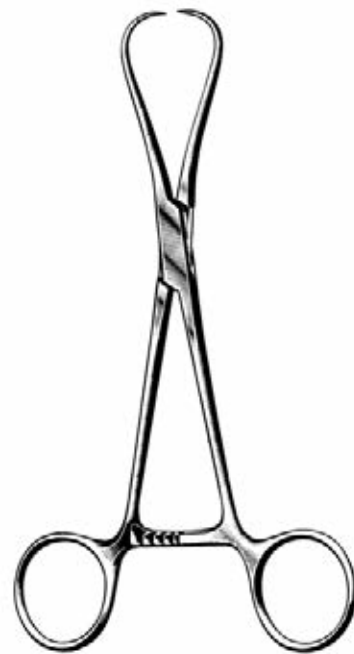

STAUDE-MOORE  
**70.508.17**  
17,0 cm

## Hakenzangen

Tenaculum Forceps

Pinces pour abaissement du col de l'utérus

Pinzas para coger el cuello del útero

Pinze per abbassare il collo dell'utero



COLLIN-POZZI  
**70.509.25**  
25,0 cm



BARRETT  
**70.510.18**  
18,0 cm



JARCHO  
**70.512.20**  
20,0 cm



SCHROEDER  
20,0 cm **70.514.20**  
24,0 cm **70.514.24**



SCHROEDER  
**70.515.24**  
24,0 cm



TIEMANN  
**70.518.22**  
22,0 cm

## Hakenzangen

Tenaculum Forceps

Pinces pour abaissement du col de l'utero

Pinzas para coger el cuello del útero

Pinze per abbassare il collo dell'utero



**2 x 2**

Zähne  
teeth  
dents  
dientes  
denti



MUSEUX  
24,0 cm



MUSEUX  
24,0 cm



**2 x 2**

Zähne  
teeth  
dents  
dientes  
denti

MUSEUX  
**70.526.20**  
20,0 cm



**3 x 4**

Zähne  
teeth  
dents  
dientes  
denti

TEALE  
18,0 cm **70.531.18**  
23,0 cm **70.531.23**  
26,5 cm **70.531.26**

## Hakenzangen

Tenaculum Forceps

Pinces pour abaissement du col de l'utérus

Pinzas para coger el cuello del útero

Pinze per abbassare il collo dell'utero

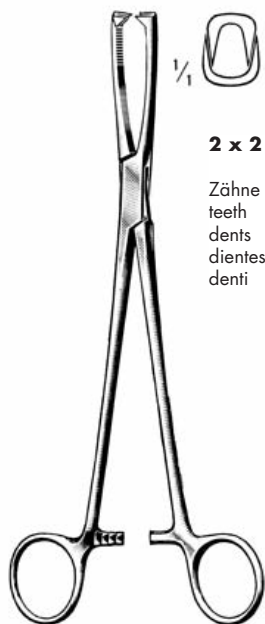

**2 x 2**

Zähne  
teeth  
dents  
dientes  
denti

JAKOBS  
**70.532.21**  
21,0 cm



**2 x 2**

Zähne  
teeth  
dents  
dientes  
denti

JAKOBS  
**70.533.21**  
21,0 cm



**2 x 3**

Zähne  
teeth  
dents  
dientes  
denti

HENROTIN  
**70.534.20**  
20,5 cm



**4 x 4**

Zähne  
teeth  
dents  
dientes  
denti

PRATT  
**70.536.28**  
28,0 cm

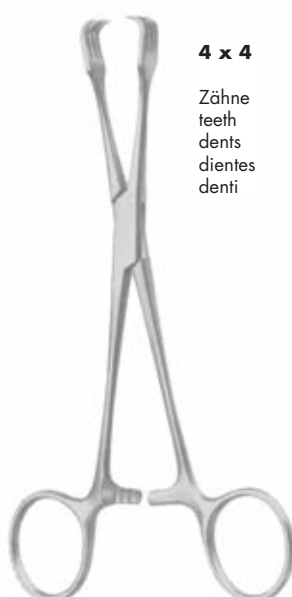

**4 x 4**

Zähne  
teeth  
dents  
dientes  
denti

CZERNY  
**70.537.21**  
21,0 cm



**4 x 4**

Zähne  
teeth  
dents  
dientes  
denti

BRAUN  
**70.538.15**  
15,5 cm

## Hakenzangen

Tenaculum Forceps

Pinces pour abaissement du col de l'utero

Pinzas para coger el cuello del útero

Pinze per abbassare il collo dell'utero

**dimeda**<sup>®</sup>  
SURGICAL INSTRUMENTS



**4 x 4**

Zähne  
teeth  
dents  
dientes  
denti

PRATT  
**70.538.26**  
26,0 cm



**5 x 6**

Zähne  
teeth  
dents  
dientes  
denti

IOWA  
**70.539.26**  
26,0 cm

## Uterus-Polypenzangen

Uterine Polypus Forceps

Pinces à polypes uterins

Pinzas per polipi uterine



NOTO  
**70.540.27**  
27,0 cm



DOYEN  
**70.542.20**  
20,0 cm

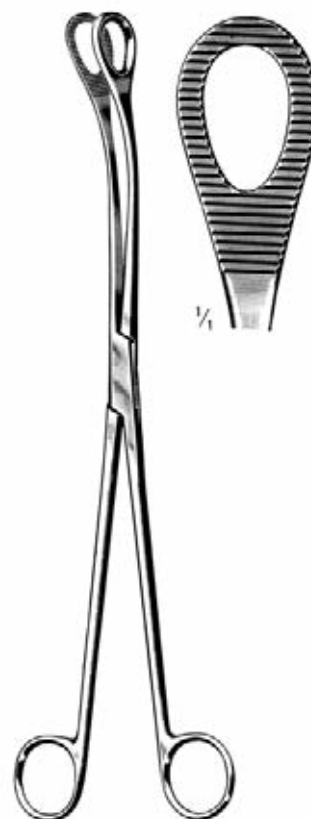

KELLY  
**70.543.32**  
32,0 cm



## Uterus-Faßzangen

Uterine Elevating Forceps  
Pinces hystérolabes  
Pinzas para el útero  
Pinzas per afferrare l'utero

**dimeda**<sup>®</sup>  
SURGICAL INSTRUMENTS



DARTIGUES  
**70.545.27**  
27,0 cm



SOMER  
**70.547.23**  
23,0 cm



COLLIN  
**70.549.25**  
25,0 cm



COLLIN  
**70.550.28**  
28,0 cm

## Uterus-Faßzangen

Uterine Elevating Forceps  
Pincas hystérolabes  
Pinzas para el útero  
Pinzas per afferrare l'utero



COLLIN  
**70.551.25**  
25,0 cm



BUMM  
**70.552.28**  
28,0 cm



SIEGLER HELLMANN  
**70.553.24**  
24,0 cm

**Uterussonden, Uterusdepressor**

Uterine Sounds, Uterine Depressor  
 Hystéromètres, Dépresseur utérin  
 Histerómetros, Depresor uterino  
 Isterometri, Depressore uterino



Amniotom  
 Amniotome  
 Amniotome  
 Amniótomo  
 Amniotomo

**BEACHMANN**  
**70.559.26**  
 26,0 cm



**BRAUN**  
**70.565.28**  
 28,0 cm

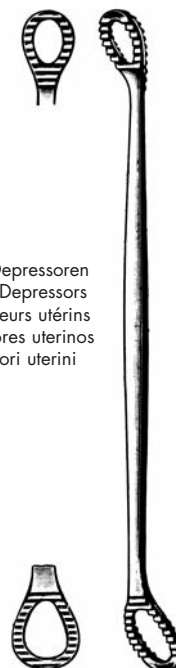

Uterus-Depressoren  
 Uterine Depressors  
 Dépresseurs utérins  
 Depresores uterinos  
 Depressori uterini

**SIMS**  
**70.567.26**  
 26,0 cm



Uterus-Sonden  
 Uterine Sounds  
 Hystéromètres  
 Histerómetros  
 Isterometri

starr  
 rigid  
 rigide  
 rigida  
 rigida

**70.580.32**    **SIMS**  
 32,0 cm

biegsam  
 malleable  
 malléable  
 malleabile  
 malleabile

**70.581.32**



starr  
 rigid  
 rigide  
 rigida  
 rigida

**70.582.32**    **MARTIN**  
 32,0 cm

biegsam  
 malleable  
 malléable  
 malleabile  
 malleabile

**70.583.32**



**COLLIN**  
**70.584.28**  
 28,0 cm



**VALLEIX**  
**70.585.25**  
 25 cm

## Uterus-Biopsie-Saugküretten

Uterine Biopsy Aspirating Curettes

Curettes aspirantes à biopsie de l'utérus

Curetas aspiradoras p. la biopsia uterina

Curette di aspirazione per biopsia

4 mm



RANDALL  
**70.590.04**  
24,0 cm

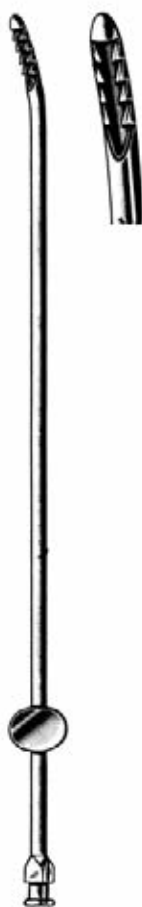

NOVAK

1 mm	<b>70.592.01</b>
2 mm	<b>70.592.02</b>
3 mm	<b>70.592.03</b>
4 mm	<b>70.592.04</b>

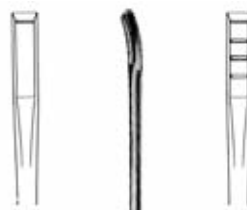

mit Korb  
with basket  
avec grille  
con cesto  
con cestino

KEVORKIAN  
30,0 cm

<b>70.594.12</b>	1,2 mm	
<b>70.594.40</b>	4,0 mm	<b>70.596.40</b>

### Probeexcisionszangen

Biopsy Specimen Forceps

Pinces amporte-pièce pour le col de l'utérus

Pinzas sacabocado para el cuello del útero

Pinze taglianti per biopsia

**dimeda**<sup>®</sup>  
SURGICAL INSTRUMENTS



FAURE  
**70.601.21**  
21,0 cm



SCHUBERT  
21,0 cm **70.604.21**  
28,0 cm **70.604.28**

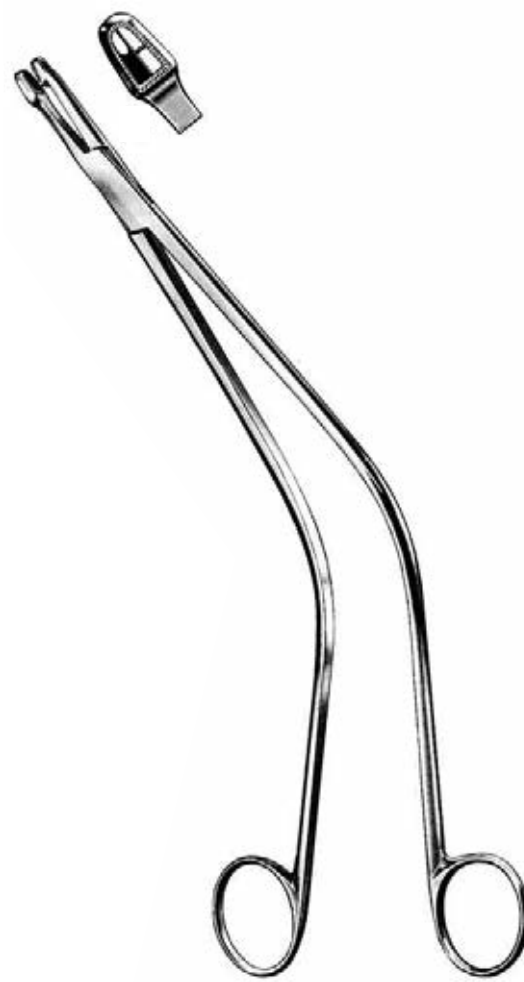

SCHUBERT  
**70.605.26**  
26,0 cm

## Biopsiezangen

Biopsy Specimen Forceps

Pinces à biopsie

Pinzas sacabocado p. biopsia

Pinze per biopsia



THOMS-GAYLOR  
**70.606.21** 23,5 cm  
**70.606.24** 21,0 cm



GELLHORN  
**70.609.23**  
23 cm

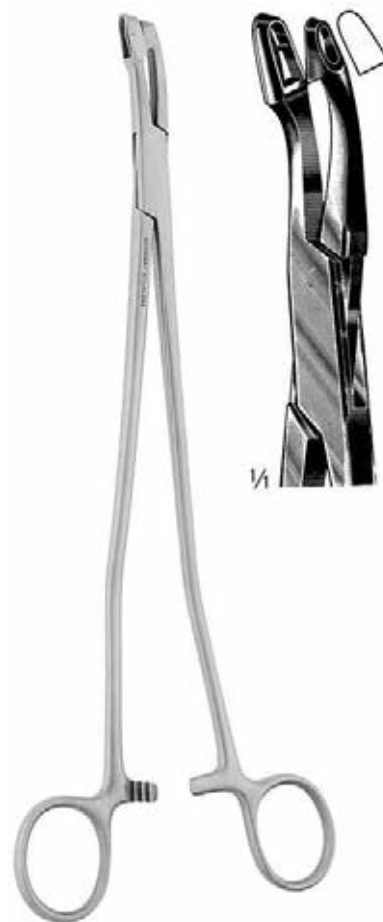

van DOREN  
**70.611.25**  
25 cm

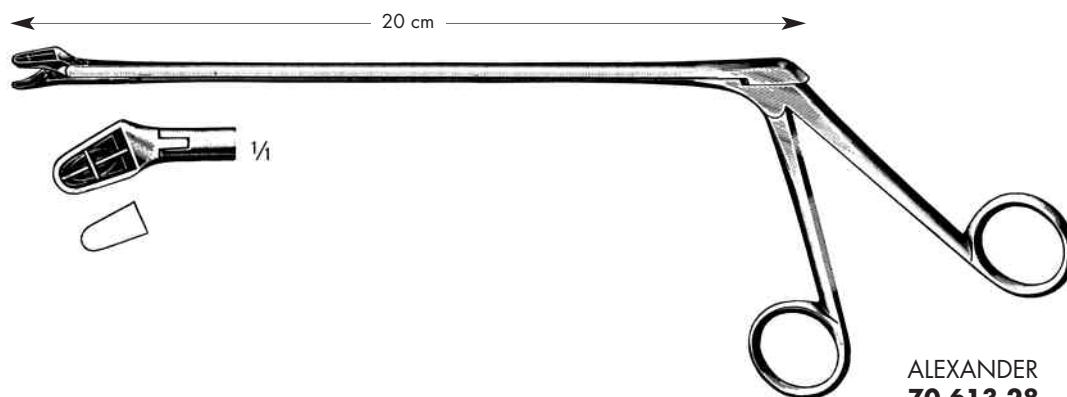

ALEXANDER  
**70.613.28**  
28 cm

## Biopsiezangen

Biopsy Specimen Forceps

Pinces à biopsie

Pinzas sacabocado p. biopsia

Pinze per biopsia

**dimeda**<sup>®</sup>  
SURGICAL INSTRUMENTS



**70.615.01**



**70.615.02**

24,0 cm

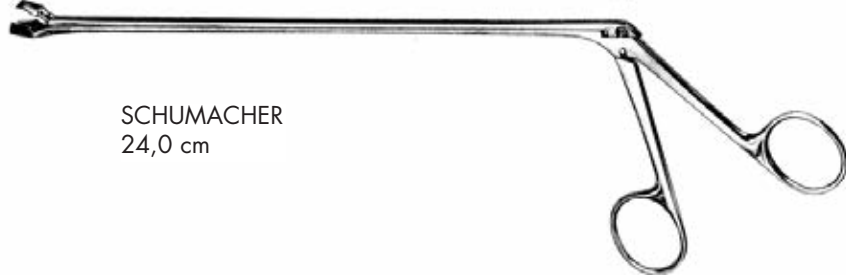

SCHUMACHER  
24,0 cm



KEVORKIAN (YOUNGE)

**70.617.04**

24,5 cm

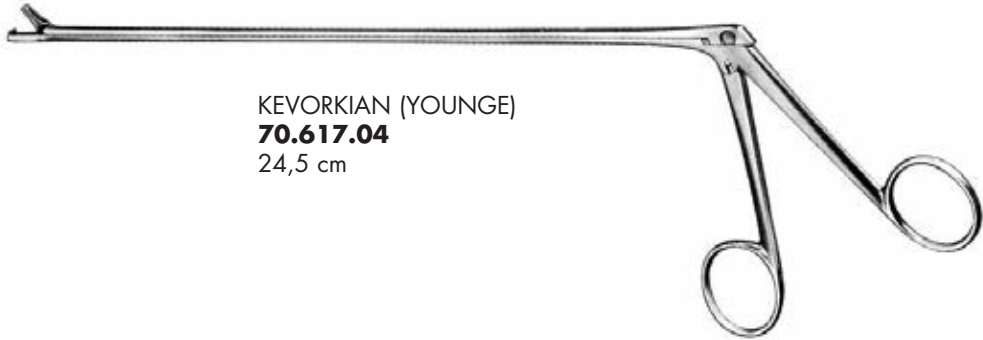

WITTNER  
**70.618.23** 23 cm **70.619.23**

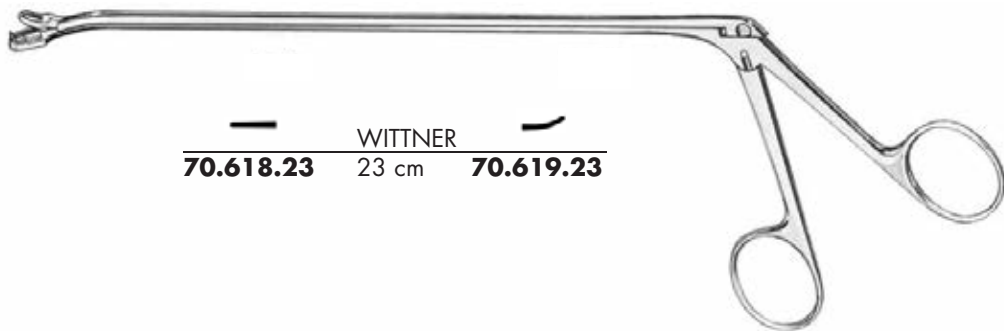

TISCHLER-MORGAN

**70.621.01**

20,0 cm





## Biopsiezangen

Biopsy Specimen Forceps

Pinces à biopsie

Pinzas sacabocado p. biopsia

Pinze per biopsia



oval  
7 x 5 mm

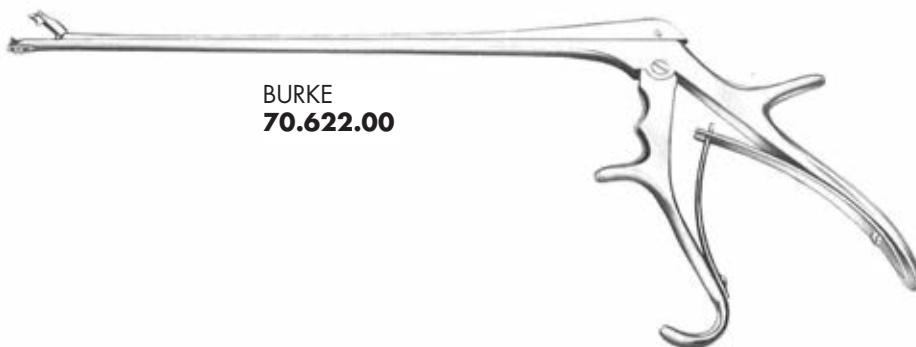

BURKE  
70.622.00



Fig. 1

TISCHLER Morgan



Fig. 3

oval ● 3,7 x 5 mm



Fig. 5

mini



Fig. 4

KEVORKAN



3 x 8 mm



Fig.	Instr. kompl. compl. instr. Instrum. compl. Strumento completo	Aufsatz allein Tip only Embout seul Punta sola
	TOWNSEND	
1	<b>70.624.01</b>	<b>70.624.11</b>
3	<b>70.624.03</b>	<b>70.624.13</b>
4	<b>70.624.04</b>	<b>70.624.14</b>
5	<b>70.624.05</b>	<b>70.624.15</b>

**70.624.99**

Griff allein  
handle only  
manche seul  
manico solo  
mango suelto



KEVORKIAN-Pacific  
70.625.04

## Biopsiezangen

Biopsy Specimen Forceps

Pinces à biopsie

Pinzas sacabocado p. biopsia

Pinze per biopsia

**dimeda**<sup>®</sup>  
SURGICAL INSTRUMENTS



■ 2,3 x 4,2 mm

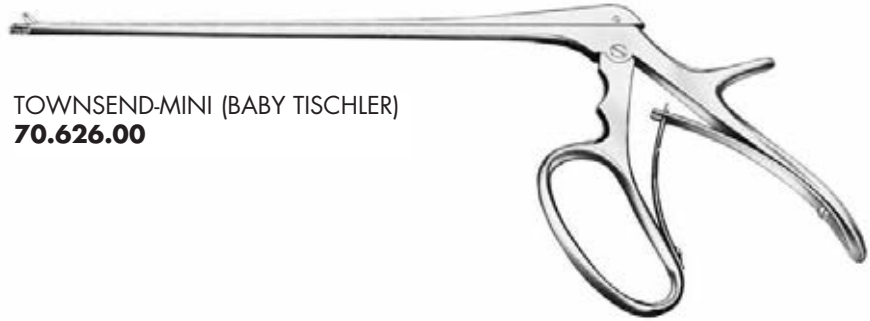

TOWNSEND-MINI (BABY TISCHLER)  
**70.626.00**



■ 3,0 x 9,5 mm

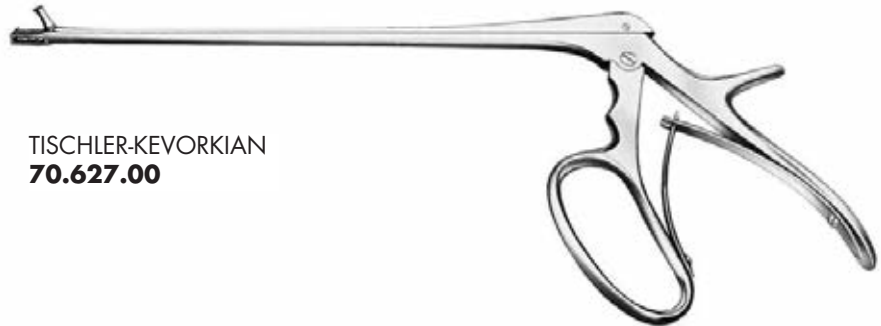

TISCHLER-KEVORKIAN  
**70.627.00**



● 4,0 x 6,5 mm

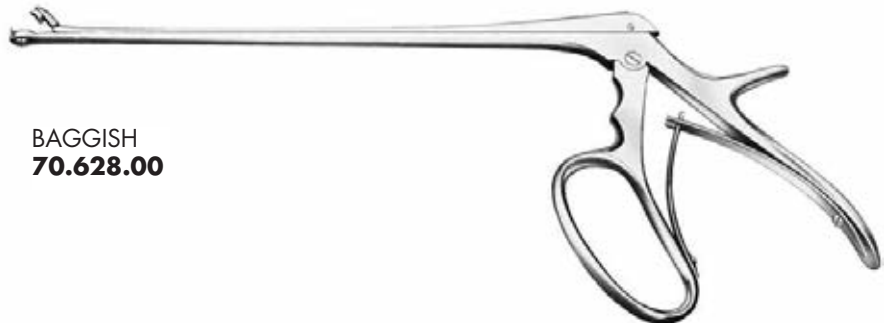

BAGGISH  
**70.628.00**



■ 4,5 x 8 mm

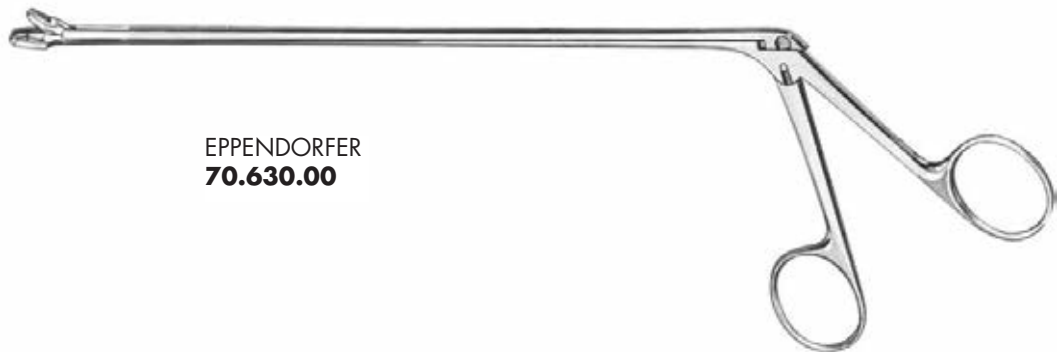

EPPENDORFER  
**70.630.00**

## Biopsiezangen

Biopsy Specimen Forceps  
Pinces à biopsie  
Pinzas sacabocado p. biopsia  
Pinze per biopsia

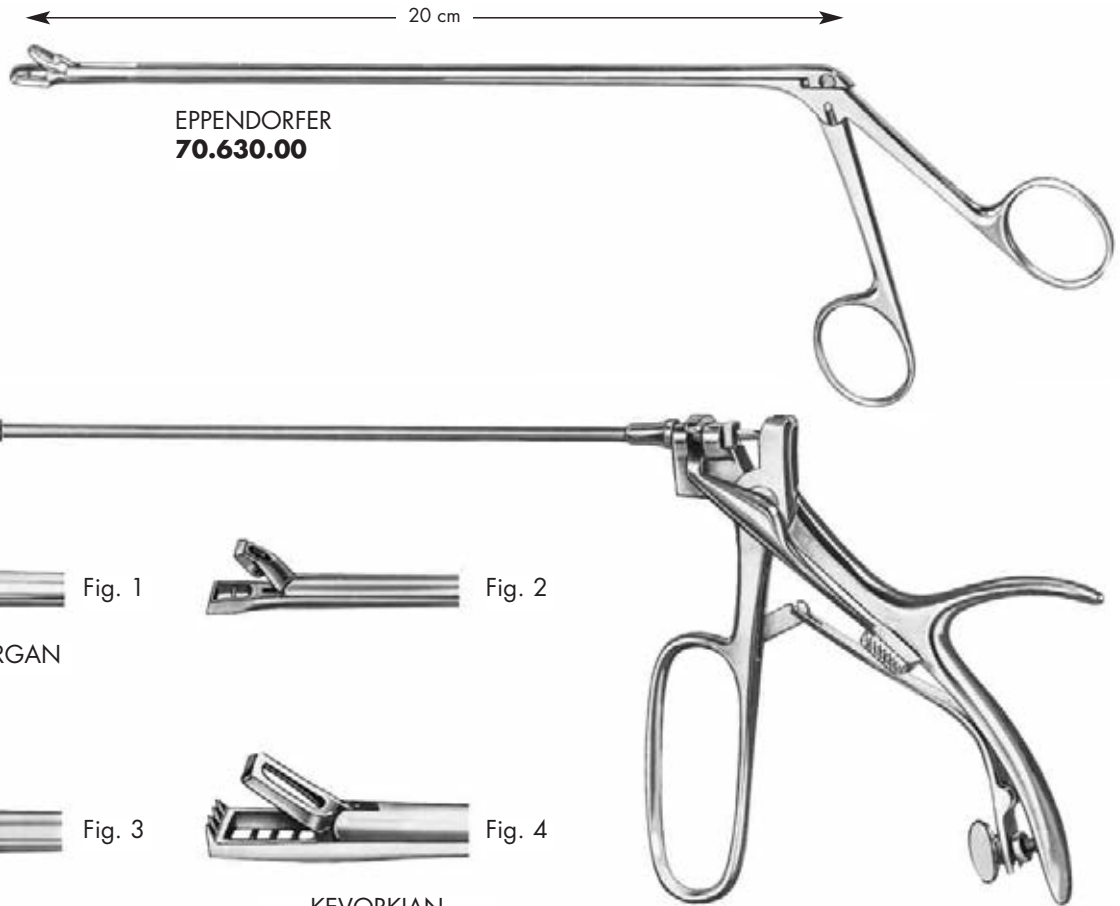

EPPENDORFER  
**70.630.00**

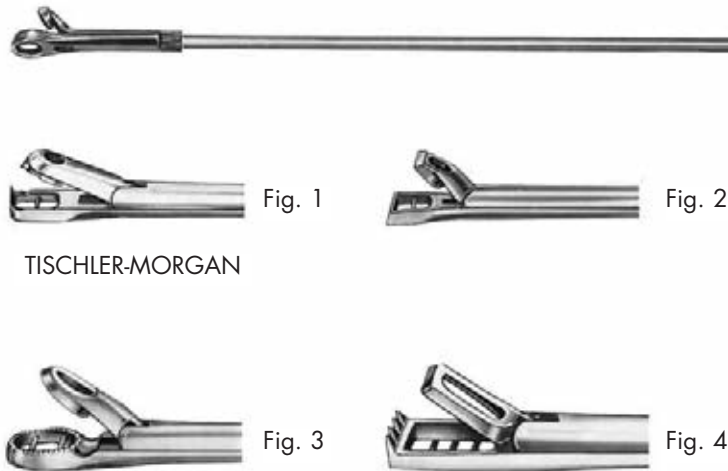

TISCHLER-MORGAN

KEVORKIAN

Fig.	Instr. kompl. compl. instr. Instrum. compl. Strumento completo	Aufsatz allein Tip only Embout seul Punta sola
1	<b>70.632.01</b>	<b>70.632.11</b>
2	<b>70.632.02</b>	<b>70.632.12</b>
3	<b>70.632.03</b>	<b>70.632.13</b>
4	<b>70.632.04</b>	<b>70.632.14</b>

Myomesser  
Myoma knives  
Evidens pour fibromes  
Cuchillo para fibromas  
Bisturi per fibromi

Myom-Heber  
Myoma Screw  
Tracteur pour fibromes  
Tirabuzón para fibromas  
Tiramiomi

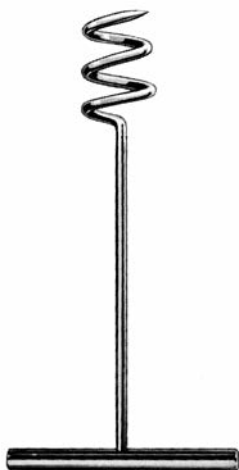

DOYEN  
**70.641.17**  
15,0 cm



SEGOND  
**70.643.27**  
27,0 cm



EMMET  
22,0 cm

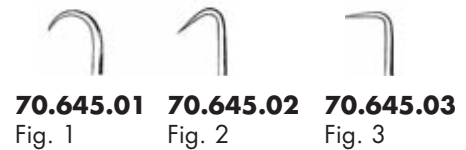

**70.645.01** **70.645.02** **70.645.03**  
Fig. 1 Fig. 2 Fig. 3



**70.645.04** **70.645.05**  
Fig. 4 Fig. 5

Fistelhaken  
Fistula Hooks  
Crochets pour fistules  
Ganchos para fistulas  
Unicini per fistole

## Salpingograph

Salpingograph  
Salpingographe  
Salpingógrafo  
Salpingografe

**dimeda**<sup>®</sup>  
SURGICAL INSTRUMENTS

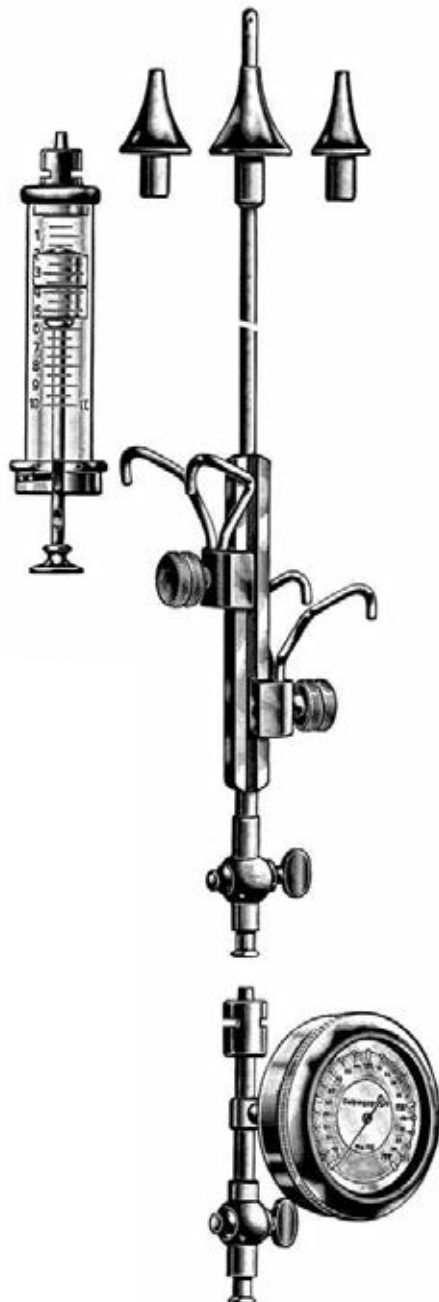

**SCHULTZE**  
**70.650.00**  
compl.

im Holzetui  
in wooden case  
en boîte de bois  
en estuche de madera  
in scatola di legno

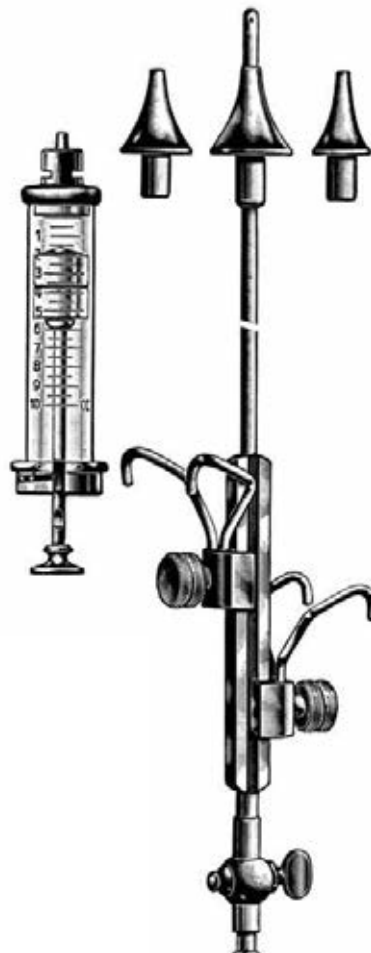

**SCHULTZE**  
**70.650.01**

ohne Manometer  
without manometer  
sans manomètre  
sin manómetro  
senza manometro



**70.650.12**   **70.650.13**   **70.650.11**



**SCHULTZE**  
**70.650.10**

Manometer zum Salpingograph  
Manometer for Salpingograph  
Manomètre pour salpingographe  
Manómetro para salpingógrafo  
Manometro per salpingografo

## Uteruslöffel, -kürette

Uterine Currettes  
Curettas utérines  
Curetas uterinas  
Curetta uterine

scharf  
sharp  
tranchant  
cortante  
tagliente



SIMON  
25,0 cm

Fig. 1	<b>70.702.01</b>
Fig. 2	<b>70.702.02</b>
Fig. 3	<b>70.702.03</b>
Fig. 4	<b>70.702.04</b>
Fig. 5	<b>70.702.05</b>
Fig. 6	<b>70.702.06</b>



SCHROEDER  
31 cm

Fig. 1	<b>70.703.01</b>
Fig. 2	<b>70.703.02</b>
Fig. 3	<b>70.703.03</b>
Fig. 4	<b>70.703.04</b>
Fig. 5	<b>70.703.05</b>
Fig. 6	<b>70.703.06</b>



scharf/stumpf  
sharp/blunt  
tranchant/mousse  
cortante/roma  
tagliente/smussa

BLAKE  
**70.704.27**  
27,0 cm



GOURDET  
28,0 cm

Fig. 1	<b>70.706.01</b>
Fig. 2	<b>70.706.02</b>
Fig. 3	<b>70.706.03</b>
Fig. 4	<b>70.706.04</b>
Fig. 5	<b>70.703.05</b>

**Uterus-Küretten**

Uterine Curettes  
 Curettes utérines  
 Curetas uterinas  
 Curette uterine

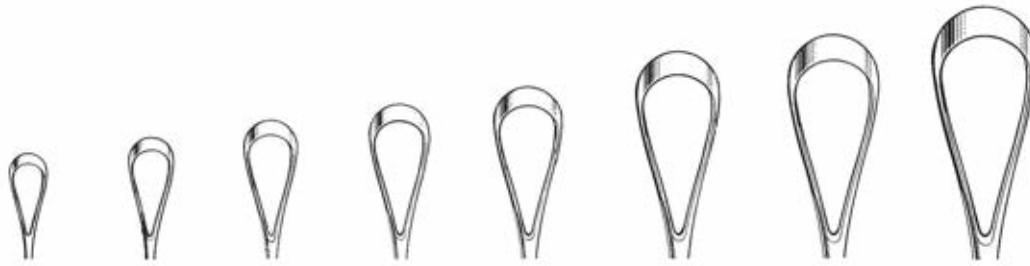

SIMS = 31 cm  
 RECAIMER = 31 cm

Fig.	00	0	1	2	3	4	5	6
mm	5	6	7	8	9	11	12	14



SIMS = 31 cm  
 RECAIMER = 31 cm

Fig.	7	8	9	10
mm	15	16	19	20

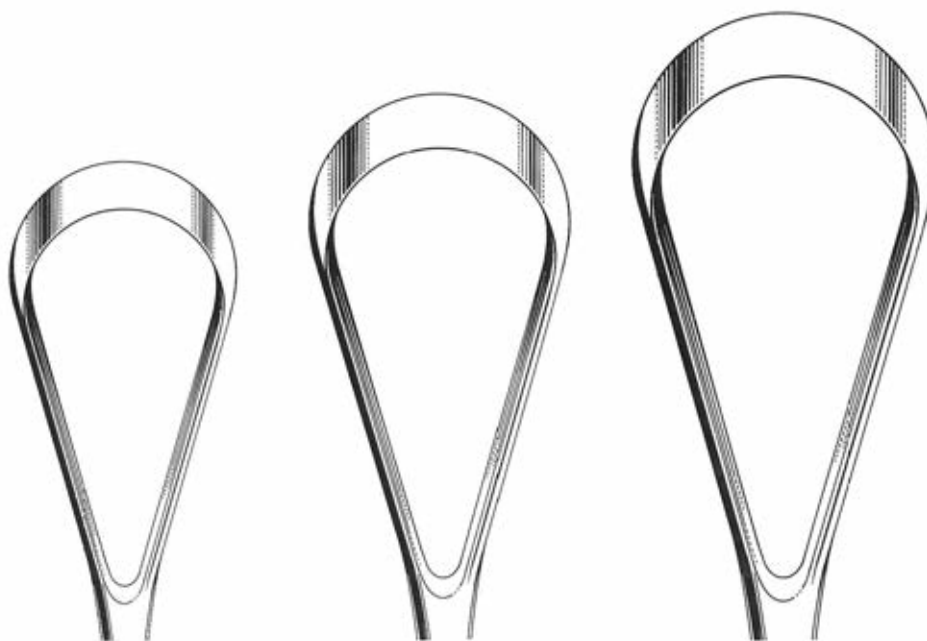

SIMS  
 RECAIMER  
 BUMM = 34 cm  
**70.710.05-**  
**70.737.40**

Fig.	14	15	16
mm	30	35	40

## Uterus-Küretten

Uterine Curettes  
Curettes utérines  
Curetas uterinas  
Curette uterine

Ausführung	scharf	stumpf
Features	sharp	blunt
Exécution	tranch.	mousse
Ejecución	cut.	roma
Esecuzione	tagl.	smussa
fest./rig.	A	B
flex./fless.	C	D



SIMS  
31,0 cm  
**70.710.05-  
70.717.14**



RECAMIER  
31,0 cm  
**70.720.07-  
70.727.25**



BUMM  
34,0 cm  
**70.730.30-  
70.737.40**

Fig.	A	B	C	D	A	B	C	D	A	B	C	D
00	70.710.05	70.712.05	70.715.05	70.717.05	70.720.05	70.722.05	70.725.05	70.727.05				
0	70.710.06	70.712.06	70.715.06	70.717.06	70.720.06	70.722.06	70.725.06	70.727.06				
1	70.710.07	70.712.07	70.715.07	70.717.07	70.720.07	70.722.07	70.725.07	70.727.07				
2	70.710.08	70.712.08	70.715.08	70.717.08	70.720.08	70.722.08	70.725.08	70.727.08				
3	70.710.09	70.712.09	70.715.09	70.717.09	70.720.09	70.722.09	70.725.09	70.727.09				
4	70.710.11	70.712.11	70.715.11	70.717.11	70.720.11	70.722.11	70.725.11	70.727.11				
5	70.710.12	70.712.12	70.715.12	70.717.12	70.720.12	70.722.12	70.725.12	70.727.12				
6	70.710.14	70.712.14	70.715.14	70.717.14	70.720.14	70.722.14	70.725.14	70.727.14				
7					70.720.15	70.722.15	70.725.15	70.727.15				
8					70.720.16	70.722.16	70.725.16	70.727.16				
9					70.720.19	70.722.19	70.725.19	70.727.19				
10					70.720.20	70.722.20	70.725.20	70.727.20				70.737.28
14									70.730.30	70.732.30	70.735.30	70.737.30
15									70.730.35	70.732.35	70.735.35	70.737.35
16									70.730.40	70.732.40	70.735.40	70.737.40



**Absaugküretten**  
 Suction & Flushing Curettes  
 Curettes d'aspiration  
 Curetas aspiradoras  
 Curette per aspirazione



**70.810.50**

Kupplungsstück  
 Coupling Piece  
 Pièce de raccordement  
 Pieza de acoplamiento  
 Pezzo di collegamento

29,0 cm

**70.810.03** Ø 3,0 mm  
**70.810.04** Ø 4,0 mm  
**70.810.06** Ø 6,0 mm  
**70.810.08** Ø 8,0 mm  
**70.810.10** Ø 10,0 mm  
**70.810.12** Ø 12,0 mm  
**70.810.14** Ø 14,0 mm

Tubenfaßpinzette  
 Tubal seizing forceps  
 Pince a saisir les trompes  
 Pinza para sostener trompas  
 Pinze per afferare trompe



NEUBÜSSER

20,0 cm

**70.850.06** Ø 6,0 mm  
**70.850.08** Ø 8,0 mm  
**70.850.10** Ø 10,0 mm





Geburtshilfe  
Obstetrics  
Obstétrique  
Obstetricia  
Ostetricia

## Geburtszangen

Obstetrical Forceps  
Forceps obstétriques  
Fórceps obstétricos  
Forcipi obstetrici

Geburtszangen für section caesares (Schnittentbindung)

Forceps for caesarean section  
Forceps pour césarienne  
Fórceps para operación cesárea  
Forcipi per tagli cesarei



WRIGLEY  
23,0 cm **72.101.23**  
28,0 cm **72.101.28**



SIMPSON  
**72.102.30**  
30,0 cm



SIMPSON  
**72.103.23**  
23,0 cm

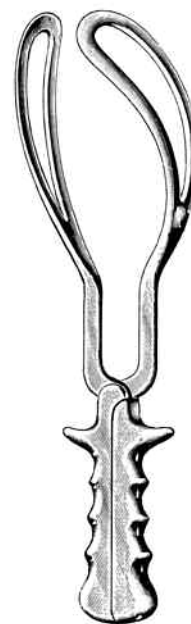

SIMPSON-BRAUN  
33,0 cm **72.105.33**  
36,0 cm **72.105.36**



De LEE  
**72.107.30**  
30,0 cm



De LEE  
36,0 cm **72.108.36**  
39,0 cm **72.108.39**



KIELLAND  
**72.110.41**  
41,0 cm



ELLIOT  
32,0 cm **72.115.32**  
38,0 cm **72.115.38**



NAEGELE  
 36,0 cm **72.119.36**  
 40,0 cm **72.119.40**



LUIKART  
**72.125.40**  
 40,0 cm



KIELLAND-LUIKART  
**72.127.40**  
 40,0 cm



SIMPSON-LUIKART  
**72.135.36**  
 36 cm



McLEAN-TUCKER-LUIKART  
**72.139.40**  
 40 cm



McLEAN-TUCKER  
**72.141.39**  
 39 cm



McLEAN-LUIKART  
**72.143.39**  
 39 cm

## Geburtszangen

Obstetrical Forceps  
Forceps obstétriques  
Fórceps obstétricos  
Forcipi obstetrici



McLEAN  
**72.145.36**  
36,0 cm



BARTON  
**72.147.36**  
36,0 cm

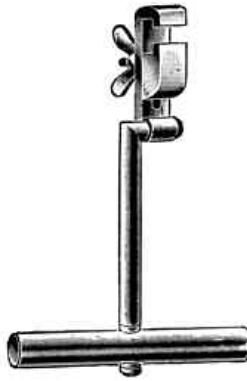

BARTON  
**72.148.17**  
17,0 cm



BOERMA  
**72.151.29**  
29,0 cm



PIPER  
**72.155.44**  
44,0 cm

für nachkommenden Kopf bei Steisslagen  
for delivery of the after coming head in breech presentation  
Spatules pour dégager la tête  
Especialmente para partos en presentación de nalgas  
Speciale in parti con predentazione di podice

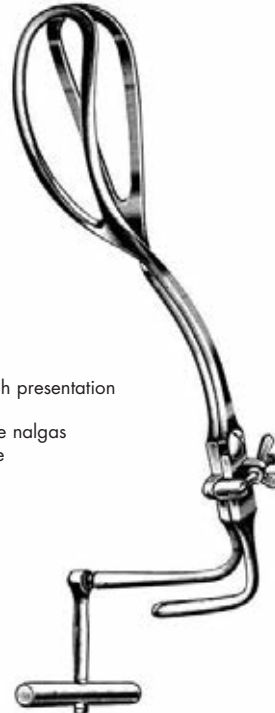

PIPER  
**72.157.40**  
40,0 cm



DEWEY  
**72.160.37**  
 37,0 cm

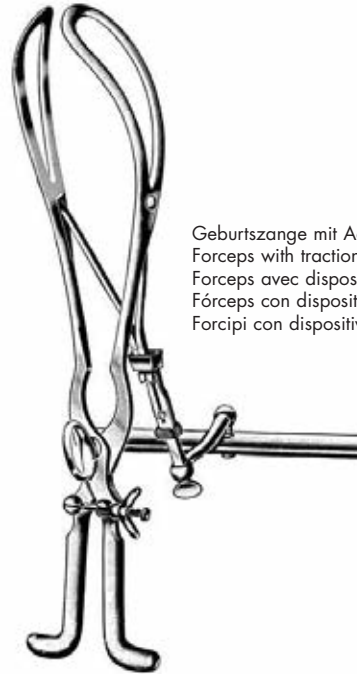

Geburtszange mit Achsenzugvorrichtung  
 Forceps with traction rod  
 Forceps avec dispositif de traction  
 Fórceps con dispositivo de tracción  
 Forcipi con dispositivo di trazione

TARNIER  
**72.162.40**  
 40,0 cm

Kopfhebel für unteres Segment bei Kaiserschnitt  
 Head extractor for use in lower segment in caesarean operation  
 Levier à tête utilisé en cas de césarienne  
 Elevador para cabeza usándose en le segmento inferior del útero  
 en casos de operaciones cesáreas  
 Elevatore per testa in interventi con taglio cesareo



MURLESS  
**72.164.26**

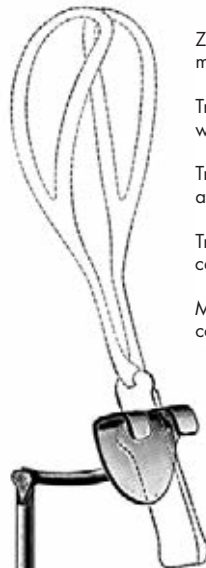

BILL  
**72.170.00**

Zughebel, passend für alle Geburtszangen,  
 mit gehorntem Standard-Griff

Traction handle to be used with all forceps,  
 with standard type handle

Tracteurs pour tous les forceps,  
 avec manches ordinaires

Tractor adecuado para todas las fórceps,  
 con mango standard

Manico a trazione adatto a tutte le forcipi,  
 con manico standard



LUIKART-BILL  
**72.171.21**  
 21,0 cm



## Geburtshilfe

Obstetrics  
Accouchements  
Obstetricia  
Ostetricia

Uterusklemmzange zur Blutstillung  
Caesarean section haemostatic forceps  
Pince-clamp utérine pour hémostase  
Pinza-clamp uterina para hemostasis  
Pinza emostatiche per tagli cesarei



SMELLIE  
**72.181.33**  
33,0 cm



GAUSS  
**72.183.27**  
27,0 cm



GREEN-ARMYTAGE  
**72.184.21**  
21,0 cm

Nabelschnurklemmen  
Umbilical Cord Clamps  
Clamps p. cordon ombilical  
Clamps umbilicales  
Pinze ombelicali



COLLIN  
**72.187.09**  
9,0 cm



KANE  
**72.189.09**  
8,5 cm



MARTIN  
**72.191.34**  
34,0 cm



COLLIER  
**72.193.30**  
30,0 cm



COLLIN  
**72.195.35**  
35,0 cm

## Plazentar- und Abortuszangen

Placenta and Ovum Forceps

Pinces placentaires et pour poste-abortum

Pinzas para aborto y placenta

Pinze per placenta e per ovaie

**dimeda**<sup>®</sup>  
SURGICAL INSTRUMENTS

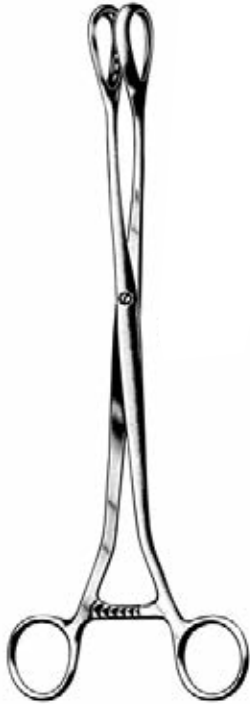

— SAENGER —  
**72.242.27**    **72.243.27**



— WINTER —  
28,0 cm  
**72.244.01** Fig. 1    **72.245.01**  
**72.244.02** Fig. 2    **72.245.02**  
**72.244.03** Fig. 3    **72.245.03**



— WINTER —  
**72.247.02** Fig. 2  
**72.247.03** Fig. 3



— LEWKOWITZ —  
**72.248.24**    **72.249.24**



McCLINTOCK  
**72.250.24**  
24,0 cm

## Plazentar- und Abortuslöffel

Placenta and ovum scoops

Curettes à avortement et placenta

Cucharillas para aborto y placenta

Cucchiai per placenta e ovaie

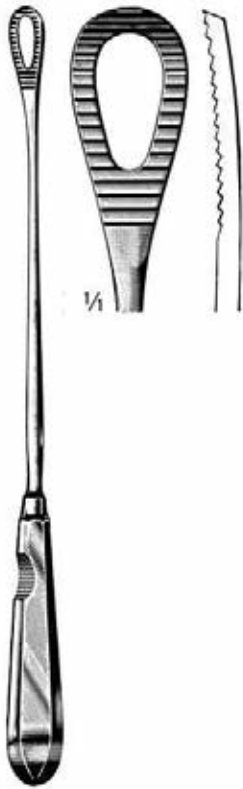

PESTALOZZA  
**72.252.30**  
30,0 cm



**72.254.14**  
14,5 mm

**72.254.18**  
18,0 mm

**72.254.21**  
21,0 mm

CUZZI  
30,0 cm



WALLICH  
**72.256.42**  
42,0 cm

**Geburtshilfe**

Obstetrics  
Accouchements  
Obstetricia  
Ostetricia



SELLHEIM  
**72.259.28**  
28,0 cm



BRAUN  
**72.302.42**  
42,0 cm

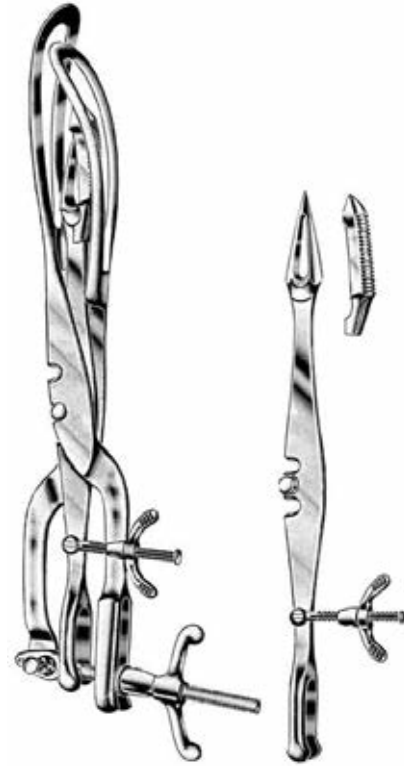

TARNIER  
**72.304.46**  
46,0 cm



SMELLIE  
**72.306.25**  
25,0 cm

Perforatorium  
Perforator  
Perce-crâne  
Perfora-crâneos  
Spezzacraneo



NÄGELE  
**72.308.25**  
25,0 cm



BRAUN  
**72.309.30**  
30,0 cm

Dekapitationshaken  
Decapitating hook  
Grochet pour décapitation  
Gancho para decapitación  
Uncino per detroncazione





Dermatologie, Hygiene  
Dermatology, Hygiene  
Dermatologie, Hygiène  
Dermatología, Higiene  
Dermatologia, Igiene

# Dermatologie

Dermatology  
Dermatologie  
Dermatología  
Dermatologia



KILNER  
74.103.15  
15 cm



SCHAMBERG  
74.111.10  
10 cm



UNNA  
74.113.14  
14 cm



UNNA  
74.115.14  
14 cm



WALTON  
74.118.14  
14 cm



SAALFELD  
74.121.10  
10 cm



mm	FOX
3	74.128.03
4	74.128.04
5	74.128.05
6	74.128.06



Fig.	PIFFARD
1	74.130.01
2	74.130.02
3	74.130.03

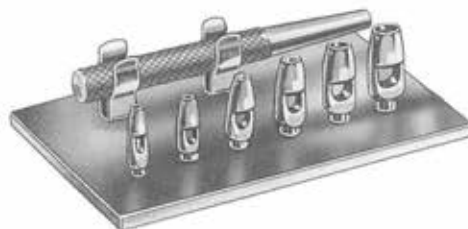

KEYES  
74.138.00  
compl.

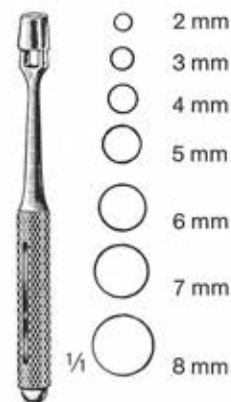

mm	KEYES
2	74.140.02
3	74.140.03
4	74.140.04
5	74.140.05
6	74.140.06
7	74.140.07
8	74.140.08



**Hygiene**

Hygiene  
Hygiène  
Higiene  
Igiene



74.301.10

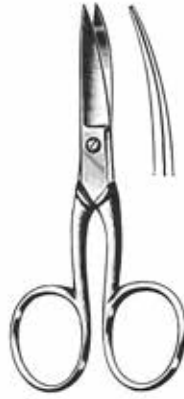

74.304.10 10 cm 74.305.10



74.331.14  
14 cm



74.336.14  
14 cm



cm TURNBULL  
11,5 74.341.11  
13,5 74.341.13



74.360.13  
13 cm



74.365.11  
11 cm



74.373.10  
10,5 cm



74.378.10  
10 cm



74.379.10  
10 mm

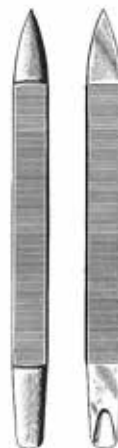

cm  
10 74.386.10  
12 74.386.12



74.396.00  
10 Ersatzklingen  
10 Spare Blades  
10 lames de rechange  
10 hojas de repuesto  
10 lame di ricambio  
  
CREDO  
74.395.14  
14,5 cm

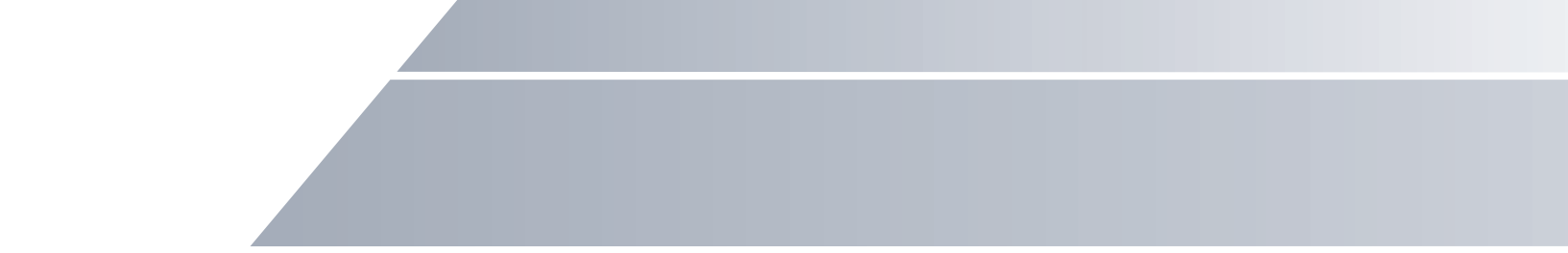



Dental Instrumente  
Dental Instruments  
Instruments dentaires  
Instrumentos dentales  
Strumenti dentali

**Spezialkatalog**

Special catalog  
Catalogue spécial  
Catálogo especial  
Catalog speciale

**dimeda**<sup>®</sup>  
SURGICAL INSTRUMENTS

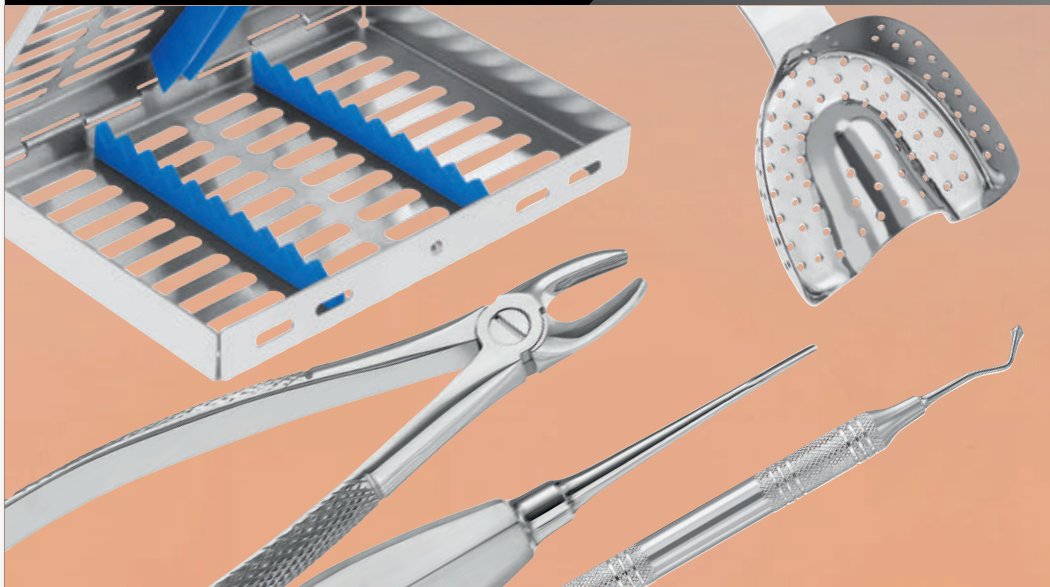

Dental Instrumente  
Dental Instruments  
Instruments dentaires  
Instrumentos dentales  
Strumenti dentali



Verschiedene Behälter  
Different Containers  
Boîtes diverses  
Contenedores varios  
Vassoi diversi

**Nadeldosen**  
Needle Cases  
Boîtes pour aiguilles  
Estuches para agujas  
Scatole per aghi

18/10  
Edelstahl rostfrei  
Stainless Steel  
Acier inoxydable  
Acero inoxidable  
Acciaio inossidabile

komplett mit perforierter Innendose  
complete with perforated interior box  
complet avec boîte intérieure perforée  
completo con caja interior perforada  
completo con scatola interiore perforata



**88.112.65**  
65x15 mm

Innendose  
Deckel und Boden perforiert  
Interior Box  
perforated lid and bottom  
Boîte intérieure  
couvercle et fond perforé  
Caja interior  
tapa y fondo perforado  
Scatola interiore  
coperchio e fondo perforati



**88.113.65**

Nadelkassetten  
Needle Cases  
Boîtes pour aiguilles  
Estuches para agujas  
Scatole per aghi

Deckel und Boden perforiert  
perforated lid and bottom  
couvercle et fond perforé  
tapa y fondo perforado  
coperchio e fondo perforati



SAUERBRUCH  
**88.110.21**  
210x125x17 mm

Deckel und Boden perforiert  
perforated lid and bottom  
couvercle et fond perforé  
tapa y fondo perforado  
coperchio e fondo perforati



**88.114.00**  
150x95x13 mm

## Verschiedene Behälter

Different Containers  
Boîtes diverses  
Contenedores varios  
Vassoi diversi



	L x B x H
<b>88.120.16</b>	165 x 85 x 35 mm
<b>88.120.18</b>	180 x 180 x 40 mm
<b>88.120.20</b>	200 x 100 x 60 mm
<b>88.120.22</b>	220 x 120 x 60 mm
<b>88.120.23</b>	230 x 130 x 50 mm
<b>88.120.25</b>	250 x 120 x 60 mm
<b>88.120.26</b>	260 x 150 x 50 mm
<b>88.120.30</b>	280 x 140 x 60 mm
<b>88.120.32</b>	320 x 150 x 60 mm
<b>88.120.40</b>	400 x 160 x 75 mm
<b>88.120.50</b>	500 x 200 x 120 mm



	L x B x H
<b>88.123.32</b>	320 x 100 x 50 mm
<b>88.123.43</b>	430 x 100 x 35 mm



## Verschiedene Behälter

Different Containers  
Boîtes diverses  
Contenedores varios  
Vassoi diversi



	Ø x H
<b>88.127.10</b>	75 x 60 mm
<b>88.127.11</b>	75 x 75 mm
<b>88.127.20</b>	100 x 60 mm
<b>88.127.21</b>	100 x 100 mm
<b>88.127.30</b>	125 x 80 mm
<b>88.127.31</b>	125 x 125 mm
<b>88.127.40</b>	150 x 150 mm



	Ø x H	
<b>88.130.04</b>	40 x 19 mm	(0.05 Liter)
<b>88.130.06</b>	61 x 30 mm	(0.07 Liter)
<b>88.130.08</b>	80 x 40 mm	(0.14 Liter)
<b>88.130.12</b>	116 x 50 mm	(0.35 Liter)
<b>88.130.13</b>	128 x 55 mm	(0.45 Liter)
<b>88.130.15</b>	147 x 65 mm	(0.70 Liter)
<b>88.130.16</b>	157 x 75 mm	(1.10 Liter)
<b>88.130.19</b>	187 x 85 mm	(1.60 Liter)



	Ø x H
<b>88.131.01</b>	42 x 30 mm
<b>88.131.02</b>	53 x 34 mm
<b>88.131.03</b>	58 x 40 mm
<b>88.131.04</b>	64 x 48 mm
<b>88.131.05</b>	68 x 47 mm
<b>88.131.06</b>	71 x 46 mm
<b>88.131.07</b>	71 x 50 mm
<b>88.131.08</b>	81 x 51 mm
<b>88.131.09</b>	81 x 54 mm
<b>88.131.10</b>	89 x 47 mm
<b>88.131.11</b>	100 x 48 mm
<b>88.131.12</b>	100 x 53 mm

## Verschiedene Behälter

Different Containers  
Boîtes diverses  
Contenedores varios  
Vassoi diversi



	Ø x H
<b>88.132.01</b>	300 x 100 mm
<b>88.132.02</b>	350 x 100 mm
<b>88.132.03</b>	400 x 100 mm
<b>88.132.04</b>	330 x 90 mm
<b>88.132.05</b>	330 x 115 mm



	Ø x H	
<b>88.133.16</b>	150 x 74 mm	(0.75 Liter)
<b>88.133.17</b>	160 x 65 mm	(1.00 Liter)
<b>88.133.22</b>	220 x 70 mm	(2.00 Liter)
<b>88.133.23</b>	230 x 80 mm	(2.50 Liter)
<b>88.133.24</b>	260 x 130 mm	(4.50 Liter)
<b>88.133.25</b>	255 x 115 mm	(3.50 Liter)
<b>88.133.27</b>	275 x 115 mm	(5.00 Liter)
<b>88.133.29</b>	300 x 105 mm	(6.00 Liter)
<b>88.133.38</b>	400 x 150 mm	(14.00 Liter)



	Ø x H
<b>88.133.31</b>	300 x 120 mm
<b>88.133.34</b>	350 x 130 mm
<b>88.133.41</b>	400 x 140 mm



<b>88.134.10</b>	1.00 Liter
<b>88.134.15</b>	1.50 Liter
<b>88.134.20</b>	2.00 Liter

## Verschiedene Behälter

Different Containers  
Boîtes diverses  
Contenedores varios  
Vassoi diversi



	<u>L x B x H</u>
<b>88.136.23</b>	380 x 230 x 95 mm
<b>88.136.27</b>	350 x 270 x 100 mm



<b>88.137.23</b>	235 mm
<b>88.137.30</b>	310 mm



	<u>L x B x H</u>	
<b>88.137.40</b>	300 x 200 x 75 mm	Small (with handle)
<b>88.137.41</b>	300 x 200 x 75 mm	Small (without handle)
<b>88.137.43</b>	350 x 230 x 100 mm	Large (with handle)



	<u>Ø x H</u>
<b>88.138.70</b>	100 x 50 mm

## Verschiedene Behälter

Different Containers  
Boîtes diverses  
Contenedores varios  
Vassoi diversi

**dimeda**<sup>®</sup>  
SURGICAL INSTRUMENTS



	<u>L x B x H</u>
<b>88.139.17</b>	170 x 100 x 30 mm
<b>88.139.20</b>	200 x 120 x 35 mm
<b>88.139.25</b>	250 x 140 x 40 mm
<b>88.139.27</b>	275 x 150 x 50 mm
<b>88.139.30</b>	300 x 160 x 50 mm
<b>88.139.40</b>	400 x 200 x 60 mm



	<u>Ø x H</u>
<b>88.139.91</b>	100 x 100 mm
<b>88.139.92</b>	150 x 150 mm



	<u>Ø x H</u>	
<b>88.140.00</b>	58 x 30 mm	25ml
<b>88.140.01</b>	52 x 50 mm	50ml
<b>88.140.03</b>	65 x 55 mm	100ml



<b>88.140.02</b>	0.25 Liter
<b>88.140.05</b>	0.50 Liter
<b>88.140.10</b>	1.00 Liter
<b>88.140.20</b>	2.00 Liter

Verschiedene Behälter / Different Containers / Boîtes diverses / Contenedores varios / Vassoi diversi

## Verschiedene Behälter

Different Containers  
Boîtes diverses  
Contenedores varios  
Vassoi diversi



	$\varnothing$ x H
<b>88.141.06</b>	60 x 20 mm
<b>88.141.09</b>	90 x 15 mm
<b>88.141.10</b>	100 x 20 mm
<b>88.141.12</b>	120 x 20 mm



	$\varnothing$ x H
<b>88.142.01</b>	30 x 90 mm
<b>88.142.02</b>	50 x 100 mm
<b>88.142.03</b>	50 x 130 mm
<b>88.142.04</b>	50 x 175 mm
<b>88.142.05</b>	75 x 100 mm
<b>88.142.06</b>	75 x 130 mm
<b>88.142.07</b>	75 x 175 mm
<b>88.142.08</b>	100 x 175 mm
<b>88.142.09</b>	100 x 200 mm



	L x B x H
<b>88.142.19</b>	190 x 100 x 13 mm
<b>88.142.20</b>	200 x 100 x 13 mm



	L x B x H
<b>88.143.19</b>	190 x 100 x 13 mm
<b>88.143.20</b>	200 x 100 x 13 mm
<b>88.143.45</b>	450 x 300 x 32 mm

## Verschiedene Behälter

Different Containers  
Boîtes diverses  
Contenedores varios  
Vassoi diversi



	L x B x H
<b>88.144.20</b>	200 x 150 x 25 mm
<b>88.144.22</b>	230 x 155 x 30 mm
<b>88.144.28</b>	300 x 175 x 30 mm
<b>88.144.31</b>	300 x 175 x 40 mm
<b>88.144.32</b>	300 x 200 x 50 mm
<b>88.144.35</b>	350 x 220 x 40 mm
<b>88.144.37</b>	400 x 300 x 50 mm
<b>88.144.42</b>	450 x 350 x 50 mm



	L x B x H
<b>88.145.21</b>	210 x 160 x 10 mm
<b>88.145.24</b>	240 x 180 x 10 mm
<b>88.145.29</b>	290 x 190 x 10 mm
<b>88.145.30</b>	310 x 150 x 10 mm
<b>88.145.32</b>	300 x 200 x 20 mm
<b>88.145.33</b>	300 x 245 x 16 mm
<b>88.145.35</b>	350 x 240 x 10 mm
<b>88.145.38</b>	385 x 265 x 16 mm
<b>88.145.39</b>	385 x 210 x 10 mm
<b>88.145.40</b>	400 x 270 x 20 mm
<b>88.145.42</b>	420 x 280 x 10 mm
<b>88.145.43</b>	430 x 295 x 16 mm
<b>88.145.49</b>	485 x 320 x 16 mm
<b>88.145.51</b>	510 x 380 x 30 mm
<b>88.145.59</b>	590 x 380 x 30 mm



	L x B x H
<b>88.146.22</b>	220 x 170 x 50 mm
<b>88.146.28</b>	300 x 175 x 30 mm
<b>88.146.30</b>	300 x 175 x 40 mm
<b>88.146.32</b>	300 x 200 x 50 mm
<b>88.146.35</b>	350 x 240 x 36 mm
<b>88.146.37</b>	400 x 300 x 50 mm
<b>88.146.42</b>	450 x 350 x 50 mm

## Verschiedene Behälter

Different Containers  
Boîtes diverses  
Contenedores varios  
Vassoi diversi



	$L \times B \times H$
<b>88.147.31</b>	230 x 150 x 85 mm



	$L \times B \times H$
<b>88.147.32</b>	230 x 150 x 85 mm



	$\varnothing \times H$
<b>88.147.33</b>	230 x 115 mm



	$\varnothing \times H$	
<b>88.150.02</b>	75 x 75 mm	(0.25 Liter)
<b>88.150.05</b>	100 x 85 mm	(0.50 Liter)
<b>88.150.07</b>	115 x 100 mm	(0.75 Liter)
<b>88.150.10</b>	125 x 125 mm	(1.00 Liter)



## Verschiedene Behälter

Different Containers  
Boîtes diverses  
Contenedores varios  
Vassoi diversi

**dimeda**<sup>®</sup>  
SURGICAL INSTRUMENTS



**88.754.10** 10.00 Liter  
**88.754.13** 13.00 Liter  
**88.754.15** 15.00 Liter  
**88.754.18** 18.00 Liter



**88.755.21** 210 mm  
**88.755.24** 240 mm  
**88.755.27** 270 mm  
**88.755.30** 300 mm

Verschiedene Behälter / Different Containers / Boîtes diverses / Contenedores varios / Vassoi diversi

## Sterilisiertrommeln

Sterilizing Drums

Tambours à stérilisation

Tambores p. esterilización

Tambori p. sterilizzazione

18/10

Edelstahl rostfrei

Stainless Steel

Acier inoxydable

Acero inoxidable

Acciaio inossidabile



### SCHIMMELBUSCH

### Ø x H

### KONRICH

<b>88.152.08</b>	125 x 80 mm	<b>88.182.08</b>
<b>88.152.10</b>	125 x 100 mm	<b>88.182.10</b>
<b>88.152.12</b>	125 x 125 mm	<b>88.182.12</b>
<b>88.155.08</b>	150 x 80 mm	
<b>88.155.10</b>	150 x 100 mm	<b>88.185.10</b>
<b>88.155.13</b>	150 x 130 mm	<b>88.185.13</b>
<b>88.155.15</b>	150 x 150 mm	<b>88.185.15</b>
<b>88.155.19</b>	150 x 190 mm	<b>88.185.19</b>
<b>88.159.14</b>	190 x 145 mm	<b>88.189.14</b>
<b>88.159.16</b>	190 x 165 mm	<b>88.189.16</b>
<b>88.159.19</b>	190 x 190 mm	<b>88.189.19</b>
<b>88.159.24</b>	190 x 240 mm	<b>88.189.24</b>
<b>88.164.14</b>	240 x 145 mm	
<b>88.164.16</b>	240 x 165 mm	<b>88.194.16</b>
<b>88.164.19</b>	240 x 190 mm	<b>88.194.19</b>
<b>88.164.24</b>	240 x 240 mm	<b>88.194.24</b>
<b>88.164.29</b>	240 x 290 mm	<b>88.194.29</b>
<b>88.164.34</b>	240 x 340 mm	
<b>88.164.39</b>	240 x 390 mm	
<b>88.169.14</b>	290 x 145 mm	<b>88.199.14</b>
<b>88.169.16</b>	290 x 165 mm	<b>88.199.16</b>
<b>88.169.19</b>	290 x 190 mm	<b>88.199.19</b>
<b>88.169.24</b>	290 x 240 mm	<b>88.199.24</b>
<b>88.169.29</b>	290 x 290 mm	<b>88.199.29</b>
<b>88.169.34</b>	290 x 340 mm	
<b>88.169.39</b>	290 x 390 mm	
<b>88.174.14</b>	340 x 145 mm	<b>88.204.14</b>
<b>88.174.16</b>	340 x 165 mm	<b>88.204.16</b>
<b>88.174.19</b>	340 x 190 mm	<b>88.204.19</b>
<b>88.174.24</b>	340 x 240 mm	<b>88.204.24</b>
<b>88.174.29</b>	340 x 290 mm	<b>88.204.29</b>
<b>88.174.34</b>	340 x 340 mm	
<b>88.174.39</b>	340 x 390 mm	
<b>88.179.14</b>	390 x 145 mm	<b>88.209.14</b>
<b>88.179.16</b>	390 x 165 mm	<b>88.209.16</b>
<b>88.179.19</b>	390 x 190 mm	<b>88.209.19</b>
<b>88.179.24</b>	390 x 240 mm	<b>88.209.24</b>
<b>88.179.29</b>	390 x 290 mm	<b>88.209.29</b>
<b>88.179.34</b>	390 x 340 mm	<b>88.209.34</b>
<b>88.179.39</b>	390 x 390 mm	<b>88.209.39</b>
<b>88.179.49</b>	390 x 490 mm	
<b>88.179.59</b>	390 x 590 mm	

## Siebschalen

Trays  
Plateaux  
Bandejas  
Cestelli

**dimeda**<sup>®</sup>  
SURGICAL INSTRUMENTS

18/10  
Edelstahl rostfrei  
Stainless Steel  
Acier inoxydable  
Acero inoxidable  
Acciaio inossidabile

Aus Drahtgeflecht  
Wire Mesh  
En fil inox  
De alambre  
In rete metallica

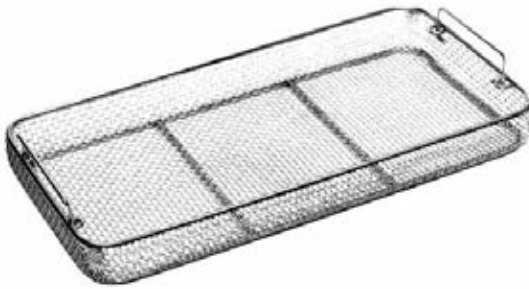

	<u>L x B x H</u>
<b>88.240.24</b>	240 x 250 x 50 mm
<b>88.240.48</b>	480 x 250 x 50 mm
<b>88.240.55</b>	550 x 250 x 50 mm
<b>88.241.24</b>	240 x 250 x 70 mm
<b>88.241.48</b>	480 x 250 x 70 mm
<b>88.242.24</b>	240 x 250 x 100 mm
<b>88.242.48</b>	480 x 250 x 100 mm

Verschiedene Behälter / Different Containers / Boîtes diverses / Contenedores varios / Vassoi diversi











Container aus Aluminium  
Aluminium Containers  
Containers en aluminium  
Contenedores de aluminio  
Container in alluminio

**Präparierscheren**  
Dissecting Scissors  
Ciseaux à dissection  
Tijeras de disección  
Forbici per dissezione

Deckelfarbe  
Colour of Lid  
Couleur du couvercle  
Color de la tapa  
Colore del coperchio

<b>A</b>		Silber, silver, argent, plata, argento
<b>B</b>		Gold, gold, or, oro, oro
<b>C</b>		Rot, red, rouge, rojo, rosso
<b>D</b>		Blau, blue, bleu, azul, blu,
<b>E</b>		Grün, green, vert, verde, verde
<b>F</b>		Schwarz, black, noir, negro, nero

	Große Container und Zubehör Large Containers and Accessories Grands container et accessoires Contenedores grandes y accesoris Grossi container e accessori	4 - 7
	3/4 Container und Zubehör 3/4 Containers and Accessories 3/4 Container et accessoires 3/4 Contenedores y accesorios 3/4 Container e accessori	8 - 11
	Halb-Container und Zubehör Half-Size-Containers and Accessories Semi-Container et accessoires Contenedores medianos y accesorios Mezzi container e accessori	12 - 15
	Flach-, Halb-, Container und Zubehör Flat Half-Size-Containers and Accessories Plat-, Semi-, Container et accessoires Contenedores medianos y planos y accesorios Piatti, Mezzi-, Container e accessori	16 - 17
	Kleine Container und Zubehör Small Containers and Accessories Petit-Container et accessoires Contenedores pequeños y accesorios Piccoli container e accessori	18 - 19
	Spezial Container Set und Zubehör Special Container Set and Accessories Spécial Container Set et accessoires Contenedores especiales y accesorios Container speciale e accessori	20
	Spezial Container Set und Zubehör Special Container Set and Accessories Spécial Container Set et accessoires Contenedores especiales y accesorios Container speciale e accessori	21 - 23
	Zubehör Accessories Accessoires Accesorios Accessori	24 - 27



## Große Container und Zubehör

Large Containers and Accessories

Grands container et accessoires

Contenedores grandes y accesorios

Grossi container e accessori

Deckel gelocht - Boden ungelocht  
Lid perforated - Bottom non perforated  
Couvercle perforé - Fond non perforé  
Tapa perforada - Fondo no perforada  
Coperchio forato - Fondo non forato

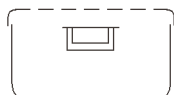

Deckel gelocht - Boden gelocht  
Lid perforated - Bottom perforated  
Couvercle perforé - Fond perforé  
Tapa perforada - Fondo perforada  
Coperchio forato - Fondo forato



580 x 280 x 100 mm



88.600.01 A  
88.600.02 B  
88.600.03 C  
88.600.04 D  
88.600.05 E  
88.600.06 F

88.601.01 A  
88.601.02 B  
88.601.03 C  
88.601.04 D  
88.601.05 E  
88.601.06 F

580 x 280 x 135 mm



88.600.11 A  
88.600.12 B  
88.600.13 C  
88.600.14 D  
88.600.15 E  
88.600.16 F

88.601.11 A  
88.601.12 B  
88.601.13 C  
88.601.14 D  
88.601.15 E  
88.601.16 F

580 x 280 x 150 mm



88.600.21 A  
88.600.22 B  
88.600.23 C  
88.600.24 D  
88.600.25 E  
88.600.26 F

88.601.21 A  
88.601.22 B  
88.601.23 C  
88.601.24 D  
88.601.25 E  
88.601.26 F

580 x 280 x 200 mm



88.600.31 A  
88.600.32 B  
88.600.33 C  
88.600.34 D  
88.600.35 E  
88.600.36 F

88.601.31 A  
88.601.32 B  
88.601.33 C  
88.601.34 D  
88.601.35 E  
88.601.36 F

580 x 280 x 260 mm



88.600.41 A  
88.600.42 B  
88.600.43 C  
88.600.44 D  
88.600.45 E  
88.600.46 F

88.601.41 A  
88.601.42 B  
88.601.43 C  
88.601.44 D  
88.601.45 E  
88.601.46 F

## Große Container und Zubehör

Large Containers and Accessories  
Grands container et accessoires  
Contenedores grandes y accesorios  
Grossi container e accessori

**dimeda**<sup>®</sup>  
SURGICAL INSTRUMENTS

Sicherheitsdeckel - Boden ungelocht  
Safety Lid - Bottom non-perforated  
Couvercle de sécurité - Fond non perforé  
Tapa de seguridad - Fondo no perforada  
Coperchio di Protezione - Fondo non forato

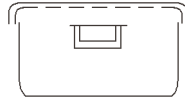

Sicherheitsdeckel - Boden gelocht  
Safety Lid - Bottom perforated  
Couvercle de sécurité - Fond perforé  
Tapa de seguridad - Fondo perforada  
Coperchio di Protezione - Fondo forato

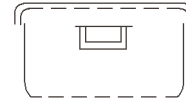

580 x 280 x 100 mm



<b>88.602.01</b>		A
<b>88.602.02</b>		B
<b>88.602.03</b>		C
<b>88.602.04</b>		D
<b>88.602.05</b>		E
<b>88.602.06</b>		F

<b>88.603.01</b>		A
<b>88.603.02</b>		B
<b>88.603.03</b>		C
<b>88.603.04</b>		D
<b>88.603.05</b>		E
<b>88.603.06</b>		F

580 x 280 x 135 mm



<b>88.602.11</b>		A
<b>88.602.12</b>		B
<b>88.602.13</b>		C
<b>88.602.14</b>		D
<b>88.602.15</b>		E
<b>88.602.16</b>		F

<b>88.603.11</b>		A
<b>88.603.12</b>		B
<b>88.603.13</b>		C
<b>88.603.14</b>		D
<b>88.603.15</b>		E
<b>88.603.16</b>		F

580 x 280 x 150 mm



<b>88.602.21</b>		A
<b>88.602.22</b>		B
<b>88.602.23</b>		C
<b>88.602.24</b>		D
<b>88.602.25</b>		E
<b>88.602.26</b>		F

<b>88.603.21</b>		A
<b>88.603.22</b>		B
<b>88.603.23</b>		C
<b>88.603.24</b>		D
<b>88.603.25</b>		E
<b>88.603.26</b>		F

580 x 280 x 200 mm



<b>88.602.31</b>		A
<b>88.602.32</b>		B
<b>88.602.33</b>		C
<b>88.602.34</b>		D
<b>88.602.35</b>		E
<b>88.602.36</b>		F

<b>88.603.31</b>		A
<b>88.603.32</b>		B
<b>88.603.33</b>		C
<b>88.603.34</b>		D
<b>88.603.35</b>		E
<b>88.603.36</b>		F

580 x 280 x 260 mm



<b>88.602.41</b>		A
<b>88.602.42</b>		B
<b>88.602.43</b>		C
<b>88.602.44</b>		D
<b>88.602.45</b>		E
<b>88.602.46</b>		F

<b>88.603.41</b>		A
<b>88.603.42</b>		B
<b>88.603.43</b>		C
<b>88.603.44</b>		D
<b>88.603.45</b>		E
<b>88.603.46</b>		F

Verschiedene Behälter / Different Containers / Boîtes diverses / Contenedores varios / Vassoi diversi

## Große Container und Zubehör

Large Containers and Accessories

Grands container et accessoires

Contenedores grandes y accesorios

Grossi container e accessori

Boden ungelocht  
Bottom non-perforated  
Fond non perforé  
Fondo no perforada  
Fondo non forato



**88.604.10** 580 x 280 x 100 mm  
**88.604.20** 580 x 280 x 135 mm  
**88.604.30** 580 x 280 x 150 mm  
**88.604.40** 580 x 280 x 200 mm  
**88.604.50** 580 x 280 x 260 mm

Boden gelocht  
Bottom perforated  
Fond perforé  
Fondo perforada  
Fondo forato







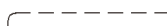

**88.605.10** 580 x 280 x 100 mm  
**88.605.20** 580 x 280 x 135 mm  
**88.605.30** 580 x 280 x 150 mm  
**88.605.40** 580 x 280 x 200 mm  
**88.605.50** 580 x 280 x 260 mm

Deckel gelocht  
Lid perforated  
Courvercle perforé  
Tapa perforada  
Coperchio forato



580 x 280 mm









**88.606.01** A   
**88.606.02** B   
**88.606.03** C   
**88.606.04** D   
**88.606.05** E   
**88.606.06** F 

Sicherheitsdeckel  
Safety Lid  
Courvercle de sécurité  
Tapa de seguridad  
Coperchio di Protezione



580 x 280 mm



**88.607.01** A   
**88.607.02** B   
**88.607.03** C   
**88.607.04** D   
**88.607.05** E   
**88.607.06** F 

## Große Container und Zubehör

Large Containers and Accessories  
Grands container et accessoires  
Contenedores grandes y accesorios  
Grossi container e accessori

**dimeda**<sup>®</sup>  
SURGICAL INSTRUMENTS

Siebkörbe Edelstahl  
Wire baskets, special steel  
Paniers grillagés en acier de haute qualité  
Cestillos de acero fino  
Cestelli in acciaio fino



**88.609.11** 540 x 255 x 30 mm  
**88.609.12** 540 x 255 x 50 mm  
**88.609.13** 540 x 255 x 70 mm  
**88.609.14** 540 x 255 x 100 mm

Siebkörbe Edelstahl  
Wire baskets, special steel  
Paniers grillagés en acier de haute qualité  
Cestillos de acero fino  
Cestelli in acciaio fino



**88.609.01** 485 x 255 x 30 mm  
**88.609.02** 485 x 255 x 50 mm  
**88.609.03** 485 x 255 x 70 mm  
**88.609.04** 485 x 255 x 100 mm

Siebboden  
Separate floors  
Fond du crible  
Cestas-cuerpos  
Fondo di Cestello



**88.609.21** 545 x 255 x 30 mm

Spannrahmen für Einschlagtücher  
Tension Clips for Towels  
Cadre tendeur à champs  
Marcos tensores para paños  
Telaio di fissaggio



**88.695.12** 545 x 255 mm

Einschlagtücher aus Baumwolle  
Wrapping drapes, cotton  
Champs, coton  
Paños de embalaje de algodón  
Telo, cotone



**88.695.07** 130 x 60 cm  
**88.695.08** 140 x 100 cm  
**88.695.09** 185 x 45 cm  
**88.695.10** 185 x 60 cm

Verschiedene Behälter / Different Containers / Boîtes diverses / Contenedores varios / Vassoi diversi

### 3/4 Container und Zubehör

3/4 Containers and Accessories

3/4 Container et accessoires

3/4 Contenedores y accesorios

3/4 Container e accessori

Deckel gelocht - Boden ungelocht  
Lid perforated - Bottom non perforated  
Courvercle perforé - Fond non perforé  
Tapa perforada - Fondo no perforada  
Coperchio forato - Fondo non forato















Deckel gelocht - Boden gelocht  
Lid perforated - Bottom perforated  
Courvercle perforé - Fond perforé  
Tapa perforada - Fondo perforada  
Coperchio forato - Fondo forato



465 x 280 x 100 mm















**88.610.01**  A  
**88.610.02**  B  
**88.610.03**  C  
**88.610.04**  D  
**88.610.05**  E  
**88.610.06**  F

**88.611.01**  A  
**88.611.02**  B  
**88.611.03**  C  
**88.611.04**  D  
**88.611.05**  E  
**88.611.06**  F

465 x 280 x 135 mm















**88.610.11**  A  
**88.610.12**  B  
**88.610.13**  C  
**88.610.14**  D  
**88.610.15**  E  
**88.610.16**  F

**88.611.11**  A  
**88.611.12**  B  
**88.611.13**  C  
**88.611.14**  D  
**88.611.15**  E  
**88.611.16**  F

465 x 280 x 150 mm



**88.610.21**  A  
**88.610.22**  B  
**88.610.23**  C  
**88.610.24**  D  
**88.610.25**  E  
**88.610.26**  F

**88.611.21**  A  
**81.611.22**  B  
**81.611.23**  C  
**81.611.24**  D  
**88.611.25**  E  
**88.611.26**  F

### 3/4 Container und Zubehör

3/4 Containers and Accessories

3/4 Container et accessoires

3/4 Contenedores y accesorios

3/4 Container e accessori

**dimeda**<sup>®</sup>  
SURGICAL INSTRUMENTS

Sicherheitsdeckel - Boden ungelocht  
Safety Lid - Bottom non-perforated  
Courvercle de sécurité - Fond non perforé  
Tapa de seguridad - Fondo no perforada  
Coperchio di Protezione - Fondo non forato

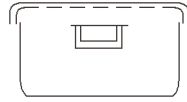



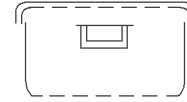









Sicherheitsdeckel - Boden gelocht  
Safety Lid - Bottom perforated  
Courvercle de sécurité - Fond perforé  
Tapa de seguridad - Fondo no perforada  
Coperchio di Protezione - Fondo forato



465 x 280 x 100 mm















**88.612.01**  A  
**88.612.02**  B  
**88.612.03**  C  
**88.612.04**  D  
**88.612.05**  E  
**88.612.06**  F

**88.613.01**  A  
**88.613.02**  B  
**88.613.03**  C  
**88.613.04**  D  
**88.613.05**  E  
**88.613.06**  F

465 x 280 x 135 mm















**88.612.11**  A  
**88.612.12**  B  
**88.612.13**  C  
**88.612.14**  D  
**88.612.15**  E  
**88.612.16**  F

**88.613.11**  A  
**88.613.12**  B  
**88.613.13**  C  
**88.613.14**  D  
**88.613.15**  E  
**88.613.16**  F

465 x 280 x 150 mm



**88.612.21**  A  
**88.612.22**  B  
**88.612.23**  C  
**88.612.24**  D  
**88.612.25**  E  
**88.612.26**  F

**88.613.21**  A  
**81.613.22**  B  
**81.613.23**  C  
**81.613.24**  D  
**88.613.25**  E  
**88.613.26**  F

Verschiedene Behälter / Different Containers / Boîtes diverses / Contenedores varios / Vassoi diversi

### 3/4 Container und Zubehör

3/4 Containers and Accessories

3/4 Container et accessoires

3/4 Contenedores y accesorios

3/4 Container e accessori

Boden ungelocht  
Bottom non-perforated  
Fond non perforé  
Fondo no perforada  
Fondo non forato

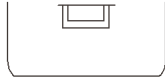

**88.614.01** 465 x 280 x 100 mm  
**88.614.02** 465 x 280 x 135 mm  
**88.614.03** 465 x 280 x 150 mm

Boden gelocht  
Bottom perforated  
Fond perforé  
Fondo perforada  
Fondo forato







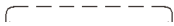

**88.615.01** 465 x 280 x 100 mm  
**88.615.02** 465 x 280 x 135 mm  
**88.615.03** 465 x 280 x 150 mm

Deckel gelocht  
Lid perforated  
Couvercle perforé  
Tapa perforada  
Coperchio forato

465 x 280 mm







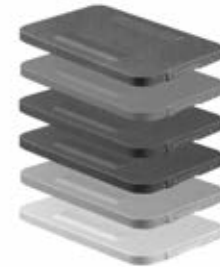

**88.616.01** A   
**88.616.02** B   
**88.616.03** C   
**88.616.04** D   
**88.616.05** E   
**88.616.06** F 

Sicherheitsdeckel  
Safety Lid  
Couvercle de sécurité  
Tapa de seguridad  
Coperchio di Protezione

465 x 280 mm



**88.617.01** A   
**88.617.02** B   
**88.617.03** C   
**88.617.04** D   
**88.617.05** E   
**88.617.06** F 



### 3/4 Container und Zubehör

3/4 Containers and Accessories  
3/4 Container et accessoires  
3/4 Contenedores y accesorios  
3/4 Container e accessori

**dimeda**<sup>®</sup>  
SURGICAL INSTRUMENTS

Siebkörbe Edelstahl  
Wire baskets, special steel  
Paniers grillagés en acier de haute qualité  
Cestillos de acero fino  
Cestelli in acciaio fino



**88.619.01** 405 x 255 x 30 mm  
**88.619.02** 405 x 255 x 50 mm  
**88.619.03** 405 x 255 x 70 mm  
**88.619.04** 405 x 255 x 100 mm

Siebboden  
Separate floors  
Fond du crible  
Cestas-cuerpos  
Fondo di Cestello



**88.619.11** 405 x 255 x 30 mm

Spannrahmen für Einschlagtücher  
Tension Clips for Towels  
Cadre tendeur à champs  
Marcos tensores para paños  
Telaio di fissaggio



**88.695.13** 405 x 255 mm

Einschlagtücher aus Baumwolle  
Wrapping drapes, cotton  
Champs, coton  
Paños de embalaje de algodón  
Telo, cotone



**88.695.08** 140 x 100 cm

Verschiedene Behälter / Different Containers / Boîtes diverses / Contenedores varios / Vassoi diversi

## Halb-Container und Zubehör

Half-Size-Containers and Accessories

Semi-Container et accessoires

Contenedores medianos y accesorios

Mezzi container e accessori

Deckel gelocht - Boden ungelocht  
Lid perforated - Bottom non perforated  
Couvercle perforé - Fond non perforé  
Tapa perforada - Fondo no perforada  
Coperchio forato - Fondo non forato

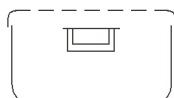













Deckel gelocht - Boden gelocht  
Lid perforated - Bottom perforated  
Couvercle perforé - Fond perforé  
Tapa perforada - Fondo perforada  
Coperchio forato - Fondo forato



285 x 280 x 100 mm















88.620.01  A  
88.620.02  B  
88.620.03  C  
88.620.04  D  
88.620.05  E  
88.620.06  F

88.621.01  A  
88.621.02  B  
88.621.03  C  
88.621.04  D  
88.621.05  E  
88.621.06  F

285 x 280 x 135 mm















88.620.11  A  
88.620.12  B  
88.620.13  C  
88.620.14  D  
88.620.15  E  
88.620.16  F

88.621.11  A  
88.621.12  B  
88.621.13  C  
88.621.14  D  
88.621.15  E  
88.621.16  F

285 x 280 x 150 mm















88.620.21  A  
88.620.22  B  
88.620.23  C  
88.620.24  D  
88.620.25  E  
88.620.26  F

88.621.21  A  
88.621.22  B  
88.621.23  C  
88.621.24  D  
88.621.25  E  
88.621.26  F

285 x 280 x 200 mm















88.620.31  A  
88.620.32  B  
88.620.33  C  
88.620.34  D  
88.620.35  E  
88.620.36  F

88.621.31  A  
88.621.32  B  
88.621.33  C  
88.621.34  D  
88.621.35  E  
88.621.36  F

285 x 280 x 260 mm



88.620.41  A  
88.620.42  B  
88.620.43  C  
88.620.44  D  
88.620.45  E  
88.620.46  F

88.621.41  A  
88.621.42  B  
88.621.43  C  
88.621.44  D  
88.621.45  E  
88.621.46  F

Sicherheitsdeckel - Boden ungelocht  
 Safety Lid - Bottom non-perforated  
 Courvercle de sécurité - Fond non perforé  
 Tapa de seguridad - Fondo no perforada  
 Coperchio di Protezione - Fondo non forato

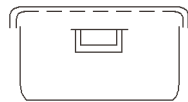

Sicherheitsdeckel - Boden gelocht  
 Safety Lid - Bottom perforated  
 Courvercle de sécurité - Fond perforé  
 Tapa de seguridad - Fondo no perforada  
 Coperchio di Protezione - Fondo forato

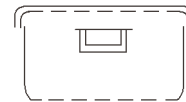

285 x 280 x 100 mm



**88.622.01** A  
**88.622.02** B  
**88.622.03** C  
**88.622.04** D  
**88.622.05** E  
**88.622.06** F

**88.623.01** A  
**88.623.02** B  
**88.623.03** C  
**88.623.04** D  
**88.623.05** E  
**88.623.06** F

285 x 280 x 135 mm



**88.622.11** A  
**88.622.12** B  
**88.622.13** C  
**88.622.14** D  
**88.622.15** E  
**88.622.16** F

**88.623.11** A  
**88.623.12** B  
**88.623.13** C  
**88.623.14** D  
**88.623.15** E  
**88.623.16** F

285 x 280 x 150 mm



**88.622.21** A  
**88.622.22** B  
**88.622.23** C  
**88.622.24** D  
**88.622.25** E  
**88.622.26** F

**88.623.21** A  
**88.623.22** B  
**88.623.23** C  
**88.623.24** D  
**88.623.25** E  
**88.623.26** F

285 x 280 x 200 mm



**88.622.31** A  
**88.622.32** B  
**88.622.33** C  
**88.622.34** D  
**88.622.35** E  
**88.622.36** F

**88.623.31** A  
**88.623.32** B  
**88.623.33** C  
**88.623.34** D  
**88.623.35** E  
**88.623.36** F

285 x 280 x 260 mm



**88.622.41** A  
**88.622.42** B  
**88.622.43** C  
**88.622.44** D  
**88.622.45** E  
**88.622.46** F

**88.623.41** A  
**88.623.42** B  
**88.623.43** C  
**88.623.44** D  
**88.623.45** E  
**88.623.46** F

## Halb-Container und Zubehör

Half-Size-Containers and Accessories

Semi-Container et accessoires

Contenedores medianos y accesorios

Mezzi container e accessori

Boden ungelocht  
Bottom non-perforated  
Fond non perforé  
Fondo no perforada  
Fondo non forato



A

<b>88.624.01</b>	285 x 280 x 100 mm
<b>88.624.02</b>	285 x 280 x 135 mm
<b>88.624.03</b>	285 x 280 x 150 mm
<b>88.624.04</b>	285 x 280 x 200 mm
<b>88.624.05</b>	285 x 280 x 260 mm

Boden gelocht  
Bottom perforated  
Fond perforé  
Fondo perforada  
Fondo forato



A

<b>88.625.01</b>	285 x 280 x 100 mm
<b>88.625.02</b>	285 x 280 x 135 mm
<b>88.625.03</b>	285 x 280 x 150 mm
<b>88.625.02</b>	285 x 280 x 200 mm
<b>88.625.03</b>	285 x 280 x 260 mm

Deckel gelocht  
Lid perforated  
Courvercle perforé  
Tapa perforada  
Coperchio forato

285 x 280 mm



<b>88.626.01</b>	A	
<b>88.626.02</b>	B	
<b>88.626.03</b>	C	
<b>88.626.04</b>	D	
<b>88.626.05</b>	E	
<b>88.626.06</b>	F	

Sicherheitsdeckel  
Safety Lid  
Courvercle de sécurité  
Tapa de seguridad  
Coperchio di Protezione

285 x 280 mm



<b>88.627.01</b>	A	
<b>88.627.02</b>	B	
<b>88.627.03</b>	C	
<b>88.627.04</b>	D	
<b>88.627.05</b>	E	
<b>88.627.06</b>	F	

Siebkörbe Edelstahl  
Wire baskets, special steel  
Paniers grillagés en acier de haute qualité  
Cestillos de acero fino  
Cestelli in acciaio fino



**88.629.01** 255 x 245 x 30 mm  
**88.629.02** 255 x 245 x 50 mm  
**88.629.03** 255 x 245 x 70 mm  
**88.629.04** 255 x 245 x 100 mm

Siebboden  
Separate floors  
Fond du crible  
Cestas-cuerpos  
Fondo di Cestello



**88.629.11** 255 x 245 x 30 mm

Spannrahmen für Einschlagtücher  
Tension Clips for Towels  
Cadre tendeur à champs  
Marcos tensores para paños  
Telaio di fissaggio



**88.695.17** 255 x 255 mm

Einschlagtücher aus Baumwolle  
Wrapping drapes, cotton  
Champs, coton  
Paños de embalaje de algodón  
Telo, cotone



**88.695.04** 90 x 60 cm  
**88.695.05** 90 x 80 cm  
**88.695.06** 130 x 45 cm  
**88.695.07** 130 x 60 cm

## Flach-, Halb-, Container und Zubehör

Flat Half-Size-Containers and Accessories

Plat, Semi-, Container et accessoires

Contenedores medianos y planos y accesorios

Piatti, Mezzi-, Container e accessori

Deckel gelocht - Boden ungelocht  
Lid perforated - Bottom non-perforated  
Courvercle perforé - Fond non perforé  
Tapa perforada - Fondo no perforada  
Coperchio forato - Fondo non forato

Deckel gelocht - Boden gelocht  
Lid perforated - Bottom perforated  
Courvercle perforé - Fond perforé  
Tapa perforada - Fondo no perforada  
Coperchio forato - Fondo forato

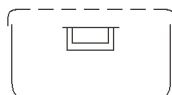

285 x 280 x 55 mm



**88.630.01** A  
**88.630.02** B  
**88.630.03** C  
**88.630.04** D  
**88.630.05** E  
**88.630.06** F

285 x 280 x 85 mm



**88.630.11** A  
**88.630.12** B  
**88.630.13** C  
**88.630.14** D  
**88.630.15** E  
**88.630.16** F

**88.631.11** A  
**88.631.12** B  
**88.631.13** C  
**88.631.14** D  
**88.631.15** E  
**88.631.16** F

Boden ungelocht  
Bottom non-perforated  
Fond non perforé  
Fondo no perforada  
Fondo non forato



**88.632.01** 285 x 280 x 55 mm  
**88.632.02** 285 x 280 x 85 mm

Boden gelocht  
Bottom perforated  
Fond perforé  
Fondo perforada  
Fondo forato



**88.632.03** 285 x 280 x 85 mm

Deckel gelocht  
Lid perforated  
Courvercle perforé  
Tapa perforada  
Coperchio forato

285 x 280 mm

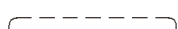

**88.632.11** A  
**88.632.12** B  
**88.632.13** C  
**88.632.14** D  
**88.632.15** E  
**88.632.10** F

## Flach-, Halb-, Container und Zubehör

Flat Half-Size-Containers and Accessories

Plat-, Semi-, Container et accessoires

Contenedores medianos y planos y accesorios

Piatti, Mezzi-, Container e accessori

**dimeda**<sup>®</sup>  
SURGICAL INSTRUMENTS

Siebkörbe Edelstahl  
Wire baskets, special steel  
Papiers grillagés en acier de haute qualité  
Cestillos de acero fino  
Cestelli in acciaio fino



**88.629.01** 255 x 245 x 30 mm  
**88.629.02** 255 x 245 x 50 mm

Siebboden  
Separate floors  
Fond du crible  
Cestas-cuerpos  
Fondo di Cestello



**88.629.11** 255 x 245 x 30 mm

Silikon-Noppenmatte  
Silicone Mats  
Tapis silicone  
Planchas granuladas de silicona  
Stuoia di silicone

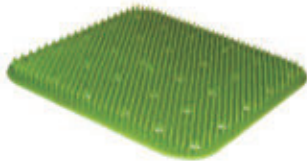

**88.695.21** 245 x 245 mm

Spannrahmen für Einschlagtücher  
Tension Clips for Towels  
Cadre tendeur à champs  
Marcos tensores para paños  
Telaio di fissaggio



**88.695.17** 255 x 255 mm

Einschlagtücher aus Baumwolle  
Wrapping drapes, cotton  
Champs, coton  
Paños de embalaje de algodón  
Telo, cotone



**88.695.04** 90 x 60 cm  
**88.695.05** 90 x 80 cm

Verschiedene Behälter / Different Containers / Boîtes diverses / Contenedores varios / Vassoi diversi



## Kleine Container und Zubehör

Small Containers and Accessories

Petit-Container et accessoires

Contenedores pequeños y accesorios

Piccoli container e accessori

Deckel gelocht - Boden ungelocht  
Lid perforated - Bottom non perforated  
Courvercle perforé - Fond non perforé  
Tapa perforada - Fondo no perforada  
Coperchio forato - Fondo non forato

Deckel gelocht - Boden gelocht  
Lid perforated - Bottom perforated  
Courvercle perforé - Fond perforé  
Tapa perforada - Fondo perforada  
Coperchio forato - Fondo forato

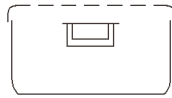

300 x 140 x 40 mm



88.640.01 A  
88.640.02 B  
88.640.03 C  
88.640.04 D  
88.640.05 E  
88.640.06 F

88.641.01 A  
88.641.02 B  
88.641.03 C  
88.641.04 D  
88.641.05 E  
88.641.06 F

300 x 140 x 70 mm



88.640.11 A  
88.640.12 B  
88.640.13 C  
88.640.14 D  
88.640.15 E  
88.640.16 F

88.641.11 A  
88.641.12 B  
88.641.13 C  
88.641.14 D  
88.641.15 E  
88.641.16 F

300 x 140 x 100 mm



88.640.21 A  
88.640.22 B  
88.640.23 C  
88.640.24 D  
88.640.25 E  
88.640.26 F

88.641.21 A  
88.641.22 B  
88.641.23 C  
88.641.24 D  
88.641.25 E  
88.641.26 F

Boden ungelocht  
Bottom non-perforated  
Fond non perforé  
Fondo no perforada  
Fondo non forato



88.642.01 300 x 140 x 40 mm  
88.642.02 300 x 140 x 70 mm  
88.642.03 300 x 140 x 100 mm

Boden gelocht  
Bottom perforated  
Fond perforé  
Fondo perforada  
Fondo forato



88.642.11 300 x 140 x 40 mm  
88.642.12 300 x 140 x 70 mm  
88.642.13 300 x 140 x 100 mm

## Kleine Container und Zubehör

Small Containers and Accessories  
Petit-Container et accessoires  
Contenedores pequeños y accesorios  
Piccoli container e accessori

**dimeda**<sup>®</sup>  
SURGICAL INSTRUMENTS

Deckel gelocht  
Lid perforated  
Courvercle perforé  
Tapa perforada  
Coperchio forato

300 x 140 mm



**88.642.21** A  
**88.642.22** B  
**88.642.23** C  
**88.642.24** D  
**88.642.25** E  
**88.642.26** F

Silikon-Noppenmatte  
Silicone Mats  
Tapis silicone  
Planchas granuladas de silicona  
Stuoia di silicone



**88.695.20** 270 x 125 mm

Spannrahmen für Einschlagtücher  
Tension Clips for Towels  
Cadre tendeur à champs  
Marcos tensores para paños  
Telaio di fissaggio



**88.695.18** 280 x 125 mm

Einschlagtücher aus Baumwolle  
Wrapping drapes, cotton  
Champs, coton  
Paños de embalaje de algodón  
Telo, cotone



**88.695.01** 60 x 40 cm

Verschiedene Behälter / Different Containers / Boîtes diverses / Contenedores varios / Vassoi diversi

## Spezial Container Set und Zubehör

Special Container Set and Accessories

Spécial Container Set et accessoires

Contenedores especiales y accesorios

Container speciale e accessori

Deckel gelocht - Boden gelocht  
Lid perforated - Bottom perforated  
Courvercle perforé - Fond perforé  
Tapa perforada - Fondo perforada  
Coperchio forato - Fondo forato



310 x 190 x 40 mm



**88.650.01** A

Boden gelocht  
Bottom perforated  
Fond perforé  
Fondo perforada  
Fondo forato



A

**88.650.11** 310 x 190 x 40 mm  
**88.650.12** 310 x 190 x 65 mm  
**88.650.13** 310 x 190 x 130 mm

310 x 190 x 65 mm



**88.650.02** A

Deckel gelocht  
Lid perforated  
Courvercle perforé  
Tapa perforada  
Coperchio forato

310 x 190 x 130 mm



**88.650.03** A



A

**88.650.21** 310 x 190 mm

Spannrahmen für Einschlagtücher  
Tension Clips for Towels  
Cadre tendeur à champs  
Marcos tensores para paños  
Telaio di fissaggio



**88.695.19** 310 x 190 mm

Einschlagtücher aus Baumwolle  
Wrapping drapes, cotton  
Champs, coton  
Paños de embalaje de algodón  
Telo, cotone



**88.695.01** 60 x 40 cm  
**88.695.01** 65 x 65 cm  
**88.695.01** 85 x 85 cm

## Spezial Container Set und Zubehör

Special Container Set and Accessories

Spécial Container Set et accessoires

Contenedores especiales y accesorios

Container speciale e accessori







**dimeda**<sup>®</sup>  
SURGICAL INSTRUMENTS

Deckel gelocht - Boden gelocht  
Lid perforated - Bottom perforated  
Couvercle perforé - Fond perforé  
Tapa perforada - Fondo perforada  
Coperchio forato - Fondo forato









300 x 138 x 65 mm



**88.660.01**  A  
**88.660.02**  B  
**88.660.03**  C  
**88.660.04**  D  
**88.660.05**  E  
**88.660.06**  F

500 x 155 x 75 mm



**88.660.11**  A  
**88.660.12**  B  
**88.660.13**  C  
**88.660.14**  D  
**88.660.15**  E  
**88.660.16**  F

Deckel gelocht - Boden gelocht  
Lid perforated - Bottom perforated  
Couvercle perforé - Fond perforé  
Tapa perforada - Fondo perforada  
Coperchio forato - Fondo forato



250 x 60 x 50 mm



**88.660.21**  A

450 x 70 x 70 mm



**88.660.22**  A

Verschiedene Behälter / Different Containers / Boîtes diverses / Contenedores varios / Vassoi diversi

## Spezial Container Set und Zubehör

Special Container Set and Accessories

Spécial Container Set et accessoires







Contenedores especiales y accesorios

Container speciale e accessori

Deckel ungelocht - Boden ungelocht  
Lid non perforated - Bottom non perforated  
Courvercle non perforé - Fond non perforé  
Tapa no perforada - Fondo no perforada  
Coperchio non-forato - Fondo non forato

285 x 280 x 100 mm





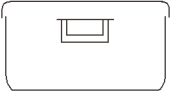



**88.670.01**  A  
**88.670.02**  B  
**88.670.03**  C  
**88.670.04**  D  
**88.670.05**  E  
**88.670.06**  F



Deckel ungelocht - Boden ungelocht  
Lid non perforated - Bottom non perforated  
Courvercle non perforé - Fond non perforé  
Tapa no perforada - Fondo no perforada  
Coperchio non-forato - Fondo non forato

285 x 280 x 150 mm



**88.670.11**  A  
**88.670.12**  B  
**88.670.13**  C  
**88.670.14**  D  
**88.670.15**  E  
**88.670.16**  F

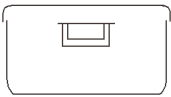

Boden ungelocht  
Bottom non-perforated  
Fond non perforé  
Fondo no perforada  
Fondo non forato









**88.624.01** 285 x 280 x 100 mm  
**88.624.03** 285 x 280 x 150 mm



Deckel ungelocht  
Lid non perforated  
Courvercle non perforé  
Tapa no perforada  
Coperchio non-forato

285 x 280 mm



**88.670.51**  A  
**88.670.22**  B  
**88.670.53**  C  
**88.670.54**  D  
**88.670.55**  E  
**88.670.56**  F



## Spezial Container Set und Zubehör







Special Container Set and Accessories  
Spécial Container Set et accessoires  
Contenedores especiales y accesorios  
Container speciale e accessori

**dimeda**<sup>®</sup>  
SURGICAL INSTRUMENTS

Deckel ungelocht - Boden ungelocht  
Lid non perforated - Bottom non perforated  
Courvercle non perforé - Fond non perforé  
Tapa no perforada - Fondo no perforada  
Coperchio non-forato - Fondo non forato

580 x 280 x 150 mm



**88.670.21**  A  
**88.670.22**  B  
**88.670.23**  C  
**88.670.24**  D  
**88.670.25**  E  
**88.670.26**  F

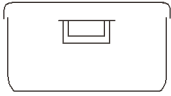

Boden ungelocht  
Bottom non-perforated  
Fond non perforé  
Fondo no perforada  
Fondo non forato





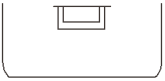



**88.604.30** 580 x 280 x 150 mm



Deckel ungelocht  
Lid non perforated  
Courvercle non perforé  
Tapa no perforada  
Coperchio non-forato

580 x 280 mm



**88.670.41**  A  
**88.670.42**  B  
**88.670.43**  C  
**88.670.44**  D  
**88.670.45**  E  
**88.670.46**  F



## Zubehör

Accessories  
Accessoires  
Accesorios  
Accessori

Bürstenspender  
für 20 Bürsten (ohne Bürsten),  
mit Aufhängevorrichtung

285 x 280 x 85 mm

Brush dispenser  
for 20 Brushes (without brushes)  
with suspension hook

Distruteur  
pour 20 brosses (sans brosses),  
avec crochet de suspension

Distribuidor de cepillos  
para 20 cepillos (sin cepillos),  
completo con gancho de suspensión

Distributore  
per 20 spazzole (spazzole escluse),  
con gancio di sospensione



**88.680.01** A  
**88.680.02** B  
**88.680.03** C  
**88.680.04** D  
**88.680.05** E  
**88.680.06** F

Handwaschbürste,  
über 400 Mal im Autoklaven  
sterilisierbar

Nailbrush, more than  
400 times autoclavable

Brosse à de ongles,  
stérilisable à l'autoclave 400 fois ou plus

Cepillo de uñas,  
esterilizable más de 400 veces en autoclave

Spazzola per unghie,  
sterilizzabile più di 400 volte in  
autoclave



**74.398.00**



Einmal-Papierfilter  
Single use paper filters  
Filtres papiers à usage unique  
Filtros de papel de un solo uso  
Filtri di carta monouso

Verpackungseinheit 100 Stück  
Packing unit 100 pieces  
Boîtes de 100 pièces  
Cajas con 100 piezas  
Unità di 100 pezzi



**88.690.01**

Für 1/1, 3/4 und halbe Container  
For 1/1, 3/4 and Half-Size Containers  
Pour 1/1, 3/4 et Semi-Container  
Para contenedores grandes y medianos  
Per grossi container e mezzo container

Langzeit-Textilfilter  
Long-term textile filters  
Filtres textiles longue  
Filtros de tejido de larga duración  
Filtri tessili a lunga durata

Verpackungseinheit 1 Stück  
Packing unit 1 pieces  
Boîtes de 1 pièces  
Cajas con 1 piezas  
Unità di 1 pezzi



**88.690.02**

Für 1/1, 3/4 und halbe Container  
For 1/1, 3/4 and Half-Size Containers  
Pour 1/1, 3/4 et Semi-Container  
Para contenedores grandes y medianos  
Per grossi container e mezzo container



**88.690.03**

Für Klein-Set Container (Mini)  
For small Container Sets (Mini)  
Pour petit-Set Container (Mini)  
Para contenedores pequeños (Mini)  
Per piccoli container (Mini)



**88.690.04**

Für Klein-Set Container (Mini)  
For small Container Sets (Mini)  
Pour petit-Set Container (Mini)  
Para contenedores pequeños (Mini)  
Per piccoli container (Mini)



**88.690.05**

Für Klein-Set Container (Dental)  
For small Container Sets (Dental)  
Pour petit-Set Container (Dental)  
Para contenedores pequeños (Dental)  
Per piccoli container (Dental)



**88.690.06**

Für Klein-Set Container (Dental)  
For small Container Sets (Dental)  
Pour petit-Set Container (Dental)  
Para contenedores pequeños (Dental)  
Per piccoli container (Dental)

Filterspender  
Filter Dispenser  
Pièce à rangement  
Contenedor de filtros  
Distributore filtri



**88.690.07**

## Zubehör

Accessories  
Accessoires  
Accesorios  
Accessori

Filterblech  
Filter sheet  
Dispositif d'arrêt filtre  
Dispositivo de sujetar filtro  
Fermafiltro



**88.690.08**

Für Einmal-Papierfilter  
For single use paper filters  
Pour filtres papiers à usage unique  
Para filtros de papel de un solo uso  
Per filtri di carta per un solo uso

**88.690.09**

Für Langzeit-TExtilfilter  
For long-term textile filters  
Pour filtres textiles longue durée  
Para filtros de tejido de larga duración  
Per filtri tessili a lunga durata

Indikatoretiketten aus Papier  
Indications labels, made of paper  
Etiquettes-témions, en papier  
Etiquetas indicadoras de papel  
Etichette di identificazione in carta

Verpackungseinheit 100 Stück  
Packing unit 100 pieces  
Boîtes de 100 pièces  
Cajas con 100 piezas  
Unità di 100 pezzi

**88.690.10**

Für 1/1, 3/4 und halbe Container  
For 1/1, 3/4 and Half-Size Containers  
Pour 1/1, 3/4 et Semi-Container  
Para contenedores grandes y medianos  
Per grossi container e mezzo container

**88.690.11**

Für Klein-Set Container (Mini und Dental)  
For small Container Sets (Mini and Dental)  
Pour petit-Set Container (Mini et Dental)  
Para contenedores pequeños (Mini de Dental)  
Per piccoli container (Mini e Dental)

Verschußblomben aus Kunststoff  
Plastic Security Seals  
Plombs de verrouillage en matière plastique  
Precintos de plastico  
Piombi in materia plastica







Verpackungseinheit 100 Stück  
Packing unit 100 pieces  
Boîtes de 100 pièces  
Cajas con 100 piezas  
Unità di 100 pezzi



**88.690.12**

Farbige Kennzeichnungsschilder (ohne Gravur)  
Coloured identification labels (without engraving)  
Étiquettes d'identification en couleur (sans gravure)  
Placas de identificación de color (sin grabación)  
Targhette di identificazione colorate (senza incisione)

Gravur auf Anfrage  
Engraving as per request  
Gravure par demande  
Grabación según su deseo  
Incisione su richiesta

**88.690.21**  A  
**88.690.22**  B  
**88.690.23**  C  
**88.690.24**  D  
**88.690.25**  E  
**88.690.26**  F

Sortiermagazin für Kennzeichnungsschilder  
Dispenser for identification labels  
Magasin à étiquettes pour d'identification  
Cajetín clasificador de identificación  
Cassetta da selezione targhette di identificazione

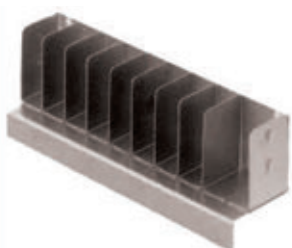

**88.690.29**

## Zubehör

Accessories  
Accessoires  
Accesorios  
Accessori

**dimeda**<sup>®</sup>  
SURGICAL INSTRUMENTS

Trennblechhaltestift zur Aufnahme von Trennblechen  
Fixing bolt for divisions  
Plot de cloisonnement pour maintenir les cloisonnements  
Piñon para separadores  
Perno di fissaggio per separatori



**88.690.31**



Sortierspieß zur Fixierung von Instrumenten  
Fixation shaft for instruments  
Attache de fixation pour la fixation d'instruments  
Piñon para fijar instrumental  
Perno di fissaggio per strumenti



**88.690.32**

Trennbleche  
Divisions  
Séparateurs  
Separadores  
Dvisori per cesti in rete



**88.690.33** 50 x 20 mm  
**88.680.34** 130 x 20 mm  
**88.690.35** 225 x 20 mm  
**88.690.36** 460 x 20 mm

Gleitschieber  
Sliders  
Curseur  
Corredor  
Cursore



**88.690.41**



Schiene für  
Gleitschieber  
Rail for Sliders  
Éclisse pour le curseur  
Riel para corredor  
Sbarra per cursore



**88.690.42** 232 mm  
**88.680.43** 471 mm

Winkelblech (Anschlagrahmen)  
Angled stopper  
Separateur en angle  
Separador ángulado  
Sbarra angolata



**88.690.44** 232 mm  
**88.680.45** 471 mm

Spiralfeder mit Halterung  
Spiral holding support  
Support à ressorts spiraux  
Apoyo con resorte espiral  
Supporto a molle



**88.690.46**

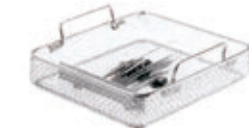

Doppelte-Spiralfeder mit Halterung  
Spiral holding support double  
Support à ressorts spiraux double  
Apoyo don resorte espiral doble  
Supporto doppio a molle



**88.690.47**

Fixierklammern für Tücher  
Fixation clamps for drapes  
Clips à champs  
Clip de fijación para paños  
Clips di fissaggio per teli



**88.690.48**



Verschiedene Behälter / Different Containers / Boîtes diverses / Contenedores varios / Vassoi diversi





Elektrochirurgie - Geräte und Instrumente  
Electrosurgery - units and instruments  
Électrochirurgie - appareils et instruments  
Electrocirugía - Aparatos e Instrumentos  
Elettrochirurgia - Apparecchi e strumenti

**Spezialkatalog**

Special catalog  
Catalogue spécial  
Catálogo especial  
Catalog speciale

**dimeda**<sup>®</sup>  
SURGICAL INSTRUMENTS



Elektrochirurgie - Geräte und Instrumente  
Electrosurgery - units and instruments  
Électrochirurgie - appareils et instruments  
Electrocirugía - Aparatos e Instrumentos  
Elettrochirurgia - Apparecchi e strumenti



Endoskopie  
Endoscopy  
Endoscopie  
Endoscopio  
Endoscopia



**Spezialkatalog**

Special catalog  
Catalogue spécial  
Catálogo especial  
Catalog speciale

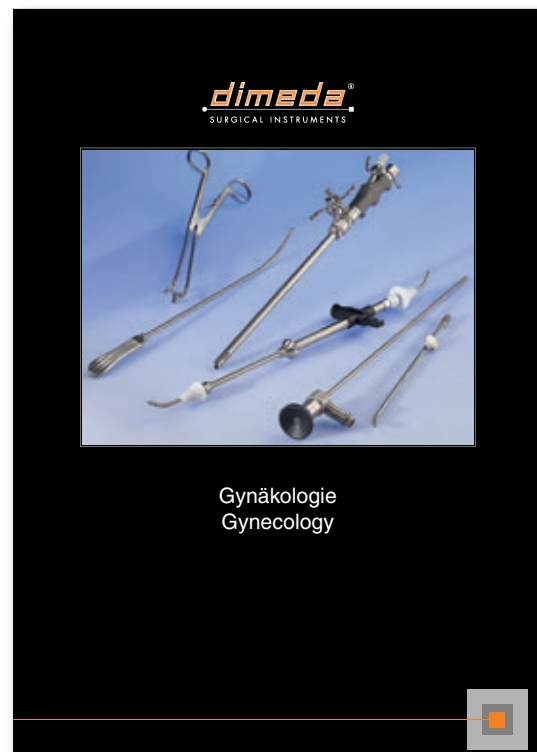
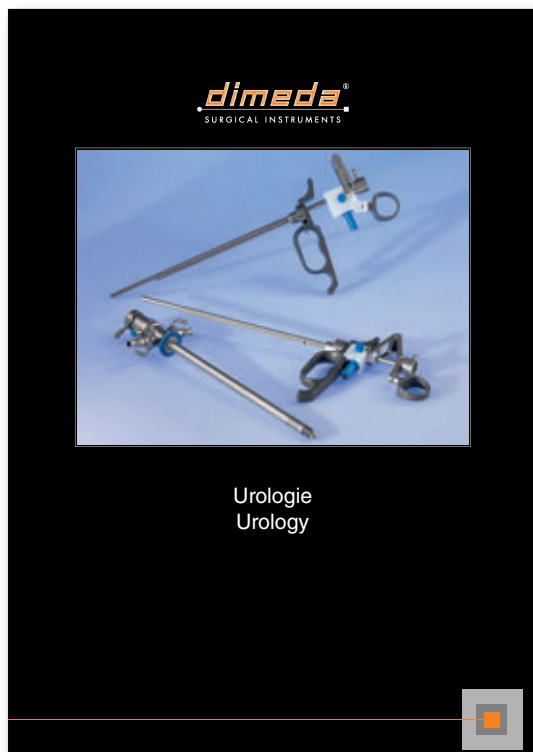

Inhaltsverzeichnis  
Index  
Index  
Indice alfabético  
Indice alphabético

## Inhaltsverzeichnis

Index  
Index  
Indice alfabético  
Indice alphabético

### A

Abziehstein ARKANSAS .....	06-19
Adenotom LAFORCE.....	46-19
ADLERKREUTZ Pinzette.....	10-04
ADSON Arterien Klemme.....	12-09
ADSON BABY Arterien Klemme.....	12-09
ADSON BABY Wund Sperrer.....	18-15
ADSON-BROWN Pinzette.....	10-03
ADSON	
Elevatorien .....	32-21
Hohlmeißel Zange .....	32-03
Mikro Pinzette .....	10-03
Nadelhalter.....	24-04
Pinzette.....	10-03
Wund Sperrer .....	18-15
AEBLI Hornhaut Schere .....	08-22
ALAN-PARKS Mastdarm Spreizer .....	68-03
ALBEE Fräser .....	33-07
ALEXANDER	
Flachmeißel.....	32-14
Hohlmeißel.....	32-14
Probeexcisions Zange.....	70-42
Raspatorien .....	32-19
ALLIS-ADAIR Darmfaß Zange .....	64-02
ALLIS-Baby Darmfaß Zange .....	64-02
ALLIS Darmfaß Zange .....	64-02
ALM Wund Sperrer .....	18-14
ALVIS Fremdkörper Kürette .....	42-06
Amniotom BEACHAM.....	70-39
Amputations Messer .....	06-16
Anatomische Skalpell.....	06-15
ANDREWS-PINCHON Sauger.....	04-03
ANDREW Zungen Spatel .....	48-02
Anoskop	
HIRSCHMANN Anoskop .....	68-04
IVES-FANSLER Anoskop .....	68-04
Apparat	
BUNNELL Handbohr Apparat.....	33-05
Handbohr Apparat.....	33-05
Handbohr Apparat mit Jacobs-Fütter.....	33-06
HUDSON Handbohr Apparat .....	33-04
KIRSCHNER Handbohr Apparat .....	33-05
MOORE Handbohr Apparat .....	33-04
PETZ Magen- und Darmnääh Apparat.....	64-09
RALK Handbohr Apparat .....	33-05
STILLE Handbohr Apparat .....	33-04
STILLE-SHERMAN Handbohr Apparat.....	33-04
ARCHER Splitter Pinzette .....	10-06
ARKANSAS Abziehstein .....	06-19
ARLT Draht Schlinge.....	42-08
ARRUGA	
Extraktion Haken.....	42-06
Kapsel Pinzette .....	43-04
Nadelhalter.....	24-06
Netzhaut Ablös Schützer .....	42-08
Sperr Elevator.....	42-02
ASCH Septum Zange.....	46-18
AUFRIEHT Nasenrücken Haken .....	46-17
Aufsatz MILLIN Kaltlicht.....	66-05
AUVARD Vaginal Spekulum .....	70-19
AXENFELD Chazalazion Löffel.....	42-07
AYER Chalazion Pinzette .....	43-06

### B

BABCOCK Darmfaß Zange.....	64-02
BABINSKY Perkussions Hammer.....	02-07
BACKHAUS-CLIP Schlauchhalter	
Tuch Klemme.....	14-03
BACKHAUS KOCHER Tuch Klemme .....	14-02
BACKHAUS Tuch Klemme .....	14-02
BAGGISH Probeexcisions Zange .....	70-45
BAINBRIDGE Arterien Klemme.....	12-14
BAKES Gallenkanal Dilatatoren .....	62-06
BALFOUR Baby Bauch Deckenhalter.....	18-22
BALFOUR	
Bauch Deckenhalter.....	18-22
Valve .....	18-22

BALL AND SOCKET Tuch Klemme .....	14-04
BALLENGER	
Schwing Messer .....	46-11
Septum Elevatorium.....	46-12
Tonsillen Fass Zange .....	50-04
Bandmass.....	02-08
Band PARHAM.....	32-11
BANGERTER Cycloclialyse Spatel.....	42-08
BARANY Lärrtrommel .....	44-04
BARBARA	
Häkchen .....	44-14
Nadel.....	44-14
Pick .....	44-14 bis 44-15
BARKAN Goniotomie Messer .....	42-05
BARNHILL Ring Messer .....	46-19
BARRAQUER KATZIN Iris Pinzette .....	42-13
BARRAQUER Colibri Iris Pinzette.....	42-13
BARRAQUER	
Cilien Pinzette .....	43-08
Colibri Schere .....	09-04
BARRAQUER Colibri Sperr Elevator.....	42-02
BARRAQUER	
Fixier Pinzette .....	43-03
Keratoplastik Messer .....	42-05
Nadelhalter.....	24-07
Vorderkammer Pinzette .....	43-02
BARRETT Haken Zange .....	70-32
BARR Rektal Spekulum .....	68-02
BARTON	
Geburts Zange .....	72-04
Zug Hebel .....	72-04
BAUMGARTNER Nadelhalter .....	24-02
BEACHAM Amniotom .....	70-39
Becher .....	88-10
Medizin Becher .....	88-07
Meß Becher .....	88-07
Sputum Becher.....	88-06
Becken	
Plazenta Becken .....	88-06
Stech Becken .....	88-06
Becken Zirkel	
COLLIN Becken Zirkel .....	72-06
COLLYER Becken Zirkel.....	72-06
MARTIN Becken Zirkel.....	72-06
BECKER Cystotom .....	42-06
BECKMANN-ADSON Wund Sperrer.....	18-15
BECKMANN-EATON Wund Sperrer.....	18-16
BECKMANN Ring Messer .....	46-19
BECKMANN Wund Sperrer .....	18-16
BEEBEE Draht und Blech Schere.....	08-43
BEER Cilien Pinzette.....	43-08
BEESON Gips Spreizer.....	30-03
BELLUCCI Ohr Mikro Schere.....	44-09
BENGOLEA Arterien Klemme .....	12-09
BENNETT Knochen Hebel .....	32-22
BERENS Lanzen Messer .....	42-04
BERGMANN FOERSTER Schwamm Zange.....	16-10
BERGMANN	
Gips Säge .....	30-02
Verband Schere .....	08-46
BERKE Muskel Pinzette .....	43-02
BERLIND-AUVARD Vaginal Spekulum .....	70-19
BERLINER Perkussions Hammer .....	02-07
BERNHARD Tuch Klemme.....	14-05
BERTILLON Schädel Messzirkel .....	02-08
BEST Darm Klemme .....	64-06
Besteck	
Autopsie Besteck.....	32-17
Mini Naht Besteck.....	26-08
Standard Naht Besteck .....	26-08
BEUSE Schere .....	08-26
BEYER	
Hohlmeißel Zange .....	32-04
Stanze .....	46-08
BILLEAU Ohr Schlinge.....	44-07
BILL Zug Hebel.....	72-05
BIRCHER-GANSKE Knochenhalte Zange .....	32-10
BIRCHER Meniskotom .....	32-24
BISHOP-HARMAN Iris Pinzette.....	42-14

BLAKE	
Gallenstein Zange.....	62-03
Uterus Kürette .....	70-48
Bleihand.....	32-11
BLOHMKE Tonsillen Fass Zange.....	50-04
BLOUNT	
Knie Haken .....	32-24
Knochen Hebel .....	32-24
BLUMENTHAL Hohlmeißel Zange.....	32-02
Blutdruckmesser.....	02-02
BODENHAMMER Rektal Spekulum.....	68-02
BOEHLER Extension Bügel .....	33-10
BOERMA Geburts Zange .....	72-04
BOETTCHER Tonsillen Schere.....	08-27
BÖHLER	
Hohlmeißel Zange .....	32-04
Knochensplitter Zange .....	32-06
Bohrdrähte KIRSCHNER .....	33-09
Bohrer	
Gewinde Bohrer .....	33-15
McKENZIE Bohrer.....	33-04
BONACCOLTO Strabismus Pinzette .....	42-14
BONNEY Schwamm Zange .....	16-08
BONN	
Iris Pinzette.....	42-15
Spül Kanüle.....	43-07
BONN TITAN Iris Pinzette .....	42-15
BORCHARDT Fräser .....	33-07
BOSE	
Tracheal Häkchen .....	54-02
Tracheal Sperre .....	54-02
BOUCHERON Ohr Spekula .....	44-02
Bougie	
COXETER Harnröhren Bougie.....	66-17
DITTEL Harnröhren Bougie.....	66-18 bis 66-19
FILIFORM Harnröhren Bougie .....	66-12
GUYON Harnröhren Bougie .....	66-14 bis 66-15
VAN BUREN Harnröhren Bougie .....	66-13
Bougie	
WALTHER Harnröhren Bougie.....	66-17
BOWLES Stethoskop.....	02-06
BOWMAN	
Discisions Messer .....	42-04
Discisions Nadel.....	42-05
Sperr Elevator.....	42-02
Tränenkanal Sonde .....	42-10
BOYNTON Nadelhalter.....	24-06
BOZEMANN-DOUGLAS Tupfer Zange .....	16-13
BOZEMANN	
Nadelhalter .....	24-03
Tupfer Zange .....	16-13
BRAITHWAITE Dermatome .....	06-22
BRAUN	
Dekapitations Haken .....	72-09
Haken Zange .....	70-31, 70-34
Kranioplast.....	72-09
BRAUN-STADLER Episiotomie	
Schere .....	07-22, 08-34
BRAUN	
Uterus Depressor.....	70-39
Vaginal Spekulum .....	70-16
BREISKY Vaginal Spekulum.....	70-20
BROWN Pinzette .....	10-03
BRUENINGS	
Kehlkopf Zange .....	52-03
Nasen scharfe Zange.....	46-05
Ohr Spekula.....	44-02
Septatom .....	46-11
Tonsillen Schnürer .....	50-04
Verlängerung Rohr .....	52-03
Zungen Spatel .....	48-02
BRUNETTI Wirbelsäulenmeißel.....	32-17
BRUNNER	
Darm Klemme.....	64-06
Fuehrungshohl Sonde .....	26-04
BRUNS	
Gips Schere .....	08-48
Scharfe Löffel.....	32-12 bis 32-13
BRYANT Schwamm Zange .....	16-11

## Inhaltsverzeichnis

Index  
Index  
Indice alfabético  
Indice alphabético

BUCHWALD Zungen Spatel.....	48-02
BUCK	
Fremdkörper Hebel .....	44-08
Ligatur Schere.....	08-40
Ohr Kürette .....	44-05
Perkussions Hammer.....	02-07
Bügel	
BOEHLER Extension Bügel .....	33-10
Extension Bügel .....	33-10
KIRSCHNER Extension Bügel .....	33-10
BUIE Saug Kanüle .....	68-05
BUMM	
Uterus-Faß Zange.....	70-38
Uterus Kürette .....	70-49 bis 70-50
BUNGE Exenterations Löffel.....	42-07
BUNNELL	
Handbohr Apparat.....	33-05
Sehnen Stripper .....	32-25
BUNT Sterilisier Klammer .....	28-02
BURCH Fixier Gabel.....	42-05
BURKE-Baby Probeexcisions Zange .....	70-44
BURKE Probeexcisions Zange .....	70-44
BUSCH Nabelschnur Schere.....	08-34
<b>C</b>	
CARMALT Splitter Pinzette .....	10-06
CARPENTER Tonsillen Messer .....	50-02
CASPAR	
Cervical Wirbelsäule Wund Spreizer ....	18-18
ges. Wirbelsäule Valve .....	18-19
ges. Wirbelsäule Wund Sperrer .....	18-19
Mikro Skalpellgriff.....	06-12
Muskelab Spreizer .....	18-20
Valve .....	18-20
Wund Sperrer .....	18-20
CASTROVIEJO	
Cyclodialyse Spatel.....	42-08 bis 42-09
Fixier Pinzette .....	43-03
Hornhaut Schere .....	09-06
Hornhaut Trephine .....	43-07
Iridectomie Schere .....	09-05
Kapsel Pinzette .....	43-04
Klingenbrecher .....	06-14
Kompass Markier .....	42-09
Lanzen Messer.....	42-04
Nadelhalter .....	24-07
Naht Pinzette.....	43-05
Sperr Elevatorium.....	42-03
Tränenkanal Dilatator .....	42-10
CATLIN Amputations Messer .....	06-16
CHAPUT Arterien Klemme .....	12-08
CHARRIERE	
Amputations Säge.....	33-03
Sägeblatt .....	33-03
CHEATLE Sterilisier Zange .....	28-02
CHERON Tupfer Zange .....	16-12
CHEVALIER-JACKSON Kehlkopf Zange .....	52-04
CHILDE Wundklammer Zange .....	26-07
CINELLI Nasenplastik Meißel.....	46-13
CITELLI Stanze.....	46-08
CLARK Sperr Elevator .....	42-02
CLAR	
Mini Stirnlampe .....	02-05
Stirnlampe.....	02-05
CLEVELAND Hohlmeißel Zange .....	32-02
CLOWARD Wund Sperrer .....	18-17
COAKLEY	
Antrum Kürette.....	46-18
Trokar.....	22-02
COLLIER Nadelhalter .....	24-02
COLLIN	
Arterien Klemme .....	12-08
Bauch Deckenhalter.....	18-24 bis 18-25
Becken Zirkel.....	72-06
Becken Zirkel.....	72-06
COLLIN-DUVAL Pinzette.....	10-04
COLLIN	
Dynamometer .....	02-03

Hammer.....	32-18
COLLIN-HARTMANN Wund Haken.....	18-03
COLLIN Nabelschnur Klemme.....	72-06
COLLIN-POZZI Haken Zange.....	70-32
COLLIN	
Skalpell Griff.....	06-08
Tupfer Zange.....	16-11
Uterus-Faß Zange.....	70-37
Uterus Sonde.....	70-39
Vaginal Spekulum .....	70-04
Wundklammer Zange .....	26-07
Zungen Zange.....	48-03
COLLYER Becken Zirkel .....	72-06
COLVER Tonsillen Fass Zange .....	50-03
CONNIN-AMSLER Markier Instrument .....	42-09
CONVERSE Nasen Messer.....	46-10
COOLEY Atraumatische Pinzette .....	11-03
COOPER Unterbindungs Nadel .....	26-02
CORDES Kehlkopf Zange.....	52-03
CORWIN Tonsillen Kompressorium.....	50-04
CORYLLOS (Thorax) Wund Haken .....	18-13
COTTLE-KAZANJIAN	
Knochensplitter Zange.....	32-06
COTTLE	
Nasen Messer .....	46-10
Nasenplastik Meißel .....	46-13
Nasenrücken Haken .....	46-17
Nasen Schere .....	07-18, 08-25
Nasen Spekulum.....	46-03
COTTLE-NEIVERT Nasenrücken Haken .....	46-17
COTTLE	
Periost Elevatorium .....	46-12
Septum Elevatorium .....	46-12
COXETER Harnröhren Bougie .....	66-17
CRAFOORD	
Arterien Bronchus Klemme .....	12-12
Lungen und Thorax Schere.....	08-36
CREDO Hornhaut Hobel .....	74-03
CRILE Arterien Klemme.....	12-05
CRILE-MURRAY Nadelhalter .....	24-02
CRILE Nadelhalter .....	24-04
CRILE-RANKIN Arterien Klemme.....	12-05
CRILE TITAN Arterien Klemme .....	12-05
CRILE-WOOD Nadelhalter .....	24-02
CRILE Wund Haken .....	18-02
CRITCHETT Sperr Elevator .....	42-02
CULLER Iris Spatel .....	42-08
CUSCO Vaginal Spekulum .....	70-04 bis 70-06
CUSHING Flachbohrer .....	33-04
CUSHING	
Pinzette.....	10-03
Wund Haken.....	18-07
CUZZI Plazentar und Abortus Löffel .....	72-08
Cystotom	
BECKER .....	42-06
GRAEFE .....	42-06
CZERNY	
Gallenstein Zange.....	62-03
Haken Zange .....	70-34
Rektal Spekulum.....	68-02
<b>D</b>	
DANDY	
Arterien Klemme.....	12-07
Neurochirurgische Schere .....	08-36
DARLING Wund Sperrer .....	18-17
Darm Schere .....	08-39
DARTIGUES Uterus-Faß Zange .....	70-37
DASTOOR	
Kapsel Sauger .....	42-09
Strabismus Pinzette.....	42-14
DAVIDSON (Scapula) Wund Haken .....	18-13
DAVIEL Star Löffel .....	42-07
DAVIS-BOYLE Mund Sperrer .....	48-04
DAVIS	
Fremdkörper Nadel.....	42-05
Sterilisier Zange .....	28-02
DAY Ohr Häkchen.....	44-07

DEAN	
Iris Messer .....	42-04
Tonsillen Schere .....	08-26
DEAVER Grip Wund Haken .....	18-05
DEAVER	
Schere .....	07-05, 08-06
Wund Haken.....	18-05
DE BAKEY Atraumatische Bulldog Klemme ..	12-02
DE BAKEY Atraumatische Pinzette .....	11-03
DE BAKEY Gefäß Schere .....	08-30
DE BAKEY Nadelhalter .....	24-03
DE BAKEY Sauger .....	04-04
Deckenhalter (Bauch)	
BALFOUR Baby Bauch Deckenhalter ....	18-22
BALFOUR Bauch Deckenhalter.....	18-22
COLLIN Bauch Deckenhalter.....	18-24 bis 18-25
Deckenhalter (Bauch)	
GELPI Bauch Deckenhalter .....	18-24
GOSSET Bauch Deckenhalter .....	18-21
KIRSCHNER Bauch Deckenhalter .....	18-23
O'SULLIVAN-O'CONNOR	
Bauch Deckenhalter .....	18-21
RIGBY Bauch Deckenhalter .....	18-24
DEJERINE Perkussions Hammer .....	02-07
De LEE Geburts Zange .....	72-02
De MARTEL-WOLFSON	
Anastomosen Klemme .....	64-07
DENHART Mund Sperrer.....	48-03
Depressor	
BRAUN Uterus.....	70-39
SIMS Uterus .....	70-39
DERF Nadelhalter .....	24-02
Dermatom	
BRAITHWAITE Dermatom .....	06-22
Ersatz Klinge .....	06-21
HUMBY Dermatom .....	06-20
SCHINK Dermatom .....	06-21
SILVER Dermatom .....	06-20
WATSON Dermatom .....	06-22
DESCHAMPS Unterbindungs Nadel .....	26-02
DESJARDINS	
Gallenkanal Klemme .....	12-15
Gallenstein Löffel .....	62-08
Gallenstein Sonde.....	62-05
Gallenstein Zange.....	62-02
DESMARRES	
Chalazion Pinzette .....	43-06
Wund Haken.....	18-07
DEUTSCHMANN Star Messer .....	42-03
DEWEY Geburts Zange,	
mit Achsenzugvorrichtung .....	72-05
Diagnostik Besteck.....	02-04
DIAMANT Draht Schneider .....	33-12
DIEFFENBACH Gefäß Bulldog Klemme .....	12-03
DIETER Hammerkopf Stanze .....	44-10
DIETHRICH	
Gefäß Nadelhalter.....	24-06
Gefäß Schere .....	08-29
Dilatator	
BAKES Gallenkanal Dilatatoren .....	62-06
CASTROVIEJO Tränenkanal Dilatator ...	42-10
GOODELL Uterus Dilatator .....	70-30
HANK Uterus Dilatator .....	70-28
HEGAR Uterus Dilatator .....	70-24 bis 70-27
LABORDE Tracheal Dilatator.....	54-02
PRATT Uterus Dilatator .....	70-29
SIMS Uterus Dilatator .....	70-30
TROUSSEAU Tracheal Dilatator .....	54-02
WILDER Tränenkanal Dilatator .....	42-10
WYLIE Uterus Dilatator .....	70-30
ZIEGLER Tränenkanal Dilatator .....	42-10
DIMEDA Abfall Zange .....	28-03
DIMEDA Alu Stimmgabel .....	44-03
DIMEDA	
Augen Magnet .....	43-08
Fingerring Säge .....	33-03
Klingenbrecher .....	06-14
Verbands Schere .....	08-46
Watteträger .....	20-03

## Inhaltsverzeichnis

Index  
Index  
Indice alfabético  
Indice alphabético

Wund Sperrer	18-14
DINGMANN Knochenhalte Zange	32-10
Dissektor	
FISCH Dissektor	44-15
GREEN Hornhaut Dissektor	42-06
HURD Tonsillen Dissektor	50-02
PATON Hornhaut Dissektor	42-05
DITTEL	
Harnröhren Bougie	66-18 bis 66-19
Katheter Spanner	66-11
DIX	
Flachmeißel Nadel	42-09
Fremdkörper Flachmeißel	42-06
Dose	
Nadel Dose	88-02
SAUERBRUCH Nadel Dose	88-02
DOUGLAS	
Cilien Pinzette	43-08
Trokar	22-02
DOYEN-Baby Darm Klemme	64-03
DOYEN	
Darm Klemme	64-03
Fräser	33-07
Gynäkologische Schere	08-33
DOYEN-JANSEN Mund Sperrer	48-03
DOYEN	
Myom Heber	70-46
Rippen Raspatorien	32-20
Sonde	20-02
Tuch Klemme	14-05
Uterus-Polypen Zange	70-36
Vaginal Spekulum	70-18, 70-20
Wund Haken	18-12
Dreher	
LANE Schrauben Dreher	33-14
Schrauben Dreher	33-14 bis 33-15
WILLIAMS Schrauben Dreher	33-14
DUBOIS Gynäkologische Schere	08-33
DUPLAY	
Haken Zange	70-31
Tupfer Zange	16-14
Duplex Stethoskop	02-06
DUPUY-WEISS Tonsillen Nadel	50-03
DUVAL	
Darmfaß Zange	64-03
Pinzette	10-04
Dynamometer COLLIN	02-03

## E

ECHLIN Hohlmeißel Zange	32-05
Einschläger	33-12
Elevator	
ARRUGA Sperr Elevator	42-02
BARRAQUER Colibri Sperr Elevator	42-02
BOWMAN Sperr Elevator	42-02
CASTROVIEJO Sperr Elevator	42-03
CLARK Sperr Elevator	42-02
CRITCHETT Sperr Elevator	42-02
GOLDSTEIN Sperr Elevator	42-03
GRAEFE Sperr Elevator	42-02
HENKE Tonsillen Elevator	50-02
Elevatorien	
ADSON Elevatorien	32-21
KEY Elevatorien	32-21
LANGENBECK Elevatorien	32-21
McDONALD Elevatorien	32-22
MURPHY-LANE Elevatorien	32-22
WATSON-CHEYNE Elevatorien	32-22
Elevatorium	
BALLENGER Septum Elevatorium	46-12
COTTLE Perioest Elevatorium	46-12
COTTLE Septum Elevatorium	46-12
FREER Septum Elevatorium	46-11
HAJEK-BALLENGER Septum Elevatorium	46-12
JOSEPH Perioest Elevatorium	46-12
KILLIAN Septum Elevatorium	46-12
LEMPERT Elevatorium	44-15
McKENTY Septum Elevatorium	46-11

ROGER Septum Elevatorium	46-11
Elevator	
LANCASTER Sperr Elevator	42-03
LISTER-BURCH Sperr Elevator	42-02
MELLINGER-AXENFELD Sperr Elevator	42-02
MELLINGER Sperr Elevator	42-02
MUELLER Sperr Elevator	42-03
MURDOCK Sperr Elevator	42-02
PARK Sperr Elevator	42-03
SMITH Sperr Elevator	42-02
STEVENSON Sperr Elevator	42-03
WEEK Sperr Elevator	42-02
WILLIAMS Sperr Elevator	42-02
ZIEGLER Sperr Elevator	42-03
ELLIOT	
Geburts Zange	72-02
Hornhaut Trephine	43-08
ELLIS Fremdkörper Hohlmeißel	42-06
ELSAESSER Nieren Fistel Zange	62-13
ELSCHNIG	
Cyclodialyse Spatel	42-08
Fixier Pinzette	43-03
Hornhaut Messer	42-05
Kapsel Pinzette	43-04
EMMET Fistel Haken	70-46
ENGEL Gips Säge	30-02
EPPENDORFER-KEVORKIAN	
Probeexcisions Zange	70-46
EPPENDORFER	
Probeexcisions Zange	70-45 bis 70-46
EPPENDORFER TISCHLER-MORGAN	
Probeexcisions Zange	70-46
ESMARCH	
Gips Messer	30-04
Verband Schere	08-46
Etui Edelstahl rostfrei	88-03
EVES	
Tonsillen Schnürer	50-04
Extraktor KUENTSCHER	33-13

## F

FARABEUF Knochenhalte Zange	32-07
FARABEUF-LAMBOTTE	
Knochenhalte Zange	32-08
FARABEUF	
Raspatorien	32-19
Wund Haken	18-02
FARREL Watteträger	20-03
Faseroptik Laryngoskopegriff	AE-11
FAULKNER Kürette	46-18
FAURE	
Peritoneum Klemme	12-17
Probeexcisions Zange	70-41
FEHLAND Darm Klemme	64-06
FEILCHENFELD Splitter Pinzette	10-06
Feile	
JOSEPH Knochen Feile	46-14
Nagel Feile	74-03
Feine Scheren	08-19, 08-24
FERGUSON	
Arterien Klemme	12-07
Gallenstein Löffel	62-07
Knochenhalte Zange	32-07
Schere	08-49
FERRIS Pinzette	10-04
Fertigschläger KUENTSCHER	33-13
FILIFORM Harnröhren Bougie	66-12
Fingerschutz LANGENBECK	48-06
FINOCHIETTO	
Nadelhalter	24-04
Rektum Schere	08-38
FINSER Wund Sperrer	18-14
FINSTERER Saug- und Spül Kanüle	04-05
FISCH Dissektor	44-15
FISCHER Iris Pinzette	42-13
Flachbohrer, CUSHING	33-04
Flachmeißel	32-14
ALEXANDER Flachmeißel	32-14

DIX Fremdkörper Flachmeißel	42-06
HIBBS Flachmeißel	32-16
HOKE Flachmeißel	32-16
LEXER Flachmeißel	32-16
LEXER Mini Flachmeißel	32-16
PARTSCH Flachmeißel	32-14
SMITH-PETERSEN Flachmeißel	32-15
STILLE Flachmeißel	32-14
FLETCHER JAVERTS Schwammzange	16-10
FLEURANT Trokar	22-02
FOERSTER	
Iris Pinzette	42-12
Schwamm Zange	16-06 bis 16-08
FOMON	
Nasenplastik Meißel	46-13
Nasen Raspel	46-15 bis 46-16
Nasenrücken Haken	46-17
Nasen Schere	07-18, 08-25
FORD BOWLES Stethoskop	02-06
FORD Stethoskop	02-06
FOX Lupus Kürette	74-02
FRAENKEL	
Kehlkopf Polypus Zange	52-02
Kehlkopf Zange	52-03
FRANCESCHETTI Hornhaut Trephine	43-07
FRANCIS Fremdkörper Nadel	42-05
FRANKLIN-SILVERMANN Punktions Nadel	22-03
Fräser	33-07
ALBEE Fräser	33-07
BORCHARDT Fräser	33-07
DOYEN Fräser	33-07
HUDSON Kegel Fräser	33-04
Kegel Fräser	33-04
Kortikalis Fräser	33-15
TOTI Fräser	33-07
FRAZIER	
Häkchen	18-06
Sauger	04-06
Wund Spreizer	18-21
FREER	
Mukosa Messer	46-10
Nasen Hohl Meißel	46-14
Septum Elevatorium	46-11
Septum Meißel	46-12
Septum Messer	46-10
FREEWAY-GRAVE Vaginal Spekulum	70-06
FRENZEL Zungen Spatel	48-02
FRIEDMAN	
Hohlmeißel Zange	32-02
Mini Hohlmeißel Zange	32-02
Perineorrhaph Sperrer	70-23
FRITSCH Wund Haken	18-11
FRYKHOLM Hohlmeißel Zange	32-05
FUCHS Kapsel Pinzette	43-04

## G

Gabel BURCH Fixier	42-05
GALLAHER Antrum Raspel	46-16
GAUSS Kopfschwarten Zange	72-06
Gefäß Schere	08-27
Gefäß Schere Mikro	09-09
GELHORN Probeexcisions Zange	70-42
GELPI Bauch Deckenhalter	18-24
GEMINI MINI Präparier	
und Ligatur Klemme	12-10
GEMINI Präparier und Ligatur Klemme	12-10
GERALD Pinzette	10-05
GERSTER Distractions Klammer	32-11
GERZOG Hammer	32-18
GILL-ARRUGA Kapsel Pinzette	43-03
GILL-HESS Iris Pinzette	42-12
GILL Hornhaut Messer	42-05
GILLIES	
Häkchen	46-17
Nadelhalter	24-05
Pinzette	10-05
GILL Iris Pinzette	42-12
Gips Messer	30-04



Gipssäge Sägeblatt	30-05 bis 30-06
Gips Schere	08-49
Gips Spreizer	30-03
Glasschale	88-03
GLOVER Atraumatische Bulldog Klemme	12-02
GOELET Wund Haken	18-03
GOLDMAN-FOX Zahnfleisch Schere	08-41
GOLDSTEIN Sperr Elevator	42-03
GOODELL Uterus Dilatorator	70-30
GOOD Tonsillen Schere	08-27
GORNEY Präparier Schere	08-13
GOSSET Bauch Deckenhalter	18-21
GOURDET Uterus Kürette	70-48
GRADLE Cilien Pinzette	43-08
GRAEFE	
Cystotom	42-06
Fixier Pinzette	43-03
Häkchen	18-06
Iris Pinzette	42-11
Pinzette	10-03
Schiel Haken	42-06
Skarifikateur	42-04
Sperr Elevator	42-02
Star Löffel	42-07
Star Messer	42-03
GRAEFE-TITAN Schiel Haken	42-06
GRAVE Vaginal Spekulum	70-02
GRAY Gallenkanal Klemme	12-15
Graziles Modell Tuch Klemme	14-02
GREEN-ARMYTAGE Uterus Klemme	72-06
GREEN	
Fixier Pinzette	43-03
Hornhaut Dissektor	42-06
Muskel Haken	42-06
Wund Haken	18-10
GREVEN Ohr Mikro Zängchen	44-10
Griff	
COLLIN Skalpell Griff	06-08
HUBER Universal Griff	52-03
Kehlkopf Spiegel Griff	52-04
GRIP Zange	33-11
Große Ringe Präparier Schere	08-19
GROSS-MAIER Tupfer Zange	16-02 bis 16-04
GROSS	
Ohr Löffel	44-06
Tupfer Zange	16-05
GRUBER Ohr Spekula	44-02
GUTHRIE Häkchen	18-06
GUTMANN Sekret Löffel	66-11
GUYON	
Gleit Sonde	66-12
Harnröhren Bougie	66-14 bis 66-15
Katheter Spanner	66-11
Nierenstiel Klemme	12-16
GUYTON-LUNDGAARD Sklerotom	42-05
Gynäkologische Mikro Schere	09-07 bis 09-08

**H**

HABERER Wund Haken	18-04
HAGLUND-STILLE Gips Spreizer	30-03
HAJEK-BALLENGER Septum Elevatorium	46-12
HAJEK-CLAUS Stanze	46-08
HAJEK-KOFLER Stanze	46-08
HAJEK Nasen Hohl Meißel	46-14
Häkchen	44-15
BARBARA Häkchen	44-14
BOSE Tracheal Häkchen	54-02
DAY Ohr Häkchen	44-07
FRAZIER Häkchen	18-06
GILLIES Häkchen	46-17
GRAEFE Häkchen	18-06
GUTHRIE Häkchen	18-06
ITERSON Tracheal Häkchen	54-02
JACKSON Tracheal Häkchen	54-02
JOSEPH Häkchen	18-06
KILNER Haut Häkchen	74-02
KNAPP Häkchen	42-06
ROLLET Häkchen	42-06

ROSE Tracheal Häkchen	54-03
WAGENER Ohr Häkchen	44-07
Haken	
ARRUGA Extraktion Haken	42-06
AUFRIEHT Nasenrücken Haken	46-17
BLOUNT Knie Haken	32-24
BRAUN Dekapitations Haken	72-09
COLLIN-HARTMANN Wund Haken	18-03
CORYLLOS (Thorax) Wund Haken	18-13
COTTLE Nasenrücken Haken	46-17
COTTLE-NEIVERT Nasenrücken Haken	46-17
CRILE Wund Haken	18-02
CUSHING Wund Haken	18-07
DAVIDSON (Scapula) Wund Haken	18-13
DEAVER Grip Wund Haken	18-05
DEAVER Wund Haken	18-05
DESMARRES Wund Haken	18-07
DOYEN Wund Haken	18-12
EMMET Fistel Haken	70-46
Extraktion Haken	33-13
FARABEUF Wund Haken	18-02
FOMON Nasenrücken Haken	46-17
FRITSCH Wund Haken	18-11
für Extensionbügel	33-10
GOELET Wund Haken	18-03
GRAEFE Schiel Haken	42-06
GRAEFE-TITAN Schiel Haken	42-06
GREEN Muskel Haken	42-06
GREEN Wund Haken	18-10
HABERER Wund Haken	18-04
HARRINGTON Wund Haken	18-05
HEANEY Wund Haken	18-12
HOFER Gaumenbogen Haken	50-02
ISRAEL Wund Haken	18-11
JAMESON Schiel Haken	42-06
KELLY Grip Wund Haken	18-04
KELLY Wund Haken	18-04, 18-12
KOCHER Wund Haken	18-10 bis 18-11
KOERTE Wund Haken	18-11
LAHEY Wund Haken	18-08
LANGENBECK Wund Haken	18-09
LITTLE Wund Haken	18-08
LOVE Zäpfchen Haken	50-02
MATHIEU Wund Haken	18-03
MEYERDING Wund Haken	18-08
MIDDELDORPF Wund Haken	18-10
MIKULICZ Wund Haken	18-12
NAGER Gaumensegel Haken	50-02
Haken	
O' CONNOR Iris Haken	42-06
OLLIER Wund Haken	18-10
PARKER Wund Haken	18-02
PRATT Cystikus Haken	68-04
REVERDIN Wund Haken	18-04
RIBBON Wund Haken	18-04
RICHARDSON-EASTMAN Wund Haken	18-04
RICHARDSON Grip Wund Haken	18-04
RICHARDSON Wund Haken	18-04
ROUX Baby Wund Haken	18-02
ROUX mini Wund Haken	18-02
ROUX Wund Haken	18-02
SAUERBRUCH Wund Haken	18-13
SCHOENBORN Schilddrüsen Haken	54-04
SENN-GREEN Wund Haken	18-07
SENN Wund Haken	18-04
SIMON Wund Haken	18-12
SMELLIE Geburts Haken	72-06
STEVENS Linsen Haken	42-06
TAYLOR Spinal Haken	32-24
US Army (PARKER-LANGENBECK)	
Wund Haken	18-03
VOLKMANN Wund Haken	18-07 bis 18-08
WIENER Iris Haken	42-06
YOUNG Prostata Haken	66-02
HALLE Scharf Löffel	32-13
HALSEY Nadelhalter	24-02
HALSTEAD-MOSQUITO	
Arterien Klemme	12-04

HALSTEAD-MOSQUITO Micro	
Arterien Klemme	12-04
HALSTEAD-MOSQUITO TITAN	
Arterien Klemme	12-04
Halter	
KALLMORGEN Schneiden Halter	70-15
KRISTELLER Schneiden Halter	70-09 bis 70-14
Lippen und Wangen Halter	48-03
PITHA Lippen Halter	48-06
REICHERT Kehlkopfpolypendeckel Halter	52-02
STERNBERG Lippen Halter	48-02
Wangen Halter	48-03
Hamburg Knopf Kanüle	43-07
Hammer	32-18
BABINSKY Perkussions Hammer	02-07
BERLINER Perkussions Hammer	02-07
BUCK Perkussions Hammer	02-07
COLLIN Hammer	32-18
DEJERINE Perkussions Hammer	02-07
GERZOG Hammer	32-18
KIRK Hammer	32-18
LUCAE Hammer	32-18
MEAD Hammer	32-18
QUISLING Hammer	32-18
Schlitz Hammer	33-13
TAYLOR Perkussions Hammer	02-07
TRAUBE Perkussions Hammer	02-07
TROMNER Perkussions Hammer	02-07
WILLIGER Hammer	32-18
HANK Uterus Dilatorator	70-28
HARRINGTON Wund Haken	18-05
HARTMANN	
Arterien Klemme	12-03
HARTMANN-HALLE Nasen Spekulum	46-02
HARTMANN-HOFFMANN Ohr Zängchen	44-08
HARTMANN	
Nasen Polypus Zange	46-04
Nasen scharfe Zange	46-07
Ohr Katheter	44-06
Ohr Spekula	44-02
Ohr Zängchen	44-08
Stimmgabel	44-03
HARTMANN-WULLSTEIN Ohr Zängchen	44-08
HARTMANN Zungen Spatel	48-02
HEANEY	
Hysterektomie Klemme	12-18
Nadelhalter	24-03
Wund Haken	18-12
HEATH Ligatur Schere	08-40
Hebel	
BARTON Zug Hebel	72-04
BENNETT Knochen Hebel	32-22
BILL Zug Hebel	72-05
BLOUNT Knochen Hebel	32-24
BUCK Fremdkörper Hebel	44-08
HOHMANN Knochen Hebel	32-22 bis 32-23
HOHMANN Mini Knochen Hebel	32-23
Knochen Hebel	32-23
LUIKART-BILL Zug Hebel	72-05
MURLESS Kopf Hebel	72-05
QUIRE Fremdkörper Hebel	44-08
Heber DOYEN Myom	70-46
HEBRA Chalazion Löffel	42-07
HEGAR Uterus Dilatorator	70-24 bis 70-27
HEGENBARTH Wundklammer Zange	26-07
HEIMING Nierenstein Zange	62-13
HEISS Arterien Klemme	12-09
HEISTER Mund Sperrer	48-03
HENKE Tonsillen Elevator	50-02
HENNIG Gips Spreizer	30-03
HENROTIN Haken Zange	70-34
HERMANN Gips Spreizer	30-03
HERRICK Peritoneum Klemme	12-17
HESS	
Iris Pinzette	42-12
Kapsel Pinzette	43-04
HEYMANN-KNIGHT Nasen Polypus Zange	46-05
HEYMANN	
Nasen scharfe Zange	46-05

## Inhaltsverzeichnis

Index  
Index  
Indice alfabético  
Indice alfabético

Nasen Schere.....	07-18, 08-25
HEYWOOD-SMITH Hämorrhoid Zange .....	68-05
HIBBS	
Flachmeißel.....	32-16
Hohlmeißel.....	32-16
Osteotom .....	32-16
HIRSCHMANN Anoskop.....	68-04
Hobel CREDO Hornhaut .....	74-03
HOESEL Nadelhalter .....	24-05
HOFER Gaumenbogen Haken .....	50-02
HOFF Tuch Klemme .....	14-03
Hohlmeißel .....	32-14
ALEXANDER Hohlmeißel.....	32-14
ELLIS Fremdkörper Hohlmeißel .....	42-06
HIBBS Hohlmeißel .....	32-16
LEXER Hohlmeißel .....	32-16
LEXER Mini Hohlmeißel.....	32-16
PARTSCH Hohlmeißel .....	32-14
SMITH-PETERSEN Hohlmeißel .....	32-15
STILLE Hohlmeißel .....	32-14
WALTON Fremdkörper Hohlmeißel.....	42-06
HOHMANN Knochen Hebel .....	32-22 bis 32-23
HOHMANN Mini Knochen Hebel.....	32-23
HOKE Flachmeißel .....	32-16
HOLTH Kapsel Stanze.....	42-09
HOPKINS Gips Messer .....	30-04
HOUSE Kürette .....	44-15
HRYNITSCHAK Prostata Wundsperrer .....	66-06
HUBER Universal Griff .....	52-03
HUDSON	
Handbohrapparat Apparat .....	33-04
Kegel Fräser.....	33-04
HUMBY	
Dermatom .....	06-20
Dermatom Ersatz Klinge.....	06-20
HUNTER Splitter Pinzette .....	10-06
HURD Tonsillen Dissektor .....	50-02

## I

Instrument	
Beschneidungs Instrument.....	66-09
KNUTSON Urethrogaphie Instrument .....	66-09
LAFORCE Fremdkörper Instrument .....	42-06
MOGAN Beschneidungs Instrument .....	66-09
Inzisions Schere .....	08-05
IOWA Haken Zange .....	70-35
IRIS	
Augen Schere.....	08-22
Schere .....	07-16, 08-21
Schere, mit großen Ringen .....	08-19
Irrigator.....	88-05
ISRAEL Wund Haken .....	18-11
ITARD Ohr Katheter .....	44-06
ITARSON Tracheal Häkchen .....	54-02
IVES-FANSLER Anoskop.....	68-04

## J

JACKSON	
Tampon Pinzette.....	52-02
Tracheal Häkchen .....	54-02
Tracheal Kannule .....	54-03
Vaginal Spekulum .....	70-16
JACOBS Haken Zange .....	70-34
JACOBSON Mikro Schere .....	09-11
JAEGER	
Lanzen Messer.....	42-04
Lid Platte .....	42-03
JAMESON	
Schiel Haken .....	42-06
Strabismus Pinzette.....	42-13
JAMISON Nadelhalter.....	24-03
JANSEN	
Nasen Zange .....	46-04
Wund Sperrer .....	18-14
JARCHO Haken Zange .....	70-32
JATHO Nasenrachen Zange .....	46-18
JENNINGS Mund Sperrer .....	48-04

JOBSON-HORNE Watteträger .....	20-03
JOHNS-HOPKINS	
Gallenkanal Klemme .....	12-14
Gefäß Bulldog Klemme.....	12-03
JOHNSON Nadelhalter .....	24-04
JONES Schlauchhalter Tuch Klemme.....	14-02
JOSEPH	
Häkchen .....	18-06
Knochen Feile.....	46-14
JOSEPH (LEWIS) Nasen Raspel.....	46-15
JOSEPH Nasen Messer .....	46-10
JOSEPH	
Nasen Säge.....	46-17
Nasen Skalpell .....	46-10
Periost Elevatorium .....	46-12
Schere .....	07-14, 08-16
JUDD-ALLIS Darmfaß Zange.....	64-02
JUDD-MASSON Blasen Wundsperrer .....	66-04
JURASZ Kehlkopf Polypus Zange.....	52-02

## K

KABIERSKE Pulverbläser .....	44-04
KALLMORGEN	
Schneiden Halter .....	70-15
Vaginal Spekulum .....	70-15
KALT-ARRUGA Nadelhalter.....	24-07
KALT	
Kapsel Pinzette .....	43-04
Kaltlicht Rectoskop.....	68-03
KALT	
Nadelhalter .....	24-07
KANE Nabelschnur Klemme.....	72-06
Kanüle	
JACKSON Tracheal Kanüle.....	54-03
LUER Tracheal Kanüle .....	54-03
WAGENER-MOSHER Tracheal Kanüle.....	54-03
Kanüle	
Bonn Spül Kanüle .....	43-07
BUJIE Saug Kanüle .....	68-05
FINSTERER Saug- und Spül Kanüle.....	04-05
Hamburg Knopf Kanüle .....	43-07
KILLIAN Spül Kanüle.....	46-09
SCHEIE Augen Kanüle.....	43-07
SIMCOE Naht Kanüle .....	43-07
Tonsillen Kanüle .....	50-05
Tübingen Luft Kanüle .....	43-07
Katheter	
HARTMANN Ohr Katheter.....	44-06
ITARD Ohr Katheter .....	44-06
Metall, Katheter Frauen .....	66-16
Metall, Katheter Männer .....	66-16
Katheter Spanner	
DITTEL Katheter Spanner .....	66-11
GUYON Katheter Spanner.....	66-11
Kauter WADSWORTH-TODD.....	42-08
Kegel Verschluss .....	70-47
KEITH Naeh Nadel .....	26-06
KELLY	
Arterien Klemme .....	12-05
KELLY Grip Wund Haken .....	18-04
KELLY	
Gynäkologische Schere .....	08-33
Gynäkologische Schere .....	07-22
Proktoskop .....	68-04
KELLY-RANKIN Arterien Klemme .....	12-05
KELLY TITAN Arterien Klemme.....	12-05
KELLY	
Uterus-Polypen Zange.....	70-36
Wund Haken .....	18-04, 18-12
KERN Knochenhalte Zange .....	32-08
KERRISON Stanze .....	46-08
KEVORKIAN-Pacific Probeexcisions Zange.....	70-44
KEVORKIAN	
Probeexcisions Zange.....	70-43, 70-46
Uterus Biopsie Saug Kürette .....	70-40
KEY Elevatorien .....	32-21
KEYES Haut Stanzbesteck.....	74-02
Kieferhöhlenpunktionskanülen LICHTWITZ .....	46-09

KIELLAND Geburts Zange .....	72-02
KIELLAND-LUIKART Geburts Zange .....	72-03
KILLIAN-CLAUS Nasen Hohl Meißel .....	46-14
KILLIAN	
Septum Elevatorium .....	46-12
Septum Spekulum.....	46-03
Spül Kanüle.....	46-09
KILNER-DOUGHTY Mund Sperrer.....	48-05
KILNER	
Haut Häkchen .....	74-02
Schere .....	07-14, 08-17
KIRBY-ARTHUR Iris Pinzette .....	42-13
KIRK Hammer .....	32-18
KIRSCHNER	
Bauch Deckenhalter.....	18-23
Bohrdrähte .....	33-09
Extension Bügel .....	33-10
Fuehrungshohl Sonde .....	26-04
Handbohr Apparat.....	33-05
Rahmen .....	18-23
Valve .....	18-23
Klammer LOWMAN Knochenhalte.....	32-11
Klammer	
BUNT Sterilisier Klammer .....	28-02
GERSTER Distraktions Klammer .....	32-11
MAYO Sterilisier Klammer.....	28-02
MICHEL Wund Klammer .....	26-07
Klemme	
ADSON Arterien Klemme .....	12-09
ADSON BABY Arterien Klemme .....	12-09
BACKHAUS-CLIP Schlauchhalter	
Tuch Klemme .....	14-03
BACKHAUS KOCHER Tuch Klemme .....	14-02
BACKHAUS Tuch Klemme .....	14-02
BAINBRIDGE Arterien Klemme .....	12-14
BALL AND SOCKET Tuch Klemme .....	14-04
BENGOLEA Arterien Klemme .....	12-09
BERNHARD Tuch Klemme .....	14-05
BEST Darm Klemme.....	64-06
BRUNNER Darm Klemme.....	64-06
CHAPUT Arterien Klemme.....	12-08
COLLIN Arterien Klemme .....	12-08
COLLIN Nabelschnur Klemme .....	72-06
CRAFOORD Arterien Bronchus Klemme.....	12-12
CRILE Arterien Klemme .....	12-05
CRILE-RANKIN Arterien Klemme .....	12-05
CRILE TITAN Arterien Klemme.....	12-05
DANDY Arterien Klemme .....	12-07
DE BAKEY Atraumatische Bulldog Klemme .....	12-02
Klemme	
DeMARTEL-WOLFSON	
Anastomosen Klemme .....	64-07
DESJARDINS Gallenkanal Klemme .....	12-15
DIEFFENBACH Gefäß Bulldog Klemme .....	12-03
DOYEN-Baby Darm Klemme.....	64-03
DOYEN Darm Klemme.....	64-03
DOYEN Tuch Klemme .....	14-05
FAURE Peritoneum Klemme .....	12-17
FEHLAND Darm Klemme .....	64-06
FERGUSON Arterien Klemme .....	12-07
GEMINI MINI Präparier und Ligatur Klemme .....	12-10
GEMINI Präparier und Ligatur Klemme.....	12-10
GLOVER Atraumatische Bulldog Klemme .....	12-02
GRAY Gallenkanal Klemme .....	12-15
GREEN-ARMYTAGE zur Blutstillung .....	72-06
GUYON Nierenstiel Klemme .....	12-16
HALSTEAD-MOSQUITO Arterien Klemme.....	12-04
HALSTEAD-MOSQUITO Micro Arterien Klemme.....	12-04
HALSTEAD-MOSQUITO TITAN Arterien Klemme .....	12-04
HARTMANN Arterien Klemme .....	12-03
HEANEY Hysterektomie Klemme .....	12-18



## Inhaltsverzeichnis

Index  
Index  
Indice alfabético  
Indice alphabético

HEISS Arterien Klemme.....	12-09	WILLET-MARTELL Kopfhaut Klemme.....	12-08	SIMS Uterus Kürette.....	70-49 bis 70-50
HERRICK Peritoneum Klemme.....	12-17	WINKELMANN		<b>L</b>	
HOFF Tuch Klemme.....	14-03	Beschneidungs Klemme.....	66-09	LABORDE Tracheal Dilator.....	54-02
JOHNS-HOPKINS Gallenkanal		ZENKER Präparier und Ligatur Klemme..	12-12	LAFORCE	
Klemme.....	12-14	Klinge Ersatz.....	06-21	Adenotom.....	46-19
JOHNS-HOPKINS Gefäß Bulldog Klemme	12-03	HUMBY Dermatom Ersatz Klinge.....	06-20	Fremdkörper Instrument.....	42-06
JONES Schlauchhalter Tuch Klemme...	14-02	Klingenbrecher		LAGRANGE Zahnfleisch Schere.....	08-41
KANE Nabelschnur Klemme Klemme..	72-06	CASTROVIEJO Klingenbrecher.....	06-14	LAHEY	
KELLY Arterien Klemme.....	12-05	DIMEDA Klingenbrecher.....	06-14	Gallenkanal Klemme.....	12-14
KELLY-RANKIN Arterien Klemme.....	12-05	TROUTMAN-CHRIS Klingenbrecher.....	06-14	Kropf Fass Zange.....	54-04
KELLY TITAN Arterien Klemme.....	12-05	Klinge		Wund Haken.....	18-08
KOCHER Arterien Klemme, grazil.....	12-06	Skalpell Steril, Mikro Klinge.....	06-13	LAMBERT Chalazion Pinzette.....	43-06
KOCHER Darm Klemme.....	64-04	KLINKENBERGH-LOTH		LAMBOTTE	
LAHEY Gallenkanal Klemme.....	12-14	Lungen und Thorax Schere.....	08-37	Knochenhalte Zange.....	32-08
LANE Magen Klemme.....	64-08	KNAPP		LAMBOTTE Mini Osteotom.....	32-15
LANE Tuch Klemme.....	14-05	Häkchen.....	42-06	LAMBOTTE	
LAWRENCE Präparier		Iris Messer.....	42-04	Osteotom.....	32-15
und Ligatur Klemme.....	12-13	KNAPP-LUER Trachom Pinzette.....	43-06	Raspatorien.....	32-19
LERICHE Arterien Klemme.....	12-09	KNAPP		LANCASTER Sperr Elevator.....	42-03
LORNA Tuch Klemme.....	14-04	Schere.....	08-20	LANDAU Vaginal Spekulum.....	70-22
LOVELACE Arterien Klemme.....	12-07	Star Löffel.....	42-07	LANDOLT	
LOWER Gallenkanal Klemme.....	12-14	KNIGHT Nasen scharfe Zange.....	46-05	Enukleations Schere.....	08-25
LOWER Ureter Klemme.....	62-10	Knochendraht.....	33-11	Mikro Skalpellgriff.....	06-13
LURZ Ureter Klemme.....	62-10	Knochenhalte Zange.....	32-09 bis 32-10	LANE	
MARTEL Kopfhaut Klemme.....	12-08	Knorpel Messer.....	06-18	Knochenhalte Zange.....	32-08
MASTIN Muskel Klemme.....	54-04	KNOWLES Verband Schere.....	08-47	Knochenraub Halte Zange.....	33-14
MAYO-GUYON Nierenstiel Klemme... 12-16		KNUTSON-KOCH Urethrographie Konus... 66-09		Magen Klemme.....	64-08
Klemme		KNUTSON Urethrographie Instrument..... 66-09		Pinzette.....	10-04
MAYO-ROBSON Darm Klemme.....	64-05	KOCHER		Schrauben Dreher.....	33-14
MEEKER Präparier und Ligatur Klemme.. 12-13		Arterien Klemme, grazil.....	12-06	Tuch Klemme.....	14-05
MIKULICZ Peritoneum Klemme.....	12-17	Blasen Spatel.....	66-04	LANGE Kehlkopf Zange.....	52-03
MIXTER Arterien Klemme.....	12-14	Darm Klemme.....	64-04	LANGENBECK	
MIXTER Arterien Bronchus Klemme.....	12-13	Kropf Sonde.....	54-04	Elevatoren.....	32-21
MIXTER BABY Arterien Bronchus Klemme 12-13		Wund Haken.....	18-10 bis 18-11	Finger Säge.....	33-03
MIXTER Gallenkanal Klemme.....	12-15	KOENIG		Fingerschutz.....	48-06
MIXTER O'SHAUGNESSY		Fuehrungshohl Sonde.....	26-04	Knochenhalte Zange.....	32-07
Arterien Klemme.....	12-14	Naeh Nadel.....	26-06	Raspatorien.....	32-19
MOYNIHAN Gallenkanal Klemme.....	12-15	KOERTE Wund Haken.....	18-11	resektions Messer.....	06-17
MOYNIHAN Tuch Klemme.....	14-05	KOGAN Endo Spekulum.....	70-23	Wund Haken.....	18-09
MURPHY Schlauch Klemme.....	12-19	Kompressorium CORWIN Tonsillen..... 50-04		LANGE Verband Schere.....	08-44
NEGUS Tonsillen Klemme.....	50-03	Komprimeter.....	33-02	LANG Tränens Löffel.....	42-08
OVERHOLT-GEISSENDOERFER		KONRICH Sterilisier Trommel.....	88-12	Lärmtrommel BARANY.....	44-04
Präparier und Ligatur Klemme.....	12-10	Konus KNUTSON-KOCH Urethrographie... 66-09		LAWRENCE Präparier und Ligatur Klemme. 12-13	
PAYR-Baby Magen Klemme.....	64-09	Kranioklast		LEBSCHKE Sternummeißel.....	32-17
PAYR Magen Klemme.....	64-09	BRAUN Kranioklast.....	72-09	LEGUEU	
PEAN Arterien Klemme.....	12-08	TARNIER Kranioklast.....	72-09	Blasen Spatel.....	66-04
PEAN Arterien Klemme, grazil.....	12-06	KRAUSE		Blasen Wundsperrer.....	66-06
PEERS BERTRAM Tuch Klemme.....	14-03	Kehlkopf Zange.....	52-03	LEKSELL STILLE Hohlmeißel Zange..... 32-05	
PENNINGTON Arterien Klemme.....	12-07	Nasen Schnürer.....	46-09	LEMPERT	
PHANEUF Peritoneum Klemme.....	12-17	Ohrpolypen Schnürer.....	44-07	Elevatorium.....	44-15
PRATT Arterien Klemme.....	12-08	KRISTELLER		Hohlmeißel Zange.....	32-03
PRESBYTERIAN HOSPITAL		Schneiden Halter.....	70-09 bis 70-14	Scharf Löffel.....	32-13
Schlauch Klemme.....	12-19	Vaginal Spekulum.....	70-09 bis 70-14	LERCHE Pinzette.....	10-04
PROVIDEN24-HOSPITAL		KRONECKER Unterbindungs Nadel..... 26-02		LERICHE Arterien Klemme.....	12-09
Arterien Klemme.....	12-05	KUENTSCHER		LESTER Fixier Pinzette.....	43-03
ROBERTS Arterien Klemme.....	12-11	Extraktor.....	33-13	LEVINSON Fremdkörper Nadel.....	42-05
ROCHESTER-CARMALT		Fertigschläger.....	33-13	LEWIN Knochenhalte Zange.....	32-10
Arterien Klemme.....	12-07	Vorböhrer.....	33-13	LEWKOWITZ Plazentar	
ROCHESTER-OCHSNER		KUHNT Hornhaut Schaber.....	42-05	und Abortus Zange.....	72-07
Arterien Klemme.....	12-06	Kürette		LEXER-BABY	
ROCHESTER-PEAN Arterien Klemme..... 12-06		Absaug Kürette.....	70-51	Präparier Schere.....	08-12
ROEDER Tuch Klemme.....	14-03	ALVIS Fremdkörper Kürette.....	42-06	Schere.....	07-10
RUMEL Thorax Klemme.....	12-11	BLAKE Uterus Kürette.....	70-48	LEXER-FINO Präparier Schere.....	08-12
SAROT Arterien Bronchus Klemme.....	12-12	BUCK Ohr Kürette.....	44-05	LEXER	
SAWTELL Tonsillen Klemme.....	50-03	BUMM Uterus Kürette.....	70-49 bis 70-50	Flachmeißel.....	32-16
SCHNIDT Tonsillen Klemme.....	50-03	COAKLEY Antrum Kürette.....	46-18	Hohlmeißel.....	32-16
SPENCER-WELLS Arterien Klemme.....	12-07	FAULKNER Kürette.....	46-18	LEXER Mini	
STILLE Nierenstiel Klemme.....	12-16	FOX Lupus Kürette.....	74-02	Flachmeißel.....	32-16
STOCKMANN Penis Klemme.....	66-10	GOURDET Uterus Kürette.....	70-48	Hohlmeißel.....	32-16
STONE Verschluss Klemme.....	64-06	HOUSE Kürette.....	44-15	LEXER	
STONE-WATT Darm Klemme.....	64-06	KEVORKIAN Uterus Biopsie		Präparier Schere.....	08-11
STRAUSS Penis Klemme.....	66-10	Saug Kürette.....	70-40	Schere.....	07-09
TOENNIS Arterien Klemme.....	12-11	NOVAK Uterus Biopsie Saug Kürette... 70-40		LICHTWITZ	
TOHOKU Tuch Klemme.....	14-04	PIFFARD Lupus Kürette.....	74-02	Kieferhöhlenpunktionskanülen..... 46-09	
TUFFIER Arterien Klemme.....	12-08	RANDALL Uterus Biopsie Saug Kürette... 70-40		Trokar.....	22-02
WEISS Schlauch Klemme.....	12-19	RECAIMER Uterus Kürette.....	70-49 bis 70-50	LISTER-BURCH Sperr Elevator.....	42-02
WERTHEIM-CULLEN		SCHROEDER Uterus Kürette.....	70-48	LISTER	
Hysterektomie Klemme.....	12-18	Kürette			
WERTHEIM Hysterektomie Klemme..... 12-18		SIMON Uterus Kürette.....	70-48		

## Inhaltsverzeichnis

Index  
Index  
Indice alfabético  
Indice alfabético

Sinus Schwamm Zange.....	16-11
Verband Schere .....	07-23, 08-45
<b>LISTON</b>	
amputations Messer .....	06-16
Knochensplitter Zange .....	32-06
<b>LITTAUER</b>	
Cilien Pinzette .....	43-08
Ligatur Schere.....	08-40
Nasen Polypus Zange .....	46-05
Ohr Zängchen .....	44-08
LITTLER Präparier Schere .....	08-13
LITTLE Wund Haken.....	18-08
LOCKLIN Schere .....	08-18
<b>Löffel</b>	
AXENFELD Chalazion Löffel .....	42-07
BRUNS Scharfe Löffel .....	32-12 bis 32-13
BUNGE Exenterations Löffel .....	42-07
CUZZI Plazentar und Abortus Löffel.....	72-08
DAVIEL Star Löffel.....	42-07
DESJARDINS Gallenstein Löffel .....	62-08
FERGUSON Gallenstein Löffel .....	62-07
GRAEFE Star Löffel .....	42-07
GROSS Ohr Löffel.....	44-06
GUTMANN Sekret Löffel.....	66-11
HALLE Löffel, Scharf .....	32-13
HEBRA Chalazion Löffel.....	42-07
KNAPP Star Löffel .....	42-07
LANG Tränensack Dissektor- Löffel .....	42-08
LEMPERT Scharfer Löffel.....	32-13
LUER-KOERTE Gallenstein Löffel .....	62-09
MARTINI Scharfer Löffel .....	32-13
MAYO Gallenstein Löffel.....	62-07
MEYHOEFER Chalazion Löffel .....	42-07
MOORE Gallenstein Löffel .....	62-05
PESTALOZZA Plazentar und Abortus Löffel .....	72-08
SCHEDE Löffel, Scharf .....	32-12
SELLHEIM Geburts Löffel .....	72-09
SIMON Löffel, Scharf .....	32-13
SPRATT Löffel, Scharf.....	32-12
VOLKMANN Löffel,Scharf.....	32-12 bis 32-13
WALLICH Plazentar und Abortus Löffel .....	72-08
<b>Löffel</b>	
WELLS Eukleation Löffel .....	42-08
WILLIGER Löffel, Scharf .....	32-13
LORENZ Verband Schere .....	08-47
LORNA Tuch Klemme.....	14-04
LOUTE Draht Spanner.....	33-11
LOVELACE Arterien Klemme .....	12-07
LOVE Zäpfchen Haken.....	50-02
LOWER Gallenkanal Klemme .....	12-14
LOWMAN Knochenhalte Klamme .....	32-11
LUBET-BARBON Nasen Polypus Zange .....	46-05
<b>LUCAE</b>	
Hammer.....	32-18
Ohr Pinzette .....	44-07
Stimmgabel.....	44-04
LUC Nasen scharfe Zange .....	46-06
<b>LUER</b>	
Hohlmeißel Zange .....	32-03
LUER-KOERTE Gallenstein Löffel.....	62-09
LUER Tracheal Kannule .....	54-03
Luftdusche POLITZER .....	44-05
LUKART-BILL Zug Hebel.....	72-05
LUKART Geburts Zange.....	72-03
LUNDSSGAARD Sklerotom.....	42-05
LUNIATSCHEK Tampon Stopfer .....	50-02
LURZ Ureter Klemme .....	62-10
<b>M</b>	
<b>MAGILL</b>	
Kathetereinführ Zange .....	04-06
Mandrin.....	04-04
Sauger.....	04-04
Magnet DIMEDA Augen .....	43-08
MAIER Tupfer Zange.....	16-12
MALTZ (COTTLE) Nasen Raspel .....	46-15

<b>MALTZ</b>	
Knorpel Messer.....	46-11
Nasen Raspel .....	46-14
Mandrin MAGILL.....	04-04
Manometer zum Salpingograph .....	70-47
<b>Markier</b>	
CASTROVIEJO Kompass .....	42-09
CONNIN-AMSLER Markier Instrument .....	42-09
MARSCHIK Tonsillen Pinzette .....	50-04
MARTEL Kopfhaut Klemme.....	12-08
MARTIN Becken Zirkel.....	72-06
MARTINI Löffel, Scharf.....	32-13
<b>MARTIN</b>	
Sequester Zange.....	32-10
Tupfer Zange .....	16-02, 16-14
Uterus Sonde.....	70-39
MASSON Nadelhalter.....	24-03
MASTIN Muskel Klemme.....	54-04
<b>MATHIEU</b>	
Fremdkörper Zange.....	66-07
Nadelhalter .....	24-05
Rektal Spekulum.....	68-02
Wund Haken.....	18-03
MATSON Raspatorien .....	32-21
MAUNDER Holz Mundkeil .....	48-06
MAYO BLAKE Gallenstein Zange .....	62-04
<b>MAYO</b>	
Gallenstein Löffel .....	62-07
MAYO-GUYON Nierenstiel Klemme .....	12-16
MAYO-HEGAR Nadelhalter .....	24-02
<b>MAYO</b>	
Linkshänder Schere .....	08-07
Nierenstein Sonde .....	62-10
MAYO-NOBLE Schere.....	07-08, 08-10
MAY Ophthalmoskop.....	02-03
MAYO-ROBSON Darm Klemme .....	64-05
<b>MAYO</b>	
Schere .....	07-06, 08-07
Sterilisier Klammer .....	28-02
MAYO-STILLE Schere.....	07-07, 08-08 bis 08-09
McCLINTOCK Plazentar und Abortus Zange .....	72-07
McCULLOUGH Strabismus Pinzette .....	42-13
McDONALD Elevatorien .....	32-22
McGEE Ohr Mikro Zängchen .....	44-10
McGUIRE Hornhaut Schere.....	09-05
<b>McINDOE</b>	
Knorpel Schere .....	08-35
Pinzette.....	10-04
<b>McIVOR</b>	
Mund Sperrer .....	48-05
Zungen Spatel .....	48-05
McKENY Septum Elevatorium.....	46-11
McKENZIE Bohrer .....	33-04
McLEAN Geburts Zange .....	72-04
McLEAN-LUIKART Geburts Zange.....	72-03
McLEAN-TUCKER-LUIKART Geburts Zange .....	72-03
McPHERSON Faden Pinzette .....	43-05
McPHERSON TITAN Faden Pinzette .....	43-05
McPHERSON WESTCOTT Sehnen Schere.....	09-04
<b>MEAD</b>	
Hammer.....	32-18
Hohlmeißel Zange .....	32-02
MEEKER Präparier und Ligatur Klemme .....	12-13
<b>Meißel</b>	
CINELLI Nasenplastik Meißel.....	46-13
COTTLE Nasenplastik Meißel .....	46-13
FOMON Nasenplastik Meißel.....	46-13
FREER Nasen Hohl Meißel .....	46-14
FREER Septum Meißel .....	46-12
HAJEK Nasen Hohl Meißel .....	46-14
KILLIAN-CLAUS Nasen Hohl Meißel .....	46-14
PASSOW Meißel .....	44-15
ROLLET Extirpations Meißel .....	42-06
SILVER Nasenplastik Meißel .....	46-14
WEST Nasen Hohl Meißel .....	46-14
MELLINGER-AXENFELD Sperr Elevator .....	42-02
MELLINGER Sperr Elevator .....	42-02
MENGHINI Trokar .....	22-03

<b>Meniskotom</b>	
BIRCHER Meniskotom .....	32-24
NEFF Meniskotom .....	32-24
SMILLIE Meniskotom .....	32-24
<b>Messer</b>	
BALLENGER Schwing Messer .....	46-11
BARKAN Goniotomie Messer .....	42-05
BARNHILL Ring Messer .....	46-19
BARRAQUER Keratoplastik Messer.....	42-05
BECKMANN Ring Messer.....	46-19
BERENS Lanzen Messer .....	42-04
BOWMAN Discisions Messer.....	42-04
CARPENTER Tonsillen Messer .....	50-02
<b>Messer</b>	
CASTROVIEJO Lanzen Messer.....	42-04
CATLIN Amputations Messer .....	06-16
CONVERSE Nasen Messer .....	46-10
COTTLE Nasen Messer .....	46-10
DEAN Iris Messer .....	42-04
DEUTSCHMANN Star Messer .....	42-03
ELSCHNIG Hornhaut Messer .....	42-05
ESMARCH Gips Messer.....	30-04
FREER Mukosa Messer.....	46-10
FREER Septum Messer .....	46-10
GILL Hornhaut Messer.....	42-05
GRAEFE Star Messer .....	42-03
HOPKINS Gips Messer.....	30-04
JAEGER Lanzen Messer .....	42-04
JOSEPH Nasen Messer .....	46-10
KNAPP Iris Messer .....	42-04
LANGENBECK Resektions Messer.....	06-17
LISTON Amputations Messer .....	06-16
MALTZ Knorpel Messer .....	46-11
MOELTGEN Winkel Messer .....	02-08
MUCK Periost Messer .....	44-15
OTIS Ersatz Messer .....	66-08
PAUFIQUE Keratoplastik Messer .....	42-05
PLESTER Lappen Messer .....	44-14
POLITZER Ohr Messer .....	44-06
REINER Gips Messer .....	30-04
ROSEN Rundschnitt Messer .....	44-14
SATO Hornhaut Messer .....	42-05
SCHIEE Goniotomie Messer .....	42-05
SCHUKNECHT Roll Messer .....	44-14
SCHUKNECHT Sichel Messer .....	44-14
SEGOND Myom Messer.....	70-46
SEXTON Ohr Messer .....	44-06
St. CLAIR-THOMSON Ring Messer.....	46-19
TABB Sichel Messer .....	44-14
TOOK Hornhaut Messer .....	42-05
VIRCHOW Hirn Messer .....	06-18
VIRCHOW Knorpel Messer .....	06-18
WHEELER Diszisions Messer .....	42-04
WULLSTEIN Sichel Messer .....	44-14
ZIEGLER Iris Messer .....	42-04
ZIEGLER Kapsulotomie Messer.....	42-05
Messzirkel BERTILLON Schädel .....	02-08
Metall Massstäbe.....	02-08
<b>METZENBAUM FINO</b>	
Präparier Schere.....	08-15
Schere .....	07-12
<b>METZENBAUM</b>	
Nadelhalter.....	24-04
Präparier Schere .....	08-13 bis 08-14
Schere .....	07-11
METZENBAUM "S" Schere.....	07-13, 08-16
MEYERDING Wund Haken .....	18-08
MEYHOEFER Chalazion Löffel .....	42-07
<b>MICHEL</b>	
Spiegel .....	46-04
Wund Klammer .....	26-07
Wundklammer Zange.....	26-07
MIDDELDORPF Wund Haken .....	18-10
<b>MIDDLETON-JANSEN</b>	
Nasen scharfe Zange .....	46-09
Mikro Pinzette.....	11-02
Mikro Schere .....	09-06, 09-13
Mikro Skalpell Griff .....	06-12
<b>MIKULICZ</b>	

Peritoneum Klemme.....	12-17
Wund Haken.....	18-12
<b>MILLIN</b>	
Blasenhals Sperrer .....	66-07
Blasen Wundsperrer.....	66-05
Fadenführungs Zange.....	66-03
Faß vordere Lappen Zange.....	66-04
Kaltlicht Aufsatz.....	66-05
Kapsel Faß Zange.....	66-03
MILLS Gefäß Schere .....	08-27
Mini Naht Besteck.....	26-08
Mini Stirnlampe CLAR.....	02-05
<b>MIXTER</b>	
Arterien Bronchus Klemme .....	12-13
Arterien Klemme .....	12-14
MIXTER BABY Arterien Bronchus Klemme .....	12-13
<b>MIXTER</b>	
Gallenkanal Klemme .....	12-15
Gallenstein Zange.....	62-04
<b>MIXTER O'SHAUGNESSY</b>	
Arterien Klemme.....	12-14
MOELTGEN Winkel Messer.....	02-08
MOGAN Beschneidungs Instrument.....	66-09
MOLLISON Wund Sperrer .....	18-17
<b>MOORE</b>	
Gallenstein Löffel .....	62-05
Handbohr Apparat.....	33-04
MOORFIELD Naht Pinzette .....	43-05
<b>MOYNIHAN</b>	
Gallenkanal Klemme .....	12-15
Gallenstein Sonde .....	62-05
Tuch Klemme .....	14-05
MUCK Periost Messer .....	44-15
MUELLER Sperr Elevator .....	42-03
Mundkeil MAUNDER Holz .....	48-06
MURDOCK Sperr Elevator.....	42-02
MURLESS Kopf Hebel .....	72-05
MURPHY-LANE Elevatorien .....	32-22
MURPHY Schlauch Klemme .....	12-19
MUSEUX Haken Zange.....	70-33
Muskel Haken .....	18-25
Mutterschlüssel für Extensionbügel.....	33-10
MYLES Nasen scharfe Zange .....	46-07
<b>N</b>	
NABATOFF Varicen Besteck Ohr Sonde.....	20-02
<b>Nadel</b>	
BARBARA Nadel.....	44-14
BOWMAN Diszisions Nadel.....	42-05
COOPER Unterbindungs Nadel .....	26-02
DAVIS Fremdkörper Nadel .....	42-05
DESCHAMPS Unterbindungs Nadel .....	26-02
DIX Flachmeißel .....	42-09
DUPUY-WEISS Tonsillen Nadel, Nadel .....	50-03
FRANCIS Fremdkörper Nadel .....	42-05
FRANKLIN-SILVERMANN	
Punktions Nadel .....	22-03
Fremdkörper Nadel.....	42-05
<b>Nadelhalter</b>	
ADSON Nadelhalter .....	24-04
ARRUGA Nadelhalter.....	24-06
BARRAQUER Nadelhalter .....	24-07
BAUMGARTNER Nadelhalter .....	24-02
BOYNTON Nadelhalter .....	24-06
BOZEMANN Nadelhalter .....	24-03
CASTROVIEJO Nadelhalter.....	24-07
COLLIER Nadelhalter .....	24-02
CRILE Nadelhalter .....	24-04
CRILE-MURRAY Nadelhalter.....	24-02
CRILE-WOOD Nadelhalter .....	24-02
DE BAKEY Nadelhalter .....	24-03
DERF Nadelhalter .....	24-02
DIETHRICH Nadelhalter .....	24-06
FINOCHIETTO Nadelhalter .....	24-04
GILLIES Nadelhalter .....	24-05
HALSEY Nadelhalter .....	24-02
HEANEY Nadelhalter .....	24-03
HOESEL Nadelhalter .....	24-05

JAMISON Nadelhalter .....	24-03
JOHNSON Nadelhalter.....	24-04
KALT Nadelhalter .....	24-07
KALT-ARRUGA Nadelhalter.....	24-07
MASSON Nadelhalter .....	24-03
MATHIEU Nadelhalter .....	24-05
MAYO-HEGAR Nadelhalter.....	24-02
METZENBAUM Nadelhalter .....	24-04
NEIVERT Nadelhalter .....	24-02
OLSEN-HEGAR Nadelhalter .....	24-05
RYDER Nadelhalter .....	24-03
SAROT Nadelhalter.....	24-04
STEVENS Nadelhalter .....	24-06
STRATTE Nadelhalter .....	24-04
TOENNIS Nadelhalter.....	24-04
WANGENSTEEN Nadelhalter .....	24-03
<b>Nadel</b>	
KEITH Naeh Nadel .....	26-06
KOENIG Naeh Nadel.....	26-06
KRONECKER Unterbindungs Nadel .....	26-02
LEVINSON Fremdkörper Nadel .....	42-05
NELSON Unterbindungs Nadel .....	26-02
POLITZER Parazentese Nadeln .....	44-06
QUINKE Punktions Nadel .....	22-03
<b>Nadelrad WARTENBERG</b> .....	02-08
<b>Nadel</b>	
REVERDIN Unterbindungs Nadel .....	26-03
ROSEN Nadel.....	44-14 bis 44-15
Star Nadel .....	42-05
VERRES Pneumoperitoneum	
Punktions Nadel .....	22-03
YOUNG Boomerang	
Unterbindungs Nadel.....	26-03
NAEGELE Geburts Zange .....	72-03
Naeh Nadel .....	26-05 bis 26-06
NÄGELE Perforatorium.....	72-09
Nagel STEINMANN Knochen .....	33-09
NAGER Gaumensegel Haken .....	50-02
NEFF Meniskotom .....	32-24
NEGUS Tonsillen Klemme.....	50-03
NEIVERT Nadelhalter .....	24-02
<b>NELSON</b>	
Pinzette.....	10-05
Trokar.....	22-02
Unterbindungs Nadel .....	26-02
NEUBÜSER Tuben Faß Pinzette .....	70-51
Neurochirurgische Schere .....	08-35
NORTHBENT Ligatur Schere .....	08-40
NOTO Uterus-Polypen Zange .....	70-36
NOVAK Uterus Biopsie Saug Kürette .....	70-40
<b>NOYES</b>	
Iris Schere .....	09-03 bis 09-04
Nasen Polypus Zange .....	46-05
Sehnen Schere.....	09-03
NUBOER Sauger.....	04-05
<b>O</b>	
OCHSNER Trokar .....	22-02
O'CONNOR Iris Haken.....	42-06
OLIVECRONA Hohlmeißel Zange .....	32-03
OLLIER Wund Haken .....	18-10
OLSEN-HEGAR Nadelhalter .....	24-05
<b>Ophthalmoskop</b>	
MAY Ophthalmoskop .....	02-03
VARIFOCAL Ophthalmoskop .....	02-03
<b>Osteotom</b> .....	32-14
HIBBS Osteotom .....	32-16
LAMBOTTE Osteotom .....	32-15
LAMBOTTE Mini Osteotom.....	32-15
STILLE Osteotom .....	32-14
<b>O'SULLIVAN-O'CONNOR</b>	
Bauch Deckenhalter.....	18-21
Vaginal Spekulum .....	70-08
Oszillierende Gips Säge .....	30-05 bis 30-06
<b>OTIS</b>	
Ersatz Messer .....	66-08
Urethrotom .....	66-08
<b>Otoskop</b> .....	02-04

<b>OVERHOLT-GEISSENDOERFER</b>	
Präparier und Ligatur Klemme .....	12-10
OVERHOLT Raspatorien .....	32-21

**P**

Parametrien Gefäß Schere .....	08-31
Parametrium Gefäß Schere .....	07-20
PARHAM Band.....	32-11
<b>PARKER</b>	
anatomische Skalpell.....	06-15
Wund Haken.....	18-02
PARK Sperr Elevator .....	42-03
<b>PARTSCH</b>	
Flachmeißel.....	32-14
Hohlmeißel.....	32-14
PASSOW Meißel .....	44-15
PATON Hornhaut Dissektor.....	42-05
<b>PAUFIQUE</b>	
Faden Pinzette .....	43-05
Keratoplastik Messer .....	42-05
PAUFIQUE TITAN Faden Pinzette .....	43-05
PAYR-Baby Magen Klemme.....	64-09
<b>PAYR</b>	
Fuehrungshohl Sonde .....	26-04
Magen Klemme .....	64-09
<b>PEAN</b>	
Arterien Graziilles Klemme .....	12-06
Arterien Klemme .....	12-08
PEDERSON Vaginal Spekulum .....	70-03
PEERS BERTRAM Tuch Klemme .....	14-03
PEET Splitter Pinzette.....	10-06
PELKMANN Tupfer Zange.....	16-12
PENNINGTON Arterien Klemme .....	12-07
PERCY Amputation Retraktor .....	33-03
<b>Perforatorium</b>	
NÄGELE Perforatorium .....	72-09
SMELLIE Perforatorium .....	72-09
PERTHES Reibhaken .....	33-08
PESTALOTTA Plazentar und Abortus Löffel .....	72-08
PETRI Schale .....	88-08
PETZ Magen- und Darmnääh Apparat .....	64-09
Pflaster Spatel.....	20-03
PHANEUF Peritoneum Klemme.....	12-17
Pick .....	44-15
BARBARA.....	44-14 bis 44-15
PIERCE Trokar .....	22-02
PIFFARD Lupus Kürette.....	74-02
PINARD Stethoskop .....	02-06
<b>Pinzette</b> .....	10-02
ADLERKREUTZ Pinzette .....	10-04
ADSON Pinzette .....	10-03
ADSON-BROWN Pinzette .....	10-03
ADSON Mikro Pinzette .....	10-03
ARCHER Splitter Pinzette .....	10-06
ARRUGA Kapsel Pinzette .....	43-04
AYER Chalazion Pinzette .....	43-06
BARRAQUER KATZIN Iris Pinzette .....	42-13
BARRAQUER Colibri Iris Pinzette .....	42-13
BARRAQUER Cilien Pinzette.....	43-08
BARRAQUER Fixier Pinzette .....	43-03
BARRAQUER Vorderkammer Pinzette.....	43-02
BEER Cilien Pinzette .....	43-08
BERKE Muskel Pinzette.....	43-02
BISHOP-HARMAN Iris Pinzette .....	42-14
BONACCOLTO Strabismus Pinzette .....	42-14
Bonn Iris Pinzette .....	42-15
Bonn TITAN Iris Pinzette .....	42-15
BROWN Pinzette .....	10-03
CARMALT Splitter Pinzette .....	10-06
CASTROVIEJO Fixier Pinzette .....	43-03
CASTROVIEJO Kapsel Pinzette .....	43-04
CASTROVIEJO Naht Pinzette.....	43-05
Cilien Pinzette .....	43-08
COLLIN-DUBVAL Pinzette .....	10-04
COOLEY Atraumatische Pinzette.....	11-03
CUSHING Pinzette .....	10-03
DASTOOR Strabismus Pinzette .....	42-14
DE BAKEY Atraumatische Pinzette.....	11-03

## Inhaltsverzeichnis

Index  
Index  
Indice alfabético  
Indice alfabético

DESMARRES Chalazion Pinzette.....	43-06
DOUGLAS Cilien Pinzette.....	43-08
DUVAL Pinzette.....	10-04
ELSCHNIG Fixier Pinzette.....	43-03
ELSCHNIG Kapsel Pinzette.....	43-04
FEILCHENFELD Splitter Pinzette.....	10-06
FERRIS Pinzette.....	10-04
FISCHER Iris Pinzette.....	42-13
FOERSTER Iris Pinzette.....	42-12
FUCHS Kapsel Pinzette.....	43-04
GERALD Pinzette.....	10-05
GILL-ARRUGA Kapsel Pinzette.....	43-03
GILL-HESS Iris Pinzette.....	42-12
GILLIES Pinzette.....	10-05
GILL Iris Pinzette.....	42-12
GRADLE Cilien Pinzette.....	43-08
GRAEFE Pinzette.....	10-03
GRAEFE Fixier Pinzette.....	43-03
GRAEFE Iris Pinzette.....	42-11
GREEN Fixier Pinzette.....	43-03
HESS Iris Pinzette.....	42-12
HESS Kapsel Pinzette.....	43-04
HUNTER Splitter Pinzette.....	10-06
JACKSON Tampon Pinzette.....	52-02
JAMESON Strabismus Pinzette.....	42-13
KALT Kapsel Pinzette.....	43-04
KIRBY-ARTHUR Iris Pinzette.....	42-13
KNAPP-LUER Tracho. Pinzette.....	43-06
LAMBERT Chalazion Pinzette.....	43-06
LANE Pinzette.....	10-04
LERCHE Pinzette.....	10-04
LESTER Fixier Pinzette.....	43-03
LITTAUER Cilien Pinzette.....	43-08
LUCAE Ohr Pinzette.....	44-07
MARSCHIK Tonsillen Pinzette.....	50-04
McCULLOUGH Strabismus Pinzette.....	42-13
McINDOE Pinzette.....	10-04
McPHERSON Faden Pinzette.....	43-05
McPHERSON TITAN Faden Pinzette.....	43-05
MOORFIELD Naht Pinzette.....	43-05
NELSON Pinzette.....	10-05
NEUBÜSER Tuben Faß Pinzette.....	70-51
PAUFIQUE Faden.....	43-05
PAUFIQUE TITAN Faden Pinzette.....	43-05
PEET Splitter Pinzette.....	10-06
POTTS-SMITH Pinzette.....	10-02
PRINCE Muskel Pinzette.....	43-02
RUSSIAN Pinzette.....	10-04
SCHWEIGGER Kapsel Pinzette.....	43-04
SEMKEN Pinzette.....	10-05
SINGLEY Pinzette.....	10-05
SNELLEN Entropium Pinzette.....	43-06
STEVENS Iris Pinzette.....	42-11
STIEGLITZ Splitter Pinzette.....	10-06
STILLE Pinzette.....	10-02
St. MARTIN Naht Pinzette.....	43-05
TERSON Kapsel Pinzette.....	43-04
TROUTMAN Colibri Iris Pinzette.....	42-13
TROUTMAN Rectus Pinzette.....	43-02
Tübingen Faden Pinzette.....	43-05
Tübingen Iris Pinzette.....	42-15
Tübingen TITAN Faden Pinzette.....	43-05
Tübingen TITAN Iris Pinzette.....	42-15
USA Pinzette.....	10-02
VIRTUS (RALK) Splitter Pinzette.....	10-06
WANGENSTEEN Pinzette.....	10-05
WILDE (TROELTSCH) Ohr Pinzette.....	44-07
PIPER Geburts Zange, mit Achsenzugvorrichtung.....	72-04
Platte JAEGER Lid.....	42-03
PLESTER Lappen Messer.....	44-14
Wund Sperrer.....	18-14
POLITZER Luftdusche.....	44-05
Ohr Messer.....	44-06
Parazentesenadeln Nadel.....	44-06
POOLE Sauger.....	04-02
POTTS DE MARTEL Gefäß Schere.....	08-27

POTTS-SMITH Gefäß Schere.....	07-19, 08-28
Pinzette.....	10-02
POZZI Haken Zange.....	70-31
Präparier Schere.....	08-34
PRATT Arterien Klemme.....	12-08
Cystikus Haken.....	68-04
Haken Zange.....	70-34 bis 70-35
Rektal Spekulum.....	68-02
Uterus Dilatator.....	70-29
PRESBYTERIAN HOSPITAL Schlauch Klemme.....	12-19
PRINCE Muskel Pinzette.....	43-02
Tonsillen Schere.....	08-27
Proktoskop KELLY.....	68-04
PROVIDEN24-HOSPITAL Arterien Klemme.....	12-05
Pulverbläser KABERSKE.....	44-04
PUTTI Knochen Raspel.....	32-25

## Q

QUATTRO Gips Spreizer.....	30-03
Quetscher SAALFELD Komedonen Quetscher.....	74-02
SCHAMBERG Komedonen Quetscher.....	74-02
UNNA Komedonen Quetscher.....	74-02
WALTON Komedonen Quetscher.....	74-02
QUINBY Zahnfleisch Schere.....	08-42
QUINKE Punktions Nadel.....	22-03
QUIRE Fremdkörper Hebel.....	44-08
QUISLING Hammer.....	32-18

## R

RADOLF Nagelausschneid Zange.....	33-03
Rahmen KIRSCHNER.....	18-23
RALK Handbohr Apparat.....	33-05
RAMPLEY Schwamm Zange.....	16-09
RANDALL Nierenstein Zange.....	62-11 bis 62-12
Uterus Biopsie Saug Kürette.....	70-40
Rasierer.....	06-14
Rasierer Klinge.....	06-14
Rasier Messer.....	06-19
Rasiermesser Ersatz Klängen.....	06-19
Raspatorien ALEXANDER Raspatorien.....	32-19
DOYEN Rippen Raspatorien.....	32-20
FARABEUF Raspatorien.....	32-19
LAMBOTTE Raspatorien.....	32-19
LANGENBECK Raspatorien.....	32-19
MATSON Raspatorien.....	32-21
OVERHOLT Raspatorien.....	32-21
SADILLOT Raspatorien.....	32-19
SEMB Raspatorien.....	32-20
WILLIGER Raspatorien.....	32-19
Raspel FOMON Nasen Raspel.....	46-15 bis 46-16
GALLAHER Antrum Raspel.....	46-16
JOSEPH (LEWIS) Nasen Raspel.....	46-15
Knochen Raspel.....	32-25
MALTZ (COTTLE) Nasen Raspel.....	46-15
MALTZ Nasen Raspel.....	46-14
PUTTI Knochen Raspel.....	32-25
WIENER (AUFRICHT) Nasen Raspel.....	46-15
WIENER Nasen Raspel.....	46-15
RECAIMER Uterus Kürette.....	70-49 bis 70-50
Reibhaken.....	33-08
PERTHES Reibhaken.....	33-08
REICHERT Kehldeckel Halter.....	52-02
REINER Gips Messer.....	30-04
Ohr Spritze.....	44-05
Reinigungs Bürste.....	28-04 bis 28-05
Retraktor PERCY Amputation.....	33-03
REVERDIN Unterbindungs Nadel.....	26-03

Wund Haken.....	18-04
REYNOLDS Schere.....	07-15, 08-18
Rhachiotom.....	32-17
RIBBON Wund Haken.....	18-04
RICHARDSON-EASTMAN Wund Haken.....	18-04
RICHARDSON Grip Wund Haken.....	18-04
RICHARDSON Wund Haken.....	18-04
RICHTER-HEATH Wundklammer Zange.....	26-07
RIGBY Bauch Deckenhalter.....	18-24
Ringstripper.....	20-03
ROBERTS Arterien Klemme.....	12-11
ROCHESTER-CARMALT Arterien Klemme.....	12-07
ROCHESTER-OCHSNER Arterien Klemme.....	12-06
ROCHESTER-PEAN Arterien Klemme.....	12-06
ROEDER Tuch Klemme.....	14-03
ROGER Septum Elevatorium.....	46-11
ROGGE Sterilisier Zange.....	28-02
Rohr BRUENINGS Verlängerung.....	52-03
ROLLET Extirpations Meißel.....	42-06
Häkchen.....	42-06
ROSENBERG Kehlkopf Zange.....	52-03
ROSEN Nadel.....	44-14 bis 44-15
Rundschnitt Messer.....	44-14
ROSER-KOENIG Mund Sperrer.....	48-03
ROSE Tracheal Häkchen.....	54-03
ROTES KREUZ Verband Schere.....	08-47
ROUX Baby Wund Haken.....	18-02
ROUX mini Wund Haken.....	18-02
ROUX Wund Haken.....	18-02
ROWE Mund Zange.....	48-06
RUBIN Septum Quetsch Zange.....	46-07
RUMEL Thorax Klemme.....	12-11
RUSKIN Hohlmeißel Zange.....	32-04
RUSKIN-LISTON Knochensplitter Zange.....	32-06
RUSSIAN Pinzette.....	10-04
RYDEL-SEIFFER Stimmgabel.....	44-04
RYDER Nadelhalter.....	24-03

## S

SAALFELD Komedonen Quetscher.....	74-02
SADILLOT Raspatorien.....	32-19
SAENGER Plazentar und Abortus Zange.....	72-07
Säge, BERGMANN Gipsäge.....	30-02
Sägeblatt CHARRIERE.....	33-03
Säge CHARRIERE Amputations Säge.....	33-03
DIMEDA Fingerring Säge.....	33-03
ENGEL Gips Säge.....	30-02
Fingerring Säge.....	33-03
JOSEPH Nasen Säge.....	46-17
LANGENBECK Finger Säge.....	33-03
WIGMORE Gips Säge.....	30-02
SAIRGES Haken Zange.....	70-32
Salpingograph SCHULTZE.....	70-47
SANVENERO Schere.....	07-13, 08-16
SAROT Arterien Bronchus Klemme.....	12-12
Nadelhalter.....	24-04
SATINSKY Lungen und Thorax Schere.....	08-37
SATO Hornhaut Messer.....	42-05
SAUERBRUCH Abfall Zange.....	28-03
SAUERBRUCH Hohlmeißel Zange.....	32-05
Nadel Dose.....	88-02
Wund Haken.....	18-13
Sauger ANDREWS-PINCHON Sauger.....	04-03
DASTOOR Kapsel Sauger.....	42-09
DE BAKEY Sauger.....	04-04
FRAZIER Sauger.....	04-06
MAGILL Sauger.....	04-04
NUBOER Sauger.....	04-05
POOLE Sauger.....	04-02
WALTON YANKAUER Sauger.....	04-03
YANKAUER Sauger.....	04-02
SAWTELL Tonsillen Klemme.....	50-03



## Inhaltsverzeichnis

Index  
Index  
Indice alfabético  
Indice alphabético

SCAGLIETTI Hohlmeißel Zange .....	32-05	MAYO-NOBLE Schere.....	07-08, 08-10	SNELLEN Draht Schlinge.....	42-08
Schaber KUHNT Hornhaut .....	42-05	MAYO-STILLE Schere..	07-07, 08-08 bis 08-09	WEBER Draht Schlinge .....	42-08
Schale		McGUIRE Hornhaut Schere .....	09-05	WILDER Draht Schlinge.....	42-08
Instrumenten Schale.....	88-08 bis 88-09	McINDOE Knorpel Schere .....	08-35	SCHMIEDEN Fuehrungshohl Sonde .....	26-04
Lösungs Schale .....	88-04	McPHERSON WESTCOTT		SCHMIEDEN-PAYR Fuehrungshohl Sonde .....	26-04
Nieren Schale .....	88-07	Sehnen Schere .....	09-04	SCHMIEDEN-TAYLOR Schere .....	08-36
PETRI Schale.....	88-08	METZENBAUM Schere .....	07-11	Schneider	
Spül- Schale .....	88-05	METZENBAUM FINO Schere .....	07-12	DIAMANT Draht Schneider .....	33-12
SCHAMBERG Komedonen Quetscher .....	88-02	METZENBAUM FINO Präparier Schere.....	08-15	Draht Schneider.....	33-12
SCHUDE Scharf Löffel .....	32-12	METZENBAUM		SCHNIDT Tonsillen Klemme .....	50-03
SCHEIE		Präparier Schere .....	08-13 bis 08-14	Schnürer	
Augen Kanüle.....	43-07	METZENBAUM "S" Schere .....	07-13, 08-16	BRUENINGS Tonsillen Schnürer .....	50-04
Goniotomie Messer .....	42-05	MILLS Gefäß Schere .....	08-27	EVES Tonsillen Schnürer .....	50-04
BARRAQUER Kehlkopf Zange .....	52-03	Nagel Schere .....	74-03	KRAUSE Nasen Schnürer .....	46-09
SCHERBAK Vaginal Spekulum .....	70-21	NORTHBENT Ligatur Schere.....	08-40	KRAUSE Ohrpolypen Schnürer .....	44-07
Schere.....	07-02 bis 07-04, 08-02 bis 08-04	NOYES Iris Schere.....	09-03 bis 09-04	TYDING Tonsillen Schnürer .....	50-05
AEBLI Hornhaut Schere .....	08-22	NOYES Sehnen Schere .....	09-03	WESTON Rektal Polypen Schnürer .....	68-05
BARRAQUER Colibri Schere .....	09-04	Ohr Mikro Schere .....	44-11	WILDE Nasen Schnürer .....	46-09
BEEBEE Draht und Blech Schere.....	08-43	Ohr Mikro Mini Schere.....	44-11	WILDE Ohrpolypen Schnürer.....	44-07
BELLUCCI Ohr Mikro Schere .....	44-09	Parametrium Gefäß Schere .....	07-20	SCHOENBORN Schilddrüsen Haken .....	54-04
BERGMANN Verband Schere .....	08-46	POTTS DE MARTEL Gefäß Schere .....	08-27	SCHOENBURG Darmfaß Zange .....	64-03
BEUSE Schere.....	08-26	POTTS-SMITH Gefäß Schere .....	07-19	SCHROEDER	
BOETTCHER Tonsillen Schere .....	08-27	POTTS-SMITH Gefäß Schere .....	08-28	Haken Zange .....	70-31 bis 70-32
BRAUN-STADLER		PRINCE Tonsillen Schere .....	08-27	Uterus Kürette .....	70-48
Episiotomie Schere .....	07-22, 08-34	QUINBY Zahnfleisch Schere.....	08-42	SCHUBERT Probeexcisions Zange .....	70-41
BRUNS Gips Schere.....	08-48	REYNOLDS Schere.....	07-15, 08-18	SCHUKNECHT	
BUCK Ligatur Schere .....	08-40	ROTES KREUZ Verband Schere.....	08-47	Roll Messer .....	44-14
BUSCH Nabelschnur Schere .....	08-34	SANVENERO Schere.....	07-13, 08-16	Sichel Messer .....	44-14
CASTROVIEJO Hornhaut Schere .....	09-06	SATINSKY Lungen und Thorax Schere .....	08-37	SCHULTZE Salpingograph .....	70-47
CASTROVIEJO Iridectomie Schere .....	09-05	SCHMIEDEN-TAYLOR Schere.....	08-36	SCHUMACHER	
COTTLE Nasen Schere.....	07-18, 08-25	SCHUMACHER Nabelschnur Schere .....	08-34	Kehlkopf Zange .....	52-03
CRAFOORD Lungen		SEUTIN Gips Schere .....	30-02	Nabelschnur Schere .....	08-34
und Thorax Schere .....	08-36	SHEA Ohr Mikro Schere.....	44-09	SCHUMACHER Probeexcisions Zange .....	70-43
DANDY Neurochirurgische Schere .....	08-36	SHORTBENT Ligatur Schere .....	08-40	Schützer ARRUGA Netzhaut Ablös.....	42-08
DEAN Tonsillen Schere .....	08-26	SIEBOLD Gynäkologische Schere .....	08-32	Schutzhülse Gewebe .....	33-15
DEAVER Schere.....	07-05, 08-06	SIEBOLD Gynäkologische Schere .....	07-21	SCHWEIGGER Kapsel Pinzette .....	43-04
DE BAKEY Gefäß Schere .....	08-30	SIMS Gynäkologische Schere .....	08-32	Schwestern Garnitur .....	74-03
DIETHRICH Gefäß Schere .....	08-29	SIMS Gynäkologische Schere .....	07-21	SEEMANN-SEIFFERT Mund Sperrer .....	48-04
DIMEDA Verband Schere.....	08-46	SMITH US ARMY Verband Schere .....	08-44	SEGOND Myom Messer .....	70-46
DOYEN Gynäkologische Schere.....	08-33	SPENCER Ligatur Schere.....	08-40	SEIFFERT Kehlkopf Zange .....	52-03
DUBOIS Gynäkologische Schere .....	08-33	Schere		SELLHEIM Geburts Löffel.....	72-09
ESMARCH Verband Schere .....	08-46	STELZNER Rektum Schere .....	08-38	SEMB	
FERGUSON Schere.....	08-49	STEVENS Tenotomie Schere.....	07-17, 08-23	Hohlmeißel Zange .....	32-06
FINOCHIETTO Rektum Schere .....	08-38	STILLE Gips Schere.....	30-02	Knochenhalte Zange .....	32-07
FOMON Nasen Schere .....	07-18, 08-25	Strabismus Schere .....	07-17	Knochen splitter Zange .....	32-07
GOLDMAN-FOX Zahnfleisch Schere .....	08-41	STRULLY Neurochirurgische Schere .....	08-35	Raspatorien .....	32-20
GOOD Tonsillen Schere.....	08-27	THOREK Lungen und Thorax Schere.....	08-36	SEMKEN Pinzette .....	10-05
GORNEY Präparier Schere .....	08-13	TOENNIS-ADSON		SEMM Vaginal Spekulum .....	70-07
Haut Schere .....	74-03	Neurochirurgische Schere .....	08-35	SENN-GREEN Wund Haken.....	18-07
Schere		TROUTMAN-CASTROVIEJO		SENN Wund Haken .....	18-04
HEATH Ligatur Schere.....	08-40	Mikro Schere .....	09-07	Septatom BRUENINGS .....	46-11
HEYMANN Nasen Schere .....	07-18, 08-25	UNIVERSAL Draht und Blech Schere.....	08-42	Sequester Zange .....	32-10
IRIS Schere .....	07-16, 08-21	UNIVERSAL Verband Schere .....	08-50	SEUTIN Gips Schere.....	30-02
IRIS Augen Schere .....	08-22	USA MODEL Nabelschnur Schere .....	08-34	SEXTON Ohr Messer .....	44-06
IRIS Schere, große Ringe .....	08-19	VANNAS Iridectomie Schere .....	09-05	SHEA Ohr Mikro Schere .....	44-09
JACOBSON Mikro Schere .....	09-11	VANNAS Mikro Schere .....	09-12 bis 09-13	SHORTBENT Ligatur Schere .....	08-40
JOSEPH Schere.....	07-14, 08-16	WAGNER Schere.....	07-22	Sieb Auffang .....	70-22
KELLY Gynaekologische Schere.....	08-33	WAGNER Zahnfleisch Schere.....	08-42	SIEBOLD	
KELLY Gynäkologische Schere .....	07-22	WALDMANN Episiotomie Schere .....	08-34	Gynäkologische Schere .....	08-32
KILNER Schere .....	07-14, 08-17	WECKER Iris Schere.....	09-04	Gynäkologische Schere .....	07-21
KLINKENBERGH-LOTH Lungen- Thorax		WERTHEIM Praeparier Schere .....	08-32	Siebschale	
Schere .....	08-37	WESTCOTT Iridectomie Schere.....	09-02	aus Drahtgeflecht .....	88-13
KNAPP Schere.....	08-20	WESTCOTT Sehnen Schere.....	09-02	aus perforiertem Blech.....	88-13
KNOWLES Verband Schere .....	08-47	WULLSTEIN Ohr Mikro Schere .....	44-11	SIEGLE Ohr Spekula .....	44-02
LAGRANGE Zahnfleisch Schere.....	08-41	WULLSTEIN Ohr Mikro Mini Schere.....	44-11	SIEGLER HELLMANN Uterus-Faß Zange .....	70-38
LANDOLT Enukeleations Schere.....	08-25	YASARGIL Mikro Schere .....	09-10 bis 09-11	SILVER	
LANGE Verband Schere .....	08-44	SCHIMMELBUSCH Sterilisier Trommel.....	88-12	Dermatom .....	06-20
LEXER Schere .....	07-09	SCHINK Dermatom .....	06-21	Nasenplastik Meißel .....	46-14
LEXER-BABY Schere .....	07-10	SCHIOETZ Tonometer .....	43-08	SIMCOE Naht Kanüle.....	43-07
LEXER-BABY Präparier Schere.....	08-12	Schlanke Schere.....	08-05	SIMON	
LEXER-FINO Präparier Schere .....	08-12	Schlauch Klemme .....	12-19	Scharf Löffel .....	32-13
LEXER Präparier Schere .....	08-11	Schlinge		Uterus Kürette .....	70-48
LISTER Verband Schere .....	07-23, 08-45	ARLT Draht Schlinge .....	42-08	Wund Haken.....	18-12
LITTAUER Ligatur Schere.....	08-40	BILLEAU Ohr Schlinge.....	44-07	SIMPSON-BRAUN Geburts Zange.....	72-02
LITTLER Präparier Schere .....	08-13	Schlingen		SIMPSON Geburts Zange .....	72-02
LOCKLIN Schere .....	08-18	Nasen Schlingen .....	46-09	SIMPSON-LUIKART Geburts Zange.....	72-03
LORENZ Verband Schere.....	08-47	Tonsillen Schlingen .....	50-04	SIMS	
MAYO Schere.....	07-06, 08-07	Schlinge		Gynäkologische Schere .....	08-32
MAYO Linkshänder Schere.....	08-07	Ohr Schlinge.....	44-07	Gynäkologische Schere .....	07-21

## Inhaltsverzeichnis

Index  
Index  
Indice alfabético  
Indice alphabético

SIMS-MAIER Tupfer Zange.....	16-05	McIVOR Zungen Spatel.....	48-05	MOLLISON Wund Sperrer.....	18-17
SIMS		TOBOLD Zungen Spatel.....	48-02	PLESTER Wund Sperrer.....	18-14
Rektal Spekulum.....	68-02	WECKER Iris Spatel.....	42-08	ROSER-KOENIG Mund Sperrer.....	48-03
Uterus Depressor.....	70-39	WHEELER Cyclodialyse Spatel.....	42-09	SEEMANN-SEIFFERT Mund Sperrer.....	48-04
Uterus Dilator.....	70-30	WIEDER Zungen Spatel.....	48-02	WEITLANER-WULLSTEIN Wund Sperrer.....	18-14
Uterus Kürette.....	70-49 bis 70-50			WEITLANER Wund Sperrer.....	18-14
Uterus Sonde.....	70-39	Spekula		WHITEHEAD Mund Sperrer.....	48-04
Vaginal Spekulum.....	70-17	BOUCHERON Ohr Spekula.....	44-02	Spiegel	
SINGLEY Pinzette.....	10-05	BRUENINGS Ohr Spekula.....	44-02	Kehlkopf Spiegel.....	52-04
Skalpelli Abnehmer.....	06-06, 06-10	GRUBER Ohr Spekula.....	44-02	MICHEL Spiegel.....	46-04
Skalpelli Griff...06-02 bis 06-05, 06-07 bis 06-08		HARTMANN Ohr Spekula.....	44-02	Spiralbohrer.....	33-04
Skalpelli Griff		SIEGLE Ohr Spekula.....	44-02	Splitter Pinzette.....	10-06
CASPAR Mikro Skalpellgriff.....	06-12	TOYNBEE Ohr Spekula.....	44-02	SPRATT Scharf Löffel.....	32-12
LANDOLT Mikro Skalpellgriff.....	06-13	Spekulum		Spreizer	
Skalpelli		AUVARD Vaginal Spekulum.....	70-19	ALAN-PARKS Mastdarm Spreizer.....	68-03
JOSEPH Nasen.....	46-10	BARR Rektal Spekulum.....	68-02	BEESON Gips Spreizer.....	30-03
Skalpelli Klinge.....	06-06	BERLIND-AUVARD Vaginal Spekulum.....	70-19	CASPAR Cervical Wirbelsäule	
Skalpelli		BODENHAMMER Rektal Spekulum.....	68-02	Wund Spreizer.....	18-18
PARKER anatomische Skalpell.....	06-15	BRAUN Vaginal Spekulum.....	70-16	CASPAR Muskelab Spreizer.....	18-20
Steril, Mikro Klinge.....	06-13	BREISKY Vaginal Spekulum.....	70-20	FRAZIER Wund Spreizer.....	18-21
Skarifikateur GRAEFE.....	42-04	COLLIN Vaginal Spekulum.....	70-04	HAGLUND-STILLE Gips Spreizer.....	30-03
SKENE Haken Zange.....	70-31	COTTLE Nasen Spekulum.....	46-03	HENNIG Gips Spreizer.....	30-03
Sklerotom		CUSCO Vaginal Spekulum.....	70-04 bis 70-06	HERMANN Gips Spreizer.....	30-03
GUYTON-LUNDGAARD Sklerotom.....	42-05	CZERYNI Rektal Spekulum.....	68-02	QUATTRO Gips Spreizer.....	30-03
LUNDGAARD Sklerotom.....	42-05	DOYEN Vaginal Spekulum.....	70-18, 70-20	SMITH-BUIE Mastdarm Spreizer.....	68-03
SLUDER-BALLENGER Tonsillotom.....	50-05	FREEWAY-GRAVE Vaginal Spekulum.....	70-06	Spritze	
SMELLIE		GRAVE Vaginal Spekulum.....	70-02	REINER Ohr Spritze.....	44-05
Geburts Haken.....	72-06	HARTMANN-HALLE Nasen Spekulum.....	46-02	Tonsillen Spritze.....	50-05
Perforatorium.....	72-09	JACKSON Vaginal Spekulum.....	70-16	STACKE Ohr Sonde.....	20-02
SMILLIE Meniskotom.....	32-24	KALLMORGEN Vagina Spekulum.....	70-15	Standard Naht Besteck.....	26-08
SMITH-BUIE Mastdarm Spreizer.....	68-03	KILLIAN Septum Spekulum.....	46-03	Standgefäß.....	88-08
SMITH-PETERSEN		KOGAN Endo Spekulum.....	70-23	Stanzbesteck KEYES Haut.....	74-02
Flachmeißel.....	32-15	KRISTELLER		Stanze	
Hohlmeißel.....	32-15	Vaginal Spekulum.....	70-09 bis 70-14	BEYER Stanze.....	46-08
SMITH Sperr Elevator.....	42-02	LANDAU Vaginal Spekulum.....	70-22	CITELLI Stanze.....	46-08
SMITH US ARMY Verband Schere.....	08-44	MATHIEU Rektal Spekulum.....	68-02	DIETER Hammerkopf Stanze.....	44-10
SNELLEN		O'SULLIVAN-O'CONNOR		HAJEK-CLAUS Stanze.....	46-08
Draht Schlinge.....	42-08	Vaginal Spekulum.....	70-08	HAJEK-KOFLER Stanze.....	46-08
Entropium Pinzette.....	43-06	PEDERSON Vaginal Spekulum.....	70-03	HOLTH Kapsel Stanze.....	42-09
SOMER Uterus-Faß Zange.....	70-37	PRATT Rektal Spekulum.....	68-02	KERRISON Stanze.....	46-08
Sonde		SCHERBAK Vaginal Spekulum.....	70-21	STAUDE-MOORE Haken Zange.....	70-31
BOWMAN Tränenkanal Sonde.....	42-10	SEMM Vaginal Spekulum.....	70-07	St. CLAIR-THOMSON Ring Messer.....	46-19
BRUNNER Fuehrungshohl Sonde.....	26-04	SIMS Rektal Spekulum.....	68-02	STEINER-AUVARD Vaginal Spekulum.....	70-19
COLLIN Uterus Sonde.....	70-39	SIMS Vaginal Spekulum.....	70-17	STEINMANN Knochen Nagel.....	33-09
DESJARDINS Gallenstein Sonde.....	62-05	STEINER-AUVARD Vaginal Spekulum.....	70-19	STELZNER Rektum Schere.....	08-38
DOYEN Sonde.....	20-02	THUDICHUM Nasen Spekulum.....	46-02	Steril Einmalskalpell.....	06-10 bis 06-11
GUYON Gleit Sonde.....	66-12	TIECK-HALLE Nasen Spekulum.....	46-03	Sterilisier Container	
KIRSCHNER Fuehrungshohl Sonde.....	26-04	TRELAT Vaginal Spekulum.....	70-07	3/4.....	88-22 bis 88-24
KOCHER Kropf.....	54-04	Vienna Nasen Spekulum.....	46-02	Flach Halb.....	88-30 bis 88-31
KOENIG Fuehrungshohl Sonde.....	26-04	VOLTOLINI Nasen Spekulum.....	46-02	Große.....	88-18 bis 88-20
Markierung Sonde.....	44-15	WEISSBARTH Vaginal Spekulum.....	70-22	Sterilisier Container	
MARTIN Uterus Sonde.....	70-39	YANKAURH Nasenrachen Spekulum.....	46-04	Halb.....	88-26 bis 88-29
MAYO Nierenstein Sonde.....	62-10	SPENCER Ligatur Schere.....	08-40	Kleine.....	88-32 bis 88-33
MOYNIHAN Gallenstein Sonde.....	62-05	SPENCER-WELLS Arterien Klemme.....	12-07	Spezial.....	88-34 bis 88-37
NABATOFF Varicen Besteck Ohr Sonde.....	20-02	Sperre BOSE Tracheal.....	54-02	Sterilisier Zange.....	28-02
PAYR Fuehrungshohl Sonde.....	26-04	Sperrer		Steril Skalpell Klinge.....	06-09
SCHMIEDEN Fuehrungshohl Sonde.....	26-04	ADSON Baby Wund Sperrer.....	18-15	STERNBERG Lippen Halter.....	48-02
SCHMIEDEN-PAYR Fuehrungshohl Sonde.....	26-04	ADSON Wund Sperrer.....	18-15	Sternnummeißel LEBSCHE.....	32-17
SIMS Uterus Sonde.....	70-39	ALM Wund Sperrer.....	18-14	Stethoskop	
STACKE Ohr Sonde.....	20-02	BECKMANN-ADSON Wund Sperrer.....	18-15	BOWLES Stethoskop.....	02-06
VALLEIX Uterus Sonde.....	70-39	BECKMANN-EATON Wund Sperrer.....	18-16	FORD Stethoskop.....	02-06
Spalter VIRCHOW Schaedel.....	32-17	BECKMANN Wund Sperrer.....	18-16	FORD BOWLES Stethoskop.....	02-06
Spanner LOUTE Draht.....	33-11	CASPAR ges. Wirbelsäule		PINARD Stethoskop.....	02-06
Spannplatte.....	06-21	Wund Sperrer.....	18-19	STEVENS	
Spannschlüssel für Extensionbügel.....	33-10	CASPAR Wund Sperrer.....	18-20	Iris Pinzette.....	42-11
Spatel		CLOWARD Wund Sperrer.....	18-17	Linsen Haken.....	42-06
ANDREW Zungen Spatel.....	48-02	DARLING Wund Sperrer.....	18-17	Nadelhalter.....	24-06
BANGERTER Cyclodialyse Spatel.....	42-08	DAVIS-BOYLE Mund Sperrer.....	48-04	STEVENSON Sperr Elevator.....	42-03
BRUENINGS Zungen Spatel.....	48-02	DENHART Mund Sperrer.....	48-03	STEVENS	
BUCHWALD Zungen Spatel.....	48-02	DIMEDA Wund Sperrer.....	18-14	Tenotomie Schere.....	07-17, 08-23
CASTROVIEJO Cyclodialyse		DOYEN-JANSEN Mund Sperrer.....	48-03	STIEGLITZ Splitter Pinzette.....	10-06
Spatel.....	42-08 bis 42-09	Speerrer		STILLE	
CULLER Iris Spatel.....	42-08	FINSEN Wund Sperrer.....	18-14	Flachmeißel.....	32-14
ELSCHNIG Cyclodialyse Spatel.....	42-08	FRIEDMAN Perineorrhaph Sperrer.....	70-23	Gips Schere.....	30-02
FRENZEL Zungen Spatel.....	48-02	HEISTER Mund Sperrer.....	48-03	Handbohr Apparat.....	33-04
HARTMANN Zungen Spatel.....	48-02	JANSEN Wund Sperrer.....	18-14	Hohlmeißel.....	32-14
Holz Zungen Spatel.....	48-02	JENNINGS Mund Sperrer.....	48-04	STILLE-HORSLEY Knochensplitter Zange.....	32-07
KOCHER Blasen Spatel.....	66-04	KILNER-DOUGHTY Mund Sperrer.....	48-05	STILLE-LISTON Knochensplitter Zange.....	32-06
LEGUEU Blasen Spatel.....	66-04	McIVOR Mund Sperrer.....	48-05	STILLE-LUER Hohlmeißel Zange.....	32-04

STILLE  
Nierenstiel Klemme ..... 12-16  
Osteotom ..... 32-14  
Pinzette ..... 10-02  
STILLE-RUSKIN Hohlmeißel Zange ..... 32-05  
STILLE-SHERMAN Handbohr Apparat ..... 33-04  
Stimmgabel ..... 44-04  
DIMEDA Alu ..... 44-03  
HARTMANN ..... 44-03  
LUCAE ..... 44-04  
RYDEL-SEIFFER ..... 44-04  
Stirnlampe CLAR ..... 02-05  
Stirnspiegel ZIEGLER ..... 02-05  
St. MARTIN Naht Pinzette ..... 43-05  
STOCKMANN Penis Klemme ..... 66-10  
STONE Verschluss Klemme ..... 64-06  
STONE-WATT Darm Klemme ..... 64-06  
Strabismus Schere ..... 07-17, 08-24  
STRATTE Nadelhalter ..... 24-04  
STRAUSS Penis Klemme ..... 66-10  
Stripper BUNNELL Sehnen ..... 32-25  
STRUEMPEL Ohr Zängchen ..... 44-08  
STRULLY Neurochirurgische Schere ..... 08-35  
STRUYCKEN Nasen scharfe Zange ..... 46-07

**T**

TABB Sichel Messer ..... 44-14  
Tampon Stopfer LUNIATSCHKE ..... 50-02  
TARNIER Geburtszange,  
mit Achsenzugvorrichtung ..... 72-05  
Kranioklast ..... 72-09  
TAYLOR  
Perkussions Hammer ..... 02-07  
Spinal Haken ..... 32-24  
TEALE Haken Zange ..... 70-33  
TERSON Kapsel Pinzette ..... 43-04  
THOMS-ALLIS Darmfaß Zange ..... 64-02  
THOMS-GAYLOR Probeexcisions Zange ..... 70-42  
THOMSON-WALKER Blasen Wundsperrer ..... 66-06  
THOREK Lungen und Thorax Schere ..... 08-36  
THUDICHUM Nasen Spekulum ..... 46-02  
TIECK-HALLE Nasen Spekulum ..... 46-03  
TIEMANN Haken Zange ..... 70-32  
TILLEY Ohr Zängchen ..... 44-08  
TISCHLER-KEVORKIAN  
Probeexcisions Zange ..... 70-44 bis 70-45  
TISCHLER-MORGAN Probeexcisions  
Zange ..... 70-43 bis 70-44, 70-46  
TIVNEN Tonsillen Fass Zange ..... 50-04  
TOBOLD  
Watteträger ..... 20-03  
Zungen Spatel ..... 48-02  
TOENNIS-ADSON  
Neurochirurgische Schere ..... 08-35  
TOENNIS  
Arterien Klemme ..... 12-11  
Nadelhalter ..... 24-04  
TOHOKU Tuch Klemme ..... 14-04  
Tonometer SCHIOETZ ..... 43-08  
Tonsillotom SLUDER-BALLENGER ..... 50-05  
TOOK Hornhaut Messer ..... 42-05  
TOTI Fräser ..... 33-07  
TOWNSEND-KEVORKIAN Probeexcisions  
Zange ..... 70-44  
TOWNSEND-MINI (BABY TISCHLER)  
Probeexcisions Zange ..... 70-45  
TOWNSEND-mini Probeexcisions Zange ..... 70-44  
TOWNSEND Probeexcisions Zange ..... 70-44  
TOWNSEND-TISCHLER  
Probeexcisions Zange ..... 70-44  
TOYNBEE Ohr Spekula ..... 44-02  
TRAUBE Perkussions Hammer ..... 02-07  
TRELAT Vaginal Spekulum ..... 70-07  
Trephe ..... 33-04  
CASTROVIEJO Hornhaut Trephe ..... 43-07  
ELLIOT Hornhaut Trephe ..... 43-08  
FRANCESCHETTI Hornhaut Trephe ..... 43-07  
Trichter ..... 88-07

TROELTSCH Nasen Zange ..... 46-04  
TROMNER Perkussions Hammer ..... 02-07  
Trokar ..... 22-02  
COAKLEY Trokar ..... 22-02  
DOUGLAS Trokar ..... 22-02  
FLEURANT Trokar ..... 22-02  
LICHTWITZ Trokar ..... 22-02  
MENGHINI Trokar ..... 22-03  
NELSON Trokar ..... 22-02  
OCHSNER Trokar ..... 22-02  
PIERCE Trokar ..... 22-02  
UCKERMANN Tracheal Trokar ..... 54-02  
UNIVERSAL Trokar ..... 22-02  
Trommel  
KONRICH Sterilisier Trommel ..... 88-12  
SCHIMMELBUSCH Sterilisier Trommel ..... 88-12  
TROUSSEAU Tracheal Dilator ..... 54-02  
TROUTMAN-CASTROVIEJO Mikro Schere ..... 09-07  
TROUTMAN-CHRIS Klingenbrecher ..... 06-14  
TROUTMAN Colibri Iris Pinzette ..... 42-13  
TROUTMAN Rectus Pinzette ..... 43-02  
Tübingen  
Faden Pinzette ..... 43-05  
Iris Pinzette ..... 42-15  
Luft Kanüle ..... 43-07  
Tübingen TITAN  
Faden Pinzette ..... 43-05  
Iris Pinzette ..... 42-15  
TUFFIER Arterien Klemme ..... 12-08  
TURNBULL Nagel Zange ..... 74-03  
TURREL Biopsie Zange ..... 68-05  
TYDING  
Tonsillen Fass Zange ..... 50-04  
Tonsillen Schnürer ..... 50-05

**U**

UCKERMANN  
Tracheal Trokar ..... 54-02  
Watteträger ..... 20-03  
Uhrmacher Pinzette ..... 10-06  
ULRICH Schwamm Zange ..... 16-06  
UNIVERSAL  
Draht und Blech Schere ..... 08-42  
Sterilisier Zange ..... 28-02  
Trokar ..... 22-02  
Verband Schere ..... 08-50  
UNNA Komodonen Quetscher ..... 74-02  
Urethrotom OTIS ..... 66-08  
Urinal ..... 88-10  
USA MODEL Nabelschnur Schere ..... 08-34  
USA Pinzette ..... 10-02  
US Army (PARKER-LANGENBECK)  
Wund Haken ..... 18-03

**V**

VALLEIX Uterus Sonde ..... 70-39  
Valve  
BALFOUR Valve ..... 18-22  
CASPAR Valve ..... 18-20  
CASPAR Valve ges. Wirbelsäule ..... 18-19  
KIRSCHNER Valve ..... 18-23  
VAN BUREN  
Harnröhren Bougie ..... 66-13  
Sequester Zange ..... 32-10  
Van DOREN Probeexcisions Zange ..... 70-42  
VANNAS  
Iridectomie Schere ..... 09-05  
Mikro Schere ..... 09-12 bis 09-13  
VARIFOCAL Ophthalmoskop ..... 02-03  
Venenstauer ..... 02-03  
VERBRUGGE Knochenhalte Zange ..... 32-09  
VERRES Pneumoperitoneum  
Punktions Nadel ..... 22-03  
Vienna Nasen Spekulum ..... 46-02  
VIRCHOW  
Hirn Messer ..... 06-18  
Knorpel Messer ..... 06-18  
Schaedel Spalter ..... 32-17

VIRTUS (RALK) Splitter Pinzette ..... 10-06  
VOLKMANN  
Scharf Löffel ..... 32-12 bis 32-13  
Wund Haken ..... 18-07 bis 18-08  
VOLTOLINI Nasen Spekulum ..... 46-02  
Vorbohrer ..... 33-12  
KUENTSCHER Vorbohrer ..... 33-13

**W**

WACHENFELDT Wundklammer Zange ..... 26-07  
WADSWORTH-TODD Kauter ..... 42-08  
WAGENER-MOSHER Tracheal Kannule ..... 54-03  
WAGENER Ohr Häkchen ..... 44-07  
WAGNER  
Schere ..... 07-22  
Zahnfleisch Schere ..... 08-42  
WALDMANN Episiotomie Schere ..... 08-34  
WALLICH Plazentar und Abortus Löffel ..... 72-08  
WALSHAM Septum Zange ..... 46-18  
WALTHER Harnröhren Bougie ..... 66-17  
WALTON  
Fremdkörper Hohlmeißel ..... 42-06  
Komodonen Quetscher ..... 74-02  
WALTON YANKAUER Sauger ..... 04-03  
WANGENSTEIN  
Nadelhalter ..... 24-03  
Pinzette ..... 10-05  
WARTENBERG Nadelrad ..... 02-08  
Waschschüssel ..... 88-05  
WATSON-CHEYNE Elevatorien ..... 32-22  
WATSON Dermatome ..... 06-22  
Watteträger ..... 20-03  
DIMEDA Watteträger ..... 20-03  
FARREL Watteträger ..... 20-03  
JOBSON-HORNE Watteträger ..... 20-03  
TOBOLD Watteträger ..... 20-03  
UCKERMANN Watteträger ..... 20-03  
WEBER Draht Schlinge ..... 42-08  
WECKER  
Iris Schere ..... 09-04  
Iris Spatel ..... 42-08  
WEEK Sperr Elevator ..... 42-02  
WEIL-BLAKESLEY Nasen scharfe Zange ..... 46-06  
WEISSBARTH Vaginal Spekulum ..... 70-22  
WEISS Schlauch Klemme ..... 12-19  
WEITLANER-WULLSTEIN Wund Sperrer ..... 18-14  
WEITLANER Wund Sperrer ..... 18-14  
WELLS Eukleation Löffel ..... 42-08  
WERTHEIM-CULLEN Hysterektomie Klemme ..... 12-18  
WERTHEIM  
Hysterektomie Klemme ..... 12-18  
Praeparier Schere ..... 08-32  
WESTCOTT  
Iridectomie Schere ..... 09-02  
Sehnen Schere ..... 09-02  
WEST Nasen Hohl Meißel ..... 46-14  
WESTON Rektal Polypen Schnürer ..... 68-05  
WHEELER  
Cyclodialyse Spatel ..... 42-09  
Diszisions Messer ..... 42-04  
WHITEHEAD Mund Sperrer ..... 48-04  
WHITE Tonsillen Fass Zange ..... 50-03  
WIEDER Zungen Spatel ..... 48-02  
WIENER (AUFRICHT) Nasen Raspel ..... 46-15  
WIENER  
Iris Haken ..... 42-06  
Nasen Raspel ..... 46-15  
WIGMORE Gips Sage ..... 30-02  
WILDE  
Nasen Schnürer ..... 46-09  
Ohrpolypen Schnürer ..... 44-07  
WILDER  
Draht Schlinge ..... 42-08  
Tränenkanal Dilatore ..... 42-10  
WILDE (TROELTSCH) Ohr Pinzette ..... 44-07  
WILLET-MARTELL Kopfhaut Klemme ..... 12-08  
WILLIAMS



## Inhaltsverzeichnis

Index  
Index  
Indice alfabético  
Indice alphabétique

Darmfaß Zange .....	64-03
Schrauben Dreher .....	33-14
Sperr Elevator .....	42-02
WILLIGER	
Hammer .....	32-18
Raspatorien .....	32-19
Scharf Löffel .....	32-13
WINKELMANN Beschneidungs Klemme .....	66-09
WINTER Plazentar und Abortus Zange .....	72-07
Wirbelsmeißel BRUNETTI .....	32-17
WITTNER Probeexcisions Zange .....	70-43
WOLFF Gipsabreiss Zange .....	30-04
WRIGLEY Geburts Zange .....	72-02
WULLSTEIN	
Ohr Mikro mini Schere .....	44-11
Ohr Mikro Schere .....	44-11
Sichel Messer .....	44-14
Wund Haken .....	18-06, 18-10
Wundsperrerr	
HRYNTSCHAK Prostata Wundsperrerr .....	66-06
JUDD-MASSON Blasen Wundsperrerr .....	66-04
LEGUEU Blasen Wundsperrerr .....	66-06
MILLIN Blasen Wundsperrerr .....	66-05
THOMSON-WALKER Blasen Wundsperrerr .....	66-06
WYLIE Uterus Dilator .....	70-30

## Y

YANKAUER	
Nasentrachen Spekulum .....	46-04
Sauger .....	04-02
YASARGIL Mikro Schere .....	09-10 bis 09-11
MAN Biopsie Zange .....	68-05
YOUNG Boomerang Unterbindungs Nadel .....	26-03
YOUNG	
Prostata Faß Zange .....	66-02
Prostata Haken .....	66-02
Zungen Zange .....	48-03

## Z

Zahnfleisch Schere .....	08-41
Zängchen	
GREVEN Ohr Mikro Zängchen .....	44-10
HARTMANN-HOFFMANN Ohr Zängchen .....	44-08
HARTMANN Ohr Zängchen .....	44-08
HARTMANN-WULLSTEIN Ohr Zängchen .....	44-08
LITTAUER Ohr Zängchen .....	44-08
McGEE Ohr Mikro Zängchen .....	44-10
Ohr Mikro Zängchen 44-09 bis 44-10, 44-12	
Ohr Mikro Mini Zängchen .....	44-13
STRUEMPEL Ohr Zängchen .....	44-08
TILLEY Ohr Zängchen .....	44-08
Zange	
ADSON Hohlmeißel Zange .....	32-03
ALEXANDER Probeexcisions Zange .....	70-42
ALLIS-ADAIR Darmfaß Zange .....	64-02
ALLIS-BABY Darmfaß Zange .....	64-02
ALLIS Darmfaß Zange .....	64-02
ASCH Septum Zange .....	46-18
BABCOCK Darmfaß Zange .....	64-02
BAGGISH Probeexcisions Zange .....	70-45
BALLENGER Tonsillen Fass Zange .....	50-04
BARRETT Haken Zange .....	70-32
BARTON Geburts Zange .....	72-04
BERGMANN FOERSTER Schwamm Zange .....	16-10
BEYER Hohlmeißel Zange .....	32-04
BIRCHER-GANSKE Knochenhalte Zange .....	32-10
BLAKE Gallenstein Zange .....	62-03
BLOHMKE Tonsillen Fass Zange .....	50-04
BLUMENTHAL Hohlmeißel Zange .....	32-02
BOERMA Geburts Zange .....	72-04
BÖHLER Hohlmeißel Zange .....	32-04
BÖHLER Knochensplitter Zange .....	32-06

BONNEY Schwamm Zange .....	16-08
BOZEMANN-DOUGLAS Tupfer Zange .....	16-13
BOZEMANN Tupfer Zange .....	16-13
BRAUN Haken Zange .....	70-31, 70-34
BRUENINGS Kehlkopf Zange .....	52-03
BRUENINGS Nasen Zange, scharf .....	46-05
BRYANT Schwamm Zange .....	16-11
BUMM Uterus-Faß Zange .....	70-38
BURKE-Baby Probeexcisions Zange .....	70-44
BURKE Probeexcisions Zange .....	70-44
CHEATLE Sterilisier Zange .....	28-02
CHERON Tupfer Zange .....	16-12
CHEVALIER-JACKSON Kehlkopf Zange .....	52-04
CHILDE Wundklammer Zange .....	26-07
CLEVELAND Hohlmeißel Zange .....	32-02
COLLIN-POZZI Haken Zange .....	70-32
COLLIN Tupfer Zange .....	16-11
COLLIN Uterus-Faß Zange .....	70-37
COLLIN Wundklammer Zange .....	26-07
COLLIN Zungen Zange .....	48-03
COLVER Tonsillen Faß Zange .....	50-03
CORDES Kehlkopf Zange .....	52-03
COTTLE-KAZANJIAN Knochensplitter Zange .....	32-06
CZERNY Gallenstein Zange .....	62-03
CZERNY Haken Zange .....	70-34
DARTIGUES Uterus-Faß Zange .....	70-37
DAVIS Sterilisier Zange .....	28-02
De LEE Geburts Zange .....	72-02
DESJARDINS Gallenstein Zange .....	62-02
DEWEY Geburtszange, mit Achsenzugvorrichtung .....	72-05
DIMEDA Abfall Zange .....	28-03
DINGMANN Knochenhalte Zange .....	32-10
DOYEN Uterus-Polypen Zange .....	70-36
DUPLAY Haken Zange .....	70-31
DUPLAY Tupfer Zange .....	16-14
DUVAL Darmfaß Zange .....	64-03
ECHLIN Hohlmeißel Zange .....	32-05
ELLIOT Geburts Zange .....	72-02
ELSAESSER Nieren Fistel Zange .....	62-13
EPPENDORFER-KEVORKIAN Probeexcisions Zange .....	70-46
EPPENDORFER Probeexcisions Zange .....	70-45 bis 70-46
EPPENDORFER TISCHLER-MORGAN Probeexcisions Zange .....	70-46
FARABEUF Knochenhalte Zange .....	32-07
FARABEUF-LAMBOTTE Knochenhalte Zange .....	32-08
FAURE Probeexcisions Zange .....	70-41
FERGUSSON Knochenhalte Zange .....	32-07
Flach Zange .....	33-11
FLETCHER JAVERTS Schwamm Zange .....	16-10
FOERSTER Schwamm Zange 16-06 bis 16-08	
FRAENKEL Kehlkopf Polypus Zange .....	52-02
FRAENKEL Kehlkopf Zange .....	52-03
FRIEDMAN Hohlmeißel Zange .....	32-02
FRIEDMAN Mini Hohlmeißel Zange .....	32-02
FRYKHOLM Hohlmeißel Zange .....	32-05
GAUSS Kopfschwarten Zange .....	72-06
GELLHORN Probeexcisions Zange .....	70-42
GRIP Zange .....	33-11
GROSS-MAIER Tupfer Zange 16-02 bis 16-04	
GROSS Tupfer Zange .....	16-05
HARTMANN Nasen Polypus Zange .....	46-04
HARTMANN Nasen Zange, scharf .....	46-07
HEGENBARTH Wundklammer Zange .....	26-07
HEIMING Nierenstein Zange .....	62-13
HENROTIN Haken v .....	70-34
HEYMANN-KNIGHT Nasen Polypus Zange .....	46-05
HEYMANN Nasen Zange, scharf .....	46-05
Zange	
HEYWOOD-SMITH Hämorrhoid. Zange .....	68-05
IOWA Haken Zange .....	70-35
JACOBS Haken Zange .....	70-34
JANSEN Nasen Zange .....	46-04
JARCHO Haken Zange .....	70-32

JATHO Nasentrachen Zange .....	46-18
JUDD-ALLIS Darmfaß Zange .....	64-02
JURASZ Kehlkopf Polypus Zange .....	52-02
KELLY Uterus-Polypen Zange .....	70-36
KERN Knochenhalte Zange .....	32-08
KEVORKIAN-Pacific Probeexcisions Zange .....	70-44
KEVORKIAN Probeexcisions Zange .....	70-43, 70-46
KIELLAND Geburts Zange .....	72-02
KIELLAND-LUIKART Geburts Zange .....	72-03
KNIGHT Nasen Zange, scharf .....	46-05
KRAUSE Kehlkopf Zange .....	52-03
LAHEY Kropf Fass Zange .....	54-04
LAMBOTTE Knochenhalte Zange .....	32-08
LANE Knochenhalte Zange .....	32-08
LANE Knochenschraub. Halte Zange .....	33-14
LANGE Kehlkopf Zange .....	52-03
LANGENBECK Knochenhalte Zange .....	32-07
LEKSELL STILLE Hohlmeißel Zange .....	32-05
LEMPERT Hohlmeißel Zange .....	32-03
LEWIN Knochenhalte Zange .....	32-10
LEWKOWITZ Plazentar und Abortus Zange .....	72-07
LISTER Sinus Schwamm Zange .....	16-11
LITON Knochensplitter Zange .....	32-06
LITTAUER Nasen Polypus Zange .....	46-05
LUBET-BARBON Nasen Polypus Zange .....	46-05
LUC Nasen Zange, scharf .....	46-06
LUER Hohlmeißel Zange .....	32-03
LUIKART Geburts Zange .....	72-03
MAGILL Kathetereinführ Zange .....	04-06
MAIER Tupfer Zange .....	16-12
MARTIN Sequester Zange .....	32-10
MARTIN Tupfer Zange .....	16-02, 16-14
MATHIEU Fremdkörper Zange .....	66-07
MAYO BLAKE Gallenstein Zange .....	62-04
McCLINTOCK Plazentar und Abortus Zange .....	72-07
McLEAN Geburts Zange .....	72-04
McLEAN-LUIKART Geburts Zange .....	72-03
McLEAN-TUCKER-LUIKART Geburts Zange .....	72-03
MEAD Hohlmeißel Zange .....	32-02
MICHEL Wundklammer Zange .....	26-07
MIDDLETON-JANSEN Nasen Zange .....	46-09
MILLIN Fadenführungs Zange .....	66-03
MILLIN Faß vordere Lappen Zange .....	66-03
MILLIN Kapsel Faß Zange .....	66-03
MIXTER Gallenstein Zange .....	62-04
MUSEUX Haken Zange .....	70-33
MYLES Nasen Zange, scharf .....	46-07
NAEGELE Geburts Zange .....	72-03
Nagel Zange .....	74-03
Nagelhaut Zange .....	74-03
NOTO Uterus-Polypen Zange .....	70-36
NOYES Nasen Polypus Zange .....	46-05
OLIVECRONA Hohlmeißel Zange .....	32-03
PELMANN Tupfer Zange .....	16-12
PIPER Geburtszange .....	72-04
PIPER Geburtszange, mit Achsenzugvorrichtung .....	72-04
POZZI Haken Zange .....	70-31
PRATT Haken Zange .....	70-34 bis 70-35
RADOLF Nagelausreiss Zange .....	33-03
RAMPLEY Schwamm Zange .....	16-09
Zange	
RANDALL Nierenstein Zange 62-11 bis 62-12	
RICHTER-HEATH Wundklammer Zange .....	26-07
ROGGE Sterilisier Zange .....	28-02
ROSENBERG Kehlkopf Zange .....	52-03
ROWE Mund Zange .....	48-06
RUBIN Septum Quetsch Zange .....	46-07
RUSKIN Hohlmeißel Zange .....	32-04
RUSKIN-LITON Knochensplitter Zange .....	32-06
SAENGER Plazentar und Abortus Zange .....	72-07
SAIRGES Haken Zange .....	70-32
SAUERBRUCH Abfall Zange .....	08-03

SAUERBRUCH Hohlmeißel Zange .....	32-05
SCAGLIETTI Hohlmeißel Zange.....	32-05
Schneide- und Biege Zange .....	33-11
SCHEINMANN Kehlkopf Zange.....	52-03
SCHOENBURG Darmfaß Zange.....	64-03
SCHROEDER Haken Zange...70-31 bis 70-32	
SCHUBERT Probeexcisions Zange .....	70-41
SCHUMACHER Kehlkopf Zange .....	52-03
SCHUMACHER Probeexcisions Zange ..70-43	
SEIFFERT Kehlkopf Zange.....	52-03
SEMB Hohlmeißel Zange .....	32-06
SEMB Knochenhalte Zange .....	32-07
SEMB Knochensplitter Zange.....	32-07
SIEGLER HELLMANN Uterus-Faß Zange.70-38	
SIMPSON-BRAUN Geburts Zange .....	72-02
SIMPSON Geburts Zange.....	72-02
SIMPSON-LUIKART Geburts Zange .....	72-03
SIMS-MAIER Tupfer Zange .....	16-05
SKENE Haken Zange .....	70-31
SOMER Uterus-Faß Zange.....	70-37
STAUDE-MOORE Haken Zange .....	70-31
STILLE-HORSLEY Knochensplitter Zange .	32-07
STILLE-LISTON Knochensplitter Zange .....	32-06
STILLE-LUER Hohlmeißel Zange .....	32-04
STILLE-RUSKIN Hohlmeißel Zange .....	32-05
STRUYCKEN Nasen Zange, scharf .....	46-07
TARNIER Geburtszange, mit Achsenzugvorrichtung .....	72-05
TEALE Haken Zange.....	70-33
THOMS-ALLIS Darmfaß Zange.....	64-02
THOMS-GAYLOR Probeexcisions Zange	70-42
TIEMANN Haken Zange.....	70-32
TISCHLER-KEVORKIAN Probeexcisions Zange .....	70-44 bis 70-45
TISCHLER-MORGAN Probeexcisions Zange .....	70-43 bis 70-44, 70-46
TIVNEN Tonsillen Fass Zange .....	50-04
TOWNSEND-KEVORKIAN Probeexcisions Zange.....	70-44
TOWNSEND-MINI (BABY TISCHLER) Probeexcisions Zange .....	70-45
TOWNSEND-Mini Probeexcisions Zange .....	70-44
TOWNSEND Probeexcisions Zange .....	70-44
TOWNSEND-TISCHLER Probeexcisions Zange .....	70-44
TROELTSCH Nasen Zange .....	46-04
TURNBULL Nagel Zange.....	74-03
TURREL Biopsie Zange.....	68-05
TYDING Tonsillen Fass Zange.....	50-04
ULRICH Schwamm Zange .....	16-06
UNIVERSAL Sterilisier Zange .....	28-02
VAN BUREN Sequester Zange.....	32-10
VAN DOREN Probeexcisions Zange.....	70-42
VERBRUGGE Knochenhalte Zange.....	32-09
WACHENFELDT Wundklammer Zange ..26-07	
WALSHAM Septum Zange .....	46-18
WEIL-BLAKESLEY Nasen Zange, scharf..	46-06
WHITE Tonsillen Fass Zange.....	50-03
WILLIAMS Darmfaß Zange .....	64-03
WINTER Plazentar und Abortus Zange ..72-07	
WITTNER Probeexcisions Zange .....	70-43
WOLFF Gipsabreiss Zange .....	30-04
WRIGLEY Geburts Zange.....	72-02
YEOMAN Biopsie Zange.....	68-05
YOUNG Prostata Faß Zange .....	66-02
YOUNG Zungen Zange .....	48-03
ZAUFAL-JANSEN Hohlmeißel Zange .....	32-04
ZAUFAL-JANSEN Hohlmeißel Zange.....	32-04
ZENKER Präparier und Ligatur Klemme .....	12-12
ZIEGLER Iris Messer .....	42-04
Kapsulotomie Messer.....	42-05
Sperr Elevator.....	42-03
Stirnspiegel .....	02-05
Tränenkanal Dilatatore.....	42-10
Zubehör für Sterilisier Container..88-38 bis 88-41	



## Inhaltsverzeichnis

Index

Index

Índice alfabético

Índice alfabético

DE

**Inhaltsverzeichnis**

Index  
Index  
Índice alfabético  
Índice alfabético

**A**

Accessories for sterilization container . . . . .88-38 to 88-41  
 Adenotome LAFORCE . . . . .46-19  
 ADLERKREUTZ thumb and tissue forceps . .10-04  
 ADSON BABY hemostatic forceps . . . . .12-09  
 ADSON-Baby retractor . . . . .18-15  
 ADSON  
 bone rongeur . . . . .32-03  
 ADSON-BROWN thumb and tissue forceps 10-03  
 ADSON  
 elevator . . . . .32-21  
 hemostatic forceps . . . . .12-09  
 hypophyseal forceps . . . . .EA-06  
 needle holder . . . . .24-04  
 nerve hook . . . . .EA-04  
 retractor . . . . .18-15  
 thumb and tissue forceps . . . . .10-03  
 thumb and tissue, micro forceps . . . . .10-03  
 AEBL corneal scissors . . . . .08-22  
 AESCULAP electrosurgery equipment cable JA-07  
 Air bag POLITZER . . . . .44-05  
 ALAN-PARKS anal retractor . . . . .68-03  
 ALBEE drill burr . . . . .33-07  
 ALEXANDER  
 bone chisel . . . . .32-14  
 bone gouge . . . . .32-14  
 periosteal elevator . . . . .32-19  
 uterine biopsy specimen forceps . . . . .70-42  
 ALLIS-ADAIR tissue forceps . . . . .64-02  
 ALLIS-Baby tissue forceps . . . . .64-02  
 ALLISON lung spatula . . . . .FG-19  
 ALLIS tissue forceps . . . . .64-02  
 ALM retractor . . . . .18-14  
 ALVIS foreign body curette . . . . .42-06  
 Amniotome BEACHAM . . . . .70-39  
 Amputation knife . . . . .06-16  
 ANDREWS-PINCHON suction tube . . . . .04-03  
 ANDREW tongue depressor . . . . .48-02  
 Anoscope  
 HIRSCHMANN . . . . .68-04  
 IVES-FANSLER . . . . .68-04  
 Apparatus  
 BARANY noise . . . . .44-04  
 PETZ stomach and intestinal suturing . .64-09  
 ARCHER splinter forceps . . . . .10-06  
 ARKANSAS grinding stone . . . . .06-19  
 ARLT wire loop . . . . .42-08  
 ARRUGA  
 capsular forceps . . . . .43-04  
 extracting hook . . . . .42-06  
 eye speculum . . . . .42-02  
 ophthalmological needle holder . . . . .24-06  
 protector . . . . .42-08  
 ASCH septum forceps . . . . .46-18  
 Atraumatic pediatric vascular forceps . . .BD-43  
 AUFRIEHT nasal retractor . . . . .46-17  
 AUVARD vaginal speculum . . . . .70-19  
 AXENFELD chalazion curette . . . . .42-07  
 AYER chalazion forceps . . . . .43-06

**B**  
 BABCOCK seizing forceps . . . . .64-02  
 BABINSKY percussion hammer . . . . .02-07  
 BACKHAUS-CLIP tube holder towel clamp .14-03  
 BACKHAUS KOCHER towel clamp . . . . .14-02  
 BACKHAUS towel clamp . . . . .14-02  
 BAGGISH uterine biopsy specimen forceps 70-45  
 BAILEY-BABY rib contractor . . . . .FG-18  
 BAILEY-GIBBON rib contractor . . . . .FG-18  
 BAILEY rib contractor . . . . .FG-18  
 BAINBRIDGE  
 atraumatic forceps . . . . .BD-09  
 hemostatic forceps . . . . .12-14  
 BAKES gall duct dilator . . . . .62-06  
 BALFOUR  
 abdominal retractor . . . . .18-22  
 BALFOUR Baby abdominal retractor . . .18-22

BALFOUR  
 blade . . . . .18-22  
 BALL AND SOCKET towel clamp . . . . .14-04  
 Ball coagulation electrode . . . . .JA-03  
 BALLENGER  
 septum elevator . . . . .46-12  
 swivel knife . . . . .46-11  
 tonsil seizing forceps . . . . .50-04  
 Band PARHAM . . . . .32-11  
 BANGERTER cyclodialysis spatula . . . . .42-08  
 BARANY noise apparatus . . . . .44-04  
 BARBARA  
 hooklet . . . . .44-14  
 needle . . . . .44-14  
 pick . . . . .44-14 to 44-15  
 BARKAN goniotomy knife . . . . .42-05  
 BARNHILL adenoid curette . . . . .46-19  
 BARRAQUER-KATZIN iris forceps . . . . .42-13  
 BARRAQUER Colibri iris forceps . . . . .42-13  
 BARRAQUER  
 anterior chamber forceps . . . . .43-02  
 cilia forceps . . . . .43-08  
 BARRAQUER Colibri eye speculum . . . . .42-02  
 BARRAQUER  
 colibri scissors . . . . .09-04  
 fixation forceps . . . . .43-03  
 keratoplasty knife . . . . .42-05  
 needle holder . . . . .24-07  
 BARRETT tenaculum forceps . . . . .70-32  
 BARR rectal speculum . . . . .68-02  
 BARTON  
 obstetrical forceps . . . . .72-04  
 traction handle . . . . .72-04  
 BAUMGARTNER needle holder . . . . .24-02  
 BEACHAM amniotome . . . . .70-39  
 Beaker . . . . .88-10  
 BECK atraumatic peripheral vascular forcepsBD-25  
 BECKER cystotome . . . . .42-06  
 BECKMANN  
 adenoid curette . . . . .46-19  
 BECKMANN-ADSON retractor . . . . .18-15  
 BECKMANN-EATON retractor . . . . .18-16  
 BECKMANN  
 retractor . . . . .18-16  
 BEEBEE wire and plate scissors . . . . .08-43  
 BEER cilia forceps . . . . .43-08  
 BEESON plaster spreader . . . . .30-03  
 BELLUCCI ear micro scissors . . . . .44-09  
 BENGOLEA hemostatic forceps . . . . .12-09  
 BENNETT bone lever . . . . .32-22  
 BERENS keratome . . . . .42-04  
 BERGMANN bandage scissors . . . . .08-46  
 BERGMANN FOERSTER sponge holding forceps  
 16-10  
 BERGMANN plaster saw . . . . .30-02  
 BERKE muscular forceps . . . . .43-02  
 BERLIND-AUVARD vaginal speculum . . .70-19  
 BERLINER percussion hammer . . . . .02-07  
 BERNHARD towel clamp . . . . .14-05  
 BERTILLON cephalometer . . . . .02-08  
 BEST intestinal forceps . . . . .64-06  
 BETHUNE rib shear . . . . .FG-04  
 BEUSE scissors toothed . . . . .08-26  
 BEYER  
 bone rongeur . . . . .32-04  
 punch . . . . .46-08  
 BILLEAU ear loop . . . . .44-07  
 BILL traction handle . . . . .72-05  
 BIRCHER-GANSKE bone holding forceps . .32-10  
 BIRCHER meniscotome . . . . .32-24  
 BISHOP-HARMAN iris forceps . . . . .42-14  
 Blade  
 BALFOUR . . . . .18-22  
 Blade breaker  
 CASTROVIEJO . . . . .06-14  
 DIMEDA . . . . .06-14  
 TROUTMAN-CHRIS . . . . .06-14  
 Blade  
 CASPAR . . . . .18-20

CASPAR vertebral column . . . . .18-19  
 HUMBY dermatome . . . . .06-20  
 KIRSCHNER abdominal retractor . . . . .18-23  
 OTIS spare . . . . .66-08  
 BLAKE  
 gall stone forceps . . . . .62-03  
 uterine curette . . . . .70-48  
 BLOHMKE tonsil seizing forceps . . . . .50-04  
 Blood pressure apparatus . . . . .02-02  
 BLOUNT  
 bone lever . . . . .32-24  
 knee retractor . . . . .32-24  
 BLUMENTHAL bone rongeur . . . . .32-02  
 BODENHAMMER rectal speculum . . . . .68-02  
 BOEHLER 16x9 cm extension bow . . . . .33-10  
 BOERMA obstetrical forceps . . . . .72-04  
 BOETTCHER tonsil scissors . . . . .08-27  
 BOEHLER  
 bone cutting forceps . . . . .32-06  
 bone rongeur . . . . .32-04  
 BONACCOLTO strabismus forceps . . . . .42-14  
 Bone holding forceps . . . . .32-09 to 32-10  
 Bone wire . . . . .33-11  
 BONNEY sponge holding forceps . . . . .16-08  
 Bonn  
 iris forceps . . . . .42-15  
 irrigating cannula . . . . .43-07  
 Bonn TITAN iris forceps . . . . .42-15  
 BORCHARDT drill burr . . . . .33-07  
 BOSE  
 tracheal hook . . . . .54-02  
 tracheal spreader . . . . .54-02  
 BOUCHERON ear specula . . . . .44-02  
 Bougiem FILIFORM . . . . .66-12  
 Bowl . . . . .88-04  
 BOWLES stethoscope . . . . .02-06  
 Bowl  
 kidney . . . . .88-07  
 solution . . . . .88-05  
 BOWMAN  
 discision knife . . . . .42-04  
 discision needle . . . . .42-05  
 eye speculum . . . . .42-02  
 lachrymal probe . . . . .42-10  
 BOYNTON ophthalmological needle holder24-06  
 BOZEMANN-DOUGLAS swab forceps . . .16-13  
 BOZEMANN  
 swab forceps . . . . .16-13  
 needle holder . . . . .24-03  
 BRAIN MINI clip applying forceps . . . . .EA-12  
 BRAIN  
 standard clip . . . . .EA-13  
 BRAIN STANDARD clip applying forceps . .EA-12  
 BRAIN  
 temporary clip . . . . .EA-12  
 BRAITHWAITE dermatome . . . . .06-22  
 BRAUN  
 cranioclast . . . . .72-09  
 decapitating hook . . . . .72-09  
 BRAUN-STADLER episiotomy scissors07-22, 08-34  
 BRAUN  
 tenaculum forceps . . . . .70-31, 70-34  
 uterine depressor . . . . .70-39  
 vaginal speculum . . . . .70-16  
 Breaker WOLFF plaster . . . . .30-04  
 BREISKY vaginal speculum . . . . .70-20  
 BROCK  
 mitral valve dilator handle . . . . .FG-26  
 mitral valve dilator opening . . . . .FG-26  
 mitral valve dilator punch . . . . .FG-26  
 BROWN thumb and tissue forceps . . . .10-03  
 BRUENINGS  
 ear specula . . . . .44-02  
 extension tube . . . . .52-03  
 larynx forceps . . . . .52-03  
 nasal cutting forceps . . . . .46-05  
 septatome . . . . .46-11  
 tongue depressor . . . . .48-02  
 tonsil snare . . . . .50-04

BRUNETTI spine chisel . . . . .	32-17	DITTEL . . . . .	66-11	antrum curette . . . . .	46-18
BRUNNER		GUYON . . . . .	66-11	trocax . . . . .	22-02
intestinal forceps . . . . .	64-06	Catheter		COLCLOUGH intervertebral disc rongeur . .	EA-11
ligature conductor . . . . .	26-04	ITARD ear . . . . .	44-06	COLLIER needle holder . . . . .	24-02
rib shear . . . . .	FG-07	metal, female . . . . .	66-16	COLLIN	
BRUNS		metal, male . . . . .	66-16	abdominal retractor . . . . .	18-24 to 18-25
bone curette . . . . .	32-12 to 32-13	CATLIN amputation knife . . . . .	06-16	clip applying forceps . . . . .	26-07
plaster scissors . . . . .	08-48	Cauter WADSWORTH-TODD . . . . .	42-08	dressing forceps . . . . .	16-11
BRYANT sponge holding forceps . . . . .	16-11	Cephalometer BERTILLON . . . . .	02-08	COLLIN-DUVAL thumb and tissue forceps .	10-04
BUCHWALD tongue depressor . . . . .	48-02	CHAPUT hemostatic forceps . . . . .	12-08	COLLIN	
BUCK		CHARRIERE		dynamometer . . . . .	02-03
ear curette . . . . .	44-05	amputation saw . . . . .	33-03	hammer . . . . .	32-18
foreign body lever . . . . .	44-08	blade saw . . . . .	33-03	COLLIN-HARTMANN retractor . . . . .	18-03
ligature scissors . . . . .	08-40	CHEATLE sterilizing forceps . . . . .	28-02	COLLIN	
percussion hammer . . . . .	02-07	CHERON dressing forceps . . . . .	16-12	hemostatic forceps . . . . .	12-08
BUJE aspirating cannula . . . . .	68-05	CHEVALIER-JACKSON larynx forceps . . .	52-04	pelvimeter . . . . .	72-06
BUMM		CHEVALIER rib spreader . . . . .	FG-15	COLLIN-POZZI tenaculum forceps . . . . .	70-32
uterine curette . . . . .	70-49 to 70-50	CHILDE clip applying forceps . . . . .	26-07	COLLIN	
uterine elevating forceps . . . . .	70-38	Chisel		scalpel handle . . . . .	06-08
BUNGE exenteration scoop . . . . .	42-07	ALEXANDER bone . . . . .	32-14	tongue holding forceps . . . . .	48-03
BUNNELL		bone . . . . .	32-14	umbilical cord clamps . . . . .	72-06
bone hand drill . . . . .	33-05	BRUNETTI spine . . . . .	32-17	uterine elevating forceps . . . . .	70-37
tendon stripper . . . . .	32-25	CINELLI rhinoplastic . . . . .	46-13	uterine sound . . . . .	70-39
BUNT safety needle . . . . .	28-02	COTTLE rhinoplastic . . . . .	46-13	vaginal speculum . . . . .	70-04
BURCH fixation fork . . . . .	42-05	FOMON rhinoplastic . . . . .	46-13	COLLYER pelvimeter . . . . .	72-06
BURKE Baby uterine biopsy specimen forceps	70-44	FREER septum . . . . .	46-12	COLVER tonsil seizing forceps . . . . .	50-03
BUSCH umbilical scissors . . . . .	08-34	HIBBS bone . . . . .	32-16	Comprimeter . . . . .	33-02
		HOKE bone . . . . .	32-16	Conductor	
		LEBSCHKE sternum . . . . .	32-17	BRUNNER ligature . . . . .	26-04
		LEXER bone . . . . .	32-16	KIRSCHNER ligature . . . . .	26-04
		LEXER mini bone . . . . .	32-16	KOENIG ligature . . . . .	26-04
		PARTSCH bone . . . . .	32-14	PAYR ligature . . . . .	26-04
		ROLLET extirpation . . . . .	42-06	SCHMIEDEN ligature . . . . .	26-04
		SILVER rhinoplastic . . . . .	46-14	SCHMIEDEN-PAYR ligature . . . . .	26-04
		SMITH-PETERSEN bone . . . . .	32-15	Cone	
		STILLE bone . . . . .	32-14	KNUTSON-KOCH urethrography . . . . .	66-09
		WEST nasal . . . . .	46-14	occlusion . . . . .	70-47
		CINELLI rhinoplastic chisel . . . . .	46-13	CONNIN-AMSLER marker . . . . .	42-09
		CITELLI punch . . . . .	46-08	Contractor	
		Clamp		BAILEY-BABY rib . . . . .	FG-18
		DeMARTEL-WOLFSON anastomosis . . . .	64-07	BAILEY-GIBBON rib . . . . .	FG-18
		LANE stomach . . . . .	64-08	BAILEY rib . . . . .	FG-18
		LOWMAN bone holding . . . . .	32-11	SELLORS rib . . . . .	FG-18
		LURZ ureter . . . . .	62-10	Conventional laryngoscope handle . . . .	AE-17
		PAYR-Baby stomach . . . . .	64-09	CONVERSE nasal knife . . . . .	46-10
		PAYR stomach . . . . .	64-09	COOLEY	
		SATINSKY anastomosis (vena cava)FG-24 to	FG-25	atraumatic anastomosis forceps BD-37, BD-40	
		FG-25		atraumatic bulldog clamps . . . . .	BD-33 to BD-34
		Clamps		atraumatic forceps 11-03, BD-35 to BD-37, BD-	39, BD-41
		COLLIN umbilical cord . . . . .	72-06	atraumatic iliac forceps . . . . .	BD-37
		COOLEY atraumatic bulldog . . . . .	BD-33 to BD-34	atraumatic pediatric forceps . . . . .	BD-38 to BD-39
		DE BAKEY atraumatic bulldog . . . . .	12-02	atrium retractor . . . . .	FG-20
		DIEFFENBACH serrefine bulldog . . . . .	12-03	COOLEY DERRA atraumatic anastomosis forceps	BD-39
		GLOVER atraumatic bulldog . . . . .	12-02	COOLEY	
		JOHNS-HOPKINS serrefine bulldog . . . .	12-03	mitral valve dilator . . . . .	FG-27 to FG-29
		Clamp		COOLEY modif- STRUCK atrium retractor .	FG-20
		spermatic cord fixation . . . . .	66-10	COOLEY	
		STOCKMANN Penile . . . . .	66-10	rib first shear . . . . .	FG-05
		STRAUSS Penile . . . . .	66-10	rib spreader . . . . .	FG-09
		WINKELMANN circumcision . . . . .	66-09	vascular dilator . . . . .	FG-30
		CLAR		vascular forceps . . . . .	BD-40
		head lamp . . . . .	02-05	COOPER ligature needle . . . . .	26-02
		CLARK eye speculum . . . . .	42-02	CORDES larynx forceps . . . . .	52-03
		CLAR		Corn cutter CREDO . . . . .	74-03
		mini head light . . . . .	02-05	CORWIN tonsil hemostat . . . . .	50-04
		Cleaning brush . . . . .	28-04 to 28-05	CORYLLOS rib shear . . . . .	FG-04
		CLEVELAND bone rongeur . . . . .	32-02	CORYLLOS (Thorax) retractor . . . . .	18-13
		Clip		COTTLE-KAZANJIAN bone cutting forceps .	32-06
		BRAIN standard . . . . .	EA-13	COTTLE	
		BRAIN temporary . . . . .	EA-12	nasal knife . . . . .	46-10
		Clip carrier . . . . .	EA-02	nasal retractor . . . . .	46-17
		Clip		nasal scissors . . . . .	07-18, 08-25
		EDWARDS . . . . .	BD-21	nasal specula . . . . .	46-03
		MICHEL . . . . .	26-07	COTTLE-NEIVERT nasal retractor . . . . .	46-17
		RANEY scalp hemostasis . . . . .	EA-03	COTTLE	
		CLOWARD		periosteal elevator . . . . .	46-12
		lamina spreader . . . . .	EA-07	rhinoplastic chisel . . . . .	46-13
		retractor . . . . .	18-17		
		COAKLEY			





Inhaltsverzeichnis  
**Index**  
 Index  
 Índice alfabético  
 Índice alfabético

septum elevator . . . . .	46-12	GRAEFE . . . . .	42-06	DESJARDINS	
Cotton applicator . . . . .	20-03	CZERNY		gall duct forceps . . . . .	12-15
DIMEDA . . . . .	20-03	gall stone forceps . . . . .	62-03	gall stone forceps . . . . .	62-02
FARREL . . . . .	20-03	rectal speculum . . . . .	68-02	gall stone probe . . . . .	62-05
JOBSON-HORNE . . . . .	20-03	tenaculum forceps . . . . .	70-34	gall stone scoop . . . . .	62-08
TOBOLD . . . . .	20-03			DESMARRES	
UCKERMANN . . . . .	20-03	D		Chalazion forceps . . . . .	43-06
COXETER urethral sound . . . . .	66-17	DALE atraumatic peripheral vascular forceps	BD-24	retractor . . . . .	18-07
CRAFOORD		DANDY		DEUTSCHMANN cataract knife . . . . .	42-03
hemostatic bronchus forceps . . . . .	12-12	hemostatic forceps . . . . .	12-07	DeVILBISS skull forceps . . . . .	EA-05
lung and thorax scissors . . . . .	08-36	nerve hook . . . . .	EA-04	DEWEY obstetrical, with traction rod forceps	72-05
Cranioclast		neurosurgical scissors . . . . .	08-36	Diagnostic set . . . . .	02-04
BRAUN . . . . .	72-09	DARDIK atraumatic forceps . . . . .	BD-07	DIAMANT wire cutter . . . . .	33-12
TARNIER . . . . .	72-09	DARLING retractor . . . . .	18-17	DIEFFENBACH serrifine bulldog clamps . . . . .	12-03
CREDO corn cutter . . . . .	74-03	DARTIGUES uterine elevating forceps . . . . .	70-37	DIETER malleus nipper . . . . .	44-10
CRILE		DASTOOR		DIETHRICH	
hemostatic forceps . . . . .	12-05	erisophake . . . . .	42-09	atraumatic forceps . . . . .	BD-31
CRILE-MURRAY needle holder . . . . .	24-02	strabismus forceps . . . . .	42-14	vascular needle holder . . . . .	24-06
CRILE		DAVIDSON (Scapula) retractor . . . . .	18-13	vascular scissors . . . . .	08-29
needle holder . . . . .	24-04	DAVIEL cataract spoon . . . . .	42-07	Dilator	
CRILE-RANKIN hemostatic forceps . . . . .	12-05	DAVIS-BOYLE mouth gag . . . . .	48-04	BAKES gall duct . . . . .	62-06
CRILE		DAVIS		CASTROVIEJO lachrymal . . . . .	42-10
retractor . . . . .	18-02	dura dissector . . . . .	EA-05	COOLEY mitral valve . . . . .	FG-27 to FG-29
CRILE TITAN hemostatic forceps . . . . .	12-05	foreign body needle . . . . .	42-05	COOLEY vascular . . . . .	FG-30
CRILE-WOOD needle holder . . . . .	24-02	sterilizing forceps . . . . .	28-02	DE BAKEY vascular . . . . .	FG-31
CRITCHETT eye speculum . . . . .	42-02	DAY ear hooklet . . . . .	44-07	GERBODE mitral valve . . . . .	FG-28
CRUTCHFIELD		DEAN		GOODELL uterine . . . . .	70-30
cervical traction tong . . . . .	EA-03	iris knife . . . . .	42-04	HANK uterine . . . . .	70-28
drill bit . . . . .	EA-03	tonsil scissors . . . . .	08-26	HEGAR uterine . . . . .	70-24 to 70-27
CULLER iris spatula . . . . .	42-08	DEAVER Grip retractor . . . . .	18-05	HETZER mitral valve . . . . .	FG-29
Cup		DEAVER		LABORDE tracheal . . . . .	54-02
medicine . . . . .	88-07	retractor . . . . .	18-05	PRATT uterine . . . . .	70-29
sputum . . . . .	88-06	scissors . . . . .	07-05, 08-06	SIMS uterine . . . . .	70-30
Curette		DE BAKEY		TROUSSEAU tracheal . . . . .	54-02
ALVIS foreign body . . . . .	42-06	atraumatic anastomosis forceps . . . . .	BD-25	TUBBS mitral valve . . . . .	FG-27
AXENFELD chalazion . . . . .	42-07	atraumatic aortic-aneurysm forceps	BD-13, BD-15, BD-18	WILDER lachrymal . . . . .	42-10
BARNHILL adenoid . . . . .	46-19	atraumatic bronchus forceps . . . . .	BD-19	WYLIE uterine . . . . .	70-30
BECKMANN adenoid . . . . .	46-19	atraumatic bulldog clamps . . . . .	12-02	ZIEGLER lachrymal . . . . .	42-10
BLAKE uterine . . . . .	70-48	atraumatic dissecting and ligature forceps	BD-25, BD-32	DIMEDA Alu tuning fork . . . . .	44-03
BRUNS bone . . . . .	32-12 to 32-13	atraumatic forceps		DIMEDA	
BUMM uterine . . . . .	70-49 to 70-50	. . . . .	11-03, BD-02, BD-08, BD-16 to BD-17, BD-20, BD-28 to BD-30	bandage scissors . . . . .	08-46
COAKLEY antrum . . . . .	46-18	atraumatic iliac forceps . . . . .	BD-11	blade breaker . . . . .	06-14
FAULKNER . . . . .	46-18	atraumatic peripheral vascular forceps . . . . .	BD-06	cotton applicator . . . . .	20-03
FOX lupus . . . . .	74-02	DE BAKEY BAHNSON atraumatic		eye magnet . . . . .	43-08
GOURDET uterine . . . . .	70-48	aortic-aneurysm forceps . . . . .	BD-14	finger ring cutter . . . . .	33-03
HALLE bone . . . . .	32-13	DE BAKEY MORRIS atraumatic forceps . . . . .	BD-16	retractor . . . . .	18-14
HEBRA chalazion . . . . .	42-07	DE BAKEY		waste pickup forceps . . . . .	28-03
HOUSE . . . . .	44-15	needle holder . . . . .	24-03	DINGMANN bone holding forceps . . . . .	32-10
KEVORKIAN uterine biopsy aspirating . . . . .	70-40	DE BAKEY REYNOLDS atraumatic		Director . . . . .	20-02
LEMPERT bone . . . . .	32-13	anastomosis forceps . . . . .	BD-30	DOYEN . . . . .	20-02
MARTINI bone . . . . .	32-13	DE BAKEY SATINSKY atraumatic forceps . . . . .	BD-22	KOCHER goitre . . . . .	54-04
MEYHOEFER chalazion . . . . .	42-07	DE BAKEY		Dish PETRI . . . . .	88-08
NOVAK uterine biopsy aspirating . . . . .	70-40	suction tube . . . . .	04-04	Dissecting knife . . . . .	06-15
PIFFARD lupus . . . . .	74-02	vascular dilator . . . . .	FG-31	Dissecting large rings scissors . . . . .	08-19
RANDALL uterine biopsy aspirating . . . . .	70-40	vascular scissors . . . . .	08-30	Dissecting scissors . . . . .	08-34
RECAIMER uterine . . . . .	70-49 to 70-50	DEJERINE percussion hammer . . . . .	02-07	Dissector	
SCHUDE bone . . . . .	32-12	De LEE obstetrical forceps . . . . .	72-02	DAVIS dura . . . . .	EA-05
SCHROEDER uterine . . . . .	70-48	Delicate model towel clamp . . . . .	14-02	dura . . . . .	EA-05
SIMON bone . . . . .	32-13	Delicate scissors . . . . .	08-05, 08-24	FISCH . . . . .	44-15
SIMON uterine . . . . .	70-48	De MARTEL saw conductor . . . . .	EA-05	GREEN corneal . . . . .	42-06
SIMS uterine . . . . .	70-49 to 70-50	DeMARTEL-WOLFSON anastomosis clamp . . . . .	64-07	HORSLEY dura . . . . .	EA-06
SPRATT bone . . . . .	32-12	DENHART mouth gag . . . . .	48-03	HURD tonsil . . . . .	50-02
St. CLAIR-THOMSON adenoid . . . . .	46-19	Depressor		LANG lachrymal . . . . .	42-08
suction . . . . .	70-51	BRAUN uterine . . . . .	70-39	MILLIGAN dura . . . . .	EA-05
VOLKMANN bone . . . . .	32-12 to 32-13	SIMS uterine . . . . .	70-39	PATON corneal . . . . .	42-05
WILLIGER bone . . . . .	32-13	DERF needle holder . . . . .	24-02	PENFIELD dura . . . . .	EA-06
Curette BUCK ear . . . . .	44-05	Dermatome blade . . . . .	06-21	ROBB vascular . . . . .	FG-33
CUSCO vaginal speculum . . . . .	70-04 to 70-06	Dermatome		SACHS dura . . . . .	EA-05
CUSHING		BRAITHWAITE . . . . .	06-22	TOENNIS dura . . . . .	EA-05
brain spatula . . . . .	EA-07	HUMBY . . . . .	06-20	DITTEL	
drill burr . . . . .	33-04	SCHINK . . . . .	06-21	catheter introducer . . . . .	66-11
laminectomy ronger . . . . .	EA-08	SILVER . . . . .	06-20	urethral sound . . . . .	66-18 to 66-19
nerve hook . . . . .	EA-04	WATSON . . . . .	06-22	DIX	
retractor . . . . .	18-07	DERRA atraumatic anastomosis, pediatric forceps	BD-28	foreign body needle . . . . .	42-09
thumb and tissue forceps . . . . .	10-03	DESCHAMPS ligature needle . . . . .	26-02	foreign body spud . . . . .	42-06
Cutter McKENZIE . . . . .	33-04			DOUGLAS	
CUZZI placenta and ovum scoop . . . . .	72-08			cilia forceps . . . . .	43-08
Cystotome				trocac . . . . .	22-02
BECKER . . . . .	42-06			DOYEN-Baby intestinal forceps . . . . .	64-03



DOYEN			
director	20-02		
drill burr	33-07		
gynecological scissors	08-33		
intestinal forceps	64-03		
DOYEN-JANSEN mouth gag	48-03		
DOYEN			
myoma screw	70-46		
periosteal, rib elevator	32-20		
retractor	18-12		
towel clamp	14-05		
uterine polypus forceps	70-36		
vaginal speculum	70-18, 70-20		
Dressing thumb and tissue forceps	10-02		
Drill bit CRUTCHFIELD	EA-03		
Drill burr	33-04, 33-07		
ALBEE	33-07		
BORCHARDT	33-07		
CUSHING	33-04		
DOYEN	33-07		
HUDSON	33-04		
TOTI	33-07		
twist	33-04		
Drums			
KONRICH sterilizing	88-12		
SCHIMMELBUSCH sterilizing	88-12		
DUBOIS gynecological scissors	08-33		
DUPLAY			
dressing forceps	16-14		
tenaculum forceps	70-31		
Duplex stethoscope	02-06		
DUPUY-WEISS tonsil needle	50-03		
DUVAL			
grasping forceps	64-03		
thumb and tissue forceps	10-04		
Dynamometer COLLIN	02-03		
E			
ECHLIN bone rongeur	32-05		
EDWARDS			
clip	BD-21		
clip applying forceps	BD-21		
Electrical plaster saw	30-05 to 30-06		
Electrode coagulation mini	JA-02 to JA-03		
Elevator			
ADSON	32-21		
ALEXANDER periosteal	32-19		
BALLENGER septum	46-12		
COTTLE periosteal	46-12		
COTTLE septum	46-12		
DOYEN periosteal, rib	32-20		
FARABEUF periosteal	32-19		
FREER septum	46-11		
HAJEK-BALLENGER septum	46-12		
HENKE tonsil	50-02		
JOSEPH periosteal	46-12		
KEY	32-21		
KILLIAN septum	46-12		
LAMBOTTE periosteal	32-19		
LANGENBECK	32-21		
LANGENBECK periosteal	32-19		
LEMPERT	44-15		
MATSON periosteal	32-21		
McDONALD	32-22		
McKENY septum	46-11		
MURLESS head	72-05		
MURPHY-LANE	32-22		
OVERHOLT periosteal	32-21		
ROGER septum	46-11		
SADILLOT periosteal	32-19		
SEMB periosteal	32-20		
WATSON-CHEYNE	32-22		
WILLIGER periosteal	32-19		
ELLIOT			
corneal trephine	43-08		
obstetrical forceps	72-02		
ELLIS foreign body gouge	42-06		
ELSAESSER nephrostomy forceps	62-13		
ELSCHNIG			
capsular forceps	43-04		
corneal knife	42-05		
cyclodialysis spatula	42-08		
fixation forceps	43-03		
EMMET fistula hook	70-46		
ENGEL plaster saw	30-02		
Enterotomy scissors	08-39		
EPPENDORFER-KEVORKIAN			
uterine biopsy specimen forceps	70-46		
EPPENDORFER TISCHLER-MORGAN			
uterine biopsy specimen forceps	70-46		
EPPENDORFER			
uterine biopsy specimen forceps 70-45 to 70-46			
ERBE SELECT electrosurgery equipment cableJA-07			
Erisophake DASTOOR	42-09		
ESMARCH			
bandage scissors	08-46		
plaster knife	30-04		
EYES tonsil snare	50-04		
Extension bow	33-10		
BOEHLER 16x9 cm	33-10		
KIRSCHNER	33-10		
tightener	33-10		
wrench	33-10		
Extractor			
KUENTSCHER	33-13		
SAALFELD comedo	74-02		
SCHAMBERG comedo	74-02		
UNNA comedo	74-02		
WALTON comedo	74-02		
F			
FARABEUF			
bone holding forceps	32-07		
FARABEUF-LAMBOTTE bone holding forceps	32-08		
FARABEUF			
periosteal elevator	32-19		
retractor	18-02		
FARREL cotton applicator	20-03		
FAULKNER curette	46-18		
FAURE			
peritoneum forceps	12-17		
uterine biopsy specimen forceps	70-41		
FEHLAND intestinal forceps	64-06		
FEILCHENFELD splinter forceps	10-06		
FERGUSSON			
angiotribe forceps	12-07		
bone holding forceps	32-07		
gall stone scoop	62-07		
scissors	08-49		
FERRIS-SMITH-KERRISON intervertebral disc			
rounger	EA-10		
FERRIS-SMITH laminectomy rounger	EA-09		
FERRIS thumb and tissue forceps	10-04		
Fiber optic laryngoscope handle	AE-11		
File			
JOSEPH file	46-14		
nail	74-03		
FILIFORM bougiem	66-12		
Fine scissors	08-19		
Finger protector LANGENBECK	48-06		
FINOCHIETTO-BABY rib spreader	FG-09		
FINOCHIETTO			
bronchus forceps	FG-21		
FINOCHIETTO BURFORD rib spreader	FG-12 to FG-14		
FINOCHIETTO-HAIGHT BABY rib spreader	FG-10		
FINOCHIETTO INFANT rib spreader	FG-12		
FINOCHIETTO (modif) rib spreader	FG-08		
FINOCHIETTO			
needle holder	24-04		
rectal scissors	08-38		
rib spreader	FG-08, FG-10 to FG-11		
FINSER retractor	18-14		
FINSTERER suction and irrigation cannula	04-05		
FISCH dissector	44-15		
FISCHER iris forceps	42-13		
Fixation system LEYLA	EA-14 to EA-18		
FLETCHER JAVERTS sponge holding forceps	16-10		
FLEURANT trocar	22-02		
FOERSTER			
iris forceps	42-12		
sponge holding forceps	16-06 to 16-08		
FOMON			
nasal rasp	46-15 to 46-16		
nasal retractor	46-17		
nasal scissors	07-18, 08-25		
rhinoplastic chisel	46-13		
Forceps			
ADLERKREUTZ thumb and tissue	10-04		
ADSON BABY hemostatic	12-09		
ADSON-BROWN thumb and tissue	10-03		
ADSON hemostatic	12-09		
ADSON hypophyseal	EA-06		
ADSON thumb and tissue	10-03		
ADSON thumb and tissue, micro	10-03		
ALEXANDER uterine biopsy specimen	70-42		
ALLIS-ADAIR tissue	64-02		
ALLIS-Baby tissue	64-02		
ALLIS tissue	64-02		
ARCHER splinter	10-06		
ARRUGA capsular	43-04		
ASCH septum	46-18		
AYER chalazion	43-06		
BABCOCK seizing	64-02		
BAGGISH uterine biopsy specimen	70-45		
BAINBRIDGE atraumatic	BD-09		
BAINBRIDGE hemostatic	12-14		
BALLENGER tonsil seizing	50-04		
BARRAQ-KATZIN iris	42-13		
BARRAQU Colibri iris	42-13		
BARRAQUER anterior chamber	43-02		
BARRAQUER cilia	43-08		
BARRAQUER fixation	43-03		
BARRETT tenaculum	70-32		
BARTON obstetrical	72-04		
BECK atraumatic peripheral vascular	BD-25		
BEER cilia	43-08		
BENGOLEA hemostatic	12-09		
BERGMANN FOERSTER sponge holding	16-10		
BERKE muscular	43-02		
BEST intestinal	64-06		
bipolar coagulation	JA-04 to JA-06		
BIRCHER-GANSKE bone holding	32-10		
BISHOP-HARMAN iris	42-14		
BLAKE gall stone	62-03		
BLOHMKE tonsil seizing	50-04		
BOERMA obstetrical	72-04		
BÖHLER bone cutting	32-06		
BONACCOLTO strabismus	42-14		
BONNEY sponge holding	16-08		
Bonn iris	42-15		
Bonn TITAN iris	42-15		
BOZEMANN-DOUGLAS dressing	16-13		
BOZEMANN dressing	16-13		
BRAIN MINI clip applying	EA-12		
BRAIN STANDARD clip applying	EA-12		
BRAUN tenaculum	70-31, 70-34		
BROWN thumb and tissue	10-03		
BRUENINGS larynx	52-03		
BRUENINGS nasal cutting	46-05		
BRUNNER intestinal	64-06		
BRYANT sponge holding	16-11		
BUMM uterine elevating	70-38		
BURKE-Baby uterine biopsy specimen	70-44		
BURKE uterine biopsy specimen	70-44		
CARMALT splinter	10-06		
CASTAÑEDA atraumatic neonatal and children	BD-42		
CASTROVIEJO capsular	43-04		
CASTROVIEJO fixation	43-03		
CASTROVIEJO suture	43-05		
CHAPUT hemostatic	12-08		
CHEATLE sterilizing	28-02		
CHERON dressing	16-12		
CHEVALIER-JACKSON larynx	52-04		
CHILDE clip applying	26-07		
cilia	43-08		

- COLLIN clip applying . . . . .26-07  
 COLLIN dressing . . . . .16-11  
 COLLIN-DUVAL thumb and tissue . . . . .10-04  
 COLLIN hemostatic . . . . .12-08  
 COLLIN-POZZI tenaculum . . . . .70-32  
 COLLIN tongue holding . . . . .48-03  
 COLLIN uterine elevating . . . . .70-37  
 COLVER tonsil seizing . . . . .50-03  
 COOLEY  
   atraumatic11-03, BD-35 to BD-37, BD-39,  
   BD-41  
 COOLEY atraumatic anastomosisBD-37, BD-40  
 COOLEY atraumatic iliac . . . . .BD-37  
 COOLEY atraumatic pediatric BD-38 to BD-39  
 COOLEY DERRA atraumatic anastomosisBD-39  
 COOLEY vascular . . . . .BD-40  
 CORDES larynx . . . . .52-03  
 COTTLE-KAZANJIAN bone cutting . . . . .32-06  
 CRAFTOORD hemostatic bronchus . . . . .12-12  
 CRILE hemostatic . . . . .12-05  
 CRILE-RANKIN hemostatic . . . . .12-05  
 CRILE TITAN hemostatic . . . . .12-05  
 CUSHING thumb and tissue . . . . .10-03  
 CZERNY gall stone . . . . .62-03  
 CZERNY tenaculum . . . . .70-34  
 DALE atraumatic peripheral vascular . . . . .BD-24  
 DANDY hemostatic . . . . .12-07  
 DARDIK atraumatic . . . . .BD-07  
 DARTIGUES uterine elevating . . . . .70-37  
 DASTOOR strabismus . . . . .42-14  
 DAVIS sterilizing . . . . .28-02  
 DE BAKEY atraumatic  
   11-03, BD-02, BD-08, BD-16 to BD-17, BD-  
   20, BD-28 to BD-30  
 DE BAKEY atraumatic anastomosis . . . . .BD-25  
 DE BAKEY atraumatic  
   aortic-aneurysm . . . . .BD-13, BD-15, BD-18  
 DE BAKEY atraumatic bronchus . . . . .BD-19  
 DE BAKEY atraumatic  
   dissecting and ligature . . . . .BD-25, BD-32  
 DE BAKEY atraumatic iliac . . . . .BD-11  
 DE BAKEY atraumatic peripheral vascularBD-  
   06  
 DE BAKEY BAHNSON atraumatic  
   aortic-aneurysm . . . . .BD-14  
 DE BAKEY MORRIS atraumatic . . . . .BD-16  
 DE BAKEY REYNOLDS atraumatic anastomosis  
   BD-30  
 DE BAKEY SATINSKY atraumatic . . . . .BD-22  
 De LEE obstetrical . . . . .72-02  
 DERRA atraumatic anastomosis, pediatricBD-  
   28  
 DESJARDINS gall duct . . . . .12-15  
 DESJARDINS gall stone . . . . .62-02  
 DESMARRS chalazion . . . . .43-06  
 DeVILBISS skull . . . . .EA-05  
 DEWEY obstetrical, with traction rod . . . . .72-05  
 DIETHRICH atraumatic . . . . .BD-31  
 DIMEDA waste pickup . . . . .28-03  
 DINGMANN bone holding . . . . .32-10  
 DOUGLAS cilia . . . . .43-08  
 DOYEN-Baby intestinal . . . . .64-03  
 DOYEN intestinal . . . . .64-03  
 DOYEN uterine polypus . . . . .70-36  
 DUPLAY dressing . . . . .16-14  
 DUPLAY tenaculum . . . . .70-31  
 DUVAL grasping . . . . .64-03  
 DUVAL thumb and tissue . . . . .10-04  
 ear micro . . . . .44-09 to 44-10, 44-12  
 ear micro mini . . . . .44-13  
 EDWARDS clip applying . . . . .BD-21  
 ELLIOT obstetrical . . . . .72-02  
 ELSAESSER nephrostomy . . . . .62-13  
 ELSCHNIG capsular . . . . .43-04  
 ELSCHNIG fixation . . . . .43-03  
 EPPENDORFER-KEVORKIAN  
   uterine biopsy specimen . . . . .70-46  
 EPPENDORFER TISCHLER-MORGAN  
   uterine biopsy specimen . . . . .70-46  
 EPPENDORFER  
   uterine biopsy specimen . . . . .70-45 to 70-46  
 FARABEUF bone holding . . . . .32-07  
 FARABEUF-LAMBOTTE bone holding . . . . .32-08  
 FAURE peritoneum . . . . .12-17  
 FAURE uterine biopsy specimen . . . . .70-41  
 FEHLAND intestinal . . . . .64-06  
 FEILCHENFELD splinter . . . . .10-06  
 FERGUSSON angiotribe . . . . .12-07  
 FERGUSSON bone holding . . . . .32-07  
 FERRIS thumb and tissue . . . . .10-04  
 FINOCHIETTO bronchus . . . . .FG-21  
 FISCHER iris . . . . .42-13  
 FLETCHER JAVERTS sponge holding . . . . .16-10  
 FOERSTER iris . . . . .42-12  
 FOERSTER sponge holding . . . . .16-06 to 16-08  
 FRAENKEL larynx . . . . .52-03  
 FRAENKEL larynx polypus . . . . .52-02  
 FUCHS capsular . . . . .43-04  
 GAUSS scalp flap . . . . .72-06  
 GELLHORN uterine biopsy specimen . . . . .70-42  
 GEMINI dissecting and ligature . . . . .12-10  
 GEMINI MINI dissecting and ligature . . . . .12-10  
 GERALD thumb and tissue . . . . .10-05  
 GILL-ARRUGA capsular . . . . .43-03  
 GILL-HESS iris . . . . .42-12  
 GILLIES thumb and tissue . . . . .10-05  
 GILL iris . . . . .42-12  
 glans and the foreskin grasping . . . . .66-10  
 GLOVER atraumatic . . . . .BD-06, BD-30  
 GLOVER atraumatic anastomosis . . . . .BD-05  
 GLOVER atraumatic coarction . . . . .BD-04  
 GRADIE cilia . . . . .43-08  
 GRAEFE fixation . . . . .43-03  
 GRAEFE iris . . . . .42-11  
 GRAEFE thumb and tissue . . . . .10-03  
 GRAY gall duct . . . . .12-15  
 GREEN-ARMYTAG  
   caesarean section haemostatic . . . . .72-06  
 GREEN fixation . . . . .43-03  
 GREGORY atraumatic profunda . . . . .BD-33  
 GREVEN ear micro . . . . .44-10  
 GRIP seizing . . . . .33-11  
 GROSS dressing . . . . .16-05  
 GROSS-MAIER dressing . . . . .16-02 to 16-04  
 GUYON kidney pedicle . . . . .12-16  
 HALSTEAD-MOSQUITO atraumatic . . . . .BD-02  
 HALSTEAD-MOSQUITO hemostatic . . . . .12-04  
 HALSTEAD-MOSQUITO micro hemostatic12-  
   04  
 HALSTEAD-MOSQUITO TITAN hemostatic12-  
   04  
 HARKEN atraumatic auricle . . . . .BD-23  
 HARRINGTON bronchus . . . . .FG-21  
 HARTMANN ear . . . . .44-08  
 HARTMANN hemostatic . . . . .12-03  
 HARTMANN-HOFFMANN ear . . . . .44-08  
 HARTMANN nasal cutting . . . . .46-07  
 HARTMANN nasal polypus . . . . .46-04  
 HARTMANN-WULLSTEIN ear . . . . .44-08  
 HEANEN hysterectomy . . . . .12-18  
 HEGENBARTH clip applying . . . . .26-07  
 HEIMING kidney stone . . . . .62-13  
 HEISS hemostatic . . . . .12-09  
 HENROTIIN tenaculum . . . . .70-34  
 HERRICK kidney pedicle . . . . .12-17  
 HESS capsular . . . . .43-04  
 HESS iris . . . . .42-12  
 HEYMANN-KNIGHT nasal polypus . . . . .46-05  
 HEYMANN nasal cutting . . . . .46-05  
 HEYWOOD-SMITH pile . . . . .68-05  
 HUNTER splinter . . . . .10-06  
 IOWA tenaculum . . . . .70-35  
 JACKSON tampon . . . . .52-02  
 JACOBS tenaculum . . . . .70-34  
 JAMESON strabismus . . . . .42-13  
 JANSEN nasal . . . . .46-04  
 JARCHO tenaculum . . . . .70-32  
 JATHO nasopharynx . . . . .46-18  
 JAVID atraumatic carotid . . . . .BD-32  
 JOHNS-HOPKINS gall duct . . . . .12-14  
 JUDD-ALLIS tissue . . . . .64-02  
 JURASZ larynx polypus . . . . .52-02  
 KALT capsular . . . . .43-04  
 KELLY hemostatic . . . . .12-05  
 KELLY-RANKIN hemostatic . . . . .12-05  
 KELLY TITAN hemostatic . . . . .12-05  
 KELLY uterine polypus . . . . .70-36  
 KERN bone holding . . . . .32-08  
 KEVORKIAN-Pacific uterine biopsy specimen  
   70-44  
 KEVORKIAN uterine biopsy specimen70-43,  
   70-46  
 KIELLAND-LUIKART obstetrical . . . . .72-03  
 KIELLAND obstetrical . . . . .72-02  
 KIRBY-ARTHUR iris . . . . .42-13  
 KNAPP-LUER trachoma . . . . .43-06  
 KNIGHT nasal cutting . . . . .46-05  
 KOCHER hemostatic delicate . . . . .12-06  
 KOCHER intestinal . . . . .64-04  
 KRAUSE larynx . . . . .52-03  
 LAHEY gall duct . . . . .12-14  
 LAHEY goitre seizing . . . . .54-04  
 LAMBERT chalazion . . . . .43-06  
 LAMBERT KAY atraumatic aortic-anastomosis  
   BD-10  
 LAMBERT KAY atraumatic iliac . . . . .BD-11  
 LAMBOTTE bone holding . . . . .32-08  
 LANE bone holding . . . . .32-08  
 LANE for bone plates . . . . .33-14  
 LANE for bone screws . . . . .33-14  
 LANE thumb and tissue . . . . .10-04  
 LANGE larynx . . . . .52-03  
 LANGENBECK bone holding . . . . .32-07  
 LAWRENCE hemostatic . . . . .12-13  
 LEES atraumatic bronchus . . . . .BD-03  
 LELAND JONES atraumatic  
   peripheral vascular . . . . .BD-08 to BD-09  
 LERCHE thumb and tissue . . . . .10-04  
 LERICHE hemostatic . . . . .12-09  
 LESTER fixation . . . . .43-03  
 LEWIN bone holding . . . . .32-10  
 LEWKOWITZ placenta and ovum . . . . .72-07  
 LIDDLE atraumatic aortic . . . . .BD-10  
 LISTER sponge holding sinus . . . . .16-11  
 LISTON bone cutting . . . . .32-06  
 LITTAUER cilia . . . . .43-08  
 LITTAUER ear . . . . .44-08  
 LITTAUER nasal polypus . . . . .46-05  
 LOVEFACE hemostatic . . . . .12-07  
 LOVEFACE lung grasping . . . . .FG-19  
 LOWER gall duct . . . . .12-14  
 LUBET-BARBON nasal polypus . . . . .46-05  
 LUCAE ear . . . . .44-07  
 LUC nasal cutting . . . . .46-06  
 LUIKART obstetrical . . . . .72-03  
 MAGILL catheter introducing . . . . .04-06  
 MAIER dressing . . . . .16-12  
 MARSCHIK tonsil . . . . .50-04  
 MARTEL scalp flap . . . . .12-08  
 MARTIN dressing . . . . .16-02, 16-14  
 MARTIN sequester . . . . .32-10  
 MASTIN muscular . . . . .54-04  
 MATHIEU foreign body . . . . .66-07  
 MAYO BLAKE gall stone . . . . .62-04  
 MAYO-GUYON kidney pedicle . . . . .12-16  
 MAYO-ROBSON intestinal . . . . .64-05  
 McCLINTOCK placenta and ovum . . . . .72-07  
 McCULLOUGH strabismus . . . . .42-13  
 McGEE ear micro . . . . .44-10  
 McINDOE thumb and tissue . . . . .10-04  
 McKENZIE clip applying . . . . .EA-02  
 McLEAN-LUIKART obstetrical . . . . .72-03  
 McLEAN obstetrical . . . . .72-04  
 McLEAN-TUCKER-LUIKART obstetrical . . . . .72-03  
 McPHERSON TITAN tying . . . . .43-05  
 McPHERSON tying . . . . .43-05  
 MEEKER hemostatic . . . . .12-13

MICHEL clip applying	26-07
MIDDLETON-JANSEN nasal cutting	46-09
MIKULICZ peritoneum	12-17
MILLIN capsule forceps	66-03
MILLIN ligature carrying	66-03
MILLIN lobe holding	66-03
MIXTER BABY hemostatic bronchus	12-13
MIXTER gall duct	12-15
MIXTER gall stone	62-04
MIXTER hemostatic	12-14
MIXTER hemostatic bronchus	12-13
MIXTER O'SHAUGNESSY hemostatic	12-14
MOORFIELD suture	43-05
MOYNIHAN gall duct	12-15
MURPHY tubing clamp	12-19
MUSEUX tenaculum	70-33
MYLES nasal cutting	46-07
NAEGELE obstetrical	72-03
NEGUS tonsil	50-03
NELSON thumb and tissue	10-05
NEUBÜSER tubal seizing	70-51
NOTO uterine polypus	70-36
NOYES nasal polypus	46-05
OCHSNER atraumatic aortic	BD-31
OLIVECRONA-TOENNIS clip applying	EA-02
OVERHOLT-GEISSENDOERFER dissecting and ligature	12-10
PAUFIQUE TITAN tying	43-05
PAUFIQUE tying	43-05
PEAN atraumatic	BD-02
PEAN hemostatic	12-08
PEAN hemostatic delicate	12-06
PEET splinter	10-06
PELMANN dressing	16-12
PENNINGTON hemostatic	12-07
PHANEUF peritoneum	12-17
PIPER obstetrical	72-04
PIPER obstetrical, with traction rod	72-04
POTTS atraumatic	BD-26 to BD-27
POTTS atraumatic anastomosis	BD-05
POTTS atraumatic coarctation	BD-04
POTTS-SMITH thumb and tissue	10-02
POZZI tenaculum	70-31
PRATT hemostatic	12-08
PRATT tenaculum	70-34 to 70-35
PRESBYTERIAN HOSPITAL tubing clamp	12-19
PRICE-THOMAS bronchus	FG-22
PRINCE muscular	43-02
PROVIDEN24-HOSPITAL hemostatic	12-05
RADOLF nail extracting	33-03
RAMPLEY sponge holding	16-09
RANDALL kidney stone	62-11 to 62-12
RANEY clip applying	EA-03
RANKIN atraumatic	BD-02
RICHTER-HEATH clip applying	26-07
ROBERTS hemostatic	12-11
ROCHESTER-CARMALT hemostatic	12-07
ROCHESTER-OCHSNER hemostatic	12-06
ROCHESTER-PEAN hemostatic	12-06
ROGGE sterilizing	28-02
ROSENBERG larynx	52-03
ROWE mouth	48-06
RUBIN septum crushing	46-07
RUMEL thorax	12-11
RUSKIN-LISTON bone cutting	32-06
RUSSIAN thumb and tissue	10-04
SAENGER placenta and ovum	72-07
SAIRGES tenaculum	70-32
SAROT bronchus	FG-23
SAROT hemostatic bronchus	12-12
SATINSKY atraumatic	BD-20
SAUERBRUCH waste pickup	28-03
SAWTELL tonsil	50-03
SCHEINMANN larynx	52-03
SCHNIDT tonsil	50-03
SCHOENBURG grasping	64-03
SCHROEDER tenaculum	70-31 to 70-32
SCHUBERT uterine biopsy specimen	70-41
SCHUMACHER larynx	52-03

SCHUMACHER uterine biopsy specimen	70-43
SCHWEIGER capsular	43-04
SEIFFERT larynx	52-03
SEMB bone cutting	32-07
SEMB bone holding	32-07
SEMB bronchus	FG-23
SEMKEN thumb and tissue	10-05
SIEGLER HELLMANN uterine elevating	70-38
SIMPSON-BRAUN obstetrical	72-02
SIMPSON-LUIKART obstetrical	72-03
SIMPSON obstetrical	72-02
SIMS-MAIER dressing	16-05
SINGLEY thumb and tissue	10-05
SKENE tenaculum	70-31
SMITHWICK clip applying	EA-02
SNELLEN entropium	43-06
SOMER uterine elevating	70-37
SPENCER-WELLS hemostatic	12-07
STAUDE-MOORE tenaculum	70-31
STEVENS iris	42-11
STIEGLITZ splinter	10-06
STILLE-HORSLEY bone cutting	32-07
STILLE kidney pedicle	12-16
STILLE-LISTON bone cutting	32-06
STILLE thumb and tissue	10-02
St- MARTIN suture	43-05
STONE closing	64-06
STONE-WATT intestinal	64-06
STRUEMPEL ear	44-08
STRUYCKEN nasal cutting	46-07
SUBRAMANIAN atraumatic	BD-31
SWEET clip applying	EA-02
TARNIER obstetrical, with traction rod	72-05
TEALE tenaculum	70-33
TERSON capsular	43-04
THOMS-ALLIS tissue	64-02
THOMS-GAYLOR uterine biopsy specimen	70-42
TIEMANN tenaculum	70-32
TILLEY ear	44-08
TISCHLER-KEVORKIAN uterine biopsy specimen	70-44 to 70-45
TISCHLER-MORGAN uterine biopsy specimen	70-43 to 70-44, 70-46
TIVNEN tonsil seizing	50-04
TOENNIS hemostatic	12-11
TOWNSEND-KEVORKIAN uterine biopsy specimen	70-44
TOWNSEND-MINI (BABY TISCHLER) uterine biopsy specimen	70-45
TOWNSEND-mini uterine biopsy specimen	70-44
TOWNSEND-TISCHLER uterine biopsy specimen	70-44
TOWNSEND uterine biopsy specimen	70-44
TROELTSCH nasal	46-04
TROUTMAN Colibri iris	42-13
TROUTMAN rectus	43-02
Tübingen iris	42-15
Tübingen TITAN iris	42-15
Tübingen TITAN tying	43-05
Tübingen tying	43-05
TUFFIER hemostatic	12-08
TURREL biopsy specimen	68-05
TYDING tonsil seizing	50-04
ULRICH sponge holding	16-06
UNIVERSAL sterilizing	28-02
USA thumb and tissue	10-02
VAN BUREN sequester	32-10
van DOREN uterine biopsy specimen	70-42
VERBRUGGE bone holding	32-09
VIRTUS (RALK) splinter	10-06
WACHENFELDT clip applying	26-07
WALSHAM septum	46-18
WANGENSTEEN thumb and tissue	10-05
WEBER atraumatic	BD-12
WEIL-BLAKESLEY nasal cutting	46-06
WEISS tubing clamp	12-19

WERTHEIM-CULLEN hysterectomy	12-18
WERTHEIM hysterectomy	12-18
WHITE tonsil seizing	50-03
WILDE (TROELTSCH) ear	44-07
WILLET-MARTELL scalp flap	12-08
WILLIAMS grasping	64-03
WINTER placenta and ovum	72-07
wire cutting and bending	33-11
WITTNER uterine biopsy specimen	70-43
WRIGLEY obstetrical	72-02
WYLIE atraumatic	BD-21
YEOMAN biopsy specimen	68-05
YOUNG prostatic grasping	66-02
YOUNG tongue holding	48-03
ZENKER hemostatic	12-12
FORD BOWLES stethoscope	02-06
FORD stethoscope	02-06
Fork BURCH fixation	42-05
FOX lupus curette	74-02
FRAENKEL larynx forceps	52-03
larynx polypus forceps	52-02
Frame KIRSCHNER abdominal retractor	18-23
FRANCESCHETTI corneal trephine	43-07
FRANCIS foreign body needle	42-05
FRANKLIN-SILVERMANN puncture needle	22-03
FRAZIER hooklet	18-06
retractor	18-21
suction tube	04-06
FREER mucosa knife	46-10
nasal gouge	46-14
septum chisel	46-12
septum elevator	46-11
septum knife	46-10
FREWAY-GRAVE vaginal speculum	70-06
FRENZEL tongue depressor	48-02
FRIEDMAN bone rongeur	32-02
FRIEDMAN Mini bone rongeur	32-02
FRIEDMAN perineorr retractor	70-23
FRITSCH retractor	18-11
FRYKHOLM bone rongeur	32-05
FUCHS capsular forceps	43-04
Funnel	88-07
<b>G</b> GALLAHER antrum rasp	46-16
GAUSS scalp flap forceps	72-06
Gauze packer LUNIATSCHEK	50-02
GELHORN uterine biopsy specimen forceps	70-42
GELPI abdominal retractor	18-24
GEMINI dissecting and ligature forceps	12-10
GEMINI MINI dissecting and ligature forceps	12-10
GERALD thumb and tissue forceps	10-05
GERBODE mitral valve dilator	FG-28
GERSTER traction bar	32-11
GERZOG hammer	32-18
GIERTZ-STILLE rib shear	FG-06
GIGLI for wire saw handle	EA-05
GILL-ARRUGA capsular forceps	43-03
GILL corneal knife	42-05
GILL-HESS iris forceps	42-12
GILLIES hooklet	46-17
needle holder	24-05
thumb and tissue forceps	10-05
GILL iris forceps	42-12
GLOVER atraumatic anastomosis forceps	BD-05
atraumatic bulldog clamps	12-02
atraumatic coarctation forceps	BD-04
atraumatic forceps	BD-06, BD-30
GLUCK rib shear	FG-03

Inhaltsverzeichnis  
**Index**  
 Index  
 Índice alfabético  
 Indice alphabético

GOELET retractor	18-03	atraumatic forceps	BD-02	capsular forceps	43-04
GOLDMAN-FOX gum scissors	08-41	hemostatic forceps	12-04	iris forceps	42-12
GOLDSTEIN eye speculum	42-03	HALSTEAD-MOSQUITO micro hemostatic forceps	12-04	HETZER mitral valve dilator	FG-29
Goniometer MOELTGEN	02-08	HALSTEAD-MOSQUITO TITAN hemostatic forceps	12-04	HEYMANN-KNIGHT nasal polypus forceps	46-05
GOODELL uterine dilator	70-30	Hamburg cannula	43-07	HEYMANN	
GOOD tonsil scissors	08-27	Hammer	32-18	nasal cutting forceps	46-05
GORNEY dissecting scissors	08-13	COLLIN	32-18	nasal scissors	07-18, 08-25
GOSSET abdominal retractor	18-21	GERZOG	32-18	HEYWOOD-SMITH pile forceps	68-05
Gouge		KIRK	32-18	HIBBS	
ALEXANDER bone	32-14	LUCAE	32-18	bone chisel	32-16
bone	32-14	MEAD	32-18	bone gouge	32-16
ELLIS foreign body	42-06	QUISLING	32-18	osteotome	32-16
FREER nasal	46-14	slotted	33-13	HIRSCHMANN anoscope	68-04
HAJEK nasal	46-14	WILLIGER	32-18	HOESEL needle holder	24-05
HIBBS bone	32-16	Hand drill		HOFER pillar retractor	50-02
KILLIAN-CLAUS nasal	46-14	bone	33-05	HOFF towel clamp	14-03
LEXER bone	32-16	BUNNELL bone	33-05	HOHMANN bone lever	32-22 to 32-23
LEXER mini bone	32-16	HUDSON brace	33-04	HOHMANN mini bone lever	32-23
PARTSCH bone	32-14	KIRSCHNER bone	33-05	HOKE bone chisel	32-16
SMITH-PETERSEN bone	32-15	MOORE bone	33-04	HOLTH corneoscleral punch	42-09
STILLE bone	32-14	RALK bone	33-05	Hook	
WALTON foreign body	42-06	STILLE bone	33-04	ADSON nerve	EA-04
WEST nasal	46-14	STILLE-SHERMAN bone	33-04	ARRUGA extracting	42-06
GOURDET uterine curette	70-48	Hand drill with jacobs chuck bone	33-06	BOSE tracheal	54-02
GRADLE cilia forceps	43-08	Handle		BRAUN decapitating	72-09
GRAEFE		BARTON traction	72-04	CUSHING nerve	EA-04
cataract knife	42-03	BILL traction	72-05	DANDY nerve	EA-04
cataract spoon	42-07	BROCK mitral valve dilator	FG-26	EMMET fistula	70-46
cystotome	42-06	COLLIN scalpel	06-08	extension	33-10
eye speculum	42-02	GIGLI for wire saw	EA-05	extraction	33-13
fixation forceps	43-03	HUBER universal	52-03	GRAEFE strabismus	42-06
hooklet	18-06	laryngeal mirror	52-04	GRAEFE-TITAN strabismus	42-06
iris forceps	42-11	LUIKART-BILL traction	72-05	GRAHAM nerve	EA-04
scarifier	42-04	HANK uterine dilator	70-28	GREEN muscular	42-06
strabismus hook	42-06	HARKEN atraumatic auricle forceps	BD-23	ITERSON tracheal	54-02
thumb and tissue forceps	10-03	HARRINGTON		JACKSON tracheal	54-02
GRAEFE-TITAN strabismus hook	42-06	bronchus forceps	FG-21	JAMESON strabismus	42-06
GRAHAM nerve hook	EA-04	retractor	18-05	Hooklet	44-15
GRAVE vaginal speculum	70-02	HARTMANN		BARBARA	44-14
GRAY gall duct forceps	12-15	ear catheter	44-06	DAY ear	44-07
GREEN-ARMYTAGE		ear forceps	44-08	FRAZIER	18-06
caesarean section haemostatic forceps	72-06	ear specula	44-02	GILLIES	46-17
GREEN		HARTMANN-HALLE nasal specula	46-02	GRAEFE	18-06
corneal dissector	42-06	HARTMANN		GUTHRIE	18-06
fixation forceps	43-03	hemostatic forceps	12-03	JOSEPH	18-06
muscular hook	42-06	HARTMANN-HOFFMANN ear forceps	44-08	WAGENER ear	44-07
retractor	18-10	HARTMANN		Hook	
GREGORY atraumatic profunda forceps	BD-33	nasal cutting forceps	46-07	LOVE nerve	EA-04
GREVEN ear micro forceps	44-10	nasal polypus forceps	46-04	mini electrode	JA-02
Grinding stone ARKANSAS	06-19	tongue depressor	48-02	O' CONNOR iris	42-06
GRIP seizing forceps	33-11	tuning fork	44-03	PRATT cystic	68-04
GROSS		HARTMANN-WULLSTEIN ear forceps	44-08	ROSE tracheal	54-03
dressing forceps	16-05	Head lamp CLAR	02-05	SACHS nerve	EA-04
ear spoon	44-06	Head light CLAR mini	02-05	SMELLIE obstetrical	72-06
GROSS-MAIER dressing forceps	16-02 to 16-04	Head mirror ZIEGLER	02-05	SMITHWICK nerve	EA-04
GRUBER ear specula	44-02	HEANEY		STEVENS lens	42-06
Gum scissors	08-41	hysterectomy forceps	12-18	WIENER iris	42-06
GUTHRIE hooklet	18-06	needle holder	24-03	HOPKINS plaster knife	30-04
GUTMANN secretions scoop	66-11	retractor	18-12	HORSLEY dura dissector	EA-06
GUYON		HEATH ligature scissors	08-40	HOUSE curette	44-15
catheter introducer	66-11	HEBRA chalazion curette	42-07	HRYNTSCHAK prostatic retractor	66-06
kidney pedicle forceps	12-16	HEGAR uterine dilator	70-24 to 70-27	HUBER universal handle	52-03
urethral sound	66-12, 66-14 to 66-15	HEGENBARTH clip applying forceps	26-07	HUDSON	
GUYTON-LUNDGAARD sclerotome	42-05	HEIFETZ brain spatula	EA-07	brace hand drill	33-04
Gynecological micro scissors	09-07 to 09-08	HEIMING kidney stone forceps	62-13	drill burr	33-04
H		HEISS hemostatic forceps	12-09	HUMBY	
HABERER retractor	18-04	HEISTER mouth gag	48-03	dermatome	06-20
HAGLUND-STILLE plaster spreader	30-03	Hemostat		dermatome blade	06-20
HAIGHT rib spreader	FG-15	CORWIN tonsil	50-04	HUNTER splinter forceps	10-06
HAJEK-BALLENGER septum elevator	46-12	PASSOW	44-15	HURD tonsil dissector	50-02
HAJEK-CLAUS punch	46-08	HENKE tonsil elevator	50-02	I	
HAJEK-KOFLER punch	46-08	HENNIG plaster spreader	30-03	Impactor	
HAJEK nasal gouge	46-14	HENROTIN tenaculum forceps	70-34	KUENTSCHER nail	33-13
HALLE		HERMANN plaster spreader	30-03	nail	33-12
bone curette	32-13	HERRICK kidney pedicle forceps	12-17	Incision scissors	08-05
dura knife	EA-06	HERTZLER rib spreader	FG-17	INGE lamina spreader	EA-07
HALSEY needle holder	24-02	HESS		Instrument	
HALSTEAD-MOSQUITO				circumcision	66-09



KNUTSON urethrography	66-09
LAFORCE foreign body	42-06
MOGAN circumcision	66-09
IOWA tenaculum forceps	70-35
IRIS	
eye scissors	08-22
large rings scissors	08-19
scissors	07-16, 08-21
Irrigator	88-05
ISRAEL retractor	18-11
ITARD ear catheter	44-06
ITERSON tracheal hook	54-02
IVES-FANSLER anoscope	68-04
<b>J</b>	
JACKSON	
tampon forceps	52-02
tracheal hook	54-02
tracheal tube	54-03
vaginal speculum	70-16
JACOBSON micro scissors	09-11
JACOBS tenaculum forceps	70-34
JAEGER	
keratome	42-04
lid plate	42-03
JAMESON	
strabismus forceps	42-13
strabismus hook	42-06
JAMISON needle holder	24-03
JANSEN	
nasal forceps	46-04
retractor	18-14
Jar	88-08
JARCHO tenaculum forceps	70-32
JATHO nasopharynx forceps	46-18
JAVID atraumatic carotid forceps	BD-32
JENNINGS mouth gag	48-04
JOBSON-HORNE cotton applicator	20-03
JOHNS-HOPKINS	
gall duct forceps	12-14
serrefine bulldog clamps	12-03
JOHNSON needle holder	24-04
JONES tube holder towel clamp	14-02
JOSEPH	
file file	46-14
hooklet	18-06
JOSEPH (LEWIS) nasal rasp	46-15
JOSEPH	
nasal knife	46-10
nasal saw	46-17
nasel knife	46-10
periosteal elevator	46-12
scissors	07-14, 08-16
JUDD-ALLIS tissue forceps	64-02
JUDD-MASSON bladder retractor	66-04
JURASZ larynx polypus forceps	52-02
<b>K</b>	
KABIERSKE powder blower	44-04
KALLMORGEN	
vaginal retractor	70-15
vaginal speculum	70-15
KALT-ARRUGA needle holder	24-07
KALT	
capsular forceps	43-04
needle holder	24-07
KANE umbilical cord umbilic-cord	72-06
KEITH suturing needle	26-06
KELLY Grip retractor	18-04
KELLY	
gynecological scissors	07-22, 08-33
hemostatic forceps	12-05
proctoscope	68-04
KELLY-RANKIN hemostatic forceps	12-05
KELLY	
retractor	18-04, 18-12
KELLY TITAN hemostatic forceps	12-05
KELLY	
uterine polypus forceps	70-36

Keratome	
BERENS	42-04
CASTROVIEJO	42-04
JAEGER	42-04
KERN bone holding forceps	32-08
KERRISON punch	46-08
KEVORKIAN-Pacific uterine biopsy specimen forceps	70-44
KEVORKIAN	
uterine biopsy aspirating curette	70-40
uterine biopsy specimen forceps 70-43, 70-46	70-46
KEY elevator	32-21
KEYES cutaneous punch	74-02
KIELLAND-LUIKART obstetrical forceps	72-03
KIELLAND obstetrical forceps	72-02
KILLIAN-CLAUS nasal gouge	46-14
KILLIAN	
septum elevator	46-12
septum specula	46-03
wash cannula	46-09
KILNER-DOUGHTY mouth gag	48-05
KILNER	
scissors	07-14, 08-17
skin retractor	74-02
KIRBY-ARTHUR iris forceps	42-13
KIRK hammer	32-18
KIRSCHNER	
abdominal retractor	18-23
abdominal retractor blade	18-23
abdominal retractor frame	18-23
bone hand drill	33-05
extension bow	33-10
ligature conductor	26-04
wiredrill	33-09
KLUNKENBERGH-LOTH lung and thorax scissors 08-37	08-37
KNAPP	
cataract spoon	42-07
iris knife	42-04
KNAPP-LUER tracheoma forceps	43-06
KNAPP	
retractor	42-06
scissors	08-20
Knife and dissector CARPENTER tonsil	50-02
Knife	
BALLENGER swivel	46-11
BARKAN goniotomy	42-05
BARRAQUER keratoplasty	42-05
BOWMAN discision	42-04
cartilage	06-18
CATLIN amputation	06-16
CONVERSE nasal	46-10
COTTLE nasal	46-10
DEAN iris	42-04
DEUTSCHMANN cataract	42-03
dissecting	06-15
electrode	JA-03
ELSCHNIG corneal	42-05
ESMARCH plaster	30-04
FREER mucosa	46-10
FREER septum	46-10
GILL corneal	42-05
GRAEFE cataract	42-03
HALLE dura	EA-06
HOPKINS plaster	30-04
JOSEPH nasal	46-10
JOSEPH nasal	46-10
KNAPP iris	42-04
LANGENBECK resection	06-17
LISTON amputation	06-16
MALTZ cartilage	46-11
MUCK periosteal	44-15
PARKER dissecting	06-15
PAUFIQUE keratoplasty	42-05
PLESTER flap	44-14
POLITZER ear	44-06
REINER plaster	30-04
ROSEN circular	44-14
SATO corneal	42-05

SCHEIE goniotomy	42-05
SCHUKNECHT roller	44-14
SCHUKNECHT sickle	44-14
SEGOND myoma	70-46
SEXTON ear	44-06
TABB sickle	44-14
TOOK corneal	42-05
VIRCHOW brain	06-18
VIRCHOW cartilage	06-18
WHEELER discision	42-04
WULLSTEIN sickle	44-14
ZIEGLER capsulotomy	42-05
ZIEGLER iris	42-04
KNIGHT nasal cutting forceps	46-05
KNOWLES bandage scissors	08-47
KNUTSON-KOCH urethrography cone	66-09
KNUTSON urethrography instrument	66-09
KOCHER	
bladder spatula	66-04
goitre director	54-04
hemostatic delicate forceps	12-06
intestinal forceps	64-04
retractor	18-10 to 18-11
KOENIG	
ligature conductor	26-04
suturing needle	26-06
KOERTE retractor	18-11
KOGAN endo speculum	70-23
KONRICH sterilizing drums	88-12
KRAUSE	
ear polypus snare	44-07
larynx forceps	52-03
nasal snare	46-09
KRISTELLER	
vaginal retractor	70-09 to 70-14
vaginal speculum	70-09 to 70-14
KRONECKER ligature needle	26-02
KUENTSCHER	
extractor	33-13
nail impactor	33-13
reamer	33-13
KUHNT corneal scarifier	42-05
<b>L</b>	
LABORDE tracheal dilator	54-02
LAFORCE	
adenotome	46-19
foreign body instrument	42-06
LAGRANGE gum scissors	08-41
LAHEY	
gall duct forceps	12-14
goitre seizing forceps	54-04
retractor	18-08
LAMBERT chalazion forceps	43-06
LAMBERT KAY	
atraumatic aortic-anastomosis forceps	BD-10
atraumatic iliac forceps	BD-11
LAMBOTTE	
bone holding forceps	32-08
LAMBOTTE mini osteotome	32-15
LAMBOTTE	
osteotome	32-15
periosteal elevator	32-19
LANCASTER eye speculum	42-03
Lancet electrode	JA-03
LANDAU vaginal speculum	70-22
LANDOLT	
enucleation scissors	08-25
micro surgical scalpel handle	06-13
LANE	
bone holding forceps	32-08
for bone plates forceps	33-14
for bone screws forceps	33-14
screw driver	33-14
stomach clamp	64-08
thumb and tissue forceps	10-04
towel clamp	14-05
LANGE	
bandage scissors	08-44

Inhaltsverzeichnis  
**Index**  
 Index  
 Índice alfabético  
 Indice alphabético

larynx forceps . . . . .	52-03	LITTLE retractor . . . . .	18-08	MATSON periosteal elevator . . . . .	32-21
LANGENBECK		LOCKLIN scissors . . . . .	08-18	MAUNDER wooden oral screw . . . . .	48-06
bone holding forceps . . . . .	32-07	Loop		MAYO BLAKE gall stone forceps . . . . .	62-04
elevator . . . . .	32-21	ARLT wire . . . . .	42-08	MAYO	
finger protector . . . . .	48-06	BILLEAU ear . . . . .	44-07	gall stone scoop . . . . .	62-07
finger saw . . . . .	33-03	ear . . . . .	44-07	MAYO-GUYON kidney pedicle forceps . . . . .	12-16
periosteal elevator . . . . .	32-19	mini electrode . . . . .	JA-02 to JA-03	MAYO-HEGAR needle holder . . . . .	24-02
resection knife . . . . .	06-17	nasal . . . . .	46-09	MAYO	
retractor . . . . .	18-09	SNELLEN wire . . . . .	42-08	kidney stone probe . . . . .	62-10
LANG lachrymal dissector . . . . .	42-08	tonsil . . . . .	50-04	left handed scissors . . . . .	08-07
Laryngoscope blade		WEBER wire . . . . .	42-08	MAYO-NOBLE scissors . . . . .	07-08, 08-10
MACINTOSH conventional . . . . .	AE-15	WILDER wire . . . . .	42-08	MAY ophthalmoscope . . . . .	02-03
MACINTOSH fiber optic . . . . .	AE-10	LORENZ bandage scissors . . . . .	08-47	MAYO-ROBSON intestinal forceps . . . . .	64-05
MILLER conventional . . . . .	AE-16	LORNA towel clamp . . . . .	14-04	MAYO	
MILLER fiber optic . . . . .	AE-10	LOUTE wire twister . . . . .	33-11	safety needle . . . . .	28-02
Laryngoscope set		LOVE-GRUENWALD laminctomy rongeur .EA-08		scissors . . . . .	07-06, 08-07
MACINTOSH conventional . .AE-18 to AE-19		LOVELACE		MAYO-STILLE scissors . . .07-07, 08-08 to 08-09	
MACINTOSH fiber optic . . .AE-12 to AE-13		hemostatic forceps . . . . .	12-07	McCLINTOCK placenta and ovum forceps .72-07	
MILLER conventional . . . . .AE-18 to AE-19		lung grasping forceps . . . . .	FG-19	McCULLOUGH strabismus forceps . . . . .	42-13
MILLER fiber optic . . . . .AE-12 to AE-13		LOVE		McDONALD elevator . . . . .	32-22
Laryngoscope		nerve hook . . . . .	EA-04	McGEE ear micro forceps . . . . .	44-10
Spare lamp conventional . . . . .	AE-20	uvula retractor . . . . .	50-02	McGUIRE corneal scissors . . . . .	09-05
Spare lamp fiber optic . . . . .	AE-20	LOWER gall duct forceps . . . . .	12-14	McINDOE	
LAWRENCE hemostatic forceps . . . . .	12-13	LOWMAN bone holding clamp . . . . .	32-11	cartilage scissors . . . . .	08-35
Lead hand splint . . . . .	32-11	LUBET-BARBON nasal polypus forceps . . . . .	46-05	thumb and tissue forceps . . . . .	10-04
LEBSCHKE sternum chisel . . . . .	32-17	LUCAE		McIVOR	
LEES atraumatic bronchus forceps . . . . .	BD-03	ear forceps . . . . .	44-07	mouth gag . . . . .	48-05
LEGUEU		hammer . . . . .	32-18	tongue depressor . . . . .	48-05
bladder retractor . . . . .	66-06	tuning fork . . . . .	44-04	McKENTY septum elevator . . . . .	46-11
bladder spatula . . . . .	66-04	LUC nasal cutting forceps . . . . .	46-06	McKENZIE	
LEKSELL STILLE bone rongeur . . . . .	32-05	LUER		clip applying forceps . . . . .	EA-02
LELAND JONES atraumatic		bone rongeur . . . . .	32-03	cutter . . . . .	33-04
peripheral vascular forceps . . . . .	BD-08 to BD-09	LUER-KOERTE gall stone scoop . . . . .	62-09	McLEAN-LUIKART obstetrical forceps . . . . .	72-03
LEMPERT		LUER		McLEAN obstetrical forceps . . . . .	72-04
bone curette . . . . .	32-13	tracheal tube . . . . .	54-03	McLEAN-TUCKER-LUIKART obstetrical forceps72-03	
bone rongeur . . . . .	32-03	LUIKART-BILL traction handle . . . . .	72-05	McPHERSON TITAN tying forceps . . . . .	43-05
elevator . . . . .	44-15	LUIKART obstetrical forceps . . . . .	72-03	McPHERSON tying forceps . . . . .	43-05
LERCHE thumb and tissue forceps . . . . .	10-04	LUNDSGAARD sclerotome . . . . .	42-05	McPHERSON WESTCOTT tenotomy scissors09-04	
LERICHE hemostatic forceps . . . . .	12-09	LUNIATSCHEK gauze packer . . . . .	50-02	MEAD	
LESTER fixation forceps . . . . .	43-03	LURZ ureter clamp . . . . .	62-10	bone rongeur . . . . .	32-02
Lever		M		hammer . . . . .	32-18
BENNETT bone . . . . .	32-22	MACINTOSH		Measure graduated . . . . .	88-07
BLOUNT bone . . . . .	32-24	conventional laryngoscope blade . . . . .	AE-15	Measuring tape . . . . .	02-08
bone . . . . .	32-23	conventional laryngoscope set AE-18 to AE-19		MEEKER hemostatic forceps . . . . .	12-13
BUCK foreign body . . . . .	44-08	fiber optic laryngoscope blade . . . . .	AE-10	MELLINGER-AXENFELD eye speculum . . . . .	42-02
HOHMANN bone . . . . .	32-22 to 32-23	fiber optic laryngoscope set . .AE-12 to AE-13		MELLINGER eye speculum . . . . .	42-02
HOHMANN mini bone . . . . .	32-23	MAGILL		MENGHINI trocar . . . . .	22-03
QUIRE foreign body . . . . .	44-08	catheter introducing forceps . . . . .	04-06	Meniscomote	
LEVINSON foreign body needle . . . . .	42-05	stylet . . . . .	04-04	BIRCHER . . . . .	32-24
LEWIN bone holding forceps . . . . .	32-10	suction tube . . . . .	04-04	NEFF . . . . .	32-24
LEWKOWITZ placenta and ovum forceps .72-07		Magnet DIMEDA eye . . . . .	43-08	SMILLIE . . . . .	32-24
LEXER-BABY scissors . . . . .	07-10	MAIER dressing forceps . . . . .	16-12	MERCEDES thoracic spreader . . . . .	FG-16
LEXER		MALTZ		Metal ruler . . . . .	02-08
bone chisel . . . . .	32-16	cartilage knife . . . . .	46-11	METZENBAUM	
bone gouge . . . . .	32-16	MALTZ (COTTLE) nasal rasp . . . . .	46-15	dissecting scissors . . . . .	08-13 to 08-14
dissecting scissors . . . . .	08-11 to 08-12	MALTZ		METZENBAUM FINO	
LEXER mini		nasal rasp . . . . .	46-14	dissecting scissors . . . . .	08-15
bone chisel . . . . .	32-16	Manometer for salpingographe . . . . .	70-47	scissors . . . . .	07-12
bone gouge . . . . .	32-16	Marker		METZENBAUM	
LEXER		CASTROVIEJO compass . . . . .	42-09	needle holder . . . . .	24-04
scissors . . . . .	07-09	CONNIN-AMSLER . . . . .	42-09	scissors . . . . .	07-11
LEYLA fixation system . . . . .	EA-14 to EA-18	MARSCHIK tonsil forceps . . . . .	50-04	METZENBAUM "S" scissors . . . . .	07-13, 08-16
LICHTWITZ trocar . . . . .	22-02, 46-09	MARTEL scalp flap forceps . . . . .	12-08	MEYERDING retractor . . . . .	18-08
LIDDLE atraumatic aortic forceps . . . . .	BD-10	MARTIN		MEYHOEFER chalazion curette . . . . .	42-07
Light carrier MILLIN fiber optic . . . . .	66-05	dressing forceps . . . . .	16-02, 16-14	MICHEL	
LISTER		electrosurgery equipment cable . . . . .	JA-07	clip . . . . .	26-07
bandage scissors . . . . .	07-23, 08-45	MARTINI bone curette . . . . .	32-13	clip applying forceps . . . . .	26-07
LISTER-BURCH eye speculum . . . . .	42-02	MARTIN		mirror . . . . .	46-04
LISTER		pelvimeter . . . . .	72-06	Micro forceps . . . . .	11-02
sponge holding sinus forceps . . . . .	16-11	sequester forceps . . . . .	32-10	Micro scissors . . . . .	09-06, 09-13
LISTON		uterine sound . . . . .	70-39	Micro surgical scalpel handle . . . . .	06-12
amputation knife . . . . .	06-16	MASSON needle holder . . . . .	24-03	MIDDELDORPF retractor . . . . .	18-10
bone cutting forceps . . . . .	32-06	MASTIN muscular forceps . . . . .	54-04	MIDDLETON-JANSEN nasal cutting forceps 46-09	
LITTAUER		MATHIEU		MIKULICZ	
cilia forceps . . . . .	43-08	foreign body forceps . . . . .	66-07	peritoneum forceps . . . . .	12-17
ear forceps . . . . .	44-08	needle holder . . . . .	24-05	retractor . . . . .	18-12
ligature scissors . . . . .	08-40	rectal speculum . . . . .	68-02	MILLER	
nasal polypus forceps . . . . .	46-05	retractor . . . . .	18-03	conventional laryngoscope blade . . . . .	AE-16
LITTLER dissecting scissors . . . . .	08-13				

conventional laryngoscope set AE-18 to AE-19			
fiber optic laryngoscope blade	AE-10		
fiber optic laryngoscope set	AE-12 to AE-13		
MILLIGAN dura dissector	EA-05		
MILLIN			
bladder neck spreader	66-07		
bladder retractor	66-05		
capsule forceps forceps	66-03		
fiber optic light carrier	66-05		
ligature carrying forceps	66-03		
lobe holding forceps	66-03		
MILLS vascular scissors	08-27		
Mini suturing kit	26-08		
Mirror			
laryngeal	52-04		
MICHEL	46-04		
MIXTER BABY hemostatic bronchus forceps	12-13		
MIXTER			
gall duct forceps	12-15		
gall stone forceps	62-04		
hemostatic bronchus forceps	12-13		
hemostatic forceps	12-14		
MIXTER O'SHAUGNESSY hemostatic forceps	12-14		
MOELTGEN goniometer	02-08		
MOGAN circumcision instrument	66-09		
MOLLISON retractor	18-17		
MOORE			
bone hand drill	33-04		
gall stone scoop	62-05		
MOORFIELD suture forceps	43-05		
MORSE-FAVOLORO rib spreader	FG-17		
Mouth gag			
DAVIS-BOYLE	48-04		
DENHART	48-03		
DOYEN-JANSEN	48-03		
HEISTER	48-03		
JENNINGS	48-04		
KILNER-DOUGHTY	48-05		
McIVOR	48-05		
ROSER-KOENIG	48-03		
SEEMANN-SEIFFERT	48-04		
WHITEHEAD	48-04		
MOYNIHAN			
gall duct forceps	12-15		
gall stone probe	62-05		
towel clamp	14-05		
MUCK periosteal knife	44-15		
MUELLER eye speculum	42-03		
MURDOCK eye speculum	42-02		
MURLESS head elevator	72-05		
MURPHY-LANE elevator	32-22		
MURPHY tubing clamp forceps	12-19		
Muscle hook retractor	18-25		
MUSEUX tenaculum forceps	70-33		
MYLES nasal cutting forceps	46-07		
N			
NABATOFF probe	20-02		
NAEGELE obstetrical forceps	72-03		
NÄGELE perforator	72-09		
NAGER palate retractor	50-02		
Needle			
BARBARA	44-14		
BOWMAN discision	42-05		
BUNT safety	28-02		
Needle case	88-02		
SAUERBRUCH	88-02		
Needle			
cataract	42-05		
COOPER ligature	26-02		
DAVIS foreign body	42-05		
DESCHAMPS ligature	26-02		
DIX foreign body	42-09		
DUPUY-WEISS tonsil	50-03		
electrode	JA-03		
foreign body	42-05		
FRANCIS foreign body	42-05		
FRANKLIN-SILVERMANN puncture	22-03		
Needle holder			
ADSON	24-04		
ARRUGA ophthalmologic	24-06		
BARRAQUER	24-07		
BAUMGARTNER	24-02		
BOYNTON ophthalmologic	24-06		
BOZEMANN	24-03		
CASTROVIEJO	24-07		
COLLIER	24-02		
CRILE	24-04		
CRILE-MURRAY	24-02		
CRILE-WOOD	24-02		
DE BAKEY	24-03		
DERF	24-02		
DIETHRICH vascular	24-06		
FINOCHIETTO	24-04		
GILLIES	24-05		
HALSEY	24-02		
HEANEY	24-03		
HOESEL	24-05		
JAMISON	24-03		
JOHNSON	24-04		
KALT	24-07		
KALT-ARRUGA	24-07		
MASSON	24-03		
MATHIEU	24-05		
MAYO-HEGAR	24-02		
METZENBAUM	24-04		
NEIVERT	24-02		
OLSEN-HEGAR	24-05		
RYDER	24-03		
SAROT	24-04		
STEVENS ophthalmological	24-06		
STRATTE	24-04		
TOENNIS	24-04		
WANGENSTEEN	24-03		
Needle			
KEITH suturing	26-06		
KOENIG suturing	26-06		
KRONECKER ligature	26-02		
LEVINSON foreign body	42-05		
MAYO safety	28-02		
mini electrode	JA-02		
NELSON ligature	26-02		
POLITZER paracentesis	44-06		
QUINKE puncture	22-03		
REVERDIN ligature	26-03		
ROSEN	44-14 to 44-15		
tonsil	50-05		
VERRES pneumoperitoneum puncture	22-03		
YOUNG Boomerang ligature	26-03		
NEFF meniscotome	32-24		
NEGUS tonsil forceps	50-03		
NEIVERT needle holder	24-02		
NELSON			
ligature needle	26-02		
thumb and tissue forceps	10-05		
trocar	22-02		
NEUBÜSER tubal seizing forceps	70-51		
Neurosurgical scissors	08-35		
Nipper			
cuticle	74-03		
DIETER malleus	44-10		
nail	74-03		
TURNBULL nail	74-03		
NORTHBENT ligature scissors	08-40		
NOTO uterine polypus forceps	70-36		
NOVAK uterine biopsy aspirating curette	70-40		
NOYES			
iris scissors	09-03 to 09-04		
nasal polypus forceps	46-05		
tendon scissors	09-03		
NUBOER suction tube	04-05		
Nurse set hospital	74-03		
O			
OCHSNER			
atraumatic aortic forceps	BD-31		
trocar	22-02		
O' CONNOR iris hook	42-06		
OLDBERG laminectomy rongeur	EA-09		
OLIVECRONA			
bone rongeur	32-03		
brain spatula	EA-07		
OLIVECRONA-TOENNIS clip applying forceps	EA-02		
OLIVECRONA			
wire saw	EA-05		
OLLIER retractor	18-10		
OLSEN-HEGAR needle holder	24-05		
Opening BROCK mitral valve dilator	FG-26		
Ophthalmoscope			
MAY	02-03		
VARIFOCAL	02-03		
Oral screw MAUNDER wooden	48-06		
Osteotome	32-14		
HIBBS	32-16		
LAMBOTTE	32-15		
LAMBOTTE mini	32-15		
STILLE	32-14		
O'SULLIVAN-O'CONNOR			
abdominal retractor	18-21		
vaginal speculum	70-08		
OTIS			
spare blade	66-08		
urethrotome	66-08		
Otoscope	02-04		
OVERHOLT-GEISSENDOERFER dissecting and			
ligature forceps	12-10		
OVERHOLT periosteal elevator	32-21		
P			
Pan			
bed	88-06		
plazenta	88-06		
PARHAM band	32-11		
PARKER			
dissecting knife	06-15		
retractor	18-02		
PARK eye speculum	42-03		
PARTSCH			
bone chisel	32-14		
bone gouge	32-14		
PASSOW hemostat	44-15		
PATON corneal dissector	42-05		
PAUFIQUE			
keratoplasty knife	42-05		
PAUFIQUE TITAN tying forceps	43-05		
PAUFIQUE			
tying forceps	43-05		
PAYR-Baby stomach clamp	64-09		
PAYR			
ligature conductor	26-04		
stomach clamp	64-09		
PEAN			
atraumatic forceps	BD-02		
hemostatic delicate forceps	12-06		
hemostatic forceps	12-08		
PEDERSON vaginal speculum	70-03		
PEERS BERTRAM towel clamp	14-03		
PEET splinter forceps	10-06		
PELKMANN dressing forceps	16-12		
Pelvimeter			
COLLIN	72-06		
COLLYER	72-06		
MARTIN	72-06		
PENFIELD dura dissector	EA-06		
PENNINGTON hemostatic forceps	12-07		
Percussion hammer			
BABINSKY	02-07		
BERLINER	02-07		
BUCK	02-07		
DEJERINE	02-07		
TAYLOR	02-07		
TRAUBE	02-07		
TROEMNER	02-07		
PERCY amputation retractor	33-03		
Perforator			



NÄGELE .....72-09  
 SMELLIE .....72-09  
 PERTHES reamer .....33-08  
 PESTALOZZA placenta and ovum scoop .....72-08  
 PETRI dish .....88-08  
 PETZ stomach and intestinal suturing apparatus64-09  
 PHANEUF peritoneum forceps .....12-17  
 Pick .....44-15  
   BARBARA .....44-14 to 44-15  
 PIERCE trocar .....22-02  
 PIFFARD lupus curette .....88-02  
 PINARD stethoscope .....02-06  
 Pin STEINMANN .....33-09  
 Pin-wheel WARTENBERG .....02-08  
 PIPER  
   obstetrical forceps .....72-04  
   obstetrical, with traction rod forceps .....72-04  
 Plaster knife .....30-04  
 Plaster saw blade .....30-05 to 30-06  
 Plaster scissors .....08-49  
 Plaster spatula .....20-03  
 Plaster spreader .....30-03  
 Plate JAEGER lid .....42-03  
 PLESTER  
   flap knife .....44-14  
   retractor .....18-14  
 Pliers flat nose .....33-11  
 POLITZER  
   air bag .....44-05  
   ear knife .....44-06  
   paracentesis needle .....44-06  
 POOLE suction tube .....04-02  
 Post mortem set .....32-17  
 POTTS  
   atraumatic anastomosis forceps .....BD-05  
   atraumatic coarctation forceps .....BD-04  
   atraumatic forceps .....BD-26 to BD-27  
 POTTS DE MARTEL vascular scissors .....08-27  
 POTTS-SMITH  
   thumb and tissue forceps .....10-02  
   vascular scissors .....07-19, 08-28  
 Powder blower KABERSKE .....44-04  
 POZZI tenaculum forceps .....70-31  
 PRATT  
   cystic hook .....68-04  
   hemostatic forceps .....12-08  
   rectal speculum .....68-02  
   tenaculum forceps .....70-34 to 70-35  
   uterine dilator .....70-29  
 PRESBYTERIAN HOSPITAL tubing clamp forceps12-19  
 PRICE-THOMAS bronchus forceps .....FG-22  
 PRINCE  
   muscular forceps .....43-02  
   tonsil scissors .....08-27  
 Probe .....20-02  
   BOWMAN lachrymal .....42-10  
   DESJARDINS gall stone .....62-05  
   MAYO kidney stone .....62-10  
   measuring .....44-15  
   MOYNIHAN gall stone .....62-05  
   NABATOFF .....20-02  
   STACKE .....20-02  
 Proctoscope KELLY .....68-04  
 Protector  
   ARRUGA .....42-08  
   tissue .....33-15  
 PROVIDEN24-HOSPITAL hemostatic forceps 12-05  
 Punch  
   BEYER .....46-08  
   BROCK mitral valve dilator .....FG-26  
   CITELLI .....46-08  
   HAJEK-CLAUS .....46-08  
   HAJEK-KOFLER .....46-08  
   HOLTH corneoscleral .....42-09  
   KERRISON .....46-08  
   KEYES cutaneous .....74-02  
   PUTTI bone rasp .....32-25

Q  
 QUATTRO plaster spreader .....30-03  
 QUINBY gum scissors .....08-42  
 QUINKE puncture needle .....22-03  
 QUIRE foreign body lever .....44-08  
 QUISLING hammer .....32-18  
 R  
 RADOLF nail extracting forceps .....33-03  
 RALK bone hand drill .....33-05  
 RAMPLEY sponge holding forceps .....16-09  
 RANDALL  
   kidney stone forceps .....62-11 to 62-12  
   uterine biopsy aspirating curette .....70-40  
 RANEY  
   clip applying forceps .....EA-03  
   scalp hemostasis clip .....EA-03  
 RANKIN atraumatic forceps .....BD-02  
 Rasp  
   bone .....32-25  
   FOMON nasal .....46-15 to 46-16  
   GALLAHER antrum .....46-16  
   JOSEPH (LEWIS) nasal .....46-15  
   MALTZ (COTTLE) nasal .....46-15  
   MALTZ nasal .....46-14  
   PUTTI bone .....32-25  
   WIENER antrum .....46-15  
   WIENER (AUFRICHT) nasal .....46-15  
 Razor .....06-14  
 Razor blade .....06-14, 06-19  
 Razor knife .....06-19  
 Reamer .....33-08, 33-12  
 KUENTSCHER .....33-13  
 PERTHES .....33-08  
 RECAMIER uterine curette .....70-49 to 70-50  
 Rectoscope cold light .....68-03  
 Retractor SCHOENBORN thyroid .....54-04  
 REICHERT epiglottis retractor .....52-02  
 REINER  
   ear syringe .....44-05  
   plaster knife .....30-04  
 Retractor .....18-06, 18-10  
 ADSON .....18-15  
 ADSON-Baby .....18-15  
 ALAN-PARKS anal .....68-03  
 ALM .....18-14  
 AUFRICHT nasal .....46-17  
 BALFOUR abdominal .....18-22  
 BALFOUR Baby abdominal .....18-22  
 BECKMANN .....18-16  
 BECKMANN-ADSON .....18-15  
 BECKMANN-EATON .....18-16  
 BLOUNT knee .....32-24  
 CASPAR .....18-20  
 CASPAR cervical spine .....18-18  
 CASPAR vertebral column .....18-19  
 CASPAR vertebral lumbar .....18-20  
 cheek .....48-03  
 CLOWARD .....18-17  
 COLLIN abdominal .....18-24 to 18-25  
 COLLIN-HARTMANN .....18-03  
 COOLEY atrium .....FG-20  
 COOLEY modif- STRUCK atrium .....FG-20  
 CORYLLOS (Thorax) .....18-13  
 COTTLE nasal .....46-17  
 COTTLE-NEIVERT nasal .....46-17  
 CRILE .....18-02  
 CUSHING .....18-07  
 DARLING .....18-17  
 DAVIDSON (Scapula) .....18-13  
 DEAVER .....18-05  
 DEAVER Grip .....18-05  
 DESMARRES .....18-07  
 DIMEDA .....18-14  
 DOYEN .....18-12  
 FARABEUF .....18-02  
 FINSEN .....18-14  
 FOMON nasal .....46-17

FRAZIER .....18-21  
 FRIEDMAN perineorr .....70-23  
 FRITSCH .....18-11  
 GELPI abdominal .....18-24  
 GOELET .....18-03  
 GOSSET abdominal .....18-21  
 GREEN .....18-10  
 HABERER .....18-04  
 HARRINGTON .....18-05  
 HEANEY .....18-12  
 HOFER pillar .....50-02  
 HRYNTSCHAK prostatic .....66-06  
 ISRAEL .....18-11  
 JANSEN .....18-14  
 JUDD-MASSON bladder .....66-04  
 KALLMORGEN vaginal .....70-15  
 KELLY .....18-04, 18-12  
 KELLY Grip .....18-04  
 KILNER skin .....74-02  
 KIRSCHNER abdominal .....18-23  
 KNAPP .....42-06  
 KOCHER .....18-10 to 18-11  
 KOERTE .....18-11  
 KRISTELLER vaginal .....70-09 to 70-14  
 LAHEY .....18-08  
 LANGENBECK .....18-09  
 LEGUEU bladder .....66-06  
 lip and cheek .....48-03  
 LITTLE .....18-08  
 LOVE uvula .....50-02  
 MATHIEU .....18-03  
 MEYERDING .....18-08  
 MIDDELDORPF .....18-10  
 MIKULICZ .....18-12  
 MILLIN bladder .....66-05  
 MOLLISON .....18-17  
 NAGER palate .....50-02  
 OLLIER .....18-10  
 O'SULLIVAN-O'CONNOR abdominal .....18-21  
 PARKER .....18-02  
 PERCY amputation .....33-03  
 PLESTER .....18-14  
 REICHERT epiglottis .....52-02  
 REVERDIN .....18-04  
 RIBBON .....18-04  
 RICHARDSON .....18-04  
 RICHARDSON-EASTMAN .....18-04  
 RICHARDSON Grip .....18-04  
 RIGBY abdominal .....18-24  
 ROLLET .....42-06  
 ROUX .....18-02  
 ROUX Baby .....18-02  
 ROUX mini .....18-02  
 SAUERBRUCH .....18-13  
 SENN .....18-04  
 SENN-GREEN .....18-07  
 SIMON .....18-12  
 SMITH-BUIE anal .....68-03  
 STERNBERG lip .....48-02  
 TAYLOR spinal .....32-24  
 THOMSON-WALKER bladder .....66-06  
 US Army (PARKER-LANGENBECK) .....18-03  
 VOLKMANN .....18-07 to 18-08  
 WEITLANER .....18-14  
 WEITLANER-WULLSTEIN .....18-14  
 YOUNG prostatic .....66-02  
 REVERDIN  
   ligature needle .....26-03  
   retractor .....18-04  
 REYNOLDS scissors .....07-15, 08-18  
 Rhachiotome .....32-17  
 Ribbon loop electrode .....JA-03  
 RIBBON retractor .....18-04  
 RICHARDSON-EASTMAN retractor .....18-04  
 RICHARDSON Grip retractor .....18-04  
 RICHARDSON retractor .....18-04  
 RICHTER-HEATH clip applying forceps .....26-07  
 RIGBY abdominal retractor .....18-24  
 Ring cutter

DIMEDA finger	33-03
finger	33-03
Ring stripper	20-03
ROBB vascular dissector	FG-33
ROBERTS hemostatic forceps	12-11
ROCHESTER-CARMALT hemostatic forceps	12-07
ROCHESTER-OCHSNER hemostatic forceps	12-06
ROCHESTER-PEAN hemostatic forceps	12-06
ROEDER towel clamp	14-03
ROGER septum elevator	46-11
ROGGE sterilizing forceps	28-02
ROLLET	
extirpation chisel	42-06
retractor	42-06
Rongeur	
ADSON bone	32-03
BEYER bone	32-04
BLUMENTHAL bone	32-02
BÖHLER bone	32-04
CLEVELAND bone	32-02
ECHLIN bone	32-05
FRIEDMAN bone	32-02
FRIEDMAN Mini bone	32-02
FRYKHOLM bone	32-05
LEKSELL STILLE bone	32-05
LEMPERT bone	32-03
LUER bone	32-03
MEAD bone	32-02
OLIVECRONA bone	32-03
RUSKIN bone	32-04
SAUERBRUCH bone	32-05
SCAGLIETTI bone	32-05
SEMB bone	32-06
STILLE-LUER bone	32-04
STILLE-RUSKIN bone	32-05
ZAUFAL-JANSEN bone	32-04
ROSENBERG larynx forceps	52-03
ROSEN	
circular knife	44-14
needle	44-14 to 44-15
ROSER-KOENIG mouth gag	48-03
ROSE tracheal hook	54-03
ROTES KREUZ bandage scissors	08-47
Rounger	
COLCLOUGH intervertebral disc	EA-11
CUSHING laminectomy	EA-08
FERRIS-SMITH-KERRISON intervertebral discEA-10	
FERRIS-SMITH laminectomy	EA-09
LOVE-GRUENWALD laminectomy	EA-08
OLDBERG laminectomy	EA-09
SPURLING laminectomy	EA-08
WAGNER laminectomy	EA-09
ROUX Baby retractor	18-02
ROUX mini retractor	18-02
ROUX retractor	18-02
ROWE mouth forceps	48-06
RUBIN septum crushing forceps	46-07
RUMEL thorax forceps	12-11
RUSKIN bone rongeur	32-04
RUSKIN-LISTON bone cutting forceps	32-06
RUSSIAN thumb and tissue forceps	10-04
RYDEL-SEIFFER tuning fork	44-04
RYDER needle holder	24-03
S	
SAALFELD comedo extractor	74-02
SACHS	
dura dissector	EA-05
nerve hook	EA-04
SADILLOT periosteal elevator	32-19
SAENGER placenta and ovum forceps	72-07
SAIRGES tenaculum forceps	70-32
Salpingograph SCHULTZE	70-47
SANVENERO scissors	07-13, 08-16
SAROT	
bronchus forceps	FG-23
hemostatic bronchus forceps	12-12
needle holder	24-04

SATINSKY	
anastomosis (vena cava) clampFG-24 to FG-25	
atraumatic forceps	BD-20
lung and thorax scissors	08-37
SATO corneal knife	42-05
SAUERBRUCH	
bone rongeur	32-05
SAUERBRUCH-FREY rib shear	FG-06
SAUERBRUCH	
needle case	88-02
retractor	18-13
rib shear	FG-05
waste pickup forceps	28-03
Saw	
BERGMANN plaster	30-02
CHARRIERE amputation	33-03
CHARRIERE blade	33-03
Saw conductor De MARTEL	EA-05
Saw	
ENGEL plaster	30-02
JOSEPH nasal	46-17
LANGENBECK finger	33-03
OLIVECRONA wire	EA-05
SAWTELL tonsil forceps	50-03
Saw	
WIGMORE plaster	30-02
SCAGLIETTI bone rongeur	32-05
Scalpel handle .06-02 to 06-05, 06-07 to 06-08	
CASPAR micro surgical	06-12
LANDOLT micro surgical	06-13
Scalpel remover	06-06, 06-10
Scalpel, sterile blade	06-06, 06-09
Scarifier	
GRAEFE	42-04
KUHN corneal	42-05
SCHAMBERG comedo extractor	74-02
SCHEDIÈ bone curette	32-12
SCHIEI	
eye cannula	43-07
goniometry knife	42-05
SCHNEIMANN larynx forceps	52-03
SCHERBAK vaginal speculum	70-21
SCHIMMELBUSCH sterilizing drums	88-12
SCHINK dermatome	06-21
SCHIOETZ tonometer	43-08
SCHMIEDEN ligature conductor	26-04
SCHMIEDEN-PAYR ligature conductor	26-04
SCHMIEDEN-TAYLOR scissors	08-36
SCHNIDT tonsil forceps	50-03
SCHOENBORN thyroid retractor	54-04
SCHOENBURG grasping forceps	64-03
SCHROEDER	
tenaculum forceps	70-31 to 70-32
uterine curette	70-48
SCHUBERT uterine biopsy specimen forceps	70-41
SCHUKNECHT	
roller knife	44-14
sickle knife	44-14
SCHULTZE salpingograph	70-47
SCHUMACHER	
larynx forceps	52-03
sternum shear	FG-07
umbilical scissors	08-34
uterine biopsy specimen forceps	70-43
SCHWEIGGER capsular forceps	43-04
Scissors	07-02 to 07-04, 08-02 to 08-04
AEBL corneal	08-22
BARRAQUER colibri	09-04
BEEBEE wire and plate	08-43
BELLUCCI ear micro	44-09
BERGMANN bandage	08-46
BEUSE scissors toothed	08-26
BOETICHER tonsil	08-27
BRAUN-STADLER episiotomy	07-22, 08-34
BRUNS plaster	08-48
BUCK ligature	08-40
BUSCH umbilical	08-34
CASTROVIEJO corneal	09-06
CASTROVIEJO iridectomy	09-05

COTTLE nasal	07-18, 08-25
CRAFOORD lung and thorax	08-36
cuticle	74-03
DANDY neurosurgical	08-36
DEAN tonsil	08-26
DEAVER	07-05, 08-06
DE BAKEY vascular	08-30
DIETRICH vascular	08-29
DIMEDA bandage	08-46
DOYEN gynecological	08-33
DUBOIS gynecological	08-33
ear micro	44-11
ear micro-mini	44-11
ESMARCH bandage	08-46
FERGUSON	08-49
FINOCHIETTO rectal	08-38
FOMON nasal	07-18, 08-25
GOLDMAN-FOX gum	08-41
GOOD tonsil	08-27
GORNEY dissecting	08-13
HEATH ligature	08-40
HEYMANN nasal	07-18, 08-25
IRIS	07-16, 08-21
IRIS eye	08-22
IRIS large rings	08-19
JACOBSON micro	09-11
JOSEPH	07-14, 08-16
KELLY gynecological	07-22, 08-33
KILNER	07-14, 08-17
KLINKENBERGH-LOTH lung and thorax	08-37
KNAPP	08-20
KNOWLES bandage	08-47
LAGRANGE gum	08-41
LANDOLT enucleation	08-25
LANGE bandage	08-44
LEXER	07-09
LEXER-BABY	07-10
LEXER dissecting	08-11 to 08-12
LISTER bandage	07-23, 08-45
LITTAUER ligature	08-40
LITTLER dissecting	08-13
LOCKLIN	08-18
LORENZ bandage	08-47
MAYO	07-06, 08-07
MAYO left handed	08-07
MAYO-NOBLE	07-08, 08-10
MAYO-STILLE	07-07, 08-08 to 08-09
McGUIRE corneal	09-05
McINDOE cartilage	08-35
McPHERSON WESTCOTT tenotomy	09-04
METZENBAUM	07-11
METZENBAUM dissecting	08-13 to 08-14
METZENBAUM FINO	07-12
METZENBAUM FINO dissecting	08-15
METZENBAUM "S"	07-13, 08-16
MILLS vascular	08-27
nail	74-03
NORTHBENT ligature	08-40
NOYES iris	09-03 to 09-04
NOYES tendon	09-03
POTTS DE MARTEL vascular	08-27
POTTS-SMITH vascular	07-19, 08-28
PRINCE tonsil	08-27
QUINBY gum	08-42
REYNOLDS	07-15, 08-18
ROTES KREUZ bandage	08-47
SANVENERO	07-13, 08-16
SATINSKY lung and thorax	08-37
SCHMIEDEN-TAYLOR	08-36
SCHUMACHER umbilical	08-34
SHEA ear micro	44-09
SHORTBENT ligature	08-40
SIEBOLD gynecological	07-21, 08-32
SIMS gynecological	07-21, 08-32
SMITH US ARMY bandage	08-44
SPENCER ligature	08-40
STELZNER rectal	08-38
STEVENS tenotomy	07-17, 08-23
STRULLY neurosurgical	08-35

THOREK lung and thorax . . . . .	08-36	SIMCOE suturing cannula . . . . .	43-07	BRUENINGS ear . . . . .	44-02
TOENNIS-ADSON neurosurgical . . . . .	08-35	SIMON		COTTLE nasal . . . . .	46-03
TROUTMAN-CASTROVIEJO micro . . . . .	09-07	bone curette . . . . .	32-13	GRUBER ear . . . . .	44-02
UNIVERSAL bandage . . . . .	08-50	retractor . . . . .	18-12	HARTMANN ear . . . . .	44-02
UNIVERSAL wire and plate . . . . .	08-42	uterine curette . . . . .	70-48	HARTMANN-HALLE nasal . . . . .	46-02
USA MODEL umbilical . . . . .	08-34	SIMPSON-BRAUN obstetrical forceps . . . . .	72-02	KILLIAN septum . . . . .	46-03
VANNAS iridectomy . . . . .	09-05	SIMPSON-LUIKART obstetrical forceps . . . . .	72-03	SIEGLE ear . . . . .	44-02
VANNAS micro . . . . .	09-12 to 09-13	SIMPSON obstetrical forceps . . . . .	72-02	THUDICHUM nasal . . . . .	46-02
WAGNER . . . . .	07-22	SIMS		TIECK-HALLE nasal . . . . .	46-03
WAGNER gum . . . . .	08-42	gynecological scissors . . . . .	07-21, 08-32	TOYNBEE ear . . . . .	44-02
WALDMANN episiotomy . . . . .	08-34	SIMS-MAIER dressing forceps . . . . .	16-05	Vienna nasal . . . . .	46-02
WECKER iris . . . . .	09-04	SIMS		VOITOLINI nasal . . . . .	46-02
WERTHEIM preparation . . . . .	08-32	rectal speculum . . . . .	68-02	YANKAUER postnasal . . . . .	46-04
WESTCOTT iridectomy . . . . .	09-02	uterine curette . . . . .	70-49 to 70-50	Speculum	
WESTCOTT tendon . . . . .	09-02	uterine depressor . . . . .	70-39	ARRUGA eye . . . . .	42-02
WULLSTEIN ear micro . . . . .	44-11	uterine dilator . . . . .	70-30	AUVARD vaginal . . . . .	70-19
WULLSTEIN ear micro-mini . . . . .	44-11	uterine sound . . . . .	70-39	BARRAQUER Colibri eye . . . . .	42-02
YASARGIL micro . . . . .	09-10 to 09-11	vaginal speculum . . . . .	70-17	BARR rectal . . . . .	68-02
Sclerotome		SINGLEY thumb and tissue forceps . . . . .	10-05	BERLIND-AUVARD vaginal . . . . .	70-19
GUYTON-LUNDSGAARD . . . . .	42-05	Sinker corticalis . . . . .	33-15	BODENHAMMER rectal . . . . .	68-02
LUNDSGAARD . . . . .	42-05	SKENE tenaculum forceps . . . . .	70-31	BOWMAN eye . . . . .	42-02
Scoop		Skin fixing plate . . . . .	06-21	BRAUN vaginal . . . . .	70-16
BUNGE exenteration . . . . .	42-07	Skull breaker VIRCHOW . . . . .	32-17	BREISKY vaginal . . . . .	70-20
CUZZI placenta and ovum . . . . .	72-08	SLUDER-BALLENGER tonsillectome . . . . .	50-05	CASTROVIEJO eye . . . . .	42-03
DESJARDINS gall stone . . . . .	62-08	SMELLIE		CLARK eye . . . . .	42-02
FERGUSON gall stone . . . . .	62-07	obstetrical hook . . . . .	72-06	COLLIN vaginal . . . . .	70-04
GUTMANN secretions . . . . .	66-11	perforator . . . . .	72-09	CRITCHETT eye . . . . .	42-02
LUER-KOERTE gall stone . . . . .	62-09	SMILLIE meniscotome . . . . .	32-24	CUSCO vaginal . . . . .	70-04 to 70-06
MAYO gall stone . . . . .	62-07	SMITH-BUIE anal retractor . . . . .	68-03	CZERNY rectal . . . . .	68-02
MOORE gall stone . . . . .	62-05	SMITH EYE SPECULUM . . . . .	42-02	DOYEN vaginal . . . . .	70-18, 70-20
PESTALOZZA placenta and ovum . . . . .	72-08	SMITH-PETERSEN		FREEWAY-GRAVE vaginal . . . . .	70-06
WALLICH placenta and ovum . . . . .	72-08	bone chisel . . . . .	32-15	GOLDSTEIN eye . . . . .	42-03
WELLS enucleation . . . . .	42-08	bone gouge . . . . .	32-15	GRAEFE eye . . . . .	42-02
Screw DOYEN myoma . . . . .	70-46	SMITH US ARMY bandage scissors . . . . .	08-44	GRAVE vaginal . . . . .	70-02
Screw driver . . . . .	33-14 to 33-15	SMITHWICK		JACKSON vaginal . . . . .	70-16
LANE . . . . .	33-14	clip applying forceps . . . . .	EA-02	KALLMORGEN vaginal . . . . .	70-15
WILLIAMS . . . . .	33-14	nerve hook . . . . .	EA-04	KOGAN endo . . . . .	70-23
SEEMANN-SEIFFERT mouth gag . . . . .	48-04	Snare		KRISTELLER vaginal . . . . .	70-09 to 70-14
SEGOND myoma knife . . . . .	70-46	BRUENINGS tonsil . . . . .	50-04	LANCASTER eye . . . . .	42-03
SEIFFERT larynx forceps . . . . .	52-03	EVES tonsil . . . . .	50-04	LANDAU vaginal . . . . .	70-22
SELLHEIM elevating spoon . . . . .	72-09	KRAUSE ear polypus . . . . .	44-07	LISTER-BURCH eye . . . . .	42-02
SELLORS rib contractor . . . . .	FG-18	KRAUSE nasal . . . . .	46-09	MATHIEU rectal . . . . .	68-02
SEMB		TYDING tonsil . . . . .	50-05	MELLINGER-AXENFELD eye . . . . .	42-02
bone cutting forceps . . . . .	32-07	WESTON rectal polypus . . . . .	68-05	MELLINGER eye . . . . .	42-02
bone holding forceps . . . . .	32-07	WILDE ear polypus . . . . .	44-07	MUELLER eye . . . . .	42-03
bone rongeur . . . . .	32-06	WILDE nasal . . . . .	46-09	MURDOCK eye . . . . .	42-02
bronchus forceps . . . . .	FG-23	SNELLEN		O'SULLIVAN-O'CONNOR vaginal . . . . .	70-08
periosteal elevator . . . . .	32-20	entropium forceps . . . . .	43-06	PARK eye . . . . .	42-03
SEMKEN thumb and tissue forceps . . . . .	10-05	wire loop . . . . .	42-08	PEDERSON vaginal . . . . .	70-03
SEMM vaginal speculum . . . . .	70-07	SOMER uterine elevating forceps . . . . .	70-37	PRATT rectal . . . . .	68-02
SENN-GREEN retractor . . . . .	18-07	Sound		SCHERBAK vaginal . . . . .	70-21
SENN retractor . . . . .	18-04	COLLIN uterine . . . . .	70-39	SEMM vaginal . . . . .	70-07
Septatome BRUENINGS . . . . .	46-11	COXETER urethral . . . . .	66-17	SIMS rectal . . . . .	68-02
Sequester forceps . . . . .	32-10	DITTEL urethral . . . . .	66-18 to 66-19	SIMS vaginal . . . . .	70-17
SEUTIN plaster shear . . . . .	30-02	GUYON urethral . . . . .	66-12, 66-14 to 66-15	SMITH eye . . . . .	42-02
SEXTON ear knife . . . . .	44-06	MARTIN uterine . . . . .	70-39	STEINER-AUVARD vaginal . . . . .	70-19
SHEA ear micro scissors . . . . .	44-09	SIMS uterine . . . . .	70-39	STEVENSON eye . . . . .	42-03
Shear		VALLEIX uterine . . . . .	70-39	TRELAT vaginal . . . . .	70-07
BETHUNE rib . . . . .	FG-04	VAN BUREN urethral . . . . .	66-13	WEEK eye . . . . .	42-02
BRUNNER rib . . . . .	FG-07	WALTHER urethral . . . . .	66-17	WEISSBARTH vaginal . . . . .	70-22
COOLEY rib first . . . . .	FG-05	Spare lamp		WILLIAMS eye . . . . .	42-02
CORYLLOS rib . . . . .	FG-04	conventional laryngoscope . . . . .	AE-20	ZIEGLER eye . . . . .	42-03
GIERTZ-STILLE rib . . . . .	FG-06	fiber optic laryngoscope . . . . .	AE-20	SPENCER ligature scissors . . . . .	08-40
GLUCK rib . . . . .	FG-03	Spatula		SPENCER-WELLS hemostatic forceps . . . . .	12-07
rib . . . . .	FG-02	ALLISON lung . . . . .	FG-19	Splinter forceps . . . . .	10-06
SAUERBRUCH-FREY rib . . . . .	FG-06	BANGERTER cyclodialysis . . . . .	42-08	Spoon	
SAUERBRUCH rib . . . . .	FG-05	CASTROVIEJO cyclodialysis . . . . .	42-08 to 42-009	DAVIEL cataract . . . . .	42-07
SCHUMACHER sternum . . . . .	FG-07	CULLER iris . . . . .	42-08	GRAEFE cataract . . . . .	42-07
SEUTIN plaster . . . . .	30-02	CUSHING brain . . . . .	EA-07	GROSS ear . . . . .	44-06
STILLE plaster . . . . .	30-02	ELSCHNIG cyclodialysis . . . . .	42-08	KNAPP cataract . . . . .	42-07
STILLE rib . . . . .	FG-03	HEIFETZ brain . . . . .	EA-07	SELLHEIM elevating . . . . .	72-09
SHORTBENT ligature scissors . . . . .	08-40	intima . . . . .	FG-32	SPRATT bone curette . . . . .	32-12
SIEBOLD gynecological scissors . . . . .	07-21, 08-32	KOCHER bladder . . . . .	66-04	Spreader	
SIEGLE ear specula . . . . .	44-02	LEGUEU bladder . . . . .	66-04	BEESON plaster . . . . .	30-03
SIEGLER HELLMANN uterine elevating forceps	70-38	OLIVECRONA brain . . . . .	EA-07	BOSE tracheal . . . . .	54-02
SILVER		WECKER iris . . . . .	42-08	CASTAÑEDA rib . . . . .	FG-14
dermatome . . . . .	06-20	WHEELER cyclodialysis . . . . .	42-09	CHEVALLIER rib . . . . .	FG-15
rhinoplastic chisel . . . . .	46-14	Specula		CLOWARD lamina . . . . .	EA-07
		BOUCHERON ear . . . . .	44-02	COOLEY rib . . . . .	FG-09

FINOCHIETTO-BABY rib . . . . .	FG-09	SUBRAMANIAN atraumatic forceps . . . . .	BD-31	JONES tube holder . . . . .	14-02
FINOCHIETTO BURFORD rib .FG-12 to FG-14		Suction tube		LANE . . . . .	14-05
FINOCHIETTO-HAIGHT BABY rib . . . . .	FG-10	ANDREWS-PINCHON . . . . .	04-03	LORNA . . . . .	14-04
FINOCHIETTO INFANT rib . . . . .	FG-12	DE BAKEY . . . . .	04-04	MOYNIHAN . . . . .	14-05
FINOCHIETTO (modif) rib . . . . .	FG-08	FRAZIER . . . . .	04-06	PEERS BERTRAM . . . . .	14-03
FINOCHIETTO rib . . . . .	FG-08, FG-10 to FG-11	MAGILL . . . . .	04-04	ROEDER . . . . .	14-03
HAGLUND-STILLE plaster . . . . .	30-03	NUBOER . . . . .	04-05	TOHOKU . . . . .	14-04
HAIGHT rib . . . . .	FG-15	POOLE . . . . .	04-02	TOWNSEND-KEVORKIAN	
HENNIG plaster . . . . .	30-03	WALTON YANKAUER . . . . .	04-03	uterine biopsy specimen forceps . . . . .	70-44
HERMANN plaster . . . . .	30-03	YANKAUER . . . . .	04-02	TOWNSEND-MINI (BABY TISCHLER)	
HERTZLER rib . . . . .	FG-17	Suturing kit		uterine biopsy specimen forceps . . . . .	70-45
INGE lamina . . . . .	EA-07	mini . . . . .	26-08	TOWNSEND-mini uterine biopsy specimen forceps	
MERCEDES thoracic . . . . .	FG-16	standard . . . . .	26-08	70-44	
MILLIN bladder neck . . . . .	66-07	Suturing needle . . . . .	26-05 to 26-06	TOWNSEND-TISCHLER	
MORSE-FAVOLORO rib . . . . .	FG-17	SWEET clip applying forceps . . . . .	EA-02	uterine biopsy specimen forceps . . . . .	70-44
QUATTRO plaster . . . . .	30-03	Syringe		TOWNSEND uterine biopsy specimen forceps70-	
TUFFIER rib . . . . .	FG-16	REINER ear . . . . .	44-05	44	
Spud DIX foreign body . . . . .	42-06	tonsil . . . . .	50-05	TOYNBEE ear specula . . . . .	44-02
SPURLING laminectomy rongeur . . . . .	EA-08	T		Traction bar GERSTER . . . . .	32-11
STACKE probe . . . . .	20-02	TABB sickle knife . . . . .	44-14	TRAUBE percussion hammer . . . . .	02-07
Stainer vaginal speculum . . . . .	70-22	Tap screw . . . . .	33-15	Tray	
Standard suturing kit . . . . .	26-08	TARNIER		instrument . . . . .	88-08 to 88-09
STAUDE-MOORE tenaculum forceps . . . . .	70-31	cranioclast . . . . .	72-09	sterilization, sheet metal . . . . .	88-13
St. CLAIR-THOMSON adenoid curette . . . . .	46-19	obstetrical, with traction rod forceps . . . . .	72-05	sterilization, wire mesh . . . . .	88-13
STEINER-AUVARD vaginal speculum . . . . .	70-19	TAYLOR		TRELAT vaginal speculum . . . . .	70-07
STEINMANN pin . . . . .	33-09	percussion hammer . . . . .	02-07	Trepine . . . . .	33-04
STELZNER rectal scissors . . . . .	08-38	spinal retractor . . . . .	32-24	CASTROVIEJO corneal . . . . .	43-07
Sterile disposable scalpel . . . . .	06-10 to 06-11	TEALE tenaculum forceps . . . . .	70-33	ELLIOT corneal . . . . .	43-08
Sterile, micro surgical scalpel blade . . . . .	06-13	Tendon stripper BUNNELL . . . . .	32-25	FRANCESCHETTI corneal . . . . .	43-07
Sterilization container		TERSON capsular forceps . . . . .	43-04	Trocar . . . . .	22-02
3/4 . . . . .	88-22 to 88-24	THOMS-ALLIS tissue forceps . . . . .	64-02	COAKLEY . . . . .	22-02
flat half size . . . . .	88-30 to 88-31	THOMS-GAYLOR uterine biopsy specimen forceps		DOUGLAS . . . . .	22-02
half size . . . . .	88-26 to 88-29	70-42		FLEURANT . . . . .	22-02
large . . . . .	88-18 to 88-20	THOMSON-WALKER bladder retractor . . . . .	66-06	LICHTWITZ . . . . .	22-02, 46-09
small . . . . .	88-32 to 88-33	THOREK lung and thorax scissors . . . . .	08-36	MENGHINI . . . . .	22-03
special . . . . .	88-34 to 88-37	THUDICHUM nasal specula . . . . .	46-02	NELSON . . . . .	22-02
Sterilizing forceps . . . . .	28-02	TIECK-HALLE nasal specula . . . . .	46-03	OCHSNER . . . . .	22-02
STERNBERG lip retractor . . . . .	48-02	TIEMANN tenaculum forceps . . . . .	70-32	PIERCE . . . . .	22-02
Stethoscope		TILLEY ear forceps . . . . .	44-08	UCKERMANN tracheal . . . . .	54-02
BOWLES . . . . .	02-06	TISCHLER-KEVORKIAN		UNIVERSAL . . . . .	22-02
FORD . . . . .	02-06	uterine biopsy specimen forceps 70-44 to 70-45		TROELTSCH nasal forceps . . . . .	46-04
FORD BOWLES . . . . .	02-06	TISCHLER-MORGAN		TROEMNER percussion hammer . . . . .	02-07
PINARD . . . . .	02-06	uterine biopsy specimen forceps70-43 to 70-44,		TROUSSEAU tracheal dilator . . . . .	54-02
STEVENS		70-46		TROUTMAN-CASTROVIEJO micro scissors . . . . .	09-07
iris forceps . . . . .	42-11	TIVNEN tonsil seizing forceps . . . . .	50-04	TROUTMAN-CHRIS blade breaker . . . . .	06-14
lens hook . . . . .	42-06	TOBOLD		TROUTMAN Colibri iris forceps . . . . .	42-13
STEVENSON eye speculum . . . . .	42-03	cotton applicator . . . . .	20-03	TROUTMAN rectus forceps . . . . .	43-02
STEVENS		tongue depressor . . . . .	48-02	TUBBS mitral valve dilator . . . . .	FG-27
ophthalmologic needle holder . . . . .	24-06	TOENNIS-ADSON neurosurgical scissors . . . . .	08-35	Tube	
tenotomy scissors . . . . .	07-17, 08-23	TOENNIS		BRUENINGS extension . . . . .	52-03
STIEGLITZ splinter forceps . . . . .	10-06	dura dissector . . . . .	EA-05	JACKSON tracheal . . . . .	54-03
STILLE		hemostatic forceps . . . . .	12-11	LUER tracheal . . . . .	54-03
bone chisel . . . . .	32-14	needle holder . . . . .	24-04	WAGENER-MOSHER tracheal . . . . .	54-03
bone gouge . . . . .	32-14	TOHOKU towel clamp . . . . .	14-04	Tubing clamp forceps . . . . .	12-19
bone hand drill . . . . .	33-04	Tong CRUTCHFIELD cervical traction . . . . .	EA-03	Tübingen	
STILLE-HORSLEY bone cutting forceps . . . . .	32-07	Tongue depressor		air cannula . . . . .	43-07
STILLE		ANDREW . . . . .	48-02	iris forceps . . . . .	42-15
kidney pedicle forceps . . . . .	12-16	BRUENINGS . . . . .	48-02	Tübingen TITAN	
STILLE-LISTON bone cutting forceps . . . . .	32-06	BUCHWALD . . . . .	48-02	iris forceps . . . . .	42-15
STILLE-LUER bone rongeur . . . . .	32-04	FRENZEL . . . . .	48-02	tying forceps . . . . .	43-05
STILLE		HARTMANN . . . . .	48-02	Tübingen	
osteotome . . . . .	32-14	McIVOR . . . . .	48-05	tying forceps . . . . .	43-05
plaster shear . . . . .	30-02	TOBOLD . . . . .	48-02	TUFFIER	
rib shear . . . . .	FG-03	WIEDER . . . . .	48-02	hemostatic forceps . . . . .	12-08
STILLE-RUSKIN bone rongeur . . . . .	32-05	wooden . . . . .	48-02	rib spreader . . . . .	FG-16
STILLE-SHERMAN bone hand drill . . . . .	33-04	Tonometer SCHIOETZ . . . . .	43-08	Tuning fork . . . . .	44-04
STILLE		Tonsillectome SLUDER-BALLENGER . . . . .	50-05	DIMEDA Alu . . . . .	44-03
thumb and tissue forceps . . . . .	10-02	TOOK corneal knife . . . . .	42-05	HARTMANN . . . . .	44-03
St. MARTIN suture forceps . . . . .	43-05	TOTI drill burr . . . . .	33-07	LUCAE . . . . .	44-04
STOCKMANN Penile clamp . . . . .	66-10	Tourniquet . . . . .	02-03	RYDEL-SEIFFER . . . . .	44-04
STONE closing forceps . . . . .	64-06	Towel clamp		TURNBULL nail nipper . . . . .	74-03
STONE-WATT intestinal forceps . . . . .	64-06	BACKHAUS . . . . .	14-02	TURREL biopsy specimen forceps . . . . .	68-05
Strabismus scissors . . . . .	07-17, 08-24	BACKHAUS-CLIP tube holder . . . . .	14-03	TYDING	
STRATTE needle holder . . . . .	24-04	BACKHAUS KOCHER . . . . .	14-02	tonsil seizing forceps . . . . .	50-04
STRAUSS Penile clamp . . . . .	66-10	BALL AND SOCKET . . . . .	14-04	tonsil snare . . . . .	50-05
STRUEMPPEL ear forceps . . . . .	44-08	BERNHARD . . . . .	14-05		
STRULLY neurosurgical scissors . . . . .	08-35	DOYEN . . . . .	14-05	U	
STRUYCKEN nasal cutting forceps . . . . .	46-07	HOFF . . . . .	14-03	UCKERMANN	
Styler MAGILL . . . . .	04-04			cotton applicator . . . . .	20-03





Inhaltsverzeichnis  
**Index**  
 Index  
 Índice alfabético  
 Indice alphabético

tracheal trocar . . . . .54-02  
 ULRICH sponge holding forceps . . . . .16-06  
 Umbilic-cord KANE umbilical cord . . . . .72-06  
 UNIVERSAL  
   bandage scissors . . . . .08-50  
   sterilizing forceps . . . . .28-02  
   trocar . . . . .22-02  
   wire and plate scissors . . . . .08-42  
 UNNA comedo extractor . . . . .74-02  
 Urethrotome OTIS . . . . .66-08  
 Urinal . . . . .88-10  
 USA  
   electrosurgery equipment cable . . . . .JA-07  
 USA MODEL umbilical scissors . . . . .08-34  
 US Army (PARKER-LANGENBECK) retractor 18-03  
 USA  
   thumb and tissue forceps . . . . .10-02  
 V  
 VALLEIX uterine sound . . . . .70-39  
 VAN BUREN  
   sequester forceps . . . . .32-10  
   urethral sound . . . . .66-13  
 Van DOREN uterine biopsy specimen forceps70-42  
 VANNAS  
   iridectomy scissors . . . . .09-05  
   micro scissors . . . . .09-12 to 09-13  
 VARIFOCAI ophthalmoscope . . . . .02-03  
 Vascular micro scissors . . . . .09-09  
 Vascular, parametrium scissors . . . . .07-20, 08-31  
 Vascular scissors . . . . .08-27  
 VERBRUGGE bone holding forceps . . . . .32-09  
 VERRES pneumoperitoneum puncture needle22-03  
 Vessel flexible clamp . . . . .BD-44 to BD-45  
 Vienna nasal specula . . . . .46-02  
 VIRCHOW  
   brain knife . . . . .06-18  
   cartilage knife . . . . .06-18  
   skull breaker . . . . .32-17  
 VIRTUS (RALK) splinter forceps . . . . .10-06  
 VOLKMANN  
   bone curette . . . . .32-12 to 32-13  
   retractor . . . . .18-07 to 18-08  
 VOLTOLINI nasal specula . . . . .46-02  
 W  
 WACHENFELDT clip applying forceps . . . . .26-07  
 WADSWORTH-TODD cauter . . . . .42-08  
 WAGENER ear hooklet . . . . .44-07  
 WAGENER-MOSHER tracheal tube . . . . .54-03  
 WAGNER  
   gum scissors . . . . .08-42  
   laminectomy rongeur . . . . .EA-09  
   scissors . . . . .07-22  
 WALDMANN episiotomy scissors . . . . .08-34  
 WALLICH placenta and ovum scoop . . . . .72-08  
 WALSHAM septum forceps . . . . .46-18  
 WALTHER urethral sound . . . . .66-17  
 WALTON  
   comedo extractor . . . . .74-02  
   foreign body gouge . . . . .42-06  
 WALTON YANKAUER suction tube . . . . .04-03  
 WANGENSTEEN  
   needle holder . . . . .24-03  
   thumb and tissue forceps . . . . .10-05  
 WARTENBERG pin-wheel . . . . .02-08  
 Wash basin . . . . .88-05  
 Watchmaker forceps . . . . .10-06  
 WATSON-CHEYNE elevator . . . . .32-22  
 WATSON dermatome . . . . .06-22  
 WEBER  
   atraumatic forceps . . . . .BD-12  
   wire loop . . . . .42-08  
 WECKER  
   iris scissors . . . . .09-04  
   iris spatula . . . . .42-08  
 WEEK eye speculum . . . . .42-02  
 WEIL-BLAKESLEY nasal cutting forceps . . . . .46-06

WEISSBARTH vaginal speculum . . . . .70-22  
 WEISS tubing clamp forceps . . . . .12-19  
 WEITLANER retractor . . . . .18-14  
 WEITLANER-WULLSTEIN retractor . . . . .18-14  
 WELLS enucleation scoop . . . . .42-08  
 WERTHEIM-CULLEN hysterectomy forceps .12-18  
 WERTHEIM  
   hysterectomy forceps . . . . .12-18  
   preparation scissors . . . . .08-32  
 WESTCOTT  
   iridectomy scissors . . . . .09-02  
   tendon scissors . . . . .09-02  
 WEST  
   nasal chisel . . . . .46-14  
   nasal gouge . . . . .46-14  
 WESTON rectal polypus snare . . . . .68-05  
 WHEELER  
   cyclodialysis spatula . . . . .42-09  
   discision knife . . . . .42-04  
 WHITEHEAD mouth gag . . . . .48-04  
 WHITE tonsil seizing forceps . . . . .50-03  
 WIEDER tongue depressor . . . . .48-02  
 WIENER  
   antrum rasp . . . . .46-15  
 WIENER (AUFRICHT) nasal rasp . . . . .46-15  
 WIENER  
   iris hook . . . . .42-06  
 WIGMORE plaster saw . . . . .30-02  
 WILDE  
   ear polypus snare . . . . .44-07  
   nasal snare . . . . .46-09  
 WILDER  
   lachrymal dilator . . . . .42-10  
   wire loop . . . . .42-08  
 WILDE (TROELTSCH) ear forceps . . . . .44-07  
 WILLET-MARTELL scalp flap forceps . . . . .12-08  
 WILLIAMS  
   eye speculum . . . . .42-02  
   grasping forceps . . . . .64-03  
   screw driver . . . . .33-14  
 WILLIGER  
   bone curette . . . . .32-13  
   hammer . . . . .32-18  
   periosteal elevator . . . . .32-19  
 WINKELMANN circumcision clamp . . . . .66-09  
 WINTER placenta and ovum forceps . . . . .72-07  
 Wire cutter . . . . .33-12  
   DIAMANT . . . . .33-12  
 Wiredrill KIRSCHNER . . . . .33-09  
 Wire loop electrode . . . . .JA-03  
 Wire twister LOUTE . . . . .33-11  
 WITTNER uterine biopsy specimen forceps .70-43  
 WOLFF plaster breaker . . . . .30-04  
 WRIGLEY obstetrical forceps . . . . .72-02  
 WULLSTEIN  
   ear micro-mini scissors . . . . .44-11  
   ear micro scissors . . . . .44-11  
   sickle knife . . . . .44-14  
 WYLIE  
   atraumatic forceps . . . . .BD-21  
   uterine dilator . . . . .70-30  
 Y  
 YANKAUER  
   postnasal specula . . . . .46-04  
   suction tube . . . . .04-02  
 YASARGIL micro scissors . . . . .09-10 to 09-11  
 YEOMAN biopsy specimen forceps . . . . .68-05  
 YOUNG Boomerang ligature needle . . . . .26-03  
 YOUNG  
   prostatic grasping forceps . . . . .66-02  
   prostatic retractor . . . . .66-02  
   tongue holding forceps . . . . .48-03  
 Z  
 ZAUFAL-JANSEN bone rongeur . . . . .32-04  
 ZENKER hemostatic forceps . . . . .12-12  
 ZIEGLER  
   capsulotomy knife . . . . .42-05

eye speculum . . . . .42-03  
 head mirror . . . . .02-05  
 iris knife . . . . .42-04  
 lachrymal dilator . . . . .42-10



**A**

Abaisse-langue  
ANDREW .....48-02  
bois.....48-02  
BRUENINGS .....48-02  
BUCHWALD .....48-02  
FRENZEL .....48-02  
HARTMANN .....48-02  
McIVOR .....48-05  
TOBOLD .....48-02  
WIEDER .....48-02

Accessoires pour containers  
pour la stérilisation .....88-38 jusque 88-41

Adenotome LAFORCE .....46-19

ADLERKREUTZ pince à dissection .....10-04

ADSON Baby  
écarteur .....18-15

ADSON BABY  
pince hémostatique .....12-09

ADSON-BROWN pince à dissection .....10-03

ADSON  
écarteur .....18-15  
écarteur à nerfs .....EA-04  
élevateur .....32-21  
pince à dissection .....10-03  
pince à dissection, micro .....10-03  
pince à hypophyse .....EA-06  
pince gouge .....32-03  
pince hémostatique .....12-09  
porte-aiguille .....24-04

AEBLI ciseaux cornéens .....08-22

AESCLAP cordon électrobistouris .....JA-07

Aesthésiomètre WARTENBERG .....02-08

Agrafe MICHEL .....26-07

Aiguille  
à amygdales .....50-05  
à cataracte .....42-05

Aiguille à sutures .....26-05 jusque 26-06

Aiguille  
BARBARA .....44-14  
BOWMAN à dissections .....42-05  
COOPER à ligatures .....26-02  
DAVIS pour corps étrangers .....42-05  
DESCHAMPS à ligatures .....26-02  
DUPUY-WEISS pour les amygdales .....50-03  
électrode .....JA-03  
électrode mini .....JA-02  
FRANCIS pour corps étrangers .....42-05  
FRANKLIN-SILVERMANN à ponction .....22-03  
KEITH à sutures .....26-06  
KOENIG à sutures .....26-06  
KRONECKER à ligatures .....26-02  
LEVINSON pour corps étrangers .....42-05  
LICHTWITZ .....46-09  
NELSON à ligatures .....26-02  
POLITZER paracentèse .....44-06  
pour corps étrangers .....42-05  
QUINKE à ponction .....22-03  
REVERDIN à ligatures .....26-03  
ROSEN .....44-14 jusque 44-15  
VERRES à ponction pneumopéritoine .....22-03  
YOUNG Boomerang à ligatures .....26-03

Aimant DIMEDA oculaire .....43-08

ALAN-PARKS dilateur pour anus et rectum .....68-03

ALBEE fraise .....33-07

Alésoir  
CRUTCHFIELD .....EA-03  
KUENTSCHER .....33-13  
pour clous .....33-12

ALEXANDER  
ciseaux-burin .....32-14  
gouge .....32-14  
pince emporte-pièce pour le col de l'utérus70-42  
rugine raspatoire .....32-19

ALLIS-ADAIR pince pour saisir les tissus .....64-02

ALLIS-Baby pince pour saisir les tissus .....64-02

ALLISON spatule pulmonaire .....FG-19

ALLIS pince pour saisir les tissus .....64-02

ALM écarteur .....18-14

ALVIS curette pour corps étrangers .....42-06

Amniotome BEACHAM .....70-39

Ampoule de rechange laryngoscope, fibres optiques .....AE-20

Ampoule de rechange laryngoscope, standardAE-20

Amygdalotome SLUDER-BALLENGER .....50-05

ANDREW abaisse-langue .....48-02

ANDREWS-PINCHON tube d'aspiration .....04-03

Anse  
ARLT .....42-08  
auriculaire .....44-07  
BILLEAU auriculaire .....44-07  
électrode mini .....JA-02 jusque JA-03

Anse en bande électrode .....JA-03

Anse en fil électrode .....JA-03

Anse  
à amygdales .....50-04

Anse  
nasale .....46-09

Anse  
SNELLEN .....42-08  
WEBER .....42-08  
WILDER .....42-08

Anuscope  
HIRSCHMANN .....68-04  
IVES-FANSLER .....68-04

Appareil PETZ à sutures stomacales et intestinales 64-09

ARCHER pince à échardes .....10-06

ARKANSAS pierre à repasser .....06-19

ARLT anse .....42-08

ARRUGA  
blépharostat .....42-02  
crochet à extraction .....42-06  
pince capsulaire .....43-04  
porte-aiguille pour l'ophtalmologie .....24-06  
protecteur .....42-08

ASCH pince à redresser la cloison .....46-18

Assourdisseur BARANY .....44-04

AUFRIEHT écarteur nasal .....46-17

AUVARD spéculum vaginal .....70-19

AXENFELD curette à chalazion .....42-07

AYER pince à chalazion .....43-06

B  
BABCOCK pince pour saisir les tissus .....64-02

BABINSKY marteau percuteur .....02-07

BACKHAUS-CLIP pince à champs clamp porte-tube 14-03

BACKHAUS KOCHER pince à champs .....14-02

BACKHAUS pince à champs .....14-02

BAGGISH pince emporte-pièce pour le col de l'utérus .....70-45

BAILEY-BABY Rapprocheur pour les côtes .....FG-18

BAILEY-GIBBON Rapprocheur pour les côtesFG-18

BAILEY Rapprocheur pour les côtes .....FG-18

Baillon MAUNDER bois .....48-06

BAINBRIDGE  
pince atraumatique .....BD-09  
pince hémostatique .....12-14

BAKES dilateur pour les voies biliaires .....62-06

BALFOUR Baby écarteur abdominal .....18-22

BALFOUR  
écarteur abdominal .....18-22  
valve .....18-22

BALL AND SOCKET pince à champs .....14-04

BALLENGER  
couteau mobile .....46-11  
élevateur pour la cloison nasale .....46-12  
pince à préhension amygdalienne .....50-04

BANGERTER spatule cyclodialyse .....42-08

BARANY assourdisseur .....44-04

BARBARA  
aiguille .....44-14  
crochet .....44-14  
pick .....44-14 jusque 44-15

BARKAN couteau à goniotomie .....42-05

BARNHILL couteau .....46-19

BARRAQ.KATZIN pince à iris .....42-13

BARRAQU Colibri pince à iris .....42-13

BARRAQUER  
ciseaux colibri .....09-04

BARRAQUER Colibri blépharostat .....42-02

BARRAQUER  
couteau pour la kératoplastie .....42-05  
pince chambre antérieure .....43-02  
pince à épiler .....43-08  
pince à fixation .....43-03  
porte-aiguille .....24-07

BARRETT pince pour abaissement du col de l'utérus .....70-32

BARR spéculum rectal .....68-02

BARTON  
forceps obstétrique .....72-04  
tracteur pour manches ordinaires .....72-04

Bassin  
de lit .....88-06  
pour placenta .....88-06

BAUMGARTNER porte-aiguille .....24-02

BEACHAM amniotome .....70-39

Becher .....88-10

BECKER cystotome .....42-06

BECKMANN-ADSON écarteur .....18-15

BECKMANN  
couteau .....46-19

BECKMANN-EATON écarteur .....18-16

BECKMANN  
écarteur .....18-16

BECK pince atraumatique vasculaire périph BD-25

BEEBEE ciseaux à fils et à plaques .....08-43

BEER pince à épiler .....43-08

BEESON écarteur pour plâtre .....30-03

BELLUCCI ciseaux auriculaires micro .....44-09

BENGOLEA pince hémostatique .....12-09

BENNETT levier à os .....32-22

BERENS kératome .....42-04

BERGMANN  
ciseaux à bandages .....08-46

BERGMANN FOERSTER pince porte-éponges16-10

BERGMANN  
scie pour plâtre .....30-02

BERKE pince musculaire .....43-02

BERLIND-AUVARD spéculum vaginal .....70-19

BERLINER marteau percuteur .....02-07

BERNHARD pince à champs .....14-05

BERTILLON céphalomètre .....02-08

BEST pince intestinale .....64-06

BETHUNE costotome .....FG-04

BEUSE ciseaux .....08-26

BEYER  
pince coupante nasale .....46-08  
pince gouge .....32-04

BILLEAU anse auriculaire .....44-07

BILL tracteur pour manches ordinaires .....72-05

BIRCHER-GANSKE davier porte-os .....32-10

BIRCHER ménisotome .....32-24

BISHOP-HARMAN pince à iris .....42-14

Bistouri  
CARPENTER à amygdales .....50-02  
CONVERSE nasal .....46-10  
électrode .....JA-03  
FREER à muqueuses .....46-10  
HALLE à duremère .....EA-06  
JOSEPH mousse .....46-10  
JOSEPH nasal .....46-10  
MALTZ à cartilage coude .....46-11

Bistouris à dissection .....06-15

Bistouris PARKER à dissection .....06-15

Bistouri stérile à usage unique06-10 jusque 06-11

BLAKE  
curette utérine .....70-48  
pince pour calculs biliaires .....62-03

Blépharostat  
ARRUGA .....42-02



BARRAQUER Colibri .....	42-02	pince pour abaissement du col de l'utérus70-31, 70-34 .....	70-16	Casse-lames	
BOWMAN .....	42-02	spéculum vaginal .....	70-16	CASTROVIEJO .....	06-14
CASTROVIEJO .....	42-03	BRAUN-STADLER ciseaux pour l'épisiotomie07-22, 08-34 .....	07-22, 08-34	DIMEDA .....	06-14
CLARK .....	42-02	BREISKY spéculum vaginal .....	70-20	TROUTMAN-CHRIS .....	06-14
CRITCHETT .....	42-02	Broche KIRSCHNER .....	33-09	CASTANEDA	
GOLDSTEIN .....	42-03	BROCK		écarteur pour les côtes .....	FG-14
GRAEFE .....	42-02	dilatateur coupant pour valve mitrale .....	FG-26	pince atraumatique p. nouveaux-nés et enfants BD-42 .....	
LANCASTER .....	42-03	manche dilatateur pour valve mitrale .....	FG-26	CASTROVIEJO	
LISTER-BURCH .....	42-02	ouverture dilatateur pour valve mitrale .....	FG-26	blépharostat .....	42-03
MELLINGER .....	42-02	Brosse à lavement .....	28-04 jusqu'à 28-05	casse-lames .....	06-14
MELLINGER-AXENFELD .....	42-02	BROWN pince à dissection .....	10-03	ciseaux à iridectomie .....	09-05
MUELLER .....	42-03	BRUENINGS		ciseaux cornéens .....	09-06
MURDOCK .....	42-02	abaisse-langue .....	48-02	dilatateur pour canal lacrymal .....	42-10
PARK .....	42-03	couteau pour la cloison nasale .....	46-11	kératome .....	42-04
SMITH .....	42-02	pince coupante nasale .....	46-05	marqueur compass .....	42-09
STEVENSON .....	42-03	pince laryngienne .....	52-03	pince capsulaire .....	43-04
WEEK .....	42-02	rallonge courbée .....	52-03	pince à fixation .....	43-03
WILLIAMS .....	42-02	serre-noeud .....	50-04	pince à suture .....	43-05
ZIEGLER .....	42-03	spéculum auriculaire .....	44-02	porte-aiguille .....	24-07
BLOHMKE pince à préhension amygdalienne50-04 .....		BRUNETTI burin à spinal .....	32-17	spatule à cyclodialyse .....	42-08 jusqu'à 42-09
BLOUNT		BRUNNER		trépan cornéen .....	43-07
écarteur à genou .....	32-24	costotome .....	FG-07	CATLIN couteaux à amputation .....	06-16
levier à os .....	32-24	pince intestinale .....	64-06	Cautére WADSWORTH-TODD .....	42-08
BLUMENTHAL pince gouge .....	32-02	sonde conductrice .....	26-04	Céphalomètre BERTILLON .....	02-08
BODENHAMMER spéculum rectal .....	68-02	BRUNS		CHAPUT pince hémostatique .....	12-08
BOEHLER étrier à extension .....	33-10	ciseaux à plâtre .....	08-48	CHARRIERE	
BOERMA forceps obstétrique .....	72-04	curette .....	32-12 jusqu'à 32-13	lame .....	33-03
BOETTCHER ciseaux à amygdales .....	08-27	BRYANT pince porte-éponges .....	16-11	scie à amputation .....	33-03
BOHLER		BUCHWALD abaisse-langue .....	48-02	CHEATLE pince à stérilisation .....	28-02
pince coupante à os .....	32-06	BUCK		CHERON pince à pansements .....	16-12
pince gouge .....	32-04	ciseaux à ligatures .....	08-40	CHEVALIER-JACKSON pince laryngienne .....	52-04
Boite		curette auriculaire .....	44-05	CHEVALLIER écarteur pour les côtes .....	FG-15
acier inoxydable .....	88-03	levier pour corps étrangers .....	44-08	CHILDE pince pour agrafes .....	26-07
PETRI .....	88-08	marteau perceur .....	02-07	CINELLI ciseau-burin pour plastique nasale .....	46-13
pour aiguille .....	88-02	BUIE tube d'aspiration .....	68-05	Cisaille SCHUMACHER pour le sternum .....	FG-07
SAUERBRUCH pour aiguille .....	88-02	BUMM		Ciseau-burin .....	32-14
verre .....	88-03	curette utérine .....	70-49 jusqu'à 70-50	ALEXANDER .....	32-14
BONACCOLTO pince à strabisme .....	42-14	pince hystérolabe .....	70-38	CINELLI pour plastique nasale .....	46-13
Bonn		BUNGE curette pour exentération .....	42-07	COTLE pour plastique nasale .....	46-13
Canule à irrigation .....	43-07	BUNNELL		FOMON pour plastique nasale .....	46-13
BONNEY pince porte-éponges .....	16-08	écorcheur à tendons .....	32-25	FREER pour la cloison nasale .....	46-12
Bonn		perforateur à main .....	33-05	HIBBS .....	32-16
pince à iris .....	42-15	BUNT épingle de sécurité .....	28-02	HOKE .....	32-16
Bonn TITAN pince à iris .....	42-15	BURCH fourchette à fixation .....	42-05	LEXER .....	32-16
BORCHARDT fraise .....	33-07	Burin à spinal BRUNETTI .....	32-17	LEXER mini .....	32-16
BOSE écarteur trachéal .....	54-02	Burin pour crâne VIRCHOW .....	32-17	PARTSCH .....	32-14
BOUCHERON spéculum auriculaire .....	44-02	BURKE-Baby pince emporte-pièce pour le col de l'utérus .....	70-44	SILVER pour plastique nasale .....	46-14
Bougie		BURKE pince emporte-pièce pour le col de l'utérus 70-44 .....	70-44	SMITH-PETERSEN .....	32-15
COXETER urétrale .....	66-17	BUSCH ciseaux pour le cordon ombilical .....	08-34	STILLE .....	32-14
DITTEL urétrale .....	66-18 jusqu'à 66-19	C		WEST nasal .....	46-14
FILIFORM conductrice .....	66-12	Cadre KIRSCHNER .....	18-23	Ciseaux	
GUYON urétrale .....	66-12, 66-14 jusqu'à 66-15	Canule		DIX pour corps étrangers .....	42-06
VAN BUREN urétrale .....	66-13	Bonn à irrigation .....	43-07	ROLLET à extirpation .....	42-06
WALTHER urétrale .....	66-17	Hamburg .....	43-07	Ciseaux sternaux LEBSCHE .....	32-17
BOWLES stéthoscope .....	02-06	JACKSON trachéale .....	54-03	Ciseaux 07-02 jusqu'à 07-04, 08-02 jusqu'à 08-04 .....	08-04
BOWMAN		LUER trachéale .....	54-03	Ciseaux à dissection .....	08-19
aiguille à discision .....	42-05	SCHIEE oculaire .....	43-07	Ciseaux	
blépharostat .....	42-02	Canules FINSTERER d'aspiration et d'irrigation04-05 .....	04-05	AEBLI cornéens .....	08-22
couteau à discision .....	42-04	Canule		Ciseaux pour l'entérotomie .....	08-39
stylet pour canal lacrymal .....	42-10	SIMCOE suture .....	43-07	Ciseaux	
BOYNTON porte-aiguille pour l'ophtalmologie24-06 .....		Tübingen air .....	43-07	à envies .....	74-03
BOZEMANN-DOUGLAS pince à pansements16-13 .....		WÄGENER-MOSHER trachéale .....	54-03	Ciseaux à gencives .....	08-41
BOZEMANN		Capsula DASTOOR aspirateur .....	42-09	Ciseaux	
pince à pansements .....	16-13	CARMALT pince à échardes .....	10-06	à ongles .....	74-03
porte-aiguille .....	24-03	CARPENTER bistouri à amygdales .....	50-02	Ciseaux à plâtre .....	08-49
BRAIN		CASPAR		Ciseaux	
clip standard .....	EA-13	écarteur .....	18-20	auriculaires micro .....	44-11
clip temporaire .....	EA-12	écarteur pour colonne cervicale .....	18-18	auriculaires micro mini .....	44-11
BRAIN MINI pince pour poser les clips .....	EA-12	écarteur pour colonne vertébrale .....	18-19	BARRAQUER colibri .....	09-04
BRAIN STANDARD pince pour poser les clipsEA-12 .....		écarteur pour lombaire vertébrale .....	18-20	BEEBEE à fils et à plaques .....	08-43
BRAITHWAITE dermatome .....	06-22	manche de bistouris, micro .....	06-12	BELLUCCI auriculaires micro .....	44-09
BRAUN		valve .....	18-20	BERGMANN à bandages .....	08-46
cranioclaste .....	72-09	valve pour colonne vertébrale .....	18-19	BEUSE .....	08-26
crochet pour décapitation .....	72-09			BOETTCHER à amygdales .....	08-27
dépresseur utérin .....	70-39			BRAUN-STADLER pour l'épisiotomie07-22, 08-34 .....	08-34

Ciseaux-burin DIX.....	42-09	Ciseaux pour strabisme.....	07-17, 08-24	écarteur abdominal.....	18-24 jusque 18-25
Ciseaux		Ciseaux préparation.....	08-34	COLLIN-HARTMANN écarteur.....	18-03
BUSCH pour le cordon ombilical.....	08-34	Ciseaux		COLLIN	
CASTROVIEJO à iridectomie.....	09-05	PRINCE à amygdales.....	08-27	hystéromètre.....	70-39
CASTROVIEJO cornéens.....	09-06	QUINBY à gencives.....	08-42	maillet.....	32-18
Ciseaux		REYNOLDS.....	07-15, 08-18	manche de bistouris.....	06-08
ciseaux micro.....	09-06	SANVENERO.....	07-13, 08-16	pince à pansements.....	16-11
Ciseaux		SATINSKY thoraciques.....	08-37	pince pincelabre.....	70-37
Ciseaux micro.....	09-06	SCHMIEDEN-TAYLOR.....	08-36	pince pour agrafes.....	26-07
COTTLE nasaux.....	07-18, 08-25	SCHUMACHER pour cordon ombilical.....	08-34	pince hémostatique.....	12-08
CRAFOORD pulmonaires.....	08-36	SEUTIN pour plâtre.....	30-02	pince tire-langue.....	48-03
CROIX ROUGE à bandages.....	08-47	SHEA auriculaire micro.....	44-09	COLLIN-POZZI pince pour abaissement du col de l'utérus.....	70-32
DANDY neurochirurgicaux.....	08-36	SHORTBENT à ligatures.....	08-40	COLLIN	
DEAN à amygdales.....	08-26	SIEBOLD gynécologiques.....	07-21, 08-32	spéculum vaginal.....	70-04
DEAVER.....	07-05, 08-06	SIMS gynécologiques.....	07-21, 08-32	COLLYER compas pelvimètre.....	72-06
DE BAKEY vasculaires.....	08-30	SMITH US ARMY à bandages.....	08-44	COLVER pince à préhension amygdalienne.....	50-03
DIETHRICH vasculaires.....	08-29	SPENCER à ligatures.....	08-40	Compas pelvimètre	
DIMEDA à bandages.....	08-46	STELZNER pour le rectum.....	08-38	COLLIN.....	72-06
DOYEN gynécologiques.....	08-33	STEVENS pour la ténotomie.....	07-17, 08-23	COLLYER.....	72-06
DUBOIS gynécologiques.....	08-33	STILLE pour plâtre.....	30-02	MARTIN.....	72-06
ESMARCH à bandages.....	08-46	STRULLY neurochirurgicaux.....	08-35	Compresseur	
FERGUSSON.....	08-49	THOREK pulmonaires.....	08-36	CORWIN à amygdales.....	50-04
FINOCHIETTO à rectum.....	08-38	TOENNIS-ADSON neurochirurgicaux.....	08-35	STOCKMANN de l'urètre.....	66-10
Ciseaux fins.....	08-05, 08-19, 08-24	TROUTMAN-CASTROVIEJO micro.....	09-07	STRAUSS de l'urètre.....	66-10
Ciseaux		UNIVERSAL à bandages.....	08-50	Comprimètre.....	33-02
FOMON nasaux.....	07-18, 08-25	UNIVERSAL à fils et plaques.....	08-42	Cône KNUTSON-KOCH pour urétrographie.....	66-09
GOLDMAN-FOX à gencives.....	08-41	USA MODEL pour le cordon ombilical.....	08-34	Cône occluseur.....	70-47
GOOD à amygdales.....	08-27	VANNAS à iridectomie.....	09-05	CONNIN-AMSLER marqueur.....	42-09
GORNEY à dissection.....	08-13	VANNAS micro.....	09-12 jusque 09-13	Containers pour la stérilisation	
HEATH à ligatures.....	08-40	Ciseaux vasculaires.....	08-27	3/4.....	88-22 jusque 88-24
HEYMANN nasaux.....	07-18, 08-25	Ciseaux vasculaires iris micro.....	09-09	grands.....	88-18 jusque 88-20
Ciseaux incisions.....	08-05	Ciseaux vasculaires paramétrium.....	07-20, 08-31	petits.....	88-32 jusque 88-33
Ciseaux		Ciseaux		plats semi.....	88-30 jusque 88-31
IRIS.....	07-16, 08-19, 08-21	WAGNER.....	07-22	semi.....	88-26 jusque 88-29
IRIS ophtalmologiques.....	08-22	WAGNER à gencives.....	08-42	spéciaux.....	88-34 jusque 88-37
JACOBSON micro.....	09-11	WALDMANN pour l'épisiotomie.....	08-34	CONVERSE bistouri nasal.....	46-10
JOSEPH.....	07-14, 08-16	WECKER à iris.....	09-04	COOLEY	
KELLY gynécologiques.....	07-22, 08-33	WERTHEIM préparation.....	08-32	clamps bulldog atrauma.....	BD-33 jusque BD-34
KILNER.....	07-14, 08-17	WESTCOTT à iridectomie.....	09-02	costotome première.....	FG-05
KLINKENBERGH-LOTH thoraciques.....	08-37	WESTCOTT à tendons.....	09-02	COOLEY DERRA pince atraumatique p.....	
KNAPP.....	08-20	WULLSTEIN auriculaires micro.....	44-11	anastomose.....	BD-39
KNOWLES à bandages.....	08-47	WULLSTEIN auriculaires micro mini.....	44-11	COOLEY	
LAGRANGE à gencives.....	08-41	YASARGIL micro.....	09-10 jusque 09-11	dilatateur pour valve mitrale.....	FG-27 jusque FG-29
LANDOLT à énucléation.....	08-25	CITELLI pince coupante nasale.....	46-08	dilatateur vasculaire.....	FG-30
LANGE à bandages.....	08-44	Clamp		écarteur atrium.....	FG-20
LEXER.....	07-09	COLLIN pour cordon ombilical.....	72-06	écarteur pour les côtes.....	FG-09
LEXER à dissection.....	08-11	KANE pour cordon ombilical.....	72-06	COOLEY modif. STRUCK écarteur atrium.....	FG-20
LEXER-BABY.....	07-10	Clamps		COOLEY	
LEXER-BABY à dissection.....	08-12	COOLEY bulldog atrauma.....	BD-33 jusque BD-34	pince atraumatique 11-03, BD-35 jusque BD-37, BD-39, BD-41	
LEXER-FINO à dissection.....	08-12	DE BAKEY bulldog atrauma.....	12-02	pince atraumatique pour l'anastomose.....	BD-37, BD-40
LISTER à bandages.....	07-23, 08-45	DIEFFENBACH bulldog serre-fine.....	12-03	pince atraumatique iliaque.....	BD-37
LITTAUER à ligatures.....	08-40	GLOVER bulldog atrauma.....	12-02	pince atraumatique pédiatrique.....	BD-38 jusque BD-39
LITTLER à dissection.....	08-13	JOHNS-HOPKINS bulldog serre-fine.....	12-03	pince vasculaire.....	BD-40
LOCKLIN.....	08-18	CLARK blépharostat.....	42-02	COOPER aiguille à ligatures.....	26-02
LORENZ à bandages.....	08-47	CLAR		CORDES pince laryngienne.....	52-03
MAYO.....	07-06, 08-07	lampe frontale.....	02-05	Cordon	
MAYO main gauche.....	08-07	mini.....	02-05	AESCULAP électrobistouris.....	JA-07
MAYO-NOBLE.....	07-08, 08-10	Clé à écrous.....	33-10	ERBE SELECT électrobistouris.....	JA-07
MAYO-STILLE.....	07-07, 08-08 jusque 08-09	CLEVELAND pince gouge.....	32-02	MARTIN électrobistouris.....	JA-07
McGUIRE cornéens.....	09-05	Clip		USA électrobistouris.....	JA-07
McINDOE à cartilage.....	08-35	BRAIN standard.....	EA-13	Corte-agraves.....	EA-02
McPHERSON WESTCOTT ténotomie.....	09-04	BRAIN temporaire.....	EA-12	CORWIN compresseur à amygdales.....	50-04
METZENBAUM.....	07-11	EDWARDS.....	BD-21	CORYLLOS costotome.....	FG-04
METZENBAUM à dissection.....	08-13 jusque 08-14	Clou STEINMANN à os.....	33-09	CORYLLOS (Thorax) écarteur.....	18-13
METZENBAUM FINO.....	07-12	CLOWARD		Costotome.....	FG-02
METZENBAUM FINO à dissection.....	08-15	écarteur.....	18-17	BETHUNE.....	FG-04
METZENBAUM "S".....	07-13, 08-16	écarteur pour corps vertébraux.....	EA-07	BRUNNER.....	FG-07
Ciseaux micro.....	09-13	COAKLEY		COOLEY première.....	FG-05
Ciseaux micro gynécologiques.....	09-07 jusque 09-08	curette pour sinus.....	46-18	CORYLLOS.....	FG-04
Ciseaux		trocart.....	22-02	GIERTZ-STILLE.....	FG-06
MILLS vasculaires.....	08-27	COLCLOUGH pince emporte-pièce pour lames intervertébrales.....	EA-11	GLUCK.....	FG-03
Ciseaux neurochirurgicaux.....	08-35	COLLIER porte-aiguille.....	24-02	SAUERBRUCH.....	FG-05
Ciseaux		COLLIN		SAUERBRUCH-FREY.....	FG-06
NORTHBENT à ligatures.....	08-40	clamp pour cordon ombilical.....	72-06	STILLE.....	FG-03
NOYES à iris.....	09-03 jusque 09-04	compas pelvimètre.....	72-06		
NOYES à tendons.....	09-03	COLLIN-DUVAL pince à dissection.....	10-04		
POTTS DE MARTEL vasculaires.....	08-27	COLLIN			
POTTS-SMITH vasculaires.....	07-19, 08-28	clamp pour cordon ombilical.....	72-06		
		dynamomètre.....	02-03		

COTTLE		CRILE TITAN pince hémostatique.....	12-05	VOLKMANN.....	32-12 jusque 32-13
ciseaux-burin pour plastique nasale.....	46-13	CRILE-WOOD porte-aiguille.....	24-02	WALLICH placentaire et pour post-abortum72-08	
ciseaux nasaux.....	07-18, 08-25	CRITCHETT blépharostat.....	42-02	WILLIGER.....	32-13
couteau nasal.....	46-10	Crochet.....	44-15	CUSCO spéculum vaginal.....	70-04 jusque 70-06
écarteur nasal.....	46-17	à extension.....	33-10	CUSHING	
élevateur pour la cloison nasale.....	46-12	à extraction.....	33-13	écarteur.....	18-07
COTTLE-KAZANJIAN pince coupante à os.....	32-06	ARRUGA à extraction.....	42-06	écarteur à nerfs.....	EA-04
COTTLE-NEIVERT écarteur nasal.....	46-17	BARBARA.....	44-14	perforateur plat.....	33-04
COTTLE		BRAUN pour décapitation.....	72-09	pince à dissection.....	10-03
spéculum nasal.....	46-03	DAY auriculaire.....	44-07	pince emporte-pièce pour laminectomie.EA-08	
Coupante BROCK dilateur pour valve mitraleFG-26		électrode mini.....	JA-02	spatule cérébrale.....	EA-07
Coupe-bague.....	33-03	EMMET pour fistules.....	70-46	Cuvette ronde.....	88-04 jusque 88-05
DIMEDA.....	33-03	FRAZIER.....	18-06	CUZZI curette placentaire et pour post-abortum72-08	
Coupe-cors CREDO.....	74-03	GILLIES.....	46-17	CZERNY	
Couteau à cartilage.....	06-18	GRAEFE.....	18-06	pince pour abaissement du col de l'utérus70-34	
Couteau		GRAEFE à strabisme.....	42-06	pince pour calculs biliaires.....	62-03
BALLENGER mobile.....	46-11	GRAEFE-TITAN à strabisme.....	42-06	spéculum rectal.....	68-02
BARKAN à goniotomie.....	42-05	GREEN musculaire.....	42-06	D	
BARNHILL.....	46-19	GUTHRIE.....	18-06	DALE pince atraumatique vasculaire périph.BD-24	
BARRAQUER pour la kératoplastie.....	42-05	JAMESON à strabisme.....	42-06	DANDY	
BECKMANN.....	46-19	JOSEPH.....	18-06	ciseaux neurochirurgicaux.....	08-36
BOWMAN à discission.....	42-04	KILNER à peau.....	74-02	écarteur à nerfs.....	EA-04
BRUENINGS pour la cloison nasale.....	46-11	O'CONNOR à iris.....	42-06	pince hémostatique.....	12-07
COTTLE nasal.....	46-10	SMELLIE pour les accouchements.....	72-06	DARDIK pince atraumatique.....	BD-07
DEAN à iridectomie.....	42-04	STEVENS.....	42-06	DARLING écarteur.....	18-17
DEUTSCHMANN à cataracte.....	42-03	WAGENER auriculaire.....	44-07	DARTIGUES pince hystérolabe.....	70-37
ELSCHNIG cornéen.....	42-05	WIENER à iris.....	42-06	DASTOOR	
ESMARCH pour plâtre.....	30-04	CROIX ROUGE ciseaux à bandages.....	08-47	Aspirateur capsulaire.....	42-09
FREER pour la cloison nasale.....	46-10	CRUTCHFIELD		pince à strabisme.....	42-14
GILL cornéen.....	42-05	alésior.....	EA-03	DAVIDSON (Scapula) écarteur.....	18-13
GRAEFE à cataracte.....	42-03	traction crânienne.....	EA-03	DAVIEL curette à cataracte.....	42-07
HOPKINS pour plâtre.....	30-04	Cuiller GUTMANN à sécrétion.....	66-11	Davier	
KNAPP à iridectomie.....	42-04	CULLER spatule à iris.....	42-08	BIRCHER-GANSKE porte-os.....	32-10
LANGENBECK à résection.....	06-17	Curette		DINGMANN porte-os.....	32-10
MUCK à périoste.....	44-15	ALVIS pour corps étrangers.....	42-06	FARABEUF-LAMBOTTE porte-os.....	32-08
OTIS de rechange.....	66-08	AXENFELD à chalazion.....	42-07	FARABEUF porte-os.....	32-07
PAUFIQUE pour la kératoplastie.....	42-05	BLAKE utérine.....	70-48	FERGUSON porte-os.....	32-07
PLESTER lobaire.....	44-14	BRUNS.....	32-12 jusque 32-13	KERN porte-os.....	32-08
POLITZER auriculaire.....	44-06	BUCK auriculaire.....	44-05	LAMBOTTE porte-os.....	32-08
Couteau pour plâtre.....	30-04	BUMM utérine.....	70-49 jusque 70-50	LANE porte-os.....	32-08
Couteau		BUNGE pour exentération.....	42-07	LANGENBECK porte-os.....	32-07
REINER pour plâtre.....	30-04	COAKLEY pour sinus.....	46-18	LEWIN porte-os.....	32-10
ROSEN circulaire.....	44-14	CUZZI placentaire et pour post-abortum	72-08	LOWMAN à os.....	32-11
SATO cornéen.....	42-05	d'aspiration.....	70-51	Davier porte-os.....	32-09 jusque 32-10
SCHEIE à goniotomie.....	42-05	DAVIEL à cataracte.....	42-07	Davier	
SCHUKNECHT circulaire.....	44-14	DESJARDINS pour calculs biliaires.....	62-08	SEMB porte-os.....	32-07
SCHUKNECHT serpette.....	44-14	FAULKNER.....	46-18	VERBRUGGE porte-os.....	32-09
SEXTON auriculaire.....	44-06	FERGUSON pour calculs biliaires.....	62-07	DAVIS	
St. CLAIR-THOMSON.....	46-19	FOX pour lupus.....	74-02	aiguille pour corps étrangers.....	42-05
TABB serpette.....	44-14	GOURDET utérine.....	70-48	DAVIS-BOYLE ouvre-bouche.....	48-04
TOOK cornéen.....	42-05	GRAEFE à cataracte.....	42-07	DAVIS	
VIRCHOW à cartilages.....	06-18	GROSS auriculaire.....	44-06	dissecteur duremètre.....	EA-05
VIRCHOW pour le cerveau.....	06-18	HALLE.....	32-13	pince à stérilisation.....	28-02
WHEELER à discission.....	42-04	HEBRA à chalazion.....	42-07	DAY crochet auriculaire.....	44-07
WULLSTEIN serpette.....	44-14	HOUSE.....	44-15	DEAN	
Couteaux à amputation.....	06-16	KEVORKIAN aspirante pour biopsie de l'utérus70-40		ciseaux à amygdales.....	08-26
Couteaux		KNAPP à cataracte.....	42-07	couteau à iridectomie.....	42-04
CATLIN à amputation.....	06-16	LANG.....	42-08	DEAVER	
LISTON à amputation.....	06-16	LEMPERT.....	32-13	ciseaux.....	07-05, 08-06
Couteau		LUER-KOERTE pour calculs biliaires.....	62-09	écarteur.....	18-05
ZIEGLER à capsulotomie.....	42-05	MARTINI.....	32-13	DEAVER Grip écarteur.....	18-05
ZIEGLER à iridectomie.....	42-04	MAYO pour calculs biliaires.....	62-07	DEBAKEY BAHNSON pince atraumatique pour aneurisme d'aorte.....	BD-14
COXETER bougie urétrale.....	66-17	MEYHOEFFER à chalazion.....	42-07	DE BAKEY	
Crachoir.....	88-06	MOORE pour calculs biliaires.....	62-05	ciseaux vasculaires.....	08-30
CRAFOORD		NOVAK aspirante pour biopsie de l'utérus70-40		clamps bulldog atrauma.....	12-02
ciseaux pulmonaires.....	08-36	PESTALOZZA placentaire et pour post-abortum	72-08	dilatateur vasculaire.....	FG-31
pince hémostatique pour les bronches.....	12-12	PIFFARD pour lupus.....	74-02	DE BAKEY MORRIS pince atraumatique.....	BD-16
Cranioclaste		RANDALL aspirante pour biopsie de l'utérus70-40		DE BAKEY	
BRAUN.....	72-09	RECAIMER utérine.....	70-49 jusque 70-50	pince atraumatique.....	11-03
TARNIER.....	72-09	SCHEDI.....	32-12	DEBAKEY pince atraumatiqueBD-02, BD-08, BD-12	
CREDO coupe-cors.....	74-03	SCHROEDER utérine.....	70-48	DE BAKEY	
CRILE		SIMON.....	32-13	pince atraumatique.....	BD-16 jusque BD-17
écarteur.....	18-02	SIMON utérine.....	70-48	DEBAKEY pince atraumatique.....	BD-20
CRILE-MURRAY porte-aiguille.....	24-02	SIMS utérine.....	70-49 jusque 70-50		
CRILE		SPRATT.....	32-12		
pince hémostatique.....	12-05				
porte-aiguille.....	24-04				
CRILE-RANKIN pince hémostatique.....	12-05				

DE BAKEY		SMITH-BUIE pour anus et rectum.....	68-03	CASTAÑEDA pour les côtes.....	FG-14
pince atraumatique.....	BD-28 jusque BD-30	TROUSSEAU trachéal.....	54-02	CHEVALLIER pour les côtes.....	FG-15
pince atraumatique à dissection et à ligature	BD-25, BD-32	TUBBS pour valve mitrale.....	FG-27	CLOWARD.....	18-17
pince atraumatique pour anastomose.....	BD-25	WILDER pour canal lacrymal.....	42-10	CLOWARD pour corps vertébraux.....	EA-07
pince atraumatique p. aneurisme d'aorte	BD-13, BD-15, BD-18	WYLIE pour col de l'utérus.....	70-30	COLLIN-HARTMANN.....	18-03
pince atraumatique pour les bronches.....	BD-19	ZIEGLER pour canal lacrymal.....	42-10	COOLEY atrium.....	FG-20
pince atraumatique iliaque.....	BD-11			COOLEY pour les côtes.....	FG-09
pince atraumatique vasculaire périph.....	BD-06			COOLEY modif. STRUCK pour l'atrium..	FG-20
porte-aiguille.....	24-03			CORYLLOS (Thorax).....	18-13
DE BAKEY REYNOLDS pince atraumatique pour				COTTLE nasal.....	46-17
anastomose.....	BD-30			COTTLE-NEIVERT nasal.....	46-17
DEBAKEY SATINSKY pince atraumatique.....	BD-22			CRILE.....	18-02
DE BAKEY				CUSHING.....	18-07
tube d'aspiration.....	04-04			CUSHING à nerfs.....	EA-04
Décolleur				DANDY à nerfs.....	EA-04
FISCH.....	44-15			DARLING.....	18-17
HURD à amygdales.....	50-02			DAVIDSON (Scapula).....	18-13
DEJERINE marteau percuteur.....	02-07			DEAVER.....	18-05
De LEE forceps obstétrique.....	72-02			DEAVER Grip.....	18-05
De MARTEL guide-scie.....	EA-05			DESMARRES.....	18-07
DeMARTEL-WOLFSON pince à anastomose.....	64-07			DIMEDA.....	18-14
DENHART ouvre-bouche.....	48-03			DOYEN.....	18-12
Dépresseur BRAUN utérin.....	70-39			FARABEUF.....	18-02
Dépresseur				FINOCHIETTO-BABY pour les côtes.....	FG-09
REICHERT pour l'épiglottis.....	52-02			FINOCHIETTO BURFORD p. les côtes	FG-12
SIMS utérin.....	70-39			jusque FG-14	
DERF porte-aiguille.....	24-02			FINOCHIETTO p. les côtes	FG-08, FG-10
Dermatome				jusque FG-11	
BRAITHWAITE.....	06-22			FINOCHIETTO-HAIGHT BABY p. les côtes	FG-10
HUMBY.....	06-20			FINOCHIETTO INFANT pour les côtes..	FG-12
SCHINK.....	06-21			FINOCHIETTO (modif) pour les côtes...	FG-08
SILVER.....	06-20			FINSEN.....	18-14
WATSON.....	06-22			FOMON nasal.....	46-17
DERRA pince atraumatique p. anastomose et				FRAZIER.....	18-21
pédiatrie BD-28				FRIEDMAN à périnéorrhapie.....	70-23
DESCHAMPS aiguille à ligatures.....	26-02			FRITSCH.....	18-11
DESJARDINS				GERSTER pour daviers.....	32-11
curette pour calculs biliaires.....	62-08			GOELET.....	18-03
pince pour calculs biliaires.....	62-02			GRAHAM à nerfs.....	EA-04
pince pour voies biliaires.....	12-15			GREEN.....	18-10
sonde pour calculs biliaires.....	62-05			HABERER.....	18-04
DESMARRES				HAGLUND-STILLE pour plâtre.....	30-03
écarteur.....	18-07			HAIGHT pour les côtes.....	FG-15
pince à chalazion.....	43-06			HARRINGTON.....	18-05
DEUTSCHMANN couteau à cataracte.....	42-03			HEANEY.....	18-12
DeVILBISS pince crânienne.....	EA-05			HENNIG pour plâtre.....	30-03
DEWEY forceps obstétrique avec dispositif de				HERMANN pour plâtre.....	30-03
traction.....	72-05			HERTZLER pour les côtes.....	FG-17
DIAMANT pince coupe-fil.....	33-12			HOFER piliaire.....	50-02
Diapason.....	44-04			HRYNITSCHAK pour saisir la prostate...	66-06
DIMEDA Alu.....	44-03			INGE pour corps vertébraux.....	EA-07
HARTMANN.....	44-03			ISRAEL.....	18-11
LUCAE.....	44-04			ITERSON trachéal.....	54-02
RYDEL-SEIFFER.....	44-04			JACKSON trachéal.....	54-02
DIFFENBACH clamps bulldog serre-fine.....	12-03			JANSEN.....	18-14
DIETER pince pour la tête du marteau.....	44-10			JUDD-MASSON vésical.....	66-04
DIETHRICH				KELLY.....	18-04, 18-12
ciseaux vasculaires.....	08-29			KELLY Grip.....	18-04
pince atraumatique.....	BD-31			KNAPP.....	42-06
porte-aiguille vasculaire.....	24-06			KOCHER.....	18-10 jusque 18-11
Dilatateur				KOERTE.....	18-11
ALAN-PARKS pour anus et rectum.....	68-03			LAHEY.....	18-08
BAKES pour les voies biliaires.....	62-06			LANGENBECK.....	18-09
CASTROVIEJO pour le canal lacrymal.....	42-10			LEGUEU vésical.....	66-06
COOLEY pour valve mitrale	FG-27 jusque FG-29			lèvres et joues.....	48-03
COOLEY vasculaire.....	FG-30			LITTLE.....	18-08
DE BAKEY vasculaire.....	FG-31			LOVE à nerfs.....	EA-04
GERBODE pour valve mitrale.....	FG-28			LOVE ovulaire.....	50-02
GOODELL pour col de l'utérus.....	70-30			MATHIEU.....	18-03
HANK pour col de l'utérus.....	70-28			MERCEDES thoracique.....	FG-16
HEGAR pour col de l'utérus	70-24 jusque 70-27			MEYERDING.....	18-08
HETZER pour valve mitrale.....	FG-29			MIDDELDORPF.....	18-10
LABORDE trachéal.....	54-02			MIKULICZ.....	18-12
PRATT pour col de l'utérus.....	70-29			MILLIN pour le col de la vessie.....	66-07
SIMS pour col de l'utérus.....	70-30			MILLIN vésical.....	66-05
				MOLLISON.....	18-17
				MORSE-FAVOLORO pour les côtes.....	FG-17
				écarteur Musculaire.....	18-25



écarteur		ROGER pour la cloison nasale .....46-11	FINSTERER canules d'aspiration et d'irrigation04-05
NAGER pour le palais.....50-02		WATSON-CHEYNE .....32-22	FISCH décolleur .....44-15
OLLIER .....18-10		ELLIOT	FISCHER pince à iris.....42-13
PARKER .....18-02		forceps obstétrique .....72-02	FLETCHER JAVERTS pince porte-éponges .....16-10
PITHA pour les lèvres et joues.....48-06		trépan cornéen .....43-08	FLEURANT trocart.....22-02
PLESTER .....18-14		ELLIS gouge pour corps étrangers.....42-06	FOERSTER
écarteur Pour plâtre .....30-03		ELSAESSER pince à néphrostomie .....62-13	pince à iris.....42-12
écarteur		ELSCHNIG	pince porte-éponges.....16-06 jusqu'à 16-08
PRATT cystique .....68-04		couteau cornéen .....42-05	FOMON
QUATTRO pour plâtre .....30-03		pince capsulaire .....43-04	ciseaux-burin pour plastique nasale.....46-13
REVERDIN .....18-04		pince fixation .....43-03	ciseaux nasaux .....07-18, 08-25
RIBBON .....18-04		spatule cyclodialyse .....42-08	écarteur nasal .....46-17
RICHARDSON .....18-04		EMMET crochet pour fistules .....70-46	rape nasale .....46-15 jusqu'à 46-16
RICHARDSON-EASTMAN .....18-04		ENGEL scie pour plâtre.....30-02	Forceps
RICHARDSON Grip .....18-04		Enlève-lame .....06-06, 06-10	BARTON obstétrique .....72-04
ROLLET .....42-06		Entonnoir.....88-07	BOERMA obstétrique .....72-04
ROSE trachéal .....54-03		Épingle	De LEE obstétrique .....72-02
ROUX .....18-02		BUNT de sécurité .....28-02	DEWEY obstétrique avec dispositif de traction
ROUX Baby.....18-02		MAYO de sécurité.....28-02	72-05
ROUX mini .....18-02		EPPENDORFER-KEVORKIAN pince emporte-pièce	ELLIOT obstétrique.....72-02
SACHS à nerfs .....EA-04		pour le col de l'utérus .....70-46	KIELLAND-LUIKART obstétrique.....72-03
SAUERBRUCH .....18-13		EPPENDORFER pince emporte-pièce pour le col de	KIELLAND obstétrique .....72-02
écarteur		l'utérus .....70-45 jusqu'à 70-46	LUIKART obstétrique .....72-03
BALFOUR abdominal.....18-22		EPPENDORFER TISCHLER-MORGAN pince	McLEAN-LUIKART obstétrique .....72-03
BALFOUR Baby abdominal .....18-22		emporte-pièce pour le col de l'utérus .....70-46	McLEAN obstétrique.....72-04
écarteur		ERBE SELECT cordon électrobistouris .....JA-07	McLEAN-TUCKER-LUIKART obstétrique .....72-03
SCHOENBORN pour la thyroïde .....54-04		ESMARCH	NAEGELE obstétrique .....72-03
écarteur		ciseaux à bandages .....08-46	PIPER obstétrique .....72-04
COLLIN abdominal .....18-24 jusqu'à 18-25		couteau pour plâtre.....30-04	PIPER obstétrique avec dispositif de traction
écarteur		Etrier	04
SENN.....18-04		à extension .....33-10	SIMPSON-BRAUN obstétrique .....72-02
SENN-GREEN .....18-07		BOEHLER à extension .....33-10	SIMPSON-LUIKART obstétrique .....72-03
écarteur		KIRSCHNER à extension .....33-10	SIMPSON obstétrique.....72-02
GELPI abdominal .....18-24		EYES serre-noeud .....50-04	TARNIER obstétrique avec dispositif de traction
GOSSET abdominal .....18-21		Evideur SEGOND pour fibromes.....70-46	72-05
écarteur		Extractor KUENTSCHER .....33-13	WRIGLEY obstétrique .....72-02
SIMON.....18-12		F	FORD BOWLES stéthoscope .....02-06
écarteur		FARABEUF	FORD stéthoscope .....02-06
KIRSCHNER abdominal .....18-23		davier porte-os .....32-07	Fourchette BURCH à fixation .....42-05
écarteur		écarteur .....18-02	FOX curette lupus .....74-02
SMITHWICK à nerfs.....EA-04		FARABEUF-LAMBOTTE davier porte-os .....32-08	FRAENKEL
écarteur		FARABEUF	pince à polypes laryngiens .....52-02
O'SULLIVAN-O'CONNOR abdominal...18-21		rugine raspatoire .....32-19	pince laryngienne .....52-03
RIGBY abdominal .....18-24		FARREL stylet.....20-03	Fraise.....33-07
écarteur		FAULKNER curette .....46-18	ALBEE .....33-07
STERNBERG pour lèvres et joues .....48-02		FAURE	BORCHARDT .....33-07
TAYLOR spinal .....32-24		pince emporte-pièce pour le col de l'utérus70-41	conique .....33-04
THOMSON-WALKER vésical .....66-06		pince à péritoine .....12-17	Fraise conique HUDSON .....33-04
TUFFIER pour les côtes.....FG-16		FEHLAND pince intestinale .....64-06	Fraise
US Army (PARKER-LANGENBECK) .....18-03		FEILCHENFELD pince à échardes .....10-06	DOYEN .....33-07
VOLKMANN .....18-07 jusqu'à 18-08		FERGUSSON	pour corticalis.....33-15
WEITLANER .....18-14		ciseaux .....08-49	TOTI .....33-07
WEITLANER-WULLSTEIN .....18-14		curette pour calculs biliaires .....62-07	FRANCESCHETTI trépan cornéen .....43-07
YOUNG pour la prostate.....66-02		davier porte-os .....32-07	FRANCIS aiguille pour corps étrangers.....42-05
E		pince hémostatique .....12-07	FRANKLIN-SILVERMANN aiguille à ponction22-03
ECHLIN pince gouge .....32-05		FERRIS pince à dissection .....10-04	FRAZIER
Ecorcheur BUNNELL à tendons .....32-25		FERRIS-SMITH-KERRISON pince emporte-pièce	crochet .....18-06
EDWARDS		pour lames intervertébrales.....EA-10	écarteur .....18-21
clip .....BD-21		FERRIS-SMITH pince emporte-pièce à laminectomie	tube d'aspiration.....04-06
pince à poser clips.....BD-21		EA-09	FREER
Électrode mini pour la coagulationJA-02 jusqu'à JA-03		FILLIFORM bougie conductrice .....66-12	bistouri à muqueuses .....46-10
Élévateur		Fil pour cerclage .....33-11	ciseaux-burin pour cloison nasale .....46-12
ADSON.....32-21		FINOCHIETTO-BABY écarteur pour les côtesFG-09	couteau pour la cloison nasale .....46-10
BALLENGER pour la cloison nasale .....46-12		FINOCHIETTO BURFORD écarteur pour les côtes	élévateur pour la cloison nasale .....46-11
COTTLE pour la cloison nasale .....46-12		....FG-12 jusqu'à FG-14	gouge nasale .....46-14
FREER pour la cloison nasale.....46-11		FINOCHIETTO	FREEWAY-GRAVE spéculum vaginal .....70-06
HAJEK-BALLENGER pour la cloison nasale46-12		ciseaux pour le rectum.....08-38	FRENZEL abaisse-langue .....48-02
HENKE à amygdales.....50-02		écarteur pour les côtesFG-08, FG-10 jusqu'à	FRIEDMAN
JOSEPH pour la cloison nasale.....46-12		FG-11	écarteur pour la perinéorrhapie.....70-23
KEY .....32-21		FINOCHIETTO-HAIGHT BABY écarteur p. les côtes	pince gouge .....32-02
KILLIAN pour la cloison nasale .....46-12		FG-10	pince gouge, mini .....32-02
LANGENBECK .....32-21		FINOCHIETTO INFANT écarteur p. les côtesFG-12	FRITSCH écarteur .....18-11
LEMPERT .....44-15		FINOCHIETTO (modif) écarteur p. les côtes FG-08	FRYKHOLM pince gouge.....32-05
McDONALD .....32-22		FINOCHIETTO	FUCHS pince capsulaire .....43-04
McKENTY pour la cloison nasale.....46-11		pince pour les bronches .....FG-21	G
MURPHYLANE .....32-22		porte-aiguille .....24-04	GALLAHER rape pour le sinus.....46-16
		FINSEN écarteur .....18-14	GAUSS pince péri-crânienne.....72-06

GELLHORN pince emporte-pièce pour le col de l'utérus	70-42
GELPI écarteur abdominal	18-24
GEMINI MINI pince à dissection et à ligature	12-10
GEMINI pince à dissection et à ligature	12-10
GERALD pince à dissection	10-05
GERBODE dilateur valve mitrale	FG-28
GERSTER écarteur pour daviers	32-11
GERZOG maillet	32-18
GIERTZ-STILLE costotome	FG-06
GIGLI manche pour scie	EA-05
GILL-ARRUGA pince capsulaire	43-03
GILL	
couteau cornéen	42-05
GILL-HESS pince à iris	42-12
GILLIES	
crochet	46-17
pince à dissection	10-05
porte-aiguille	24-05
GILL	
pince à iris	42-12
GLOVER	
clamps bulldog atrauma	12-02
pince atraumatique	BD-06, BD-30
pince atraumatique à coarctation	BD-04
pince atraumatique pour l'anastomose	BD-05
GLUCK costotome	FG-03
GOELET écarteur	18-03
GOLDMAN-FOX ciseaux à gencives	08-41
GOLDSTEIN blépharostat	42-03
Goniomètre MOELTGEN	02-08
GOOD ciseaux à amygdales	08-27
GOODELL dilateur du col de l'utérus	70-30
GORNEY ciseaux à dissection	08-13
GOSSET écarteur abdominal	18-21
Gouge	
ALEXANDER	32-14
ELLIS pour corps étrangers	42-06
FREER nasale	46-14
HAJEK nasale	46-14
HIBBS	32-16
KILLIAN-CLAUS nasale	46-14
LEXER	32-16
LEXER mini	32-16
PARTSCH	32-14
SMITH-PETERSEN	32-15
STILLE	32-14
WALTON pour corps étrangers	42-06
WEST nasale	46-14
GOURDET curette utérine	70-48
GRADLE pince à épiler	43-08
GRAEFE	
blépharostat	42-02
couteau à cataracte	42-03
crochet	18-06
crochet à strabisme	42-06
curette à cataracte	42-07
kistitome	42-06
pince à dissection	10-03
pince à iris	42-11
pince fixation	43-03
scarificateur	42-04
GRAEFE-TITAN crochet à strabisme	42-06
GRAHAM écarteur à nerfs	EA-04
GRAVE spéculum vaginal	70-02
GRAY pince pour voies biliaires	12-15
GREEN-ARMYTAGE pince-clamp utérine pour hémostase	72-06
GREEN	
crochet musculaire	42-06
dissecteur cornéen	42-06
écarteur	18-10
pince fixation	43-03
GREGORY pince atraumatique pour profunda	BD-33
GREVEN pince auriculaire micro	44-10
GRIP pince à saisir	33-11

GROSS	
curette auriculaire	44-06
GROSS-MAIER pince à pansements	16-02 jusqu'à 16-04
GROSS	
pince à pansements	16-05
GRUBER spéculum auriculaire	44-02
Guide-scie De MARTEL	EA-05
GUTHRIE crochet	18-06
GUTMANN cuillère à sécrétion	66-11
GUYON	
bougie urétrale	66-12, 66-14 jusqu'à 66-15
introduit de sondes	66-11
pince à pédicule rénal	12-16
GUYTON-LUNDGAARD sclérotome	42-05
H	
HABERER écarteur	18-04
HAGLUND-STILLE écarteur pour plâtre	30-03
HAIGHT écarteur pour les côtes	FG-15
HAJEK-BALLENGER élévateur pour la cloison nasale	46-12
HAJEK-CLAUS pince coupante nasale	46-08
HAJEK gouge nasale	46-14
HAJEK-KOFLER pince coupante nasale	46-08
HALLE	
bistouri à duremère	EA-06
curette	32-13
HALSEY porte-aiguille	24-02
HALSTEAD-MOSQUITO micro pince hémostatique	12-04
HALSTEAD-MOSQUITO	
pince atraumatique	BD-02
pince hémostatique	12-04
HALSTEAD-MOSQUITO TITAN pince hémostatique	12-04
Hamburg canule	43-07
HANK dilateur pour col de l'utérus	70-28
Haricot	88-07
HARKEN pince atraumatique auriculaire	BD-23
HARRINGTON	
écarteur	18-05
pince pour les bronches	FG-21
HARTMANN	
abaisse-langue	48-02
diapason	44-03
HARTMANN-HALLE spéculum nasal	46-02
HARTMANN-HOFFMANN pince auriculaire	44-08
HARTMANN	
pince auriculaire	44-08
pince coupante nasale	46-07
pince nasale à polypes	46-04
pince hémostatique	12-03
sonde auriculaire	44-06
spéculum auriculaire	44-02
HARTMANN-WULLSTEIN pince auriculaire	44-08
HEANEY	
écarteur	18-12
pince à hystérectomie	12-18
porte-aiguille	24-03
HEATH ciseaux à ligatures	08-40
HEBRA curette à chalazion	42-07
HEGAR dilateur pour col de l'utérus	70-24 jusqu'à 70-27
HEGENBARTH pince pour agrafes	26-07
HEIFETZ spatule cérébrale	EA-07
HEIMING pince pour les calculs du bassin	62-13
HEISS pince hémostatique	12-09
HEISTER ouvre-bouche	48-03
Hémostate PASSOW	44-15
HENKE élévateur à amygdales	50-02
HENNIG écarteur pour plâtre	30-03
HENROTIN pince pour abaissement du col de l'utérus	70-34
HERMANN écarteur pour plâtre	30-03
HERRICK pince à péritoine	12-17
HERTZLER écarteur pour les côtes	FG-17
HESS	
pince à saisir	42-12

pince capsulaire	43-04
HETZER dilateur pour valve mitrale	FG-29
HEYMANN	
ciseaux nasaux	07-18, 08-25
HEYMANN-KNIGHT pince nasale à polypes	46-05
HEYMANN	
pince coupante nasale	46-05
HEYWOOD-SMITH pince à hémorroïdes	68-05
HIBBS	
ciseau-burin	32-16
gouge	32-16
ostéome	32-16
HIRSCHMANN anoscope	68-04
HOESEL porte-aiguille	24-05
HOFER écarteur piliaire	50-02
HOFF pince à champs	14-03
HOHMANN levier à os	32-22 jusqu'à 32-23
HOHMANN mini levier à os	32-23
HOKE ciseau-burin	32-16
HOLTH pince pour capsulotomie	42-09
HOPKINS couteau pour plâtre	30-04
HORSLEY dissecteur duremère	EA-06
HOUSE curette	44-15
HRYNTSCHAK écarteur pour saisir la prostate	66-06
HUBER manche universel	52-03
HUDSON	
fraise conique	33-04
perforateur à main	33-04
HUMBY	
dermatome	06-20
lame dermatome de rechange	06-20
HUNTER pince à échardes	10-06
HURD décolleur à amygdales	50-02
Hystéromètre	
COLLIN	70-39
MARTIN	70-39
SIMS	70-39
VALLEIX	70-39
I	
Impactor	33-12
KUENTSCHER	33-13
INGE écarteur vertébral	EA-07
Instrument	
de circoncision	66-09
KNUTSON pour urétrographie	66-09
Instrument	
LAFORCE pour corps étrangers	42-06
Instrument	
MOGAN de circoncision	66-09
WINKELMANN de circoncision	66-09
Insufflateur POLITZER d'air	44-05
Introduit de sondes	
DITTEL	66-11
GUYON	66-11
IOWA pince pour abaissement du col de l'utérus	70-35
IRIS	
ciseaux	07-16, 08-19, 08-21
ciseaux ophtalmologiques	08-22
Irrigateur	88-05
ISRAEL écarteur	18-11
ITARD sonde auriculaire	44-06
ITERTON écarteur trachéal	54-02
IVES-FANSLER anoscope	68-04
J	
JACKSON	
canule trachéale	54-03
écarteur trachéal	54-02
pince porte tampons	52-02
spéculum vaginal	70-16
JACOBSON ciseaux micro	09-11
JACOBS pince pour abaissement du col de l'utérus	70-34
JAEGER	
kératome	42-04
plaque pour paupières	42-03





ciseaux à dissection	08-11
LEXER-FINO ciseaux à dissection	08-12
LEXER	
gouge	32-16
LEXER mini	
ciseau-burin	32-16
gouge	32-16
LEYLA système de fixation	EA-14 jusqu'à EA-18
LICHTWITZ	
aiguille	46-09
trocart	22-02
LIDDLE pince atraumatique pour l'aorte	BD-10
Lien PARHAM	32-11
Lime	
à ongles	74-03
JOSEPH à os	46-14
LISTER-BURCH blépharostat	42-02
LISTER	
ciseaux à bandages	07-23, 08-45
pince porte-éponges, sinus	16-11
LITON	
couteaux à amputation	06-16
pince coupante à os	32-06
LITTAUER	
ciseaux à ligatures	08-40
pince auriculaire	44-08
pince à épiler	43-08
pince nasale à polypes	46-05
LITTLE écarteur	18-08
LITTLER ciseaux à dissection	08-13
LOCKLIN ciseaux	08-18
LORENZ ciseaux à bandages	08-47
LORNA pince à champs	14-04
LOUTE tendeur serre-fil	33-11
LOVE	
écarteur à nerfs	EA-04
écarteur ovulaire	50-02
LOVE-GRUENWALD pince emporte-pièce pour laminectomie	EA-08
LOVELACE	
pince pulmonaire	FG-19
pince hémostatique	12-07
LOWER pince pour voies biliaires	12-14
LOWMAN davier à os	32-11
LUBET-BARBON pince nasale à polypes	46-05
LUCAE	
diapason	44-04
maillet	32-18
pince auriculaire	44-07
LUC pince coupante nasale	46-06
LUER	
canule trachéale	54-03
LUER-KOERTE curette pour calculs biliaires	62-09
LUER	
pince gouge	32-03
LUKART-BILL tracteur pour manches ordinaires	72-05
LUKART forceps obstétrique	72-03
LUNDGAARD sclérotome	42-05
LUNIATSCHEK obturateur à gaze	50-02
LURZ pince urétérale	62-10
M	
MACINTOSH	
laryngoscope set fibres optiques	AE-12 jusqu'à AE-13
laryngoscope set standard	AE-18 jusqu'à AE-19
laryngoscope spatules fibres optiques	AE-10
laryngoscope spatules standard	AE-15
MAGILL	
doigt	04-04
pince pour introduire les sondes	04-06
tube d'aspiration	04-04
MAIER pince à pansements	16-12
Maillets	32-18
COLLIN	32-18
GERZOG	32-18
KIRK	32-18
LUCAE	32-18

MEAD	32-18
QUISLING	32-18
WILLIGER	32-18
Main en plomb	32-11
MALTZ	
bistouri à cartilage coude	46-11
MALTZ (COTTLE) rape nasale	46-15
MALTZ	
rape nasale	46-14
Manche	
BROCK dilateur pour valve mitrale	FG-26
CASPAR de bistouris, micro	06-12
COLLIN de bistouris	06-08
Manche de bistouris	06-02 jusqu'à 06-05, 06-07
jusqu'à 06-08	
Manche de bistouris, micro	06-12
Manche	
GIGLI pour scie	EA-05
HUBER universel	52-03
LANDOLT de bistouris, micro	06-13
miroirs laryngiens	52-04
Manomètre pour salpingographe	70-47
Marqueur	
CASTROVIEJO compass	42-09
CONNIN-AMSLER	42-09
MARSCHIK pince à amygdales	50-04
Marteau à fente	33-13
Marteau	
BABINSKY percuteur	02-07
BERLINER percuteur	02-07
BUCK percuteur	02-07
DEJERINE percuteur	02-07
TAYLOR percuteur	02-07
TRAUBE percuteur	02-07
TROEMNER percuteur	02-07
MARTEL pince pour cuir chevelu	12-08
MARTIN	
compas pelvimètre	72-06
cordon électrobistouris	JA-07
hystéromètre	70-39
MARTINI curette	32-13
MARTIN	
pince à pansements	16-02, 16-14
pince à sequestres	32-10
MASSON porte-aiguille	24-03
MASTIN pince musculaire	54-04
MATHIEU	
écarteur	18-03
pince pour corps étrangers	66-07
porte-aiguille	24-05
spéculum rectal	68-02
MATSON rugine raspatoire	32-21
MAUNDER baillon bois	48-06
MAYO BLAKE pince pour calculs biliaires	62-04
MAYO	
ciseaux	07-06, 08-07
ciseaux pour main gauche	08-07
curette pour calculs biliaires	62-07
épingle de sécurité	28-02
MAYO-GUYON pince pédicule rénal	12-16
MAYO-HEGAR porte-aiguille	24-02
MAYO-NOBLE ciseaux	07-08, 08-10
MAY ophtalmoscope	02-03
MAYO-ROBSON pince intestinale	64-05
MAYO	
sonde pour les calculs du bassin	62-10
MAYO-STILLE ciseaux	07-07, 08-08 jusqu'à 08-09
McCLINTOCK pince placentaire et pour post-abortum	72-07
McCULLOUGH pince à strabisme	42-13
McDONALD élévateur	32-22
McGEE pince auriculaire micro	44-10
McGUIRE ciseaux cornéens	09-05
McINDOE	
ciseaux à cartilage	08-35
pince à dissection	10-04
McIVOR	
abaisse-langue	48-05
ouvre-bouche	48-05

McKENTY élévateur pour la cloison nasale	46-11
McKENZIE	
perforateur plat	33-04
pince pour poser clips	EA-02
McLEAN forceps obstétrique	72-04
McLEAN-LUIKART forceps obstétrique	72-03
McLEAN-TUCKER-LUIKART forceps obstétrique	72-03
McPHERSON pince à ligatures	43-05
McPHERSON TITAN pince à ligatures	43-05
McPHERSON WESTCOTT ciseaux à ténatomie	04-04
MEAD	
maillet	32-18
pince gouge	32-02
Mèche	33-04
MEEKER pince à dissection et à ligature	12-13
MELLINGER-AXENFELD blépharostat	42-02
MELLINGER blépharostat	42-02
MENGHINI trocart	22-03
Ménisotome	
BIRCHER	32-24
NEFF	32-24
SMILLIE	32-24
MERCEDES écarteur thoracique	FG-16
Mesure graduée	88-07
METZENBAUM	
ciseaux	07-11
ciseaux à dissection	08-13 jusqu'à 08-14
METZENBAUM FINO	
ciseaux	07-12
ciseaux à dissection	08-15
METZENBAUM	
porte-aiguille	24-04
METZENBAUM "S" ciseaux	07-13, 08-16
MEYERDING écarteur	18-08
MEYHOEFER curette à chalazion	42-07
MICHEL	
agrafes	26-07
miroir	46-04
pince pour agrafes	26-07
MIDDELDORPF écarteur	18-10
MIDDLETON-JANSEN pince coupante nasale	46-09
MIKULICZ	
écarteur	18-12
pince à péritoine	12-17
MILLER	
laryngoscope set fibres optiques	AE-12 jusqu'à AE-13
laryngoscope set standard	AE-18 jusqu'à AE-19
laryngoscope spatules fibres optiques	AE-10
laryngoscope spatules standard	AE-16
MILLIGAN dissecteur duremère	EA-05
MILLIN	
écarteur pour le col de la vessie	66-07
écarteur vésical	66-05
pince porte-fil	66-03
pince capsulaire	66-03
pince pour saisir lombeaux	66-03
support lumière froide	66-05
MILLS ciseaux vasculaires	08-27
Mini CLAR	02-05
Miroir frontal ZIEGLER	02-05
Miroir	
laryngien	52-04
MICHEL	46-04
MIXTER BABY pince hémostatique p. les bronches	12-13
MIXTER O'SHAUGNESSY pince hémostatique	12-14
MIXTER	
pince pour calculs biliaires	62-04
pinces hémostatique	12-14
pince hémostatique pour les bronches	12-13
pince pour voies biliaires	12-15
MOELTGEN goniomètre	02-08
MOGAN Instrument de circoncision	66-09
MOLLISON écarteur	18-17

Monde mesurer.....	44-15	HEISTER.....	48-03	ADSON gouge.....	32-03
MOORE		JENNINGS.....	48-04	Pince à échardes.....	10-06
curette pour calculs biliaires.....	62-05	KILNER-DOUGHTY.....	48-05	Pince	
perforateur à main.....	33-04	McIVOR.....	48-05	à envies.....	74-03
MOORFIELD pince à suture.....	43-05	ROSER-KOENIG.....	48-03	ALEXANDER emporte-pièce pour le col de	
MORSE-FAVOLORO écarteur pour les côtes FG-17		SEEMANN-SEIFFERT.....	48-04	l'utérus.....	70-42
MOYNIHAN		WHITEHEAD.....	48-04	ALLIS-ADAIR à saisir les tissus.....	64-02
pince à champs.....	14-05	OVERHOLT-GEISSENDOERFER pince à dissection		ALLIS à saisir les tissus.....	64-02
pince pour voies biliaires.....	12-15	et à ligature.....	12-10	ALLIS-Baby à saisir les tissus.....	64-02
sonde pour calculs biliaires.....	62-05	OVERHOLT rugine raspatoire.....	32-21	à ongles.....	74-03
MUCK couteau périoste.....	44-15			ARCHER à échardes.....	10-06
MUELLER blépharostat.....	42-03	P		ARRUGA capsulaire.....	43-04
MURDOCK blépharostat.....	42-02	PARHAM lien.....	32-11	ASCH pour redresser cloison.....	46-18
MURLESS lavier à tête.....	72-05	PARK blépharostat.....	42-03	Pince à sequestres.....	32-10
MURPHY-LANE élévateur.....	32-22	PARKER		Pince à stérilisation.....	28-02
MURPHY pince serre-tubes.....	12-19	bistouri à dissection.....	06-15	Pince	
MUSEUX pince pour abaissement du col de		écarteur.....	18-02	auriculaire micro.....	44-09 jusque 44-10, 44-12
l'utérus.....	70-33	PARTSCH		auriculaire micro mini.....	44-13
MYLES pince coupante nasale.....	46-07	ciseaux-burin.....	32-14	AYER à chalazion.....	43-06
		gouge.....	32-14	BABCOCK pour saisir les tissus.....	64-02
N		PASSOW hémostate.....	44-15	BACKHAUS à champs.....	14-02
NABATOFF sonde auriculaire en argent.....	20-02	PATON dissecteur cornéen.....	42-05	BACKHAUS-CLIP à champs clamp porte-tube	
NAEGELE forceps obstétrique.....	72-03	PAUFIQUE		14-03	
NÄGELE perce crâne.....	72-09	couteau pour la kératoplastie.....	42-05	BACKHAUS KOCHER à champs.....	14-02
NÄGER écarteur pour le palais.....	50-02	pince à ligatures.....	43-05	BAGGISH emporte-pièce pour le col de	
NEFF ménisicotome.....	32-24	PAUFIQUE TITAN pince à ligatures.....	43-05	l'utérus.....	70-45
NEGUS pince à amygdales.....	50-03	PAYR-Baby pince clamp stomacale.....	64-09	BALL AND SOCKET à champs.....	14-04
NEIVERT porte-aiguille.....	24-02	PAYR		BALLENGER à préhension amygdalienne.....	50-04
NELSON		pince clamp stomacale.....	64-09	BARRAQ.KATZIN à iris.....	42-13
aiguille à ligatures.....	26-02	sonde conductrice.....	26-04	BARRAQU Colibri à iris.....	42-13
pince à dissection.....	10-05	PEAN		BARRAQUER chambre antérieure.....	43-02
trocart.....	22-02	pince atraumatique.....	BD-02	BARRAQUER à épiler.....	43-08
NEUBÜSER pince à saisir les trompes.....	70-51	pince hémostatique.....	12-08	BARRAQUER à fixation.....	43-03
NORTHBENT ciseaux à ligatures.....	08-40	pince hémostatique délicate.....	12-06	BARRETT pour abaissement du col de l'utérus	
NOTO pince à polypes utérins.....	70-36	PEDERSON spéculum vaginal.....	70-03	70-32	
NOVAK curette aspirante pour biopsie de l'utérus		PEERS BERTRAM pince à champs.....	14-03	BEER à épiler.....	43-08
70-40		PEET pince à échardes.....	10-06	BERGMANN FOERSTER porte-éponges.....	16-10
NOYES		PELKMANN pince à pansements.....	16-12	BERKE musculaire.....	43-02
ciseaux à iris.....	09-03 jusque 09-04	PENFIELD dissecteur duremère.....	EA-06	BERNHARD à champs.....	14-05
ciseaux à tendons.....	09-03	PENNINGTON pince hémostatique.....	12-07	BEST intestinale.....	64-06
pince nasale à polypes.....	46-05	Perce-crâne		BEYER coupante nasale.....	46-08
NUBOER tube d'aspiration.....	04-05	NÄGELE.....	72-09	BEYER gouge.....	32-04
		SMELLIE.....	72-09	BISHOP-HARMAN à iris.....	42-14
O		PERCY retracteur à amputation.....	33-03	BLAKE pour calculs biliaires.....	62-03
Obturbateur à gaze LUNIATSCHEK.....	50-02	Perforateur		BLOHMKE à préhension amygdalienne.....	50-04
OCHSNER		à main.....	33-05	BLUMENTHAL gouge.....	32-02
pince atraumatique pour l'aorte.....	BD-31	à mandrin Jacobs.....	33-06	BÖHLER coupante à os.....	32-06
trocart.....	22-02	BUNNELL à main.....	33-05	BÖHLER gouge.....	32-04
O'CONNOR crochet à iris.....	42-06	CUSHING plat.....	33-04	BONACCOLTO à strabisme.....	42-14
OLDBERG pince emporte-pièce pour laminectomie		HUDSON à main.....	33-04	Bonn à iris.....	42-15
EA-09		KIRSCHNER à main.....	33-05	BONNEY porte-éponges.....	16-08
OLIVECRONA		McKENZIE plat.....	33-04	Bonn TITAN à iris.....	42-15
pince gouge.....	32-03	MOORE à main.....	33-04	BOZEMANN à pansements.....	16-13
scie.....	EA-05	RALK à main.....	33-05	BOZEMANN-DOUGLAS à pansements.....	16-13
spatule cérébrale.....	EA-07	STILLE à main.....	33-04	BRAIN MINI de pose clip.....	EA-12
OLIVECRONA-TOENNIS pince à poser clipsEA-02		STILLE-SHERMAN à main.....	33-04	BRAIN STANDARD de pose clip.....	EA-12
OLLIER écarteur.....	18-10	PERTHES pointes-carrées.....	33-08	BRAUN pour abaissement du col de l'utérus70-	
OLSEN-HEGAR porte-aiguille.....	24-05	PESTALOZZA curette placentaire et pour post-		31, 70-34	
Ophthalmoscope		abortion.....	72-08	BROWN à dissection.....	10-03
MAY.....	02-03	PETRI boîte.....	88-08	BRUENINGS coupante nasale.....	46-05
VARIFOCAL.....	02-03	PETZ appareil à sutures stomacales et intestinales		BRUENINGS laryngienne.....	52-03
Ostéotome.....	32-14	64-09		BRUNNER intestinale.....	64-06
HIBBS.....	32-16	PHANEUF pince à péritoine.....	12-17	BRYANT porte-éponges.....	16-11
LAMBOTTE.....	32-15	Pick		BUMM hystérolabe.....	70-38
LAMBOTTE mini.....	32-15	BARBARA.....	44-14 jusque 44-15	BURKE emporte-pièce pour le col de l'utérus70-	
STILLE.....	32-14	PIERCE trocart.....	22-02	44	
O'SULLIVAN-O'CONNOR		Pierre ARKANSAS à repasser.....	06-19	BURKE-Baby emporte-pièce pour le col de	
écarteur abdominal.....	18-21	PIFFARD curette à lupus.....	74-02	l'utérus.....	70-44
spéculum vaginal.....	70-08	PINARD stéthoscope.....	02-06	CARMALT à échardes.....	10-06
OTIS		Pince à champs modèle gracille.....	14-02	CASTROVIEJO capsulaire.....	43-04
couteau de rechange.....	66-08	Pince		CASTROVIEJO fixation.....	43-03
uréthrotome.....	66-08	à couper et à plier le fil.....	33-11	CASTROVIEJO suture.....	43-05
Otoscope.....	02-04	Pince à dissection.....	10-02	CHEATLE à stérilisation.....	28-02
Ouverture BROCK dilateur pour valve mitraleFG-		Pince		CHERON à pansements.....	16-12
26		ADLERKREUTZ à dissection.....	10-04	CHEVALIER-JACKSON laryngienne.....	52-04
Ouvre-bouche		ADSON à dissection.....	10-03	CHILDE pour agrafes.....	26-07
DAVIS-BOYLE.....	48-04	ADSON à dissection, micro.....	10-03	CITELLI coupante nasale.....	46-08
DENHART.....	48-03	ADSON à hypophyse.....	EA-06	Pince-clamp GREEN-ARMYTAGE utérine pour	
DOYEN-JANSEN.....	48-03	ADSON-BROWN à dissection.....	10-03	hémostase.....	72-06

Pince	
CLEVELAND gouge	32-02
coagulation bipolaire	JA-04 jusqu'à JA-06
COLCLOUGH emporte-pièce pour lames intervertébrales	EA-11
COLLIN à pansements	16-11
COLLIN-DUVAL à dissection	10-04
COLLIN hystérolabe	70-37
COLLIN pour agrafes	26-07
COLLIN-POZZI pour abaissement du col de l'utérus	70-32
COLLIN tire-langue	48-03
COLVER à préhension amygdalienne	50-03
CORDES laryngienne	52-03
COTTLE-KAZANJIAN coupante à os	32-06
coupe-fil	33-12
CUSHING à dissection	10-03
CUSHING emporte-pièce pour laminectomie EA-08	
CZERNY pour abaissement du col de l'utérus 70-34	
CZERNY pour calculs biliaires	62-03
DARTIGUES hystérolabe	70-37
DASTOOR à strabisme	42-14
DAVIS à stérilisation	28-02
DeMARTEL-WOLFSON pour anastomose	64-07
DESJARDINS pour calculs biliaires	62-02
DESJARDINS pour voies biliaires	12-15
DESMARRES à chalazion	43-06
DeVILBISS crânienne	EA-05
Pince d'horloger	10-06
Pince	
DIAMANT coupe-fil	33-12
DIETER pour la tête du marteau	44-10
DIMEDA pour déchets	28-03
DOUGLAS à épiler	43-08
DOYEN à champs	14-05
DOYEN à polypes utérins	70-36
DOYEN-Baby intestinale	64-03
DOYEN intestinale	64-03
DUPLAY à pansements	16-14
DUPLAY pour abaissement du col de l'utérus 70-31	
DUVAL à dissection	10-04
DUVAL à saisir les tissus	64-03
ECHLIN gouge	32-05
EDWARDS pour poser clips	BD-21
ELSAESSER à néphrostomie	62-13
ELSCHNIG capsulaire	43-04
ELSCHNIG à fixation	43-03
épiler	43-08
EPPENDORFER emporte-pièce pour le col de l'utérus	70-45 jusqu'à 70-46
EPPENDORFER-KEVORKIAN emporte-pièce pour le col de l'utérus	70-46
EPPENDORFER TISCHLER-MORGAN emporte- pièce pour le col de l'utérus	70-46
FAURE emporte-pièce pour le col de l'utérus	70-41
FAURE à péritoine	12-17
FEHLAND intestinale	64-06
FEILCHENFELD à échardes	10-06
FERRIS à dissection	10-04
FERRIS-SMITH emporte-pièce pour laminectomie	EA-09
FERRIS-SMITH-KERRISON emporte-pièce pour lames intervertébrales	EA-10
FINOCHIETTO pour les bronches	FG-21
FISCHER à iris	42-13
FLETCHER JAVERTS porte-éponges	16-10
FOERSTER à iris	42-12
FOERSTER porte-éponges	16-06 jusqu'à 16-08
FRAENKEL à polypes laryngiens	52-02
FRAENKEL laryngienne	52-03
FRIEDMAN gouge	32-02
FRIEDMAN gouge, mini	32-02
FRYKHOLM gouge	32-05
FUCHS capsulaire	43-04
GAUSS péri crânienne	72-06

GELLHORN emporte-pièce pour le col de l'utérus	70-42
GEMINI à dissection et à ligature	12-10
GEMINI MINI à dissection et à ligature	12-10
GERALD à dissection	10-05
GILL à iris	42-12
GILL-ARRUGA capsulaire	43-03
GILL-HESS à iris	42-12
GILLIES à dissection	10-05
GRADLE à épiler	43-08
GRAEFE à dissection	10-03
GRAEFE à iris	42-11
GRAEFE à fixation	43-03
GRAY pour les voies biliaires	12-15
GREEN à fixation	43-03
GREVEN auriculaire micro	44-10
GRIP à saisir	33-11
GROSS à pansements	16-05
GROSS-MAIER à pansements	16-02 jusqu'à 16-04
GUYON pédicule rénal	12-16
HAJEK-CLAUS coupante nasale	46-08
HAJEK-KOFLER coupante nasale	46-08
HARRINGTON pour les bronches	FG-21
HARTMANN auriculaire	44-08
HARTMANN coupante nasale	46-07
HARTMANN-HOFFMANN auriculaire	44-08
HARTMANN à polypes nasaux	46-04
HARTMANN-WULLSTEIN auriculaire	44-08
HEANEY pour l'hystérectomie	12-18
HEGENBARTH pour agrafes	26-07
HEIMING pour les calculs du bassin	62-13
HENROTTIN pour abaissement du col de l'utérus	70-34
HERRICK à péritoine	12-17
HESS à iris	42-12
HESS capsulaire	43-04
HEYMANN coupante nasale	46-05
HEYMANN-KNIGHT à polypes nasaux	46-05
HEYWOOD-SMITH pour hémorroïdes	68-05
HOFF à champs	14-03
HOLTH capsulaire	42-09
HUNTER à échardes	10-06
IOWA pour abaissement du col de l'utérus	70-35
JACKSON porte-tampons	52-02
JACOBS pour abaissement du col de l'utérus 70-34	
JAMESON à strabisme	42-13
JANSEN nasale	46-04
JARCHO pour abaissement du col de l'utérus 70-32	
JATHO nasopharyngienne	46-18
JOHNS-HOPKINS pour voies biliaires	12-14
JONES à champs clamp porte-tube	14-02
JUDD-ALLIS pour saisir les tissus	64-02
JURASZ à polypes laryngiens	52-02
KALT capsulaire	43-04
KELLY à polypes utérins	70-36
KERRISON coupante nasale	46-08
KEVORKIAN emporte-pièce pour le col de l'utérus	70-43, 70-46
KEVORKIAN-Pacific emporte-pièce pour le col de l'utérus	70-44
KIRBY-ARTHUR à iris	42-13
KNAPP-LUER trachome	43-06
KNIGHT coupante nasale	46-05
KOCHER intestinale	64-04
KRAUSE laryngienne	52-03
LAHEY pour saisir le goitre	54-04
LAHEY pour les voies biliaires	12-14
LAMBERT à chalazion	43-06
LANE à champs	14-05
LANE à dissection	10-04
LANE pour saisir les attelles	33-14
LANE pour saisir les vis	33-14
LANE clamp stomacale	64-08

LANGE laryngienne	52-03
LAWRENCE à dissection et à ligature	12-13
LEKSELL STILLE gouge	32-05
LEMPERT gouge	32-03
LERCHE à dissection	10-04
LESTER à fixation	43-03
LEWKOWITZ placentaire et pour post-abortum 72-07	
LISTER porte-éponges, sinus	16-11
LISTON coupante à os	32-06
LITTAUER auriculaire	44-08
LITTAUER à épiler	43-08
LITTAUER à polypes nasaux	46-05
LORNA à champs	14-04
LOVE-GRUENWALD emporte-pièce p. laminectomie	EA-08
LOVELACE pulmonaire	FG-19
LOWER pour les voies biliaires	12-14
LUBET-BARBON à polypes nasaux	46-05
LUCAE auriculaire	44-07
LUC coupante nasale	46-06
LUER gouge	32-03
LURZ uretère	62-10
MAIER à pansements	16-12
MARSHCHIK à amygdales	50-04
MARTEL pour cuir chevelu	12-08
MARTIN à pansements	16-02, 16-14
MARTIN à sequestres	32-10
MASTIN musculaire	54-04
MATHIEU pour corps étrangers	66-07
MAYO BLAKE pour calculs biliaires	62-04
MAYO-GUYON pédicule rénal	12-16
MAYO-ROBSON intestinale	64-05
McCLINTOCK placentaire et pour post- abortum	72-07
McCULLOUGH à strabisme	42-13
McGEE auriculaire micro	44-10
McINDOE à dissection	10-04
McKENZIE à poser clips	EA-02
McPHERSON à ligatures	43-05
McPHERSON TITAN à ligatures	43-05
MEAD gouge	32-02
MEEKER à dissection et à ligature	12-13
MICHEL pour agrafes	26-07
Pince micro	11-02
Pince	
MIDDLETON-JANSEN coupante nasale	46-09
MIKULICZ à péritoine	12-17
MILLIN porte-fil	66-03
MILLIN capsulaire	66-03
MILLIN pour saisir lombeaux	66-03
MIXTER pour calculs biliaires	62-04
MIXTER pour voies biliaires	12-15
MOORFIELD suture	43-05
MOYNIHAN à champs	14-05
MOYNIHAN pour voies biliaires	12-15
MURPHY serre-tubes	12-19
MUSEUX pour abaissement du col de l'utérus 70-33	
MYLES coupante nasale	46-07
NEGUS à amygdales	50-03
NELSON à dissection	10-05
NEUBÜSER pour saisir les trompes	70-51
NOTO à polypes utérins	70-36
NOYES à polypes nasaux	46-05
OLDBERG emporte-pièce pour laminectomie	EA-09
OLIVECRONA gouge	32-03
OLIVECRONA-TOENNIS pour poser clips	EA-02
OVERHOLT-GEISSENDOERFER à dissection et à ligature	12-10
PAUFIQUE à ligatures	43-05
PAUFIQUE TITAN à ligatures	43-05
PAYR-Baby clamp stomacale	64-09
PAYR clamp stomacale	64-09
PEERS BERTRAM à champs	14-03
PEET à échardes	10-06
PELMANN à pansements	16-12

PHANEUF à péritoine.....12-17	COOLEY vasculaire .....BD-40	MAGILL pour introduire les sondes.....04-06
plate.....33-11	CRAFOORD hémostatique pour bronches12-12	Pince
POTTS-SMITH à dissection .....10-02	CRILE hémostatique .....12-05	SMITHWICK à poser clips .....EA-02
pour fixer.....66-10	CRILE-RANKIN hémostatique .....12-05	Pince
pour fixer le cordon .....66-10	CRILE TITAN hémostatique .....12-05	MIXTER BABY hémostatique pour les bronches 12-13
POZZI pour l'abaissement du col de l'utérus70-31	DALE atraumatique vasculaire périph.....BD-24	MIXTER hémostatique .....12-14
PRATT pour l'abaissement du col de l'utérus .....70-34 jusque 70-35	DANDY hémostatique.....12-07	MIXTER hémostatique pour les bronches 12-13
PRESBYTERIAN HOSPITAL serre-tubes.....12-19	DARDIK atraumatique.....BD-07	MIXTER O'SHAUGNESSY hémostatique 12-14
PRICE-THOMAS pour les bronches.....FG-22	DE BAKEY atraumatique .....11-03	Pince
PRINCE musculaire.....43-02	DEBAKEY atraumatique..BD-02, BD-08, BD-12	SNELLEN entropion .....43-06
RADOLF pour extraire les ongles .....33-03	DE BAKEY atraumatique ..BD-16 jusque BD-17	Pinces
RAMPLEY porte-éponges .....16-09	DEBAKEY atraumatique .....BD-20	OCHSNER atraumatique pour l' aorte...BD-31
RANDALL pour les calculs du bassin62-11 jusque 62-12	DE BAKEY atraumatique ..BD-28 jusque BD-30	Pince
RANEY pour poser et enlever.....EA-03	DE BAKEY atraumatique à dissection et à ligature .....BD-25, BD-32	SOMER hystérolabes .....70-37
RICHTER-HEATH pour agrafes.....26-07	DE BAKEY atraumatique pour l'anastomoseBD-25	Pince
ROEDER à champs.....14-03	DE BAKEY atraumatique pour aneurisme d'aorte.....BD-13, BD-15, BD-18	PEAN atraumatique.....BD-02
ROGGE à stérilisation .....28-02	DE BAKEY atraumatique pour les bronchesBD-19	PEAN hémostatique.....12-08
ROSENBERG laryngienne.....52-03	DE BAKEY atraumatique iliaque .....BD-11	PEAN hémostatique délicate .....12-06
ROWE pour la bouche .....48-06	DE BAKEY atraumatique vasculaire périphBD-06	PENNINGTON hémostatique .....12-07
RUBIN pour écraser la cloison.....46-07	DEBAKEY BAHNSON atraumatique pour l'aneurisme d'aorte .....BD-14	POTTS atraumatique.....BD-26 jusque BD-27
RUMEL thoracique.....12-11	DE BAKEY MORRIS atraumatique .....BD-16	POTTS atraumatique à coarctacion .....BD-04
RUSKIN gouge .....32-04	DE BAKEY REYNOLDS atraumatique p. anastomose .....BD-30	POTTS atraumatique pour anastomose ..BD-05
RUSKIN-LISTON coupante à os .....32-06	DEBAKEY SATINSKY atraumatique.....BD-22	PRATT hémostatique .....12-08
RUSSIAN à dissection .....10-04	DERRA atraumatique pour anastomose et pédiatrie BD-28	PROVIDEN24-HOSPITAL hémostatique...12-05
Pince	DIETHRICH atraumatique .....BD-31	Pince
ADSON BABY hémostatique .....12-09	Pince	SPURLING emporte-pièce pour laminectomie EA-08
ADSON hémostatique .....12-09	SEIFFERT laryngienne .....52-03	Pince
Pince	SEMB pour les bronches.....FG-23	RANEY hémostatique pour le cuir cheveluEA-03
SAENGER placentaire et pour post-abortum72-07	SEMB coupante à os.....32-07	RANKIN atraumatique.....BD-02
SAIRGES pour l'abaissement du col de l'utérus 70-32	SEMB gouge .....32-06	ROBERTS hémostatique.....12-11
SAROT pour les bronches.....FG-23	SEMKEN à dissection .....10-05	ROCHESTER-CARMALT hémostatique ....12-07
SATINSKY pour anastomose(veina cava) .....FG-24 jusque FG-25	Pince serre-tubes.....12-19	ROCHESTER-OCHSNER hémostatique ...12-06
Pince atraumatique pédiatrique vasculaire ..BD-43	Pince	ROCHESTER-PEAN hémostatique .....12-06
Pince	FERGUSSON hémostatique .....12-07	SAROT hémostatique pour les bronches.12-12
SAUERBRUCH gouge .....32-05	GLOVER atraumatique .....BD-06, BD-30	SATINSKY atraumatique.....BD-20
SAUERBRUCH pour déchets.....28-03	GLOVER atraumatique à coarctacion ...BD-04	SPENCER-WELLS hémostatique .....12-07
SAWTELL à amygdales .....50-03	GLOVER atraumatique pour anastomoseBD-05	SUBRAMANIAN atraumatique .....BD-31
Pince	GREGORY atraumatique pour profundaBD-33	Pince
BAINBRIDGE atraumatique .....BD-09	HALSTEAD-MOSQUITO atraumatique ..BD-02	STAUDE-MOORE pour l'abaissement du col de l'utérus.....70-31
BAINBRIDGE hémostatique .....12-14	HALSTEAD-MOSQUITO hémostatique ...12-04	STEVENS à iris .....42-11
BECK atraumatique vasculaire périph...BD-25	HALSTEAD-MOSQUITO micro hémostatique12-04	STIEGLITZ à échardes.....10-06
BENGOLEA hémostatique .....12-09	HALSTEAD-MOSQUITO TITAN hémostatique 12-04	STILLE à dissection .....10-02
Pince	HARKEN atraumatique auriculaire .....BD-23	STILLE-HORSLEY coupante à os.....32-07
SCAGLIETTI gouge.....32-05	HARTMANN hémostatique.....12-03	STILLE-LISTON coupante à os .....32-06
Pince	HEISS hémostatique .....12-09	STILLE-LUER gouge.....32-04
CASTANEDA atraumatique pour nouveaux-nés et enfants .....BD-42	Pince	STILLE pédicule rénal .....12-16
CHAPUT hémostatique .....12-08	SIEGLER HELLMANN hystérolabes .....70-38	STILLE-RUSKIN gouge .....32-05
Pince	SIMS-MAIER à pansements.....16-05	St. MARTIN suture.....43-05
SCHEINMANN laryngienne .....52-03	SINGLEY à dissection .....10-05	Pince
SCHNIDT à amygdales .....50-03	Pince	TOENNIS hémostatique .....12-11
SCHOENBURG à saisir les tissus.....64-03	JAVID atraumatique pour carotifs .....BD-32	Pince
SCHROEDER pour abaissement du col de l'utérus .....70-31 jusque 70-32	KELLY hémostatique .....12-05	STONE à fermer .....64-06
SCHUBERT emporte-pièce pour le col de l'utérus .....70-41	KELLY-RANKIN hémostatique.....12-05	STONE-WATT intestinale .....64-06
SCHUMACHER emporte-pièce p. le col de l'utérus .....70-43	KELLY TITAN hémostatique .....12-05	STRUEMPEL auriculaire .....44-08
SCHUMACHER laryngienne.....52-03	Pince	STRUYCKEN coupante nasale .....46-07
SCHWEIGGER capsulaire.....43-04	SKENE pour l'abaissement du col de l'utérus 70-31	Pince
Pince	Pince	TUFFIER hémostatique.....12-08
COLLIN hémostatique.....12-08	KOCHER hémostatique délicate.....12-06	Pince vasculaire flexible.....BD-44 jusque BD-45
COOLEY atraumatique .....11-03, BD-35 jusque BD-37, BD-39, BD-41	LAMBERT KAY atraumatique p. anastomose d'aorte .....BD-10	Pince
COOLEY atraumatique pour anastomoseBD-37, BD-40	LAMBERT KAY atraumatique iliaque .....BD-11	SWEET pour poser clips .....EA-02
COOLEY atraumatique iliaque .....BD-37	LEES atraumatique pour les bronches...BD-03	Pince
COOLEY atraumatique pédiatriqueBD-38 jusque BD-39	LELAND JONES atraumatique vasculaire périph.....BD-08 jusque BD-09	WYLIE atraumatique.....BD-21
COOLEY DERRA atraumatique p. anastomose BD-39	LERICHE hémostatique .....12-09	Pince
	LIDDLE atraumatique pour l'aorte.....BD-10	TEALE pour l'abaissement du col de l'utérus70-33
	LOVELACE hémostatique.....12-07	TERSON capsulaire.....43-04
		THOMS-ALLIS pour saisir les tissus .....64-02
		THOMS-GAYLOR emporte-pièce pour le col de l'utérus .....70-42
		TIEMANN pour l'abaissement du col de l'utérus.....70-32
		TILLEY auriculaire .....44-08
		TISCHLER-KEVORKIAN emporte-pièce pour le col de l'utérus .....70-44 jusque 70-45
		TISCHLER-MORGAN emporte-pièce pour le col



de l'utérus.....	70-43	jusque 70-44, 70-46
TIVNEN à préhension amygdalienne .....	50-04	
TOHOKU à champs .....	14-04	
TOWNSEND emporte-pièce pour le col de l'utérus .....	70-44	
TOWNSEND-KEVORKIAN emporte-pièce pour le col de l'utérus.....	70-44	
TOWNSEND-mini emporte-pièce pour le col de l'utérus .....	70-44	
TOWNSEND-MINI (BABY TISCHLER) emporte-pièce pour le col de l'utérus .....	70-45	
TOWNSEND-TISCHLER emporte-pièce pour le col de l'utérus .....	70-44	
TROELTSCH nasale .....	46-04	
TROUTMAN Colibri à iris .....	42-13	
TROUTMAN rectus.....	43-02	
Tübingen à iris.....	42-15	
Tübingen à ligatures.....	43-05	
Tübingen TITAN à iris.....	42-15	
Tübingen TITAN à ligatures .....	43-05	
TURNBULL pour les ongles .....	74-03	
TURREL emporte-pièce pour biopsie .....	68-05	
TYDING à préhension amygdalienne .....	50-04	
ULRICH porte-éponges .....	16-06	
UNIVERSAL à stérilisation .....	28-02	
USA à dissection .....	10-02	
VAN BUREN à sequestres .....	32-10	
van DOREN emporte-pièce pour le col de l'utérus .....	70-42	
VIRTUS (RALK) à échardes .....	10-06	
WACHENFELDT pour agrafes .....	26-07	
WAGNER emporte-pièce pour laminectomie EA-09 .....	46-18	
WALSHAM pour redresser cloison .....	10-05	
WANGENSTEEN à dissection .....	46-06	
WEIL-BLAKESLEY coupante nasale.....	12-19	
WEISS serre-tubes .....	12-18	
WERTHEIM-CULLEN pour hystérectomie .....	12-18	
WERTHEIM pour hystérectomie.....	50-03	
WHITE à préhension amygdalienne .....	44-07	
WILDE (TROELTSCH) auriculaire .....	12-08	
WILLET-MARTELL pour cuir chevelu .....	64-03	
WILLIAMS pour saisir les tissus .....	72-07	
WINTER placentaire et pour post-abortum .....	70-43	
WITTNER emporte-pièce pour le col de l'utérus .....	30-04	
WOLFF pour rompre plâtre .....	68-05	
YEOMAN emporte-pièce pour biopsie .....	66-02	
YOUNG pour saisir la prostate .....	48-03	
YOUNG tire-langue .....	32-04	
ZAUFAL-JANSEN gouge .....	12-12	
ZENKER à dissection et à ligature.....		
PIPER		
forceps obstétrique .....	72-04	
forceps obstétrique avec dispositif de traction .....	42-03	
Plaque JAEGER à paupières .....	06-21	
Plaque pour tendre la peau .....		
Plateau		
en fil inox .....	88-13	
en tôle perforée .....	88-13	
pour instruments.....	88-08	jusque 88-09
PLESTER		
couteau lobaire .....	44-14	
écarteur .....	18-14	
Poignée laryngoscope, fibres optiques.....	AE-11	
Poignée laryngoscope, standard .....	AE-17	
Pointes carrées.....	33-08	
PERTHES .....	33-08	
POLITZER		
aiguille paracentèse .....	44-06	
couteau auriculaire .....	44-06	
insufflateur d'air.....	44-05	
POOLE tube d'aspiration.....	04-02	
Porte-aiguille		
ADSON.....	24-04	
ARRUGA pour l'ophtalmologie .....	24-06	
BARRAQUER .....	24-07	

BAUMGARTNER .....	24-02	
BOYNTON pour l'ophtalmologie.....	24-06	
BOZEMANN .....	24-03	
CASTROVIEJO .....	24-07	
COLLIER .....	24-02	
CRILE .....	24-04	
CRILE-MURRAY .....	24-02	
CRILE-WOOD .....	24-02	
DE BAKEY .....	24-03	
DERF .....	24-02	
DIETHRICH vasculaire.....	24-06	
FINOCHIETTO .....	24-04	
GILLIES .....	24-05	
HALSEY .....	24-02	
HEANEY .....	24-03	
HOESEL .....	24-05	
JAMISON .....	24-03	
JOHNSON .....	24-04	
KALT .....	24-07	
KALT-ARRUGA .....	24-07	
MASSON .....	24-03	
MATHIEU .....	24-05	
MAYO-HEGAR.....	24-02	
METZENBAUM.....	24-04	
NEIVERT .....	24-02	
OLSEN-HEGAR .....	24-05	
RYDER .....	24-03	
SAROT .....	24-04	
STEVENS pour ophtalmologie .....	24-06	
STRATTE .....	24-04	
TOENNIS .....	24-04	
WANGENSTEEN.....	24-03	
POTTS DE MARTEL ciseaux vasculaires .....	08-27	
POTTS		
pince atraumatique .....	BD-26	jusque BD-27
pince atraumatique à coarctacion.....	BD-04	
pince atraumatique pour anastomose .....	BD-05	
POTTS-SMITH		
ciseaux vasculaires.....	07-19, 08-28	
pince à dissection .....	10-02	
POZZI pince pour abaissement du col de l'utérus .....	70-31	
PRATT		
dilatateur pour col de l'utérus .....	70-29	
écarteur cystique.....	68-04	
pince pour abaissement du col de l'utérus .....	70-34	jusque 70-35
pince hémostatique .....	12-08	
spéculum rectal .....	68-02	
PRESBYTERIAN HOSPITAL pince serre-tubes .....	12-19	
PRICE-THOMAS pince pour bronches.....	FG-22	
PRINCE		
ciseaux à amygdales.....	08-27	
pince musculaire.....	43-02	
Proctoscope KELLY .....	68-04	
Protecteur		
ARRUGA.....	42-08	
de tissu p.vis cann .....	33-15	
PROVIDEN24-HOSPITAL pince hémostatique .....	12-05	
PUTTI rape à os .....	32-25	
Q		
QUATTRO écarteur pour plâtre .....	30-03	
QUINBY ciseaux à gencives.....	08-42	
QUINKE aiguille à ponction .....	22-03	
QUIRE levier pour corps étrangers .....	44-08	
QUISLING maillet.....	32-18	
R		
RADOLF pince pour extraire les ongles .....	33-03	
RALK perforateur à main .....	33-05	
Rallonge BRUENINGS courbe.....	52-03	
RAMPLEY pince porte-éponges.....	16-09	
RANDALL		
curette aspirante pour biopsie de l'utérus .....	70-40	
pince pour les calculs du bassin .....	62-11	jusque 62-12
RANEY		
pince pour poser et enlever.....	EA-03	

pince hémostatique pour le cuir chevelu .....	EA-03	
RANKIN pince atraumatique .....	BD-02	
Rape		
à os .....	32-25	
FOMON nasale.....	46-15	jusque 46-16
GALLAHER pour le sinus .....	46-16	
JOSEPH (LEWIS) nasale .....	46-15	
MALTZ (COTTLE) nasale.....	46-15	
MALTZ nasale.....	46-14	
PUTTI à os.....	32-25	
WIENER (AUFRICHT) nasale .....	46-15	
WIENER nasale .....	46-15	
Rapprocheur		
BAILEY-BABY pour les côtes.....	FG-18	
BAILEY pour les côtes .....	FG-18	
BAILEY-GIBBON pour les côtes .....	FG-18	
SELLORS pour les côtes .....	FG-18	
Rasoir .....	06-14, 06-19	
RECAIMER curette utérine.....	70-49	jusque 70-50
Récepteur cylindrique.....	88-08	
Rectoscope lumière froide .....	68-03	
Règle en métal .....	02-08	
REICHERT dépresseur pour épiglottis .....	52-02	
REINER		
couteau pour plâtre.....	30-04	
seringue auriculaire.....	44-05	
Rétracteur PERCY à amputation .....	33-03	
REVERDIN		
aiguille à ligatures .....	26-03	
écarteur .....	18-04	
REYNOLDS ciseaux .....	07-15, 08-18	
Rachiotome .....	32-17	
RIBBON écarteur.....	18-04	
RICHARDSON-EASTMAN écarteur.....	18-04	
RICHARDSON écarteur.....	18-04	
RICHARDSON Grip écarteur .....	18-04	
RICHTER-HEATH pince pour agrafes .....	26-07	
RIGBY écarteur abdominal .....	18-24	
ROBB dissecteur vasculaire .....	FG-33	
ROBERTS pince hémostatique .....	12-11	
ROCHESTER-CARMALT pince hémostatique .....	12-07	
ROCHESTER-OCHSNER pince hémostatique .....	12-06	
ROCHESTER-PEAN pince hémostatique.....	12-06	
ROEDER pince à champs .....	14-03	
ROGER élévateur pour la cloison nasale.....	46-11	
ROGGE pince à stérilisation.....	28-02	
ROLLET		
ciseaux à extirpation .....	42-06	
écarteur .....	42-06	
ROSE écarteur trachéal.....	54-03	
ROSEN		
aiguille .....	44-14	jusque 44-15
ROSENBERG pince laryngienne .....	52-03	
ROSEN		
couteau circulaire .....	44-14	
ROSER-KOENIG ouvre-bouche.....	48-03	
ROUX Baby écarteur .....	18-02	
ROUX écarteur.....	18-02	
ROUX mini écarteur.....	18-02	
ROWE pince pour la bouche.....	48-06	
Ruban métrique.....	02-08	
RUBIN pince pour écraser la cloison .....	46-07	
Rugine		
ALEXANDER raspatoire .....	32-19	
DOYEN raspatoire pour les côtes .....	32-20	
FARABEUF raspatoire .....	32-19	
KUHNT cornéen .....	42-05	
LAMBOTTE raspatoire .....	32-19	
LANGENBECK raspatoire.....	32-19	
MATSON raspatoire .....	32-21	
OVERHOLT raspatoire .....	32-21	
SADILLOT raspatoire .....	32-19	
SEMB raspatoire .....	32-20	
WILLIGER raspatoire.....	32-19	
RUMEL pince thoracique .....	12-11	
RUSKIN-LISTON pince coupante à os .....	32-06	
RUSKIN pince gouge.....	32-04	
RUSSIAN pince à dissection .....	10-04	
RYDEL-SEIFFER diapason .....	44-04	

RYDER porte-aiguille .....	24-03	GUYTON-LUNDSGAARD .....	42-05	pince pour poser clips .....	EA-02
S		LUNDSGAARD .....	42-05	SNELLEN	
SAALFELD tire comédons .....	74-02	Seaux pour déchets .....	88-11	anse .....	42-08
SACHS		SEEMANN-SEIFFERT ouvre-bouche .....	48-04	pince entropion .....	43-06
dissecteur duremère .....	EA-05	SEGOND évideur pour fibromes .....	70-46	SOMER pince hystérolabe .....	70-37
écarteur à nerfs .....	EA-04	SEIFFERT pince laryngienne .....	52-03	Sonde .....	20-02
SADILLOT rugine raspatoire .....	32-19	SELLHEIM levier pour abaisser la tête .....	72-09	BRUNNER conductrice .....	26-04
SAENGER pince placentaire et pour post-abortum 72-07		SELLORS Rapprocheur des côtes .....	FG-18	DESJARDINS pour calculs biliaires .....	62-05
SAIRGES pince pour l'abaissement du col de l'utérus .....	70-32	SENB		DOYEN .....	20-02
Salpingographe SCHULTZE .....	70-47	davier porte-os .....	32-07	HARTMANN auriculaire .....	44-06
SANVENERO ciseaux .....	07-13, 08-16	pince pour bronches .....	FG-23	ITARD auriculaire .....	44-06
SAROT		pince coupante à os .....	32-07	KILLIAN .....	46-09
pince pour les bronches .....	FG-23	pince gouge .....	32-06	KIRSCHNER conductrice .....	26-04
pince hémostatique pour les bronches .....	12-12	rugine raspatoire .....	32-20	KOENIG conductrice .....	26-04
porte-aiguille .....	24-04	SEMKEN pince à dissection .....	10-05	MAYO pour les calculs du bassinet .....	62-10
SATINSKY		SEMM spéculum vaginal .....	70-07	métallique pour femmes .....	66-16
ciseaux thoraciques .....	08-37	SENN écarteur .....	18-04	métallique pour hommes .....	66-16
pince pour l'anastomose (veina cava)FG-24 jusque FG-25		SENN-GREEN écarteur .....	18-07	MOYNIHAN pour calculs biliaires .....	62-05
pince atraumatique .....	BD-20	Seringue		NABATOFF auriculaire en argent .....	20-02
SATO couteau cornéen .....	42-05	à amygdales .....	50-05	PAYR conductrice .....	26-04
SAUERBRUCH		REINER auriculaire .....	44-05	SCHMIEDEN conductrice .....	26-04
boîte pour aiguille .....	88-02	Serre-noeud		SCHMIEDEN-PAYR conductrice .....	26-04
costotome .....	FG-05	BRUENINGS .....	50-04	STACKE auriculaire en argent .....	20-02
écarteur .....	18-13	EVES .....	50-04	Spatule .....	20-03
SAUERBRUCH-FREY costotome .....	FG-06	Serre-noeud		ALLISON pulmonaire .....	FG-19
SAUERBRUCH		KRAUSE auriculaire .....	44-07	BANGERTER cyclodialyse .....	42-08
pince gouge .....	32-05	Serre-noeud		CASTROVIEJO cyclodialyse 42-08 jusque 42- 09	
pince pour déchets .....	28-03	KRAUSE nasal .....	46-09	CULLER à iris .....	42-08
SAWTELL pince à amygdales .....	50-03	TYDING .....	50-05	ELSCHNIG cyclodialyse .....	42-08
SCAGLIETTI pince gouge .....	32-05	Serre-noeud		KOCHER à goitre .....	54-04
Scarificateur GRAEFE .....	42-04	WESTON à polypes rectaux .....	68-05	KOCHER vésicale .....	66-04
SCHAMBERG tire comédons .....	74-02	WILDE auriculaire .....	44-07	LEGUEU vésicale .....	66-04
SCHAEDE curette .....	32-12	Serre-noeud		pour la tunique interne .....	FG-32
SCHAEI		WILDE nasal .....	46-09	Spatule	
canule oculaire .....	43-07	Set à autopsie .....	32-17	CUSHING cérébrale .....	EA-07
couteau à goniotomie .....	42-05	SEUTIN ciseaux pour plâtre .....	30-02	HEIFETZ cérébrale .....	EA-07
SCHHEINMANN pince laryngienne .....	52-03	SEXTON couteau auriculaire .....	44-06	OLIVECRONA cérébrale .....	EA-07
SCHERBAK spéculum vaginal .....	70-21	SHEA ciseaux auriculaires micro .....	44-09	Spatule	
SCHIMMELBUSCH tambours à stérilisation .....	88-12	SHORTBENT ciseaux à ligatures .....	08-40	WECKER à iris .....	42-08
SCHINK dermatome .....	06-21	SIEBOLD ciseaux gynécologiques .....	07-21, 08-32	WELLS à énucléation .....	42-08
SCHIOETZ tonomètre tonomet.echell.obli. ....	43-08	SIEGLER HELLMANN pince hystérolabe .....	70-38	WHEELER cyclodialyse .....	42-09
SCHMIEDEN-PAYR sonde conductrice .....	26-04	SIEGLE spéculum auriculaire .....	44-02	Spéculum	
SCHMIEDEN sonde conductrice .....	26-04	SILVER		AUVARD vaginal .....	70-19
SCHMIEDEN-TAYLOR ciseaux .....	08-36	ciseau-burin pour la plastique nasale .....	46-14	Spéculum	
SCHNIDT pince à amygdales .....	50-03	dermatome .....	06-20	BARR rectal .....	68-02
SCHOENBORN écarteur pour la thyroïde .....	54-04	SIMCOE canule à suture .....	43-07	Spéculum	
SCHOENBURG pince pour saisir les tissus .....	64-03	SIMON		BERLIND-AUWARD vaginal .....	70-19
SCHROEDER		curette .....	32-13	Spéculum	
curette utérine .....	70-48	curette utérine .....	70-48	BODENHAMMER rectal .....	68-02
pince pour abaissement du col de l'utérus 70- 31 jusque 70-32		écarteur .....	18-12	BOUCHERON auriculaire .....	44-02
SCHUBERT pince emporte-pièce pour le col de l'utérus .....	70-41	SIMPSON-BRAUN forceps obstétrique .....	72-02	Spéculum	
SCHUKNECHT		SIMPSON forceps obstétrique .....	72-02	BRAUN vaginal .....	70-16
couteau circulaire .....	44-14	SIMPSON-LUIKART forceps obstétrique .....	72-03	BREISKY vaginal .....	70-20
couteau serpette .....	44-14	SIMS		Spéculum	
SCHULTZE salpingographe .....	70-47	ciseaux gynécologiques .....	07-21, 08-32	BRUENINGS auriculaire .....	44-02
SCHUMACHER		curette utérine .....	70-49 jusque 70-50	Spéculum	
cisaille à sternum .....	FG-07	dépresseur utérin .....	70-39	COLLIN vaginal .....	70-04
ciseaux pour cordon ombilical .....	08-34	dilatateur pour le col de l'utérus .....	70-30	Spéculum	
pince emporte-pièce pour le col de l'utérus 70- 43		hystéromètre .....	70-39	COTTLE nasal .....	46-03
pince laryngienne .....	52-03	SIMS-MAIER pince à pansements .....	16-05	Spéculum	
SCHWEIGGER pince capsulaire .....	43-04	SIMS		CUSCO vaginal .....	70-04 jusque 70-06
Scie		spéculum rectal .....	68-02	Spéculum	
BERGMANN pour plâtre .....	30-02	spéculum vaginal .....	70-17	CZERNY rectal .....	68-02
CHARRIERE à amputation .....	33-03	SINGLEY pince à dissection .....	10-05	Spéculum	
ENGEL pour plâtre .....	30-02	SKENE pince pour l'abaissement du col de l'utérus 70-31		DOYEN vaginal .....	70-18, 70-20
JOSEPH nasale .....	46-17	SLUDER-BALLENGER amygdalotome .....	50-05	FREEWAY-GRAVE vaginal .....	70-06
LANGENBECK à doigts .....	33-03	SMELLIE		GRAVE vaginal .....	70-02
OLIVECRONA .....	EA-05	Crochet pour les accouchements .....	72-06	Spéculum	
Scie oscillante pour plâtre .....	30-05 jusque 30-06	perce-crâne .....	72-09	GRUBER auriculaire .....	44-02
Scie		SMILLIE ménisotome .....	32-24	HARTMANN auriculaire .....	44-02
WIGMORE pour plâtre .....	30-02	SMITH blépharostat .....	42-02	HARTMANN-HALLE nasal .....	46-02
Sclerotome		SMITH-BUIE dilateur pour anus et rectum .....	68-03	Spéculum	
		SMITH-PETERSEN		JACKSON vaginal .....	70-16
		ciseaux-burin .....	32-15	KALLMORGEN vaginal .....	70-15
		gouge .....	32-15	Spéculum	
		SMITH US ARMY ciseaux à bandages .....	08-44	KILLIAN cloison .....	46-03
		SMITHWICK		KOGAN endos .....	70-23
		écarteur à nerfs .....	EA-04	Spéculum	

KRISTELLER vaginal.....	70-09	jusque 70-14
LANDAU vaginal.....	70-22	
Spéculum		
MATHIEU rectal.....	68-02	
Spéculum		
O'SULLIVAN-O'CONNOR vaginal.....	70-08	
PEDERSON vaginal.....	70-03	
Spéculum		
PRATT rectal.....	68-02	
Spéculum		
SCHERBAK vaginal.....	70-21	
SEMM vaginal.....	70-07	
Spéculum		
SIEGLE auriculaire.....	44-02	
SIMS rectal.....	68-02	
Spéculum		
SIMS vaginal.....	70-17	
STEINER-AUVARD vaginal.....	70-19	
Spéculum		
THUDICHUM nasal.....	46-02	
TIECK-HALLE nasal.....	46-03	
TOYNBEE auriculaire.....	44-02	
Spéculum		
TRELAT vaginal.....	70-07	
Spéculum		
VIENNA nasal.....	46-02	
VOLTOLINI nasal.....	46-02	
Spéculum		
WEISSBARTH vaginal.....	70-22	
Écarteur		
YANKAUER nasopharyngien.....	46-04	
SPENCER ciseaux à ligatures.....	08-40	
SPENCER-WELLS pince hémostatique.....	12-07	
Sphérique électrode pour la coagulation.....	JA-03	
SPRATT curette.....	32-12	
SPURLING pince emporte-pièce pour laminectomie EA-08.....	20-02	
STACKE sonde auriculaire en argent.....	20-02	
STAUDE-MOORE pince pour l'abaissement du col de l'utérus.....	70-31	
St. CLAIR-THOMSON couteau.....	46-19	
STEINER-AUVARD spéculum vaginal.....	70-19	
STEINMANN clou à os.....	33-09	
STELZNER ciseaux à rectum.....	08-38	
STERNBERG écarteur pour lèvres et joues.....	48-02	
Stéthoscope		
BOWLES.....	02-06	
Stéthoscope duplex.....	02-06	
Stéthoscope		
FORD.....	02-06	
FORD BOWLES.....	02-06	
PINARD.....	02-06	
STEVENS		
ciseaux à ténotomie.....	07-17, 08-23	
crochet.....	42-06	
STEVENSON blépharostat.....	42-03	
STEVENS		
pince à iris.....	42-11	
porte-aiguille pour l'ophtalmologie.....	24-06	
STIEGLITZ pince à échardes.....	10-06	
STILLE		
ciseau-burin.....	32-14	
ciseaux pour plâtre.....	30-02	
costotome.....	FG-03	
gouge.....	32-14	
STILLE-HORSLEY pince coupante à os.....	32-07	
STILLE-LISTON pince coupante à os.....	32-06	
STILLE-LUER pince gouge.....	32-04	
STILLE		
ostéotome.....	32-14	
perforateur à main.....	33-04	
pince à dissection.....	10-02	
pince pédicule rénal.....	12-16	
STILLE-RUSKIN pince gouge.....	32-05	
STILLE-SHERMAN perforateur à main.....	33-04	
St. MARTIN pince à suture.....	43-05	
STOCKMANN compresseur de l'urètre.....	66-10	
STONE pince pour fermer.....	64-06	
STONE-WATT pince intestinale.....	64-06	

STRATTE porte-aiguille.....	24-04	
STRAUSS compresseur de l'urètre.....	66-10	
Strippers.....	20-03	
STRUEMPEL pince auriculaire.....	44-08	
STRULLY ciseaux neurochirurgicaux.....	08-35	
STRUYCKEN pince coupante nasale.....	46-07	
Stylet.....	20-03	
BOWMAN pour canal lacrymal.....	42-10	
DIMEDA.....	20-03	
FARREL.....	20-03	
JOBSON-HORNE.....	20-03	
TOBOLD.....	20-03	
UCKERMANN.....	20-03	
SUBRAMANIAN pince atraumatique.....	BD-31	
Support MILLIN lumière froide.....	66-05	
SWEET pince pour poser clips.....	EA-02	
Système de fixation LEYLA.....	EA-14	
T		
TABB couteau serpente.....	44-14	
Tambour		
KONRICH à stérilisation.....	88-12	
SCHIMMELBUSCH à stérilisation.....	88-12	
Taraud pour vis canulées.....	33-15	
Tarmis pour spéculum vaginal.....	70-22	
TARNIER		
cranioclaste.....	72-09	
forceps obstétrique avec dispositif de traction.....	72-05	
TAYLOR		
écarteur spinal.....	32-24	
marteau perceur.....	02-07	
TEALE pince pour abaissement du col de l'utérus.....	70-33	
Tendeur		
à broches.....	33-10	
LOUTE serre-fil.....	33-11	
Tensiomètre.....	02-02	
TERSON pince capsulaire.....	43-04	
THOMS-ALLIS pince pour saisir les tissus.....	64-02	
THOMS-GAYLOR pince emporte-pièce pour le col de l'utérus.....	70-42	
THOMSON-WALKER écarteur vésical.....	66-06	
THOREK ciseaux pulmonaires.....	08-36	
THUDICHUM spéculum nasal.....	46-02	
TIECK-HALLE spéculum nasal.....	46-03	
TIEMANN pince pour abaissement du col de l'utérus.....	70-32	
TILLEY pince auriculaire.....	44-08	
Tire		
SAALFELD comédons.....	74-02	
SCHAMBERG comédons.....	74-02	
UNNA comédons.....	74-02	
WALTON comédons.....	74-02	
TISCHLER-KEVORKIAN pince emporte-pièce pour le col de l'utérus.....	70-44	
TISCHLER-MORGAN pince emporte-pièce pour le col de l'utérus.....	70-43	
TIVNEN pince à préhension amygdalienne.....	50-04	
TOBOLD		
abaisse-langue.....	48-02	
stylet.....	20-03	
TOENNIS-ADSON ciseaux neurochirurgicaux.....	08-35	
TOENNIS		
dissecteur duremère.....	EA-05	
pince hémostatique.....	12-11	
porte-aiguille.....	24-04	
TOHOKU pince à champs.....	14-04	
Tonomètre SCHIOETZ tonomet.echell.obli.....	43-08	
TOOK couteau cornéen.....	42-05	
TOTI fraise.....	33-07	
Tourne-vis		
hexagonal.....	33-14	
LANE.....	33-14	
Tournevis pour vis canulées.....	33-15	
Tourne-vis		
WILLIAMS.....	33-14	
Tourniquet.....	02-03	

TOWNSEND-KEVORKIAN pince emporte-pièce pour le col de l'utérus.....	70-44	
TOWNSEND-MINI (BABY TISCHLER) pince emporte-pièce pour le col de l'utérus.....	70-45	
TOWNSEND-mini pince emporte-pièce pour le col de l'utérus.....	70-44	
TOWNSEND pince emporte-pièce pour le col de l'utérus.....	70-44	
TOWNSEND-TISCHLER pince emporte-pièce pour le col de l'utérus.....	70-44	
TOYNBEE spéculum auriculaire.....	44-02	
Tracteur		
BARTON pour manches ordinaires.....	72-04	
BILL pour manches ordinaires.....	72-05	
DOYEN pour fibromes.....	70-46	
LUIKART-BILL pour manches ordinaires.....	72-05	
Traction CRUTCHFIELD crânienne.....	EA-03	
TRAUBE marteau perceur.....	02-07	
TRELAT spéculum vaginal.....	70-07	
Trépan.....	33-04	
CASTROVIEJO cornéen.....	43-07	
ELLIOT cornéen.....	43-08	
FRANCESCHETTI cornéen.....	43-07	
Trépan KEYES cutanéen.....	74-02	
Trocart.....	22-02	
COAKLEY.....	22-02	
DOUGLAS.....	22-02	
FLEURANT.....	22-02	
LICHTWITZ.....	22-02	
MENGHINI.....	22-03	
NELSON.....	22-02	
OCHSNER.....	22-02	
PIERCE.....	22-02	
UCKERMANN trachéal.....	54-02	
UNIVERSAL.....	22-02	
TROELTSCH pince nasale.....	46-04	
TROEMNER marteau perceur.....	02-07	
Trousse à manucure pour les infirmières.....	74-03	
TROUSSEAU dilateur trachéal.....	54-02	
Trousse de diagnostic.....	02-04	
Trousse mini à poche et à suture.....	26-08	
Trousses standard à poche et à suture.....	26-08	
TROUTMAN-CASTROVIEJO ciseaux micro.....	09-07	
TROUTMAN-CHRIS casse-lames.....	06-14	
TROUTMAN Colibri pince à iris.....	42-13	
TROUTMAN pince rectus.....	43-02	
TUBBS dilateur valve mitrale.....	FG-27	
Tube		
ANDREWS-PINCHON d'aspiration.....	04-03	
BUIE d'aspiration.....	68-05	
DE BAKEY d'aspiration.....	04-04	
FRAZIER d'aspiration.....	04-06	
MAGILL d'aspiration.....	04-04	
NUBOER d'aspiration.....	04-05	
POOLE d'aspiration.....	04-02	
WALTON YANKAUER d'aspiration.....	04-03	
YANKAUER d'aspiration.....	04-02	
Tübingen		
canule air.....	43-07	
pince à iris.....	42-15	
pince à ligatures.....	43-05	
Tübingen TITAN		
pince à iris.....	42-15	
pince à ligatures.....	43-05	
TUFFIER		
écarteur pour les côtes.....	FG-16	
pince hémostatique.....	12-08	
TURNBULL pince à ongles.....	74-03	
TURREL pince emporte-pièce pour biopsie.....	68-05	
TYDING		
pince à préhension amygdalienne.....	50-04	
serre-noeud.....	50-05	
U		
UCKERMANN		
stylet.....	20-03	
trocart trachéal.....	54-02	
ULRICH pince porte-éponges.....	16-06	
UNIVERSAL		



ciseaux à bandages.....	08-50	WEISS pince serre-tubes.....	12-19	dilatateur pour canal lacrymal.....	42-10
ciseaux à fils et à plaques.....	08-42	WEITLANER écarteur.....	18-14	miroir frontal.....	02-05
pince à stérilisation.....	28-02	WEITLANER-WULLSTEIN écarteur.....	18-14		
trocart.....	22-02	WELLS spatule à énucléation.....	42-08		
UNNA tire comédons.....	74-02	WERTHEIM			
Uréthrotome OTIS.....	66-08	ciseaux préparation.....	08-32		
Urinal.....	88-10	WERTHEIM-CULLEN pince pour hystérectomie	12-18		
USA		18			
cordon électrobistouris.....	JA-07	WERTHEIM			
USA MODEL ciseaux pour le cordon ombilical	08-34	Pince pour hystérectomie.....	12-18		
USA		WEST			
pince à dissection.....	10-02	ciseaux-burin nasal.....	46-14		
US Army (PARKER-LANGENBECK) écarteur.	18-03	WESTCOTT			
V		ciseaux à iridectomie.....	09-02		
VALLEIX hystéromètre.....	70-39	ciseaux à tendons.....	09-02		
Valve		WEST			
BALFOUR.....	18-22	gouge nasale.....	46-14		
CASPAR.....	18-20	WESTON serre noeud à polypes rectaux.....	68-05		
CASPAR pour colonne vertébrale.....	18-19	WHEELER			
KIRSCHNER.....	18-23	couteau à discision.....	42-04		
VAN BUREN		spatule à cyclodialyse.....	42-09		
bougie urétrale.....	66-13	WHITEHEAD ouvre-bouche.....	48-04		
pince à sequestres.....	32-10	WHITE pince à préhension amygdalienne.....	50-03		
Van DOREN pince emporte-pièce pour le col de l'utérus.....	70-42	WIEDER abaisse-langue.....	48-02		
VANNAS		WIENER (AUFRICHT) rape nasale.....	46-15		
ciseaux à iridectomie.....	09-05	WIENER			
ciseaux micro.....	09-12 jusqu'à 09-13	crochet à iris.....	42-06		
VARIFOCAL ophtalmoscope.....	02-03	rape nasale.....	46-15		
Vase à médicaments.....	88-07	WIGMORE scie pour plâtre.....	30-02		
Valve		WILDER			
KALLMORGEN vaginale.....	70-15	anse.....	42-08		
KRISTELLER vaginale.....	70-09 jusqu'à 70-14	dilatateur pour canal lacrymal.....	42-10		
VERBRUGGE davier porte-os.....	32-09	WILDE			
VERRES aiguille à ponction pneumopéritoine.....	22-03	Serre-noeud auriculaire.....	44-07		
VIENNA spéculum nasal.....	46-02	serre-noeud nasal.....	46-09		
VIRCHOW		WILDE (TROELTSCH) pince auriculaire.....	44-07		
burin pour le crâne.....	32-17	WILLET-MARTELL pince cuir chevelu.....	12-08		
couteau à cartilage.....	06-18	WILLIAMS			
couteau pour le cerveau.....	06-18	blépharostat.....	42-02		
VIRTUS (RALK) pince à échardes.....	10-06	pince pour saisir les fissus.....	64-03		
VOLKMANN		tourne-vis.....	33-14		
curette.....	32-12 jusqu'à 32-13	WILLIGER			
écarteur.....	18-07 jusqu'à 18-08	curette.....	32-13		
VOLTOLINI spéculum nasal.....	46-02	maillet.....	32-18		
W		rugine raspatoire.....	32-19		
WACHENFELDT pince pour agrafes.....	26-07	WINKELMANN Instrument de circoncision.....	66-09		
WADSWORTH-TODD cautère.....	42-08	WINTER pince placentaire et pour post-abortum	72-07		
WAGENER crochet auriculaire.....	44-07	WITTNER pince emporte-pièce pour le col de l'utérus.....	70-43		
WAGENER-MOSHER canule trachéale.....	54-03	l'utérus.....	70-43		
WAGNER		WOLFF pince pour rompre plâtre.....	30-04		
ciseaux.....	07-22	WRIGLEY forceps obstétrique.....	72-02		
ciseaux à gencives.....	08-42	WULLSTEIN			
pince emporte-pièce pour laminectomie.EA-09		ciseaux auriculaires micro.....	44-11		
WALDMANN ciseaux à épisiotomie.....	08-34	ciseaux auriculaires micro mini.....	44-11		
WALLICH curette placentaire et pour post-abortum	72-08	couteau serpette.....	44-14		
WALSHAM pince pour redresser cloison.....	46-18	WYLLIE			
WALTHER bougie urétrale.....	66-17	dilatateur pour col de l'utérus.....	70-30		
WALTON		pince atraumatique.....	BD-21		
gouge pour corps étrangers.....	42-06	Y			
tire comédons.....	74-02	YANKAUER			
WALTON YANKAUER tube d'aspiration.....	04-03	spéculum nasopharyngien.....	46-04		
WANGENSTEEN		tube d'aspiration.....	04-02		
pince à dissection.....	10-05	YASARGIL ciseaux micro.....	09-10 jusqu'à 09-11		
porte-aiguille.....	24-03	YEOMAN pince emporte-pièce pour biopsie.....	68-05		
WARTENBERG aësthésiomètre.....	02-08	YOUNG Boomerang aiguille à ligatures.....	26-03		
WATSON-CHEYNE élévateur.....	32-22	YOUNG			
WATSON dermatome.....	06-22	écarteur pour la prostate.....	66-02		
WEBER anse.....	42-08	pince pour saisir la prostate.....	66-02		
WECKER		pince tire-langue.....	48-03		
ciseaux à iris.....	09-04	Z			
spatule à iris.....	42-08	ZAUFAL-JANSEN pince gouge.....	32-04		
WEEK blépharostat.....	42-02	ZENKER pince à dissection et à ligature.....	12-12		
WEIL-BLAKESLEY pince coupante nasale.....	46-06	ZIEGLER			
WEISSBARTH spéculum vaginal.....	70-22	blépharostat.....	42-03		
		couteau à capsulotomie.....	42-05		
		couteau à iridectomie.....	42-04		

**A**

Abajalengua  
ANDREW .....48-02  
BRUENINGS .....48-02  
BUCHWALD .....48-02  
FRENZEL .....48-02  
HARTMANN .....48-02  
madera .....48-02  
McIVOR .....48-05  
TOBOLD .....48-02  
WIEDER .....48-02

Abertura BROCK dilatador para válvula mitralFG-26

Abreboca  
DAVIS-BOYLE .....48-04  
DENHART .....48-03  
DOYEN-JANSEN .....48-03  
HEISTER .....48-03  
JENNINGS .....48-04  
KILNER-DOUGHTY .....48-05  
McIVOR .....48-05  
ROSER-KOENIG .....48-03  
SEEMANN-SEIFFERT .....48-04  
WHITEHEAD .....48-04

Accesorios para contenedores  
para esterilización .....88-38 hasta 88-41  
Adenotomo LAFORCE .....46-19  
ADLERKREUTZ pinza de disección .....10-04  
ADSON BABY  
pinza hemostática .....12-09  
ADSON Baby  
separador .....18-15  
ADSON-BROWN pinza de disección .....10-03  
ADSON  
elevador .....32-21  
gancho para nervios .....EA-04  
pinza de disección .....10-03  
pinza gubia .....32-03  
pinza hemostática .....12-09  
pinza micro de disección .....10-03  
pinza para hipófisis .....EA-06  
porta-aguja .....24-04  
separador .....18-15  
AEBLI tijera para corneal .....08-22  
AESFULAP cable electrobisturías .....JA-07

Aguja  
amigdalas .....50-05  
BARBARA .....44-14  
BOWMAN para discisión .....42-05  
COOPER para ligaduras .....26-02  
DAVIS para cuerpos extraños .....42-05  
DESCHAMPS para ligaduras .....26-02  
DIX .....42-09  
electrodo .....JA-03  
electrodo mini .....JA-02  
FRANCIS para cuerpos extraños .....42-05  
FRANKLIN-SILVERMANN para punción .....22-03  
KEITH para sutura .....26-06  
KOENIG para sutura .....26-06  
KRONECKER para ligaduras .....26-02  
LEVINSON para cuerpos extranj .....42-05  
LICHTWITZ .....46-09  
NELSON para ligaduras .....26-02  
para catarata .....42-05  
para cuerpos extraños .....42-05  
Aguja para sutura .....26-05 hasta 26-06

Aguja  
POLITZER paracentesis .....44-06  
QUINKE para punción .....22-03  
REVERDIN para ligaduras .....26-03  
ROSEN .....44-14 hasta 44-15  
VERRES para punción, neumoperitoneo .....22-03  
YOUNG Boomerang para ligaduras .....26-03  
ALAN-PARKS separadore rectales .....68-03  
ALBEE fresa .....33-07  
ALEXANDER  
cincel .....32-14  
gubia .....32-14

periostótomo .....32-19  
pinza sacabocado para el cuello del útero70-42

ALLIS-ADAIR pinza para tejidos .....64-02  
ALLIS-Baby pinza para tejidos .....64-02  
ALLISON espátula pulmón .....FG-19  
ALLIS pinza para tejidos .....64-02  
ALM separador .....18-14  
ALVIS cureta para cuerpos extraños .....42-06  
Amigdalotomo SLUDER-BALLENGER .....50-05  
Amniótomo BEACHAM .....70-39  
ANDREW abajalengua .....48-02  
ANDREWS-PINCHON tubo de aspiración .....04-03

Anoscopio  
HIRSCHMANN .....68-04  
IVES-FANSLER .....68-04

Aparato PETZ para suturar estomacales e intestinales .....64-09

Aproximador  
BAILEY-BABY para costillas .....FG-18  
BAILEY-GIBBON para costillas .....FG-18  
BAILEY para costillas .....FG-18  
SELLORS para costillas .....FG-18  
ARCHER pinza para espinas .....10-06  
ARKANSAS Piedra afiladora .....06-19  
ARIT asa .....42-08

ARRUGA  
blefarostato .....42-02  
gancho para extracción .....42-06  
pinza capsulares .....43-04  
porta-aguja de oftalmología .....24-06  
protector .....42-08

Asa  
amigdalas .....50-04  
ARLT .....42-08  
auriculares .....44-07  
BILLEAU auriculares .....44-07  
Asa de alambre electrodo .....JA-03  
Asa de cinta electrodo .....JA-03

Asa  
electrodo mini .....JA-02 hasta JA-03  
para nasales .....46-09  
SNELLEN .....42-08  
WEBER .....42-08  
WILDER .....42-08

ASCH pinza enderezar tabique .....46-18  
AUFRIEHT separador para nasales .....46-17  
AUVARD espéculo vaginales .....70-19  
AXENFELD cucharilla para chalazion .....42-07  
AYER pinza chalazión .....43-06

B  
BABCOCK pinza para tejidos .....64-02  
BABINSKY martillos de percusión .....02-07  
BACKHAUS-CLIP pinza para campos con porta-tubo .....14-03  
BACKHAUS KOCHER pinza para campos .....14-02  
BACKHAUS pinza para campos .....14-02  
BAGGISH pinza sacabocado para el cuello del útero .....70-45  
BAILEY aproximador para costillas .....FG-18  
BAILEY-BABY aproximador para costillas .....FG-18  
BAILEY-GIBBON aproximador para costillasFG-18  
BAINBRIDGE  
pinza traumática .....BD-09  
pinza hemostática .....12-14  
BAKES dilatador para conducto biliar .....62-06  
BALFOUR Baby separador abdominales .....18-22  
BALFOUR  
separador abdominales .....18-22  
valva .....18-22  
BALL AND SOCKET pinza para campos .....14-04  
BALLENGER  
cuchillo .....46-11  
elevadores tabique .....46-12  
pinza coger amigdalas .....50-04

Bandeja  
de alambre .....88-13  
de chapa de acero perforada .....88-13

para instrumento .....88-08 hasta 88-09  
BANGERTER espátula ciclodialísis .....42-08  
BARANY ensordecedor .....44-04  
BARBARA  
aguja .....44-14  
ganchito .....44-14  
pick .....44-14 hasta 44-15  
BARKAN cuchillo para goniotomía .....42-05  
BARNHILL cuchillo .....46-19  
Barra GERSTER de tracción .....32-11  
BARRAQ.KATZIN pinza para iris .....42-13  
BARRAQU Colibri pinza para iris .....42-13  
BARRAQUER Colibri blefarostato .....42-02  
BARRAQUER  
cuchillo para queratoplastico .....42-05  
pinza cámara anterior .....43-02  
pinza depilatorias .....43-08  
pinza fijación .....43-03  
porta-aguja .....24-07  
tijeras de colibri .....09-04  
BARR espéculo rectales .....68-02  
BARRETT pinza pra coger el cuello de útero70-32  
BARTON  
pinza obstétricas .....72-04  
tractor adecuada para todas las pinzas con mango .....72-04  
BAUMGARTNER porta-aguja .....24-02  
BEACHAM amniótomo .....70-39  
Vaso .....88-10  
BECKER quistotomo .....42-06  
BECKMANN-ADSON separador .....18-15  
BECKMANN  
cuchillo .....46-19  
BECKMANN-EATON separador .....18-16  
BECKMANN  
separador .....18-16  
BECK pinza atraumática para vasculares perifBD-25  
BEEBEE tijeras para alambre y chapas .....08-43  
BEER pinza depilatorias .....43-08  
BEESON separador para yesos .....30-03  
BELLUCCI tijeras auriculares micro .....44-09  
BENGOLEA pinza hemostática .....12-09  
BENNETT elevador para huesos .....32-22  
BERENS queratomo .....42-04  
BERGMANN FOERSTER pinza porta esponjas16-10  
BERGMANN  
sierra para yesos .....30-02  
tijeras de vendajes .....08-46  
BERKE pinza musculares .....43-02  
BERLIND-AUVARD espéculo vaginales .....70-19  
BERLINER martillos de percusión .....02-07  
BERNHARD pinza para campos .....14-05  
BERTILLON cefalómetro .....02-08  
BEST pinza intestinales .....64-06  
BETHUNE costotomo .....FG-04  
BEUSE tijeras .....08-26  
BEYER  
pinza gubia .....32-04  
pinza sacabocado .....46-08  
BILLEAU asa auriculares .....44-07  
BILL tractor adecuada para todas las pinzas con mango .....72-05  
BIRCHER-GANSKE pinza para huesos .....32-10  
BIRCHER meniscotomo .....32-24  
BISHOP-HARMAN pinza para iris .....42-14  
Bisturi  
CONVERSE para nasales .....46-10  
electrodo .....JA-03  
Bisturías para disección .....06-15  
Bisturías PARKER para disección .....06-15  
Bisturi  
FREER mucosa .....46-10  
HALLE para duramadre .....EA-06  
JOSEPH para nasales .....46-10  
JOSEPH romo .....46-10  
MALTZ cartilage acodado .....46-11  
SEGOND para fibroma .....70-46

BLAKE			
cureta uterinas.....	70-48		
pinza para cálculos biliares.....	62-03		
Blefarostato			
ARRUGA.....	42-02		
BARRAQUER Colibri.....	42-02		
BOWMAN.....	42-02		
CASTROVIEJO.....	42-03		
CLARK.....	42-02		
CRITCHETT.....	42-02		
GOLDSTEIN.....	42-03		
GRAEFE.....	42-02		
LANCASTER.....	42-03		
LISTER-BURCH.....	42-02		
MELLINGER.....	42-02		
MELLINGER-AXENFELD.....	42-02		
MUELLER.....	42-03		
MURDOCK.....	42-02		
PARK.....	42-03		
SMITH.....	42-02		
STEVENSON.....	42-03		
WEEK.....	42-02		
WILLIAMS.....	42-02		
ZIEGLER.....	42-03		
BLOHMKE pinza coger amígdalas.....	50-04		
BLOUNT			
elevador para huesos.....	32-24		
separador para rodilla.....	32-24		
BLUMENTHAL pinza gubia.....	32-02		
BODENHAMMER espéculo rectales.....	68-02		
BOEHLER estribo para extensión.....	33-10		
BOERMA pinzas obstétricas.....	72-04		
BOETICHER tijeras para amígdalas.....	08-27		
BÖHLER			
pinza cortante para huesos.....	32-06		
pinza gubia.....	32-04		
Bola electrodo para coagulación.....	JA-03		
Bombilla de repuesto			
para laringoscopio convencional.....	AE-20		
Bombilla de repuesto			
para laringoscopio de fibra óptica.....	AE-20		
BONACCOLTO pinza para estrabismo.....	42-14		
Bonn			
canula irrigacion.....	43-07		
BONNEY pinza porta esponjas.....	16-08		
Bonn			
pinza para iris.....	42-15		
Bonn TITAN pinza para iris.....	42-15		
BORCHARDT fresa.....	33-07		
BOSE			
gancho traqueal.....	54-02		
separador traqueal.....	54-02		
BOUCHERON espéculos auriculares.....	44-02		
BOWLES estetoscopio.....	02-06		
BOWMAN			
aguja para discision.....	42-05		
blefarostato.....	42-02		
cuchillo para discision.....	42-04		
sonda canal lacrimon.....	42-10		
BOYNTON porta-aguja de oftalmología.....	24-06		
BOZEMANN-DOUGLAS pinza para tapones 16-13			
BOZEMANN			
pinza para tapones.....	16-13		
porta-aguja.....	24-03		
BRAIN			
clip standard.....	EA-13		
clip temporarios.....	EA-12		
BRAIN MINI pinza de aplicación clip.....	EA-12		
BRAIN STANDARD pinza de aplicación clip.....	EA-12		
BRAITHWAITE dermatomo.....	06-22		
BRAUN			
cranioclasto.....	72-09		
depresor uterino.....	70-39		
espéculo vaginales.....	70-16		
gancho de decapitación.....	72-09		
pinza pra coger el cuello de útero.....	70-31, 70-34		
BRAUN-STADLER tijeras para episiotomía.....	07-22,		
08-34			
BREISKY espéculo vaginales.....	70-20		
BROCK			
abertura dilatador para válvula mitral.....	FG-26		
cortante dilatador para válvula mitral.....	FG-26		
mango dilatador para válvula mitral.....	FG-26		
BROWN pinza de disección.....	10-03		
BRUENINGS			
abajalengua.....	48-02		
cierranudos amígdalas.....	50-04		
cuchillo tabique.....	46-11		
espéculos auriculares.....	44-02		
pinza cortantes para nasales.....	46-05		
pinza laringe.....	52-03		
tubo alarmiento.....	52-03		
BRUNETTI cincel espinal.....	32-17		
BRUNNER			
costotomo.....	FG-07		
pinza intestinales.....	64-06		
sonda conductora.....	26-04		
BRUNS			
cucharilla cortante.....	32-12 hasta 32-13		
tijeras para yeso.....	08-48		
BRYANT pinza porta esponjas.....	16-11		
BUCHWALD abajalengua.....	48-02		
BUCK			
cureta auriculares.....	44-05		
elevadores cuerpos extraños.....	44-08		
martillos de percusión.....	02-07		
tijeras para puntas.....	08-40		
BUIE tubo de aspiracion.....	68-05		
Buja			
COXETER uretrales.....	66-17		
DITTEL uretrales.....	66-18 hasta 66-19		
GUYON uretrales.....	66-12, 66-14 hasta 66-15		
VAN BUREN uretrales.....	66-13		
WALTHER uretrales.....	66-17		
BUMM			
cureta uterinas.....	70-49 hasta 70-50		
pinza para el útero.....	70-38		
BUNGE cucharilla para exentracion.....	42-07		
BUNNELL			
perforador a mano.....	33-05		
separador tendones.....	32-25		
BUNT clip para esterilización.....	28-02		
BURCH horquilla fijadora.....	42-05		
BURKE-Baby pinza sacabocado			
para el cuello del útero.....	70-44		
BURKE pinza sacabocado para el cuello del útero			
70-44			
BUSCH tijeras para umbilicales.....	08-34		
C			
Cable			
AESCLAP electrobisturías.....	JA-07		
ERBE SELECT electrobisturías.....	JA-07		
MARTIN electrobisturías.....	JA-07		
USA electrobisturías.....	JA-07		
Caja			
para agujas.....	88-02		
SAUERBRUCH para agujas.....	88-02		
Canula			
Bonn irrigacion.....	43-07		
Hamburg canula abotonada.....	43-07		
KILLIAN.....	46-09		
SCHEIE oculares.....	43-07		
Cánulas FINSTERER para aspiración e irrigación			
04-05			
Canula			
SIMCOE sutura.....	43-07		
Tübingen aire.....	43-07		
Capsular DASTOOR aspirador.....	42-09		
CARMALT pinza para espinas.....	10-06		
CARPENTER cuchillo para amígdalas.....	50-02		
CASPAR			
espéculo para lumbar vertebral.....	18-20		
mango de bisturías micro.....	06-12		
separador.....	18-20		
separador para columna espinal.....	18-18		
separador para columna vertebral.....	18-19		
valva.....	18-20		
valva para columna vertebral.....	18-19		
CASTAÑEDA			
pinza traumática para nacidos y niños.....	BD-42		
separador costales.....	FG-14		
CASTROVIEJO			
blefarostato.....	42-03		
dilatador canal lacrimon.....	42-10		
espátula cicloalálisis.....	42-08 hasta 42-09		
marcador compas.....	42-09		
pinza capsulares.....	43-04		
pinza fijación.....	43-03		
pinza sutura.....	43-05		
porta-aguja.....	24-07		
queratomo.....	42-04		
rompe hojas.....	06-14		
tijeras para corneal.....	09-06		
tijeras para iridectomia.....	09-05		
trépano para corneal.....	43-07		
Cateter			
HARTMANN auriculares.....	44-06		
ITARD auriculares.....	44-06		
merálicas para hombre.....	66-16		
merálicas para mujer.....	66-16		
CATLIN cuchillo para amputación.....	06-16		
Cauterio WADSWORTH-TODD.....	42-08		
Cefalómetro BERTILLON.....	02-08		
Cepillo de limpieza.....	28-04 hasta 28-05		
CHAPUT pinza hemostática.....	12-08		
CHARRIERE			
hoja de recambio.....	33-03		
sierra para amputacion.....	33-03		
CHEATLE pinza para esterilización.....	28-02		
CHERON pinza para tapones.....	16-12		
CHEVALIER-JACKSON pinza laringe.....	52-04		
CHEVALIER separador costales.....	FG-15		
CHILDE pinza para grapas.....	26-07		
Cierranudo			
KRAUSE auriculares.....	44-07		
Cierranudos			
BRUENINGS amígdalas.....	50-04		
EVES amígdalas.....	50-04		
KRAUSE para nasales.....	46-09		
TYDING amígdalas.....	50-05		
WILDE para nasales.....	46-09		
Cierranudo			
WESTON polipus rectal.....	68-05		
WILDE auriculares.....	44-07		
Cincel.....	32-14		
ALEXANDER.....	32-14		
CINELLI plástica para nasales.....	46-13		
COTTLE plástica para nasales.....	46-13		
DIX para cuerpos extraños.....	42-06		
Cincel espinal BRUNETTI.....	32-17		
Cincel esternon LEBSCH.....	32-17		
Cincel			
FOMON plástica para nasales.....	46-13		
FREER tabique.....	46-12		
HIBBS.....	32-16		
HOKE.....	32-16		
LEXER.....	32-16		
LEXER mini.....	32-16		
PARTSCH.....	32-14		
ROLLET para extirpacion.....	42-06		
SILVER plástica para nasales.....	46-14		
SMITH-PETERSEN.....	32-15		
STILLE.....	32-14		
WEST para nasales.....	46-14		
CINELLI cincel plástica para nasales.....	46-13		
Cinta de métrica.....	02-08		
Cinta sola PARHAM.....	32-11		
CITELLI pinza sacabocado.....	46-08		
Cizalla			
SEUTIN para yeso.....	30-02		
STILLE para yeso.....	30-02		
Clamp			
COLLIN para umbilicales.....	72-06		
COOLEY de bulldog traumática.....	BD-33 hasta		

BD-34	
DE BAKEY de bulldog atraumatica.....	12-02
DIFFENBACH de bulldog para sierra-fina12-03	
GLOVER de bulldog atraumatica .....	12-02
JOHNS-HOPKINS de bulldog para sierra-fina 12-03	
KANE para umbilicales .....	72-06
LOWMAN para huesos.....	32-11
CLARK blefarostato.....	42-02
CLAR	
lámpara frontal.....	02-05
mini.....	02-05
Clavo para huesos STEINMANN.....	33-09
CLEVELAND pinza gubia .....	32-02
Clip	
BRAIN standard.....	EA-13
BRAIN temporarios .....	EA-12
BUNT para esterilización.....	28-02
EDWARDS .....	BD-21
MAYO para esterilización.....	28-02
CLOWARD	
separador .....	18-17
separador para cuerpos vertebrales.....	EA-07
COAKLEY	
cureta para seno .....	46-18
trócar .....	22-02
Cobo para desechos .....	88-11
COLCLOUGH pinza sacabocado	
para discos intervertebrales.....	EA-11
COLLIER porta-aguja.....	24-02
COLLIN	
clamp para umbilicales .....	72-06
dinamometro .....	02-03
COLLIN-DUVAL pinza de disección .....	10-04
COLLIN	
espéculo vaginales.....	70-04
COLLIN-HARTMANN separador .....	18-03
COLLIN	
histerómetro .....	70-39
mango de bisturíes.....	06-08
martillo.....	32-18
pelvimetro .....	72-06
pinza hemostática .....	12-08
pinza para el útero .....	70-37
pinza para grapas.....	26-07
pinza para tapones.....	16-11
pinza tiralengua .....	48-03
COLLIN-POZZI pinza para coger el cuello de útero .....	70-32
COLLIN	
separador abdominales ....	18-24 hasta 18-25
COLLYER pelvimetro.....	72-06
COLVER pinza coger amígdalas .....	50-03
Compresor CORWIN amígdalas.....	50-04
Compresor	
STOCKMANN uretrales .....	66-10
STRAUSS uretrales .....	66-10
CONNIN-AMSLER marcador.....	42-09
Cono	
de oclusion .....	70-47
KNUTSON-KOCH para uretrografia .....	66-09
Contenedores para esterilización	
3/4 .....	88-22 hasta 88-24
especiales.....	88-34 hasta 88-37
grandes.....	88-18 hasta 88-20
medianos.....	88-26 hasta 88-29
medianos y planos .....	88-30 hasta 88-31
pequeños.....	88-32 hasta 88-33
CONVERSE bisturí para nasales .....	46-10
COOLEY	
clamp de bulldog atraumaticaBD-33 hasta BD-34	
costotomo primera .....	FG-05
COOLEY DERRA pinza atraumatica anastomosis BD-39	
COOLEY	
dilatador para válvula mitralFG-27 hasta FG-29	

dilatador para vasculares .....	FG-30
COOLEY modif. STRUCK separador atrium.FG-20	
COOLEY	
pinza atraumatica11-03, BD-35 hasta BD-37, BD-39, BD-41	
pinza atraumatica anastomosis..BD-37, BD-40	
pinza atraumatica iliaca.....	BD-37
pinza atraumatica pediátricasBD-38 hasta BD-39	
pinza para vascular .....	BD-40
separador atrium .....	FG-20
separador costales.....	FG-09
COOPER aguja para ligaduras.....	26-02
Copa graduada.....	88-07
CORDES pinza laringe .....	52-03
Corta-anillos .....	33-03
DIMEDA .....	33-03
Corta-callos CREDO .....	74-03
Corta-grapas .....	EA-02
Cortante BROCK dilatador para válvula mitralFG-26	
CORWIN compresor amígdalas .....	50-04
CORYLLOS costotomo.....	FG-04
CORYLLOS (Thorax) separador .....	18-13
Costótomo.....	FG-02
Costotomo	
BETHUNE .....	FG-04
BRUNNER .....	FG-07
COOLEY primera .....	FG-05
CORYLLOS.....	FG-04
GIERTZ-STILLE .....	FG-06
Costótomo	
GLUCK.....	FG-03
Costotomo	
SAUERBRUCH .....	FG-05
SAUERBRUCH-FREY .....	FG-06
Costótomo	
STILLE .....	FG-03
COTTLE	
cincel plástica para nasales .....	46-13
cuchillo para nasales .....	46-10
elevadores periostotomo.....	46-12
elevadores tabique.....	46-12
espéculo para nasales .....	46-03
COTTLE-KAZANJIAN pinza cortante para huesos 32-06	
COTTLE-NEIVERT separador para nasales...46-17	
COTTLE	
separador para nasales.....	46-17
tijeras para nasales .....	07-18, 08-25
COXETER bujía uretrales.....	66-17
CRAFOORD	
pinza hemostática bronquial .....	12-12
tijeras para pulmonares .....	08-36
Cranioclasto	
BRAUN.....	72-09
TARNIER .....	72-09
CREDO corta-callos .....	74-03
CRILE-MURRAY porta-aguja .....	24-02
CRILE	
pinza hemostática .....	12-05
porta-aguja .....	24-04
CRILE-RANKIN pinza hemostática .....	12-05
CRILE	
separador .....	18-02
CRILE TITAN pinza hemostática .....	12-05
CRILE-WOOD porta-aguja.....	24-02
CRITCHETT blefarostato .....	42-02
CRUTCHFIELD	
perforador para inicial.....	EA-03
pinza de tracción craneal.....	EA-03
CRUZ ROJA tijeras de vendajes.....	08-47
Cuadro KIRSCHNER .....	18-23
Cubeta	
para placenta.....	88-06
PETRI .....	88-08
redonda .....	88-04 hasta 88-05
Cuchara	
DESJARDINS para cálculos biliares .....	62-08

FERGUSON para cálculos biliares.....	62-07
LUER-KOERTE para cálculos biliares.....	62-09
MAYO para cálculos biliares .....	62-07
MOORE para cálculos biliares.....	62-05
Cucharilla	
AXENFELD para chalazion.....	42-07
BRUNS cortante .....	32-12 hasta 32-13
BUNGE para extracción .....	42-07
DAVIEL para cataratas.....	42-07
GRAEFE para cataratas .....	42-07
GUTMANN para secreciones .....	66-11
HALLE cortante .....	32-13
HEBRA para chalazion .....	42-07
KNAPP para cataratas .....	42-07
LEMPERT cortante .....	32-13
MARTINI cortante .....	32-13
MEYHOEFER para chalazion .....	42-07
SCHUDE cortante .....	32-12
SIMON cortante .....	32-13
SPRATT cortante .....	32-12
VOLKMANN cortante.....	32-12 hasta 32-13
WILLIGER cortante .....	32-13
Cuchillo	
BALLENGER .....	46-11
BARKAN para goniotomía.....	42-05
BARNHILL .....	46-19
BARRAQUER para queratoplastico.....	42-05
BECKMANN .....	46-19
BOWMAN para discision .....	42-04
BRUENINGS tabique .....	46-11
CARPENTER para amígdalas .....	50-02
CATLIN para amputación.....	06-16
COTTLE para nasales .....	46-10
DEAN para iris.....	42-04
DEUTSCHMANN para catarata .....	42-03
ELSCHNIG para corneal.....	42-05
ESMARCH para yesos.....	30-04
FREER tabique .....	46-10
GILL para corneal .....	42-05
GRAEFE para catarata .....	42-03
HOPKINS para yesos .....	30-04
KNAPP para iris .....	42-04
LANGENBECK para resección .....	06-17
LISTON para amputación .....	06-16
MUCK periostio .....	44-15
OTIS de repuesto .....	66-08
Cuchillo para amputación .....	06-16
Cuchillo para cartílagos.....	06-18
Cuchillo para yesos.....	30-04
Cuchillo	
PAUFIQUE para queratoplastico .....	42-05
PLESTER lobar.....	44-14
POLITZER auriculares.....	44-06
REINER para yesos .....	30-04
ROSEN circular .....	44-14
SATO para corneal .....	42-05
SCHIE para goniotomía .....	42-05
SCHUKNECHT circular .....	44-14
SCHUKNECHT forma hoz.....	44-14
SEXTON auriculares.....	44-06
St. CLAIR-THOMSON .....	46-19
TABB forma hoz.....	44-14
TOOK para corneal.....	42-05
VIRCHOW para cartílagos .....	06-18
VIRCHOW para cerebro .....	06-18
WHEELER para discision .....	42-04
WULLSTEIN forma hoz .....	44-14
ZIEGLER capsulotomía .....	42-05
ZIEGLER para iridectomía .....	42-04
CULLER espátula para iris .....	42-08
Cuna .....	88-06
Cureta	
ALVIS para cuerpos extraños.....	42-06
aspiradora .....	70-51
BLAKE uterinas .....	70-48
BUCK auriculares.....	44-05
BUMM uterinas .....	70-49 hasta 70-50
COAKLEY para seno .....	46-18
CUZZI para aborto y placenta .....	72-08



FAULKNER .....	46-18	de aorta .....	BD-13, BD-15, BD-18	DE BAKEY para vasculares .....	FG-31
FOX para lupus .....	74-02	pinza atraumatica bronquiales .....	BD-19	GERBODE para válvula mitral .....	FG-28
GOURDET uterinas .....	70-48	pinza atraumatica de disección y ligaduraBD-	25, BD-32	GOODELL uterinos .....	70-30
GROSS auriculares .....	44-06	pinza atraumatica iliaca .....	BD-11	HANK uterinos .....	70-28
HOUSE .....	44-15	pinza atraumatica para vasculares perifBD-06		HEGAR uterinos .....	70-24 hasta 70-27
KEVORKIAN aspiradoras		porta-aguja .....	24-03	HETZER para válvula mitral .....	FG-29
para la biopsia uterina .....	70-40	DE BAKEY REYNOLDS		KUENTSCHER .....	33-13
LANG .....	42-08	pinza atraumatica anastomosis .....	BD-30	LABORDE traqueal .....	54-02
NOVAK aspiradoras para la biopsia uterina	70-40	DEBAKEY SATINSKY pinza atraumatica .....	BD-22	MILLIN para el cuello vesical .....	66-07
PESTALAZZA para aborto y placenta .....	72-08	DE BAKEY		PRATT uterinos .....	70-29
PIFFARD para lupus .....	74-02	tijeras para vasculares .....	08-30	SIMS uterinos .....	70-30
RANDALL aspiradoras para la biopsia uterina	70-40	tubo de aspiración .....	04-04	TROUSSEAU traqueal .....	54-02
RECAIMER uterinas .....	70-49 hasta 70-50	Dedal LANGENBECK .....	48-06	TUBBS para válvula mitral .....	FG-27
SCHROEDER uterinas .....	70-48	DEJERINE martillos de percusión .....	02-07	WILDER canal lacrimal .....	42-10
SIMON uterinas .....	70-48	De LEE pinza obstétricas .....	72-02	WYLIE uterinos .....	70-30
SIMS uterinas .....	70-49 hasta 70-50	De MARTEL guia-sierra .....	EA-05	ZIEGLER canal lacrimal .....	42-10
WALLICH para aborto y placenta .....	72-08	DeMARTEL-WOLFSON pinza para anastomosis64-	07	DIMEDA Alu diapasones .....	44-03
CUSCO espéculo vaginales .....	70-04 hasta 70-06	DENHART abreboza .....	48-03	DIMEDA	
CUSHING		Depresor		corta-anillos .....	33-03
espátulas cerebral .....	EA-07	BRAUN uterino .....	70-39	estilete .....	20-03
gancho para nervios .....	EA-04	REICHERT epiglotis .....	52-02	iman oculístico .....	43-08
perforadores plano .....	33-04	SIMS uterino .....	70-39	pinza para desechos .....	28-03
pinza cortantes para laminectomía .....	EA-08	DERF porta-aguja .....	24-02	rompe hojas .....	06-14
pinza de disección .....	10-03	Dermátomo		separador .....	18-14
separador .....	18-07	BRAITHWAITE .....	06-22	tijeras de vendajes .....	08-46
Cuticular .....	74-03	hoja .....	06-21	Dinamometro COLLIN .....	02-03
CUZZI cureta para aborto y placenta .....	72-08	HUMBY .....	06-20	DINGMANN pinza para huesos .....	32-10
CZERNY		SCHINK .....	06-21	Disecador	
espéculo rectales .....	68-02	SILVER .....	06-20	GREEN para corneal .....	42-06
pinza para cálculos biliares .....	62-03	WATSON .....	06-22	HURD para amígdalas .....	50-02
pinza para coger el cuello de útero .....	70-34	DERRA pinza atraumatica anastomosis,		PATON para la cornea .....	42-05
D		pediátricas .....	BD-28	Disector ROBB para vasculares .....	FG-33
DALE pinza atraumatica para vasculares perifBD-	24	DESCHAMPS aguja para ligaduras .....	26-02	DITTEL	
DANDY		Descolorador		bujia uretrales .....	66-18 hasta 66-19
gancho para nervios .....	EA-04	DAVIS duramadre .....	EA-05	introduccion de catéte .....	66-11
pinza hemostática .....	12-07	duramadre .....	EA-05	DIX	
tijeras para neuroquirurgicas .....	08-36	FISCH .....	44-15	aguja .....	42-09
DARDIK pinza atraumatica .....	BD-07	HORSLEY duramadre .....	EA-06	cincel para cuerpos extraños .....	42-06
DARLING separador .....	18-17	MILLIGAN duramadre .....	EA-05	DOUGLAS	
DARTIGUES pinza para el útero .....	70-37	PENFIELD duramadre .....	EA-06	pinza depilatorias .....	43-08
DASTOOR		SACHS duramadre .....	EA-05	trócar .....	22-02
capsular aspirador .....	42-09	TOENNIS duramadre .....	EA-05	DOYEN-Baby pinza intestinales .....	64-03
pinza para estrabismo .....	42-14	DESJARDINS		DOYEN	
DAVIDSON (Scapula) separador .....	18-13	cuchara para cálculos biliares .....	62-08	espéculo vaginales .....	70-18, 70-20
DAVIEL cucharilla para cataratas .....	42-07	pinza para cálculos biliares .....	62-02	fresa .....	33-07
DAVIS		pinza via billar .....	12-15	DOYEN-JANSEN abreboza .....	48-03
aguja para cuerpos extraños .....	42-05	sonda para cálculos biliares .....	62-05	DOYEN	
DAVIS-BOYLE abreboza .....	48-04	DESMARRES		periotótomos para costillas .....	32-20
DAVIS		pinza chalazión .....	43-06	pinza intestinal .....	64-03
descolorador duramadre .....	EA-05	separador .....	18-07	pinza para campos .....	14-05
pinza para esterilización .....	28-02	Destornillador .....	33-14 hasta 33-15	pinza para polipe uterino .....	70-36
DAY ganchito auriculares .....	44-07	LANE .....	33-14	separador .....	18-12
DEAN		WILLIAMS .....	33-14	sonda .....	20-02
cuchillo para iris .....	42-04	DEUTSCHMANN cuchillo para catarata .....	42-03	tijeras para ginecológicas .....	08-33
tijeras para amígdalas .....	08-26	DeVILBISS pinza craneanea .....	EA-05	tirabuzón para fibroma .....	70-46
DEAVER Grip separador .....	18-05	DEWEY pinzas obstétricas		DUBOIS tijeras para ginecológicas .....	08-33
DEAVER		con dispositivo de tracción .....	72-05	DUPLAY	
separador .....	18-05	Diagnóstico Juego para .....	02-04	pinza para tapones .....	16-14
tijeras .....	07-05, 08-06	DIAMANT pinza corta-hilo .....	33-12	pinza para coger el cuello de útero .....	70-31
DEBAKEY BAHNSON		Diapasones .....	44-04	DUPUY-WEISS pinza aguja .....	50-03
pinza atraumatica aneurisma de aorta .....	BD-14	DIMEDA Alu .....	44-03	DUVAL	
DE BAKEY		HARTMANN .....	44-03	pinza de disección .....	10-04
clamp de bulldog atraumatica .....	12-02	LUCAE .....	44-04	pinza para tejidos .....	64-03
dilatador para vasculares .....	FG-31	RYDEL-SEIFFER .....	44-04	E	
DE BAKEY MORRIS pinza atraumatica .....	BD-16	DEFFENBACH clamp de bulldog para serra-fina	12-03	ECHLIN pinza gubia .....	32-05
DE BAKEY		DIETER pinza la cabeza del martillo .....	44-10	EDWARDS	
pinza atraumatica .....	11-03	DIETHRICH		clip .....	BD-21
DEBAKEY pinza atraumatica .....	BD-02, BD-08	pinza atraumatica .....	BD-31	pinza para aplicar clips .....	BD-21
DE BAKEY		porta-aguja para vascular .....	24-06	Electrodo para coagulación miniJA-02 hasta JA-03	
pinza atraumatica .....	BD-16 hasta BD-17	tijeras para vasculares .....	08-29	Elevador	
DEBAKEY pinza atraumatica .....	BD-20	Dilatador		ADSON .....	32-21
DE BAKEY		BAKES para conducto biliar .....	62-06	BENNETT para huesos .....	32-22
pinza atraumatica .....	BD-28 hasta BD-30	CASTROVIEJO canal lacrimal .....	42-10	BLOUNT para huesos .....	32-24
pinza atraumatica anastomosis .....	BD-25	COOLEY para válvula mitralFG-27 hasta FG-	29	Elevadores	
pinza atraumatica aneurisma		COOLEY para vasculares .....	FG-30	BALLENGER tabique .....	46-12

FREER tabique .....	46-11	Especulo CASPAR para lumbar vertebral ....	18-20	FARABEUF	
HAJEK-BALLENGER tabique.....	46-12	Espéculo		periestótomos .....	32-19
JOSEPH periostotomo.....	46-12	COLLIN vaginales .....	70-04	pinza para huesos .....	32-07
KILLIAN tabique.....	46-12	COTTLE para nasales .....	46-03	separador .....	18-02
McKENTY tabique.....	46-11	CUSCO vaginales .....	70-04 hasta 70-06	FARREL estilite .....	20-03
QUIRE cuerpos extraños .....	44-08	CZERNY rectales .....	68-02	FAULKNER cureta .....	46-18
ROGER tabique .....	46-11	DOYEN vaginales .....	70-18, 70-20	FAURE	
Elevador		FREEWAY-GRAVE vaginales.....	70-06	pinza para peritoneo .....	12-17
HENKE para amígdalas .....	50-02	GRAVE vaginales .....	70-02	pinza sacabocado para el cuello del útero70-41	
HOHMANN mini para huesos .....	32-23	HARTMANN-HALLE para nasales .....	46-02	FEHLAND pinza intestinales .....	64-06
HOHMANN para huesos..32-22 hasta 32-23		JACKSON vaginales .....	70-16	FEILCHENFELD pinza para espinas .....	10-06
KEY .....	32-21	KALLMORGEN vaginales.....	70-15	FERGUSSON	
LANGENBECK .....	32-21	KILLIAN tabique .....	46-03	cuchara para cálculos biliares .....	62-07
LEMPERT .....	44-15	KOGAN endocervicales.....	70-23	pinza hemostática.....	12-07
McDONALD.....	32-22	KRISTELLER vaginales .....	70-09 hasta 70-14	pinza para huesos .....	32-07
MURLESS para cabeza.....	72-05	LANDAU vaginales .....	70-22	tijeras .....	08-49
MURPHYLANE .....	32-22	MATHIEU rectales .....	68-02	FERRIS pinza de disección .....	10-04
para huesos .....	32-23	O'SULLIVAN-O'CONNOR vaginales.....	70-08	FERRIS-SMITH-KERRISON	
WATSON-CHEYNE .....	32-22	PEDERSON vaginales.....	70-03	pinza sacabocado para discos intervertebrales EA-10	
ELLIOT		PRATT rectales .....	68-02	FERRIS-SMITH pinza cortantes para laminectomía EA-09	
pinza obstétricas.....	72-02	Espéculos		FILIFORM sonda.....	66-12
trépano para corneal .....	43-08	BOUCHERON auriculares.....	44-02	FINOCHIETTO-BABY separador costales.....	FG-09
ELLIS gubia para cuerpos extraños .....	42-06	BRUENINGS auriculares.....	44-02	FINOCHIETTO BURFORD	
ELSAESSER pinza para nephrostomía.....	62-13	Espéculo		separador costales.....	FG-12 hasta FG-14
ELSCHNIG		SCHERBAK vaginales .....	70-21	FINOCHIETTO-HAIGHT BABY separador costales FG-10	
cuchillo para corneal.....	42-05	SEMM vaginales.....	70-07	FINOCHIETTO INFANT separador costales.FG-12	
espatula ciclodiallisis .....	42-08	Espéculos		FINOCHIETTO (modif) separador costales .FG-08	
pinza capsulares.....	43-04	GRUBER auriculares .....	44-02	FINOCHIETTO	
pinza fijación .....	43-03	HARTMANN auriculares.....	44-02	pinza bronquiales.....	FG-21
Embudos .....	88-07	Espéculo		porta-aguja .....	24-04
EMMET gancho para fístula .....	70-46	SIMS rectales .....	68-02	separador costales FG-08, FG-10 hasta FG-11	
ENGEL sierra para yesos .....	30-02	SIMS vaginales.....	70-17	tijera para recto.....	08-38
Ensordecedor BARANY.....	44-04	Espéculos		FINSEN separador .....	18-14
EPPENDORFER-KEVORKIAN		SIEGLE auriculares .....	44-02	FINSTERER cánulas para aspiración e irrigación 04-05	
pinza sacabocado para el cuello del útero70-46		Espéculo		FISCH descolador .....	44-15
EPPENDORFER pinza sacabocado para el cuello del útero.....70-45 hasta 70-46		STEINER-AUVARD vaginales .....	70-19	FISCHER pinza para iris .....	42-13
EPPENDORFER TISCHLER-MORGAN		Espéculos		Fleboextractores .....	20-03
pinza sacabocado para el cuello del útero70-46		TOYNBEE auriculares.....	44-02	FLETCHER JAVERTS pinza porta esponjas...16-10	
ERBE SELECT cable electrobisturías .....	JA-07	Espéculo		FLEURANT trócar.....	22-02
Escariadores .....	33-08	THUDICHUM para nasales .....	46-02	FOERSTER	
PERTHES .....	33-08	TIECK-HALLE para nasales .....	46-03	pinza para iris.....	42-12
Escarificador GRAEFE.....	42-04	TRELAT vaginales .....	70-07	pinza porta esponjas .....	16-06 hasta 16-08
Esclerotomo		Vienna para nasales .....	46-02	FOMON	
GUYTON-LUNDSGAARD.....	42-05	VOLTOLINI para nasales.....	46-02	cincel plástica para nasales .....	46-13
LUNDSGAARD .....	42-05	WEISSBARTH vaginales.....	70-22	lima para nasales.....	46-15 hasta 46-16
Escupideras .....	88-06	YANKAUER nasofaringe .....	46-04	separador para nasales.....	46-17
Esférica.....	33-04	Especulo frontal ZIEGLER.....	02-05	tijeras para nasales .....	07-18, 08-25
Esfigmomanómetros.....	02-02	Especulo		Fórceps	
ESMARCH		laringeos.....	52-04	BARTON obstétricos.....	72-04
cuchillo para yesos .....	30-04	MICHEL .....	46-04	BOERMA obstétricos .....	72-04
tijeras de vendajes .....	08-46	Estetoscopio		De LEE obstétricos .....	72-02
Espátula .....	20-03	BOWLES.....	02-06	DEWEY obstétricos con dispositivo de tracción 72-05	
ALLISON pulmón .....	FG-19	Estetoscopio duplex .....	02-06	ELLIOT obstétricos .....	72-02
Espátula		Estetoscopio		KIELLAND-LUIKART obstétricos .....	72-03
BANGERTER ciclodiallisis.....	42-08	FORD .....	02-06	KIELLAND obstétricos .....	72-02
CASTROVIEJO ciclodiallisis42-08 hasta 42-09		FORD BOWLES .....	02-06	LUIKART obstétricos .....	72-03
CULLER para iris .....	42-08	PINARD .....	02-06	McLEAN-LUIKART obstétricos.....	72-03
ELSCHNIG ciclodiallisis .....	42-08	Estilite .....	20-03	McLEAN obstétricos .....	72-04
KOCHER vesical .....	66-04	DIMEDA .....	20-03	McLEAN-TUCKER-LUIKART obstétricos.....	72-03
LEGUEU vesical .....	66-04	FARREL .....	20-03	NAEGELE obstétricos.....	72-03
Espátula		JOBSON-HORNE .....	20-03	PIPER obstétricos .....	72-04
para la íntima .....	FG-32	MAGILL para tubo .....	04-04	PIPER obstétricos con dispositivo de tracción 72-04	
Espátulas		TOBOLD .....	20-03	SIMPSON-BRAUN obstétricos.....	72-02
CUSHING cerebral .....	EA-07	UCKERMANN .....	20-03	SIMPSON-LUIKART obstétricos.....	72-03
HEIFETZ cerebral .....	EA-07	Estríbo		SIMPSON obstétricos .....	72-02
OLIVECRONA cerebral .....	EA-07	BOEHLER para extensión .....	33-10	TARNIER obstétricos con dispositivo de tracción.....	72-05
Espatula		KIRSCHNER para extensión .....	33-10	WRIGLEY obstétricos .....	72-02
WECKER para iris .....	42-08	para extensión.....	33-10	FORD BOWLES estetoscopio .....	02-06
WELLS enucleacion .....	42-08	Estuche		FORD estetoscopio .....	02-06
WHEELER ciclodiallisis.....	42-09	acero inoxidable.....	88-03	FOX cureta para lupus.....	74-02
Espéculo		caja .....	88-03	FRAENKEL	
AUVARD vaginales.....	70-19	Estuche de bolsillo y de sutura			
BARR rectales .....	68-02	mini.....	26-08		
BERLIND-AUVARD vaginales.....	70-19	standard .....	26-08		
BODENHAMMER rectales.....	68-02	EYES cierranudos amígdalas .....	50-04		
BRAUN vaginales .....	70-16	Extractor KUENTSCHER .....	33-13		
BREISKY vaginales .....	70-20	F			
		FARABEUF-LAMBOTTE pinza para huesos...32-08			

pinza laringe.....	52-03	GERALD pinza de disección.....	10-05	Guia-sierra De MARTEL.....	EA-05
pinza polipus laringe.....	52-02	GERBODE dilatador para válvula mitral.....	FG-28	GUTHRIE ganchito.....	18-06
FRANCESCHETTI trépano para corneal.....	43-07	GERSTER barra de tracción.....	32-11	GUTMANN cucharilla para secreciones.....	66-11
FRANCIS aguja para cuerpos extraños.....	42-05	GERZOG martillo.....	32-18	GUYON	
FRANKLIN-SILVERMANN aguja para punción.....	22-03	GIERTZ-STILLE costotomo.....	FG-06	bujía uretrales.....	66-12, 66-14 hasta 66-15
FRAZIER		GIGLI mango para sierra.....	EA-05	introdutor de catéter.....	66-11
ganchito.....	18-06	GILL-ARRUGA pinza capsular.....	43-03	pinza para pedícula renal.....	12-16
separador.....	18-21	GILL		GUYTON-LUNDSGAARD esclerotomo.....	42-05
tubo de aspiración.....	04-06	cuchillo para corneal.....	42-05		
FREER		GILL-HESS pinza para iris.....	42-12	H	
bisturi mucosa.....	46-10	GILLIES		HABERER separador.....	18-04
cincel tabique.....	46-12	ganchito.....	46-17	HAGLUND-STILLE separador para yesos.....	30-03
cuchillo tabique.....	46-10	pinza de disección.....	10-05	HAIGHT separador costales.....	FG-15
elevadores tabique.....	46-11	porta-aguja.....	24-05	HAJEK-BALLENGER elevadores tabique.....	46-12
gubia.....	46-14	GILL		HAJEK-CLAUS pinza seno maxil.....	46-08
FREEWAY-GRAVE espéculo vaginales.....	70-06	pinza para iris.....	42-12	HAJEK gubia para nasales.....	46-14
FRENZEL abajalengua.....	48-02	GLOVER		HAJEK-KOFLER pinza sacabocado.....	46-08
Fresa.....	33-07	clamp de bulldog atraumatica.....	12-02	HALLE	
ALBEE.....	33-07	pinza atraumatica.....	BD-06, BD-30	bisturi para duramadre.....	EA-06
BORCHARDT.....	33-07	pinza atraumatica anastomosis.....	BD-05	cucharilla cortante.....	32-13
Fresa cónica HUDSON.....	33-04	pinza para coasctación atraumatica.....	BD-04	HALSEY porta-aguja.....	24-02
Fresa		GLUCK costótomo.....	FG-03	HALSTEAD-MOSQUITO micro pinza hemostática	12-04
DOYEN.....	33-07	GOELET separador.....	18-03	12-04	
para corticalis.....	33-15	GOLDMAN-FOX tijeras para encías.....	08-41	HALSTEAD-MOSQUITO	
TOTI.....	33-07	GOLDSTEIN blefarostato.....	42-03	pinza atraumatica.....	BD-02
FRIEDMAN MINI pinza gubia, mini.....	32-02	Goniómetro MOELTGEN.....	02-08	pinza hemostática.....	12-04
FRIEDMAN		GOODELL dilatador uterinos.....	70-30	HALSTEAD-MOSQUITO TITAN pinza hemostática	12-04
pinza gubia.....	32-02	GOOD tijeras para amígdalas.....	08-27	12-04	
separador perineorraf.....	70-23	GORNEY tijera de disección.....	08-13	Hamburg canula abotonada.....	43-07
FRITSCH separador.....	18-11	GOSSET separador abdominales.....	18-21	HANK dilatador uterinos.....	70-28
FRYKHOLM pinza gubia.....	32-05	GOURDET cureta uterinas.....	70-48	HARKEN pinza atraumatica aurícula.....	BD-23
FUCHS pinza capsulares.....	43-04	GRADLE pinza depilatorias.....	43-08	HARRINGTON	
		GRAEFE		pinza bronquiales.....	FG-21
G		blefarostato.....	42-02	separador.....	18-05
GALLAHER lima para seno.....	46-16	cucharilla para cataratas.....	42-07	HARTMANN	
Ganchito.....	44-15	cuchillo para catarata.....	42-03	abajalengua.....	48-02
BARBARA.....	44-14	escarificador.....	42-04	catéter auriculares.....	44-06
DAY auriculares.....	44-07	ganchito.....	18-06	diapasones.....	44-03
FRAZIER.....	18-06	gancho para estrabismo.....	42-06	espéculos auriculares.....	44-02
GILLIES.....	46-17	pinza de disección.....	10-03	HARTMANN-HALLE espéculo para nasales.....	46-02
GRAEFE.....	18-06	pinza fijación.....	43-03	HARTMANN-HOFFMANN pinza auriculares.....	44-08
GUTHRIE.....	18-06	pinza para iris.....	42-11	HARTMANN	
JOSEPH.....	18-06	quistotomo.....	42-06	pinza auriculares.....	44-08
KILNER para la piel.....	74-02	GRAEFE-TITAN gancho para estrabismo.....	42-06	pinza cortantes para nasales.....	46-07
WAGENER auriculares.....	44-07	GRAHAM gancho para nervios.....	EA-04	pinza hemostática.....	12-03
Gancho		Grapas MICHEL.....	26-07	pinza polipus para nasales.....	46-04
ADSON para nervios.....	EA-04	GRAVE espéculo vaginales.....	70-02	HARTMANN-WULLSTEIN pinza auriculares.....	44-08
ARRUGA para extracción.....	42-06	GRAY pinza via billar.....	12-15	HEANEY	
BOSE traqueal.....	54-02	GREEN-ARMYTAGE pinza-clamp uterina		pinza histerectomía.....	12-18
BRAUN de decapitación.....	72-09	para hemostasis.....	72-06	porta-aguja.....	24-03
CUSHING para nervios.....	EA-04	GREEN		separador.....	18-12
DANDY para nervios.....	EA-04	disecador para corneal.....	42-06	HEATH tijeras para puntas.....	08-40
de extracción.....	33-13	gancho muscular.....	42-06	HEBRA cucharilla para chalazion.....	42-07
electrodo mini.....	JA-02	pinza fijación.....	43-03	HEGAR dilatador uterinos.....	70-24 hasta 70-27
EMMET para fístula.....	70-46	separador.....	18-10	HEGENBARTH pinza para grapas.....	26-07
GRAEFE para estrabismo.....	42-06	GREGORY pinza atraumatica profunda.....	BD-33	HEIFETZ espátulas cerebral.....	EA-07
GRAEFE-TITAN para estrabismo.....	42-06	GREVEN pinza auriculares micro.....	44-10	HEIMING pinza para cálculos renales.....	62-13
GRAHAM para nervios.....	EA-04	GRIP pinza para agarrar.....	33-11	HEISS pinza hemostática.....	12-09
GREEN muscular.....	42-06	GROSS		HEISTER abreboca.....	48-03
ITERSON traqueal.....	54-02	cureta auriculares.....	44-06	Hemostata PASSOW.....	44-15
JAMESON para estrabismo.....	42-06	GROSS-MAIER pinza para tapones.....	16-02 hasta 16-04	HENKE elevador para amígdalas.....	50-02
LOVE para nervios.....	EA-04	GROSS		HENNIG separador para yesos.....	30-03
O' CONNOR para iris.....	42-06	pinza para tapones.....	16-05	HENROTIN pinza psra coger el cuello de útero.....	70-34
para extensión.....	33-10	GRUBER espéculos auriculares.....	44-02	HERMANN separador para yesos.....	30-03
PRATT cístico.....	68-04	Gubia.....	32-14	HERRICK pinza para peritoneo.....	12-17
ROSE traqueal.....	54-03	ALEXANDER.....	32-14	HERTZLER separador costales.....	FG-17
SACHS para nervios.....	EA-04	ELLIS para cuerpos extraños.....	42-06	HESS	
SMELLIE obstetrico.....	72-06	FREER gubia.....	46-14	pinza capsulares.....	43-04
SMITHWICK para nervios.....	EA-04	HAJEK para nasales.....	46-14	pinza para iris.....	42-12
STEVENS para cristalino.....	42-06	HIBBS.....	32-16	HETZER dilatador para válvula mitral.....	FG-29
WIENER para iris.....	42-06	KILLIAN-CLAUS para nasales.....	46-14	HEYMANN-KNIGHT pinza polipus para nasales	46-05
Garrote MAUNDER madera.....	48-06	LEXER.....	32-16	HEYMANN	
GAUSS pinza para pericraneo.....	72-06	LEXER mini.....	32-16	pinza cortantes para nasales.....	46-05
GELLHORN pinza sacabocado		PARTSCH.....	32-14	tijeras para nasales.....	07-18, 08-25
para el cuello del útero.....	70-42	SMITH-PETERSEN.....	32-15	HEYWOOD-SMITH pinza emorroidal.....	68-05
GELPI separador abdominales.....	18-24	STILLE.....	32-14	HIBBS	
GEMINI MINI pinza de disección y ligadura.....	12-10	WALTON para cuerpos extraños.....	42-06	cincel.....	32-16
GEMINI pinza de disección y ligadura.....	12-10	WEST para nasales.....	46-14		



gubia .....	32-16
osteotomo .....	32-16
Hilo para huesos .....	33-11
HIRSCHMANN anoscopio .....	68-04
Histerómetro	
COLLIN .....	70-39
MARTIN .....	70-39
SIMS .....	70-39
VALLEIX .....	70-39
HOESEL porta-aguja .....	24-05
HOFER separador bilar .....	50-02
HOFF pinza para campos .....	14-03
HOHMANN elevador para huesos 32-22 hasta 32-23	
HOHMANN mini elevador para huesos .....	32-23
Hoja	
CHARRIERE de recambio .....	33-03
Hoja de bisturíes estériles .....	06-06, 06-09
Hoja de bisturíes estériles micro .....	06-13
Hoja	
dermatómano .....	06-21
HUMBY de repuesto para dermatómano .....	06-20
Hoja para navaja .....	06-14, 06-19
Hoja sierra para yesos .....	30-05 hasta 30-06
HOKE cincel .....	32-16
HOLTH pinza para capsuloiridectomo .....	42-09
HOPKINS cuchillo para yesos .....	30-04
Horquilla BURCH fijadora .....	42-05
HORSLEY descolador duramadre .....	EA-06
HOUSE cureta .....	44-15
HRYNTSCHAK separador para prostata .....	66-06
HUBER mango universal .....	52-03
HUDSON	
fresa cónica .....	33-04
perforador a mano .....	33-04
HUMBY	
dermatómano .....	06-20
hoja de repuesto para dermatómano .....	06-20
HUNTER pinza para espinas .....	10-06
HURD disecador para amígdalas .....	50-02
I	
Iman DIMEDA oculístico .....	43-08
Impactor .....	33-12
KUENTSCHER .....	33-13
INGE separador para cuerpos vertebrales .....	EA-07
Instrument LAFORCE para cuerpos extraños .....	42-06
Instrumento	
KNUTSON para uretrografía .....	66-09
MOGAN para circuncisión .....	66-09
para circuncisión .....	66-09
WINKELMANN para circuncisión .....	66-09
Insuflador POLITZER de aire .....	44-05
Introducción de catéter	
DITTEL .....	66-11
GUYON .....	66-11
IOWA pinza para coger el cuello de útero .....	70-35
IRIS	
tijera .....	08-19
tijera de oftalmología .....	08-22
tijeras .....	07-16, 08-21
Irrigador .....	88-05
ISRAEL separador .....	18-11
ITARD cateter auriculares .....	44-06
ITERSON gancho traqueal .....	54-02
IVES-FANSLER anoscopio .....	68-04
J	
JACKSON	
especulo vaginales .....	70-16
pinza tapones .....	52-02
separador traqueal .....	54-02
tubo traqueal .....	54-03
JACOBSON tijeras micro .....	09-11
JACOBS pinza pra coger el cuello de útero .....	70-34
JAEGER	
placa para párpados .....	42-03
queratomo .....	42-04
JAMESON	

gancho para estrabismo .....	42-06
pinza para estrabismo .....	42-13
JAMISON porta-aguja .....	24-03
JANSEN	
pinza para nasales .....	46-04
separador .....	18-14
JARCHO pinza pra coger el cuello de útero .....	70-32
JATHO pinza nasofaringe .....	46-18
JAVID pinza atraumatica carotis .....	BD-32
JENNINGS abrebooca .....	48-04
Jeringa	
amígdalas .....	50-05
REINER auriculares .....	44-05
JOBSON-HORNE estilete .....	20-03
JOHNS-HOPKINS	
clamp de bulldog para sierra-fina .....	12-03
pinza via billar .....	12-14
JOHNSON porta-aguja .....	24-04
JONES pinza para campos con porta-tubo .....	14-02
JOSEPH	
bisturi para nasales .....	46-10
bisturi romo .....	46-10
elevadores periostotomo .....	46-12
ganchito .....	18-06
JOSEPH (LEWIS) lima para nasales .....	46-15
JOSEPH	
lima para huesos .....	46-14
sierra para nasales .....	46-17
tijera .....	08-16
tijeras .....	07-14
JUDD-ALLIS pinza para tejidos .....	64-02
JUDD-MASSON separador vesicales .....	66-04
Juego	
de autopsia .....	32-17
de manicura para enfermeras .....	74-03
KEYES de trefinas cutaneous .....	74-02
Juego para	
diagnóstico .....	02-04
otoscopia .....	02-04
JURASZ pinza polipus laringe .....	52-02
K	
KABIERSKE lanzapolvo .....	44-04
KALLMORGEN	
especulo vaginales .....	70-15
valva vaginales .....	70-15
KALT-ARRUGA porta-aguja .....	24-07
KALT	
pinza capsulares .....	43-04
porta-aguja .....	24-07
KANE clamp para umbilicales .....	72-06
KEITH aguja para sutura .....	26-06
KELLY Grip separador .....	18-04
KELLY	
pinza hemostática .....	12-05
pinza para polipe uterino .....	70-36
proctoscopio .....	68-04
KELLY-RANKIN pinza hemostática .....	12-05
KELLY	
separador .....	18-04, 18-12
tijeras para ginecológicas .....	07-22, 08-33
KELLY TITAN pinza hemostática .....	12-05
KERN pinza para huesos .....	32-08
KERRISON pinza sacabocado .....	46-08
KEVORKIAN	
cureta aspiradoras para la biopsia uterina 70-40	
KEVORKIAN-Pacific pinza sacabocado	
para el cuello del útero .....	70-44
KEVORKIAN	
pinza sacabocado para el cuello del útero 70-43, 70-46	
KEY elevador .....	32-21
KEYES juego de trefinas cutaneous .....	74-02
KIELLAND pinza obstétricas .....	72-02
KIELLAND-LUIKART pinzas obstétricas .....	72-03
KILLIAN	
canula .....	46-09
KILLIAN-CLAUS gubia para nasales .....	46-14

KILLIAN	
elevadores tabique .....	46-12
especulo tabique .....	46-03
KILNER-DOUGHTY abrebooca .....	48-05
KILNER	
ganchito para la piel .....	74-02
tijera .....	08-17
tijeras .....	07-14
KIRBY-ARTHUR pinza para iris .....	42-13
KIRK martillo .....	32-18
KIRSCHNER	
cuadro .....	18-23
estribo para extensión .....	33-10
perforador a mano .....	33-05
separador abdominales .....	18-23
sonda conductora .....	26-04
taladros filiformes .....	33-09
valva .....	18-23
KLINKENBERGH-LOTH tijeras para toracica .....	08-37
KNAPP	
cucharilla para cataratas .....	42-07
cuchillo para iris .....	42-04
KNAPP-LUER pinza tracoma .....	43-06
KNAPP	
separador .....	42-06
tijeras .....	08-20
KNIGHT pinza cortantes para nasales .....	46-05
KNOWLES tijeras de vendajes .....	08-47
KNUTSON instrumento para uretrografía .....	66-09
KNUTSON-KOCH cono para uretrografía .....	66-09
KOCHER	
espatula vesical .....	66-04
pinza hemostática delgada .....	12-06
pinza intestinales .....	64-04
separador .....	18-10 hasta 18-11
sonda bocio .....	54-04
KOENIG	
aguja para sutura .....	26-06
sonda conductora .....	26-04
KOERTE separador .....	18-11
KOGAN especulo endocervicales .....	70-23
KONRICH tambor para esterilización .....	88-12
KRAUSE	
cierranudo auriculares .....	44-07
cierranudos para nasales .....	46-09
pinza laringe .....	52-03
KRISTELLER	
especulo vaginales .....	70-09 hasta 70-14
valva vaginales .....	70-09 hasta 70-14
KRONECKER aguja para ligaduras .....	26-02
KUENTSCHER	
dilatador .....	33-13
extractador .....	33-13
impactor .....	33-13
KUHNT legra para la cornea .....	42-05
L	
LABORDE dilatador traqueal .....	54-02
LAFORCE	
adenotomo .....	46-19
instrument para cuerpos extraños .....	42-06
LAGRANGE tijeras para encías .....	08-41
LAHEY	
pinza agarrar bocio .....	54-04
pinza via billar .....	12-14
separador .....	18-08
LAMBERT KAY	
pinza atraumatica anastomosis de aorta .....	BD-10
pinza atraumatica iliaca .....	BD-11
LAMBERT pinza chalazión .....	43-06
LAMBOTTE mini osteotomo .....	32-15
LAMBOTTE	
osteotomo .....	32-15
periostotomo .....	32-19
pinza para huesos .....	32-08
Lámpara frontal CLAR .....	02-05
LANCASTER blefarostato .....	42-03
Lanceta electrodo .....	JA-03
LANDAU especulo vaginales .....	70-22

LANDOLT					
mango de bisturíes micro.....	06-13				
tijeras enucleación.....	08-25				
LANE					
destornillador.....	33-14				
pinza clamp estomacales.....	64-08				
pinza de disección.....	10-04				
pinza para campos.....	14-05				
pinza para huesos.....	32-08				
pinza para sostener placas.....	33-14				
pinza para sostener tornillo.....	33-14				
LANG cureta.....	42-08				
LANGENBECK					
cuchillo para resección.....	06-17				
dedal.....	48-06				
elevador.....	32-21				
periotóstomo.....	32-19				
pinza para huesos.....	32-07				
separador.....	18-09				
sierra a dedo.....	33-03				
LANGE					
pinza laríngea.....	52-03				
tijeras de vendajes.....	08-44				
Lanzapalvo KABERSKE.....	44-04				
Laringoscopia conjuntos					
MACINTOSH convencional AE-18 hasta AE-19					
MACINTOSH de fibra óptica AE-12 hasta AE-13					
MILLER convencional..... AE-18 hasta AE-19					
MILLER de fibra óptica..... AE-12 hasta AE-13					
Laringoscopia espátulas					
MACINTOSH convencional..... AE-15					
MACINTOSH de fibra óptica..... AE-10					
MILLER convencional..... AE-16					
MILLER de fibra óptica..... AE-10					
Laringoscopia mango convencional..... AE-17					
Laringoscopia mango de fibra óptica..... AE-11					
LAWRENCE pinza de disección y ligadura..... 12-13					
LEBSCHKE cincel esternon..... 32-17					
LEES pinza atraumática bronquiales..... BD-03					
Legra KUHN para la córnea..... 42-05					
LEGUEU					
espátula vesical..... 66-04					
separador vesicales..... 66-06					
LEKSELL STILLE pinza gubia..... 32-05					
LELAND JONES pinza atraumática para vasos perif..... BD-08 hasta BD-09					
LEMPERT					
cucharilla cortante..... 32-13					
elevador..... 44-15					
pinza gubia..... 32-03					
LERICHE pinza de disección..... 10-04					
LERICHE pinza hemostática..... 12-09					
LESTER pinza fijación..... 43-03					
LEVINSON aguja para cuerpos extraños..... 42-05					
LEWIN pinza para huesos..... 32-10					
LEWKOWITZ pinza para aborto y placenta..... 72-07					
LEXER-BABY					
tijera de disección..... 08-12					
tijeras..... 07-10					
LEXER					
cincel..... 32-16					
LEXER-FINO tijera de disección..... 08-12					
LEXER					
gubia..... 32-16					
LEXER mini					
cincel..... 32-16					
gubia..... 32-16					
LEXER					
tijeras..... 07-09					
tijeras de disección..... 08-11					
LEYLA sistema de fijación..... EA-14 hasta EA-18					
LICHTWITZ					
aguja..... 46-09					
trócar..... 22-02					
LIDDLE pinza atraumática aorta..... BD-10					
Lima					
FOMON para nasales..... 46-15 hasta 46-16					
GALLAHER para seno..... 46-16					
JOSEPH (LEWIS) para nasales..... 46-15					
JOSEPH para huesos..... 46-14					
MALTZ (COTTLE) para nasales..... 46-15					
MALTZ para nasales..... 46-14					
para huesos..... 32-25					
para unas..... 74-03					
PUTTI para huesos..... 32-25					
WIENER (AUFRIEHT) para nasales..... 46-15					
WIENER para el seno..... 46-15					
LISTER-BURCH blefarostato..... 42-02					
LISTER					
pinza para seno, porta esponjas..... 16-11					
tijeras de vendajes..... 07-23, 08-45					
LITTON					
cuchillo para amputación..... 06-16					
pinza cortante para huesos..... 32-06					
LITTAUER					
pinza auriculares..... 44-08					
pinza depilatorias..... 43-08					
pinza polipus para nasales..... 46-05					
tijeras para puntas..... 08-40					
LITTLER tijera de disección..... 08-13					
LITTLE separador..... 18-08					
Llave..... 33-10					
LOCKLIN tijera..... 08-18					
LORENZ tijeras de vendajes..... 08-47					
LORNA pinza para campos..... 14-04					
LOUTE tensor cierra-hilo..... 33-11					
LOVE					
gancho para nervios..... EA-04					
LOVE-GRUENWALD pinza cortantes para laminectomía..... EA-08					
LOVELACE					
pinza hemostática..... 12-07					
pinza para coger el pulmón..... FG-19					
LOVE					
separador uvula..... 50-02					
LOWER pinza via billar..... 12-14					
LOWMAN clamp para huesos..... 32-11					
LUBET-BARBON pinza polipus para nasales..... 46-05					
LUCAE					
diapasones..... 44-04					
martillo..... 32-18					
pinza auriculares..... 44-07					
LUC pinza cortantes para nasales..... 46-06					
LUER-KOERTE cuchara para cálculos biliares..... 62-09					
LUER					
pinza gubia..... 32-03					
tubo traqueal..... 54-03					
LUIKART-BILL tractor adecuada para todas las pinzas con mango..... 72-05					
LUIKART pinza obstétricas..... 72-03					
LUNDSGAARD esclerótomo..... 42-05					
LUNIATSCHEK obturador a gaza..... 50-02					
LURZ pinza para ureter..... 62-10					
M					
MACINTOSH					
laringoscopia conjuntos convencional..... AE-18 hasta AE-19					
laringoscopia conjuntos de fibra óptica..... AE-12 hasta AE-13					
laringoscopia espátulas convencional..... AE-15					
laringoscopia espátulas de fibra óptica..... AE-10					
MAGILL					
estilete para tubo..... 04-04					
tubo de aspiración..... 04-04, 04-06					
MAIER pinza para tapones..... 16-12					
MALTZ					
bisturí cartilage acodado..... 46-11					
MALTZ (COTTLE) lima para nasales..... 46-15					
MALTZ					
lima para nasales..... 46-14					
Mango					
BROCK dilatador para válvula mitral..... FG-26					
CASPAR de bisturíes micro..... 06-12					
COLLIN de bisturíes..... 06-08					
Mango					
de bisturíes..... 06-02 hasta 06-05, 06-07 hasta 06-08					
08					
Mango de bisturíes micro..... 06-12					
Mango					
espejos laríngeos..... 52-04					
GIGLI para sierra..... EA-05					
HUBER universal..... 52-03					
LANDOLT de bisturíes micro..... 06-13					
Mano de plomo..... 32-11					
Manómetro para salpingógrafo..... 70-47					
Marcador					
CASTROVIEJO compas..... 42-09					
CONNIN-AMSLER..... 42-09					
MARSCHIK pinza amígdalas..... 50-04					
MARTEL pinza para pericraneos..... 12-08					
Martillo					
COLLIN..... 32-18					
con ranura..... 33-13					
GERZOG..... 32-18					
KIRK..... 32-18					
LUCAE..... 32-18					
MEAD..... 32-18					
QUISLING..... 32-18					
Martillos					
BABINSKY de percusión..... 02-07					
BERLINER de percusión..... 02-07					
BUCK de percusión..... 02-07					
DEJERINE de percusión..... 02-07					
TAYLOR de percusión..... 02-07					
TRAUBE de percusión..... 02-07					
TROMNER de percusión..... 02-07					
Martillo					
WILLIGER..... 32-18					
MARTIN					
cable electrobisturíes..... JA-07					
histerómetro..... 70-39					
MARTINI cucharilla cortante..... 32-13					
MARTIN					
pelvómetro..... 72-06					
pinza para secuestros..... 32-10					
pinza para tapones..... 16-02, 16-14					
MASSON porta-aguja..... 24-03					
MASTIN pinza muscular..... 54-04					
MATHIEU					
espéculo rectales..... 68-02					
pinza para cuerpos extraños..... 66-07					
porta-aguja..... 24-05					
separador..... 18-03					
MATSON periotóstomo..... 32-21					
MAUNDER garrote madera..... 48-06					
MAYO BLAKE pinza para cálculos biliares..... 62-04					
MAYO					
clip para esterilización..... 28-02					
cuchara para cálculos biliares..... 62-07					
MAY oftalmoscopio..... 02-03					
MAYO-GUYON pinza para pedícula renal..... 12-16					
MAYO-HEGAR porta-aguja..... 24-02					
MAYO-NOBLE tijeras..... 07-08, 08-10					
MAYO-ROBSON pinza intestinales..... 64-05					
MAYO					
sonda para cálculos renales..... 62-10					
MAYO-STILLE tijeras..... 07-07, 08-08 hasta 08-09					
MAYO					
tijeras..... 07-06, 08-07					
tijeras zurdo..... 08-07					
McCLINTOCK pinza para aborto y placenta..... 72-07					
McCULLOUGH pinza para estrabismo..... 42-13					
McDONALD elevador..... 32-22					
McGEE pinza auriculares micro..... 44-10					
McGUIRE tijeras para corneal..... 09-05					
McINDOE					
pinza de disección..... 10-04					
tijeras para cartilago..... 08-35					
McIVOR					
abajalengua..... 48-05					
abreboca..... 48-05					
McKENTY elevadores tabique..... 46-11					
McKENZIE					
perforadores plano..... 33-04					
pinza para poner grapas..... EA-02					

McLEAN pinza obstétricas .....	72-04	sonda para cálculos biliares .....	62-05	gubia .....	32-14
McLEAN-LUIKART pinza obstétricas .....	72-03	MUCK cuchillo periostio .....	44-15	PASSOW hemostata .....	44-15
McLEAN-TUCKER-LUIKART pinza obstétricas .....	72-03	MUELLER blefarostato .....	42-03	PATON disecador para la cornea .....	42-05
McPHERSON pinza ligaduras .....	43-05	MURDOCK blefarostato .....	42-02	PAUFIQUE	
McPHERSON TITAN pinza ligaduras .....	43-05	MURLESS elevador para cabeza .....	72-05	cuchillo para queratoplastico .....	42-05
McPHERSON WESTCOTT tijeras para tenotomia		MURPHY-LANE elevador .....	32-22	pinza ligaduras .....	43-05
09-04		MURPHY pinza para cierra-tubo .....	12-19	PAUFIQUE TITAN pinza ligaduras .....	43-05
MEAD		MUSEUX pinza para coger el cuello de útero	70-33	PAYR-Baby pinza clamp estomacales .....	64-09
martillo .....	32-18	MYLES pinza cortantes para nasales .....	46-07	PAYR	
pinza gubia .....	32-02			pinza clamp estomacales .....	64-09
MEEKER pinza de disección y ligadura .....	12-13			sonda conductora .....	26-04
MELLINGER-AXENFELD blefarostato .....	42-02			PEAN	
MELLINGER blefarostato .....	42-02			pinza atraumatica .....	BD-02
MENGHINI trócar .....	22-03			pinza hemostática .....	12-08
Menisotomo				pinza hemostática delgada .....	12-06
BIRCHER .....	32-24			PEDERSON espéculo vaginales .....	70-03
NEFF .....	32-24			PEERS BERTRAM pinza para campos .....	14-03
SMILLIE .....	32-24			PEET pinza para espinas .....	10-06
MERCEDES separador torácico .....	FG-16			PELKMANN pinza para tapones .....	16-12
METZENBAUM FINO				Pelvimetro	
tijera de disección .....	08-15			COLLIN .....	72-06
tijeras .....	07-12			COLLYER .....	72-06
METZENBAUM				MARTIN .....	72-06
porta-aguja .....	24-04			PENFIELD descolador duramadre .....	EA-06
METZENBAUM "S"				PENNINGTON pinza hemostática .....	12-07
tijera .....	08-16			PERCY retractor para amputacion .....	33-03
tijeras .....	07-13			Perfora-cráneo	
METZENBAUM				NÄGELE .....	72-09
tijera de disección .....	08-13 hasta 08-14			SMELLIE .....	72-09
tijeras .....	07-11			Perforador	
MEYERDING separador .....	18-08			a mano .....	33-05
MEYHOEFER cucharilla para chalazion .....	42-07			BUNNELL a mano .....	33-05
MICHEL				con mandril Jacobs .....	33-06
espejo .....	46-04			CRUTCHFIELD para inicial .....	EA-03
grapas .....	26-07			Perforadores	
pinza para grapas .....	26-07			CUSHING plano .....	33-04
MIDDELDORPF separador .....	18-10			McKENZIE plano .....	33-04
MIDDLETON-JANSEN pinza cortantes para				Perforador	
nasales .....	46-09			HUDSON a mano .....	33-04
MIKULICZ				KIRSCHNER a mano .....	33-05
pinza para peritoneo .....	12-17			MOORE a mano .....	33-04
separador .....	18-12			para clavos .....	33-12
MILLER				RALK a mano .....	33-05
laringoscopia				STILLE a mano .....	33-04
conjuntos convencional...AE-18 hasta AE-19				STILLE-SHERMAN a mano .....	33-04
laringoscopia				Periostótomo	
conjuntos de fibra optica AE-12 hasta AE-13				ALEXANDER .....	32-19
laringoscopia espátulas convencional...AE-16				DOYEN para costillas .....	32-20
laringoscopia espátulas de fibra optica AE-10				FARABEUF .....	32-19
MILLIGAN descolador duramadre .....	EA-05			LAMBOTTE .....	32-19
MILLIN				LANGENBECK .....	32-19
dilatador para el cuello vesical .....	66-07			MATSON .....	32-21
pinza capsulares .....	66-03			OVERHOLT .....	32-21
pinza para lóbulos anteriores .....	66-03			SADILLOT .....	32-19
pinza porta ligaduras .....	66-03			SEMB .....	32-20
Portador de luz fria .....	66-05			WILLIGER .....	32-19
separador vesicales .....	66-05			PERTHES escariadores .....	33-08
MILLS tijeras para vasculares .....	08-27			PESTALOZZA cureta para aborto y placenta .....	72-08
Mini				PETRI cubeta .....	88-08
CLAR .....	02-05			PETZ aparato	
estuche de bolsillo y de sutura .....	26-08			para suturar estomacales e intestinales .....	64-09
MIXTER BABY pinza hemostática bronquial .....	12-13			PHANEUF pinza para peritoneo .....	12-17
MIXTER O'SHAUGNESSY pinza hemostática .....	12-14			Pick .....	44-15
MIXTER				BARBARA .....	44-14 hasta 44-15
pinza hemostática .....	12-14			Piedra afiladora ARKANSAS .....	06-19
pinza hemostática bronquial .....	12-13			PIERCE trócar .....	22-02
pinza para cálculos biliares .....	62-04			PIFFARD cureta para lupus .....	74-02
pinza via billar .....	12-15			PINARD estetoscopio .....	02-06
MOELTGEN goniómetro .....	02-08			Pinza	
MOGAN instrumento para circuncisión .....	66-09			ADLERKREUTZ de disección .....	10-04
MOLLISON separador .....	18-17			ADSON BABY hemostática .....	12-09
MOORE				ADSON-BROWN de disección .....	10-03
cuchara para cálculos biliares .....	62-05			ADSON de disección .....	10-03
perforador a mano .....	33-04			ADSON gubia .....	32-03
MOORFIELD pinza sutura .....	43-05			ADSON hemostática .....	12-09
MORSE-FAVOLORO separador costales .....	FG-17			ADSON micro de disección .....	10-03
MOYNIHAN				ADSON para hipófisis .....	EA-06
pinza para campos .....	14-05			ALEXANDER sacabocado para el cuello del	
pinza via billar .....	12-15			útero .....	70-42

ALLIS-ADAIR para tejidos .....64-02	COLCLOUGH sacabocado	DOUGLAS depilatorias.....43-08
ALLIS-Baby para tejidos .....64-02	para discos intervertebrales.....EA-11	DOYEN-Baby intestinales .....64-03
ALLIS para tejidos .....64-02	COLLIN-DUVAL de disección .....10-04	DOYEN intestinales .....64-03
ARCHER para espinas .....10-06	COLLIN hemostática.....12-08	DOYEN para campos .....14-05
ARRUGA capsulares.....43-04	COLLIN para el útero .....70-37	DOYEN para polipe uterino.....70-36
ASCH enderezar tabique.....46-18	COLLIN para grapas.....26-07	DUPLOY para tapones .....16-14
auriculares micro...44-09 hasta 44-10, 44-12	COLLIN para taponos.....16-11	DUPLOY pra coger el cuello de útero.....70-31
auriculares micro mini .....44-13	COLLIN-POZZI para coger el cuello de útero	DUPUY-WEISS aguja .....50-03
AYER chalazión .....43-06	70-32	DUVAL de disección .....10-04
BABCOCK para tejidos .....64-02	COLLIN tiralengua .....48-03	DUVAL para tejidos.....64-03
BACKHAUS-CLIP para campos con porta-tubo	COLVER coger amígdalas.....50-03	ECHLIN gubia .....32-05
14-03	COOLEY	EDWARDS para applicar clips .....BD-21
BACKHAUS KOCHER para campos.....14-02	atraumatica11-03, BD-35 hasta BD-37, BD-	ELSAESSER para nephrostomíe.....62-13
BACKHAUS para campos.....14-02	39, BD-41	ELSCHNIG capsulares.....43-04
BAGGISH sacabocado para el cuello del útero	COOLEY atraumatica anastomosisBD-37, BD-	ELSCHNIG fijación .....43-03
70-45	40	EPPENDORFER-KEVORKIAN
BAINBRIDGE atraumatica .....BD-09	COOLEY atraumatica iliaca .....BD-37	sacabocado para el cuello del útero ..70-46
BAINBRIDGE hemostática .....12-14	COOLEY atraumatica pediátricasBD-38 hasta	EPPENDORFER
BALL AND SOCKET para campos.....14-04	BD-39	sacabocado para el cuello del útero70-45
BALLENGER coger amígdalas .....50-04	COOLEY DERRA atraumatica anastomosisBD-	hasta 70-46
BARRAQ.KATZIN para iris.....42-13	39	EPPENDORFER TISCHLER-MORGAN
BARRAQU Colibri para iris.....42-13	COOLEY para vascular .....BD-40	sacabocado para el cuello del útero ..70-46
BARRAQUER cámara anterior .....43-02	CORDES laringe.....52-03	FARABEUF-LAMBOTTE para huesos.....32-08
BARRAQUER depilatorias .....43-08	corta-hilo.....33-12	FARABEUF para huesos .....32-07
BARRAQUER fijación.....43-03	COTTLE-KAZANJIAN cortante para huesos32-	FAURE para peritoneo.....12-17
BARRETT pra coger el cuello de útero ...70-32	06	FAURE sacabocado para el cuello del útero70-
BECK atraumatica para vasculares perifBD-25	CRAFOORD hemostática bronquial.....12-12	41
BEER depilatorias.....43-08	CRILE hemostática .....12-05	FEHLAND intestinales .....64-06
BENGOLEA hemostática .....12-09	CRILE-RANKIN hemostática .....12-05	FEILCHENFELD para espinas .....10-06
BERGMANN FOERSTER porta esponjas 16-10	CRILE TITAN hemostática .....12-05	FERGUSON hemostática .....12-07
BERKE muscular .....43-02	CRUTCHFIELD de tracción craneal.....EA-03	FERGUSON para huesos .....32-07
BERNHARD para campos .....14-05	CUSHING cortantes para laminectomía EA-08	FERRIS de disección .....10-04
BEST intestinales .....64-06	CUSHING de disección .....10-03	FERRIS-SMITH cortantes para laminectomíaEA-
BEYER gubia .....32-04	CZERNY para cálculos biliares .....62-03	09
BEYER sacabocado .....46-08	CZERNY pra coger el cuello de útero.....70-34	FERRIS-SMITH-KERRISON
BIRCHER-GANSKE para huesos.....32-10	DALE atraumatica para vasculares perifBD-24	sacabocado para discos intervertebralesEA-
BISHOP-HARMAN para iris .....42-14	DANDY hemostática .....12-07	10
BLAKE para cálculos biliares.....62-03	DARDIK atraumatica.....BD-07	FINOCHIETTO bronquiales.....FG-21
BLOHMKE coger amígdalas.....50-04	DARTIGUES para el útero .....70-37	FISCHER para iris .....42-13
BLUMENTHAL gubia .....32-02	DASTOOR para estrabismo .....42-14	FLETCHER JAVERTS porta esponjas .....16-10
BÖHLER cortante para huesos .....32-06	DAVIS para esterilización .....28-02	Pinza flexibles para vascularesBD-44 hasta BD-45
BÖHLER gubia .....32-04	DE BAKEY atraumatica .....11-03	Pinza
BONACCOLTO para estrabismo .....42-14	DEBAKEY atraumatica .....BD-02, BD-08	FOERSTER para iris.....42-12
BONNEY porta esponjas.....16-08	DE BAKEY atraumatica .....BD-16 hasta BD-17	FOERSTER porta esponjas .16-06 hasta 16-08
Bonn para iris .....42-15	DEBAKEY atraumatica .....BD-20	FRAENKEL laringe.....52-03
Bonn TITAN para iris.....42-15	DE BAKEY atraumatica .....BD-28 hasta BD-30	FRAENKEL polipus laringe .....52-02
BOZEMANN-DOUGLAS para tapones..16-13	DE BAKEY atraumatica anastomosis.....BD-25	FRIEDMAN gubia .....32-02
BOZEMANN para tapones.....16-13	DE BAKEY atraumatica	FRIEDMAN MINI gubia, mini .....32-02
BRAIN MINI de aplicación clip .....EA-12	aneurisma de aorta ...BD-13, BD-15, BD-18	FRYKHOLM gubia .....32-05
BRAIN STANDARD de aplicación clip...EA-12	DE BAKEY atraumatica bronquiales .....BD-19	FUCHS capsulares.....43-04
BRAUN para coger el cuello de útero70-31,	DE BAKEY atraumatica	GAUSS para pericraneos.....72-06
70-34	de disección y ligadura .....BD-25, BD-32	GELLHORN sacabocado para el cuello del
BROWN de disección .....10-03	DE BAKEY atraumatica iliaca .....BD-11	útero .....70-42
BRUENINGS cortantes para nasales .....46-05	DE BAKEY atraumatica para vasculares perif	GEMINI de disección y ligadura .....12-10
BRUENINGS laringe .....52-03	BD-06	GEMINI MINI de disección y ligadura ..12-10
BRUNNER intestinales .....64-06	DEBAKEY BAHNSON atraumatica	GERALD de disección .....10-05
BRYANT porta esponjas.....16-11	aneurisma de aorta .....BD-14	GILL-ARRUGA capsular .....43-03
BUMM para el útero .....70-38	DE BAKEY MORRIS atraumatica .....BD-16	GILL-HESS para iris .....42-12
BURKE-Baby sacabocado para el cuello del	DE BAKEY REYNOLDS atraumatica	GILLIES de disección .....10-05
útero.....70-44	anastomosis.....BD-30	GILL para iris.....42-12
BURKE sacabocado para el cuello del útero70-	DEBAKEY SATINSKY atraumatica .....BD-22	GLOVER atraumatica.....BD-06, BD-30
44	Pinza de disección .....10-02	GLOVER atraumatica anastomosis .....BD-05
CARMALT para espinas .....10-06	Pinza	GLOVER para coarctación atraumatica .BD-04
CASTAÑEDA atraumatica para nacidos y	DeMARTEL-WOLFSON para anastomosis64-	GRADLE depilatorias .....43-08
niños .....BD-42	07	GRAEFE de disección .....10-03
CASTROVIEJO capsulares.....43-04	depilatorias.....43-08	GRAEFE fijación .....43-03
CASTROVIEJO fijación .....43-03	Pinza de relojero .....10-06	GRAEFE para iris.....42-11
CASTROVIEJO sutura .....43-05	Pinza	GRAY via billar .....12-15
CHAPUT hemostática .....12-08	DERRA atraumatica anastomosis, pediátricas	GREEN fijación .....43-03
CHEATLE para esterilización .....28-02	BD-28	GREGORY atraumatica profunda.....BD-33
CHERON para tapones .....16-12	DESJARDINS para cálculos biliares .....62-02	GREVEN auriculares micro.....44-10
CHEVALIER-JACKSON laringe .....52-04	DESJARDINS via billar.....12-15	GRIP para agarrar .....33-11
CHILDE para grapas .....26-07	DESMARRES chalazión.....43-06	GROSS-MAIER para tapones16-02 hasta 16-
CITELLI sacabocado .....46-08	DeVILBISS cranea .....EA-05	04
Pinza-clamp GREEN-ARMYTAGE uterina	DIAMANT corta-hilo .....33-12	GROSS para tapones.....16-05
para hemostasis .....72-06	DIETER la cabeza del martillo.....44-10	GUYON para pedícula renal .....12-16
Pinza	DIETHRICH atraumatica .....BD-31	HAJEK-CLAUS seno maxil .....46-08
CLEVELAND gubia .....32-02	DIMEDA para desechos .....28-03	HAJEK-KOFLER sacabocado .....46-08
coagulación bipolar.....JA-04 hasta JA-06	DINGMANN para huesos .....32-10	HALSTEAD-MOSQUITO atraumatica .....BD-02



HALSTEAD-MOSQUITO hemostática	12-04
HALSTEAD-MOSQUITO micro hemostática	12-04
HALSTEAD-MOSQUITO TITAN hemostática	12-04
HARKEN atraumática aurícula	BD-23
HARRINGTON bronquiales	FG-21
HARTMANN auriculares	44-08
HARTMANN cortantes para nasales	46-07
HARTMANN hemostática	12-03
HARTMANN-HOFFMANN auriculares	44-08
HARTMANN polipus para nasales	46-04
HARTMANN-WULLSTEIN auriculares	44-08
HEANEY histerectomía	12-18
HEGENBARTH para grapas	26-07
HEIMING para cálculos renales	62-13
HEISS hemostática	12-09
HENROTIN pra coger el cuello de útero	70-34
HERRICK para peritoneo	12-17
HESS capsulares	43-04
HESS para iris	42-12
HEYMANN cortantes para nasales	46-05
HEYMANN-KNIGHT polipus para nasales	46-05
HEYWOOD-SMITH emorroidal	68-05
HOFF para campos	14-03
HOLTH para capsulairidectomía	42-09
HUNTER para espinas	10-06
IOWA pra coger el cuello de útero	70-35
JACKSON tapones	52-02
JACOBS pra coger el cuello de útero	70-34
JAMESON para estrabismo	42-13
JANSEN para nasales	46-04
JARCHO pra coger el cuello de útero	70-32
JATHO nasofaringe	46-18
JAVID atraumática carótis	BD-32
JOHNS-HOPKINS via billar	12-14
JONES para campos con porta-tubo	14-02
JUDD-ALLIS para tejidos	64-02
JURASZ polipus laringe	52-02
KALT capsulares	43-04
KELLY hemostática	12-05
KELLY para polipe uterino	70-36
KELLY-RANKIN hemostática	12-05
KELLY TITAN hemostática	12-05
KERN para huesos	32-08
KERRISON sacabocado	46-08
KEVORKIAN-Pacific	
sacabocado para el cuello del útero	70-44
KEVORKIAN	
sacabocado para el cuello del útero	70-43, 70-46
KIRBY-ARTHUR para iris	42-13
KNAPP-LUER tracoma	43-06
KNIGHT cortantes para nasales	46-05
KOCHER hemostática delgada	12-06
KOCHER intestinales	64-04
KRAUSE laringe	52-03
LAHEY agarrar bocio	54-04
LAHEY via billar	12-14
LAMBERT chalazión	43-06
LAMBERT KAY atraumática anastomosis de aorta	BD-10
LAMBERT KAY atraumática iliaca	BD-11
LAMBOTTE para huesos	32-08
LANE clamp estomacales	64-08
LANE de disección	10-04
LANE para campos	14-05
LANE para huesos	32-08
LANE para sostener placas	33-14
LANE para sostener tornillo	33-14
LANGÉ laringe	52-03
LANGENBECK para huesos	32-07
LAWRENCE de disección y ligadura	12-13
LEES atraumática bronquiales	BD-03
LEKSELL STILLE gubia	32-05
LELAND JONES	
atraumática para vasculares	BD-08 hasta BD-09

LEMPERT gubia	32-03
LERCHE de disección	10-04
LERICHE hemostática	12-09
LESTER fijación	43-03
LEWIN para huesos	32-10
LEWKOWITZ para aborto y placenta	72-07
LIDDLE atraumática aorta	BD-10
LISTER para seno, porta esponjas	16-11
LISTON cortante para huesos	32-06
LITTAUER auriculares	44-08
LITTAUER depilatorias	43-08
LITTAUER polipus para nasales	46-05
LORNA para campos	14-04
LOVE-GRUENWALD cortantes para laminectomía	EA-08
LOVELACE hemostática	12-07
LOVELACE para coger el pulmón	FG-19
LOWER via billar	12-14
LUBET-BARBON polipus para nasales	46-05
LUCAE auriculares	44-07
LUC cortantes para nasales	46-06
LUER gubia	32-03
LURZ para ureter	62-10
MAIER para tapones	16-12
MARSHIK amigdalas	50-04
MARTEL para pericraneo	12-08
MARTIN para secuestros	32-10
MARTIN para tapones	16-02, 16-14
MASTIN muscular	54-04
MATHIEU para cuerpos extraños	66-07
MAYO BLAKE para cálculos biliares	62-04
MAYO-GUYON para pedícula renal	12-16
MAYO-ROBSON intestinales	64-05
McCLINTOCK para aborto y placenta	72-07
McCULLOUGH para estrabismo	42-13
McGEE auriculares micro	44-10
McINDOE de disección	10-04
McKENZIE para poner grapas	EA-02
McPHERSON ligaduras	43-05
McPHERSON TITAN ligaduras	43-05
MEAD gubia	32-02
MEEKER de disección y ligadura	12-13
MICHEL para grapas	26-07
Pinza micro	11-02
Pinza	
MIDDLETON-JANSEN cortantes para nasales	46-09
MIKULICZ para peritoneo	12-17
MILLIN capsulares	66-03
MILLIN para lóbulos anteriores	66-03
MILLIN porta ligaduras	66-03
MIXTER BABY hemostática bronquial	12-13
MIXTER hemostática	12-14
MIXTER hemostática bronquial	12-13
MIXTER O'SHAUGNESSY hemostática	12-14
MIXTER para cálculos biliares	62-04
MIXTER via billar	12-15
MOORFIELD sutura	43-05
MOYNIHAN para campos	14-05
MOYNIHAN via billar	12-15
MURPHY para cierra-tubo	12-19
MUSEUX pra coger el cuello de útero	70-33
MYLES cortantes para nasales	46-07
NEGUS para amigdalas	50-03
NELSON de disección	10-05
NEUBÜSER para sostener trompas	70-51
NOTO para polipe uterino	70-36
NOYES polipus para nasales	46-05
OCHSNER atraumática aorta	BD-31
OLDBERG cortantes para laminectomía	EA-09
OLIVECRONA gubia	32-03
OLIVECRONA-TOENNIS para poner grapas	EA-02
OVERHOLT-GEISSENDOERFER de disección y ligadura	12-10
Pinza para campos modelo delicato	14-02
Pinza para cierra-tubo	12-19
Pinza	
para cortar y alambre	33-11

Pinza para espinas	10-06
Pinza para esterilización	28-02
Pinza	
para fijar	66-10
para fijar el cordón espermático	66-10
Pinza para huesos	32-09 hasta 32-10
Pinza para secuestros	32-10
Pinza	
para unas	74-03
PAUFIQUE ligaduras	43-05
PAUFIQUE TITAN ligaduras	43-05
PAYR-Baby clamp estomacales	64-09
PAYR clamp estomacales	64-09
PEAN atraumática	BD-02
PEAN hemostática	12-08
PEAN hemostática delgada	12-06
PEERS BERTRAM para campos	14-03
PEET para espinas	10-06
PELKMANN para tapones	16-12
PENNINGTON hemostática	12-07
PHANEUF para peritoneo	12-17
picos planos	33-11
POTTS atraumática	BD-26 hasta BD-27
POTTS atraumática anastomosis	BD-04
POTTS para coarctación atraumática	BD-04
POTTS-SMITH de disección	10-02
POZZI para coger el cuello de útero	70-31
PRATT hemostática	12-08
PRATT para coger el cuello de útero	70-34 hasta 70-35
PRESBYTERIAN HOSPITAL para cierra-tubo	12-19
PRICE-THOMAS bronquiales	FG-22
PRINCE muscular	43-02
PROVIDEN24-HOSPITAL hemostática	12-05
RADOLF para unas	33-03
RAMPLEY porta esponjas	16-09
RANDALL para cálculos renales	62-11 hasta 62-12
RANEY hemostática para cuero cabell	EA-03
RANEY para poner y quitar	EA-03
RANKIN atraumática	BD-02
RICHTER-HEATH para grapas	26-07
ROBERTS hemostática	12-11
ROCHESTER-CARMALT hemostática	12-07
ROCHESTER-OCHSNER hemostática	12-06
ROCHESTER-PEAN hemostática	12-06
ROEDER para campos	14-03
ROGGE para esterilización	28-02
ROSENBERG laringe	52-03
ROWE boca	48-06
RUBIN para magullar tabique	46-07
RUMEL para torácica	12-11
RUSKIN gubia	32-04
RUSKIN-LISTON cortante para huesos	32-06
RUSSIAN de disección	10-04
SAENGER para aborto y placenta	72-07
SAIRGES pra coger el cuello de útero	70-32
SAROT bronquiales	FG-23
SAROT hemostática bronquial	12-12
SATINSKI atraumática	BD-20
SATINSKY	
para anastomosis (vena cava)	FG-24 hasta FG-25
Pinzas atraumáticas, pediátricas, vasculares	BD-43
Pinza	
SAUERBRUCH gubia	32-05
SAUERBRUCH para desechos	28-03
SAWTELL para amigdalas	50-03
SCAGLIETTI gubia	32-05
SCHEINMANN laringe	52-03
SCHNIDT para amigdalas	50-03
SCHOENBURG para tejidos	64-03
SCHROEDER	
para coger el cuello de útero	70-31 hasta 70-32
SCHUBERT sacabocado para el cuello del útero	70-41
SCHUMACHER laringe	52-03

SCHUMACHER sacabocado para el cuello del útero.....	70-43	WACHENFELDT para grapas.....	26-07	POTTS-SMITH pinza de disección.....	10-02
SCHWEIGGER capsulares.....	43-04	WAGNER cortantes para laminectomía.EA-09		tijeras para vasculares.....	07-19, 08-28
SEIFFERT laringe.....	52-03	WALSHAM enderezar tabique.....	46-18	POZZI pinza pra coger el cuello de útero...	70-31
SEMB bronquiales.....	FG-23	WANGENSTEEN de disección.....	10-05	Pinza para unas.....	74-03
SEMB cortante para huesos.....	32-07	WEBER atraumatica.....	BD-12	PRATT dilatador uterinos.....	70-29
SEMB gubia.....	32-06	WEIL-BLAKESLEY cortantes para nasales	46-06	espéculo rectales.....	68-02
SEMB para huesos.....	32-07	WEISS para cierra-tubo.....	12-19	gancho cístico.....	68-04
SEMKEN de disección.....	10-05	WERTHEIM-CULLEN histerectomía.....	12-18	pinza hemostática.....	12-08
SIEGLER HELLMANN para el útero.....	70-38	WERTHEIM histerectomía.....	12-18	pinza pra coger el cuello del útero	70-34 hasta 70-35
SIMS-MAIER para tapones.....	16-05	WHITE coger amígdalas.....	50-03	PRESBYTERIAN HOSPITAL pinza para cierra-tubo.....	12-19
SINGLEY de disección.....	10-05	WILDE (TROELTSCH) auriculares.....	44-07	PRICE-THOMAS pinza bronquiales.....	FG-22
SKENE para coger el cuello de útero.....	70-31	WILLET-MARTELL para pericraneos.....	12-08	PRINCE pinza musculares.....	43-02
SMITHWICK para poner grapas.....	EA-02	WILLIAMS para tejidos.....	64-03	tijeras para amígdalas.....	08-27
SNELLEN entropión.....	43-06	WINTER para aborto y placenta.....	72-07	Proctoscopio KELLY.....	68-04
SOMER para el útero.....	70-37	WITTNER sacabocado para el cuello del útero	70-43	Protector ARRUGA.....	42-08
SPENCER-WELLS hemostática.....	12-07	WOLFF para romper yesos.....	30-04	de tejido.....	33-15
SPURLING cortantes para laminectomía	EA-08	WYLIE atraumatica.....	BD-21	PROVIDEN24-HOSPITAL pinza hemostática.	12-05
STAUDE-MOORE para coger el cuello de útero	70-31	YEOMAN sacabocado para biopsia.....	68-05	PUTTI lima para huesos.....	32-25
STEVENS para iris.....	42-11	YOUNG para coger prostata.....	66-02	Q	
STIEGLITZ para espinas.....	10-06	YOUNG firalengua.....	48-03	QUATTRO separador para yesos.....	30-03
STILLE de disección.....	10-02	ZAUFAL-JANSEN gubia.....	32-04	Queratomo BERENS.....	42-04
STILLE-HORSLEY cortante para huesos.....	32-07	ZENKER de disección y ligadura.....	12-12	CASTROVIEJO.....	42-04
STILLE-LISTON cortante para huesos.....	32-06	PIPER pinza obstétricas.....	72-04	JAEGER.....	42-04
STILLE-LUER gubia.....	32-04	pinza obstétricas con dispositivo de tracción	72-04	QUINBY tijeras para encías.....	08-42
STILLE para pedícula renal.....	12-16	Placa JAEGER para párpados.....	42-03	QUINKE aguja para punción.....	22-03
STILLE-RUSKIN gubia.....	32-05	Placa para extender la piel.....	06-21	QUIRE elevadores cuerpos extraños.....	44-08
St. MARTIN sutura.....	43-05	PLESTER cuchillo lobar.....	44-14	QUISLING martillo.....	32-18
STONE para cerrar.....	64-06	separador.....	18-14	Quistotomo BECKER.....	42-06
STONE-WATT intestinales.....	64-06	POLITZER aguja paracentesis.....	44-06	GRAEFE.....	42-06
STRUEMPEL auriculares.....	44-08	cuchillo auriculares.....	44-06	Quita hojas.....	06-06, 06-10
STRUYCKEN cortantes para nasales.....	46-07	insuflador de aire.....	44-05	R	
SUBRAMANIAN atraumatica.....	BD-31	POOLE tubo de aspiración.....	04-02	RADOLF pinza para unas.....	33-03
SWEET para poner grapas.....	EA-02	Porta-aguja ADSON.....	24-04	RALK perforador a mano.....	33-05
TEALE para coger el cuello del útero.....	70-33	ARRUGA de oftalmología.....	24-06	RAMPLEY pinza porta esponjas.....	16-09
TERSON capsulares.....	43-04	BARRAQUER.....	24-07	RANDALL cureta aspiradoras para la biopsia	uterina
THOMS-ALLIS para tejidos.....	64-02	BAUMGARTNER.....	24-02	40 pinza para cálculos renales	62-11 hasta 62-12
THOMS-GAYLOR sacabocado para el cuello del útero.....	70-42	BOYNTON de oftalmología.....	24-06	RANEY pinza hemostática para cuero cabell	EA-03
TIEMANN para coger el cuello del útero	70-32	BOZEMANN.....	24-03	pinza para poner y quitar.....	EA-03
TILLEY auriculares.....	44-08	CASTROVIEJO.....	24-07	RANKIN pinza atraumatica.....	BD-02
TISCHLER-KEVORKIAN sacabocado para el cuello del útero	70-44 hasta 70-45	COLLIER.....	24-02	Raquiotomo.....	32-17
TISCHLER-MORGAN sacabocado para el cuello del útero	70-43 hasta 70-44, 70-46	CRILE.....	24-04	RECAIMER cureta uterinas.....	70-49 hasta 70-50
TIVNEN coger amígdalas.....	50-04	CRILE-MURRAY.....	24-02	Rectoscopio luz fría.....	68-03
TOENNIS hemostática.....	12-11	CRILE-WOOD.....	24-02	Regla de metal.....	02-08
TOHOKU para campos.....	14-04	DE BAKEY.....	24-03	REICHERT depresor epiglotis.....	52-02
TOWNSEND-KEVORKIAN sacabocado para el cuello del útero.....	70-44	DERF.....	24-02	REINER cuchillo para yesos.....	30-04
TOWNSEND-MINI (BABY TISCHLER) sacabocado para el cuello del útero	70-45	DIETHRICH para vascular.....	24-06	jeringa auriculares.....	44-05
TOWNSEND-mini sacabocado para el cuello del útero.....	70-44	FINOCHIETTO.....	24-04	Retractor PERCY para amputacion.....	33-03
TOWNSEND sacabocado para el cuello del útero.....	70-44	GILLIES.....	24-05	REVERDIN aguja para ligaduras.....	26-03
TOWNSEND-TISCHLER sacabocado para el cuello del útero.....	70-44	HALSEY.....	24-02	separador.....	18-04
TROELTSCH para nasales.....	46-04	HEANEY.....	24-03	REYNOLDS tijera.....	08-18
TROUTMAN Colibri para iris.....	42-13	HOESEL.....	24-05	tijeras.....	07-15
TROUTMAN rectus.....	43-02	JAMISON.....	24-03	RIBBON separador.....	18-04
Tübingen ligaduras.....	43-05	JOHNSON.....	24-04	RICHARDSON-EASTMAN separador.....	18-04
Tübingen para iris.....	42-15	KALT.....	24-07	RICHARDSON Grip separador.....	18-04
Tübingen TITAN ligaduras.....	43-05	KALT-ARRUGA.....	24-07	RICHARDSON separador.....	18-04
Tübingen TITAN para iris.....	42-15	MASSON.....	24-03	RICHTER-HEATH pinza para grapas.....	26-07
TUFFIER hemostática.....	12-08	MATHIEU.....	24-05	RIGBY separador abdominales.....	18-24
TURNBULL para unas.....	74-03	MAYO-HEGAR.....	24-02	Riñonera.....	88-07
TURREL sacabocado para biopsia.....	68-05	METZENBAUM.....	24-04	ROBB disector para vasculares.....	FG-33
TYDING coger amígdalas.....	50-04	NEIVERT.....	24-02	ROBERTS pinza hemostática.....	12-11
ULRICH porta esponjas.....	16-06	OLSEN-HEGAR.....	24-05	ROCHESTER-CARMALT pinza hemostática	12-07
UNIVERSAL para esterilización.....	28-02	RYDER.....	24-03	ROCHESTER-OCHSNER pinza hemostática	12-06
USA de disección.....	10-02	SAROT.....	24-04	ROCHESTER-PEAN pinza hemostática.....	12-06
VAN BUREN para secuestrós.....	32-10	STEVENS de oftalmología.....	24-06		
van DOREN sacabocado para el cuello del útero.....	70-42	STRATTE.....	24-04		
VERBRUGGE para huesos.....	32-09	TOENNIS.....	24-04		
VIRTUS (RALK) para espinas.....	10-06	WANGENSTEEN.....	24-03		
		Portador MILLIN de luz fría.....	66-05		
		POTTS DE MARTEL tijeras para vasculares	08-27		
		POTTS pinza atraumatica.....	BD-26 hasta BD-27		
		pinza atraumatica anastomosis.....	BD-05		
		pinza para coarctación atraumatica.....	BD-04		

ROEDER pinza para campos.....	14-03
ROGER elevadores tabique.....	46-11
ROGGE pinza para esterilización.....	28-02
ROLLET	
cincel para extirpacion.....	42-06
separador.....	42-06
Rompecraneo VIRCHOW.....	32-17
Rompe hojas	
CASTROVIEJO.....	06-14
DIMEDA.....	06-14
TROUTMAN-CHRIS.....	06-14
ROSE gancho traqueal.....	54-03
ROSEN	
aguja.....	44-14 hasta 44-15
ROSENBERG pinza laringe.....	52-03
ROSEN	
cuchillo circular.....	44-14
ROSER-KOENIG abreboca.....	48-03
ROUX BABY separador.....	18-02
ROUX MINI separador.....	18-02
ROUX separador.....	18-02
ROWE pinza boca.....	48-06
RUBIN pinza para magullar tabique.....	46-07
RUMEL pinza para toracica.....	12-11
RUSKIN-LISTON pinza cortante para huesos.....	32-06
RUSKIN pinza gubia.....	32-04
RUSSIAN pinza de disección.....	10-04
RYDEL-SEIFFER diapasones.....	44-04
RYDER porta-aguja.....	24-03
<b>S</b>	
SAALFELD saca comedones.....	74-02
Saca	
SAALFELD comedones.....	74-02
SCHAMBERG comedones.....	74-02
UNNA comedones.....	74-02
WALTON comedones.....	74-02
SACHS	
descolador duramide.....	EA-05
gancho para nervios.....	EA-04
SADILLOT periostótomo.....	32-19
SAENGER pinza para aborto y placenta.....	72-07
SAIRGES pinza para coger el cuello del útero.....	70-32
Salpingógrafa SCHULTZE.....	70-47
SANVENERO	
tijera.....	08-16
tijeras.....	07-13
SAROT	
pinza bronquiales.....	FG-23
pinza hemostática bronquial.....	12-12
porta-aguja.....	24-04
SATINSKI pinza atraumatica.....	BD-20
SATINSKY	
pinza para anastomosis (vena cava).....	FG-24 hasta FG-25
tijeras para toracica.....	08-37
SATO cuchillo para corneal.....	42-05
SAUERBRUCH	
caja para agujas.....	88-02
costotomo.....	FG-05
SAUERBRUCH-FREY costotomo.....	FG-06
SAUERBRUCH	
pinza gubia.....	32-05
pinza para desechos.....	28-03
separador.....	18-13
SAWTELL pinza para amigdalas.....	50-03
SCAGLIETTI pinza gubia.....	32-05
SCHAMBERG saca comedones.....	74-02
SCHUDE cucharilla cortante.....	32-12
SCHIE	
canula oculares.....	43-07
cuchillo para goniotomia.....	42-05
SCHNEIMANN pinza laringe.....	52-03
SCHERBAK espéculo vaginales.....	70-21
SCHIMMELBUSCH tambor para esterilización.....	88-12
SCHINK dermatótomos.....	06-21
SCHIOETZ tonómetro.....	43-08

SCHMIEDEN-PAYR sonda conductora.....	26-04
SCHMIEDEN sonda conductora.....	26-04
SCHMIEDEN-TAYLOR tijeras.....	08-36
SCHNIDT pinza para amigdalas.....	50-03
SCHOENBORN separador tiroide.....	54-04
SCHOENBURG pinza para tejidos.....	64-03
SCHROEDER	
cureta uterinas.....	70-48
pinza para coger el cuello del útero.....	70-31 hasta 70-32
SCHUBERT pinza sacabocado para el cuello del útero.....	70-41
SCHUKNECHT	
cuchillo circular.....	44-14
cuchillo forma hoz.....	44-14
SCHULTZE salpingógrafa.....	70-47
SCHUMACHER	
pinza laringe.....	52-03
pinza sacabocado para el cuello del útero.....	70-43
tijera para esternón.....	FG-07
tijeras para umbilicales.....	08-34
SCHWEIGER pinza capsulares.....	43-04
SEEMANN-SEIFFERT abreboca.....	48-04
SEGOND bisturí para fibroma.....	70-46
SEIFFERT pinza laringe.....	52-03
SELLHEIM separador para la salida de la cabeza.....	72-09
SELLORS aproximadore para costillas.....	FG-18
SEMB	
periostótomo.....	32-20
pinza bronquiales.....	FG-23
pinza cortante para huesos.....	32-07
pinza gubia.....	32-06
pinza para huesos.....	32-07
SEMKEN pinza de disección.....	10-05
SEMM espéculo vaginales.....	70-07
SENN-GREEN separador.....	18-07
SENN separador.....	18-04
Sensímetro WARTENBERG.....	02-08
Separador.....	18-06, 18-10
ADSON.....	18-15
ADSON Baby.....	18-15
ALM.....	18-14
AUFRIEDT para nasales.....	46-17
BALFOUR abdominales.....	18-22
BALFOUR Baby abdominales.....	18-22
BECKMANN.....	18-16
BECKMANN-ADSON.....	18-15
BECKMANN-EATON.....	18-16
BEESON para yesos.....	30-03
BLOUNT para rodilla.....	32-24
BOSE traqueal.....	54-02
BUNNELL tendones.....	32-25
CASPAR.....	18-20
CASPAR para columna espinal.....	18-18
CASPAR para columna vertebral.....	18-19
CASTANEDA costales.....	FG-14
CHEVALLIER costales.....	FG-15
CLOWARD.....	18-17
CLOWARD para cuerpos vertebrales.....	EA-07
COLLIN abdominales.....	18-24 hasta 18-25
COLLIN-HARTMANN.....	18-03
COOLEY atrium.....	FG-20
COOLEY costales.....	FG-09
COOLEY modif. STRUCK atrium.....	FG-20
CORYLLOS (Thorax).....	18-13
COTTLE-NEIVERT para nasales.....	46-17
COTTLE para nasales.....	46-17
CRILE.....	18-02
CUSHING.....	18-07
DARLING.....	18-17
DAVIDSON (Scapula).....	18-13
DEAVER.....	18-05
DEAVER Grip.....	18-05
de labios y mejillas.....	48-03
DESMARRES.....	18-07
DIMEDA.....	18-14
DOYEN.....	18-12

Separadore	
ALAN-PARKS rectales.....	68-03
SMITH-BUIE rectales.....	68-03
Separador	
FARABEUF.....	18-02
FINOCHIETTO-BABY costales.....	FG-09
FINOCHIETTO BURFORD costales.....	FG-12 hasta FG-14
FINOCHIETTO costales.....	FG-08, FG-10 hasta FG-11
FINOCHIETTO-HAIGHT BABY costales.....	FG-10
FINOCHIETTO INFANT costales.....	FG-12
FINOCHIETTO (modif) costales.....	FG-08
FINSEN.....	18-14
FOMON para nasales.....	46-17
FRAZIER.....	18-21
FRIEDMAN perineorraf.....	70-23
FRITSCH.....	18-11
GELPI abdominales.....	18-24
GOELET.....	18-03
GOSSET abdominales.....	18-21
GREEN.....	18-10
HABERER.....	18-04
HAGLUND-STILLE para yesos.....	30-03
HAIGHT costales.....	FG-15
HARRINGTON.....	18-05
HEANEY.....	18-12
HENNIG para yesos.....	30-03
HERMANN para yesos.....	30-03
HERTZLER costales.....	FG-17
HOFER para pilar.....	50-02
HRYNTSCHAK para prostata.....	66-06
INGE para cuerpos vertebrales.....	EA-07
ISRAEL.....	18-11
JACKSON traqueal.....	54-02
JANSEN.....	18-14
JUDD-MASSON vesicales.....	66-04
KELLY.....	18-04, 18-12
KELLY Grip.....	18-04
KIRSCHNER abdominales.....	18-23
KNAPP.....	42-06
KOCHER.....	18-10 hasta 18-11
KOERTE.....	18-11
LAHEY.....	18-08
LANGENBECK.....	18-09
LEGUEU vesicales.....	66-06
LITTLE.....	18-08
LOVE uvula.....	50-02
MATHIEU.....	18-03
MERCEDES torácico.....	FG-16
MEYERDING.....	18-08
MIDDELORP.....	18-10
MIKULICZ.....	18-12
MILLIN vesicales.....	66-05
MOLLISON.....	18-17
MORSE-FAVOLORO costales.....	FG-17
Separador ganchos musculares.....	18-25
Separador	
NAGER paladar.....	50-02
OLLIER.....	18-10
O'SULLIVAN-O'CONNOR abdominales.....	18-21
Separador para yesos.....	30-03
Separador	
PARKER.....	18-02
PITHA de labios.....	48-06
PLESTER.....	18-14
QUATTRO para yesos.....	30-03
REVERDIN.....	18-04
RIBBON.....	18-04
RICHARDSON.....	18-04
RICHARDSON-EASTMAN.....	18-04
RICHARDSON Grip.....	18-04
RIGBY abdominales.....	18-24
ROLLET.....	42-06
ROUX.....	18-02
ROUX BABY.....	18-02
ROUX MINI.....	18-02
SAUERBRUCH.....	18-13
SCHOENBORN tiroide.....	54-04



SELLHEIM para la salida de la cabeza.....	72-09	KOCHER bocio.....	54-04	para fil ..... 33-10	
SENN.....	18-04	KOENIG conductora.....	26-04	Terraja.....	33-15
SENN-GREEN.....	18-07	MAYO para cálculos renales.....	62-10	TERSON pinza capsulares.....	43-04
SIMON.....	18-12	medurar.....	44-15	THOMS-ALLIS pinza para tejidos.....	64-02
STERNBERG de labios.....	48-02	MOYNIHAN para cálculos biliares.....	62-05	THOMS-GAYLOR pinza sacabocado	
TAYLOR espinal.....	32-24	NABATOFF de plata auricular.....	20-02	para el cuello del útero.....	70-42
THOMSON-WALKER vesicales.....	66-06	PAYR conductora.....	26-04	THOMSON-WALKER separador vesicales.....	66-06
TUFFIER costales.....	FG-16	SCHMIEDEN conductora.....	26-04	THOREK tijeras para pulmonares.....	08-36
US Army (PARKER-LANGENBECK).....	18-03	SCHMIEDEN-PAYR conductora.....	26-04	THUDICHUM espéculo para nasales.....	46-02
VOLKMANN.....	18-07 hasta 18-08	STACKE de plata auricular.....	20-02	TIECK-HALLE espéculo para nasales.....	46-03
WEITLANER.....	18-14	SPENCER tijeras para puntas.....	08-40	TIEMANN pinza pra coher el cuello de útero70-	
WEITLANER-WULLSTEIN.....	18-14	SPENCER-WELLS pinza hemostática.....	12-07	32	
YOUNG para prostata.....	66-02	SPRATT cucharilla cortante.....	32-12	Tijera	
SEUTIN cizalla para yeso.....	30-02	SPURLING pinza cortantes para laminectomíaEA-		AEBLI para corneal.....	08-22
SEXTON cuchillo auriculares.....	44-06	08		Tijera de disección.....	08-19
SHEA tijeras auriculares micro.....	44-09	STACKE sonda de plata auricular.....	20-02	Tijera finas.....	08-19
SHORTBENT tijeras para puntas.....	08-40	Standard estuche de bolsillo y de sutura.....	26-08	Tijera	
SIEBOLD tijeras para ginecológicas.07-21, 08-32		STAUDE-MOORE pinza		FINOCHIETTO para recto.....	08-38
SIEGLE espéculos auriculares.....	44-02	para coher el cuello de útero.....	70-31	GORNEY de disección.....	08-13
SIEGLER HELLMANN pinza para el útero.....	70-38	St. CLAIR-THOMSON cuchillo.....	46-19	IRIS.....	08-19
Sierra		STEINER-AUVARD espéculo vaginales.....	70-19	IRIS de oftalmología.....	08-22
BERGMANN para yesos.....	30-02	STEINMANN clavo para huesos.....	33-09	JOSEPH.....	08-16
CHARRIERE para amputacion.....	33-03	STELZNER tijera para recto.....	08-38	KILNER.....	08-17
ENGEL para yesos.....	30-02	STERNBERG separador de labios.....	48-02	LEXER-BABY de disección.....	08-12
JOSEPH para nasales.....	46-17	STEVENS		LEXER-FINO de disección.....	08-12
LANGENBECK a dedo.....	33-03	gancho para cristalino.....	42-06	LITTLER de disección.....	08-13
OLIVECRONA.....	EA-05	STEVENSON blefarostato.....	42-03	LOCKLIN.....	08-18
Sierra oscilante para yesos.....	30-05 hasta 30-06	STEVENS		METZENBAUM de disección08-13 hasta 08-	
Sierra		pinza para iris.....	42-11	14	
WIGMORE para yesos.....	30-02	porta-aguja de oftalmología.....	24-06	METZENBAUM FINO de disección.....	08-15
SILVER		tijeras para tenotomia.....	07-17	METZENBAUM "S".....	08-16
cincel plástica para nasales.....	46-14	tijera tenotomia.....	08-23	Tijera para enterótomos.....	08-39
dermatomo.....	06-20	STIEGLITZ pinza para espinas.....	10-06	Tijera	
SIMCOE canula sutura.....	43-07	STILLE		REYNOLDS.....	08-18
SIMON		cincel.....	32-14	Tijeras.....	07-02 hasta 07-04, 08-02 hasta 08-04
cucharilla cortante.....	32-13	cizalla para yeso.....	30-02	Tijera	
cureta uterinas.....	70-48	costótomo.....	FG-03	SANVENERO.....	08-16
separador.....	18-12	gubia.....	32-14	Tijeras	
SIMPSON-BRAUN pinza obstétricas.....	72-02	STILLE-HORSLEY pinza cortante para huesos32-07		auriculares micro.....	44-11
SIMPSON pinza obstétricas.....	72-02	STILLE-LISTON pinza cortante para huesos.....	32-06	auriculares micro mini.....	44-11
SIMPSON-LUIKART pinza obstétricas.....	72-03	STILLE-LUER pinza gubia.....	32-04	BARRAQUER de colibri.....	09-04
SIMS		STILLE		BEEBEE para alambre y chapas.....	08-43
cureta uterinas.....	70-49 hasta 70-50	osteotomo.....	32-14	BELLUCCI auriculares micro.....	44-09
depresor uterino.....	70-39	perforador a mano.....	33-04	BERGMANN de vendajes.....	08-46
dilatador uterinos.....	70-30	pinza de disección.....	10-02	BEUSE.....	08-26
espéculo rectales.....	68-02	pinza para pedícula renal.....	12-16	BOETTCHE para amígdalas.....	08-27
espéculo vaginales.....	70-17	STILLE-RUSKIN pinza gubia.....	32-05	BRAUN-STADLER para episiotomía07-22, 08-	
histerómetro.....	70-39	STILLE-SHERMAN perforador a mano.....	33-04	34	
SIMS-MAIER pinza para tapones.....	16-05	St. MARTIN pinza sutura.....	43-05	BRUNS para yeso.....	08-48
SIMS		STOCKMANN compresor uretrales.....	66-12	BUCK para puntas.....	08-40
tijeras para ginecológicas.....	07-21, 08-32	STONE pinza para cerrar.....	64-06	BUSCH para umbilicales.....	08-34
SINGLEY pinza de disección.....	10-05	STONE-WAIT pinza intestinales.....	64-06	CASTROVIEJO para corneal.....	09-06
Sistema LEYLA de fijación.....	EA-14 hasta EA-18	STRATTE porta-aguja.....	24-04	CASTROVIEJO para iridectomia.....	09-05
SKENE pinza para coher el cuello del útero70-31		STRAUSS compresor uretrales.....	66-10	Tijera	
SLUDER-BALLENGER amígdalotomo.....	50-05	STRUEMPEL pinza auriculares.....	44-08	SCHUMACHER para esternón.....	FG-07
SMELLIE		STRULLY tijeras para neuroquirurgicas.....	08-35	Tijeras	
gancho obstetrico.....	72-06	STRUYCKEN pinza cortantes para nasales.....	46-07	COTTLE para nasales.....	07-18, 08-25
perfora-cráneo.....	72-09	SUBRAMANIAN pinza atraumatica.....	BD-31	CRAFOORD para pulmonares.....	08-36
SMILLIE meniscotomo.....	32-24	SWEET pinza para poner grapas.....	EA-02	CRUZ ROJA de vendajes.....	08-47
SMITH blefarostato.....	42-02	T		cuticular.....	74-03
SMITH-BUIE separadore rectales.....	68-03	TABB cuchillo forma hoz.....	44-14	DANDY para neuroquirurgicas.....	08-36
SMITH-PETERSEN		Taladros.....	33-04	DEAN para amígdalas.....	08-26
cincel.....	32-15	KIRSCHNER filiformes.....	33-09	DEAVER.....	07-05, 08-06
gubia.....	32-15	Tambor		DE BAKEY para vasculares.....	08-30
SMITH US ARMY tijeras de vendajes.....	08-44	KONRICH para esterilización.....	88-12	DIETHRICH para vasculares.....	08-29
SMITHWICK		SCHIMMELBUSCH para esterilización.....	88-12	DIMEDA de vendajes.....	08-46
gancho para nervios.....	EA-04	Tamiz para especulo vaginal.....	70-22	DOYEN para ginecológicas.....	08-33
pinza para poner grapas.....	EA-02	TARNIER		DUBOIS para ginecológicas.....	08-33
SNELLEN		cranioclasto.....	72-09	ESMARCH de vendajes.....	08-46
asa.....	42-08	pinza obstétricas con dispositivo de tracción		Tijeras estrabismo.....	08-24
pinza entropión.....	43-06	72-05		Tijeras	
SOMER pinza para el útero.....	70-37	Tarro.....	88-08	FERGUSSON.....	08-49
Sonda.....	20-02	TAYLOR		Tijeras finas.....	08-24
BOWMAN canal lacrimonal.....	42-10	martillos de percusión.....	02-07	Tijeras fins.....	08-05
BRUNNER conductora.....	26-04	separador espinal.....	32-24	Tijeras	
DESJARDINS para cálculos biliares.....	62-05	TEALE pinza para coher el cuello del útero.....	70-33	FOMON para nasales.....	07-18, 08-25
DOYEN.....	20-02	Tensor		GOLDMAN-FOX para encias.....	08-41
FILIFORM.....	66-12	LOUTE cierra-hilo.....	33-11	GOOD para amígdalas.....	08-27
KIRSCHNER conductora.....	26-04			HEATH para puntas.....	08-40

HEYMANN para nasales.....07-18, 08-25	WAGNER para encías .....08-42	Tübingen TITAN
Tijeras incisión .....08-05	WALDMANN para episiotomía .....08-34	pinza ligaduras .....43-05
Tijeras	WECKER para iris .....09-04	pinza para iris.....42-15
IRIS.....07-16, 08-21	WERTHEIM para preparación .....08-32	Tubo
JACOBSON micro .....09-11	WESTCOTT para iridectomia .....09-02	ANDREWS-PINCHON de aspiración .....04-03
JOSEPH .....07-14	WESTCOTT para tendones .....09-02	BRUENINGS alarmiento .....52-03
KELLY para ginecológicas.....07-22, 08-33	WULLSTEIN auriculares micro .....44-11	BUJE de aspiración .....68-05
KILNER .....07-14	WULLSTEIN auriculares micro mini .....44-11	DE BAKEY de aspiración .....04-04
KLINKENBERGH-LOTH para torácica .....08-37	YASARGIL micro.....09-10 hasta 09-11	FRAZIER de aspiración .....04-06
KNAPP .....08-20	TILLEY pinza auriculares .....44-08	JACKSON traqueal .....54-03
KNOWLES de vendajes .....08-47	Tirabuzón DOYEN para fibroma.....70-46	LUER traqueal .....54-03
LAGRANGE para encías .....08-41	TISCHLER-KEVORKIAN pinza sacabocado	MAGILL de aspiración .....04-04, 04-06
LANDOLT enucleación .....08-25	para el cuello del útero.....70-44 hasta 70-45	NUBOER de aspiración .....04-05
LANGE de vendajes.....08-44	TISCHLER-MORGAN pinza sacabocado	POOLE de aspiración .....04-02
LEXER .....07-09	para el cuello del útero70-43 hasta 70-44, 70-46	WAGENER-MOSHER traqueal.....54-03
LEXER-BABY.....07-10	TIVNEN pinza coger amígdalas .....50-04	WALTON YANKAUER de aspiración .....04-03
LEXER de disección .....08-11	TOBOLD	YANKAUER de aspiración .....04-02
LISTER de vendajes.....07-23, 08-45	abajalengua.....48-02	TUFFIER
LITTAUER para puntas.....08-40	estilete .....20-03	pinza hemostática .....12-08
LORENZ de vendajes .....08-47	TOENNIS-ADSON tijeras para neuroquirúrgicas	separador costales .....FG-16
MAYO .....07-06, 08-07	08-35	TURNBULL pinza para unas.....74-03
MAYO-NOBLE .....07-08, 08-10	TOENNIS	TURREL pinza sacabocado para biopsia.....68-05
MAYO-STILLE .....07-07, 08-08 hasta 08-09	descolador duramadre .....EA-05	TYDING
MAYO zurdo.....08-07	pinza hemostática .....12-11	cierranudos amígdalas .....50-05
McGUIRE para corneal.....09-05	porta-aguja .....24-04	pinza coger amígdalas.....50-04
McINDOE para cartilago .....08-35	TOHOKU pinza para campos .....14-04	U
McPHERSON WESTCOTT para tenotomía09-04	Tonómetro SCHIOETZ .....43-08	UCKERMANN
METZENBAUM.....07-11	TOOK cuchillo para corneal.....42-05	estilete .....20-03
METZENBAUM FINO.....07-12	Torniquete.....02-03, 33-02	trocar traqueal.....54-02
METZENBAUM "S".....07-13	TOTI fresa .....33-07	ULRICH pinza porta esponjas .....16-06
Tijeras micro .....09-06, 09-13	TOWNSEND-KEVORKIAN pinza sacabocado	UNIVERSAL
Tijeras micro para ginecológicas09-07 hasta 09-08	para el cuello del útero .....70-44	pinza para esterilización .....28-02
Tijeras	TOWNSEND-MINI (BABY TISCHLER) pinza	tijeras de vendajes .....08-50
MILLS para vasculares .....08-27	sacabocado para el cuello del útero.....70-45	tijeras para alambre y chapas.....08-42
NORTHBENT para puntas.....08-40	TOWNSEND-mini pinza sacabocado	trócar .....22-02
NOYES para iris .....09-03 hasta 09-04	para el cuello del útero .....70-44	UNNA saca comedones .....74-02
NOYES para tendones .....09-03	TOWNSEND pinza sacabocado	Uretrotomo OTIS .....66-08
Tijeras para encías .....08-41	para el cuello del útero .....70-44	Urinal .....88-10
Tijeras para estrabismo.....07-17	TOWNSEND-TISCHLER pinza sacabocado	USA
Tijeras parametrío para vasculares.....07-20	para el cuello del útero .....70-44	cable electrobisturías.....JA-07
Tijeras para neuroquirúrgicas .....08-35	TOYNBEE espéculos auriculares .....44-02	USA MODEL tijeras para umbilicales.....08-34
Tijeras para preparación.....08-34	Tractor	USA
Tijeras para vasculares .....08-27	BARTON adecuada	pinza de disección.....10-02
Tijeras para vasculares micro .....09-09	para todas las pinzas con mango.....72-04	US Army (PARKER-LANGENBECK) separador18-03
Tijeras para yeso .....08-49	BILL adecuada para todas las pinzas con	Uso único de bisturías estériles06-10 hasta 06-11
Tijeras	mango .....72-05	V
POTTS DE MARTEL para vasculares .....08-27	LUIKART-BILL adecuada	VALLEIX histerómetro .....70-39
POTTS-SMITH para vasculares...07-19, 08-28	para todas las pinzas con mango .....72-05	Valva
PRINCE para amígdalas .....08-27	TRAUBE martillos de percusión .....02-07	BALFOUR .....18-22
QUINBY para encías .....08-42	TRELAT espéculo vaginales .....70-07	CASPAR .....18-20
REYNOLDS .....07-15	Trépano .....33-04	CASPAR para columna vertebral .....18-19
SANVENERO .....07-13	CASTROVIEJO para corneal .....43-07	KALLMORGEN vaginales.....70-15
SATINSKY para torácica.....08-37	ELLIOT para corneal .....43-08	KIRSCHNER .....18-23
SCHMIEDEN-TAYLOR .....08-36	FRANCSCHETTI para corneal.....43-07	KRISTELLER vaginales .....70-09 hasta 70-14
SCHUMACHER para umbilicales .....08-34	Trócar .....22-02	VAN BUREN
SHEA auriculares micro .....44-09	COAKLEY .....22-02	bujía uretrales .....66-13
SHORTBENT para puntas .....08-40	DOUGLAS .....22-02	pinza para secuestros .....32-10
SIEBOLD para ginecológicas .....07-21, 08-32	FLEURANT .....22-02	Van DOREN pinza sacabocado
SIMS para ginecológicas .....07-21, 08-32	LICHTWITZ .....22-02	para el cuello del útero .....70-42
SMITH US ARMY de vendajes .....08-44	MENGHINI .....22-03	VANNAS
SPENCER para puntas.....08-40	NELSON .....22-02	tijeras micro.....09-12 hasta 09-13
STEVENS para tenotomía .....07-17	OCHSNER .....22-02	tijeras para iridectomia .....09-05
STRULLY para neuroquirúrgicas.....08-35	PIERCE .....22-02	VARIFOCAL oftalmoscopio .....02-03
Tijera	Trócar UCKERMANN traqueal.....54-02	Vaso para medicamentos .....88-07
STELZNER para recto .....08-38	Trócar	VERBRUGGE pinza para huesos.....32-09
STEVENS tenotomía .....08-23	UNIVERSAL .....22-02	VERRES aguja para punción, neumoperitoneo22-03
Tijeras	TROELTSCH pinza para nasales.....46-04	Vienna espéculo para nasales .....46-02
THOREK para pulmonares .....08-36	TROEMNER martillos de percusión.....02-07	VIRCHOW
TOENNIS-ADSON para neuroquirúrgicas08-35	TROUSSEAU dilatador traqueal .....54-02	cuchillo para cartílagos .....06-18
TROUTMAN-CASTROVIEJO micro .....09-07	TROUTMAN-CASTROVIEJO tijeras micro .....09-07	cuchillo para cerebro .....06-18
UNIVERSAL de vendajes .....08-50	TROUTMAN-CHRIS rompe hojas.....06-14	rompecraneo .....32-17
UNIVERSAL para alambre y chapas .....08-42	TROUTMAN Colibri pinza para iris .....42-13	VIRTUS (RALK) pinza para espinas .....10-06
USA MODEL para umbilicales.....08-34	TROUTMAN pinza rectus .....43-02	VOLKMANN
VANNAS micro.....09-12 hasta 09-13	TUBBS dilatador para válvula mitral.....FG-27	cucharilla cortante .....32-12 hasta 32-13
VANNAS para iridectomia .....09-05	Tübingen	separador .....18-07 hasta 18-08
WAGNER .....07-22	canula aire.....43-07	
	pinza ligaduras .....43-05	
	pinza para iris.....42-15	

VOLTOLINI espéculo para nasales .....	46-02	09	
W		WINTER pinza para aborto y placenta.....	72-07
WACHENFELDT pinza para grapas .....	26-07	WITTNER pinza sacabocado	
WADSWORTH-TODD cauterio.....	42-08	para el cuello del útero .....	70-43
WAGENER ganchito auriculares .....	44-07	WOLFF pinza para romper yesos .....	30-04
WAGENER-MOSHER tubo traqueal.....	54-03	WRIGLEY pinza obstétricas .....	72-02
WAGNER		WULLSTEIN	
pinza cortantes para laminectomía .....	EA-09	cuchillo forma hoz .....	44-14
tijeras .....	07-22	tijeras auriculares micro .....	44-11
tijeras para encías .....	08-42	tijeras auriculares micro mini.....	44-11
WALDMANN tijeras para episiotomía.....	08-34	WYLLIE	
WALLICH cureta para aborto y placenta.....	72-08	dilatador uterinos.....	70-30
WALSHAM pinza enderezar tabique.....	46-18	pinza atraumatica.....	BD-21
WALTHER bujía uretrales.....	66-17	Y	
WALTON		YANKAUER	
gubia para cuerpos extraños.....	42-06	espéculo nasofaringe .....	46-04
saca comedones.....	74-02	tubo de aspiración.....	04-02
WALTON YANKAUER tubo de aspiración .....	04-03	YASARGIL tijeras micro.....	09-10 hasta 09-11
WANGENSTEEN		YEOMAN pinza sacabocado para biopsia.....	68-05
pinza de disección.....	10-05	YOUNG Boomerang aguja para ligaduras.....	26-03
porta-aguja .....	24-03	YOUNG	
WARTENBERG sensimetro.....	02-08	pinza para coger prostata .....	66-02
WATSON-CHEYNE elevador .....	32-22	pinza tiralengua .....	48-03
WATSON dermatomo.....	06-22	separador para prostata.....	66-02
WEBER		Z	
asa .....	42-08	ZAUFAL-JANSEN pinza gubia .....	32-04
pinza atraumatica.....	BD-12	ZENKER pinza de disección y ligadura .....	12-12
WECKER		ZIEGLER	
espatula para iris.....	42-08	blefarostato .....	42-03
tijeras para iris .....	09-04	cuchillo capsulotomía .....	42-05
WEEK blefarostato .....	42-02	cuchillo para iridectomía .....	42-04
WEIL-BLAKESLEY pinza cortantes para nasales.....	46-06	dilatador canal lacrimonal.....	42-10
WEISSBARTH espéculo vaginales.....	70-22	espejo frontal .....	02-05
WEISS pinza para cierra-tubo .....	12-19		
WEITLANER separador .....	18-14		
WEITLANER-WULLSTEIN separador.....	18-14		
WELLS espatula enucleacion.....	42-08		
WERTHEIM-CULLEN pinza histerectomía.....	12-18		
WERTHEIM			
pinza histerectomía .....	12-18		
tijeras para preparacion.....	08-32		
WEST			
cincel para nasales .....	46-14		
WESTCOTT			
tijeras para iridectomía .....	09-02		
tijeras para tendones.....	09-02		
WEST			
gubia para nasales .....	46-14		
WESTON cierranudo polipus rectal .....	68-05		
WHEELER			
cuchillo para discision .....	42-04		
espatula ciclodialálisis .....	42-09		
WHITEHEAD abreboca.....	48-04		
WHITE pinza coger amigdalas.....	50-03		
WIEDER abajalengua .....	48-02		
WIENER (AUFRIEHT) lima para nasales .....	46-15		
WIENER			
gancho para iris.....	42-06		
lima para el seno.....	46-15		
WIGMORE sierra para yesos .....	30-02		
WILDE			
cierranudo auriculares.....	44-07		
cierranudos para nasales.....	46-09		
WILDER			
asa .....	42-08		
dilatador canal lacrimonal.....	42-10		
WILDE (TROELTSCH) pinza auriculares .....	44-07		
WILLET-MARTELL pinza para pericraneos.....	12-08		
WILLIAMS			
blefarostato .....	42-02		
destornillador .....	33-14		
pinza para tejidos .....	64-03		
WILLIGER			
cucharilla cortante .....	32-13		
martillo .....	32-18		
periostótomo .....	32-19		
WINKELMANN instrumento para circuncisión.....	66-06		

**A**

Mano di piombo.....	32-11
Abassalingua	
ANDREW.....	48-02
BRUENINGS.....	48-02
BUCHWALD.....	48-02
FRENZEL.....	48-02
HARTMANN.....	48-02
legno.....	48-02
McIVOR.....	48-05
TOBOLD.....	48-02
WIEDER.....	48-02
Accessori per contenitori	
per sterilizzazione.....	88-38 lavorare a 88-41
Ad elettrodo mini.....	JA-03
Adenotomo LAFORCE.....	46-19
ADLERKREUTZ pinza dissezione.....	10-04
ADSON Baby	
divaricatore.....	18-15
ADSON BABY	
pinza emostatica.....	12-09
ADSON-BROWN pinza dissezione.....	10-03
ADSON	
divaricatore.....	18-15
divaricatore per nervi.....	EA-04
elevatore.....	32-21
pinza dissezione.....	10-03
pinza dissezione, micro.....	10-03
pinza emostatica.....	12-09
pinza per ipofisi.....	EA-06
pinza sgorbia.....	32-03
port'aghi.....	24-04
AEBLI forbici corneali.....	08-22
AESFULAP cavo elettrobisturi.....	JA-07
Affilare ARKANSAS.....	06-19
Ago	
BARBARA.....	44-14
BOWMAN per dissezione curva.....	42-05
COOPER per legature.....	26-02
DAVIS per corpi estranei.....	42-05
DESCHAMPS per legature.....	26-02
DIX.....	42-09
DUPUY-WEISS tonsille.....	50-03
elettrodo mini.....	JA-02
forma di ago.....	JA-03
FRANCIS per corpi estranei.....	42-05
FRANKLIN-SILVERMANN da punzione.....	22-03
KEITH suture.....	26-06
KOENIG suture.....	26-06
KRONECKER per legature.....	26-02
LEVINSON per corpi estranei.....	42-05
LICHTWITZ seno.....	46-09
NELSON per legature.....	26-02
per cataratta stretta retta.....	42-05
per corpi estranei retto.....	42-05
POLITZER auricolare.....	44-06
QUINKE da punzione.....	22-03
REVERDIN per legature.....	26-03
ROSEN.....	44-14 lavorare a 44-15
Ago suture.....	26-05 lavorare a 26-06
Ago	
tonsille.....	50-05
VERRES da punzione pneumoperitoneo.....	22-03
YOUNG Boomerang per legature.....	26-03
Agrafes MICHEL.....	26-07
ALAN-PARKS dilatatore per l'ano e il retto.....	68-03
ALBEE fresa.....	33-07
Alesatore	
CRUTCHFIELD.....	EA-03
KUENTSCHER.....	33-13
per chiodi centromid.....	33-12
ALEXANDER	
periototomo.....	32-19
pinza tagliente per biopsia.....	70-42
scalpello.....	32-14
sgorbida.....	32-14
ALLIS-ADAIR pinza per afferrare tessuti.....	64-02
ALLIS-Baby pinza per afferrare tessuti.....	64-02

ALLISON spatola polmone.....	FG-19
ALLIS pinza per afferrare tessuti.....	64-02
ALM divaricatore.....	18-14
ALVIS curretta per corpi estranei.....	42-06
Amniotomo BEACHAM.....	70-39
ANDREW abassalingua.....	48-02
ANDREWS-PINCHON tubi d'aspirazione.....	04-03
Anoscopio	
HIRSCHMANN.....	68-04
IVES-FANSLER.....	68-04
Ansa	
ARLT.....	42-08
auricolare.....	44-07
BILLEAU auricolare.....	44-07
di filo.....	JA-03
di nastro.....	JA-03
elettrodo mini.....	JA-02
SNELLEN.....	42-08
WEBER.....	42-08
WILDER.....	42-08
Anse.....	46-09
tonsille.....	50-04
Apparecchio	
per vuoto di sangue.....	33-02
PETZ per sutura stomacali e intestinali.....	64-09
Approssimatori	
BAILEY-BABY costali.....	FG-18
BAILEY costali.....	FG-18
BAILEY-GIBBON costali.....	FG-18
SELLORS costali.....	FG-18
Apribocca	
DAVIS-BOYLE.....	48-04
DENHART.....	48-03
DOYEN-JANSEN.....	48-03
HEISTER.....	48-03
JENNINGS.....	48-04
KILNER-DOUGHTY.....	48-05
MAUNDER legno.....	48-06
McIVOR.....	48-05
ROSER-KOENIG.....	48-03
SEEMANN-SEIFFERT.....	48-04
WHITEHEAD.....	48-04
ARCHER pinza schegge.....	10-06
Arco per estensione.....	33-10
BOEHLER.....	33-10
KIRSCHNER.....	33-10
ARKANSAS affilare.....	06-19
ARLT ansa.....	42-08
ARRUGA	
blefarostato.....	42-02
pinza capsulare.....	43-04
port'aghi oftalmologia.....	24-06
protettore.....	42-08
uncino.....	42-06
ASCH pinza raddrizzare setto.....	46-18
Assordatore BARANY.....	44-04
Astucci per diagnostica.....	02-04
Astucci per otoscopia.....	02-04
Astucci tascabili e per sutura	
mini.....	26-08
standard.....	26-08
AUFRIEDT divaricatore nasale.....	46-17
AUVARD specolo vaginali.....	70-19
AXENFELD curretta per calazio.....	42-07
AYER pinza calazio.....	43-06
B	
BABCOCK pinza per afferrare tessuti.....	64-02
BABINSKY martelli percussori.....	02-07
Bacinella.....	88-05
per placenta.....	88-06
reniforme.....	88-07
BACKHAUS-CLIP pinza fissateli porta tubo.....	14-03
BACKHAUS KOCHER pinza fissateli.....	14-02
BACKHAUS pinza fissateli.....	14-02
BAGGISH pinza tagliente per biopsia.....	70-45
BAILEY approssimatori costali.....	FG-18
BAILEY-BABY approssimatori costali.....	FG-18
BAILEY-GIBBON approssimatori costali.....	FG-18

BAINBRIDGE	
pinza traumatica.....	BD-09
pinza emostatica.....	12-14
BAKES dilatatore per condotti biliari.....	62-06
BALFOUR Baby divaricatore addominale.....	18-22
BALFOUR	
divaricatore addominale.....	18-22
valva centrale.....	18-22
BALL AND SOCKET pinza fissateli.....	14-04
BALLENGER	
coltello girevole.....	46-11
elevatore setto.....	46-12
pinza tonsille.....	50-04
BANGERTER spatola ciclodialis.....	42-08
BARANY assordatore.....	44-04
BARBARA	
ago.....	44-14
pick.....	44-14 lavorare a 44-15
uncinetto.....	44-14
BARKAN coltello per goniotomia.....	42-05
BARNHILL coltello.....	46-19
BARRAQ-KATZIN pinza iride.....	42-13
BARRAQU Colibri pinza iride.....	42-13
BARRAQUER Colibri blefarostato.....	42-02
BARRAQUER	
coltello per cheratopl.....	42-05
forbici colibri.....	09-04
pinza camera anteriore.....	43-02
pinza depilatorie.....	43-08
pinza fissaggio.....	43-03
port'aghi.....	24-07
BARRETT pinza per abbassare il collo dell'utero	
70-32.....	
BARR specolo rettale.....	68-02
BARTON	
forbici obstetriche.....	72-04
trattore per manico standard.....	72-04
BAUMGARTNER port'aghi.....	24-02
BEACHAM amniotomo.....	70-39
Becher.....	88-10
BECKER cistitomo.....	42-06
BECKMANN-ADSON divaricatore.....	18-15
BECKMANN	
coltello.....	46-19
divaricatore.....	18-16
BECKMANN-EATON divaricatore.....	18-16
BECK pinza traumatica vascolare.....	BD-25
BEEBEE forbici filo metallo lamiera.....	08-43
BEER pinza depilatorie.....	43-08
BEESON divaricatori per gessi.....	30-03
BELLUCCI forbici auricolari micro.....	44-09
Benda per emostasi.....	02-03
BENGOLEA pinza emostatica.....	12-09
BENNETT elevatore per ossa.....	32-22
BERENS cheratomo.....	42-04
BERGMANN FOERSTER pinza	
per tamponi e spugne.....	16-10
BERGMANN	
forbici bendaggi.....	08-46
sega per gessi.....	30-02
BERKE pinza muscolre.....	43-02
BERLIND-AUVARD specolo vaginali.....	70-19
BERLINER martelli percussori.....	02-07
BERNHARD pinza fissateli.....	14-05
BERTILLON cefalometro.....	02-08
BEST pinza intestinali.....	64-06
BETHUNE costotomo.....	FG-04
BEUSE forbici.....	08-26
BEYER	
pinza osteotomo.....	46-08
pinza sgorbia.....	32-04
Bicchiere graduato.....	88-07
BILLEAU ansa auricolare.....	44-07
BILL trattore per manico standard.....	72-05
BIRCHER-GANSKE tenaglia per ossa.....	32-10
BIRCHER meniscotomo.....	32-24
BISHOP-HARMAN pinza iride.....	42-14
Bisturi	
CONVERSE nasale.....	46-10



dissezione.....	06-15	depressore uterino.....	70-39	valva.....	18-20
FREER mucosa.....	46-10	pinza per abbassare il collo dell'utero70-31, 70-34		valva spina vertebrale.....	18-19
HALLE per duramadre.....	EA-06	specolo vaginali.....	70-16	<b>CASTAÑEDA</b>	
JOSEPH nassale botton.....	46-10	<b>BRAUN-STADLER</b> forbici episiotomia 07-22, 08-34		divaricatore costali.....	FG-14
MALTZ cartilage angolat.....	46-11	<b>BRAUN</b>		pinza atraumatica.....	BD-42
Bisturi per dissezione PARKER.....	06-15	uncino per detroncazione.....	72-09	<b>CASTROVIEJO</b>	
<b>Bisturi</b>		<b>BREISKY</b> specolo vaginali.....	70-20	blefarostato.....	42-03
SEGOND per fibromi.....	70-46	<b>BROCK</b>		cheratomo.....	42-04
Bisutri lama sterili.....	06-09	dilatatore per valvole mitrali.....	FG-26	dilatatore canale lacrimale.....	42-10
Bituri forma di bisturi.....	JA-03	manico per valvole mitrali.....	FG-26	forbici corneali.....	09-06
<b>BLAKE</b>		pinza tagliente.....	FG-26	forbici iridectomia.....	09-05
curetta uterine.....	70-48	<b>BROWN</b> pinza dissezione.....	10-03	marcatore compasso.....	42-09
pinza per calcoli biliari.....	62-03	<b>BRUENINGS</b>		pinza capsulare.....	43-04
<b>Blefarostato</b>		abassalingua.....	48-02	pinza fissaggio.....	43-03
ARRUGA.....	42-02	coltello setto.....	46-11	pinza rompe lamette.....	06-14
BARRAQUER Colibri.....	42-02	pinza laringe.....	52-03	pinza sutura.....	43-05
BOWMAN.....	42-02	pinza tagliente nasale.....	46-05	port'aghi.....	24-07
CASTROVIEJO.....	42-03	serranodi tonsille.....	50-04	spatola ciclodialiisi.....	42-08 lavorare a
CLARK.....	42-02	specoli auricolare.....	44-02	trapano corneale.....	43-07
CRITCHETT.....	42-02	tubo allungo.....	52-03	<b>CATLIN</b> coltello per amputazione.....	06-16
GOLDSTEIN.....	42-03	<b>BRUNETTI</b> scalpello spinale.....	32-17	Cauterio WADSWORTH-TODD.....	42-08
GRAEFE.....	42-02	<b>BRUNNER</b>		Cavachiodi KUENTSCHER.....	33-13
LANCASTER.....	42-03	costotomo.....	FG-07	<b>Cavo</b>	
LISTER-BURCH.....	42-02	pinza intestinale.....	64-06	AESCULAP elettrobisturi.....	JA-07
MELLINGER.....	42-02	sonda conduttrice.....	26-04	ERBE SELECT elettrobisturi.....	JA-07
MELLINGER-AXENFELD.....	42-02	<b>BRUNS</b>		MARTIN elettrobisturi.....	JA-07
MUELLER.....	42-03	curetta tagliente.....	32-12 lavorare a	USA elettrobisturi.....	JA-07
MURDOCK.....	42-02	forbici gesso.....	08-48	<b>Cefalometro BERTILLON</b> .....	02-08
PARK.....	42-03	<b>BRYANT</b> pinza per tamponi e spugne.....	16-11	<b>Cesoia</b>	
SMITH.....	42-02	BUCHWALD abassalingua.....	48-02	BÖHLER per ossa.....	32-06
STEVENSON.....	42-03	<b>BUCK</b>		COTTLE-KAZANJIAN per ossa.....	32-06
WEEK.....	42-02	curetta auricolare.....	44-05	LISTON per ossa.....	32-06
WILLIAMS.....	42-02	forbici per legature.....	08-40	RUSKIN-LISTON per ossa.....	32-06
ZIEGLER.....	42-03	leva corpi estranei.....	44-08	SEMB per ossa.....	32-07
<b>BLOHMKE</b> pinza tonsille.....	50-04	martelli percussori.....	02-07	STILLE-HORSLEY per ossa.....	32-07
<b>BLOUNT</b>		<b>BUIE</b> tubo di aspirazione.....	68-05	STILLE-LISTON per ossa.....	32-06
elevatore per ginocchio.....	32-24	<b>BUMM</b>		<b>Cestelli</b>	
elevatore per ossa.....	32-24	curetta uterina.....	70-49 lavorare a	in acciaio perforato.....	88-13
<b>BLUMENTHAL</b> pinza sgorbia.....	32-02	pinza per afferrare l'utero.....	70-38	in rete metallica.....	88-13
<b>BODENHAMMER</b> specolo rettale.....	68-02	<b>BUNGE</b> curetta per palpebre.....	42-07	CHAPUT pinza emostatica.....	12-08
<b>BOEHLER</b> arco per estensione.....	33-10	<b>BUNNELL</b>		<b>CHARRIERE</b>	
<b>BOERMA</b> forbici obstetriche.....	72-04	perforatore a mano.....	33-05	lama di ricambio.....	33-03
<b>BOETTCHE</b> forbici tonsillari.....	08-27	scollatendini.....	32-25	sega per amputazione.....	33-03
<b>BÖHLER</b>		<b>BUNT</b> pinza per sterilizzazione.....	28-02	<b>CHEATLE</b> pinza per sterilizzazione.....	28-02
cesoia per ossa.....	32-06	<b>BURCH</b> forchetta di fissaggio.....	42-05	<b>Cheratomo</b>	
pinza sgorbia.....	32-04	<b>BURKE</b> -Baby pinza tagliente per biopsia.....	70-44	BERENS.....	42-04
<b>BONACCOLITO</b> pinza strabismo.....	42-14	<b>BURKE</b> pinza tagliente per biopsia.....	70-44	CASTROVIEJO.....	42-04
<b>Bonn</b>		<b>BUSCH</b> forbici ombelicali.....	08-34	JAEGER.....	42-04
cannula irrigazione.....	43-07	<b>C</b>		<b>CHERON</b> pinza per medicatura.....	16-12
<b>BONNEY</b> pinza per tamponi e spugne.....	16-08	Calamita DIMEDA oculistica.....	43-08	CHEVALIER-JACKSON pinza laringe.....	52-04
<b>Bonn</b>		<b>Candeletta</b>		CHEVALLIER divaricatore costali.....	FG-15
pinza iride.....	42-15	COXETER dilatatrici.....	66-17	Chiave.....	33-10
<b>Bonn TITAN</b> pinza iride.....	42-15	DITTEL dilatatrici.....	66-18 lavorare a	<b>CHILDE</b> pinza per agrafes.....	26-07
<b>BORCHARDT</b> fresa.....	33-07	FILIFORM.....	66-12	Chiodo per ossa STEINMANN.....	33-09
<b>BOSE</b>		GUYON dilatatrici66-12, 66-14 lavorare a	66-15	<b>CINELLI</b> scalpello plastica nasale.....	46-13
divaricatore tracheale.....	54-02	VAN BUREN dilatatrici.....	66-13	<b>Cistitomo</b>	
uncino tracheale.....	54-02	WALTHER dilatatrici.....	66-17	BECKER.....	42-06
<b>BOUCHERON</b> specoli auricolare.....	44-02	<b>Cannula</b>		GRAEFE.....	42-06
<b>BOWLES</b> stetoscopio.....	02-06	Bonn irrigazione.....	43-07	<b>CITELLI</b> pinza osteotomo.....	46-08
<b>BOWMAN</b>		Hamburg bottonuta.....	43-07	<b>CLARK</b> blefarostato.....	42-02
ago per disisione curva.....	42-05	KILLIAN.....	46-09	<b>CLAR</b>	
blefarostato.....	42-02	SCHEIE oculistica.....	43-07	lampada frontale.....	02-05
coltello per disisione.....	42-04	SIMCOE sutura.....	43-07	mini.....	02-05
specillo canale lacrimale.....	42-10	Tübingen aria.....	43-07	<b>CLEVELAND</b> pinza sgorbia.....	32-02
<b>BOYNTON</b> port'aghi oftalmologia.....	24-06	<b>Cannula</b>		<b>Clip</b>	
<b>BOZEMANN-DOUGLAS</b> pinza per medicatura 16-13		FINSTERER per aspirazione e irrigazione04-05		BRAIN emostatica per il cuoio capelluto EA-12	
<b>BOZEMANN</b>		Capsula diametro.....	88-04 lavorare a	BRAIN standard.....	EA-13
pinza per medicatura.....	16-13	<b>Capsula DASTOOR</b> aspiratore.....	42-09	EDWARDS.....	BD-21
port'aghi.....	24-03	CARMALT pinza schegge.....	10-06	<b>CLOWARD</b>	
<b>BRAIN</b>		<b>CARPENTER</b> coltello tonsille.....	50-02	divaricatore.....	18-17
clip emostatica per il cuoio capelluto.....	EA-12	<b>CASPAR</b>		divaricatore per corpi vertebrali.....	EA-07
clip standard.....	EA-13	divaricatore.....	18-20	<b>COAKLEY</b>	
<b>BRAIN MINI</b> pinza per posizionare clip.....	EA-12	divaricatore lombar vertebrale.....	18-20	curetta per seno.....	46-18
<b>BRAIN STANDARD</b> pinza per posizionare clipEA-12		divaricatore spina cervica.....	18-18	trequarti.....	22-02
<b>BRAITHWAITE</b> dermatomo.....	06-22	divaricatore spina vertebrale.....	18-19	<b>COLCLOUGH</b> pinza tagliente	
<b>BRAUN</b>		manico per bisutri, micro.....	06-12	per dischi intervertebrali.....	EA-11
cranioclasto.....	72-09			<b>COLLIER</b> port'aghi.....	24-02
				<b>COLLIN</b>	
				dinamometro.....	02-03

divaricatore addominale	18-24 lavorare a 18-25
COLLIN-DUVAL pinza dissezione	10-04
COLLIN-HARTMANN divaricatore	18-03
COLLIN	
isterometro	70-39
manico per bisturi	06-08
martello	32-18
pelvimetro	72-06
pinza emostatica	12-08
pinza ombelicale	72-06
pinza per afferrare l'utero	70-37
pinza per agrafes	26-07
pinza per medicatura	16-11
pinza tirlingua	48-03
COLLIN-POZZI pinza	
per abbassare il collo dell'utero	70-32
COLLIN	
specolo vaginali	70-04
COLLYER pelvimetro	72-06
Coltellino KUHNT per corneale	42-05
Coltello	
BALLENGER girevole	46-11
BARKAN per goniotomia	42-05
BARNHILL	46-19
BARRAQUER per cheratopl	42-05
BECKMANN	46-19
BOWMAN per disisione	42-04
BRUENINGS setto	46-11
CARPENTER tonsille	50-02
CATLIN per amputazione	06-16
COTTLE nassale	46-10
DEAN per iridettomi	42-04
DEUTSCHMANN per cataratta	42-03
ELSCHNIG per corneale	42-05
ESMARCH per gessi	30-04
FREER setto	46-10
GILL per corneale	42-05
GRAEFE per cataratta	42-03
HOPKINS per gessi	30-04
JOSEPH smusso	46-10
KNAPP per iridettomi	42-04
LANGENBECK per resezione	06-17
LISTON per amputazione	06-16
MUCK periostale	44-15
PAUFIQUE per cheratopl	42-05
Coltello per amputazione	06-16
Coltello per cartilagini	06-18
Coltello per gessi	30-04
Coltello	
PLESTER lobare	44-14
POLITZER auricolare	44-06
REINER per gessi	30-04
ROSEN circolare	44-14
SATO per corneale	42-05
SCHEIE per goniotomia	42-05
SCHUKNECHT circolare	44-14
SCHUKNECHT falciforme	44-14
SEXTON auricolare	44-06
St. CLAIR-THOMSON	46-19
TABB falciforme	44-14
TOOK per corneale	42-05
VIRCHOW per cartilagini	06-18
VIRCHOW per il cervello	06-18
WHEELER per disisione	42-04
WULLSTEIN falciforme	44-14
ZIEGLER per capsulotomia	42-05
ZIEGLER per iridettomi	42-04
COLVER pinza tonsille	50-03
Compressore CORWIN tonsille	50-04
CONNIN-AMSLER marcatore	42-09
Cono	
di occlusione	70-47
KNUTSON-KOCH per uretrografia	66-09
Contenitori per sterilizzazione	
3/4	88-22 lavorare a 88-24
grossi	88-18 lavorare a 88-20
mezzi	88-26 lavorare a 88-29
piatti mezzi	88-30 lavorare a 88-31

piccoli	88-32 lavorare a 88-33
spezzate	88-34 lavorare a 88-37
CONVERSE bisturi nassale	46-10
COOLEY	
costotomo prima	FG-05
COOLEY DERRA pinza atraumatica anastomosi	BD-39
COOLEY	
dilatatore per valvole mitrali	FG-27 lavorare a FG-29
dilatatore vascolare	FG-30
divaricatore costali	FG-09
divaricatore per cavità	FG-20
COOLEY modif- STRUCK divaricatore per cavità	FG-20
COOLEY pinza atraumatica	
11-03, BD-35 lavorare a BD-37, BD-41	
pinza atraumatica anastomosi	BD-37, BD-40
pinza atraumatica bulldog	BD-33 lavorare a BD-34
pinza atraumatica iliaca	BD-37
pinza atraumatica pediatrica	BD-38 lavorare a BD-39
pinza vascolare	BD-40
COOPER ago per legature	26-02
CORDES pinza laringe	52-03
Corta-agrafes	EA-02
CORWIN compressore tonsille	50-04
CORYLLOS costotomo	FG-04
CORYLLOS Thorax divaricatore	18-13
Costotomi	FG-02
GLUCK	FG-03
STILLE	FG-03
Costotomo	
BETHUNE	FG-04
BRUNNER	FG-07
COOLEY prima	FG-05
CORYLLOS	FG-04
GIERTZ-STILLE	FG-06
SAUERBRUCH	FG-05
SAUERBRUCH-FREY	FG-06
COTTLE	
coltello nassale	46-10
divaricatore nasale	46-17
elevatore periostotomo	46-12
elevatore setto	46-12
forbici nasali	07-18, 08-25
COTTLE-KAZANJIAN cesoia per ossa	32-06
COTTLE-NEIVERT divaricatore nasale	46-17
COTTLE	
scalpello plastica nasale	46-13
specolo nasale	46-03
COXETER candeletta dilatatrici	66-17
CRAFOORD	
forbici polmonari	08-36
pinza emostatica bronchiale	12-12
Cranioclasto	
BRAUN	72-09
TARNIER	72-09
CREDO tagliacalli	74-03
CRILE	
divaricatore	18-02
CRILE-MURRAY port'aghi	24-02
CRILE	
pinza emostatica	12-05
port'aghi	24-04
CRILE-RANKIN pinza emostatica	12-05
CRILE TITAN pinza emostatica	12-05
CRILE-WOOD port'aghi	24-02
CRITCHETT blefarostato	42-02
Crivello per specolo vaginale	70-22
CROCE RSSSA forbici bendaggi	08-47
CRUTCHFIELD	
alesatore	EA-03
pinza per trazione craniale	EA-03
Cucchia GUTMANN per secrezioni	66-11
Cucchiaio	
DESJARDINS per calcoli biliari	62-08
FERGUSSON per calcoli biliari	62-07

LUER-KOERTE per calcoli biliari	62-09
MAYO per calcoli biliari	62-07
MOORE per calcoli biliari	62-05
SELLHEIM osterico	72-09
CULLER spatola iride	42-08
Curetta	
ALVIS per corpi estranei	42-06
AXENFELD per calazio	42-07
BLAKE uterine	70-48
BRUNS tagliente	32-12 lavorare a 32-13
BUCK auricolare	44-05
BUMM uterine	70-49 lavorare a 70-50
BUNGE per palpebre	42-07
COAKLEY per seno	46-18
CUZZI per placenta e per ovaie	72-08
DAVIEL per cataratta	42-07
FAULKNER tagliente	46-18
FOX per lupus	74-02
GOURDET uterine	70-48
GRAEFE per cataratta	42-07
GROSS auricolare	44-06
HALLE tagliente	32-13
HEBRA per calazio	42-07
HOUSE	44-15
KEVORKIAN di aspirazione per biopsia	70-40
KNAPP per cataratta	42-07
LEMPERT tagliente	32-13
MARTINI tagliente	32-13
MEYHOEFER per calazio	42-07
NOVAK di aspirazione per biopsia	70-40
per aspirazione	70-51
PESTALOZZA per placenta e per ovaie	72-08
PIFFARD per lupus	74-02
RANDALL di aspirazione per biopsia	70-40
RECAIMER uterine	70-49 lavorare a 70-50
SCHEDE tagliente	32-12
SCHROEDER uterine	70-48
SIMON tagliente	32-13
SIMON uterine	70-48
SIMS uterine	70-49 lavorare a 70-50
SPRATT tagliente	32-12
VOLKMANN tagliente	32-12 lavorare a 32-13
WALLICH per placenta e per ovaie	72-08
WILLIGER tagliente	32-13
Curette LANG	42-08
CUSCO specolo vaginali	70-04 lavorare a 70-06
CUSHING	
divaricatore	18-07
divaricatore per nervi	EA-04
perforatore piano	33-04
pinza dissezione	10-03
pinza tagliente per laminectomia	EA-08
spatole cerebr	EA-07
CUZZI curetta per placenta e per ovaie	72-08
CZERNY	
pinza per abbassare il collo dell'utero	70-34
pinza per calcoli biliari	62-03
specolo rettale	68-02
D	
DALE pinza atraumatica vascolare	BD-24
DANDY	
divaricatore per nervi	EA-04
forbici neurochirurgia	08-36
pinza emostatica	12-07
DARDIK pinza atraumatica	BD-07
DARLING divaricatore	18-17
DARTIGUES pinza per afferrare l'utero	70-37
DASTOOR	
capsula aspiratore	42-09
pinza strabismo	42-14
DAVIDSON Scapula divaricatore	18-13
DAVIEL curetta per cataratta	42-07
DAVIS	
ago per corpi estranei	42-05
DAVIS-BOYLE apribocca	48-04
DAVIS	
dissettore per duramide	EA-05
pinza per sterilizzazione	28-02

DAY uncinetto auricolare.....	44-07	ALAN-PARKS per l'ano e il retto.....	68-03	CUSHING.....	18-07
DEAN		BAKES per condotti biliari.....	62-06	CUSHING per nervi.....	EA-04
coltello per iridettomi.....	42-04	BROCK per valvole mitrali.....	FG-26	DANDY per nervi.....	EA-04
forbici tonsillari.....	08-26	CASTROVIEJO canale lacrimale.....	42-10	DARLING.....	18-17
DEAVER		COOLEY per valvole mitraliFG-27 lavorare a		DAVIDSON Scapula.....	18-13
divaricatore.....	18-05	FG-29		DEAVER.....	18-05
forbici.....	07-05, 08-06	COOLEY vascolare.....	FG-30	DEAVER Grip.....	18-05
DEAVER Grip divaricatore.....	18-05	DE BAKEY vascolare.....	FG-31	DESMARRES.....	18-07
DE BAKEY BAHNSON		GERBODE per valvole mitrali.....	FG-28	DIMEDA.....	18-14
pinza atraumatica per aneurisma di aortaBD-14		GOODELL uterini.....	70-30	DOYEN.....	18-12
DE BAKEY		HANK uterini.....	70-28	FARABEUF.....	18-02
dilatatore vascolare.....	FG-31	HEGAR uterini.....	70-24 lavorare a 70-27	FINOCHIETTO-BABY costali.....	FG-09
forbici vascolari.....	08-30	HETZER per valvole mitrali.....	FG-29	FINOCHIETTO BURFORD	
DE BAKEY MORRIS pinza atraumatica.....	BD-16	LABORDE tracheale.....	54-02	costali.....	FG-12 lavorare a FG-14
DE BAKEY PINZA atraumatica		PRATT uterini.....	70-29	FINOCHIETTO costaliFG-08, FG-10 lavorare a	FG-11
11-03, BD-02, BD-08, BD-16 lavorare a BD-17,		SIMS uterini.....	70-30	FINOCHIETTO-HAIGHT BABY costali.....	FG-10
BD-20, BD-29 lavorare a BD-30		SMITH-BUIE per l'ano e il retto.....	68-03	FINOCHIETTO INFANT costali.....	FG-12
pinza atraumatica anastomosi.....	BD-25	TROUSSEAU tracheale.....	54-02	FINOCHIETTO (modif) costali.....	FG-08
pinza atraumatica anastomosi, pediatricaBD-		TUBBS per valvole mitrali.....	FG-27	FINSEN.....	18-14
28		WILDER canale lacrimale.....	42-10	FOMON nasale.....	46-17
pinza atraumatica bronchi.....	BD-19	WYLIE uterini.....	70-30	FRAZIER.....	18-21
pinza atraumatica bulldog.....	12-02	ZIEGLER canale lacrimale.....	42-10	FRIEDMAN perineorraf.....	70-23
pinza atraumatica		DIMEDA Alu diapason.....	44-03	FRTISCH.....	18-11
dissezione e per legature.....	BD-25, BD-32	DIMEDA		GELPI addominale.....	18-24
pinza atraumatica iliaca.....	BD-11	calamita oculistiche.....	43-08	GERSTER per tenaglie.....	32-11
pinza atraumatica		divaricatore.....	18-14	GOELET.....	18-03
per aneurisma di aortaBD-13, BD-15, BD-18		forbici bendaggi.....	08-46	GOSSET addominale.....	18-21
pinza atraumatica vascolare.....	BD-06	pinza per rifiuti.....	28-03	GRAHAM per nervi.....	EA-04
port'aghi.....	24-03	pinza rompe lamette.....	06-14	GREEN.....	18-10
DE BAKEY REYNOLDS		specillo.....	20-03	HABERER.....	18-04
pinza atraumatica anastomosi.....	BD-30	taglia anelli.....	33-03	HAIGHT costali.....	FG-15
DE BAKEY SATINSKY		Dinamometro COLLIN.....	02-03	HARRINGTON.....	18-05
pinza atraumatica.....	BD-22	DINGMANN tenaglia per ossa.....	32-10	HEANEY.....	18-12
DE BAKEY		Dissettore		HERTZLER costali.....	FG-17
tubi d'aspirazione.....	04-04	DAVIS per duramide.....	EA-05	HOFER pillare.....	50-02
DEJERINE martelli percussori.....	02-07	GREEN per corneale.....	42-06	HRYNTSCHAK per prostata.....	66-06
De LEE forcipe obstetrici.....	72-02	HORSLEY per duramide.....	EA-06	INGE per corpi vertebrali.....	EA-07
De MARTEL guida sega.....	EA-05	HURD tonsille.....	50-02	ISRAEL.....	18-11
DeMARTEL-WOLFSON pinza per anastomosi64-		MILLIGAN per duramide.....	EA-05	JANSEN.....	18-14
07		PATON per corneale.....	42-05	JUDD-MASSON vescicale.....	66-04
DENHART apribocca.....	48-03	PENFIELD per duramide.....	EA-06	KELLY.....	18-04, 18-12
Depressore		per duramide.....	EA-05	KELLY GRIP.....	18-04
BRAUN uterino.....	70-39	ROBB vascolare.....	FG-33	KIRSCHNER addominale.....	18-23
SIMS uterino.....	70-39	SACHS per duramide.....	EA-05	KNAPP.....	42-06
Depressor REICHERT epiglottide.....	52-02	TOENNIS per duramide.....	EA-05	KOCHER.....	18-10 lavorare a 18-11
DERF port'aghi.....	24-02	Dissezione bisturi.....	06-15	KOERTE.....	18-11
Dermatomo		Ditale LANGENBECK.....	48-06	labbra e guance.....	48-03
BRAITHWAITE.....	06-22	DITTEL		LAHEY.....	18-08
HUMBY.....	06-20	candeletta dilatatrici..66-18 lavorare a 66-19		LANGENBECK.....	18-09
SCHINK.....	06-21	mandrino per sonde uretrali.....	66-11	LEGUEU vescicale.....	66-06
SILVER.....	06-20	Divaricatore.....	18-06, 18-10	LITTLE.....	18-08
WATSON.....	06-22	ADSON.....	18-15	LOVE per nervi.....	EA-04
DERRA pinza atraumatica.....	BD-28	ADSON Baby.....	18-15	LOVE uvula.....	50-02
DESCHAMPS ago per legature.....	26-02	ADSON per nervi.....	EA-04	MATHIEU.....	18-03
DESJARDINS		ALM.....	18-14	MERCEDES per il torace.....	FG-16
cucchiaio per calcoli biliari.....	62-08	AUFRIEHT nasale.....	46-17	MEYERDING.....	18-08
pinza per calcoli biliari.....	62-02	BALFOUR addominale.....	18-22	MIDDELDORPF.....	18-10
pinza vie biliari.....	12-15	BALFOUR Baby addominale.....	18-22	MIKULICZ.....	18-12
sonda per calcoli biliari.....	62-05	BECKMANN.....	18-16	MILLIN del collo vescicale.....	66-07
DESMARRES		BECKMANN-ADSON.....	18-15	MILLIN vescicale.....	66-05
divaricatore.....	18-07	BECKMANN-EATON.....	18-16	MOLLISON.....	18-17
pinza calazio.....	43-06	BOSE tracheale.....	54-02	MORSE-FAVOLORO costali.....	FG-17
DEUTSCHMANN coltello per cataratta.....	42-03	CASPAR.....	18-20	Divaricatore muscolari uncinici.....	18-25
DeVILBISS pinza cranocraniana.....	EA-05	CASPAR lombar vertebrale.....	18-20	Divaricatore	
DEWEY forcipe obstetrici		CASPAR spina cervica.....	18-18	NAGER palat.....	50-02
con dispositivo di trazione.....	72-05	CASPAR spina vertebrale.....	18-19	OLLIER.....	18-10
Diamant tagliafilari.....	33-12	CASTANEDA costali.....	FG-14	O'SULLIVAN-O'CONNOR addominale.....	18-21
Diapason.....	44-04	CHEVALLIER costali.....	FG-15	PARKER.....	18-02
DIMEDA Alu.....	44-03	CLOWARD.....	18-17	PITHA labbra.....	48-06
HARTMANN.....	44-03	CLOWARD per corpi vertebrali.....	EA-07	PLESTER.....	18-14
LUCAE.....	44-04	COLLIN addominale..18-24 lavorare a 18-25		REVERDIN.....	18-04
RYDEL-SEIFFER.....	44-04	COLLIN-HARTMANN.....	18-03	RIBBON.....	18-04
DIFFENBACH pinza serratina bulldog.....	12-03	COOLEY costali.....	FG-09	RICHARDSON.....	18-04
DIETER pinza la testa de mastello.....	44-10	COOLEY modif- STRUCK per cavità.....	FG-20	RICHARDSON-EASTMAN.....	18-04
DIETHRICH		COOLEY per cavità.....	FG-20	RICHARDSON Grip.....	18-04
forbici vascolari.....	08-29	CORYLLOS Thorax.....	18-13	RIGBY addominale.....	18-24
Pinza atraumatica.....	BD-31	COTTLE nasale.....	46-17	ROLLET.....	42-06
port'aghi vascolare.....	24-06	COTTLE-NEIVERT nasale.....	46-17	ROUX.....	18-02
Dilatatore		CRILE.....	18-02		



ROUX aortica mini .....	18-02
ROUX BABY .....	18-02
SACHS per nervi .....	EA-04
SAUERBRUCH .....	18-13
SCHOENBORN tiroide .....	54-04
SENN .....	18-04
SENN-GREEN .....	18-07
SIMON .....	18-12
SMITHWICK per nervi .....	EA-04
STERNBERG labbra .....	48-02
TAYLOR spina .....	32-24
THOMSON-WALKER vescicale .....	66-06
TUFFIER costali .....	FG-16
US Army (PARKER-LANGENBECK) .....	18-03
VOLKMANN .....	18-07 lavorare a 18-08
WEITLANER .....	18-14
WEITLANER-WULLSTEIN .....	18-14
YOUNG per prostata .....	66-02
Divaricatori	
BEESON per gessi .....	30-03
HAGLUND-STILLE per gessi .....	30-03
HENNIG per gessi .....	30-03
HERMANN per gessi .....	30-03
Divaricatori per gessi .....	30-03
Divaricatori	
QUATTRO per gessi .....	30-03
Divisore per craneo VIRCHOW .....	32-17
DIX	
ago .....	42-09
scalpello per corpi estranei .....	42-06
DOUGLAS	
pinza depilatoria .....	43-08
tre quarti .....	22-02
DOYEN-Baby pinza intestinali .....	64-03
DOYEN	
divaricatore .....	18-12
forbici ginecologiche .....	08-33
fresa .....	33-07
DOYEN-JANSEN apribocca .....	48-03
DOYEN	
periototomo costali .....	32-20
pinza fissateli .....	14-05
pinza intestinali .....	64-03
pinza per polipi uterine .....	70-36
sonda .....	20-02
specolo vaginali .....	70-18, 70-20
tiramiomi per fibromi .....	70-46
DUBOIS forbici ginecologiche .....	08-33
DUPLAY	
pinza per abbassare il collo dell'utero .....	70-31
pinza per medicatura .....	16-14
DUPUY-WEISS ago tonsille .....	50-03
DUVAL	
pinza dissezione .....	10-04
pinza per afferrare tessuti .....	64-03
E	
ECHLIN pinza sgorbia .....	32-05
EDWARDS	
clip .....	BD-21
pinza applicatore per clips .....	BD-21
Elettrodo per coagulazione miniJA-02 lavorare a JA-03	
Elevatore	
ADSON .....	32-21
BALLENGER setto .....	46-12
BENNETT per ossa .....	32-22
BLOUNT per ginocchio .....	32-24
BLOUNT per ossa .....	32-24
COTTLE periototomo .....	46-12
COTTLE setto .....	46-12
FREER setto .....	46-11
HAJEK-BALLENGER setto .....	46-12
HENKE tonsille .....	50-02
HOHMANN mini per ossa .....	32-23
HOHMANN per ossa 32-22 lavorare a .....	32-23
JOSEPH periototomo .....	46-12
KEY .....	32-21
KILLIAN setto .....	46-12
LANGENBECK .....	32-21
LEMPERT .....	44-15
McDONALD .....	32-22
McKENTY setto .....	46-11
MURLESS per testa .....	72-05
MURPHY-LANE .....	32-22
per ossa .....	32-23
ROGER setto .....	46-11
WATSON-CHEYNE .....	32-22
ELLIOT	
forbici obstetriche .....	72-02
trapano corneale .....	43-08
ELLIS sgorbia per corpi estranei .....	42-06
ELSAESSER pinza per nefrostomia .....	62-13
ELSCHNIG	
coltello per corneale .....	42-05
pinza capsulare .....	43-04
pinza fissaggio .....	43-03
spatola ciclodialisi .....	42-08
EMMET uncinì per fistole .....	70-46
Emostasi PASSOW .....	44-15
ENGEL sega per gessi .....	30-02
EPPENDORFER-KEVORKIAN	
pinza tagliente per biopsia .....	70-46
EPPENDORFER	
pinza tagliente per biopsia 70-45 lavorare a 70-46	
EPPENDORFER TISCHLER-MORGAN	
pinza tagliente per biopsia .....	70-46
ERBE SELECT cavo elettrobisturi .....	JA-07
ESMARCH	
coltello per gessi .....	30-04
forbici bendaggi .....	08-46
EVES serranodi tonsille .....	50-04
F	
FARABEUF	
divaricatore .....	18-02
FARABEUF-LAMBOTTE tenaglia per ossa .....	32-08
FARABEUF	
periototomo .....	32-19
tenaglia per ossa .....	32-07
FARREL specillo .....	20-03
FAULKNER curretta tagliente .....	46-18
FAURE	
pinza peritoneali .....	12-17
pinza tagliente per biopsia .....	70-41
FEHLAND pinza intestinali .....	64-06
FEILCHENFELD pinza schegge .....	10-06
FERGUSSON	
cucchiaio per calcoli biliari .....	62-07
forbici .....	08-49
pinza emostatica .....	12-07
tenaglia per ossa .....	32-07
FERRIS pinza dissezione .....	10-04
FERRIS-SMITH-KERRISON pinza tagliente per dischi intervertebrali .....	EA-10
FERRIS-SMITH pinza tagliente per laminectomia EA-09	
FILIFORM candele .....	66-12
Fili	
KIRSCHNER .....	33-09
per ossa .....	33-11
FINOCHIETTO-BABY divaricatore costali .....	FG-09
FINOCHIETTO BURFORD	
divaricatore costali .....	FG-12 lavorare a FG-14
FINOCHIETTO	
divaricatore costali FG-08, FG-10 lavorare a FG-11	
forbici rette .....	08-38
FINOCHIETTO-HAIGHT BABY divaricatore costali FG-10	
FINOCHIETTO INFANT divaricatore costali FG-12	
FINOCHIETTO (modif) divaricatore costali .....	FG-08
FINOCHIETTO	
pinza per bronchi .....	FG-21
port'aghi .....	24-04
FINSEN divaricatore .....	18-14
FINSTERER canunule per aspirazione e irrigazione .....	04-05
FISCHER pinza iride .....	42-13
FISCH scollato .....	44-15
FLETCHER JAVERTS pinza per tamponi e spugne 16-10	
FLEURANT tre quarti .....	22-02
FOERSTER	
pinza iride .....	42-12
pinza per tamponi e spugne 16-06 lavorare a 16-08	
FOMON	
divaricatore nasale .....	46-17
forbici nasali .....	07-18, 08-25
raspa nasale .....	46-15 lavorare a 46-16
scalpello plastica nasale .....	46-13
Forbici 07-02 lavorare a 07-04, 08-02 lavorare a 08-04	
AEBLI corneali .....	08-22
auricolari micro .....	44-11
auricolari micro mini .....	44-11
BARRAQUER colibri .....	09-04
BEEBEE filo metallo lamiera .....	08-43
BELLUCCI auricolari micro .....	44-09
BERGMANN bendaggi .....	08-46
BEUSE .....	08-26
BOETTCHER tonsillari .....	08-27
BRAUN-STADLER episiotomia .....	07-22, 08-34
BRUNS gesso .....	08-48
BUCK per legature .....	08-40
BUSCH ombelicali .....	08-34
CASTROVIEJO corneali .....	09-06
CASTROVIEJO iridectomia .....	09-05
COTTLE nasali .....	07-18, 08-25
CRAFOORD pulmonari .....	08-36
CROCE RSSSA bendaggi .....	08-47
DANDY neurochirurgia .....	08-36
DEAN tonsillari .....	08-26
DEAVER .....	07-05, 08-06
DIMEDA bendaggi .....	08-46
Forbici dissezione .....	08-19
Forbici	
DOYEN ginecologiche .....	08-33
DUBOIS ginecologiche .....	08-33
Forbici enterotomia .....	08-39
Forbici	
ESMARCH bendaggi .....	08-46
FERGUSSON .....	08-49
Forbici fini .....	08-05, 08-19, 08-24
Forbici	
FINOCHIETTO rette .....	08-38
FOMON nasali .....	07-18, 08-25
Forbici gesso .....	08-49
Forbici ginecologiche micro 09-07 lavorare a 09-08	
Forbici gingivali .....	08-41
Forbici	
GOLDMAN-FOX gingivali .....	08-41
GORNEY dissezione .....	08-13
HEATH per legature .....	08-40
HEYMANN nasali .....	07-18, 08-25
Forbici incisione .....	08-05
Forbici	
IRIS .....	07-16, 08-19, 08-21
IRIS oftalmologia .....	08-22
JACOBSON micro .....	09-11
JOSEPH .....	07-14, 08-16
KELLY ginecologiche .....	07-22, 08-33
KILNER .....	07-14, 08-17
KLINKENBERGH-LOTH toracali .....	08-37
KNAPP .....	08-20
KNOWLES bendaggi .....	08-47
LAGRANGE gingivali .....	08-41
LANDOLT enucleazione .....	08-25
LANGE bendaggi .....	08-44
LEXER .....	07-09
LEXER-BABY .....	07-10
LEXER-BABY dissezione .....	08-12
LEXER dissezione .....	08-11

LEXER-FINO dissezione.....	08-12	De LEE obstetriche.....	72-02	GIERTZ-STILLE costotomo.....	FG-06
LISTER bendaggi.....	07-23, 08-45	DEWEY obstetriche con dispositivo di tranzione.....	72-05	GIGLI manico per sega.....	EA-05
LITTAUER per legature.....	08-40	ELLIOT obstetriche.....	72-02	GILL-ARRUGA pinza capsulare.....	43-03
LITTLER dissezione.....	08-13	KIELLAND-LUIKART obstetriche.....	72-03	GILL	
LOCKLIN.....	08-18	KIELLAND obstetriche.....	72-02	coltello per corneale.....	42-05
LORENZ bendaggi.....	08-47	LUIKART obstetriche.....	72-03	GILL-HESS pinza iride.....	42-12
MAYO.....	07-06, 08-07	McLEAN-LUIKART obstetriche.....	72-03	GILLIES	
MAYO mancini.....	08-07	McLEAN obstetriche.....	72-04	pinza dissezione.....	10-05
MAYO-NOBLE.....	07-08, 08-10	McLEAN-TUCKER-LUIKART obstetriche.....	72-03	port' aghi.....	24-05
MAYO-STILLE..07-07, 08-08 lavorare a	08-09	NAEGELE obstetriche.....	72-03	uncinetto.....	46-17
McGUIRE corneali.....	09-05	PIPER obstetriche.....	72-04	GILL	
McINDOE cartilago.....	08-35	PIPER obstetriche con dispositivo di tranzione.....	72-04	pinza iride.....	42-12
McPHERSON WESTCOTT tendini.....	09-04	SIMPSON-BRAUN obstetriche.....	72-02	Giraviti.....	33-14 lavorare a 33-15
METZENBAUM.....	07-11	SIMPSON-LUIKART obstetriche.....	72-03	LANE.....	33-14
METZENBAUM dissezione08-13 lavorare a	08-14	SIMPSON obstetriche.....	72-02	WILLIAMS.....	33-14
METZENBAUM FINO.....	07-12	TARNIER obstetriche con dispositivo di tranzione.....	72-05	GLOVER	
METZENBAUM FINO dissezione.....	08-15	WRIGLEY obstetriche.....	72-02	pinza atraumatica.....	BD-06, BD-30
METZENBAUM "S".....	07-13, 08-16	FORD BOWLES stetoscopio.....	02-06	pinza atraumatica anastomosi.....	BD-05
Forbici micro.....	09-06	FORD stetoscopio.....	02-06	pinza atraumatica bulldog.....	12-02
Forbici		Forbici		pinza atraumatica coartazione.....	BD-04
MICRO micro.....	09-13	DE BAKEY vascolari.....	08-30	GLUCK costotomi.....	FG-03
Forbici neurochirurgia.....	08-35	DIETHRICH vascolari.....	08-29	GOELET divaricatore.....	18-03
Forbici		GOOD tonsillari.....	08-27	GOLDMAN-FOX forbici gingivali.....	08-41
NORTHBENT per legature.....	08-40	MILLS vascolari.....	08-27	GOLDSTEIN blefarostato.....	42-03
NOYES iridectomia.....	09-03	parametrio vascolari.....	08-31	Goniometro MOELTGEN.....	02-08
NOYES iris.....	09-04	POTTS DE MARTEL vascolari.....	08-27	GOODELL dilatatore uterini.....	70-30
NOYES tendini.....	09-03	POTTS-SMITH vascolari.....	08-28	GOOD forbici tonsillari.....	08-27
per pelle.....	74-03	PRINCE tonsillari.....	08-27	GORNEY forbici dissezione.....	08-13
per unghie.....	74-03	Forbici vascolari.....	08-27	GOSSET divaricatore addominale.....	18-21
POTTS-SMITH vascolari.....	07-19	FOX curetta per lupus.....	74-02	GOURDET curetta uterine.....	70-48
Forbici preparazioni.....	08-34	FRAENKEL		GRADLE pinza depilatoria.....	43-08
Forbici		pinza laringe.....	52-03	GRAEFE	
QUINBY gingivali.....	08-42	pinza polipus laringe.....	52-02	blefarostato.....	42-02
REYNOLDS.....	07-15, 08-18	FRANCESCHETTI trapano corneale.....	43-07	cistotomo.....	42-06
SANVENERO.....	07-13, 08-16	FRANCIS ago per corpi estranei.....	42-05	coltello per cataratta.....	42-03
SATINSKY toracali.....	08-37	FRANKLIN-SILVERMANN ago da punzione.....	22-03	curetta per cataratta.....	42-07
SCHMIEDEN-TAYLOR.....	08-36	FRAZIER		pinza dissezione.....	10-03
SCHUMACHER ombelicali.....	08-34	divaricatore.....	18-21	pinza fissaggio.....	43-03
SCHUMACHER per sterno.....	FG-07	tubi d' aspirazione.....	04-06	pinza iride.....	42-11
SEUTIN per gessi.....	30-02	uncinetto.....	18-06	scarificatore.....	42-04
SHEA auricolari micro.....	44-09	FREER		GRAEFE-TITAN uncino per strabismo.....	42-06
SHORTBENT per legature.....	08-40	bisturi mucosa.....	46-10	GRAEFE	
SIEBOLD ginecologiche.....	07-21, 08-32	coltello setto.....	46-10	uncinetto.....	18-06
SIMS ginecologiche.....	07-21, 08-32	elevatore setto.....	46-11	uncino per strabismo.....	42-06
SMITH US ARMY bendaggi.....	08-44	scalpello setto.....	46-12	GRAHAM divaricatore per nervi.....	EA-04
SPENCER per legature.....	08-40	sgorbias nasale.....	46-14	GRAVE specolo vaginali.....	70-02
STELZNER rette.....	08-38	FREEWAY-GRAVE specolo vaginali.....	70-06	GRAY pinza via biliari.....	12-15
STEVENS tenotomia.....	07-17	FRENZEL abassalingua.....	48-02	GREEN-ARMYTAGE pinza emostatica per tagli cesari.....	72-06
STEVENS tenotomy.....	08-23	FRESA		GREEN	
STILLE per gessi.....	30-02	ALBEE.....	33-07	dissettore per corneale.....	42-06
Forbici strabismo.....	07-17, 08-24	BORCHARDT.....	33-07	divaricatore.....	18-10
Forbici		FRESA cuneiforme HUDSON.....	33-04	pinza fissaggio.....	43-03
STRULLY neurochirurgia.....	08-35	FRESA		uncino muscolare.....	42-06
THOREK pulmonari.....	08-36	DOYEN.....	33-07	GREGORY pinza atraumatica profonda.....	BD-33
TOENNIS-ADSON neurochirurgia.....	08-35	per corticalis.....	33-15	GREVEN pinza auricolare micro.....	44-10
TROUTMAN-CASTROVIEJO micro.....	09-07	TOTI.....	33-07	GRIP pinza per afferare.....	33-11
UNIVERSAL bendaggi.....	08-50	FRIEDMAN		GROSS	
UNIVERSAL filo metallo lamiera.....	08-42	divaricatore perineorraf.....	70-23	curetta auricolare.....	44-06
USA MODEL ombelicali.....	08-34	pinza sgorbia.....	32-02	GROSS-MAIER pinza per medicatura 16-2 lavorare a 16-4	
VANNAS iridectomia.....	09-05	pinza sgorbia, mini.....	32-02	GROSS	
VANNAS micro.....	09-12 lavorare a 09-13	FRTISCH divaricatore.....	18-11	pinza per medicatura.....	16-05
Forbici vascolari micro.....	09-09	FRYKHOLM pinza sgorbia.....	32-05	GRUBER specoli auricolare.....	44-02
Forbici vascolari parametrium.....	07-20	FUCHS pinza capsulare.....	43-04	Guida sega De MARTEL.....	EA-05
Forbici		G		GUTHRIE uncinetto.....	18-06
WAGNER.....	07-22	GALLAHER raspa per seno.....	46-16	GUTMANN cucchiara per secrezioni.....	66-11
WAGNER gingivali.....	08-42	GAUSS pinza per pericranio.....	72-06	GUYON	
WALDMANN episiotomia.....	08-34	GELLHORN pinza tagliente per biopsia.....	70-42	candeletta dilatatrice66-12, 66-14 lavorare a 66-15	
WECKER tendini.....	09-04	GELPI divaricatore addominale.....	18-24	mandrino per sonde uretrali.....	66-11
WERTHEIM preparazion.....	08-32	GEMINI MINI pinza dissezione e per legature 12- 10		pinza peduncolo renale.....	12-16
WESTCOTT iridectomie.....	09-02	GEMINI pinza dissezione e per legature.....	12-10	GUYTON-LUNDSGAARD sclerotomo.....	42-05
WESTCOTT tendini.....	09-02	GERALD pinza dissezione.....	10-05	H	
WULLSTEIN auricolari micro.....	44-11	GERBODE dilatatore per valvole mitrali.....	FG-28	HABERER divaricatore.....	18-04
WULLSTEIN auricolari micro mini.....	44-11	GERSTER divaricatore per tenaglie.....	32-11	HAGLUND-STILLE divaricatori per gessi.....	30-03
YASARGIL micro.....	09-10 lavorare a 09-11	GERZOG martello.....	32-18	HAIGHT divaricatore costali.....	FG-15
Forchetta BURCH di fissaggio.....	42-05	H		HAJEK-BALLENGER elevatore setto.....	46-12
Forbici		HABERER divaricatore.....	18-04		
BARTON obstetriche.....	72-04	HAGLUND-STILLE divaricatori per gessi.....	30-03		
BOERMA obstetriche.....	72-04	HAIGHT divaricatore costali.....	FG-15		

HAJEK-CLAUS pinza seno .....	46-08	HUBER manico universale .....	52-03	KALT-ARRUGA port'aghi.....	24-07
HAJEK-KOFLER pinza tagliente nasale .....	46-08	HUDSON		KALT	
HAJEK sgorbia nasale .....	46-14	fresa cuneiforme .....	33-04	pinza capsulare.....	43-04
HALLE		perforatore a mano .....	33-04	port'aghi.....	24-07
bisturi per duramide .....	EA-06	HUMBY dermatomo.....	06-20	KANE pinza ombelicale.....	72-06
curetta tagliente .....	32-13	HUNTER pinza schegge.....	10-06	KEITH ago suture.....	26-06
HALSEY port'aghi.....	24-02	HURD dissestere tonsille .....	50-02	KELLY	
HALSTEAD-MOSQUITO micro pinza emostatica		I		divaricatore .....	18-04, 18-12
12-04		Imbuti .....	88-07	forbici ginecologiche .....	07-22, 08-33
HALSTEAD-MOSQUITO		INGE divaricatore per corpi vertebrali.....	EA-07	KELLY GRIP divaricatore .....	18-04
pinza atraumatica .....	BD-02	Insuffiatore		KELLY	
pinza emostatica .....	12-04	KABIERSKE per polvere .....	44-04	pinza emostatica .....	12-05
HALSTEAD-MOSQUITO TITAN pinza emostatica		POLITZER d'aria.....	44-05	pinza per polipi uterine .....	70-36
12-04		IOWA pinza per abbassare il collo dell'utero70-		proctoscopio .....	68-04
Hamburg cannula bottonuta .....	43-07	35		KELLY-RANKIN pinza emostatica .....	12-05
HANK dilatatore uterini .....	70-28	IRIS		KELLY TITAN pinza emostatica .....	12-05
HARKEN pinza atraumatica ventricolari .....	BD-23	forbici .....	07-16, 08-19, 08-21	KERN tenaglia per ossa .....	32-08
HARRINGTON		forbici oftalmologia .....	08-22	KERRISON pinza tagliente nasale .....	46-08
divaricatore.....	18-05	Irrigatore .....	88-05	KEVORKIAN	
pinza per bronchi .....	FG-21	ISRAEL divaricatore .....	18-11	curetta di aspirazione per biopsia .....	70-40
HARTMANN		Isterometro		KEVORKIAN-Pacific pinza tagliente per biopsia70-	44
abassalingua .....	48-02	COLLIN .....	70-39	KEVORKIAN	
diapason .....	44-03	MARTIN .....	70-39	pinza tagliente per biopsia .....	70-43, 70-46
HARTMANN-HALLE specolo nasale.....	46-02	SIMS .....	70-39	KEY elevatore .....	32-21
HARTMANN-HOFFMANN pinza auricolare.....	44-08	VALLEIX.....	70-39	KEYES set di trapani cutanei.....	74-02
HARTMANN		ITARD sonda auricolare .....	44-06	KIELLAND forcipe obstetrici .....	72-02
pinza auricolare .....	44-08	ITERSON uncino tracheale .....	54-02	KIELLAND-LUIKART forcipe obstetrici .....	72-03
pinza emostatica .....	12-03	IVES-FANSLER anoscopio .....	68-04	KILLIAN	
pinza nasale polipus .....	46-04	J		cannula .....	46-09
pinza tagliente nasale .....	46-07	JACKSON		KILLIAN-CLAUS sgorbia nasale .....	46-14
sonda auricolare.....	44-06	pinza taponi.....	52-02	KILLIAN	
specoli auricolare .....	44-02	specolo vaginali .....	70-16	elevatore setto .....	46-12
HARTMANN-WULLSTEIN pinza auricolare.....	44-08	tubo tracheale .....	54-03	specolo setto .....	46-03
HEANEY		uncino tracheale .....	54-02	KILNER-DOUGHTY apribocca .....	48-05
divaricatore.....	18-12	JACOBSON forbici micro .....	09-11	KILNER	
pinza isterectomia.....	12-18	JACOBS pinza per abbassare il collo dell'utero70-		forbici.....	07-14, 08-17
port'aghi.....	24-03	34		uncinetto per pelle .....	74-02
HEATH forbici per legature.....	08-40	JAEGER		KIRBY-ARTHUR pinza iride.....	42-13
HEBRA curetta per calazio .....	42-07	cheratomo .....	42-04	KIRK martello .....	32-18
HEGAR dilatatore uterini 70-24 lavorare a		placca per palpebre.....	42-03	KIRSCHNER	
70-27		JAMESON		arco per estensione.....	33-10
HEGENBARTH pinza per agrafes .....	26-07	pinza strabismo .....	42-13	divaricatore addominale.....	18-23
HEIFETZ spatole cerebr .....	EA-07	uncino per strabismo .....	42-06	filii .....	33-09
HEIMING pinza per calcoli renali .....	62-13	JAMISON port'aghi.....	24-03	perforatore a mano.....	33-05
HEISS pinza emostatica .....	12-09	JANSEN		sonda conduttrice.....	26-04
HEISTER apribocca .....	48-03	divaricatore.....	18-14	telaio .....	18-23
HENKE elevatore tonsille.....	50-02	pinza nasale .....	46-04	valva per telaio .....	18-23
HENNIG divaricatori per gessi .....	30-03	JARCHO pinza per abbassare il collo dell'utero		KLINKENBERGH-LOTH forbici toracali .....	08-37
HENROTIN pinza per abbassare il collo dell'utero		70-32		KNAPP	
70-34		JATHO pinza nasofarinx tagliente .....	46-18	coltello per iridectomi.....	42-04
HERMANN divaricatori per gessi .....	30-03	JAVID pinza atraumatica carotis.....	BD-32	curetta per cataratta.....	42-07
HERRICK pinza peritoneali .....	12-17	JENNINGS apribocca .....	48-04	divaricatore.....	42-06
HERTZLER divaricatore costali .....	FG-17	JOBSON-HORNE specillo .....	20-03	forbici .....	08-20
HESS		JOHNS-HOPKINS		KNAPP-LUER pinza trichiasi .....	43-06
pinza capsulare.....	43-04	pinza serrafina bulldog .....	12-03	KNIGHT pinza tagliente nasale .....	46-05
pinza iride .....	42-12	pinza vie biliari .....	12-14	KNOWLES forbici bendaggi .....	08-47
HETZER dilatatore per valvole mitrali.....	FG-29	JOHNSON port'aghi.....	24-04	KNUTSON-KOCH cono per uretrografia.....	66-09
HEYMANN		JONES pinza fissateli porta tubo .....	14-02	KNUTSON strumento per uretrografia .....	66-09
forbici nasali .....	07-18, 08-25	JOSEPH		KOCHER	
HEYMANN-KNIGHT pinza nasale polipus .....	46-05	bisturi nasale botton.....	46-10	divaricatore .....	18-10 lavorare a 18-11
HEYMANN		coltello smusso.....	46-10	pinza emostatica delicate .....	12-06
pinza tagliente nasale .....	46-05	elevatore periostotomo .....	46-12	pinza intestinali .....	64-04
HEYWOOD-SMITH pinza per emorroidia.....	68-05	forbici .....	07-14, 08-16	sonda gozzo .....	54-04
HIBBS		JOSEPH (LEWIS) raspa nasale .....	46-15	spatola vescicali .....	66-04
osteotome .....	32-16	JOSEPH		KOENIG	
scalpello .....	32-16	lima per ossa .....	46-14	ago suture.....	26-06
sgorbia .....	32-16	sega nasale.....	46-17	sonda conduttrice.....	26-04
HIRSCHMANN anoscopio .....	68-04	uncinetto .....	18-06	KOERTE divaricatore .....	18-11
HOESEL port'aghi .....	24-05	JUDD-ALLIS pinza per afferrare tessuti .....	64-02	KOGAN specolo endo .....	70-23
HOFER divaricatore pillare.....	50-02	JUDD-MASSON divaricatore vescicale .....	66-04	KONRICH tamburo per sterilizzazione .....	88-12
HOFF pinza fissateli .....	14-03	JURASZ pinza polipus laringe.....	52-02	KRAUSE	
HOHMANN elevatore per ossa32-22 lavorare a		K		pinza laringe.....	52-03
32-23		KABIERSKE insuffiatore per polvere .....	44-04	serranodi .....	46-09
HOHMANN mini elevatore per ossa.....	32-23	KALLMORGEN		serranodi auricolare .....	44-07
HOKE scalpello.....	32-16	specolo vaginali .....	70-15	KRISTELLER	
HOLTH pinza per capsulo .....	42-09	specolo vaginali .....	70-15	specolo vaginali.....	70-09 lavorare a 70-14
HOPKINS coltello per gessi .....	30-04	valva vaginali.....	70-15	valva vaginali .....	70-09 lavorare a 70-14
HORSLEY dissestere per duramide.....	EA-06			KRONECKER ago per legature .....	26-02
HOUSE curetta .....	44-15				
HRYNTSCHAK divaricatore per prostata.....	66-06				

KUENTSCHER					
alesatore.....	33-13				
cavachiodi.....	33-13				
strum per conficc.....	33-13				
KUHNT coltellino per corneale.....	42-05				
<b>L</b>					
LABORDE dilatatore tracheale.....	54-02				
LAFORCE					
adenotomo.....	46-19				
strumenti per corpi estranei.....	42-06				
LAGRANGE forbici gingivali.....	08-41				
LAHEY					
divaricatore.....	18-08				
pinza afferrare gozzo.....	54-04				
pinza vie biliari.....	12-14				
Lama bisturi sterili, micro.....	06-13				
Lama bisutri, sterili.....	06-06				
Lama					
bisutri sterile.....	06-09				
CHARRIERE di ricambio.....	33-03				
Lama di sega.....	30-05 lavorare a 30-06				
Lama					
OTIS die ricambio.....	66-08				
Lama per dermatomo.....	06-21				
Lama per rasoio.....	06-19				
Lama per togliere.....	06-06, 06-10				
LAMBERT KAY					
pinza atraumatica aortica.....	BD-10				
pinza atraumatica iliaca.....	BD-11				
LAMBERT pinza calazio.....	43-06				
LAMBOTTE mini osteotomo.....	32-15				
LAMBOTTE					
osteotomo.....	32-15				
periototomo.....	32-19				
tenaglia per ossa.....	32-08				
Lamette per rasoio.....	06-14				
Lampada frontale CLAR.....	02-05				
Lampadina ricambio per laringoscopia fibre ottiche.....	AE-20				
Lampadina ricambio per laringoscopia standard AE-20					
LANCASTER blefarostato.....	42-03				
Lancetta elettrodo.....	JA-03				
LANDAU specchio vaginali.....	70-22				
LANDOLT					
forbici enucleazione.....	08-25				
manico per bisutri, micro.....	06-13				
LANE					
giraviti.....	33-14				
pinza dissezione.....	10-04				
pinza fissateli.....	14-05				
pinza porta placche.....	33-14				
pinza porta viti.....	33-14				
pinza stomacali.....	64-08				
tenaglia per ossa.....	32-08				
LANG curette.....	42-08				
LANGE					
forbici bendaggi.....	08-44				
LANGENBECK					
coltello per resezione.....	06-17				
ditale.....	48-06				
divaricatore.....	18-09				
elevatore.....	32-21				
periototomo.....	32-19				
sega a dita.....	33-03				
tenaglia per ossa.....	32-07				
LANGE					
pinza laringe.....	52-03				
Laringoscopia manico fibre ottiche.....	AE-11				
Laringoscopia manico standard.....	AE-17				
Laringoscopia set					
MACINTOSH fibre otticheAE-12 lavorare a AE-13					
MACINTOSH standardAE-18 lavorare a AE-19					
MILLER fibre ottiche.....AE-12 lavorare a AE-13					
MILLER standard.....AE-18 lavorare a AE-19					
Laringoscopia spatole					
MACINTOSH fibre ottiche.....	AE-10				
MACINTOSH standard.....	AE-15				
MILLER fibre ottiche.....	AE-10				
MILLER standard.....	AE-16				
LAWRENCE pinza dissezione e per legature	12-13				
LEBSCHKE scalpello sterno.....	32-17				
LEES pinza atraumatica bronchi.....	BD-03				
LEGUEU					
divaricatore vescicale.....	66-06				
spatola vescicali.....	66-04				
LEKSELL STILLIE pinza sgorbia.....	32-05				
LELAND JONES pinza atraumatica vascolare.....	BD-08 lavorare a BD-09				
LEMPERT					
curetta tagliente.....	32-13				
elevatore.....	44-15				
pinza sgorbia.....	32-03				
LERCHE pinza dissezione.....	10-04				
LERICHE pinza emostatica.....	12-09				
LESTER pinza fissaggio.....	43-03				
Leva					
BUCK corpi estranei.....	44-08				
QUIRE corpi estranei.....	44-08				
LEVINSON ago per corpi estranei.....	42-05				
LEWIN tenaglia per ossa.....	32-10				
LEWKOWITZ pinza per placenta e per ovaie	72-07				
LEXER-BABY					
forbici.....	07-10				
forbici dissezione.....	08-12				
LEXER-FINO forbici dissezione.....	08-12				
LEXER					
forbici.....	07-09				
forbici dissezione.....	08-11				
LEXER mini					
scalpello.....	32-16				
sgorbia.....	32-16				
LEXER					
scalpello.....	32-16				
sgorbia.....	32-16				
LEYLA sistema da fissaggioEA-14 lavorare a EA-18					
LICHTWITZ					
ago seno.....	46-09				
frequarti.....	22-02				
LIDDLE pinza atraumatica aorta.....	BD-10				
Lima					
JOSEPH per ossa.....	46-14				
per ossa.....	32-25				
per unghie.....	74-03				
PUTTI per ossa.....	32-25				
LISTER-BURCH blefarostato.....	42-02				
LISTER					
forbici bendaggi.....	07-23, 08-45				
pinza sinus per tamponi e spugne.....	16-11				
LITTON					
cesoia per ossa.....	32-06				
coltello per amputazione.....	06-16				
LITTAUER					
forbici per legature.....	08-40				
pinza auricolare.....	44-08				
pinza depilatoria.....	43-08				
pinza nasale polipus.....	46-05				
LITTLE divaricatore.....	18-08				
LITTLER forbici dissezione.....	08-13				
LOCKLIN forbici.....	08-18				
LORENZ forbici bendaggi.....	08-47				
LORNA pinza fissateli.....	14-04				
LOUTE strumento tendifilo.....	33-11				
LOVE					
divaricatore per nervi.....	EA-04				
divaricatore uvula.....	50-02				
LOVE-GRUENWALD pinza tagliente per laminectomia.....	EA-08				
LOVELACE					
pinza emostatica.....	12-07				
pinza per afferrare il polmone.....	FG-19				
LOWER pinza vie biliari.....	12-14				
LOWMAN tenaglia per ossa.....	32-11				
LUBET-BARBON pinza nasale polipus.....	46-05				
LUCAE					
diapason.....	44-04				
martello.....	32-18				
pinza auricolare.....	44-07				
LUC pinza tagliente nasale.....	46-06				
LUER-KOERTE cucchiaino per calcoli biliari.....	62-09				
LUER					
pinza sgorbia.....	32-03				
tubo tracheale.....	54-03				
LUIKART-BILL trattore per manico standard.....	72-05				
LUIKART forbici ostetriche.....	72-03				
LUNDGAARD sclerotomo.....	42-05				
LUNIATSCHEK otturatore per garza.....	50-02				
LURZ pinza per uretere.....	62-10				
<b>M</b>					
MACINTOSH					
laringoscopia set fibre otticheAE-12 lavorare a AE-13					
laringoscopia set standardAE-18 lavorare a AE-19					
laringoscopia spatole fibre ottiche.....	AE-10				
laringoscopia spatole standard.....	AE-15				
MAGILL					
pinza per introdurre le sonde.....	AE-06				
stiletto.....	AE-04				
tubi d'aspirazione.....	AE-04				
MAIER pinza per medicatura.....	16-12				
MALTZ					
bisturi cartilage angolat.....	46-11				
MALTZ (COTTLE) raspa nasale.....	46-15				
MALTZ					
raspa nasale.....	46-14				
Mandrino					
DITTEL per sonde uretrali.....	66-11				
GUYON per sonde uretrali.....	66-11				
Manico					
BROCK per valvole mitrali.....	FG-26				
CASPAR per bisturi, micro.....	06-12				
COLLIN per bisturi.....	06-08				
GIGLI per sega.....	EA-05				
HUBER universale.....	52-03				
LANDOLT per bisturi, micro.....	06-13				
Manico per bisturi06-02 lavorare a 06-05, 06-07 lavorare a 06-08					
Manico per bisturi, micro.....	06-12				
Manico					
per specchi laringei.....	52-04				
Manometro per salpingografo.....	70-47				
Marcatore					
CASTROVIEJO compasso.....	42-09				
CONNIN-AMSLER.....	42-09				
MARSHIK pinza tonsille.....	50-04				
Martelli percussori					
BABINSKY.....	02-07				
BERLINER.....	02-07				
BUCK.....	02-07				
DEJERINE.....	02-07				
TAYLOR.....	02-07				
TRAUBE.....	02-07				
TROEMNER.....	02-07				
Martello.....	32-18				
COLLIN.....	32-18				
con fessura.....	33-13				
GERZOG.....	32-18				
KIRK.....	32-18				
LUCAE.....	32-18				
MEAD.....	32-18				
QUISLING.....	32-18				
WILLIGER.....	32-18				
MARTEL pinza cuoio capelluto.....	12-08				
MARTIN					
cavo elettrobisturi.....	JA-07				
MARTINI curreta tagliente.....	32-13				
MARTIN					
isterometro.....	70-39				
pelvimetro.....	72-06				
pinza per medicatura.....	16-02, 16-14				



pinza per sequestri	32-10
Maschio per vite	33-15
MASSON port'aghi	24-03
MASTIN pinza muscolare	54-04
MATHIEU	
divaricatore	18-03
pinza per corpi estranei	66-07
port'aghi	24-05
specolo rettale	68-02
MATSON periostotomo	32-21
MAUNDER apribocca legno	48-06
MAYO BLAKE pinza per calcoli biliari	62-04
MAYO	
cucchiaino per calcoli biliari	62-07
forbici	07-06, 08-07
forbici mancini	08-07
MAY oftalmoscopio	02-03
MAYO-GUYON pinza peduncolo renale	12-16
MAYO-HEGAR port'aghi	24-02
MAYO-NOBLE forbici	07-08, 08-10
MAYO	
pinza per sterilizzazione	28-02
MAYO-ROBSON pinza intestinali	64-05
MAYO	
sonda per calcoli renali	62-10
MAYO-STILLE forbici 07-07, 08-08 lavorare a 08-09	
McCLINTOCK pinza per placenta e per ovaie 72-07	
McCULLOUGH pinza strabismo	42-13
McDONALD elevatore	32-22
McGEE pinza auricolare micro	44-10
McGUIRE forbici corneali	09-05
McINDOE	
forbici cartilago	08-35
pinza dissezione	10-04
McIVOR	
abassalingua	48-05
apribocca	48-05
McKENY elevatore setto	46-11
McKENZIE	
perforatore piano	33-04
pinza per applicare e agrafes	EA-02
McLEAN forbici ostetriche	72-04
McLEAN-LUIKART forbici ostetriche	72-03
McLEAN-TUCKER-LUIKART forbici ostetriche	72-03
McPHERSON pinza legature	43-05
McPHERSON TITAN pinza legature	43-05
McPHERSON WESTCOTT forbici tendini	09-04
MEAD	
martello	32-18
pinza sgorbia	32-02
MEEKER pinza dissezione e per legature	12-13
MELLINGER-AXENFELD blefarostato	42-02
MELLINGER blefarostato	42-02
MENGHINI trequarti	22-03
Meniscotomo	
BIRCHER	32-24
NEFF	32-24
SMILLIE	32-24
MERCEDES divaricatore per il torace	FG-16
METZENBAUM FINO	
forbici	07-12
forbici dissezione	08-15
METZENBAUM	
forbici	07-11
forbici dissezione	08-13 lavorare a 08-14
port'aghi	24-04
METZENBAUM "S" forbici	07-13, 08-16
MEYERDING divaricatore	18-08
MEYHOEFER curetta per calazio	42-07
MICHEL	
agrafes	26-07
pinza per agrafes	26-07
specchio	46-04
MICRO forbici micro	09-13
MIDDELORPF divaricatore	18-10
MIDDLETON-JANSEN pinza tagliente nasale	46-09
MIKULICZ	

divaricatore	18-12
pinza peritoneali	12-17
MILLER	
laringoscopio set fibre ottiche AE-12 lavorare a AE-13	
laringoscopio set standard AE-18 lavorare a AE-19	
laringoscopio spatole fibre ottiche	AE-10
laringoscopio spatole standard	AE-16
MILLIGAN dissettore per duramadre	EA-05
MILLIN	
divaricatore del collo vescicale	66-07
divaricatore vescicale	66-05
pinza per afferrare la capsula	66-03
pinza per lobuli anteriori	66-03
pinza porta-filo	66-03
supporto per luce fredda	66-05
MILLS forbici vascolari	08-27
Mini	
astucci tascabili e per sutura	26-08
CLAR	02-05
MIXTER BABY pinza emostatica bronchiale	12-13
MIXTER O'SHAUGNESSY pinza emostatica	12-14
MIXTER	
pinza emostatica	12-14
pinza emostatica bronchiale	12-13
pinza per calcoli biliari	62-04
pinza vie biliari	12-15
MOELTGEN goniometro	02-08
MOGAN strumento per circoncisione	66-09
MOLLISON divaricatore	18-17
MOORE	
cucchiaino per calcoli biliari	62-05
perforatore a mano	33-04
MOORFIELD pinza sutura	43-05
MORSE-FAVOLORO divaricatore costali	FG-17
MOYNIHAN	
pinza fissateli	14-05
pinza vie biliari	12-15
sonda per calcoli biliari	62-05
MUCK coltello periostale	44-15
MUELLER blefarostato	42-03
MURDOCK blefarostato	42-02
MURLESS elevatore per testa	72-05
MURPHY-LANE elevatore	32-22
MURPHY pinza serratubi	12-19
MUSEUX pinza per abbassare il collo dell'utero	70-33
MYLES pinza tagliente nasale	46-07
N	
NABATOFF sonda auricola argento	20-02
NAEGELE forbici ostetriche	72-03
NÄGELE spezzacrano	72-09
NAGER divaricatore palat.	50-02
Nastro metrico	02-08
Nastro PARHAM solo	32-11
NEFF meniscotomo	32-24
NEGUS pinza tonsille	50-03
NEIVERT port'aghi	24-02
NELSON	
ago per legature	26-02
pinza dissezione	10-05
trequarti	22-02
NEUBUSER pinza per afferrare trompe	70-51
NORTHBENT forbici per legature	08-40
NOTO pinza per polipi uterine	70-36
NOVAK curetta di aspirazione per biopsia	70-40
NOYES	
forbici iridectomia	09-03
forbici iris	09-04
forbici tendini	09-03
pinza nasale polipus	46-05
NUBOER tubi d'aspirazione	04-05
O	
OCHSNER	
pinza traumatica aorta	BD-31
trequarti	22-02

O' CONNOR uncino per iris	42-06
Oftalmoscopio	
MAY	02-03
VARIFOCAL	02-03
OLDBERG pinza tagliente per laminectomia	EA-09
OLIVECRONA	
pinza sgorbia	32-03
sega	EA-05
spatole cerebr	EA-07
OLIVECRONA-TOENNIS pinza per applicare e agrafes	EA-02
OLLIER divaricatore	18-10
OLSEN-HEGAR port'aghi	24-05
Osteotome HIBBS	32-16
Osteotomo	32-14
LAMBOTTE	32-15
LAMBOTTE mini	32-15
STILLE	32-14
O'SULLIVAN-O'CONNOR	
divaricatore addominale	18-21
specolo vaginali	70-08
OTIS	
lama die ricambio	66-08
uretrotomo	66-08
Otturatore LUNIATSCHKEK per garza	50-02
OVERHOLT-GEISSENDOERFER pinza dissezione e per legature	12-10
OVERHOLT periostotomo	32-21
P	
Padella	88-06
Parametrio forbici vascolari	08-31
PARHAM nastro solo	32-11
PARK blefarostato	42-03
PARKER	
bisturi per dissezione	06-15
divaricatore	18-02
PARTSCH	
scalpello	32-14
sgorbia	32-14
PASSOW emostasi	44-15
PATON dissettore per corneale	42-05
PAUFIQUE	
coltello per cheratopl	42-05
pinza legature	43-05
PAUFIQUE TITAN pinza legature	43-05
PAYR-Baby pinza stomacali	64-09
PAYR	
pinza stomacali	64-09
sonda conduttrice	26-04
PEAN	
pinza traumatica	BD-02
pinza emostatica	12-08
pinza emostatica delicate	12-06
PEDERSON specolo vaginali	70-03
PEERS BERTRAM pinza fissateli	14-03
PEET pinza schegge	10-06
PELKMANN pinza per medicatura	16-12
Pelvimetro	
COLLIN	72-06
COLLYER	72-06
MARTIN	72-06
PENFIELD dissettore per duramadre	EA-06
PENNINGTON pinza emostatica	12-07
PERCY retractor per amputazione	33-03
Perforatore	
a mano	33-05
BUNNELL a mano	33-05
HUDSON a mano	33-04
KIRSCHNER a mano	33-05
McKENZIE piano	33-04
MOORE a mano	33-04
per mandrino jacobs	33-06
RALK a mano	33-05
STILLE a mano	33-04
STILLE-SHERMAN a mano	33-04
Perforatore CUSHING piano	33-04
Periostotomo	
ALEXANDER	32-19

DOYEN costali .....	32-20	Bonn TITAN iride .....	42-15	BD-28	
FARABEUF .....	32-19	BOZEMANN-DOUGLAS per medicatura .....	16-13	DE BAKEY atraumatica bronchi .....	BD-19
LAMBOTTE .....	32-19	BOZEMANN per medicatura .....	16-13	DE BAKEY atraumatica bulldog .....	12-02
LANGENBECK .....	32-19	BRAIN MINI per posizionare clip .....	EA-12	DE BAKEY atraumatica	
MATSON .....	32-21	BRAIN STANDARD per posizionare clip .....	EA-12	dissezione e per legature .....	BD-25, BD-32
OVERHOLT .....	32-21	BRAUN per abbassare il collo dell'utero .....	70-31, 70-34	DE BAKEY atraumatica iliaca .....	BD-11
SADILLOT .....	32-19	BROCK tagliente .....	FG-26	DE BAKEY atraumatica	
SEMB .....	32-20	BROWN dissezione .....	10-03	per aneurisma di aorta .....	BD-13, BD-15, BD-18
WILLIGER .....	32-19	BRUENINGS laringe .....	52-03	DE BAKEY atraumatica vascolare .....	BD-06
Per per intima .....	FG-32	BRUENINGS tagliente nasale .....	46-05	DE BAKEY BAHNSON atraumatica	
PERTHES punteruoli .....	33-08	BRUNNER intestinali .....	64-06	per aneurisma di aorta .....	BD-14
PESTALOTTA curetta per placenta e per ovaie .....	72-08	BRYANT per tamponi e spugne .....	16-11	DE BAKEY MORRIS atraumatica .....	BD-16
PETRI scatola .....	88-08	BLUMM per afferrare l'utero .....	70-38	DE BAKEY REYNOLDS atraumatica anastomosi	
PETZ apparecchio		BUNT per sterilizzazione .....	28-02	BD-30	
per sutura stomacali e intestinali .....	64-09	BURKE-Baby tagliente per biopsia .....	70-44	DE BAKEY SATINSKY atraumatica .....	BD-22
PHANEUF pinza peritoneali .....	12-17	BURKE tagliente per biopsia .....	70-44	DeMARTEL-WOLFSON per anastomosi .....	64-07
Piastra per tendere la pelle .....	06-21	CARMALT schegge .....	10-06	depilatoria .....	43-08
Pick .....	44-15	CASTANEDA atraumatica .....	BD-42	DERRA atraumatica .....	BD-28
BARBARA .....	44-14 lavorare a	CASTROVIEJO capsulare .....	43-04	DESJARDINS per calcoli biliari .....	62-02
PIERCE trequarti .....	22-02	CASTROVIEJO fissaggio .....	43-03	DESJARDINS vie biliari .....	12-15
PIFFARD curetta per lupus .....	74-02	CASTROVIEJO rompe lamette .....	06-14	DESMARRES calazio .....	43-06
PINARD stetoscopio .....	02-06	CASTROVIEJO sutura .....	43-05	DeVILBISS crancraneanea .....	EA-05
Pinza		CHAPUT emostatica .....	12-08	DIEFFENBACH serrafina bulldog .....	12-03
ADLERKREUTZ dissezione .....	10-04	CHEATLE per sterilizzazione .....	28-02	DIETER la testa de mastello .....	44-10
ADSON BABY emostatica .....	12-09	CHERON per medicatura .....	16-12	Pinza	
ADSON-BROWN dissezione .....	10-03	CHEVALIER-JACKSON laringe .....	52-04	DIETHRICH atraumatica .....	BD-31
ADSON dissezione .....	10-03	CHILDE per agrafes .....	26-07	Pinza	
ADSON dissezione, micro .....	10-03	CITELLI osteotomo .....	46-08	DIMEDA per rifiuti .....	28-03
ADSON emostatica .....	12-09	CLEVELAND sgorbia .....	32-02	DIMEDA rompe lamette .....	06-14
ADSON per ipofisi .....	EA-06	COAGULAZIONE bipolare JA-04 lavorare a	JA-06	Pinza di orologio .....	10-06
ADSON sgorbia .....	32-03	COLCLOUGH tagliente per dischi		Pinza dissezione .....	10-02
ALEXANDER tagliente per biopsia .....	70-42	intervertebrali .....	EA-11	Pinza	
ALLIS-ADAIR per afferrare tessuti .....	64-02	COLLIN-DUVAL dissezione .....	10-04	DOUGLAS depilatorie .....	43-08
ALLIS-Baby per afferrare tessuti .....	64-02	COLLIN emostatica .....	12-08	DOYEN-Baby intestinali .....	64-03
ALLIS per afferrare tessuti .....	64-02	COLLIN ombelicale .....	72-06	DOYEN fissateli .....	14-05
ARCHER schegge .....	10-06	COLLIN per afferrare l'utero .....	70-37	DOYEN intestinali .....	64-03
ARRUGA capsulare .....	43-04	COLLIN per afferrare l'utero .....	70-37	DOYEN per polipi uterine .....	70-36
ASCH raddrizzare setto .....	46-18	COLLIN per agrafes .....	26-07	DUPLAY per abbassare il collo dell'utero .....	70-31
Pinza atraumatica pediatrica vascolare .....	BD-43	COLLIN per medicatura .....	16-11	DUPLAY per medicatura .....	16-14
Pinza		COLLIN-POZZI		DUVAL dissezione .....	10-04
auricolare micro .....	44-09 lavorare a	per abbassare il collo dell'utero .....	70-32	DUVAL per afferrare tessuti .....	64-03
12		COLLIN tiralingua .....	48-03	ECHLIN sgorbia .....	32-05
auricolare micro mini .....	44-13	COLVER tonsille .....	50-03	EDWARDS applicatore per clips .....	BD-21
AYER calazio .....	43-06	COOLEY atraumatica		ELSAESSER per nefrostomia .....	62-13
BABCOCK per afferrare tessuti .....	64-02	11-03, BD-35 lavorare a	BD-37, BD-39, BD-41	ELSCHNIG capsulare .....	43-04
BACKHAUS-CLIP fissateli porta tubo .....	14-03	COOLEY atraumatica anastomosi	BD-37, BD-40	ELSCHNIG fissaggio .....	43-03
BACKHAUS fissateli .....	14-02	COOLEY atraumatica anastomosi	BD-37, BD-40	EPPENDORFER-KEVORKIAN	
BACKHAUS KOCHER fissateli .....	14-02	COOLEY atraumatica bulldog	BD-33 lavorare a	tagliente per biopsia .....	70-46
BAGGISH tagliente per biopsia .....	70-45	BD-34		EPPENDORFER	
BAINBRIDGE atraumatica .....	BD-09	COOLEY atraumatica iliaca .....	BD-37	tagliente per biopsia .....	70-46
BAINBRIDGE emostatica .....	12-14	COOLEY atraumatica pediatrica	BD-38	EPPENDORFER TISCHLER-MORGAN	
BALL AND SOCKET fissateli .....	14-04	lavorare a	BD-39	tagliente per biopsia .....	70-46
BALLENGER tonsille .....	50-04	COOLEY DERRA atraumatica anastomosi	BD-39	FAURE peritoneali .....	12-17
BARRAQ-KATZIN iride .....	42-13	COOLEY DERRA atraumatica anastomosi	BD-39	FAURE tagliente per biopsia .....	70-41
BARRAQU Colibri iride .....	42-13	COOLEY DERRA atraumatica anastomosi	BD-39	FEHLAND intestinali .....	64-06
BARRAQUER camera anteriore .....	43-02	COOLEY vascolare .....	BD-40	FEILCHENFELD schegge .....	10-06
BARRAQUER depilatoria .....	43-08	CORDES laringe .....	52-03	FERGUSON emostatica .....	12-07
BARRAQUER fissaggio .....	43-03	CRAFOORD emostatica bronchiale .....	12-12	FERRIS dissezione .....	10-04
BARRETT per abbassare il collo dell'utero .....	70-32	CRILE emostatica .....	12-05	FERRIS-SMITH-KERRISON tagliente per dischi	
BECK atraumatica vascolare .....	BD-25	CRILE-RANKIN emostatica .....	12-05	intervertebrali .....	EA-11
BEER depilatoria .....	43-08	CRILE TITAN emostatica .....	12-05	FERRIS-SMITH tagliente per laminectomia	EA-09
BENGOLEA emostatica .....	12-09	CRUTCHFIELD per trazione craniale .....	EA-03	FINOCHIETTO per bronchi .....	FG-21
BERGMANN FOERSTER per tamponi e spugne		CUSHING dissezione .....	10-03	FISCHER iride .....	42-13
16-10		CUSHING tagliente per laminectomia .....	EA-08	Pinza fissateli modello delicato .....	14-02
BERKE muscolre .....	43-02	CZERNY per abbassare il collo dell'utero .....	70-34	Pinza	
BERNHARD fissateli .....	14-05	CZERNY per calcoli biliari .....	62-03	FLETCHER JAVERTS per tamponi e spugne	
BEST intestinali .....	64-06	DALE atraumatica vascolare .....	BD-24	10	
BEYER osteotomo .....	46-08	DANDY emostatica .....	12-07	FOERSTER iride .....	42-12
BEYER sgorbia .....	32-04	DARDIK atraumatica .....	BD-07	FOERSTER per tamponi	
BISHOP-HARMAN iride .....	42-14	DARTIGUES per afferrare l'utero .....	70-37	e spugne .....	16-06 lavorare a
BLAKE per calcoli biliari .....	62-03	DASTOOR strabismo .....	42-14	16-08	
BLOHMKE tonsille .....	50-04	DAVIS per sterilizzazione .....	28-02	FRAENKEL laringe .....	52-03
BLUMENTHAL sgorbia .....	32-02	DE BAKEY atraumatica		FRAENKEL polipus laringe .....	52-02
BÖHLER sgorbia .....	32-04	11-03, BD-02, BD-08, BD-16 lavorare a	BD-17, BD-20, BD-29 lavorare a	FRIEDMAN sgorbia .....	32-02
BONACCOLTO strabismo .....	42-14	BD-30		FRIEDMAN sgorbia, mini .....	32-02
BONNEY per tamponi e spugne .....	16-08	DE BAKEY atraumatica anastomosi .....	BD-25	FRYKHOLM sgorbia .....	32-05
Bonn iride .....	42-15	DE BAKEY atraumatica anastomosi, pediatrica		FUCHS capsulare .....	43-04

GEMINI MINI dissezione e per legature 12-10  
GERALD dissezione ..... 10-05  
GILL-ARRUGA capsulare ..... 43-03  
GILL-HESS iride ..... 42-12  
GILLIES dissezione ..... 10-05  
GILL iride ..... 42-12  
GLOVER atraumatica ..... BD-06, BD-30  
GLOVER atraumatica anastomosi ..... BD-05  
GLOVER atraumatica bulldog ..... 12-02  
GLOVER atraumatica coartazione ..... BD-04  
GRADLE depilatorie ..... 43-08  
GRAEFE dissezione ..... 10-03  
GRAEFE fissaggio ..... 43-03  
GRAEFE iride ..... 42-11  
GRAY vie biliari ..... 12-15  
GREEN-ARMYTAGE emostatica  
per tagli cesarei ..... 72-06  
GREEN fissaggio ..... 43-03  
GREGORY atraumatica profonda ..... BD-33  
GREVEN auricolare micro ..... 44-10  
GRIP per afferrare ..... 33-11  
GROSS-MAIER per medicatura 16-02 lavorare  
a 16-04 ..... 16-05  
GROSS per medicatura ..... 16-05  
GUYON peduncolo renale ..... 12-16  
HAJEK-CLAUS seno ..... 46-08  
HAJEK-KOFLER tagliente nasale ..... 46-08  
HALSTEAD-MOSQUITO atraumatica ..... BD-02  
HALSTEAD-MOSQUITO emostatica ..... 12-04  
HALSTEAD-MOSQUITO micro emostatica 12-  
04 ..... 12-04  
HALSTEAD-MOSQUITO TITAN emostatica 12-  
04 ..... 12-04  
HARKEN atraumatica ventricolari ..... BD-23  
HARRINGTON per bronchi ..... FG-21  
HARTMANN auricolare ..... 44-08  
HARTMANN emostatica ..... 12-03  
HARTMANN-HOFFMANN auricolare ..... 44-08  
HARTMANN nasale polipus ..... 46-04  
HARTMANN tagliente nasale ..... 46-07  
HARTMANN-WULLSTEIN auricolare ..... 44-08  
HEANEY isterectomia ..... 12-18  
HEGENBARTH per agrafes ..... 26-07  
HEIMING per calcoli renali ..... 62-13  
HEISS emostatica ..... 12-09  
HENROTIN per abbassare il collo dell'utero  
70-34 ..... 70-34  
HERRICK peritoneali ..... 12-17  
HESS capsulare ..... 43-04  
HESS iride ..... 42-12  
HEYMANN-KNIGHT nasale polipus ..... 46-05  
HEYMANN tagliente nasale ..... 46-05  
HEYWOOD-SMITH per emorroidia ..... 68-05  
HOFF fissateli ..... 14-03  
HOLTH per capsulo ..... 42-09  
HUNTER schegge ..... 10-06  
IOWA per abbassare il collo dell'utero 70-35  
JACKSON taponi ..... 52-02  
JACOBS per abbassare il collo dell'utero 70-34  
JAMESON strabismo ..... 42-13  
JANSEN nasale ..... 46-04  
JARCHO per abbassare il collo dell'utero 70-  
32 ..... 70-32  
JATHO nasofarinx tagliente ..... 46-18  
JAVID atraumatica carotis ..... BD-32  
JOHNS-HOPKINS serrafina bulldog ..... 12-03  
JOHNS-HOPKINS vie biliari ..... 12-14  
JONES fissateli porta tubo ..... 14-02  
JUDD-ALLIS per afferrare tessuti ..... 64-02  
JURASZ polipus laringe ..... 52-02  
KALT capsulare ..... 43-04  
KANE ombelicale ..... 72-06  
KELLY emostatica ..... 12-05  
KELLY per polipi uterine ..... 70-36  
KELLY-RANKIN emostatica ..... 12-05  
KELLY TITAN emostatica ..... 12-05  
KERRISON tagliente nasale ..... 46-08  
KEVORKIAN-Pacific tagliente per biopsia 70-44  
KEVORKIAN tagliente per biopsia 70-43, 70-

46  
KIRBY-ARTHUR iride ..... 42-13  
KNAPP-LUER trichiasi ..... 43-06  
KNIGHT tagliente nasale ..... 46-05  
KOCHER emostatica delicate ..... 12-06  
KOCHER intestinali ..... 64-04  
KRAUSE laringe ..... 52-03  
LAHEY afferrare gozzo ..... 54-04  
LAHEY vie biliari ..... 12-14  
LAMBERT calazio ..... 43-06  
LAMBERT KAY atraumatica aortica ..... BD-10  
LAMBERT KAY atraumatica iliaca ..... BD-11  
LANE dissezione ..... 10-04  
LANE fissateli ..... 14-05  
LANE porta placche ..... 33-14  
LANE porta viti ..... 33-14  
LANE stomacali ..... 64-08  
LANGE laringe ..... 52-03  
LAWRENCE dissezione e per legature ..... 12-13  
LEES atraumatica bronchi ..... BD-03  
LEKSELL STILLE sgorbia ..... 32-05  
LELAND JONES atraumatica  
vascolare ..... BD-08 lavorare a BD-09  
LEMPERT sgorbia ..... 32-03  
LERCHE dissezione ..... 10-04  
LERICHE emostatica ..... 12-09  
LESTER fissaggio ..... 43-03  
LEWKOWITZ per placenta e per ovaie ..... 72-07  
LIDDLE atraumatica aorta ..... BD-10  
LISTER sinus per tamponi e spugne ..... 16-11  
LITTAUER auricolare ..... 44-08  
LITTAUER depilatorie ..... 43-08  
LITTAUER nasale polipus ..... 46-05  
LORNA fissateli ..... 14-04  
LOVE-GRUENWALD tagliente per  
laminectomia ..... EA-08  
LOVELACE emostatica ..... 12-07  
LOVELACE per afferrare il polmone ..... FG-19  
LOWER vie biliari ..... 12-14  
LUBET-BARBON nasale polipus ..... 46-05  
LUCAE auricolare ..... 44-07  
LUC tagliente nasale ..... 46-06  
LUER sgorbia ..... 32-03  
LURZ per uretere ..... 62-10  
MAGILL per introdurre le sonde ..... 04-06  
MAIER per medicatura ..... 16-12  
MARSCHIK tonsille ..... 50-04  
MARTEL cuoio capelluto ..... 12-08  
MARTIN per medicatura ..... 16-02, 16-14  
MARTIN per sequestri ..... 32-10  
MARTIN muscolare ..... 54-04  
MATHIEU per corpi estranei ..... 66-07  
MAYO BLAKE per calcoli biliari ..... 62-04  
MAYO-GUYON peduncolo renale ..... 12-16  
MAYO per sterilizzazione ..... 28-02  
MAYO-ROBSON intestinali ..... 64-05  
McCLINTOCK per placenta e per ovale ..... 72-07  
McCULLOUGH strabismo ..... 42-13  
McGEE auricolare micro ..... 44-10  
McINDOE dissezione ..... 10-04  
McKENZIE per applicare e agrafes ..... EA-02  
McPHERSON legature ..... 43-05  
McPHERSON TITAN legature ..... 43-05  
MEAD sgorbia ..... 32-02  
MEEKER dissezione e per legature ..... 12-13  
MICHEL per agrafes ..... 26-07  
Pinza micro ..... 11-02  
Pinza  
MIDDLETON-JANSEN tagliente nasale ..... 46-09  
MIKULICZ peritoneali ..... 12-17  
MILLIN per afferrare la capsula ..... 66-03  
MILLIN per lobuli anteriori ..... 66-03  
MILLIN porta-filo ..... 66-03  
MIXTER BABY emostatica bronchiale ..... 12-13  
MIXTER emostatica ..... 12-14  
MIXTER emostatica bronchiale ..... 12-13  
MIXTER O'SHAUGNESSY emostatica ..... 12-14  
MIXTER per calcoli biliari ..... 62-04  
MIXTER vie biliari ..... 12-15

MOORFIELD sutura ..... 43-05  
MOYNIHAN fissateli ..... 14-05  
MOYNIHAN vie biliari ..... 12-15  
MURPHY serratubi ..... 12-19  
MUSEUX per abbassare il collo dell'utero 70-  
33 ..... 70-33  
MYLES tagliente nasale ..... 46-07  
NEGUS tonsille ..... 50-03  
NELSON dissezione ..... 10-05  
NEUBÜSER per afferrare trompe ..... 70-51  
NOTO per polipi uterine ..... 70-36  
NOYES nasale polipus ..... 46-05  
OCHSNER atraumatica aorta ..... BD-31  
OLDBERG tagliente per laminectomia ..... EA-09  
OLIVECRONA sgorbia ..... 32-03  
OLIVECRONA-TOENNIS per applicare e  
agrafes ..... EA-02  
OVERHOLT-GEISSENDOERFER  
dissezione e per legature ..... 12-10  
PAUFIQUE legature ..... 43-05  
PAUFIQUE TITAN legature ..... 43-05  
PAYR-Baby stomacali ..... 64-09  
PAYR stomacali ..... 64-09  
PEAN atraumatica ..... BD-02  
PEAN emostatica ..... 12-08  
PEAN emostatica delicate ..... 12-06  
PEERS BERTRAM fissateli ..... 14-03  
PEET schegge ..... 10-06  
PELMANN per medicatura ..... 16-12  
PENNINGTON emostatica ..... 12-07  
per fissare ..... 66-10  
per fissare il tronco spermatico ..... 66-10  
Pinza per sequestri ..... 32-10  
Pinza per sterilizzazione ..... 28-02  
Pinza  
PHANEUF peritoneali ..... 12-17  
piatta ..... 33-11  
POTTS atraumatica ..... BD-26 lavorare a BD-27  
POTTS atraumatica anastomosi ..... BD-05  
POTTS atraumatica coartazione ..... BD-04  
POTTS-SMITH dissezione ..... 10-02  
POZZI per abbassare il collo dell'utero 70-31  
PRATT emostatica ..... 12-08  
PRATT per abbassare  
il collo dell'utero ..... 70-34 lavorare a 70-35  
PRESBYTERIAN HOSPITAL serratubi ..... 12-19  
PRICE-THOMAS per bronchi ..... FG-22  
PRINCE muscole ..... 43-02  
PROVIDEN24-HOSPITAL emostatica ..... 12-05  
RADOLF per unghie ..... 33-03  
RAMPLEY per tamponi e spugne ..... 16-09  
RANDALL per calcoli renali 62-11 lavorare a  
62-12 ..... 62-12  
RANEY emostatica per il cuoio capelluto EA-03  
RANEY per applicare e togliere ..... EA-03  
RANKIN atraumatica ..... BD-02  
RICHTER-HEATH per agrafes ..... 26-07  
ROBERTS emostatica ..... 12-11  
ROCHESTER-CARMALT emostatica ..... 12-07  
ROCHESTER-OCHSNER emostatica ..... 12-06  
ROCHESTER-PEAN emostatica ..... 12-06  
ROEDER fissateli ..... 14-03  
ROGGE per sterilizzazione ..... 28-02  
ROSENBERG laringe ..... 52-03  
ROWE bocca ..... 48-06  
RUBIN per ammaccare il setto ..... 46-07  
RUMEL toracale ..... 12-11  
RUSKIN sgorbia ..... 32-04  
RUSSIAN dissezione ..... 10-04  
SAENGER per placenta e per ovale ..... 72-07  
SAIRGES per abbassare il collo dell'utero 70-  
32 ..... 70-32  
SAROT emostatica bronchiale ..... 12-12  
SAROT per bronchi ..... FG-23  
SATINSKY atraumatica ..... BD-20  
SATINSKY  
per anastomosi (vena cava) FG-24 lavorare a  
FG-25 ..... FG-25  
SAUERBRUCH per rifiuti ..... 28-03



SAUERBRUCH sgorbia .....	32-05	ULRICH per tamponi e spugne.....	16-06	WANGENSTEEN .....	24-03
SAWTELL tonsille .....	50-03	UNIVERSAL per sterilizzazione.....	28-02	POTTS DE MARTEL forbici vascolari .....	08-27
SCAGLIETTI sgorbia .....	32-05	USA dissezione .....	10-02	POTTS	
Pinza schegge .....	10-06	VAN BUREN per sequestri .....	32-10	pinza atraumatica ....BD-26 lavorare a	BD-27
Pinza		van DOREN tagliente per biopsia.....	70-42	pinza atraumatica anastomosi.....	BD-05
SCHEINMANN laringe .....	52-03	Pinza vascolare flessibile.BD-44 lavorare a	BD-45	pinza atraumatica coartazione.....	BD-04
SCHNIDT tonsille .....	50-03	Pinza		POTTS-SMITH	
SCHOENBURG per afferrare tessuti.....	64-03	VIRTUS (RALK) schegge .....	10-06	forbici vascolari .....	07-19
SCHROEDER per abbassare il collo		WACHENFELDT per agrafes .....	26-07	forbici vascolari .....	08-28
dell'utero .....	70-31 lavorare a	WAGNER tagliente per laminectomia.....	EA-09	pinza dissezione.....	10-02
SCHUBERT tagliente per biopsia.....	70-41	WALSHAM raddrizzare setto .....	46-18	POZZI pinza per abbassare il collo dell'utero	70-31
SCHUMACHER laringe.....	52-03	WANGENSTEEN dissezione.....	10-05	31	
SCHUMACHER tagliente per biopsia.....	70-43	WEBER atraumatica .....	BD-12	PRATT	
SCHWEIGGER capsulare .....	43-04	WEIL-BLAKESLEY tagliente nasale .....	46-06	dilatatore uterini .....	70-29
SEIFFERT laringe .....	52-03	WEISS serratubi.....	12-19	pinza emostatica .....	12-08
SEMB per bronchi.....	FG-23	WERTHEIM-CULLEN isterectomia .....	12-18	pinza per abbassare	
SEMB sgorbia .....	32-06	WERTHEIM isterectomia .....	12-18	il collo dell'utero.....	70-34 lavorare a
SEMKEN dissezione.....	10-05	WESTON polipus rettali .....	68-05	specolo rettale .....	68-02
Pinza serratubi.....	12-19	WHITE tonsille.....	50-03	unicino cistico.....	68-04
Pinza		WILDE (TROELTSCH) auricolare .....	44-07	PRESBYTERIAN HOSPITAL pinza serratubi... 12-19	
SIEGLER HELLMANN per afferrare l'utero	70-38	WILLET-MARTELL cuoio capelluto.....	12-08	PRICE-THOMAS pinza per bronchi.....	FG-22
SIMS-MAIER per medicatura.....	16-05	WILLIAMS per afferrare tessuti.....	64-03	PRINCE	
SINGLEY dissezione .....	10-05	WINTER per placenta e per ovale .....	72-07	forbici tonsillari.....	08-27
SKENE per abbassare il collo dell'utero	70-31	WITTNER tagliente per biopsia.....	70-43	pinza muscolare .....	43-02
SMITHWICK per applicare e agrafes....	EA-02	WOLFF per gessi .....	30-04	Proctoscopia KELLY .....	68-04
SNELLEN entropio .....	43-06	WYLIE atraumatica.....	BD-21	Protettore	
SOMER per afferrare l'utero.....	70-37	YEOMAN per biopsia .....	68-05	ARRUGA.....	42-08
SPENCER-WELLS emostatica.....	12-07	YOUNG per afferrare la prostata .....	66-02	di tessuto .....	33-15
SPURLING tagliente per laminectomia ..	EA-08	YOUNG tiralingua.....	48-03	PROVIDEN24-HOSPITAL pinza emostatica ..	12-05
STAUDE-MOORE per abbassare il collo		ZAUFAL-JANSEN sgorbia.....	32-04	Punte .....	33-04
dell'utero .....	70-31	ZENKER dissezione e per legature.....	12-12	Punteruoli .....	33-08
STEVENS iride.....	42-11	PIPER		PERTHES .....	33-08
STIEGLITZ schegge .....	10-06	forbici osteriche .....	72-04	PETTI lima per ossa .....	32-25
STILLE dissezione .....	10-02	forbici osteriche con dispositivo di trazione	72-04		
STILLE-LUER sgorbia.....	32-04	Placca JAEGER per palpebre .....	42-03	Q	
STILLE peduncolo renale.....	12-16	PLESTER		QUATTRO divaricatori per gessi .....	30-03
STILLE-RUSKIN sgorbia.....	32-05	coltello lobare .....	44-14	QUINBY forbici gengivali .....	08-42
St. MARTIN sutura .....	43-05	divaricatore.....	18-14	QUINKE ago da punzione .....	22-03
STONE per serra .....	64-06	POLITZER		QUIRE leva corpi estranei .....	44-08
STONE-WATT intestinali.....	64-06	ago auricolare.....	44-06	QUISLING martello .....	32-18
STRUEMPEL auricolare.....	44-08	coltello auricolare .....	44-06		
STRUYCKEN tagliente nasale .....	46-07	insolfiatore d'aria .....	44-05	R	
SUBRAMANIAN atraumatica .....	BD-31	POOLE tubi d'aspirazione .....	04-02	Rachiotomo .....	32-17
SWEET per applicare e agrafes .....	EA-02	Porf'aghi		RADOLF pinza per unghie.....	33-03
tagliafilo e per piegare.....	33-11	ADSON .....	24-04	RALK perforatore a mano.....	33-05
TEALE per abbassare il collo dell'utero..	70-33	ARRUGA oftalmologia.....	24-06	RAMPLEY pinza per tamponi e spugne .....	16-09
TERSON capsulare .....	43-04	BARRAQUER .....	24-07	RANDALL	
THOMS-ALLIS per afferrare tessuti.....	64-02	BAUMGARTNER .....	24-02	curetta di aspirazione per biopsia .....	70-40
THOMS-GAYLOR tagliente per biopsia..	70-42	BOYNTON oftalmologia.....	24-06	pinza per calcoli renali62-11 lavorare a	62-12
TIEMANN per abbassare il collo dell'utero	70-32	BOZEMANN.....	24-03	12	
TILLEY auricolare.....	44-08	CASTROVIEJO.....	24-07	RANEY	
TISCHLER-KEVORKIAN tagliente		COLLIER.....	24-02	pinza emostatica per il cuoio capelluto ..	EA-03
per biopsia .....	70-44 lavorare a	CRILE .....	24-04	pinza per applicare e togliere.....	EA-03
TISCHLER-MORGAN tagliente		CRILE-MURRAY.....	24-02	RANKIN pinza atraumatica.....	BD-02
per biopsia .....	70-43 lavorare a	CRILE-WOOD.....	24-02	Rasagio.....	06-14, 06-19
TIVNEN tonsille .....	50-04	DE BAKEY .....	24-03	Raspa	
TOENNIS emostatica .....	12-11	DERF .....	24-02	FOMON nasale.....	46-15 lavorare a
TOHOKU fissateli.....	14-04	DIETHRICH vascolare .....	24-06	GALLAHER per seno.....	46-16
TOWNSEND-KEVORKIAN tagliente per		FINOCHIETTO.....	24-04	JOSEPH (LEWIS) nasale.....	46-15
biopsia .....	70-44	GILLIES .....	24-05	MALTZ (COTTLE) nasale.....	46-15
TOWNSEND-MINI (BABY TISCHLER) tagliente		HALSEY .....	24-02	MALTZ nasale.....	46-14
per biopsia.....	70-45	HEANEY .....	24-03	WIENER (AUFRIEHT) nasale .....	46-15
TOWNSEND-mini tagliente per biopsia..	70-44	HOESEL .....	24-05	WIENER per seno.....	46-15
TOWNSEND tagliente per biopsia .....	70-44	JAMISON .....	24-03	RECAIMER curetta uterine70-49 lavorare a	70-50
TOWNSEND-TISCHLER tagliente per biopsia		JOHNSON .....	24-04	Recipiente cylindr.....	88-08
70-44		JOHNSON .....	24-04	Regolo acciaio.....	02-08
TROELTSCH nasale .....	46-04	KALT .....	24-07	REICHERT depressor epiglottide .....	52-02
TROUTMAN-CHRIS rompe lamette.....	06-14	KALT-ARRUGA .....	24-07	REINER	
TROUTMAN Colibri iride.....	42-13	MASSON .....	24-03	coltello per gessi.....	30-04
TROUTMAN rectus.....	43-02	MATHIEU .....	24-05	siringa auricolare.....	44-05
Tübingen iride .....	42-15	MAYO-HEGAR.....	24-02	Retratore PERCY per amputazione .....	33-03
Tübingen legature .....	43-05	METZENBAUM.....	24-04	Rettoscopio luce fredda.....	68-03
Tübingen TITAN iride.....	42-15	NEIVERT .....	24-02	REVERDIN	
Tübingen TITAN legature.....	43-05	OLSEN-HEGAR .....	24-05	ago per legature.....	26-03
TUFFIER emostatica .....	12-08	RYDER .....	24-03	divaricatore.....	18-04
TURREL per biopsia .....	68-05	SAROT .....	24-04	REYNOLDS forbici .....	07-15, 08-18
TYDING tonsille .....	50-04	STEVENS oftalmologia .....	24-06	RIBBON divaricatore .....	18-04
		STRATTE .....	24-04	RICHARDSON divaricatore .....	18-04
		TOENNIS .....	24-04	RICHARDSON-EASTMAN divaricatore .....	18-04

RICHARDSON Grip divaricatore.....	18-04
RICHTER-HEATH pinza per agrafes.....	26-07
RIGBY divaricatore addominale.....	18-24
ROBB dissettore vascolare.....	FG-33
ROBERTS pinza emostatica.....	12-11
ROCHESTER-CARMALT pinza emostatica.....	12-07
ROCHESTER-OCHSNER pinza emostatica.....	12-06
ROCHESTER-PEAN pinza emostatica.....	12-06
ROEDER pinza fissateli.....	14-03
ROGER elevatore setto.....	46-11
ROGGE pinza per sterilizzazione.....	28-02
ROLLET	
divaricatore.....	42-06
scalpello per sacco.....	42-06
ROSEN	
ago.....	44-14 lavorare a 44-15
ROSENBERG pinza laringe.....	52-03
ROSEN	
coltello circolare.....	44-14
ROSER-KOENIG apribocca.....	48-03
ROSE uncino tracheale.....	54-03
ROUX BABY divaricatore.....	18-02
ROUX	
divaricatore.....	18-02
divaricatore aortica mini.....	18-02
ROWE pinza bocca.....	48-06
RUBIN pinza per ammaccare il setto.....	46-07
RUMEL pinza toracale.....	12-11
RUSKIN-LISTON cesoia per ossa.....	32-06
RUSKIN pinza sgorbia.....	32-04
RUSSIAN pinza dissezione.....	10-04
RYDEL-SEIFFER diapason.....	44-04
RYDER port'aghi.....	24-03
S	
SAALFELD tiracomedoni.....	74-02
SACHS	
dissettore per duramadre.....	EA-05
divaricatore per nervi.....	EA-04
SADILLOT periostotomo.....	32-19
SAENGER pinza per placenta e per ovaie.....	72-07
SAIRGES pinza per abbassare il collo dell'utero	
70-32	
Salpingografo SCHULTZE.....	70-47
SANVENERO forbici.....	07-13, 08-16
SAROT	
pinza emostatica bronchiale.....	12-12
pinza per bronchi.....	FG-23
port'aghi.....	24-04
SATINSKY	
forbici toracali.....	08-37
pinza a traumatica.....	BD-20
pinza per anastomosi (vena cava)FG-24	
lavorare a FG-25	
SATO coltello per corneale.....	42-05
SAUERBRUCH	
costotomo.....	FG-05
divaricatore.....	18-13
SAUERBRUCH-FREY costotomo.....	FG-06
SAUERBRUCH	
pinza per rifiuti.....	28-03
pinza sgorbia.....	32-05
scatola port'aghi.....	74-02
SAWTELL pinza tonsille.....	50-03
SCAGLIETTI pinza sgorbia.....	32-05
Scalpello.....	32-14
ALEXANDER.....	32-14
CINELLI plastica nasale.....	46-13
COTTLE plastica nasale.....	46-13
DIX per corpi estranei.....	42-06
FOMON plastica nasale.....	46-13
FREER setto.....	46-12
HIBBS.....	32-16
HOKE.....	32-16
LEXER.....	32-16
LEXER mini.....	32-16
PARTSCH.....	32-14
ROLLET per sacco.....	42-06
SILVER plastica nasale.....	46-14

SMITH-PETERSEN.....	32-15
Scalpello spinale BRUNETTI.....	32-17
Scalpello sterno LEBSCHKE.....	32-17
Scalpello	
STILLE.....	32-14
WEST nasale.....	46-14
Scarificatore GRAEFE.....	42-04
Scatola	
acciaio inossidabile.....	88-03
PETRI.....	88-08
port'aghi.....	88-02
SAUERBRUCH port'aghi.....	88-02
vetro.....	88-03
SCHAMBERG tiracomedoni.....	74-02
SCHUDE curetta tagliente.....	32-12
SCHIEI	
cannula oculistiche.....	43-07
coltello per goniotomia.....	42-05
SCHNEIDERMAN pinza laringe.....	52-03
SCHERBAK specolo vaginali.....	70-21
SCHIMMELBUSCH tamburo per sterilizzazione88-	
12	
SCHINK dermatomo.....	06-21
SCHIOETZ tonometro.....	43-08
SCHMIEDEN-PAYR sonda conduttrice.....	26-04
SCHMIEDEN sonda conduttrice.....	26-04
SCHMIEDEN-TAYLOR forbici.....	08-36
SCHNIDT pinza tonsille.....	50-03
SCHOENBORN divaricatore tiroide.....	54-04
SCHOENBURG pinza per afferrare tessuti.....	64-03
SCHROEDER	
curetta uterine.....	70-48
pinza per abbassare il collo dell'utero70-31	
lavorare a 70-32	
SCHUBERT pinza tagliente per biopsia.....	70-41
SCHUKNECHT	
coltello circolare.....	44-14
coltello falciforme.....	44-14
SCHULTZE salpingografo.....	70-47
SCHUMACHER	
forbici ombelicali.....	08-34
forbici per sterno.....	FG-07
pinza laringe.....	52-03
pinza tagliente per biopsia.....	70-43
SCHWEIGER pinza capsulare.....	43-04
Sclerotomo	
GUYTON-LUNDGAARD.....	42-05
LUNDGAARD.....	42-05
Scollatendini BUNNELL.....	32-25
Scollato FISCH.....	44-15
Secchi per rifiuti.....	88-11
SEEMANN-SEIFFERT apribocca.....	48-04
Sega	
BERGMANN per gessi.....	30-02
CHARRIERE per amputazione.....	33-03
ENGEL per gessi.....	30-02
JOSEPH nasale.....	46-17
LANGENBECK a dita.....	33-03
OLIVECRONA.....	EA-05
Sega per gessi oscillante.....	30-5 lavorare a 30-6
Sega	
per taglia anelli.....	33-03
WIGMORE per gessi.....	30-02
SEGOND bisturi per fibromi.....	70-46
SEIFFERT pinza laringe.....	52-03
SELLHEIM cucchiaino ostetrico.....	72-09
SELLORS approssimatori costali.....	FG-18
SEMB	
cesoia per ossa.....	32-07
periostotomo.....	32-20
pinza per bronchi.....	FG-23
pinza sgorbia.....	32-06
tenaglia per ossa.....	32-07
SEMKEN pinza dissezione.....	10-05
SEMM specolo vaginali.....	70-07
SENN divaricatore.....	18-04
SENN-GREEN divaricatore.....	18-07
Sensimetro WARTENBERG.....	02-08
Serranodi	

BRUENINGS tonsille.....	50-04
EYES tonsille.....	50-04
KRAUSE.....	46-09
KRAUSE auricolare.....	44-07
TYDING tonsille.....	50-05
WILDE.....	46-09
WILDE auricolare.....	44-07
Serrapene	
STOCKMANN.....	66-10
STRAUSS.....	66-10
Set	
KEYES di trapani cutanei.....	74-02
Set per autopsia.....	32-17
Set	
per manicure per infermiere.....	74-03
SEUTIN forbici per gessi.....	30-02
SEXTON coltello auricolare.....	44-06
Sfera elettrodo per coagulazione.....	JA-03
Sferica.....	33-04
Sfigmomanometro.....	02-02
Sgorbia.....	32-14
ALEXANDER.....	32-14
ELLIS per corpi estranei.....	42-06
FREER nasale.....	46-14
HAJEK nasale.....	46-14
HIBBS.....	32-16
KILLIAN-CLAUS nasale.....	46-14
LEXER.....	32-16
LEXER mini.....	32-16
PARTSCH.....	32-14
SMITH-PETERSEN.....	32-15
STILLE.....	32-14
WALTON per corpi estranei.....	42-06
WEST nasale.....	46-14
SHEA forbici auricolari micro.....	44-09
SHORTBENT forbici per legature.....	08-40
SIEBOLD forbici ginecologiche.....	07-21, 08-32
SIEGLER HELLMANN pinza per afferrare l'utero	
70-38	
SIEGLE specoli auricolare.....	44-02
SILVER	
dermatomo.....	06-20
scalpello plastica nasale.....	46-14
SIMCOE cannula sutura.....	43-07
SIMON	
curetta tagliente.....	32-13
curetta uterine.....	70-48
divaricatore.....	18-12
SIMPSON-BRAUN forcipe ostetriche.....	72-02
SIMPSON forbici ostetriche.....	72-02
SIMPSON-LUIKART forbici ostetriche.....	72-03
SIMS	
curetta uterine.....	70-49 lavorare a 70-50
depressore uterino.....	70-39
dilatatore uterini.....	70-30
forbici ginecologiche.....	07-21, 08-32
isterometro.....	70-39
SIMS-MAIER pinza per medicatura.....	16-05
SIMS	
specolo rettale.....	68-02
specolo vaginali.....	70-17
SINGLEY pinza dissezione.....	10-05
Siringa	
REINER auricolare.....	44-05
tonsille.....	50-05
Sistema LEYLA da fissaggioEA-14 lavorare a EA-	
18	
SKENE pinza per abbassare il collo dell'utero70-	
31	
SLUDER-BALLENGER tonsillotomo.....	50-05
SMELLIE	
spezzacrano.....	72-09
uncino uncino ostetrico.....	72-06
SMILLIE meniscotomo.....	32-24
SMITH blefarostato.....	42-02
SMITH-BUIE dilatatore per l'ano e il retto.....	68-03
SMITH-PETERSEN	
scalpello.....	32-15
sgorbia.....	32-15

SMITH US ARMY forbici bendaggi.....08-44	KOGAN endo.....70-23	Strumento
SMITHWICK	KRISTELLER vaginali...70-09 lavorare a	KNUTSON per uretrografia.....66-09
divaricatore per nervi.....EA-04	LANDAU vaginali.....70-22	LOUTE tendifilo.....33-11
pinza per applicare e agrafes.....EA-02	MATHIEU rettale.....68-02	MOGAN per circoncisione.....66-09
SNELLEN	O'SULLIVAN-O'CONNOR vaginali.....70-08	per circoncisione.....66-09
ansa.....42-08	PEDERSON vaginali.....70-03	WINKELMANN per circoncisione.....66-09
pinza entropio.....43-06	PRATT rettale.....68-02	Strum
SOMER pinza per afferrare l'utero.....70-37	SCHERBAK vaginali.....70-21	KUENTSCHER per conficc.....33-13
Sonda.....20-02	SEMM vaginali.....70-07	per conficc.....33-12
BRUNNER conduttrice.....26-04	SIMS rettale.....68-02	STRUYCKEN pinza tagliente nasale.....46-07
DESJARDINS per calcoli biliari.....62-05	SIMS vaginali.....70-17	SUBRAMANIAN pinza atraumatica.....BD-31
DOYEN.....20-02	STEINER-AUVARD vaginali.....70-19	Supporto MILLIN per luce fredda.....66-05
HARTMANN auricolare.....44-06	THUDICHUM nasale.....46-02	SWEET pinza per applicare e agrafes.....EA-02
ITARD auricolare.....44-06	TIECK-HALLE nasale.....46-03	T
KIRSCHNER conduttrice.....26-04	TRELAT vaginali.....70-07	TABB coltello falciforme.....44-14
KOCHER gozzo.....54-04	Vienna nasale.....46-02	Taglia anelli DIMEDA.....33-03
KOENIG conduttrice.....26-04	VOLTOLINI nasale.....46-02	Tagliacalli CREDO.....74-03
MAYO per calcoli renali.....62-10	WEISSBARTH vaginali.....70-22	Tagliafili.....33-12
misurare.....44-15	YANKAUER nasofarins.....46-04	Diamant.....33-12
MOYNIHAN per calcoli biliari.....62-05	SPENCER forbici per legature.....08-40	Tamburo
NABATOFF auricola argento.....20-02	SPENCER-WELLS pinza emostatica.....12-07	KONRICH per sterilizzazione.....88-12
PAYR conduttrice.....26-04	Spezzacrano	SCHIMMELBUSCH per sterilizzazione...88-12
per uomini metallica.....66-16	NÄGELE.....72-09	TARNIER
SCHMIEDEN conduttrice.....26-04	SMELLIE.....72-09	cranioclasto.....72-09
SCHMIEDEN-PAYR conduttrice.....26-04	SPRATT curretta tagliente.....32-12	forbici ostetriche con dispositivo di trazione
STACKE auricola argento.....20-02	SPURLING pinza tagliente per laminectomiaEA-08	72-05
Spatola.....20-03	Sputacchiera.....88-06	TAYLOR
ALLISON polmone.....FG-19	STACKE sonda auricola argento.....20-02	divaricatore spina.....32-24
BANGERTER ciclodialisi.....42-08	Standard astucci tascabili e per sutura.....26-08	martelli percussori.....02-07
CASTROVIEJO ciclodialisi42-08 lavorare a 42-09	STAUDE-MOORE pinza	TEALE pinza per abbassare il collo dell'utero70-33
CULLER iride.....42-08	per abbassare il collo dell'utero.....70-31	Telaio KIRSCHNER.....18-23
ELSCHNIG ciclodialisi.....42-08	St. CLAIR-THOMSON coltello.....46-19	Tenaglia
KOCHER vescicali.....66-04	STEINER-AUVARD specolo vaginali.....70-19	BIRCHER-GANSKE per ossa.....32-10
LEGUEU vescicali.....66-04	STEINMANN chiodo per ossa.....33-09	DINGMANN per ossa.....32-10
WECKER iride.....42-08	STELZNER forbici rette.....08-38	FARABEUF-LAMBOTTE per ossa.....32-08
WELLS enucleaciona.....42-08	STERNBERG divaricatore labbra.....48-02	FARABEUF per ossa.....32-07
WHEELER ciclodialisi.....42-09	Stetoscopio	FERGUSSON per ossa.....32-07
Spatole	BOWLES.....02-06	KERN per ossa.....32-08
CUSHING cerebr.....EA-07	Stetoscopio duplex.....02-06	LAMBOTTE per ossa.....32-08
HEIFETZ cerebr.....EA-07	Stetoscopio	LANE per ossa.....32-08
OLIVECRONA cerebr.....EA-07	FORD.....02-06	LANGENBECK per ossa.....32-07
Spazzola per pulire.....28-04 lavorare a 28-05	FORD BOWLES.....02-06	LEWIN per ossa.....32-10
Specchio frontale ZIEGLER.....02-05	PINARD.....02-06	LOWMAN per ossa.....32-11
Specchio	STEVENS	Tenaglia per ossa.....32-09 lavorare a 32-10
laringei.....52-04	forbici tenotomia.....07-17	Tenaglia
MICHEL.....46-04	forbici tenotomy.....08-23	SEMB per ossa.....32-07
Specillo.....20-03	STEVENSON blefarostato.....42-03	VERBRUGGE per ossa.....32-09
BOWMAN canale lacrimale.....42-10	STEVENS	Tenditore di fili.....33-10
DIMEDA.....20-03	pinza iride.....42-11	TERSON pinza capsulare.....43-04
FARREL.....20-03	port'aghi oftalmologia.....24-06	THOMS-ALLIS pinza per afferrare tessuti.....64-02
JOBSON-HORNE.....20-03	uncino per cristallino.....42-06	THOMS-GAYLOR pinza tagliente per biopsia70-42
TOBOLD.....20-03	STIEGLITZ pinza schegge.....10-06	THOMSON-WALKER divaricatore vescicale 66-06
UCKERMANN.....20-03	Stilletto MAGILL.....04-04	THOREK forbici pulmonari.....08-36
Specoli	STILLE	THUDICHUM specolo nasale.....46-02
BOUCHERON auricolare.....44-02	costotomi.....FG-03	TIECK-HALLE specolo nasale.....46-03
BRUENINGS auricolare.....44-02	forbici per gessi.....30-02	TIEMANN pinza per abbassare il collo dell'utero 70-32
GRUBER auricolare.....44-02	STILLE-HORSLEY cesoia per ossa.....32-07	TILLEY pinza auricolare.....44-08
HARTMANN auricolare.....44-02	STILLE-LISTON cesoia per ossa.....32-06	Tiracomedoni
SIEGLE auricolare.....44-02	STILLE-LUER pinza sgorbia.....32-04	SAALFELD.....74-02
TOYNBEE auricolare.....44-02	STILLE	SCHAMBERG.....74-02
Specolo	osteotomo.....32-14	UNNA.....74-02
AUVARD vaginali.....70-19	perforatore a mano.....33-04	WALTON.....74-02
BARR rettale.....68-02	pinza dissezione.....10-02	Tiramioni DOYEN per fibromi.....70-46
BERLIND-AUVARD vaginali.....70-19	pinza peduncolo renale.....12-16	TISCHLER-KEVORKIAN pinza
BODENHAMMER rettale.....68-02	STILLE-RUSKIN pinza sgorbia.....32-05	tagliente per biopsia.....70-44 lavorare a 70-45
BRAUN vaginali.....70-16	STILLE	TISCHLER-MORGAN pinza
BREISKY vaginali.....70-20	scalpello.....32-14	tagliente per biopsia70-43 lavorare a 70-44, 70-46
COLLIN vaginali.....70-04	sgorbia.....32-14	TIVNEN pinza tonsille.....50-04
COTTLE nasale.....46-03	STILLE-SHERMAN perforatore a mano.....33-04	TOBOLD
CUSCO vaginali.....70-04 lavorare a 70-06	St. MARTIN pinza sutura.....43-05	abassalingua.....48-02
CZERNY rettale.....68-02	STOCKMANN serrapene.....66-10	specillo.....20-03
DOYEN vaginali.....70-18, 70-20	STONE pinza per serra.....64-06	TOENNIS-ADSON forbici neurochirurgia.....08-35
FREEWAY-GRAVE vaginali.....70-06	STONE-WATT pinza intestinali.....64-06	TOENNIS
GRAVE vaginali.....70-02	STRATTE port'aghi.....24-04	dissettore per duramadre.....EA-05
HARTMANN-HALLE nasale.....46-02	STRAUSS serrapene.....66-10	
JACKSON vaginali.....70-16	Stripper anello.....20-03	
KALLMORGEN vaginali.....70-15	STRUEMPEL pinza auricolare.....44-08	
KILLIAN setto.....46-03	STRULLY forbici neurochirurgia.....08-35	
	Strumenti LAFORCE per corpi estranei.....42-06	

pinza emostatica	12-11
port'agli	24-04
TOHOKU pinza fissateli	14-04
Tonometro SCHIOETZ	43-08
Tonsillotomo SLUDER-BALLENGER	50-05
TOOK coltello per corneale	42-05
TOTI fresa	33-07
TOWNSEND-KEVORKIAN pinza tagliante per biopsia	70-44
TOWNSEND-MINI (BABY TISCHLER) pinza tagliante per biopsia	70-45
TOWNSEND-mini pinza tagliante per biopsia	70-44
TOWNSEND-TISCHLER pinza tagliante per biopsia	70-44
TOYNBEE specoli auricolare	44-02
Trapano	33-04
CASTROVIEJO corneale	43-07
ELLIOT corneale	43-08
FRANCESCHETTI corneale	43-07
Trattore	
BARTON per manico standard	72-04
BILL per manico standard	72-05
LUIKART-BILL per manico standard	72-05
TRAUBE martelli percussori	02-07
TRELAT specolo vaginali	70-07
Trequarti	22-02
COAKLEY	22-02
DOUGLAS	22-02
FLEURANT	22-02
LICHTWITZ	22-02
MENGHINI	22-03
NELSON	22-02
OCHSNER	22-02
PIERCE	22-02
UCKERMANN tracheale	54-02
UNIVERSAL	22-02
TROELTSCH pinza nasale	46-04
TROMNER martelli percussori	02-07
Tronchesina	
per pelle	74-03
per unghie	74-03
TURNBULL per unghie	74-03
TROUSSEAU dilatatore tracheale	54-02
TROUTMAN-CASTROVIEJO forbici micro	09-07
TROUTMAN-CHRIS pinza rompe lamette	06-14
TROUTMAN Colibri pinza iride	42-13
TROUTMAN pinza rectus	43-02
TUBBS dilatatore per valvole mitrali	FG-27
Tubi d'aspirazione	
ANDREWS-PINCHON	04-03
DE BAKEY	04-04
FRAZIER	04-06
MAGILL	04-04
NUBOER	04-05
POOLE	04-02
WALTON YANKAUER	04-03
YANKAUER	04-02
Tübingen	
cannula aria	43-07
pinza iride	42-15
pinza legature	43-05
Tübingen TITAN	
pinza iride	42-15
pinza legature	43-05
Tubo	
BRUENINGS allungo	52-03
BUIE di aspirazione	68-05
JACKSON tracheale	54-03
LUER tracheale	54-03
WAGENER-MOSHER tracheale	54-03
TUFFIER	
divaricatore costali	FG-16
pinza emostatica	12-08
TURNBULL tronchesina per unghie	74-03
TURREL pinza per biopsia	68-05
TYDING	
pinza tonsille	50-04

serranodi tonsille	50-05
U	
UCKERMANN	
specillo	20-03
trequarti tracheale	54-02
ULRICH pinza per tamponi e spugne	16-06
Uncinetto	44-15
BARBARA	44-14
DAY auricolare	44-07
FRAZIER	18-06
GILLIES	46-17
GRAEFE	18-06
GUTHRIE	18-06
JOSEPH	18-06
KILNER per pelle	74-02
WAGENER auricolare	44-07
Uncini EMMET per fistole	70-46
Uncino	
ARRUGA	42-06
BOSE tracheale	54-02
BRAUN per detroncazione	72-09
cava chiodi	33-13
elettrodo mini	JA-02
GRAEFE per strabismo	42-06
GRAEFE-TITAN per strabismo	42-06
GREEN muscolare	42-06
ITERSON tracheale	54-02
JACKSON tracheale	54-02
JAMESON per strabismo	42-06
O' CONNOR per iris	42-06
per estensione piccolo	33-10
ROSE tracheale	54-03
SMELLIE uncino ostetrico	72-06
STEVENS per cristallino	42-06
WIENER per iris	42-06
Uncino PRATT cistico	68-04
UNIVERSAL	
forbici bendaggi	08-50
forbici filo metallo lamiera	08-42
pinza per sterilizzazione	28-02
trequarti	22-02
UNNA tiracomedoni	74-02
Uretrotomo OTIS	66-08
Urinal	88-10
USA	
cavo elettrobisturi	JA-07
USA MODEL forbici ombelicali	08-34
USA	
pinza dissezione	10-02
US Army (PARKER-LANGENBECK) divaricatore	18-03
Uso bisturi, sterili	06-10 lavorare a 06-11
V	
VALLEIX isterometro	70-39
Valva	
BALFOUR centrale	18-22
CASPAR	18-20
CASPAR spina vertebrale	18-19
KALLMORGEN vaginali	70-15
KIRSCHNER per telaio	18-23
KRISTELLER vaginali	70-09 lavorare a 70-14
VAN BUREN	
candeletta dilatatrici	66-13
pinza per sequestri	32-10
Van DOREN pinza tagliante per biopsia	70-42
VANNAS	
forbici iridectomia	09-05
forbici micro	09-12 lavorare a 09-13
VARIFOCAL oftalmoscopio	02-03
Vassoio	
per medicamento	88-07
per strumenti	88-08 lavorare a 88-09
VERBRUGGE tenaglia per ossa	32-09
VERRES ago da punzione pneumoperitoneo	22-03
Vienna specolo nasale	46-02
VIRCHOW	
coltello per cartilagini	06-18

coltello per il cervello	06-18
divisore per craneo	32-17
VIRTUS (RALK) pinza schegge	10-06
VOLKMANN	
curetta tagliante	32-12 lavorare a 32-13
divaricatore	18-07 lavorare a 18-08
VOLTOLINI specolo nasale	46-02
W	
WACHENFELDT pinza per agrafes	26-07
WADSWORTH-TODD cauterio	42-08
WAGENER-MOSHER tubo tracheale	54-03
WAGENER uncinetto auricolare	44-07
WAGNER	
forbici	07-22
forbici gingivali	08-42
pinza tagliente per laminectomia	EA-09
WALDMANN forbici episiotomia	08-34
WALLICH curetta per placenta e per ovaie	72-08
WALSHAM pinza raddrizzare setto	46-18
WALTHER candeletta dilatatrici	66-17
WALTON	
sgorbia per corpi estranei	42-06
tiracomedoni	74-02
WALTON YANKAUER tubi d'aspirazione	04-03
WANGENSTEEN	
pinza dissezione	10-05
port'agli	24-03
WARTENBERG sensimetro	02-08
WATSON-CHEYNE elevatore	32-22
WATSON dermatomo	06-22
WEBER	
ansa	42-08
pinza atraumatica	BD-12
WECKER	
forbici tendini	09-04
spatola iride	42-08
WEEK blefarostato	42-02
WEIL-BLAKESLEY pinza tagliante nasale	46-06
WEISSBARTH specolo vaginali	70-22
WEISS pinza serratubi	12-19
WEITLANER divaricatore	18-14
WEITLANER-WULLSTEIN divaricatore	18-14
WELLS spatola enucleaciona	42-08
WERTHEIM-CULLEN pinza isterectomia	12-18
WERTHEIM	
forbici preparazion	08-32
pinza isterectomia	12-18
WESTCOTT	
forbici iridectomie	09-02
forbici tendini	09-02
WESTON pinza polipus rettali	68-05
WEST	
scalpello nasale	46-14
sgorbia nasale	46-14
WHEELER	
coltello per disizisione	42-04
spatola ciclodialiisi	42-09
WHITEHEAD apribocca	48-04
WHITE pinza tonsille	50-03
WIEDER abassalingua	48-02
WIENER (AUFRICHT) raspa nasale	46-15
WIENER	
raspa per seno	46-15
uncino per iris	42-06
WIGMORE sega per gessi	30-02
WILDER	
ansa	42-08
dilatatore canale lacrimale	42-10
WILDE	
serranodi	46-09
serranodi auricolare	44-07
WILDE (TROELTSCH) pinza auricolare	44-07
WILLET-MARTELL pinza cuoio capelluto	12-08
WILLIAMS	
blefarostato	42-02
giraviti	33-14
pinza per afferrare tessuti	64-03
WILLIGER	

curetta tagliente .....	32-13
martello .....	32-18
periototomo .....	32-19
WINKELMANN strumento per circoncisione	66-09
WINTER pinza per placenta e per ovale.....	72-07
WITTNER pinza tagliente per biopsia.....	70-43
WOLFF pinza per gessi .....	30-04
WRIGLEY forbici ostetriche.....	72-02
WULLSTEIN	
coltello falciforme.....	44-14
forbici auricolari micro .....	44-11
forbici auricolari micro mini .....	44-11
WYLIE	
dilatatore uterini .....	70-30
pinza atraumatica.....	BD-21
Y	
YANKAUER	
specolo nasofarins .....	46-04
tubi d'aspirazione.....	04-02
YASARGIL forbici micro ...09-10 lavorare a	09-11
YEOMAN pinza per biopsia .....	68-05
YOUNG Boomerang ago per legature .....	26-03
YOUNG	
divaricatore per prostata .....	66-02
pinza per afferrare la prostata .....	66-02
pinza tiralingua .....	48-03
Z	
ZAUFAL-JANSEN pinza sgorbia.....	32-04
ZENKER pinza dissezione e per legature ....	12-12
ZIEGLER	
blefarostato .....	42-03
coltello per capsulotomia .....	42-05
coltello per iridettomi.....	42-04
dilatatore canale lacrimale.....	42-10
specchio frontale.....	02-05









Chirurgie  
Surgery  
Chirurgie  
Cirugía  
Chirurgia

**DIMEDA Instrumente GmbH**

Gänsäcker 54 + 58  
D-78532 Tuttlingen, Germany

Tel. +49.7462.94 61-0  
Fax +49.7462.94 61-33

info@dimeda.de  
www.dimeda.de