

dimeda[®]
SURGICAL INSTRUMENTS



NEUROCHIRURGIE

NEUROSURGERY
NEUROCHIRURGIE
NEUROCIRUGÍA
NEUROCHIRURGIA





[DAS UNTERNEHMEN]

„Mit unseren Instrumenten wird nicht gespielt, sie retten Leben.“

„Our instruments are not to play, they save lives.“

[DEUTSCH]

Seit 1976 sind wir erfolgreich in der Medizinbranche tätig. Wir bieten ein komplettes Programm chirurgischer Instrumente an. Im Mittelpunkt aller Maßnahmen und Aktivitäten unseres Hauses steht der Kunde. Seine Wünsche, Ansprüche und Anforderungen sind für uns eine tägliche Herausforderung. Deshalb ist absolute Kundenorientierung für uns oberstes Prinzip. Sie prägt unsere Geschäftspolitik und ist jederzeit Ansporn für das Handeln und Denken unserer Mitarbeiter. Daher sind wir stets für morgen gerüstet. Unser Qualitätsmanagement ist ein essentieller Bestandteil unserer langfristigen Unternehmensstrategie, in die jeder einzelne Mitarbeiter eingebunden ist und die von einem Wir-Gefühl getragen wird. Unabhängig vom jeweiligen Arbeitsplatz, fühlt sich jeder DIMEDA-Mitarbeiter für die Einhaltung der Qualität verantwortlich.

Wir verfügen über modernste Logistik. Unser umfassendes Lager garantiert schnelle Lieferzeiten. Sollten Artikel nicht lagermäßig vorrätig sein, so können diese durch einen speziellen Service kurzfristig zur Verfügung gestellt und versendet werden. Alle Instrumente und Geräte aus unserem Sortiment werden von geschulten und erfahrenen Fachkräften mit handwerklichem Geschick unter Einsatz modernster Maschinen und Anlagen hergestellt. Dabei kommen ausnahmslos Materialien zum Einsatz, die unseren besonders hohen Qualitätsstandards genügen. Unsere Produktpalette mit mehr als 23.000 verschiedenen Standardinstrumenten für die Human-, Dental und Veterinärmedizin wird durch die enge Zusammenarbeit mit unseren Kunden, Ärzten und Wissenschaftlern im In- und Ausland ständig erweitert und nach dem neuesten Stand der Technik optimiert.

[ENGLISH]

Since 1976 we have been working successfully in the medical field. The focus of all our measures and activities is the customer. His wishes, demands and requirements are a daily challenge for us. Therefore, customer service is our top priority. It effects our business policy and is a permanent task for every member of our team. For this reason we are prepared for the future at any time. Our Quality Management is an essential component in our long-term company strategy in which every single employee is involved and which is supported by a common feeling. Every DIMEDA employee feels himself responsible for observance of quality no matter in which department he is working.

Our extensive warehouse guarantees quick delivery times. Articles which are not available ex stock can be supplied in a short time due to a special service. All instruments and devices of our product range are manufactured by well-trained and experienced skilled workers with special craftsmanship and by use of most modern machines and equipment. We only use materials which meet our high quality standards. Our product range with more than 23,000 different standard instruments for Human, Dental and Veterinary medical applications is permanently increased and optimized as per the state of the art by the close cooperation of our domestic and foreign customers, physicians and scientists.

[LOGISTIK]

„Einmal um die ganze Welt“

„All around the world.“













[DEUTSCH]









Seit 40 Jahren nutzen Ärzte weltweit unsere chirurgischen Instrumente. Es gibt kaum ein Land, in dem wir nicht vertreten sind. Von unserem Lager bis zu ihrem Bestimmungsort hat unsere Ware oft einen langen Weg hinter sich. Wir setzen logistisch alles daran, dass Ihre Bestellung rechtzeitig und zu Ihrer Zufriedenheit eintrifft.

[ENGLISH]

Since 40 years physicians and surgeons all over the world are using our surgical instruments. There is hardly a country where we do not have a distributor.



01	DIAGNOSTIK <i>DIAGNOSTICS</i> <i>DIAGNOSTIC</i> <i>DIAGNÓSTICO</i> <i>DIAGNOSTICA</i>		1 - 4
02	SKALPELLE, MESSER <i>SCALPELS, KNIVES</i> <i>BISTOURIS, COUTEAUX</i> <i>BISTURÍS, CUCHILLOS</i> <i>BISTURI, COLTELLI</i>		5 - 16
03	SCHEREN <i>SCISSORS</i> <i>CISEAUX</i> <i>TIJERAS</i> <i>FORBICI</i>		17 - 46
04	MIKRO-SCHEREN <i>MICRO SCISSORS</i> <i>MICRO-CISEAUX</i> <i>MICRO TIJERAS</i> <i>MICRO FORBICI</i>		47 - 58
05	PINZETTEN <i>THUMB & TISSUE FORCEPS</i> <i>PINCES</i> <i>PINZAS</i> <i>PINZE</i>		59 - 70
06	MIKRO-PINZETTEN <i>MICRO THUMB & TISSUE FORCEPS</i> <i>MICRO PINCES</i> <i>MICRO PINZAS</i> <i>MICRO PINZE</i>		71 - 86
07	ARTERIENKLEMMEN <i>HEMOSTATIC FORCEPS</i> <i>PINCES HÉMOSTATIQUES</i> <i>PINZAS HEMOSTÁTICAS</i> <i>PINZE EMOSTATICHE</i>		87 - 102
08	WUNDHAKEN <i>RETRACTORS</i> <i>ÉCARTEURS</i> <i>SEPARADORES</i> <i>DIVARICATORI</i>		103 - 148
09	NADELHALTER <i>NEEDLE HOLDERS</i> <i>PORTE-AIGUILLES</i> <i>PORTA-AGUJAS</i> <i>PORT'AGHI</i>		149 - 162
10	ORTHOPÄDIE, BOHRAPPARATE <i>ORTHOPEDICS, DRILLS</i> <i>ORTHOPÉDIE, PERFORATEURS</i> <i>ORTOPEDÍA, PERFORADORES</i> <i>ORTOPEDIA, PERFORATORI</i>		163 - 214
11	SCHÄDEL INSTRUMENTE <i>SKULL INSTRUMENTS</i> <i>INSTRUMENTS CRÂNIENNES</i> <i>INSTRUMENTOS PARA CRANEOTOMÍA</i> <i>STRUMENTI PER CRANIOTOME</i>		215 - 222
12	HAKEN, DISSEKTOREN <i>HOOKS, DISSECTORS</i> <i>CROCHETS, DISSECTEURS</i> <i>GANCHOS, DISECTORES</i> <i>UNCINI, DISSETTORI</i>		223 - 238

13	MIKRO-RUNDGRIFF INSTRUMENTE <i>MICRO INSTRUMENTS WITH ROUND HANDLES</i> <i>MICRO-INSTRUMENTS À MANCHE ROND</i> <i>INSTRUMENTOS PARA MICROCIROUGÍA CON MANGOS REDONDOS</i> <i>STRUMENTI PER MICROCHIRURGIA CON MANICO ROTONDO</i>		239 - 252
14	SPATEL <i>SPATULAS</i> <i>SPATULES</i> <i>ESPATULÁS</i> <i>SPATOLE</i>		253 - 256
15	SAUGROHRE <i>SUCTION TUBES</i> <i>TUBES D'ASPIRATION</i> <i>TUBOS DE ASPIRACIÓN</i> <i>TUBI D'ASPIRAZIONE</i>		257 - 264
16	STANZEN <i>RONGEURS</i> <i>GOUGES</i> <i>GUBIAS</i> <i>SGORBIE</i>		265 - 282
17	ANEURYSMEN - GEFÄß CLIPS <i>ANEURYSM - VESSEL CLIPS</i> <i>ANEURYSM - CLIPS VASCULAIRES</i> <i>ANEURYSM - CLIPS VASCULARES</i> <i>ANEURYSM - CLIPS VASCOLARI</i>		283 - 316
18	HYPOPHYSEKTOMIE-INSTRUMENTE <i>PITUITARY INSTRUMENTS</i> <i>INSTRUMENTS POUR L'HYPOPHYSECTOMIE</i> <i>INSTRUMENTOS PARA HIPOFISECTOMÍA</i> <i>STRUMENTI PER IPOFISECTOMIA</i>		317 - 330
19	HOCHFREQUENZ-CHIRURGIE <i>HIGH FREQUENCY SURGERY</i> <i>CHIRURGIE À HAUTE FRÉQUENCE</i> <i>ELECTROCIRUGÍA</i> <i>ELETTROCHIRURGIA</i>		331 - 336
20	CONTAINER <i>CONTAINERS</i> <i>CONTAINER</i> <i>CONTENEDORES</i> <i>CONTAINER</i>		337 - 340
21	INHALTSVERZEICHNIS <i>INDEX</i> <i>INDEX</i> <i>ÍNDICE ALFABÉTICO</i> <i>INDICE ALPHABETICO</i>		341 - 362
22	NUMMERNVERZEICHNIS <i>NUMERICAL INDEX</i> <i>INDEX NUMÉRIQUE</i> <i>ÍNDICE NUMÉRICO</i> <i>INDICE NUMERICO</i>		363 - 373

01



◆ **DIAGNOSTIK**
DIAGNOSTICS
DIAGNOSTIC
DIAGNÓSTICO
DIAGNOSTICA

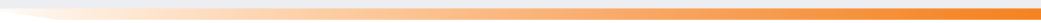

Diagnostik, Perkussionshämmer

Diagnostic, percussion hammers
Diagnostiques, marteaux-percuteurs
Diagnósticas, martillos para reflejos
Diagnostica, martelli percussori

Dynamometer, mit Einteilung in Kilo
Dynamometer, graduated in kg
Dynamometre, divisé en kilos
Dinamometro, graduado en kg
Dinamometro, graduato in kg



COLLIN
02.140.01
12,5 cm/5"

für Erwachsene
for adults
pour adultes
para adultos
per adulti



COLLIN
02.140.02
10 cm/4"

für Kinder
for children
pour enfants
para niños
per bambini

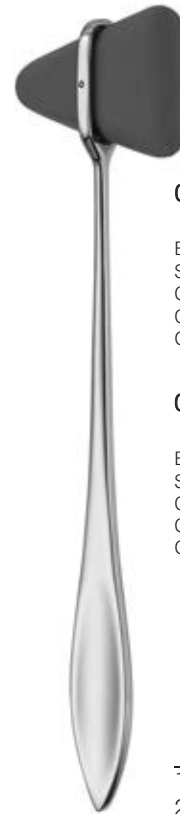

02.288.29

Ersatzgummi, grau
Spare rubber, grey
Caoutchouc, gris, seule
Caucho, gris, suelto
Gomma, grigia, solo

02.288.30

Ersatzgummi, rot
Spare rubber, red
Caoutchouc, rouge, seule
Caucho, rojo, suelto
Gomma, rossa, solo

TAYLOR

17 cm/6 ³ / ₄ "	02.288.17
20 cm/8"	02.288.20



02.290.99

Ersatzgummi
Spare rubber
Caoutchouc, seule
Caucho, suelto
Gomma, solo

TRAUBE
02.290.16
16 cm/6¹/₄"



Ø 40 mm

02.292.99

Ersatzgummi
Spare rubber
Caoutchouc, seule
Caucho, suelto
Gomma, solo

BABINSKY
02.292.22
22 cm/8³/₄"



02.294.99

Ersatzgummi
Spare rubber
Caoutchouc, seule
Caucho, suelto
Gomma, solo

TROEMNER
02.294.24
24 cm/9¹/₂"



Ø 40 mm

RABINER
 02.296.23
 23 cm/9"



DEJERINE
 02.302.20
 20 cm/8"



DEJERINE
 02.304.20
 21 cm/8¼"

02.304.99

Ersatzgummi für 02.302.20, 02.304.20
 Spare rubber for 02.302.20, 02.304.20
 Caoutchouc seule pour 02.302.20, 02.304.20
 Caucho suelto para 02.302.20, 02.304.20
 Gomma solo per 02.302.20, 02.304.20

mit Nadel
 with needle
 avec aiguille
 con aguja
 con ago



BERLINER
 17 cm/6¾" 02.306.17
 20 cm/8" 02.306.20



BUCK
 02.308.18
 18 cm/7"

02.308.97

Pinsel allein
 Brush only
 Pinceau seule
 Pincel suelto
 Pennello solo

02.308.98

Nadel allein
 Needle only
 Aiguille seule
 Aguja suelta
 Ago solo

02.308.99

Ersatzgummi Satz
 Spare rubber set
 Caoutchouc jeu seule
 Caucho set suelto
 Gomma set solo

Schieblehren, Aesthesiometer

Calipers, aesthesiometer
 Pieds à coulisse, estésiometre
 Calibres, estesiómetro
 Calibro, estesiometro

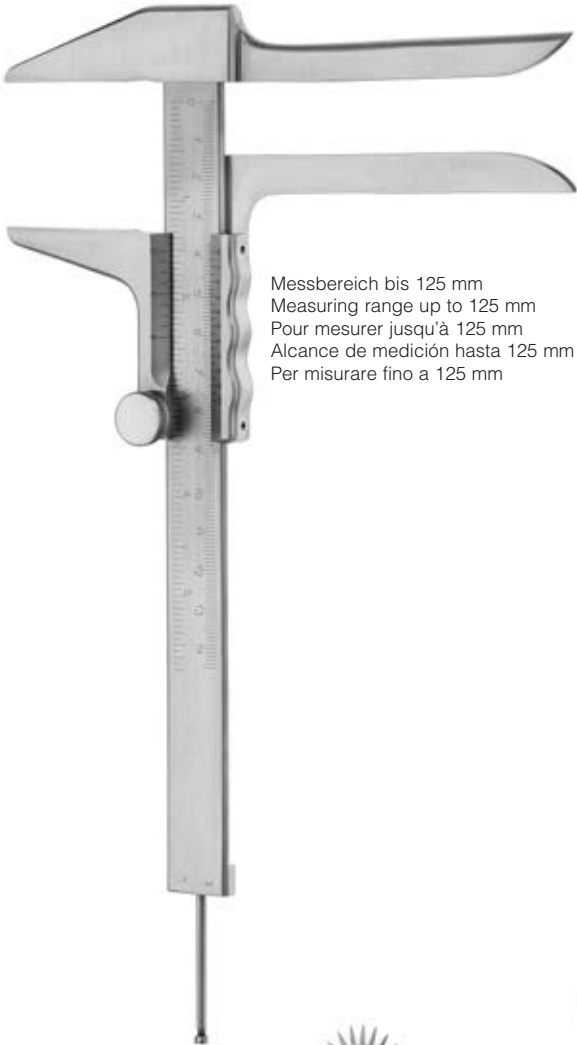

Messbereich bis 125 mm
 Measuring range up to 125 mm
 Pour mesurer jusqu'à 125 mm
 Alcance de medición hasta 125 mm
 Per misurare fino a 125 mm

02.318.00

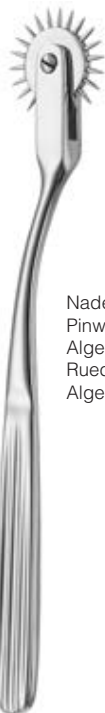

Nadelrad
 Pinwheel
 Algesimetre
 Rueda de espigas
 Algesimetro

WARTENBERG
 02.320.19
 19 cm/7 1/4"



Stimmgabel
 Tuning fork
 Diapason
 Diapason
 Diapason

mit Hammer, Nadelrad, Pinsel u. Nadel
 with hammer, pinwheel, brush and needle
 avec marteaux, roue aux épingles, broset et aiguille
 con martillo, rueda con espigas, cepillo y aguja
 con martello, algesimetro, spazzola ed ago

44.075.00

Aesthesiometer
 Aesthesiometer
 Estésiometre
 Estesiómetro
 Estesiometro



WEBER
 02.320.09
 9 cm/3 1/2"



10 cm/4"	02.340.10
15 cm/6"	02.340.15
20 cm/8"	02.340.20
25 cm/9 3/4"	02.340.25
30 cm/12"	02.340.30
40 cm/16"	02.340.40
50 cm/20"	02.340.50

Einteilung in mm und Zoll
 Graduated in mm and inches
 Divisé en mm et pouces
 Graduado en mm y pulgadas
 Diviso in millimetri e pollici

02



◆ **SKALPELLE, MESSER**

SCALPELS, KNIVES

BISTOURIS, COUTEAUX

BISTURÍS, CUCHILLOS

BISTURI, COLTELLI

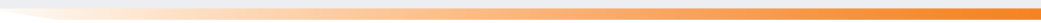

Skalpellgriffe

Scalpel handles

Manches de bistouris

Mangos de bisturís

Manici per bisturi

Skalpellgriffe, passend für
auswechselbare Skalpellklingen
Fig. 10, 11, 12, 13, 15

Scalpel handles for scalpel blades
fig. 10, 11, 12, 13, 15

Manches pour lames de bistouris
interchangeables
fig. 10, 11, 12, 13, 15

Mangos de bisturí para
hojas intercambiables
fig. 10, 11, 12, 13, 15

Manici per bisturi, per fissare
le lame intercambiabili
fig. 10, 11, 12, 13, 15

massiv, mit Zentimeter-Graduierung
solid, cm-graduation
solide, gradué en cm
macizo, graduado en cm
pieno, graduato in cm



06.103.00
12 cm/4¾"
Fig. 3



06.103.01
12 cm/4¾"
No. 3



lang
long
long
largo
lungo

06.103.02
21,5 cm/8½"
Fig. 3 L



06.103.06
21 cm/8¼"
Fig. 3 L



abgewinkelt, lang
angled, long
coudé, long
angulado, largo
angolare, lungo

rund
round
rond
redondo
rotondo



06.103.03
14,5 cm/5¾"
Fig. 3 R

rund, abgewinkelt
round, angled
rond, coudé
redondo, angulado
rotondo, angolare



06.103.33
14 cm/5½"
Fig. 3 R

Fig.
3

Skalpellgriffe, passend für
auswechselbare Skalpellklingen
Fig. 10, 11, 12, 13, 15

Scalpel handles for scalpel
blades fig. 10, 11, 12, 13, 15

Manches pour lames de
bistouris interchangeables
fig. 10, 11, 12, 13, 15

Mangos de bisturí para
hojas intercambiables
fig. 10, 11, 12, 13, 15

Manici per bisturi, per fissare
le lame intercambiabili
fig. 10, 11, 12, 13, 15

Fig.
3

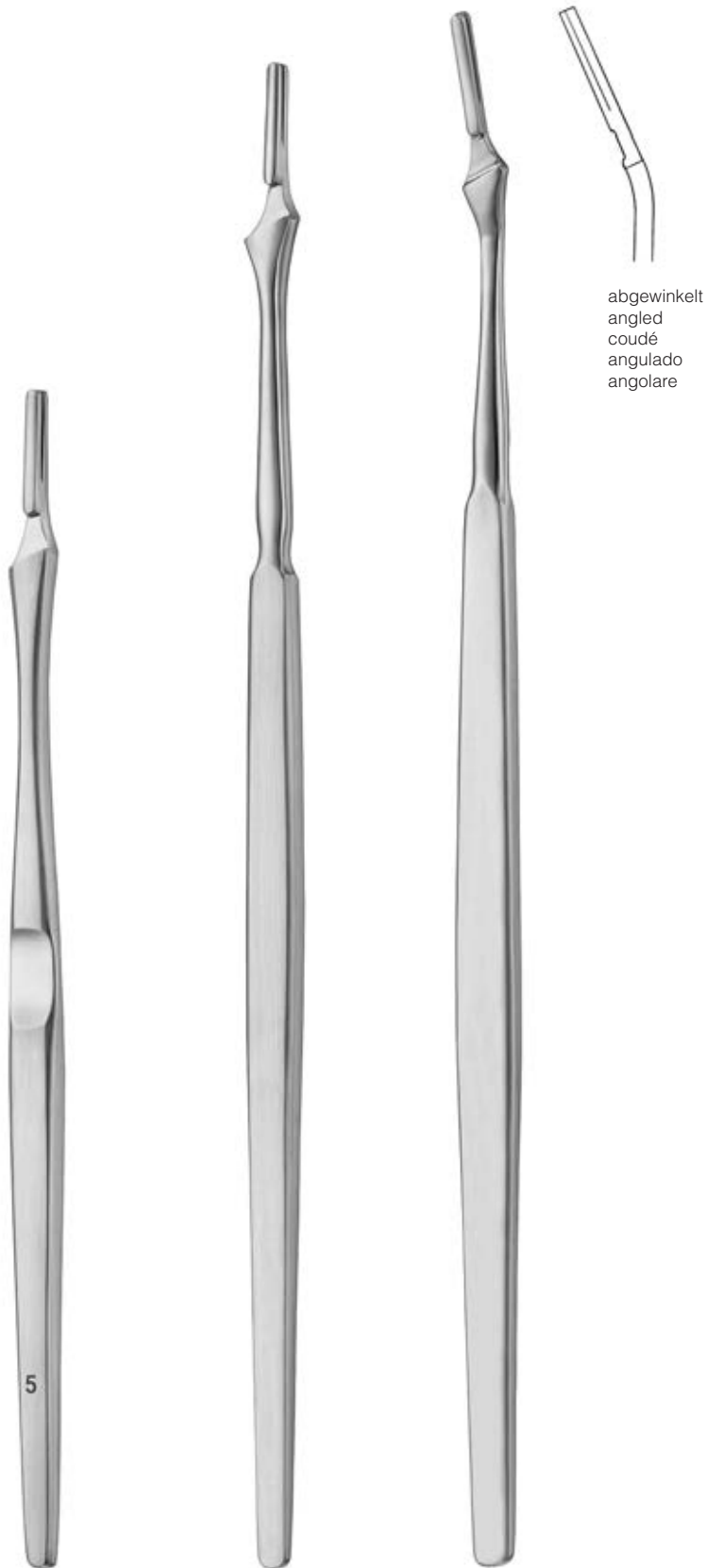

06.105.00
16 cm/6¼"
No. 5

06.106.00
21,5 cm/8½"
No. 5

06.106.01
21 cm/8¼"
No. 5

Skalpellgriffe

Scalpel handles
Manches de bistouris
Mangos de bisturis
Manici per bisturi

Skalpellgriffe, passend für
auswechselbare Skalpellschneiden
Fig. 10, 11, 12, 13, 15

Scalpel handles for scalpel
blades fig. 10, 11, 12, 13, 15

Manches pour lames de
bistouris interchangeables
fig. 10, 11, 12, 13, 15

Mangos de bisturi para
hojas intercambiables
fig. 10, 11, 12, 13, 15

Manici per bisturi, per fissare le
lame intercambiabili
fig. 10, 11, 12, 13, 15

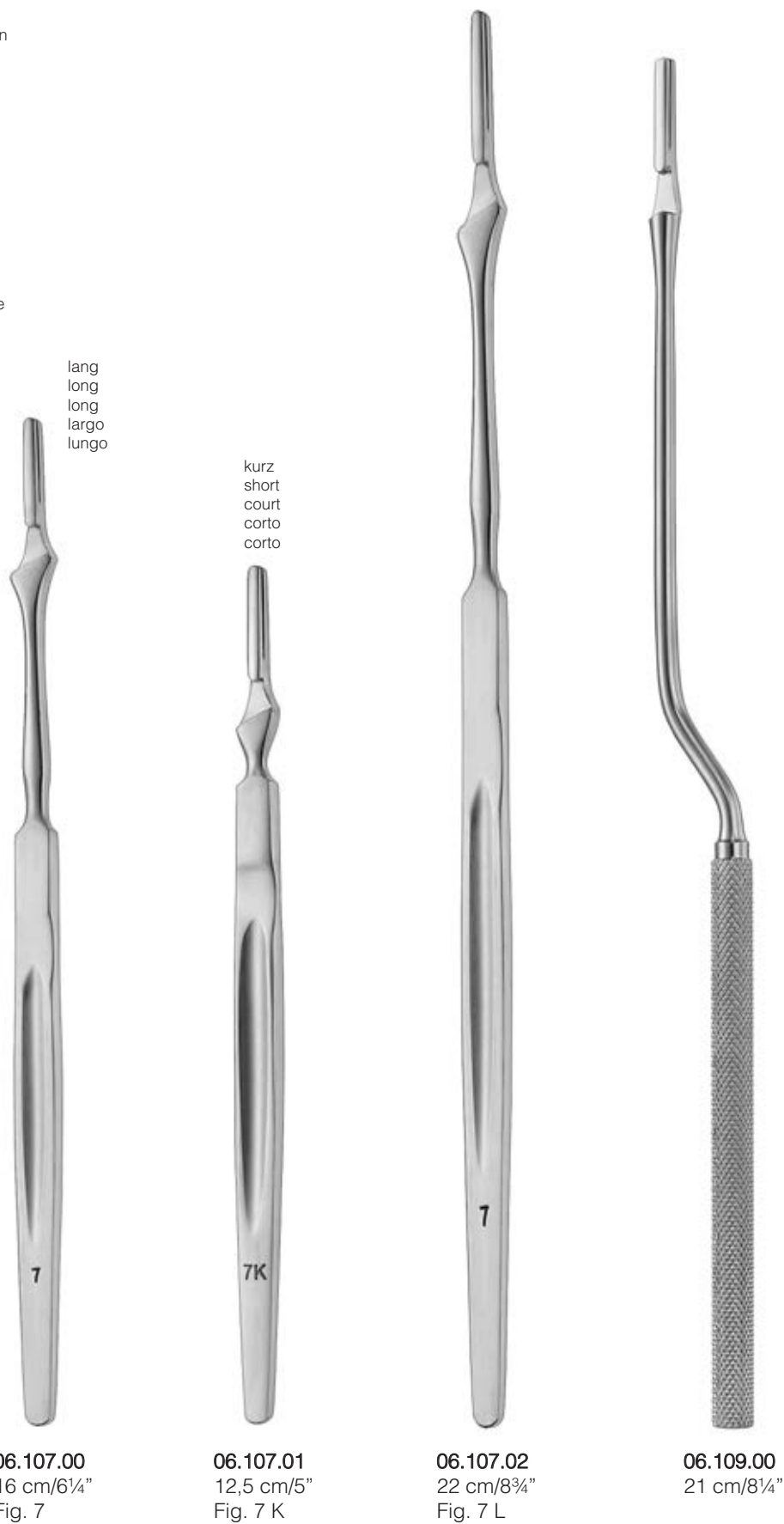

Fig.
3

Skalpelli, passend für
 auswechselbare Skalpellklingen
 Fig. 18, 19, 20, 21, 22, 23, 24, 25, 34, 36

Scalpel handles for scalpel
 blades fig. 18, 19, 20, 21, 22, 23, 24, 25, 34, 36

Manches pour lames de bistouris
 interchangeables
 fig. 18, 19, 20, 21, 22, 23, 24, 25, 34, 36

Mangos de bisturí para
 hojas intercambiables
 fig. 18, 19, 20, 21, 22, 23, 24, 25, 34, 36

Manici per bisturi, per fissare
 le lame intercambiabili
 fig. 18, 19, 20, 21, 22, 23, 24, 25, 34, 36

mit Zentimeter-Graduierung
 cm-graduation
 gradué en cm
 graduado en cm
 graduato in cm

Fig.
 4



06.104.00
 13,5 cm/5¼"
 Fig. 4



06.104.01
 13,5 cm/5¼"
 Fig. 4



06.104.02
 21 cm/8¼"
 Fig. 4 L



06.104.06
 21 cm/8¼"
 Fig. 4 L

lang
 long
 long
 largo
 lungo

abgewinkelt, lang
 angled, long
 coudé, long
 angulado, largo
 angolare, lungo

**Fig.
3**

für Skalpellgriff Fig. 3
 for scalpel handle fig. 3
 pour manche de bistouris fig. 3
 para mango de bisturís fig. 3
 per manico per bisturi fig. 3



06.110.00
Fig. 10



06.111.00
Fig. 11



06.112.00
Fig. 12

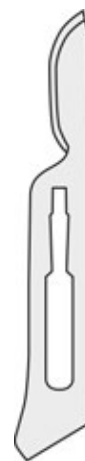

06.115.00
Fig. 15

in Packungen à 100 Stück
 in packages of 100 pieces
 en boîtes de 100 pièces
 en cajas de 100 piezas
 in scatole di 100 pezzi



Fig.
4

für Skalpellingriff Fig. 4
for scalpel handle fig. 4
pour manche de bistouris fig. 4
para mango de bisturís fig. 4
per manico per bisturi fig. 4

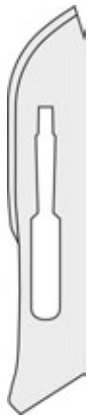

06.120.00
Fig. 20



06.121.00
Fig. 21



06.122.00
Fig. 22

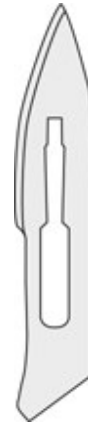

06.123.00
Fig. 23



06.124.00
Fig. 24

Skalpellinge-Entferner
Scalpel blade remover
Enlève-lame
Quita hojas
Distributore lame

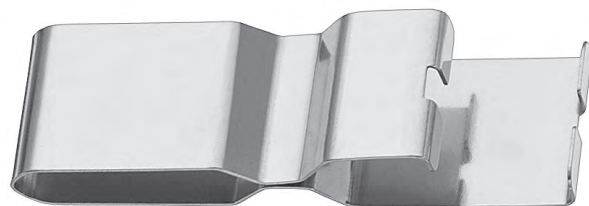

06.199.00

Mikro Skalpellgriffe

Micro scalpel handles

Micro manches pour bistouris

Micro mangos de bisturí

Micro manici per bisturi



06.302.13
13,5 cm/5¼"



06.304.15
15,5 cm/6"



CASPAR
06.306.18
18 cm/7"



06.308.20
20 cm/8"



LANDOLT
40.858.21
21 cm/8¼"

Mikro Skalpellgriffe, Mikro-Skalpellklingen

Micro scalpel handles, micro scalpel blades
Micro manches pour bistouris, micro lame de bistouris
Micro mangos de bisturí, micro hojas de bisturí
Micro manici per bisturi, micro lame per bisturi



in Packungen à 10 Stück, steril
in packages of 10 pieces, sterile
en boîtes de 10 pièces, stériles
en cajas de 10 piezas, estériles
in scatole di 10 pezzi, sterili



40.859.01
Fig. 61



40.859.02
Fig. 62



40.859.04
Fig. 64



40.859.05
Fig. 65



40.859.07
Fig. 67



40.859.09
Fig. 69

LANDOLT
40.857.25
25 cm/10"

Klingenhalter, Klingenbrecher

Blade holders, blade breakers

Pincettes pour saisir et casser les lames de rasoir

Porta-hojas, rompe-hojas de afeitár

Pinze per afferrare e rompere le lamette da rasoio

Rasierklingen brechbar, Packung mit 10 Stück
Razor blades breakable, package with 10 pieces
Lames de rasoir cassable, boîte de 10 pièces
Hojas de afeitár rompeable, paquete con 10 piezas
Lamette da rasoio rompibile, scatola di 10 pezzi



06.296.00



TROUTMAN-CHRIS

06.290.09

9 cm/3½"

Griffdurchmesser
Handle diameter
Diamètre du manche
Diámetro del mango
Diametro di manico
5,5 mm



TROUTMAN-CHRIS

06.291.09

9 cm/3½"

Griffdurchmesser
Handle diameter
Diamètre du manche
Diámetro del mango
Diametro di manico
5,5 mm



DIMEDA

06.291.11

11 cm/4¼"



CASTROVIEJO
06.292.18
18 cm/7"



CASTROVIEJO
06.294.13
13 cm/5"

Griffdurchmesser
Handle diameter
Diamètre du manche
Diámetro del mango
Diametro di manico
8 mm

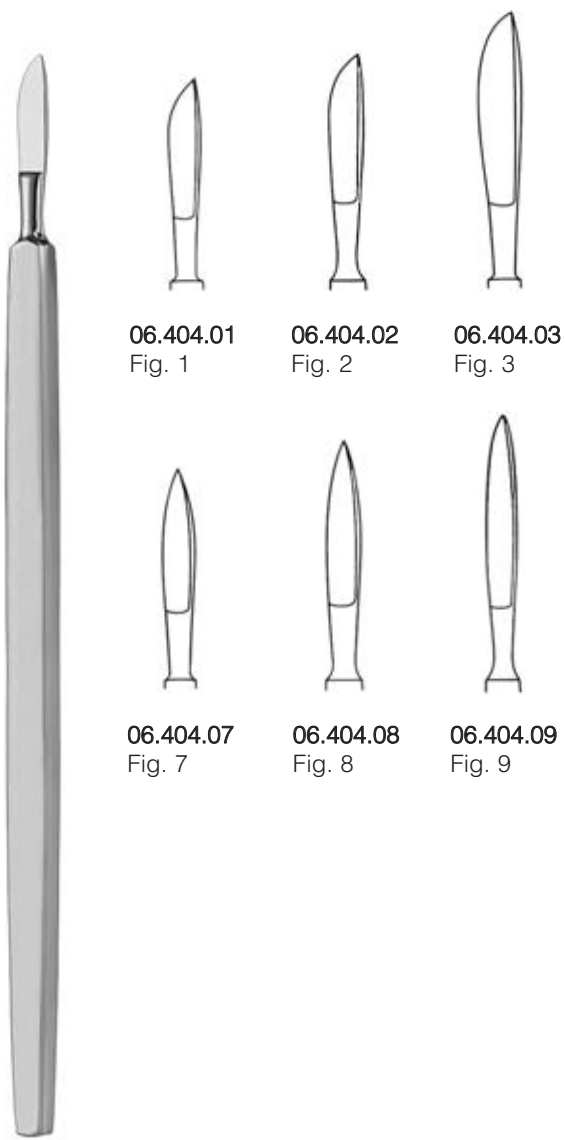

DIEFFENBACH
13 cm/5"

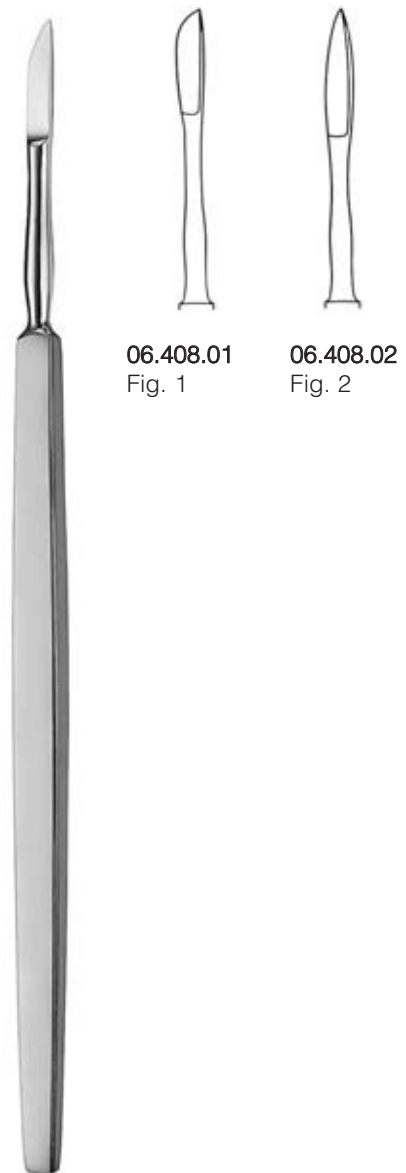

PARKER
14 cm/5½"

03



◆ SCHEREN

SCISSORS

CISEAUX

TIJERAS

FORBICI

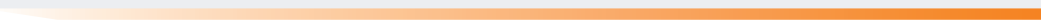

Chirurgische Scheren

Operating scissors

Ciseaux à chirurgie

Tijeras para cirugía

Forbici per chirurgia

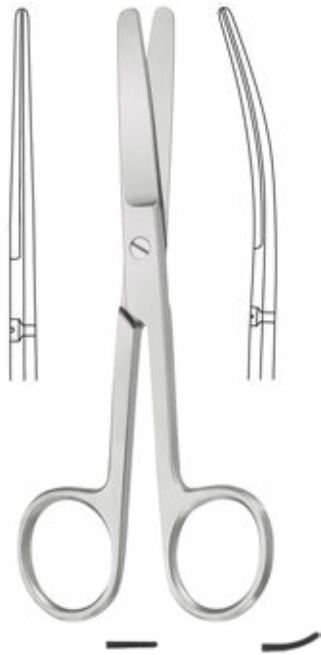

10,5 cm/4¼"	08.102.10	08.103.10
11,5 cm/4½"	08.102.11	08.103.11
13 cm/5"	08.102.13	08.103.13
14,5 cm/5¾"	08.102.14	08.103.14
15,5 cm/6¼"	08.102.15	08.103.15
16,5 cm/6½"	08.102.16	08.103.16
18,5 cm/7¼"	08.102.18	08.103.18
20 cm/8"	08.102.20	08.103.20

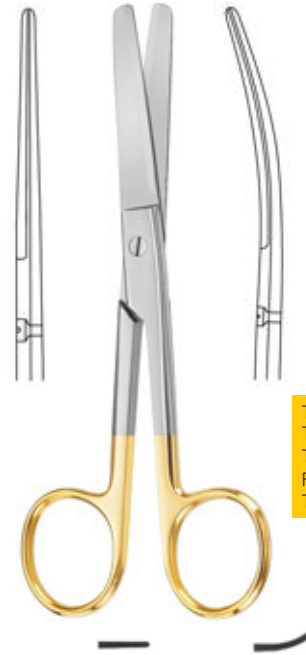

TC-Schneiden
TC cutting edges
Tranchant TC
Filos de corte TC
Taglio TC

14,5 cm/5¾"	08.104.14	08.105.14
16,5 cm/6½"	08.104.16	08.105.16
18,5 cm/7¼"	08.104.18	08.105.18



SUPERCUT

10,5 cm/4¼"	07.102.10	07.103.10
11,5 cm/4½"	07.102.11	07.103.11
13 cm/5"	07.102.13	07.103.13
14,5 cm/5¾"	07.102.14	07.103.14
15,5 cm/6¼"	07.102.15	07.103.15
16,5 cm/6½"	07.102.16	07.103.16
18,5 cm/7¼"	07.102.18	07.103.18
20 cm/8"	07.102.20	07.103.20



TC-Schneiden
TC cutting edges
Tranchant TC
Filos de corte TC
Taglio TC

14,5 cm/5¾"	07.104.14	07.105.14
16,5 cm/6½"	07.104.16	07.105.16

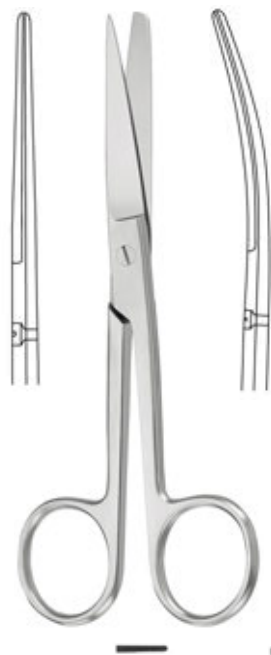

10,5 cm/4¼"	08.110.10	08.111.10
11,5 cm/4½"	08.110.11	08.111.11
13 cm/5"	08.110.13	08.111.13
14,5 cm/5¾"	08.110.14	08.111.14
15,5 cm/6¼"	08.110.15	08.111.15
16,5 cm/6½"	08.110.16	08.111.16
18,5 cm/7¼"	08.110.18	08.111.18
20 cm/8"	08.110.20	08.111.20

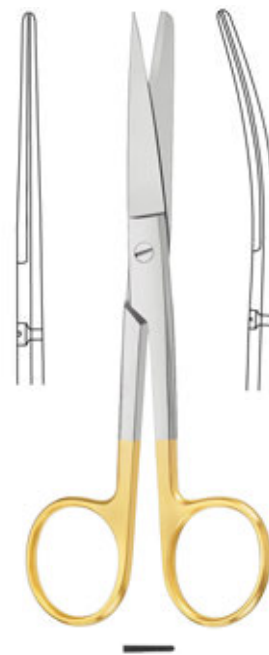

TC-Schneiden
TC cutting edges
Tranchant TC
Filos de corte TC
Taglio TC

14,5 cm/5¾"	08.114.14	08.115.14
16,5 cm/6½"	08.114.16	08.115.16
18,5 cm/7¼"	08.114.18	08.115.18

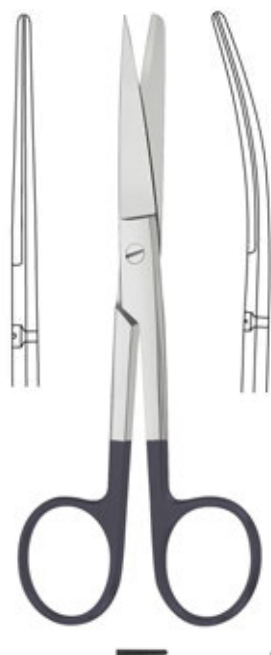

SUPER CUT

11,5 cm/4½"	07.110.11	07.111.11
13 cm/5"	07.110.13	07.111.13
14,5 cm/5¾"	07.110.14	07.111.14
15,5 cm/6¼"	07.110.15	07.111.15
16,5 cm/6½"	07.110.16	07.111.16
18,5 cm/7¼"	07.110.18	07.111.18
20 cm/8"	07.110.20	07.111.20

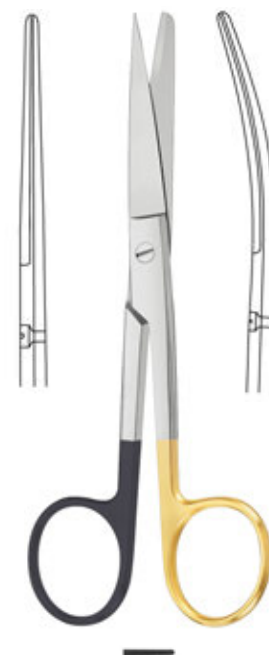

TC-Schneiden
TC cutting edges
Tranchant TC
Filos de corte TC
Taglio TC

14,5 cm/5¾"	07.114.14	07.115.14
16,5 cm/6½"	07.114.16	07.115.16

Chirurgische Scheren

Operating scissors

Ciseaux à chirurgie

Tijeras para cirugía

Forbici per chirurgia

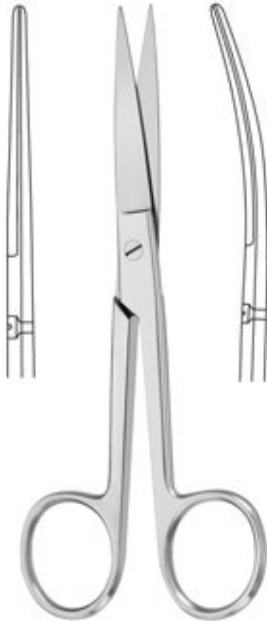

10,5 cm/4¼"	08.120.10	08.121.10
11,5 cm/4½"	08.120.11	08.121.11
13 cm/5"	08.120.13	08.121.13
14,5 cm/5¾"	08.120.14	08.121.14
15,5 cm/6¼"	08.120.15	08.121.15
16,5 cm/6½"	08.120.16	08.121.16
18,5 cm/7¼"	08.120.18	08.121.18
20 cm/8"	08.120.20	08.121.20

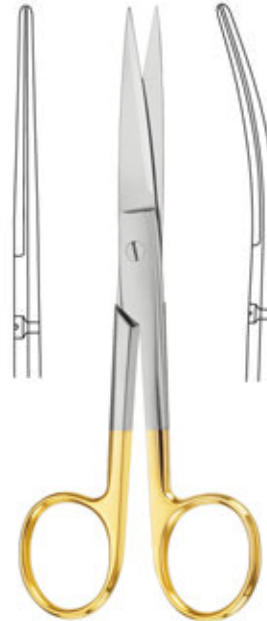

TC-Schneiden
TC cutting edges
Tranchant TC
Filos de corte TC
Taglio TC

14,5 cm/5¾"	08.124.14	08.125.14
16,5 cm/6½"	08.124.16	08.125.16
18,5 cm/7¼"	08.124.18	08.125.18

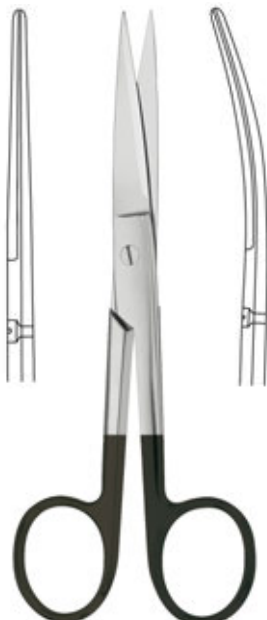

SUPERCUT

10,5 cm/4¼"	07.120.10	07.121.10
11,5 cm/4½"	07.120.11	07.121.11
13 cm/5"	07.120.13	07.121.13
14,5 cm/5¾"	07.120.14	07.121.14
15,5 cm/6¼"	07.120.15	07.121.15
16,5 cm/6½"	07.120.16	07.121.16
18,5 cm/7¼"	07.120.18	07.121.18
20 cm/8"	07.120.20	07.121.20

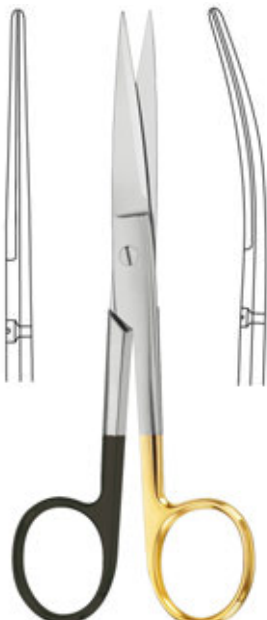

TC-Schneiden
TC cutting edges
Tranchant TC
Filos de corte TC
Taglio TC

14,5 cm/5¾"	07.124.14	07.125.14
16,5 cm/6½"	07.124.16	07.125.16

fein
delicate
déliçats
finas
delicate



14,5 cm/5¾"



08.122.01

stumpf/stumpf
blunt/blunt
mousse/mousse
romo/romo
smusso/smusso

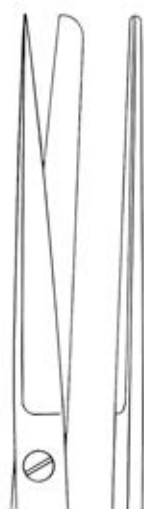

08.122.02

spitz/stumpf
sharp/blunt
pointue/mousse
aguda/romo
acuta/smusso

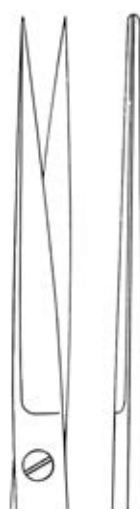

08.122.03

spitz/spitz
sharp/sharp
pointue/pointue
aguda/aguda
acuta/acuta

fein
delicate
déliçats
finas
delicate

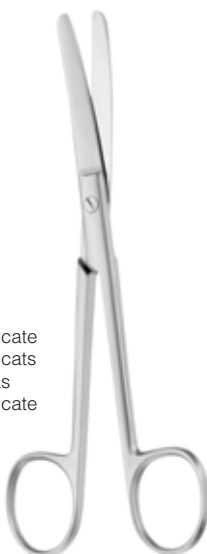

14,5 cm/5¾"



08.123.01

stumpf/stumpf
blunt/blunt
mousse/mousse
romo/romo
smusso/smusso



08.123.02

spitz/stumpf
sharp/blunt
pointue/mousse
aguda/romo
acuta/smusso



08.123.03

spitz/spitz
sharp/sharp
pointue/pointue
aguda/aguda
acuta/acuta

Präparierscheren

Dissecting scissors
Ciseaux à dissection
Tijeras de disección
Forbici per dissezione

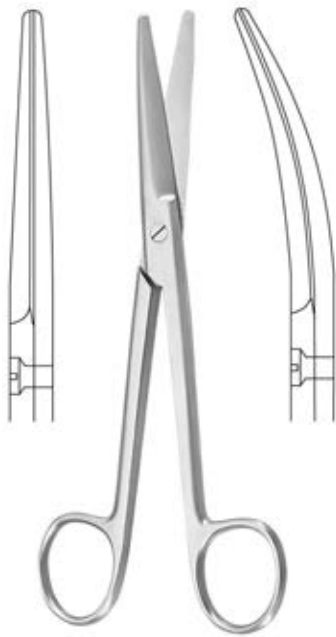

MAYO

14,5 cm/5¾"	08.160.14	08.161.14
15,5 cm/6"	08.160.15	08.161.15
17 cm/6¾"	08.160.17	08.161.17
19 cm/7½"	08.160.19	08.161.19
23 cm/9"	08.160.23	08.161.23
28 cm/11"	08.160.28	08.161.28

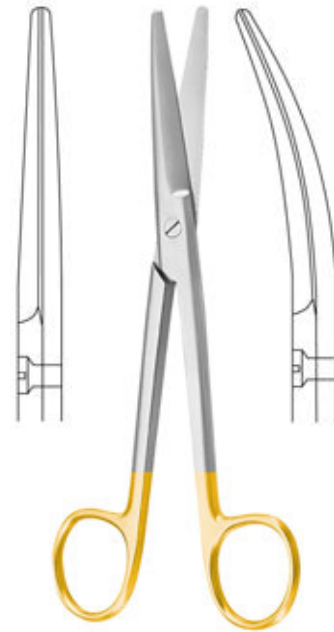

MAYO

TC-Schneiden
TC cutting edges
Tranchant TC
Filos de corte TC
Taglio TC

14,5 cm/5¾"	08.164.14	08.165.14
17 cm/6¾"	08.164.17	08.165.17
23 cm/9"	08.164.23	08.165.23

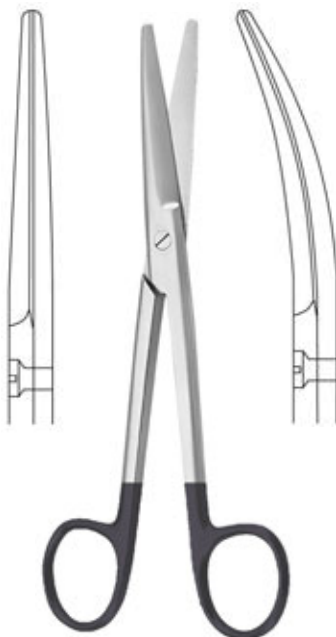

MAYO

14,5 cm/5¾"	07.160.14	07.161.14
17 cm/6¾"	07.160.17	07.161.17
23 cm/9"	07.160.23	07.161.23

SUPERCUT

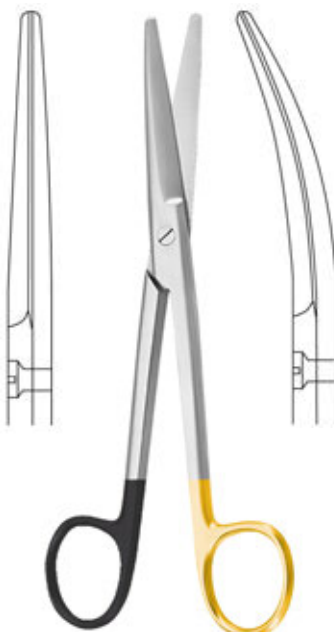

MAYO

TC-Schneiden
TC cutting edges
Tranchant TC
Filos de corte TC
Taglio TC

14,5 cm/5¾"	07.164.14	07.165.14
17 cm/6¾"	07.164.17	07.165.17
23 cm/9"	07.164.23	07.165.23

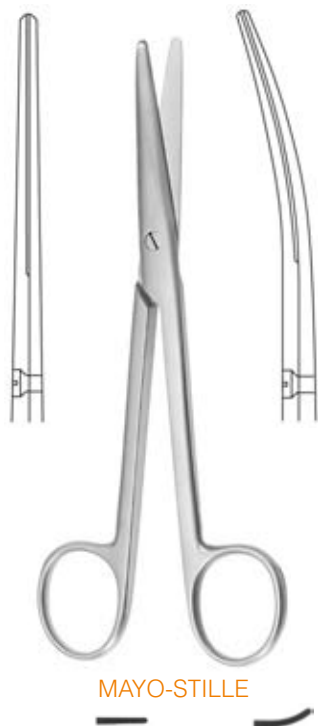

MAYO-STILLE

15 cm/6"	08.170.15	08.171.15
17 cm/6¾"	08.170.17	08.171.17



MAYO-STILLE

15 cm/6"	08.174.15	08.175.15
17 cm/6¾"	08.174.17	08.175.17

TC-Schneiden
 TC cutting edges
 Tranchant TC
 Filos de corte TC
 Taglio TC

Präparierscheren

Dissecting scissors
 Ciseaux à dissection
 Tijeras de disección
 Forbici per dissezione

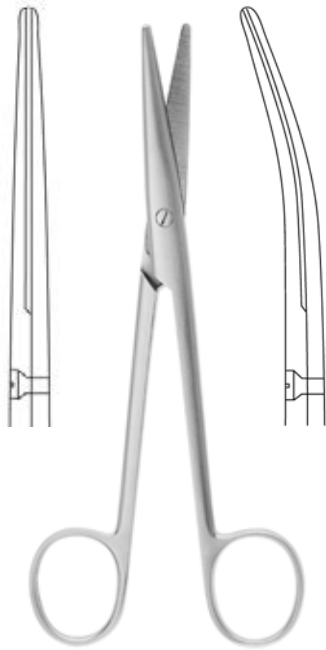

LEXER

16 cm/6¼"	08.190.16	08.191.16
21 cm/8¼"	08.190.21	08.191.21

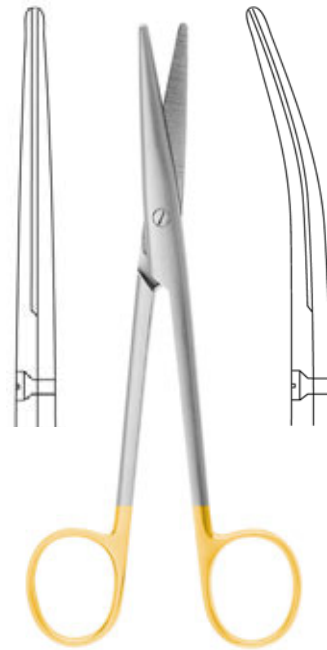

LEXER

16 cm/6¼"	08.194.16	08.195.16
21 cm/8¼"	08.194.21	08.195.21

TC-Schneiden
 TC cutting edges
 Tranchant TC
 Filos de corte TC
 Taglio TC

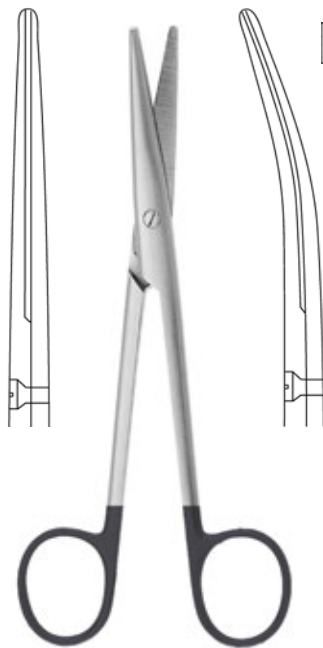

LEXER

16 cm/6¼"	07.190.16	07.191.16
21 cm/8¼"	07.190.21	07.191.21

SUPERCUT

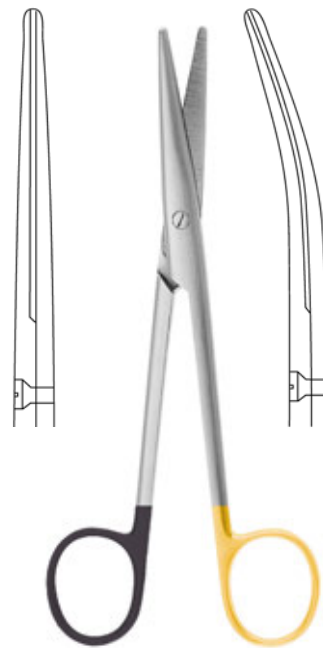

LEXER

16 cm/6¼"	07.194.16	07.195.16
21 cm/8¼"	07.194.21	07.195.21

TC-Schneiden
 TC cutting edges
 Tranchant TC
 Filos de corte TC
 Taglio TC



LITTLER
 12 cm/4¾" **08.205.12**
 14 cm/5½" **08.205.14**



DEBAKEY
08.215.17
 17,5 cm/7"

Präparierscheren

Dissecting scissors
Ciseaux à dissection
Tijeras de disección
Forbici per dissezione



METZENBAUM

11,5 cm/4½"	08.210.11	08.211.11
14 cm/5½"	08.280.14	08.281.14
14,5 cm/5¾"	08.280.15	08.281.15
15,5 cm/6"	08.210.15	08.211.15
18 cm/7"	08.280.18	08.281.18
20 cm/8"	08.280.20	08.281.20
23 cm/9"	08.280.23	08.281.23
25 cm/10"	08.280.25	08.281.25
28 cm/11"	08.280.28	08.281.28
30 cm/12"	08.280.30	08.281.30



METZENBAUM

11,5 cm/4½"	08.284.11	08.285.11
14,5 cm/5¾"	08.284.15	08.285.15
18 cm/7"	08.284.18	08.285.18
20 cm/8"	08.284.20	08.285.20
23 cm/9"	08.284.23	08.285.23
25 cm/10"	08.284.25	08.285.25
28 cm/11"	08.284.28	08.285.28
30 cm/12"	08.284.30	08.285.30

TC-Schneiden
TC cutting edges
Tranchant TC
Filos de corte TC
Taglio TC



METZENBAUM

11,5 cm/4½"	07.280.11	07.281.11
14,5 cm/5¾"	07.280.15	07.281.15
18 cm/7"	07.280.18	07.281.18
20 cm/8"	07.280.20	07.281.20
23 cm/9"	07.280.23	07.281.23
25 cm/10"	07.280.25	07.281.25
28 cm/11"	07.280.28	07.281.28
30 cm/12"	07.280.30	07.281.30



METZENBAUM

11,5 cm/4½"	07.284.11	07.285.11
14,5 cm/5¾"	07.284.15	07.285.15
18 cm/7"	07.284.18	07.285.18
20 cm/8"	07.284.20	07.285.20
23 cm/9"	07.284.23	07.285.23
25 cm/10"	07.284.25	07.285.25
28 cm/11"	07.284.28	07.285.28
30 cm/12"	07.284.30	07.285.30

SUPERCUT

TC-Schneiden
TC cutting edges
Tranchant TC
Filos de corte TC
Taglio TC

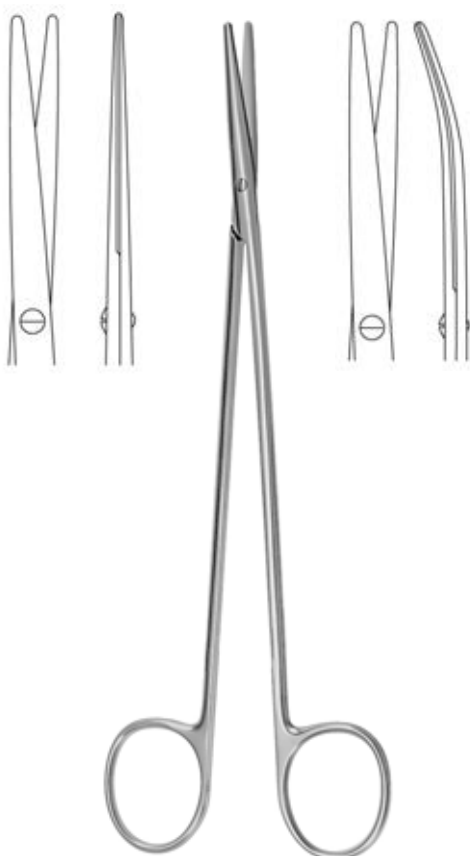

METZENBAUM FINO

14,5 cm/5¾"	08.282.15	08.283.15
18 cm/7"	08.282.18	08.283.18
20 cm/8"	08.282.20	08.283.20
23 cm/9"	08.282.23	08.283.23
25 cm/10"	08.282.25	08.283.25
28 cm/11"	08.282.28	08.283.28

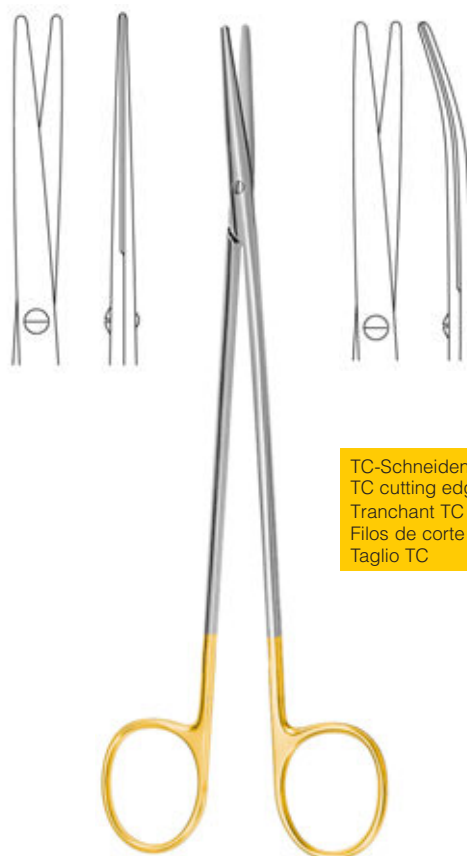

METZENBAUM FINO

14,5 cm/5¾"	08.286.15	08.287.15
18 cm/7"	08.286.18	08.287.18
20 cm/8"	08.286.20	08.287.20
23 cm/9"	08.286.23	08.287.23
25 cm/10"	08.286.25	08.287.25
28 cm/11"	08.286.28	08.287.28

TC-Schneiden
 TC cutting edges
 Tranchant TC
 Filos de corte TC
 Taglio TC

Präparierscheren

Dissecting scissors
 Ciseaux à dissection
 Tijeras de disección
 Forbici per dissezione

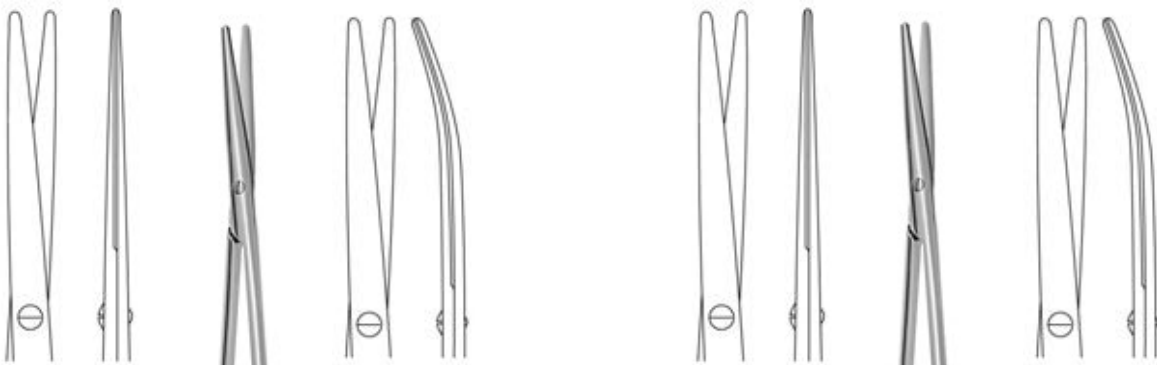

SUPERCUT

TC-Schneiden
 TC cutting edges
 Tranchant TC
 Filos de corte TC
 TaglioTC



METZENBAUM FINO



METZENBAUM FINO

14,5 cm/5¾"	07.282.15	07.283.15
18 cm/7"	07.282.18	07.283.18
20 cm/8"	07.282.20	07.283.20
23 cm/9"	07.282.23	07.283.23
25 cm/10"	07.282.25	07.283.25
28 cm/11"	07.282.28	07.283.28

14,5 cm/5¾"	07.286.15	07.287.15
18 cm/7"	07.286.18	07.287.18
20 cm/8"	07.286.20	07.287.20
23 cm/9"	07.286.23	07.287.23
25 cm/10"	07.286.25	07.287.25
28 cm/11"	07.286.28	07.287.28

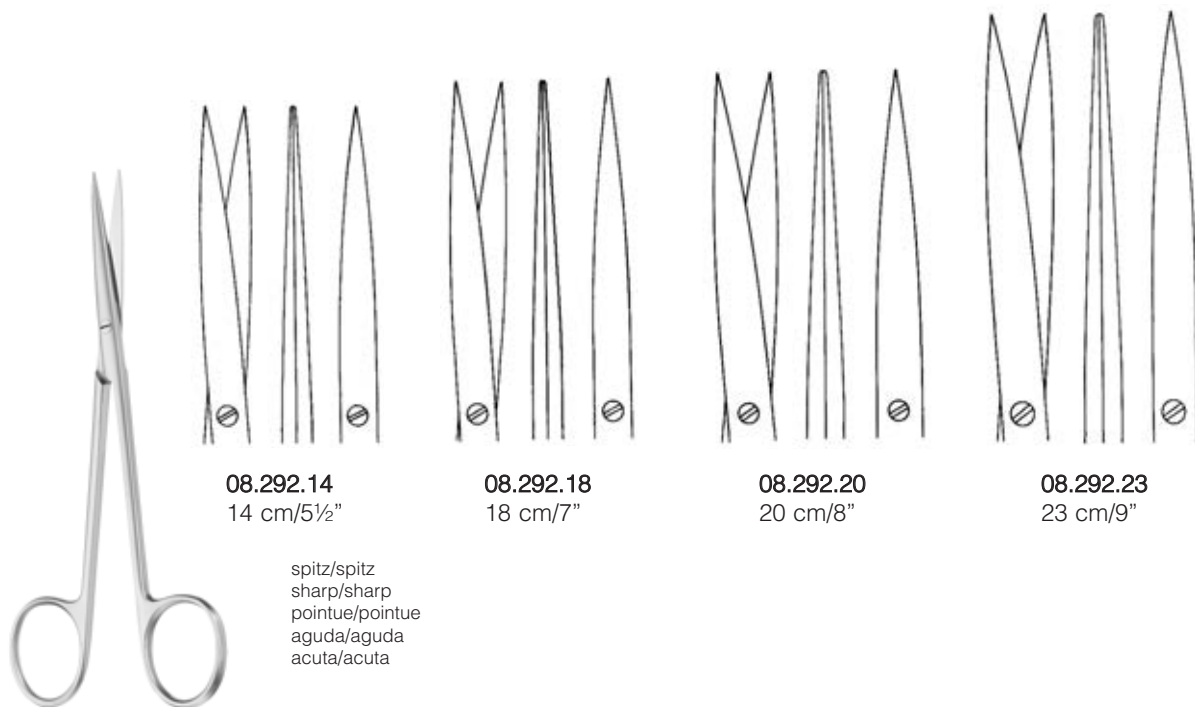

08.292.14
 14 cm/5½"

08.292.18
 18 cm/7"

08.292.20
 20 cm/8"

08.292.23
 23 cm/9"

spitz/spitz
 sharp/sharp
 pointue/pointue
 aguda/aguda
 acuta/acuta

METZENBAUM FINO

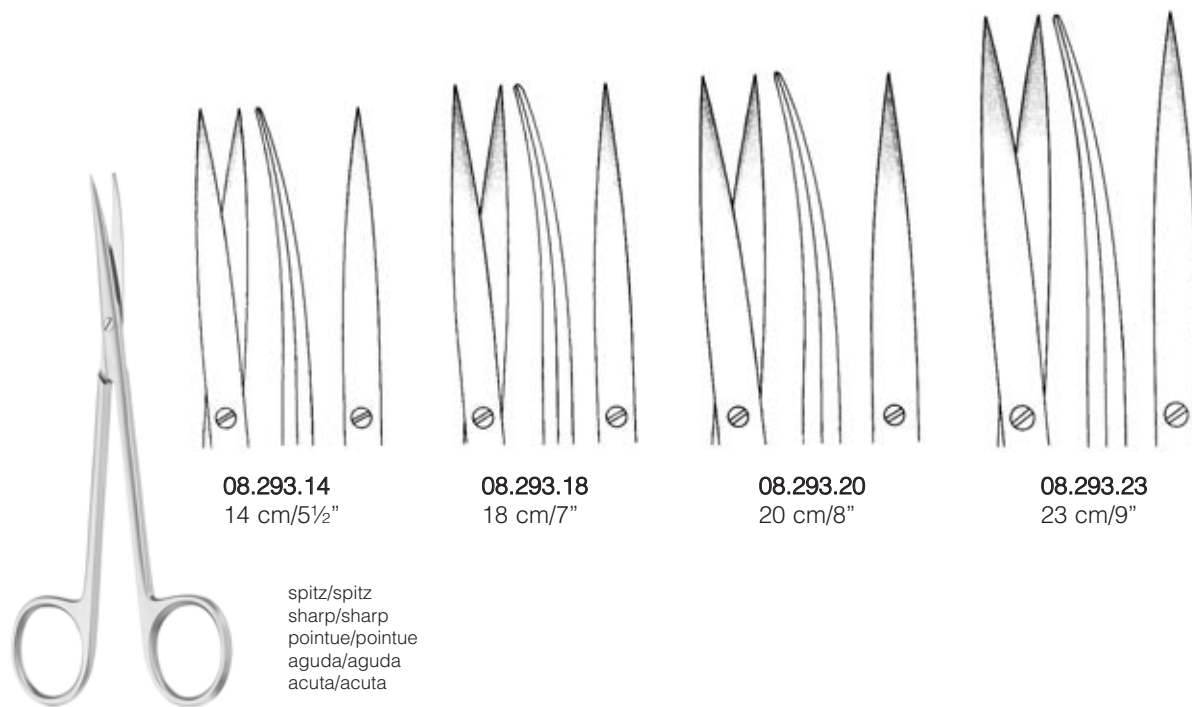

08.293.14
 14 cm/5½"

08.293.18
 18 cm/7"

08.293.20
 20 cm/8"

08.293.23
 23 cm/9"

spitz/spitz
 sharp/sharp
 pointue/pointue
 aguda/aguda
 acuta/acuta

METZENBAUM FINO

Präparierscheren

Dissecting scissors
Ciseaux à dissection
Tijeras de disección
Forbici per dissezione



METZENBAUM FINO

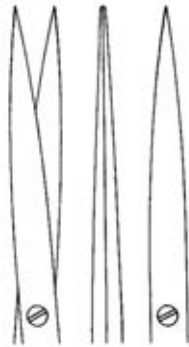

08.296.14
14,5 cm/5¾"

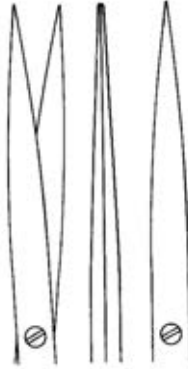

08.296.18
18 cm/7"

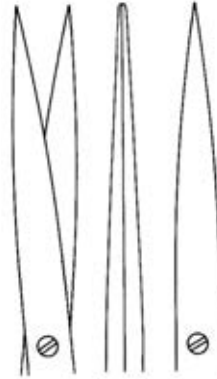

08.296.20
20 cm/8"

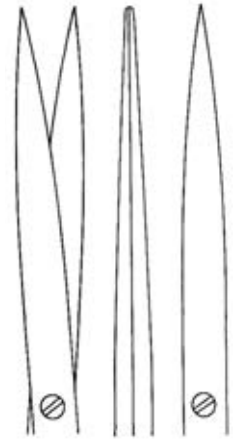

08.296.23
23 cm/9"

spitz/spitz
sharp/sharp
pointue/pointue
aguda/aguda
acuta/acuta

TC-Schneiden
TC cutting edges
Tranchant TC
Filos de corte TC
Taglio TC



METZENBAUM FINO



08.297.14
14,5 cm/5¾"



08.297.18
18 cm/7"



08.297.20
20 cm/8"



08.297.23
23 cm/9"

spitz/spitz
sharp/sharp
pointue/pointue
aguda/aguda
acuta/acuta

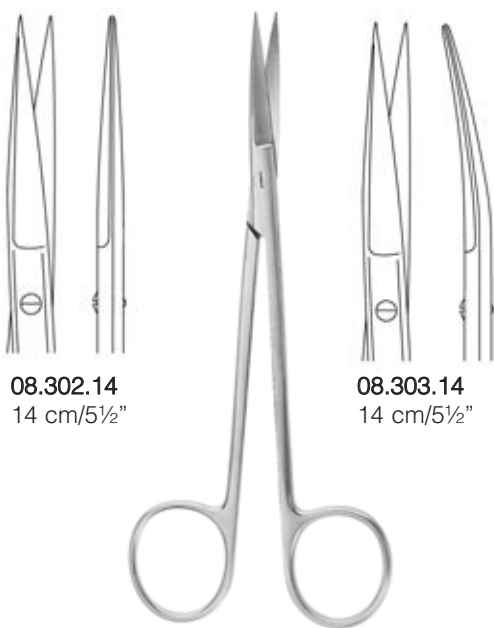
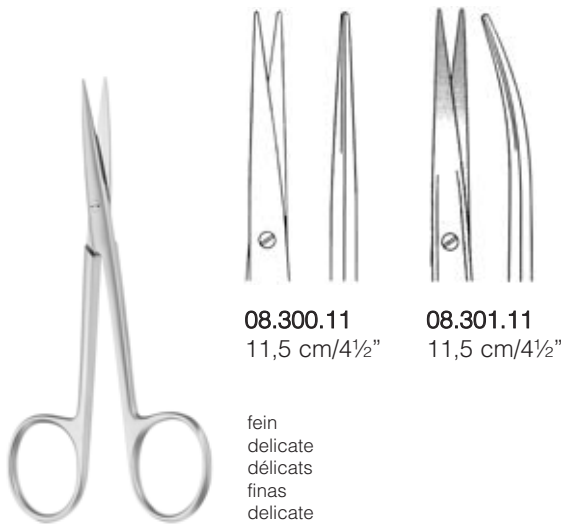

SANVENERO

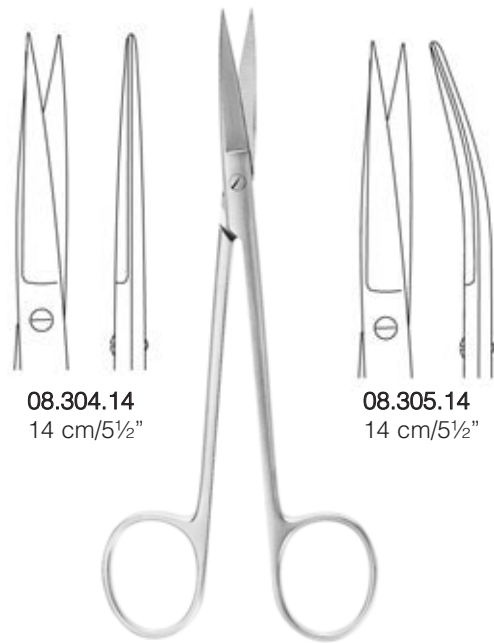

JOSEPH

Präparierscheren

Dissecting scissors
Ciseaux à dissection
Tijeras de disección
Forbici per dissezione



KILNER

12 cm/4¾" **08.310.12**
15 cm/6" **08.310.15**



KILNER

12 cm/4¾" **08.314.12**
15 cm/6" **08.314.15**

TC-Schneiden
TC cutting edges
Tranchant TC
Filos de corte TC
Taglio TC



KILNER

12 cm/4¾" **07.310.12**
15 cm/6" **07.310.15**

SUPERCUT



KILNER

12 cm/4¾" **07.314.12**
15 cm/6" **07.314.15**

TC-Schneiden
TC cutting edges
Tranchant TC
Filos de corte TC
Taglio TC



REYNOLDS
08.320.15
 15 cm/6"

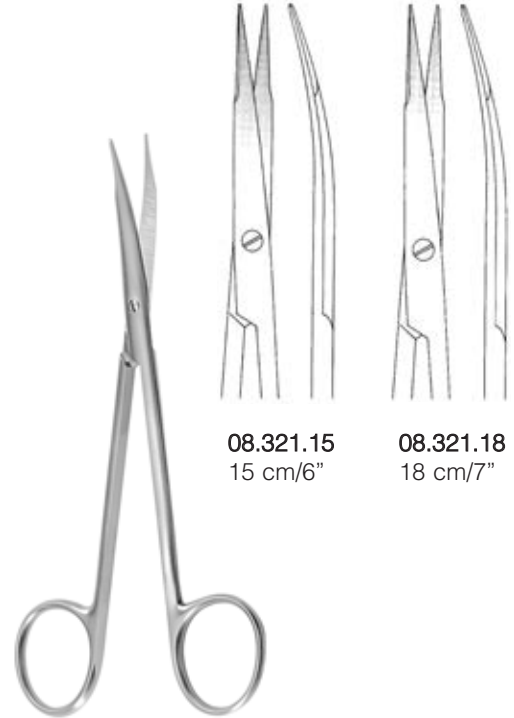

08.321.15
 15 cm/6"

08.321.18
 18 cm/7"

REYNOLDS

TC-Schneiden
 TC cutting edges
 Tranchant TC
 Filos de corte TC
 Taglio TC



REYNOLDS
08.324.15
 15 cm/6"

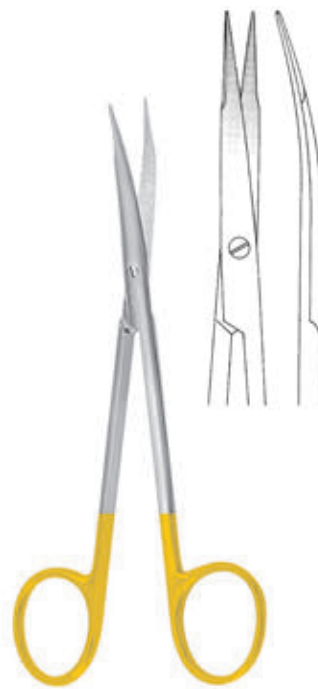

REYNOLDS
08.325.15
 15 cm/6"

Irisscheren

Iris scissors
Ciseaux à iridectomie
Tijeras para iridectomía
Forbici per iridectomia

TC-Schneiden
TC cutting edges
Tranchant TC
Filos de corte TC
Taglio TC



IRIS

9 cm/3½"	08.340.09
10,5 cm/4¼"	08.340.10
11,5 cm/4½"	08.340.11
12,5 cm/5"	08.340.12



IRIS

9 cm/3½"	08.341.09
10,5 cm/4¼"	08.341.10
11,5 cm/4½"	08.341.11
12,5 cm/5"	08.341.12



IRIS

08.344.11

11,5 cm/4½"



IRIS

08.345.11

11,5 cm/4½"



08.342.10 08.343.10

IRIS

10,5 cm/4¼"

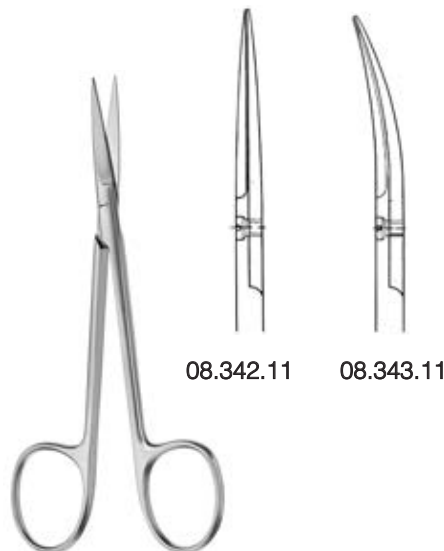

08.342.11 08.343.11

IRIS

11,5 cm/4½"



IRIS

08.351.11

11,5 cm/4½"



IRIS

08.353.11

11,5 cm/4½"

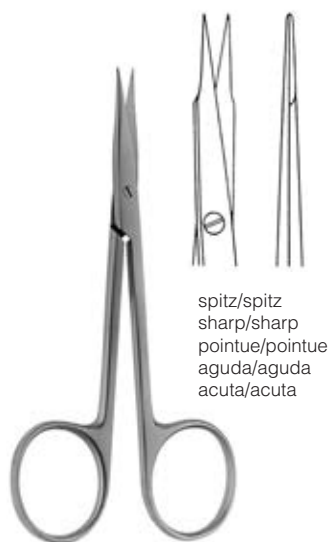

spitz/spitz
 sharp/sharp
 pointue/pointue
 aguda/aguda
 acuta/acuta

STEVENS
08.360.11
 10,5 cm/4½"

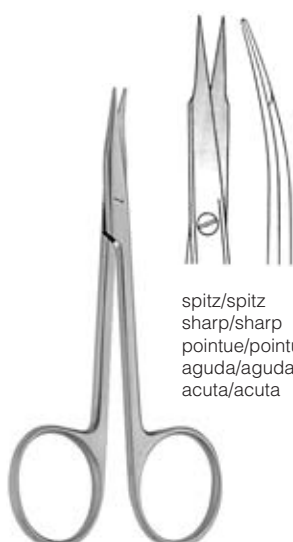

spitz/spitz
 sharp/sharp
 pointue/pointue
 aguda/aguda
 acuta/acuta

STEVENS
08.361.11
 10,5 cm/4½"

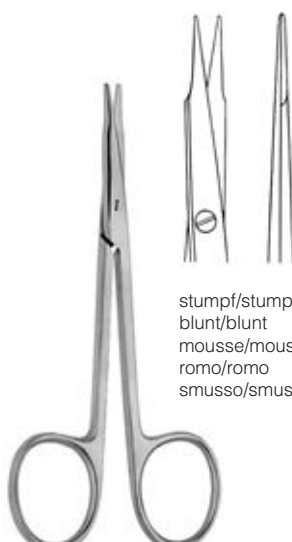

stumpf/stumpf
 blunt/blunt
 mousse/mousse
 romo/romo
 smusso/smusso

STEVENS
08.362.11
 10,5 cm/4½"

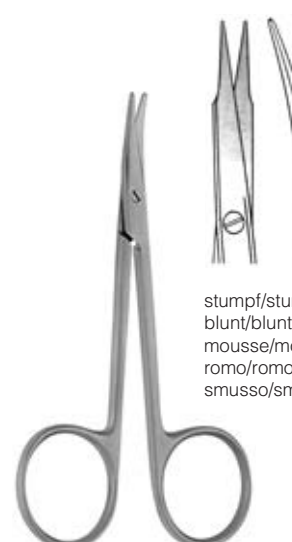

stumpf/stumpf
 blunt/blunt
 mousse/mousse
 romo/romo
 smusso/smusso

STEVENS
08.363.11
 10,5 cm/4½"

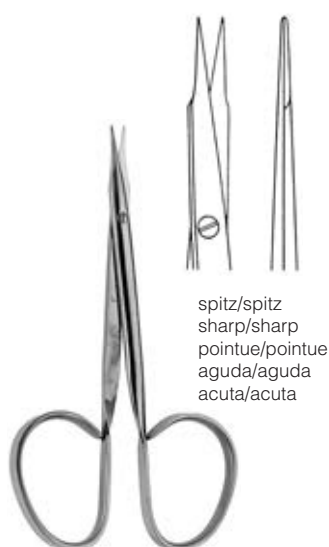

spitz/spitz
 sharp/sharp
 pointue/pointue
 aguda/aguda
 acuta/acuta

STEVENS
08.364.10
 10,5 cm/4½"

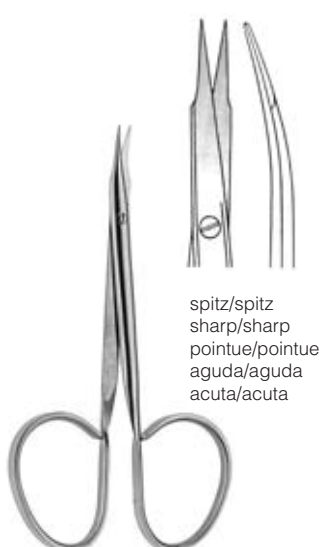

spitz/spitz
 sharp/sharp
 pointue/pointue
 aguda/aguda
 acuta/acuta

STEVENS
08.365.10
 10,5 cm/4½"



stumpf/stumpf
 blunt/blunt
 mousse/mousse
 romo/romo
 smusso/smusso

STEVENS
08.366.10
 10,5 cm/4½"

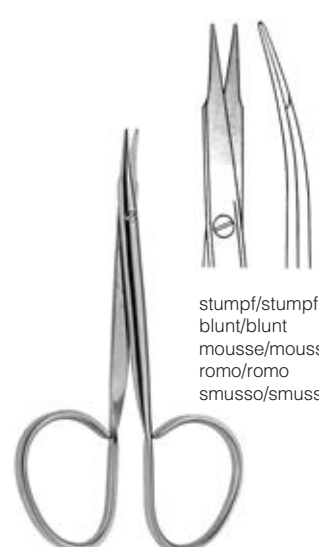

stumpf/stumpf
 blunt/blunt
 mousse/mousse
 romo/romo
 smusso/smusso

STEVENS
08.367.10
 10,5 cm/4½"

Feine Scheren, Strabismusscheren

Delicate scissors, strabismus scissors
 Ciseaux délicats, ciseaux à strabisme
 Tijeras finas, tijeras para estrabismo
 Forbici delicate, forbici per strabismo

Strabismusscheren
 Strabismus scissors
 Ciseaux à strabisme
 Tijeras para estrabismo
 Forbici per strabismo



TC-Schneiden
 TC cutting edges
 Tranchant TC
 Filos de corte TC
 Taglio TC

gezahnt
 toothed
 dentelés
 dentadas
 dentate



Trigeminusschere
 (auch für die Nase)

Trigeminal scissors
 (also for nose)

Ciseaux pour le nerf trigéminale
 (aussi pour le nez)

Tijeras para nervio trigémino
 (también para la nariz)

Forbici per il nervo trigemino
 (anche per il naso)

OLIVECRONA
 08.475.23
 23 cm/9"

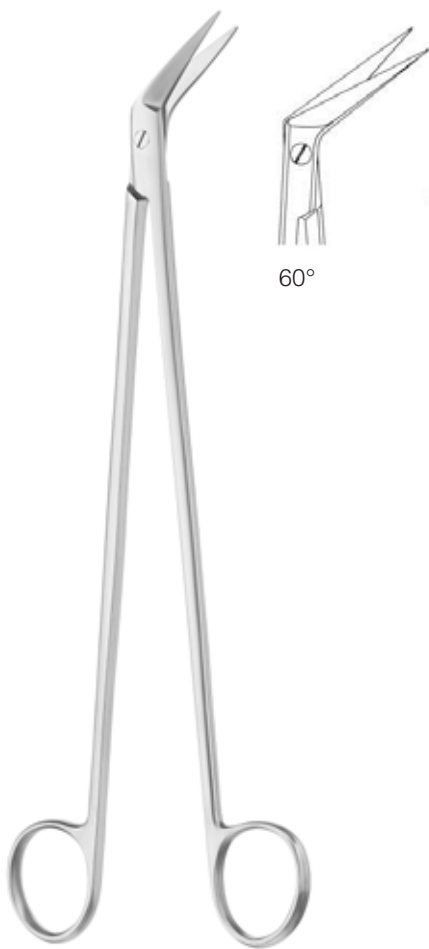

POTTS DE MARTEL
21 cm/8¼" **08.473.21**
24 cm/9½" **08.473.24**

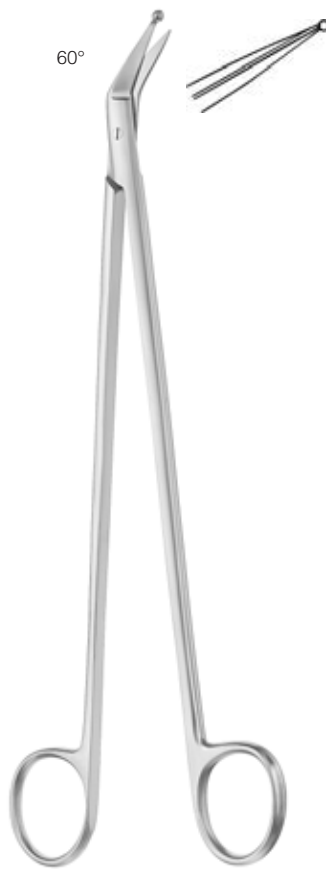

MILLS
08.475.22
22 cm/8¾"

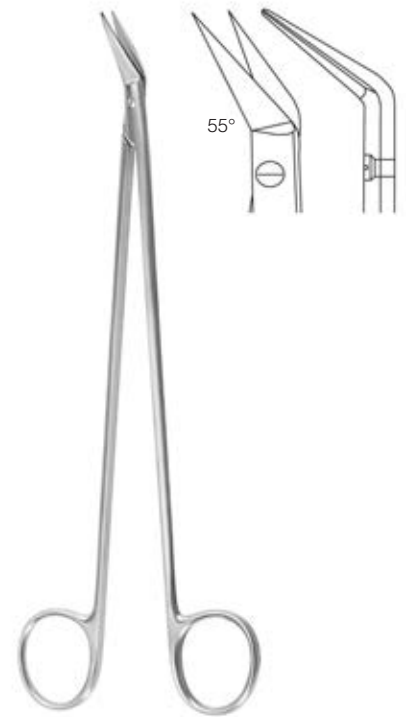

POTTS-SMITH
08.480.18
18,5 cm/7¼"

Gefäßscheren

Vascular scissors
Ciseaux vasculaires
Tijeras vasculares
Forbici vascolari



POTTS-SMITH

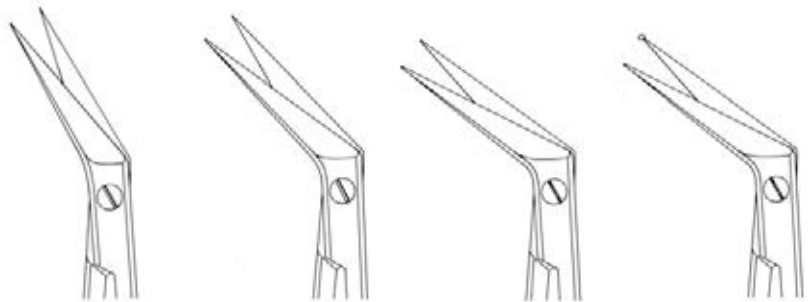

	25°	40°	60°	60°
19 cm/7½"	08.480.25	08.480.40	08.480.60	08.480.61



POTTS-SMITH

TC-Schneiden
TC cutting edges
Tranchant TC
Filos de corte TC
Taglio TC

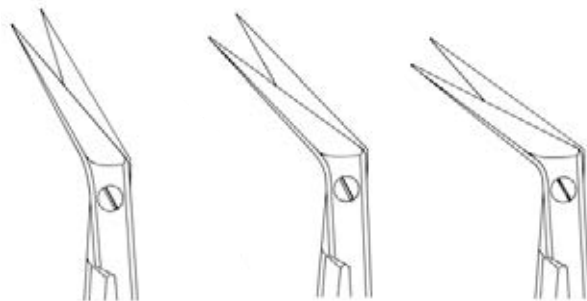

	25°	40°	60°
19 cm/7½"	08.484.25	08.484.40	08.484.60

SUPERCUT



POTTS-SMITH

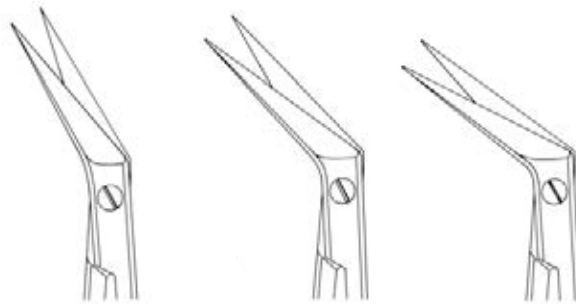

	25°	40°	60°
19 cm/7½"	07.480.25	07.480.40	07.480.60



POTTS-SMITH

TC-Schneiden
 TC cutting edges
 Tranchant TC
 Filos de corte TC
 Taglio TC

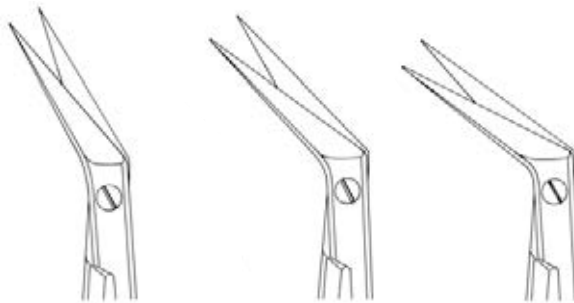

	25°	40°	60°
19 cm/7½"	07.484.25	07.484.40	07.484.60

Gefäßscheren

Vascular scissors

Ciseaux vasculaires

Tijeras vasculares

Forbici vascolari



DIETHRICH

16 cm/6¼"	08.485.25
18 cm/7"	08.486.25



DIETHRICH

16 cm/6¼"	08.485.45
18 cm/7"	08.486.45



DIETHRICH

16 cm/6¼"	08.485.60
18 cm/7"	08.486.60



DIETHRICH

16 cm/6¼"	08.485.90
18 cm/7"	08.486.90



DIETHRICH

16 cm/6¼"	08.485.92
18 cm/7"	08.487.25



DIETHRICH

08.488.25
18 cm/7"

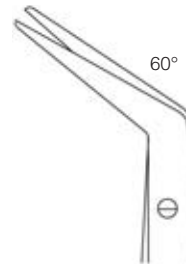
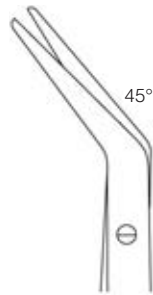
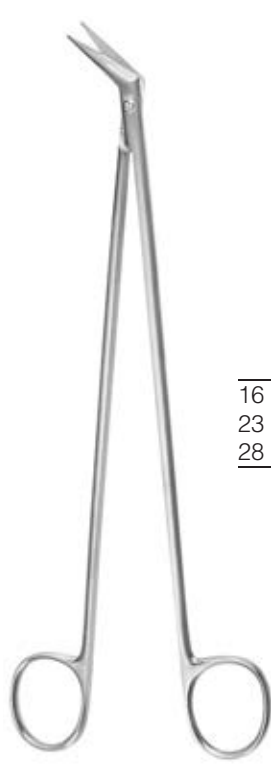

	25°	45°	60°
16 cm/6¼"	08.490.16	08.491.16	08.492.16
23 cm/9"	08.490.23	08.491.23	08.492.23
28 cm/11"	08.490.28	08.491.28	08.492.28

DE BAKEY

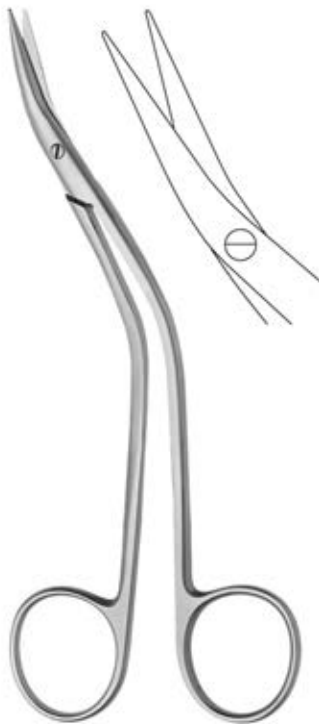

DE BAKEY
08.495.15
 15,5 cm/6"

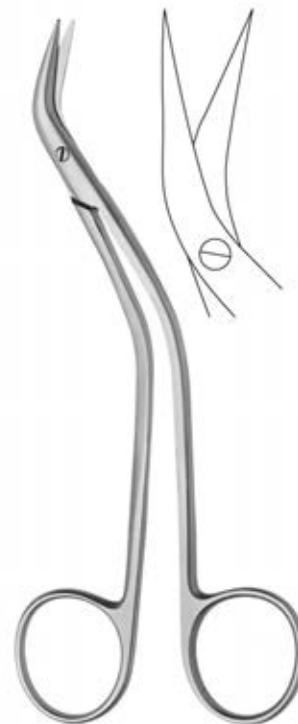

DE BAKEY
08.497.15
 15,5 cm/6"

Präparierscheren

Dissecting scissors
Ciseaux à dissection
Tijeras de disección
Forbici per dissezione

Nerv-Präparierscheren
Nerve dissecting scissors
Ciseaux à préparation de nerfs
Tijeras para preparación de nervios
Forbici per preparazione di nervi

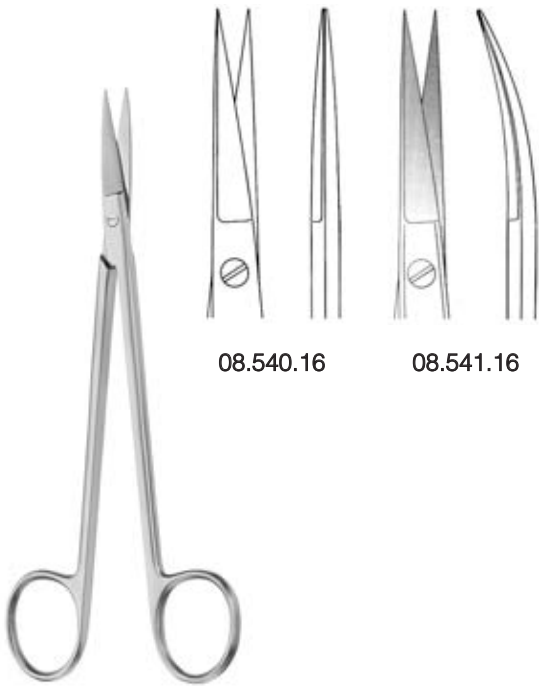

08.540.16

08.541.16

KELLY

16 cm/6¼"

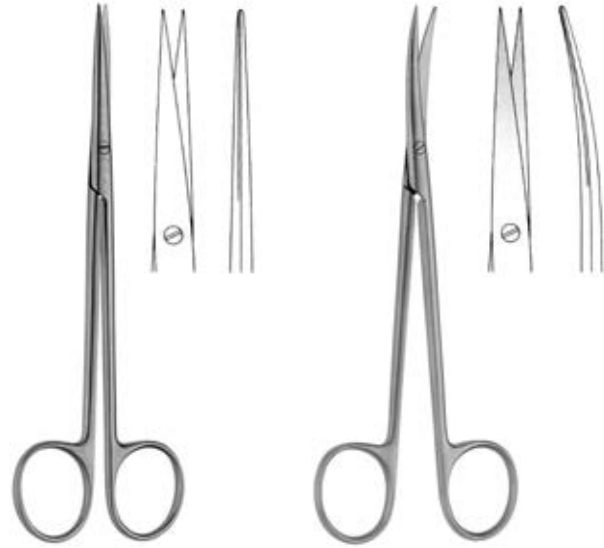

08.582.15

15 cm/6"

08.583.15

15 cm/6"



fein
delicate
délicats
finas
delicate

JAMESON WERBER

08.584.13

13 cm/5"



08.584.15
15 cm/6"

fein
delicate
délicats
finas
delicate

08.585.18
18 cm/7"

JAMESON

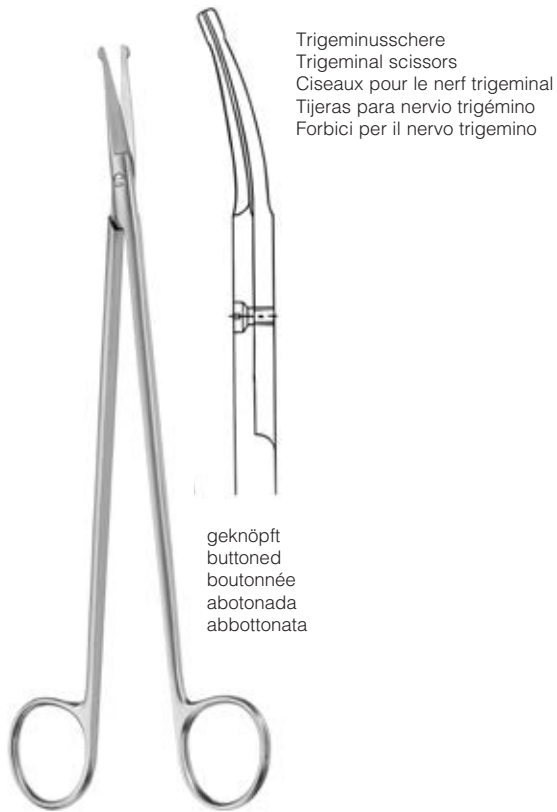

Trigeminusschere
 Trigeminal scissors
 Ciseaux pour le nerf trigéminal
 Tijeras para nervio trigémino
 Forbici per il nervo trigemino

geknöpft
 buttoned
 boutonnée
 abotonada
 abbottonata

STRULLY
08.601.22
 22 cm/8¾"

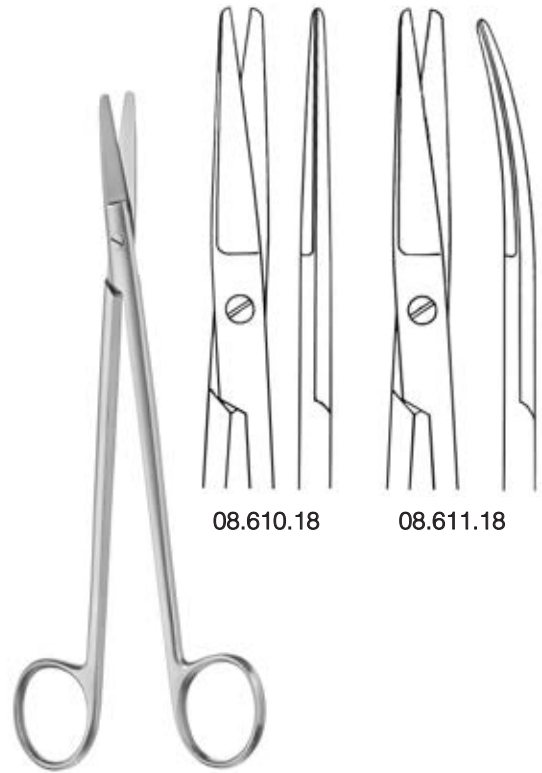

08.610.18

08.611.18

TOENNIS ADSON
 18 cm/7"



08.609.17

sehr fein
 very delicate
 très délicats
 muy finas
 molto delicate

08.609.18

fein
 delicate
 délicats
 finas
 delicate

TOENNIS ADSON
 17,5 cm/7"

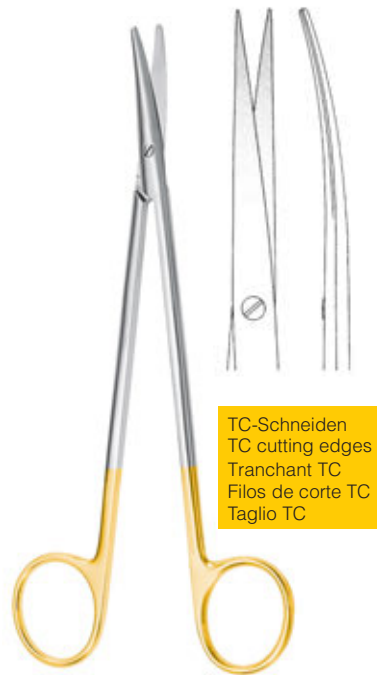

TC-Schneiden
 TC cutting edges
 Tranchant TC
 Filos de corte TC
 Taglio TC

TOENNIS-ADSON
08.613.17
 17 cm/6¾"

Scheren für Neurochirurgie
 Neurosurgical scissors
 Ciseaux neurochirurgicaux
 Tijeras para cirugía neurocirugía
 Forbici neurochirurgiche

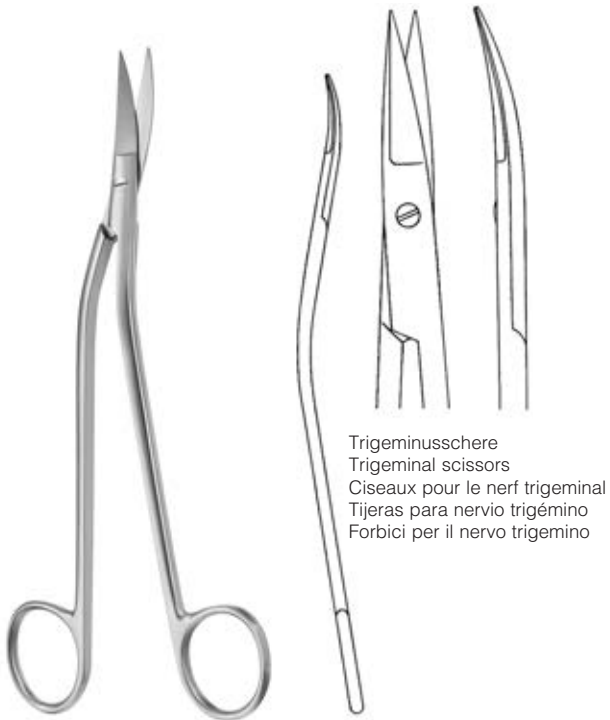

Trigeminusschere
 Trigeminal scissors
 Ciseaux pour le nerf trigéminal
 Tijeras para nervio trigémino
 Forbici per il nervo trigemino

DANDY
08.617.17
 17 cm/6¾"

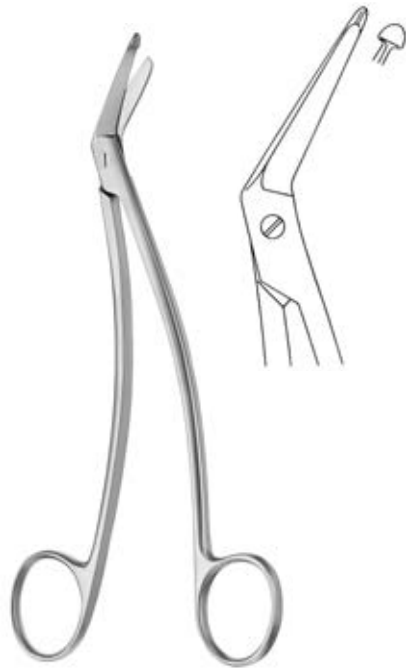

SCHMIEDEN TAYLOR
08.619.17
 17 cm/6¾"

Zahnfleischscheren
 Gum scissors
 Ciseaux à gencive
 Tijeras para encías
 Forbici per gengive

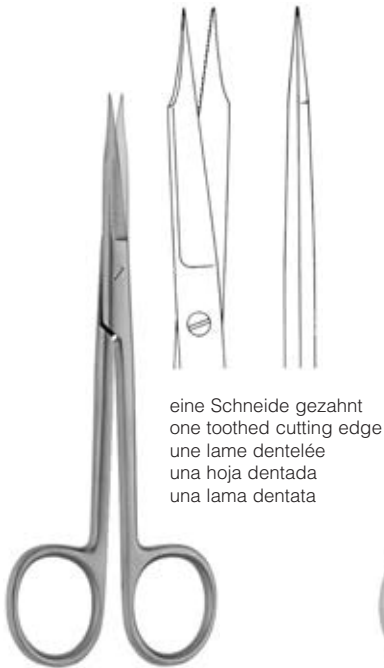

eine Schneide gezahnt
 one toothed cutting edge
 une lame dentelée
 una hoja dentada
 una lama dentata

GOLDMAN FOX
08.820.13
 13 cm/5"

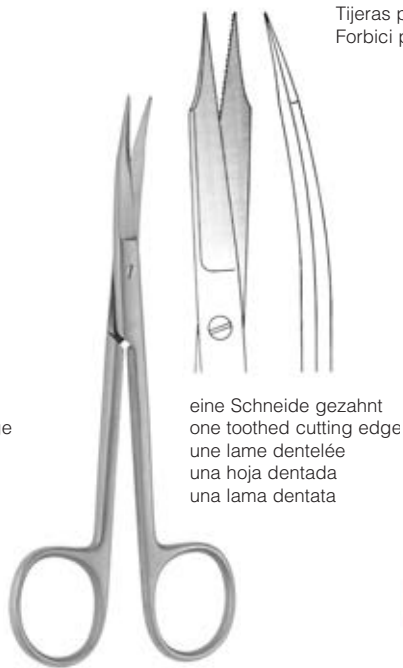

eine Schneide gezahnt
 one toothed cutting edge
 une lame dentelée
 una hoja dentada
 una lama dentata

GOLDMAN FOX
08.821.13
 13 cm/5"



TC-Schneiden
 TC cutting edges
 Tranchant TC
 Filos de corte TC
 Taglio TC

GOLDMAN FOX
08.822.13
 13 cm/5"



GOLDMAN FOX
08.823.13
 13 cm/5"

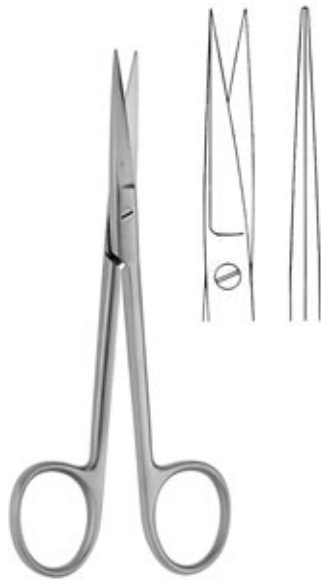

WAGNER
08.824.12
 12 cm/6¾"



WAGNER
08.825.12
 12 cm/6¾"

Draht-Scheren
 Wire cutting scissors
 Ciseaux coupe-fil
 Tijeras para cortar hilo
 Forbici per tagliare fili



eine Schneide gezahnt
 one toothed cutting edge
 une lame dentelée
 una hoja dentada
 una lama dentata

UNIVERSAL
08.831.12
 12 cm/4¾"



eine Schneide gezahnt
 one toothed cutting edge
 une lame dentelée
 una hoja dentada
 una lama dentata

UNIVERSAL
08.835.12
 12 cm/4¾"

TC-Schneiden
 TC cutting edges
 Tranchant TC
 Filos de corte TC
 Taglio TC

Verbandsscheren

Bandage scissors
Ciseaux à bandages
Tijeras para vendajes
Forbici per bendaggi

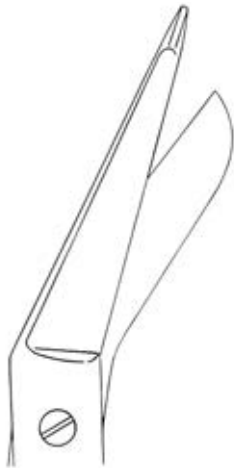

LISTER

9 cm/3½"	08.901.09
11 cm/4¼"	08.901.11
14 cm/5½"	08.901.14
16 cm/6¼"	08.901.16
18 cm/7"	08.901.18
20 cm/8"	08.901.20
25 cm/10"	08.901.25

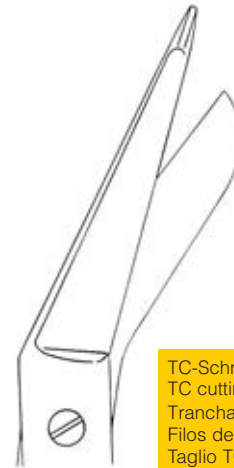

TC-Schneiden
TC cutting edges
Tranchant TC
Filos de corte TC
Taglio TC

LISTER

14 cm/5½"	08.905.14
18 cm/7"	08.905.18
20 cm/8"	08.905.20



UNIVERSAL

schwarz	blau	grün	rot	gelb	weiß
black	blue	green	red	yellow	white
noir	bleu	vert	rouge	jaune	blanc
negro	azul	verde	rojo	amarillo	blanco
nero	blu	verde	rosso	giallo	bianco

15 cm/6"	08.950.15	08.950.15B	08.950.15G	08.950.15R	08.950.15Y	08.950.15W
18 cm/7"	08.950.18	08.950.18B	08.950.18G	08.950.18R	08.950.18Y	08.950.18W

04



◆ **MIKRO-SCHEREN**

MICRO SCISSORS

MICRO-CISEAUX

MICRO TIJERAS

MICRO FORBICI

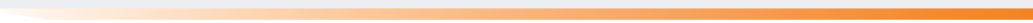

Mikro-Scheren

Micro scissors
Micro-ciseaux
Micro tijeras
Micro forbici



CASTROVIEJO
10 cm/4"



09.133.10

spitz/spitz
sharp/sharp
pointu/pointu
agudo/agudo
acuto/acuto



09.135.10

stumpf/stumpf
blunt/blunt
mousse/mousse
romo/romo
smusso/smusso



VANNAS
8 cm/3 1/4"



09.140.08



09.141.08



09.143.08



10 mm
Blattlänge
Length of blades
Longeur des lames
Largo de hojas
Lunghezza della lama



14 mm
Blattlänge
Length of blades
Longeur des lames
Largo de hojas
Lunghezza della lama

14 cm/5 1/2"	09.202.14	09.203.14
15 cm/6"	09.202.15	09.203.15
16,5 cm/6 1/2"	09.202.16	09.203.16
18 cm/7"	09.202.18	09.203.18

16,5 cm/6 1/2"	09.204.16	09.205.16
18 cm/7"	09.204.18	09.205.18

Mikro-Präparierschere
 Micro dissecting scissors
 Micro-ciseaux à dissection
 Micro tijeras de disección
 Micro forbici per dissezione



14,5 cm/5¾"	09.220.14	09.221.14	09.223.14
18 cm/7"	09.220.18	09.221.18	09.223.18
23 cm/9"	09.220.23	09.221.23	

spitz/spitz
 sharp/sharp
 pointu/pointu
 agudo/agudo
 acuto/acuto

spitz/spitz
 sharp/sharp
 pointu/pointu
 agudo/agudo
 acuto/acuto

stumpf/stumpf
 blunt/blunt
 mousse/mousse
 romo/romo
 smusso/smusso



VANNAS
09.228.14
 14,5 cm/5¾"



VANNAS
09.229.14
 14,5 cm/5¾"



GOMEL
09.221.16
 16 cm/6¼"

Mikro-Gefäßscheren

Vascular micro scissors
 Micro-ciseaux vasculaires
 Tijeras microquirúrgicas vasculares
 Forbici micro-chirurgici vascolari



18 cm/7"

Schneideblatt
 Cutting edge
 Lame
 Filo cortante
 Filo di lama

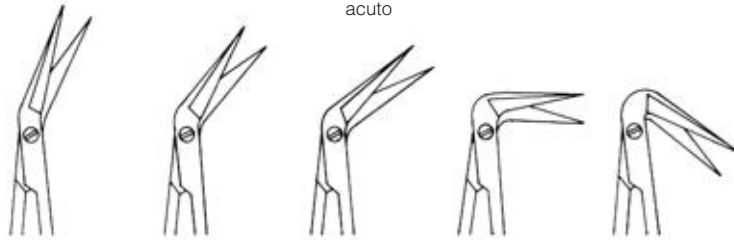

25° 45° 60° 90° 125°

spitz
 sharp
 pointu
 agudo
 acuto

Flachgriff Flat handle Manche plat Mango plano Manico piatto	14 mm	09.224.25	09.224.45	09.224.60	09.224.90	09.225.00
TOLEDO	7 mm	09.236.25	09.236.45	09.236.60	09.236.90	09.237.25
	10 mm	09.234.25	09.234.45	09.234.60	09.234.90	09.235.25
	14 mm	09.230.25	09.230.45	09.230.60	09.230.90	09.231.25

Schneideblatt
 Cutting edge
 Lame
 Filo cortante
 Filo di lama

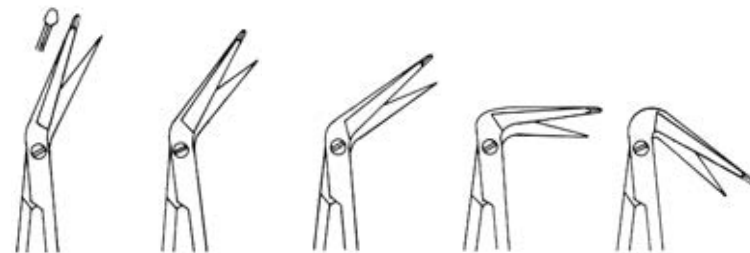

25° 45° 60° 90° 125°

1 Blatt geknöpft
 1 blade buttoned
 1 lame boutonnée
 1 hoja abotonada
 1 lama abbottonata

Flachgriff Flat handle Manche plat Mango plano Manico piatto	14 mm	09.225.25	09.225.45	09.225.60	09.225.90	09.226.00
TOLEDO	14 mm	09.232.25	09.232.45	09.232.60	09.232.90	09.233.25



TOLEDO
 16,5 cm/6½"



NAGEL



45°

09.245.20
20 cm/8"



45°

09.246.20
20 cm/8"



125°

09.247.19
19 cm/7½"

1 Blatt geknöpft
1 blade buttoned
1 lame boutonnée
1 hoja abotonada
1 lama abbottonata

Mikro-Scheren

Micro scissors
Micro-ciseaux
Micro tijeras
Micro forbici



YASARGIL



16,5 cm/6½"	09.250.16	09.251.16	
20 cm/8"	09.250.20	09.251.20	09.253.20

Mikro-Präparierschere
Micro dissecting scissors
Micro-ciseaux à dissection
Micro tijeras de disección
Micro forbici per dissezione

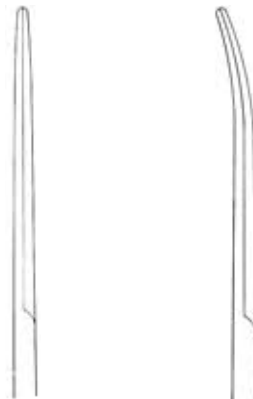

09.254.20
20 cm/8"

09.255.20
20 cm/8"



YASARGIL

gezahnt
 toothed
 dentelés
 dentadas
 dentate



22,5 cm/9"
 24,5 cm/9¾"

09.250.22

09.252.22

09.251.22

09.253.22

09.251.24

Mikro-Präparierschere
 Micro dissecting scissors
 Micro-ciseaux à dissection
 Micro tijeras de disección
 Micro forbici per dissezione



09.254.22
 22,5 cm/9"

09.255.22
 22,5 cm/9"

VANNAS
09.248.23
 22,5 cm/9"

VANNAS
09.249.23
 22,5 cm/9"

Mikro-Scheren

Micro scissors
Micro-ciseaux
Micro tijeras
Micro forbici



YASARGIL

YASARGIL

12 cm/4 ³ / ₄ "	09.260.12	09.261.12
16 cm/6 ¹ / ₄ "	09.260.16	09.261.16
18,5 cm/7 ¹ / ₄ "	09.260.18	09.261.18



VANNAS

VANNAS

VANNAS

12 cm/4 ³ / ₄ "	09.262.12	09.263.12	09.265.12
16 cm/6 ¹ / ₄ "	09.262.16	09.263.16	



gezahnt
toothed
dentelés
dentadas
dentate



gezahnt
toothed
dentelés
dentadas
dentate

MILLES

09.270.16
16 cm/6¹/₄"

MILLES

09.271.16
16 cm/6¹/₄"



Venenschere
Vein scissors
Ciseaux pour veines
Tijeras para venas
Forbici per vene

BIEMER

09.264.13
13 cm/5"

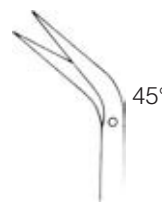

45°

seitwärts abgewinkelt
angled to side
coudés latéralement
acodadas hacia el lado
angolata lateralmente

POTTS-YASARGIL

09.261.19
18,5 cm/7¹/₄"



09.266.18

18,5 cm/7¼"



09.267.18



09.268.18

VANNAS
18,5 cm/7¼"



09.269.18



JACOBSON
09.257.19
19 cm/7½"

Mikro-Scheren

Micro scissors
Micro-ciseaux
Micro tijeras
Micro forbici

Leichtmetall Rundgriffe, gut ausbalanciert
Light-weight round handles, well-balanced
Manches ronds en métal léger, bien équilibrés
Mangos redondos de metal ligero, bien equilibrados
Manici rotondi metallo leggero, equilibrio perfetto



15 cm/5"	09.300.15	09.301.15
18 cm/7"	09.300.18	09.301.18



18 cm/7"	09.302.18	09.303.18
----------	-----------	-----------

SUPERCUT



gezahnt
toothed
dentelés
dentadas
dentate

15 cm/5"	09.304.15	09.305.15
18 cm/7"	09.304.18	09.305.18



runde Schneideblätter
round cutting blades
lames rondes
hojas redondas
lame rotonde

15 cm/5"	09.307.15	09.309.15
18 cm/7"	09.307.18	09.309.18



TOLEDO
 16,5 cm/6½"

Schneideblatt
 Cutting edge
 Lame
 Filo cortante
 Filo di lama



7 mm	09.356.07	09.357.07
10 mm	09.356.10	09.357.10
14 mm	09.356.14	09.357.14

- ergonomischer Griff
- ansprechendes Design
- sichere und feinfühlig Handhabung
- leichtes Reinigen
- keine schmutzanfälligen Riefelungen

- ergonomic handle
- sophisticated design
- safe and fine feeling in hand, well balanced
- easy to clean
- no dirt catching knurlings

- poignée ergonomique
- aspect attrayant
- une manipulation délicate et en sécurité
- la précision du geste opératoire
- un nettoyage facile
- striure pas sensible à la saleté

- mango ergonómico
- diseño llamativo
- manipulación segura y delicada
- limpieza fácil
- las estriadas no son susceptible a la suciedad

- manico ergonomico
- design appariscente
- maneggio sicuro e delicato
- purificazione facile
- non incline de la sporcizia

Mikro-Gefäßscheren

Vascular micro scissors

Micro-ciseaux vasculaires

Tijeras microquirúrgicas vasculares

Forbici micro-chirurgici vascolari



Schneide 10 mm
Cutting edge 10 mm
Lame 10 mm
Filo cortante 10 mm
Filo di lama 10mm

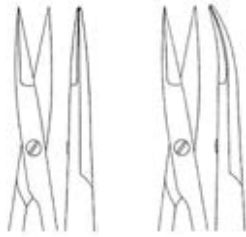

15 cm/6"	09.710.15	09.711.15
18 cm/7"	09.710.18	09.711.18
21 cm/8¼"	09.710.21	09.711.21
23 cm/9"	09.710.23	09.711.23

Rundgriff
Round handle
Manche rond
Mango redondo
Manico rotondo



Schneide 10 mm
Cutting edge 10 mm
Lame 10 mm
Filo cortante 10 mm
Filo di lama 10 mm

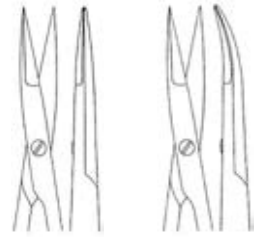

15 cm/6"	09.712.15	09.713.15
18 cm/7"	09.712.18	09.713.18
21 cm/8¼"	09.712.21	09.713.21
23 cm/9"	09.712.23	09.713.23

Flachgriff
Flat handle
Manche plat
Mango plano
Manico piatto

05



◆ **PINZETTEN**

THUMB & TISSUE FORCEPS

PINCES

PINZAS

PINZE

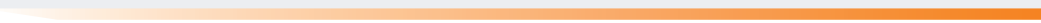

Pinzetten

Thumb and tissue forceps
 Pincès à dissection
 Pinzas de disección
 Pinze per dissezione

schmal
 narrow
 étroite
 estrecha
 stretta



11,5 cm/4½"	10.102.11	10.110.11
13 cm/5"	10.102.13	10.110.13
14,5 cm/5¾"	10.102.14	10.110.14
16 cm/6¼"	10.102.16	10.110.16
18 cm/7"	10.102.18	10.110.18
20 cm/8"	10.102.20	10.110.20
25 cm/10"	10.102.25	10.110.25
30 cm/12"	10.102.30	10.110.30



mit TC-Einsätzen
 with TC inserts
 avec mors TC
 con bocas TC
 con morso TC

14,5 cm/5¾"	10.114.14
16 cm/6¼"	10.114.16



mit TC-Einsätzen
 with TC inserts
 avec mors TC
 con bocas TC
 con morso TC

POTTS-SMITH

15,5 cm/6"		10.116.15
18 cm/7"	10.112.18	10.116.18
20 cm/8"		10.116.20
21 cm/8¼"	10.112.21	10.116.21
23 cm/9"		10.116.23
25 cm/10"	10.112.25	10.116.25
30 cm/12"	10.112.30	

1:2



1:2



schmal
 narrow
 étroite
 estrecha
 stretta

11,5 cm/4½"	10.120.11	10.130.11
13 cm/5"	10.120.13	10.130.13
14,5 cm/5¾"	10.120.14	10.130.14
16 cm/6¼"	10.120.16	10.130.16
18 cm/7"	10.120.18	10.130.18
20 cm/8"	10.120.20	10.130.20
23 cm/9"	10.120.23	
25 cm/10"	10.120.25	10.130.25
30 cm/12"	10.120.30	10.130.30

1:2



mittel
 medium
 moyen
 medio
 mezzo

13 cm/5"	10.131.13
14,5 cm/5¾"	10.131.14

2:3



11,5 cm/4½"	10.140.11
13 cm/5"	10.140.13
14,5 cm/5¾"	10.140.14
16 cm/6¼"	10.140.16
18 cm/7"	10.140.18
20 cm/8"	10.140.20
25 cm/10"	10.140.25

1:2



POTTS-SMITH

18 cm/7"	10.126.18
21 cm/8¼"	10.126.21
25 cm/10"	10.126.25
40 cm/16"	10.126.40

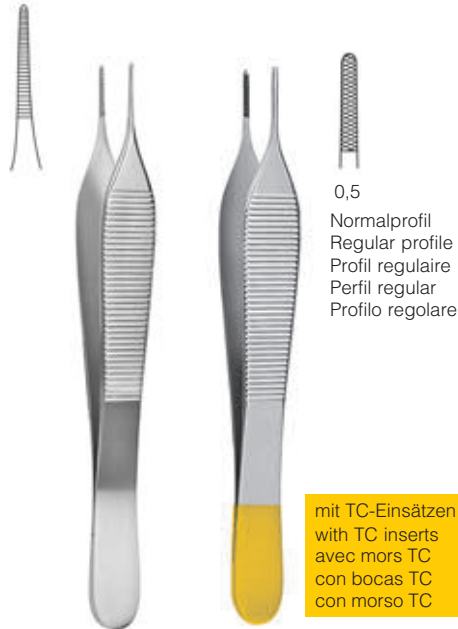

mit TC-Einsätzen
 with TC inserts
 avec mors TC
 con bocas TC
 con morso TC

ADSON

12 cm/4¾"	10.170.12	10.174.12
15 cm/6"	10.170.15	10.174.15
18 cm/7"	10.170.18	



ADSON micro

12 cm/4¾"	10.176.12
15 cm/6"	10.176.15

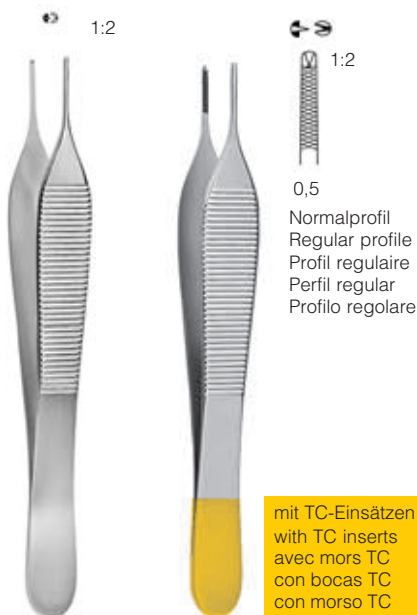

mit TC-Einsätzen
 with TC inserts
 avec mors TC
 con bocas TC
 con morso TC

ADSON

12 cm/4¾"	10.180.12	10.184.12
15 cm/6"	10.180.15	10.184.15
18 cm/7"	10.180.18	

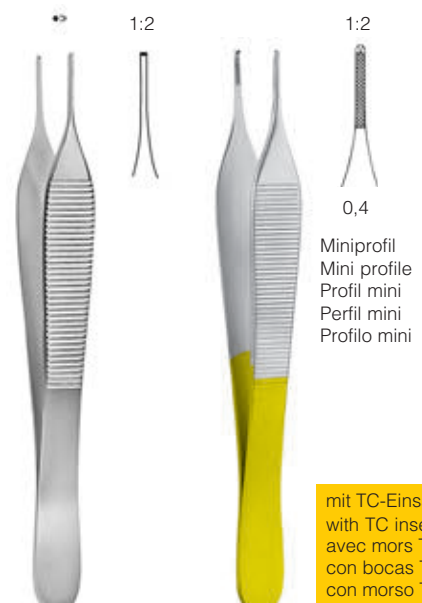

mit TC-Einsätzen
 with TC inserts
 avec mors TC
 con bocas TC
 con morso TC

ADSON micro

12 cm/4¾"	10.186.12	10.173.12
15 cm/6"	10.186.15	10.173.15
18 cm/7"	10.186.18	

Pinzetten

Thumb and tissue forceps
 Pincès à dissection
 Pinzas de disección
 Pinze per dissezione

kreuzgerieft
 cross serrated
 striure en croix
 estrias cruzadas
 striature trasversali

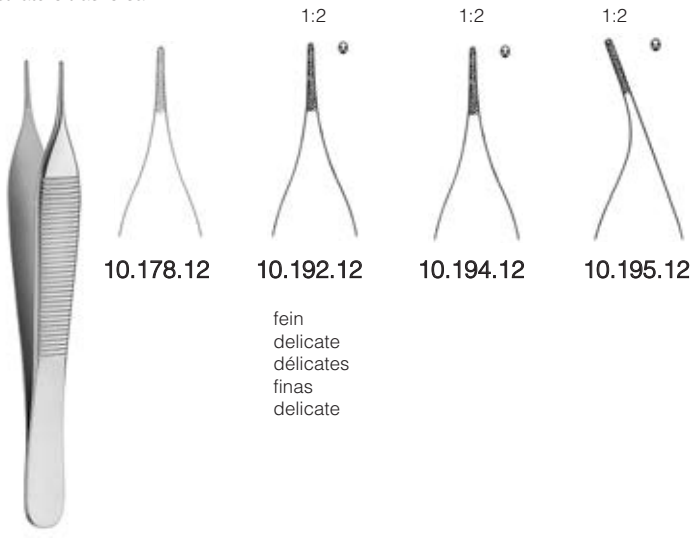

10.178.12

10.192.12

10.194.12

10.195.12

fein
 delicate
 délicates
 finas
 delicate

ADSON
 12 cm/4¾"

1:2

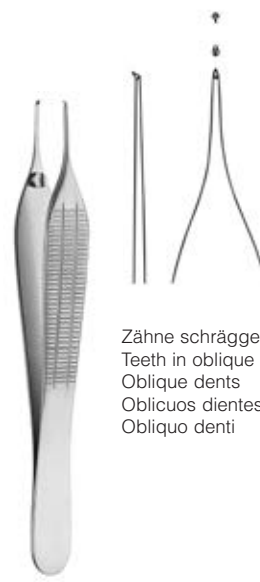

Zähne schräggestellt
 Teeth in oblique position
 Oblique dents
 Obliquos dentes
 Obliquo denti

ADSON-BIEMER
 10.187.12
 12 cm/4¾"

kreuzgerieft
 cross serrated
 striure en croix
 estrias cruzadas
 striature trasversali

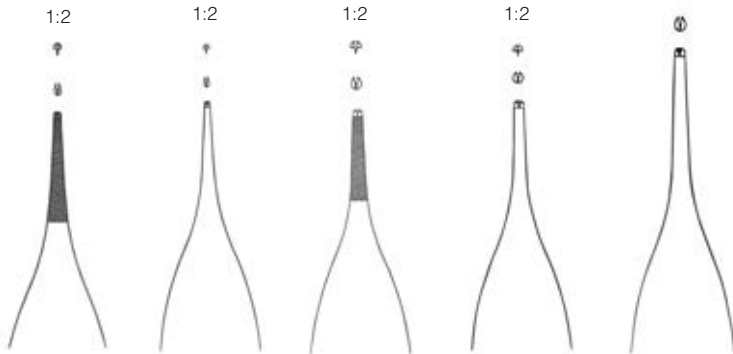

10.191.12
 12 cm/4¾"

10.196.12
 12 cm/4¾"

10.197.12
 12 cm/4¾"

10.198.12
 12 cm/4¾"

10.198.15
 15 cm/6"

fein
 delicate
 délicates
 finas
 delicate

ADSON

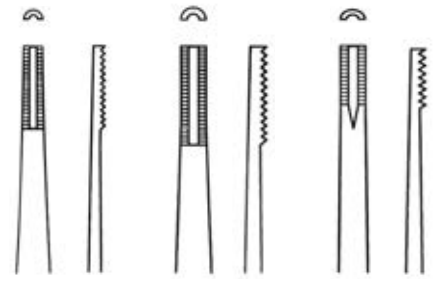

10.189.16
 15 cm/6"

10.189.20
 20 cm/8"

10.189.25
 25 cm/10"

BROWN

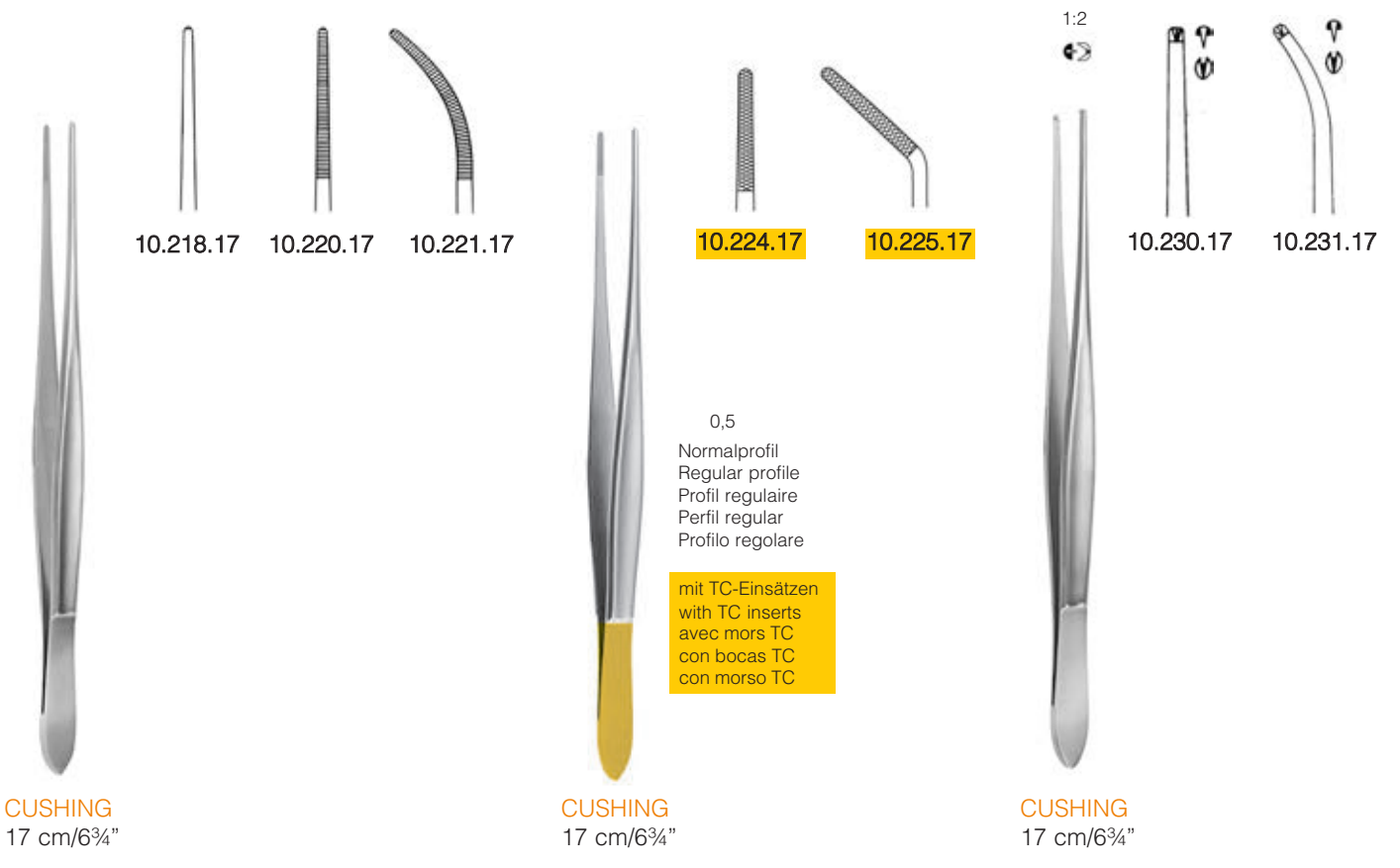
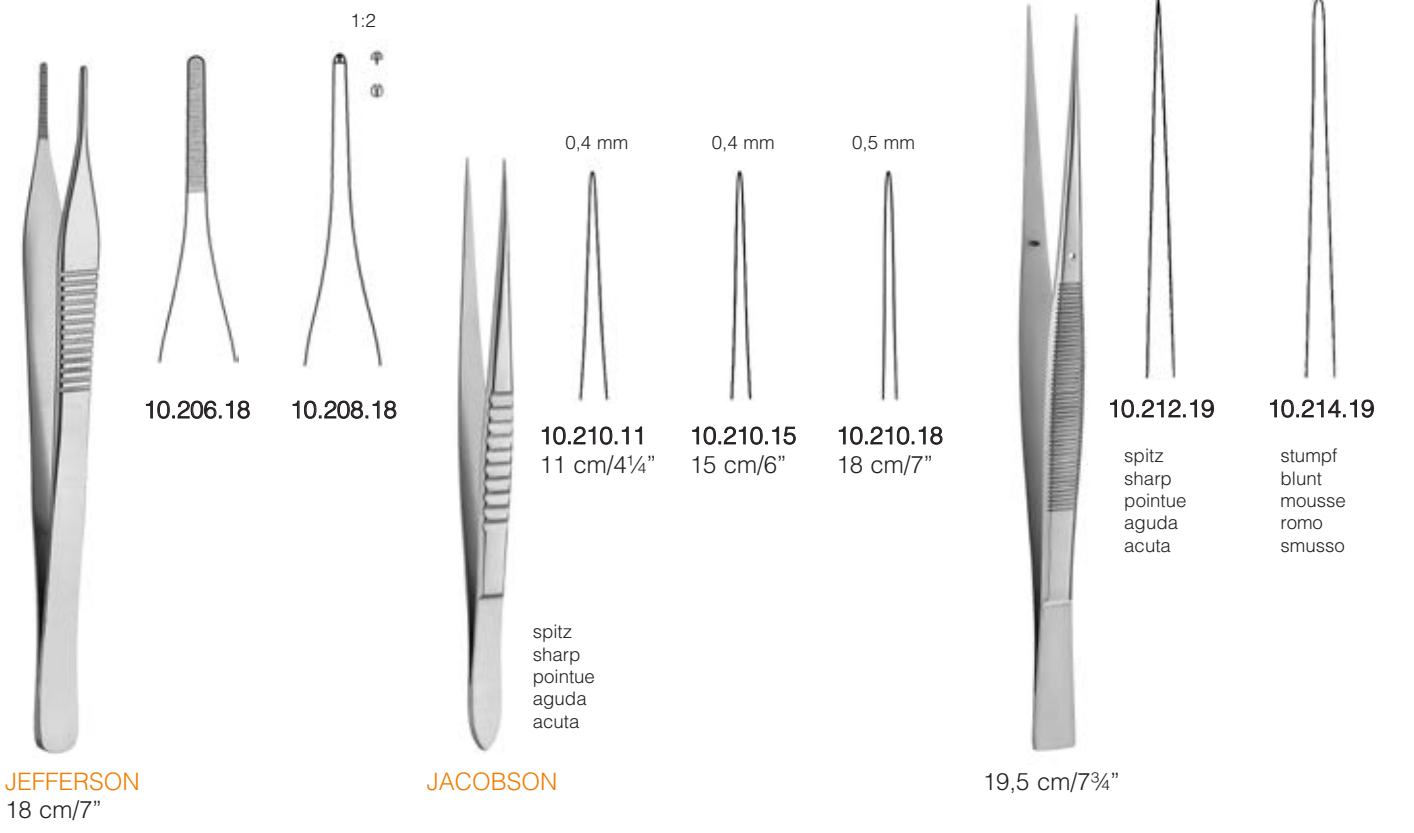

Pinzetten

Thumb and tissue forceps
 Pincès à dissection
 Pinzas de disección
 Pinze per dissezione

mit TC-Einsätzen
 with TC inserts
 avec mors TC
 con bocas TC
 con morso TC



0,5
 Normalprofil
 Regular profile
 Profil regulaire
 Perfil regular
 Profilo regolare

mit Schaberende
 with dissector end
 à rugine
 con rascador
 con estremità a forma di raschino

CUSHING-TAYLOR
10.226.18
 18,5 cm/7¼"



GRUENWALD
10.228.18
 18,5 cm/7¼"



0,4
 Miniprofil
 Mini profile
 Profil mini
 Perfil mini
 Profilo mini

mit TC-Einsätzen
 with TC inserts
 avec mors TC
 con bocas TC
 con morso TC

McINDOE
10.257.15
 15 cm/6"



McINDOE
10.259.15
 15 cm/6"

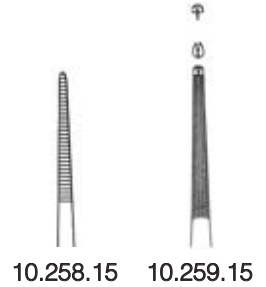

fein
 delicate
 délicates
 finas
 delicate

kreuzgerieft
 cross serrated
 striure en croix
 estrias cruzadas
 striature trasversali



SEMKEN

10.260.12
 12,5 cm/5"



10.260.15
 15 cm/6"



10.261.12
 12,5 cm/5"



10.261.15
 15 cm/6"



SEMKEN

fein
 delicate
 délicates
 finas
 delicate

10.268.12
 12,5 cm/5"



10.268.14
 14,5 cm/5¾"



Pinzetten

Thumb and tissue forceps
Pincès à dissection
Pinzas de disección
Pinze per dissezione



SEMKEN

1:2



10.270.12
12,5 cm/5"

2:3



10.270.13
12,5 cm/5"

1:2



10.271.12
12,5 cm/5"

1:2



10.270.15
15 cm/6"

1:2



10.271.15
15 cm/6"



GILLIES
10.272.15
15,5 cm/6"

1:2



kreuzgerieft
cross serrated
striure en croix
estrias cruzadas
striature trasversali



WAUGH

1:2



10.282.15
15 cm/6"

1:2



10.282.18
18 cm/7"

1:2



10.282.20
20 cm/8"

1:2



10.282.25
25 cm/10"

1:2



10.282.30
30,5 cm/12"

schmal
narrow
étroite
estrecha
stretta

1:2



0,4
Miniprofil
Mini profile
Profil mini
Perfil mini
Profilo mini



GILLIES
10.272.16
15,5 cm/6"

mit TC-Einsätzen
with TC inserts
avec mors TC
con bocas TC
con morso TC

Pinzetten

Thumb and tissue forceps

Pinces à dissection

Pinzas de disección

Pinze per dissezione



TAYLOR
10.274.17
17 cm/6¾"



TAYLOR
10.276.17
17,5 cm/7"



TAYLOR
10.277.17
18,5 cm/7¼"

mit Schaberende
with dissector end
à rugine
con rascador
con estremità a forma di raschino



TAYLOR
10.279.17
17 cm/6¾"

mit Schaberende
with dissector end
à rugine
con rascador
con estremità a forma di raschino



TAYLOR
10.278.17
17 cm/6¾"

mit Schaberende
with dissector end
à rugine
con rascador
con estremità a forma di raschino



TAYLOR
10.280.17
17 cm/6¾"

mit Schaberende
with dissector end
à rugine
con rascador
con estremità a forma di raschino

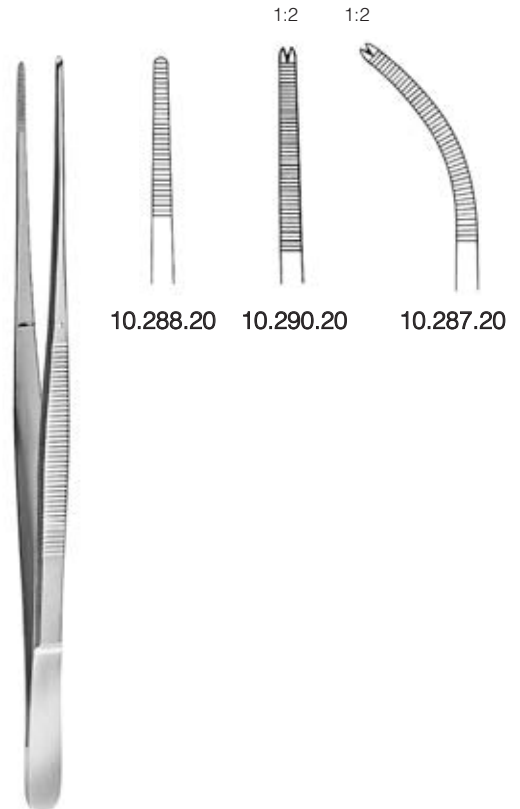

BROPHY
20 cm/8"

10.288.20 10.290.20 10.287.20

Pinzetten

Thumb and tissue forceps
Pincers à dissection
Pinzas de disección
Pinze per dissezione



10.302.18
18 cm/7"



10.303.18
18 cm/7"



10.302.23
23 cm/9"



fein
delicate
délicates
finas
delicate



10.310.18
18 cm/7"



10.311.18
18 cm/7"



10.310.23
23 cm/9"



mit TC-Einsätzen
with TC inserts
avec mors TC
con bocas TC
con morso TC

0,3
Mikroprofil
Micro profile
Profil micro
Perfil micro
Profilo micro



0,4
Miniprofil
Mini profile
Profil mini
Perfil mini
Profilo mini

GERALD
10.304.17
17,5 cm/7"

GERALD
10.306.17
17,5 cm/7"



DUEHRSSEN
20 cm/8"



10.314.20



10.298.20



WANGENSTEEN
15 cm/6" **10.324.15**
23 cm/9" **10.324.23**



WANGENSTEEN
15 cm/6" **10.326.15**
23 cm/9" **10.326.23**
25 cm/10" **10.326.25**

0,5
Normalprofil
Regular profile
Profil regulare
Perfil regular
Profilo regolare

mit TC-Einsätzen
with TC inserts
avec mors TC
con bocas TC
con morso TC

Uhrmacher-Pinzetten

Jeweller forceps
Pinces d'horloger
Pinzas de relojero
Pinze da orologiaio



10.332.01
12 cm/4¾"
Fig. 1



10.330.12
12 cm/4¾"
Fig. 3



10.330.31
11 cm/4¼"
Fig. 3 C

fein
delicate
délicates
finas
delicate



10.332.04
11 cm/4¼"
Fig. 4



10.332.05
11 cm/4¼"
Fig. 5



10.332.45
11 cm/4¼"
Fig. 5

0,3 mm
45°



10.333.05
11 cm/4¼"
Fig. 5a



10.332.15
11 cm/4¼"
Fig. 6



10.331.12
12 cm/4¾"
Fig. 7



10.333.11
11,5 cm/4½"

1:2



14 cm/5½"

0,2 mm



10.818.14

0,3 mm



10.820.14



GRAEFE
42.810.10
10 cm/4"



GRAEFE
42.811.10
10 cm/4"



GRAEFE
42.813.10
10 cm/4"

Pinzetten

Thumb and tissue forceps

Pinces à dissection

Pinzas de disección

Pinze per dissezione

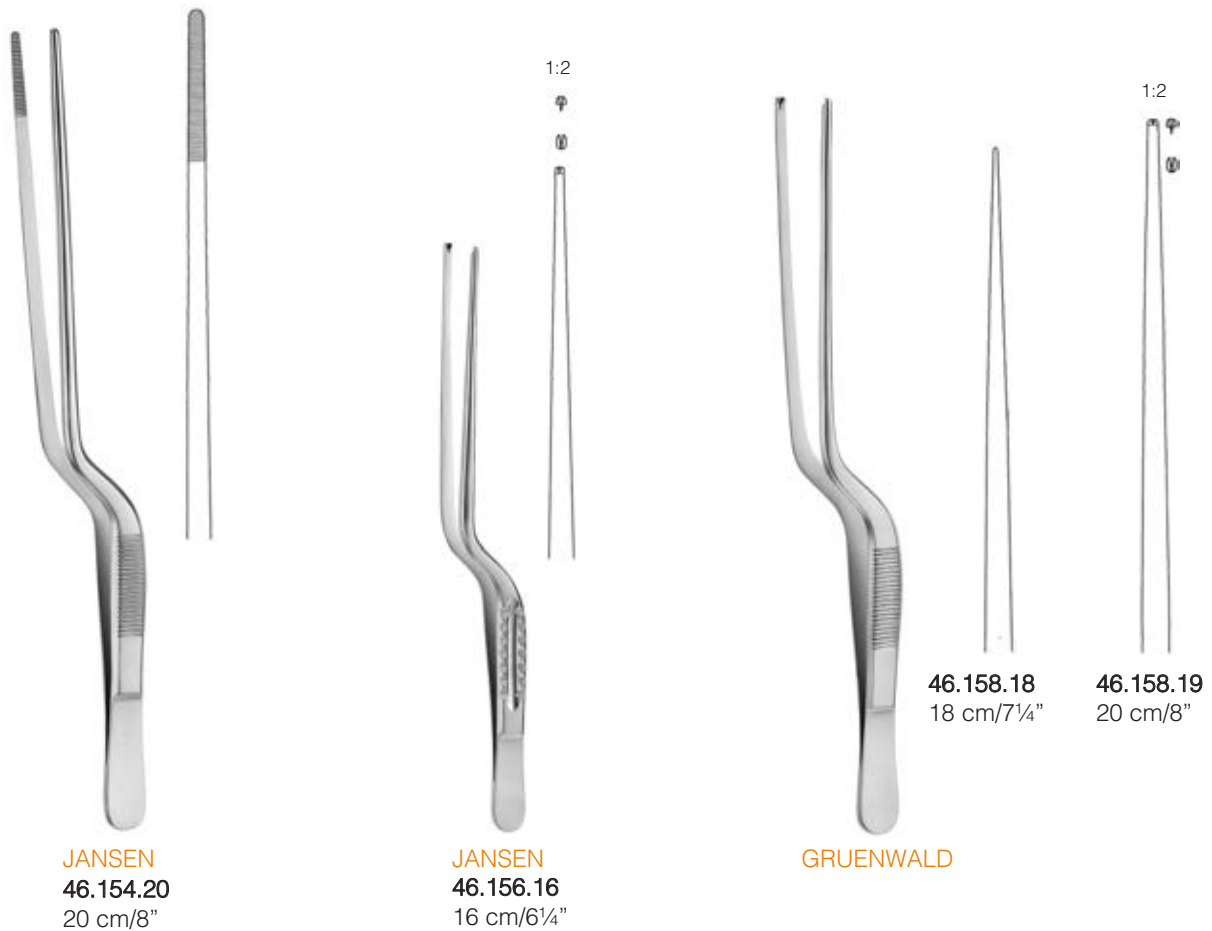

06



◆ **MIKRO-PINZETTEN**

MICRO THUMB & TISSUE FORCEPS

MICRO PINCES

MICRO PINZAS

MICRO PINZE

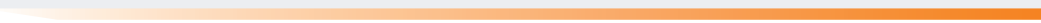

Mikro-Knüpfpinzetten

Micro suture tying forceps
 Micro pinces pour nouer les fils
 Micro pinzas para enlazar
 Micro pinze per annodare fili

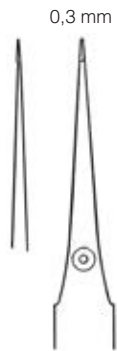

11.102.12
12 cm/4¾"



11.103.12
12 cm/4¾"



11.104.15
15 cm/6"



11.105.15
15 cm/6"

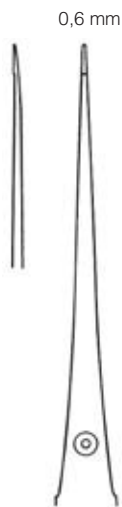

11.108.18
18 cm/7"



11.109.18
18 cm/7"

0,6 mm



11.108.23
23 cm/9"

Leichtmetall Rundgriffe, gut ausbalanciert
 Light-weight round handles, well-balanced
 Manches ronds en métal léger, bien équilibrés
 Mangos redondos de metal ligero, bien equilibrados
 Manici rotondi metallo leggero, equilibrio perfetto



11.110.15
15 cm/6"



11.111.15
15 cm/6"



11.110.18
18 cm/7"



11.111.18
18 cm/7"



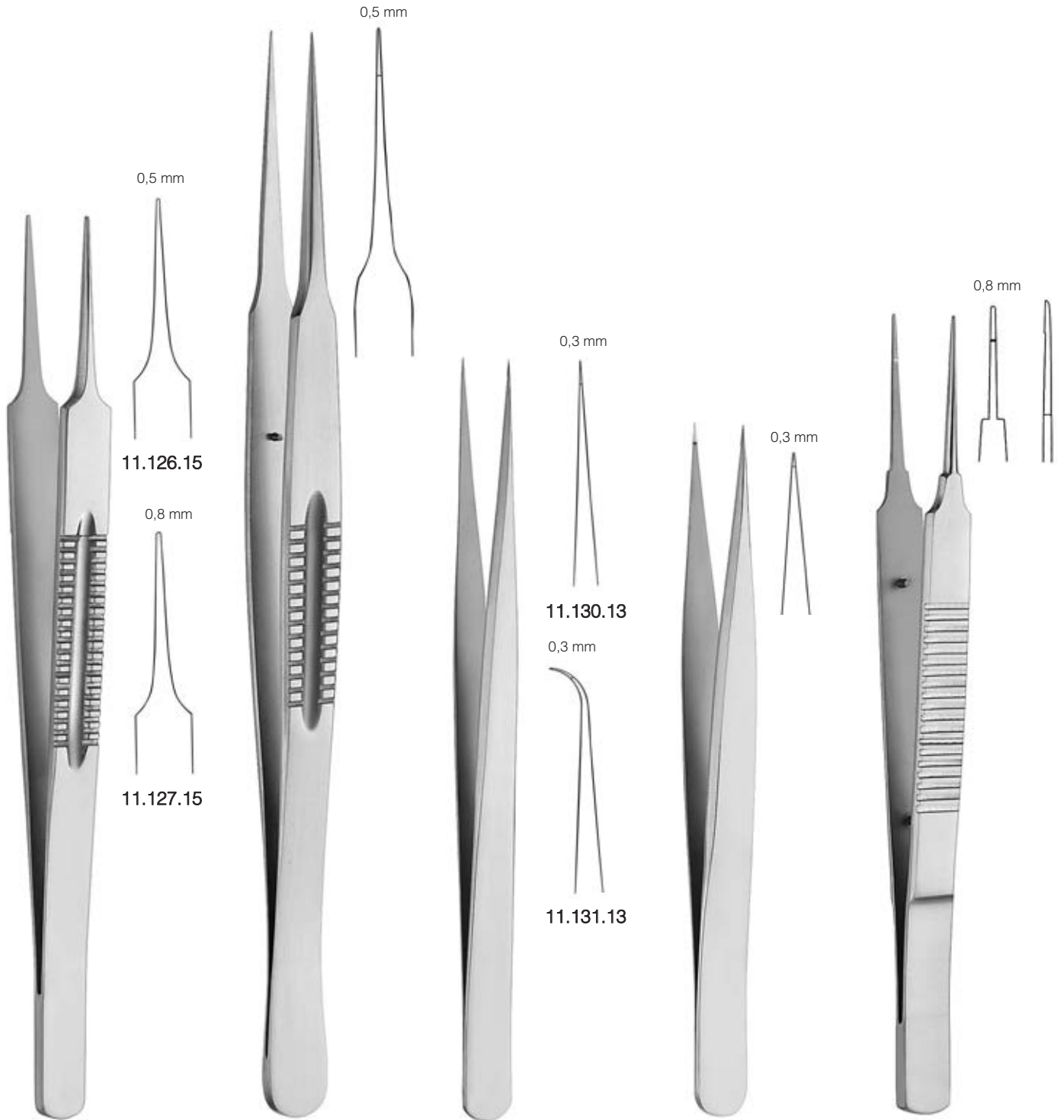

LAZAR
 15,5 cm/6"

11.128.18
 18,5 cm/7¼"

VISE
 13,5 cm/5¼"

11.132.12
 12 cm/4¾"

AUSTIN
11.134.14
 14 cm/5½"

Mikro-Pinzetten

Micro forceps
Micro pinces
Micro pinzas
Micro pinze

Leichtmetall Rundgriffe, gut ausbalanciert
Light-weight round handles, well-balanced
Manches ronds en métal léger, bien équilibrés
Mangos redondos de metal ligero, bien equilibrados
Manici rotondi metallo leggero, equilibrio perfetto



1:2
11.138.18 11.136.18

0,2 mm 0,3 mm 0,2 mm 0,3 mm

11.218.15 15 cm/6" 11.220.15 15 cm/6" 11.219.15 15 cm/6" 11.221.15 15 cm/6"

spitz sharp pointue aguda acuta
stumpf blunt mousse roma smussa
spitz sharp pointue aguda acuta
stumpf blunt mousse roma smussa

0,2 mm 0,3 mm 0,2 mm 0,3 mm

11.218.18 18 cm/7" 11.220.18 18 cm/7" 11.219.18 18 cm/7" 11.221.18 18 cm/7"

spitz sharp pointue aguda acuta
stumpf blunt mousse roma smussa
spitz sharp pointue aguda acuta
stumpf blunt mousse roma smussa

GOMEL
18 cm/7"

- ergonomischer Griff
- ansprechendes Design
- sichere und feinfühlig Handhabung
- leichtes Reinigen
- keine schmutzanfälligen Riefelungen
- ergonomic handle
- sophisticated design
- safe and fine feeling in hand, well-balanced
- easy to clean
- no dirt catching knurlings
- poignée ergonomique
- aspect attrayant
- une manipulation délicate et en sécurité
- la précision du geste opératoire
- un nettoyage facile
- striure pas sensible à la saleté

- mango ergonómico
- diseño llamativo
- manipulación segura y delicada
- limpieza fácil
- las estriadas no son susceptible a la suciedad
- manico ergonomico
- design appariscente
- maneggio sicuro e delicato
- purificazione facile
- non incline de la sporcizia



TOLEDO

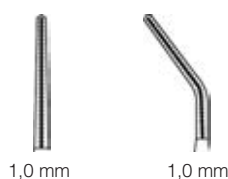

ATRAUMA



DE BAKEY

18 cm/7"	11.230.18	11.231.18
21 cm/8¼"	11.230.21	11.231.21

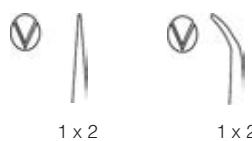

18 cm/7"	11.232.18	11.233.18
21 cm/8¼"	11.232.21	11.233.21

diamantiertes Maul
 diamond coated jaws
 mors diamanté
 boca diamantada
 morso diamantato



18 cm/7"	11.234.18	11.235.18	11.244.18	11.245.18
21 cm/8¼"	11.234.21	11.235.21	11.244.21	11.245.21

diamantiertes Maul
 diamond coated jaws
 mors diamanté
 boca diamantada
 morso diamantato

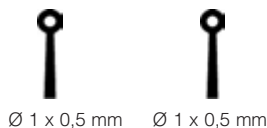

18 cm/7"	11.238.18	11.248.18
21 cm/8¼"	11.238.21	11.248.21

ATRAUMA



DE BAKEY



DE BAKEY

1,0 mm

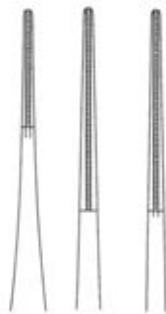

1,5 mm

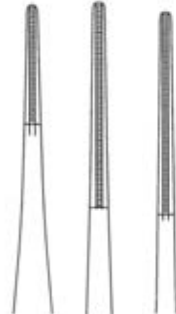

1,8 mm

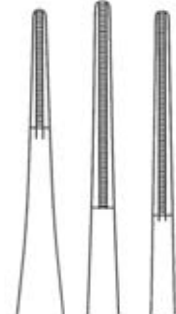

15 cm/6"	11.290.15	11.300.16	11.302.16
20 cm/8"	11.290.20	11.300.20	11.302.20
24 cm/9½"	11.290.24	11.300.24	11.302.24

Titan
 Titanium
 Titane
 Titanio
 Titanio

2,0 mm

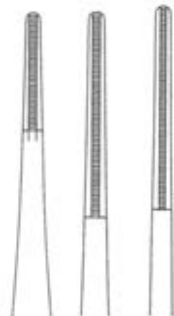

2,8 mm

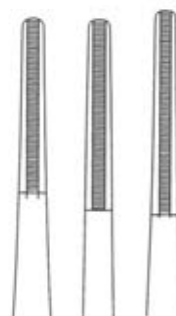

15 cm/6"	11.292.15	11.298.15
20 cm/8"	11.292.20	11.298.20
24 cm/9½"	11.292.24	11.298.24

Titan
 Titanium
 Titane
 Titanio
 Titanio

ATRAUMA



DE BAKEY



DE BAKEY

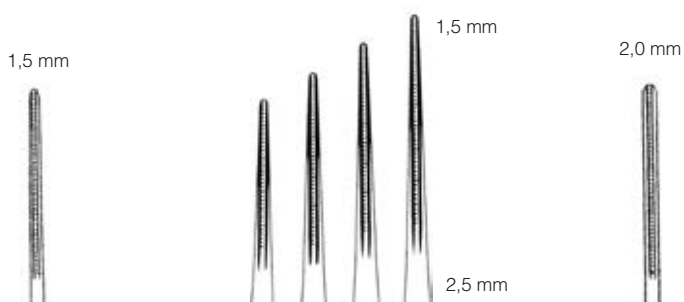

15 cm/6"		11.324.15
16 cm/6¼"	11.306.16	
19,5 cm/7¾"	11.322.20	11.324.20
20 cm/8"	11.306.20	
24 cm/9½"	11.322.24	11.306.24
30 cm/12"	11.322.30	11.306.30

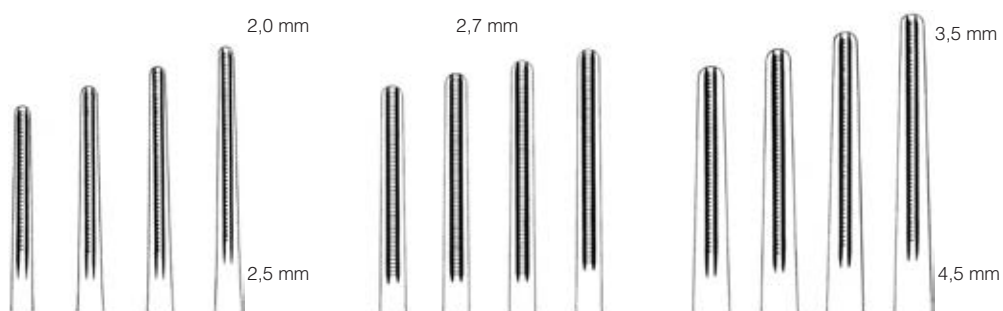

16 cm/6¼"	11.308.16	11.304.16	11.310.16
20 cm/8"	11.308.20	11.304.20	11.310.20
24 cm/9½"	11.308.24	11.304.24	11.310.24
30 cm/12"	11.308.30	11.304.30	11.310.30
35 cm/14"			11.310.35
40 cm/16"			11.310.40

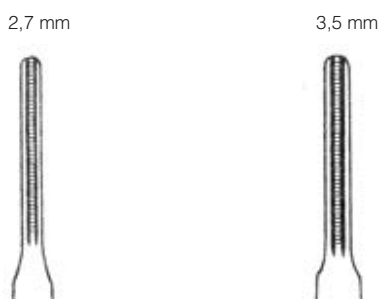

15 cm/6"	11.332.15	11.334.15
19,5 cm/7¾"	11.332.20	11.334.20
24 cm/9½"	11.332.24	11.334.24
30 cm/12"	11.332.30	11.334.30
35 cm/14"		11.334.35

ATRAUMA



DE BAKEY



DE BAKEY

2,0 mm



2,7 mm



2,5 mm

16 cm/6¼"	11.309.16
20 cm/8"	11.309.20
24 cm/9½"	11.309.24
30 cm/12"	11.309.30

15 cm/6"	11.333.15
19,5 cm/7¾"	11.333.20
24 cm/9½"	11.333.24
30 cm/12"	11.333.30

ATRAUMA



COOLEY

2,0 mm



ATRAUMA



DE BAKEY

1,0 mm



ATRAUMA



DE BAKEY

1,5 mm



COOLEY

16 cm/6¼"	11.314.16
20 cm/8"	11.314.20
24 cm/9½"	11.314.24

DE BAKEY

15 cm/6"	11.315.15
19,5 cm/7¾"	11.315.19
24 cm/9½"	11.315.24

DE BAKEY-DIETRICH

15 cm/6"	11.316.16
19,5 cm/7¾"	11.316.20
24 cm/9½"	11.316.24

ATRAUMA



DE BAKEY



DE BAKEY-ADSON
 12 cm/4¾" **11.318.12**
 15 cm/6" **11.318.15**

1,2 mm

ATRAUMA



DE BAKEY



DE BAKEY-GERALD
 18 cm/7" **11.430.18**

ATRAUMA



DE BAKEY

2,0 mm



DE BAKEY-WHEELER
 24 cm/9½" **11.456.24**

ATRAUMA



COOLEY



11.462.15
 15 cm/6"
 4 mm

11.462.24
 24 cm/9½"
 8 mm



GLASSMAN

Atraumatische Pinzetten
 Atraumatic tissue forceps
 Pincas atraumatiques
 Pinzas atraumáticas
 Pinze atraumatiche

ATRAUMA



DE BAKEY

mit TC-Einsätzen
 with TC inserts
 avec mors TC
 con bocas TC
 con morso TC



DE BAKEY

1,5 mm

2,0 mm

2,7 mm

3,5 mm

6 x 12

6 x 12

6 x 12

6 x 12



15 cm/6"	11.404.15	11.412.15	11.414.15	11.416.15
19,5 cm/7¾"	11.404.19	11.412.19	11.414.19	11.416.19
24 cm/9½"	11.404.24	11.412.24	11.414.24	11.416.24

1,5 mm

2,0 mm

2,7 mm

3,5 mm

2 x 4

2 x 4





2 x 4

2 x 4





15 cm/6"	11.402.15	11.422.15	11.424.15	11.426.15
19,5 cm/7¾"	11.402.20	11.422.19	11.424.19	11.426.19
24 cm/9½"	11.402.24	11.422.24	11.424.24	11.426.24



1,2 mm	1,5 mm	1,5 mm	1,5 mm
			
11.428.15 15 cm/6"	11.428.20 20 cm/8"	11.428.24 24 cm/9½"	11.428.30 30 cm/12"

extrem leicht
 extremely light
 extrêmement légère
 especialmente ligera
 estremamente leggera

0,3 mm	0,6 mm	0,6 mm
		
11.504.01	11.504.02	11.504.03



18,5 cm/7¼"

Ligaturpinzetten, Mikro-Pinzetten

Ligature forceps, micro forceps
 Pincès à ligatures, micro pincès
 Pinzas para ligaduras, micro pinzas
 Pinze per legatura, micro pinze

Ligaturpinzetten
 Ligature forceps
 Pincès à ligature
 Pinzas para ligaduras
 Pinze per legatura



11.505.19
 18,5 cm/7¼"



YASARGIL

0,6 mm

0,9 mm

1:2



16 cm/6¼"	11.506.16	11.509.16	
18 cm/7"	11.506.18	11.509.18	11.510.18
20 cm/8"	11.506.20	11.509.20	
22 cm/8¾"	11.506.22	11.509.22	
24 cm/9½"	11.506.24	11.509.24	

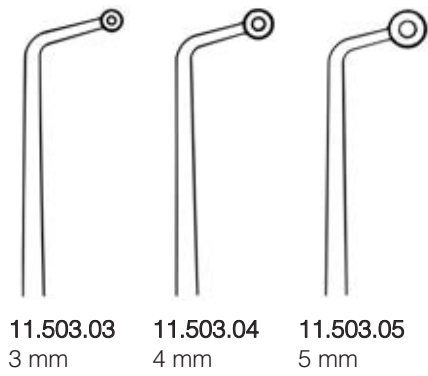
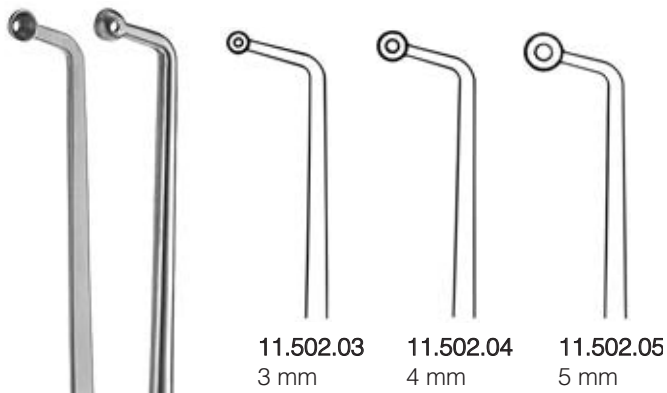

Maul löffelförmig
 Jaw spoon-shaped
 Mors en forme de cuillère
 Boca en forma de cuchara
 Morso a forma di cucchiaio

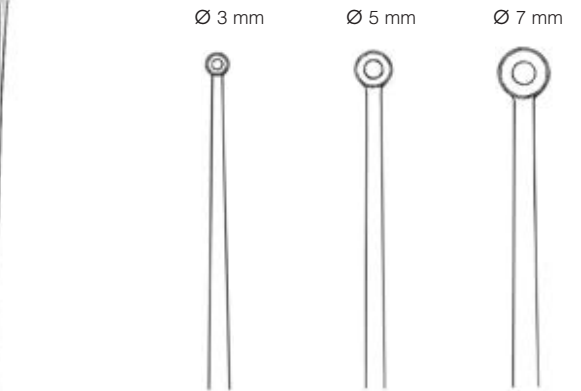

22 cm/8 ³ / ₄ "	11.513.22	11.515.22	
24 cm/9 ¹ / ₂ "	11.513.24	11.515.24	11.517.24

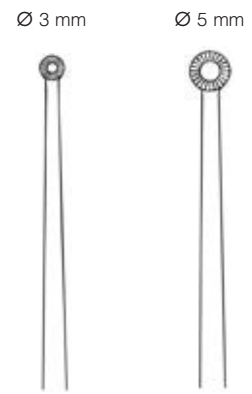

11.521.22
22 cm/8³/₄"

11.523.22
22 cm/8³/₄"

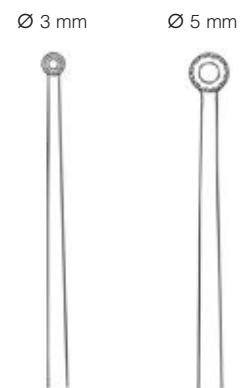

HEIFETZ
11.522.22
22 cm/8³/₄"

HEIFETZ
11.525.22
22 cm/8³/₄"

SAMII
23 cm/9"

YASARGIL

Tumorfasspinzetten

Tumor grasping forceps
Pincés pour saisir des tumeurs
Pinzas para agarrar tumores
Pinze da presa per tumori



HEIFETZ
22 cm/8¾"



HUNT
11.529.20
20 cm/8"



Mikrochirurgie-Pinzetten

Microsurgery forceps
Pincas à microchirurgie
Pinzas para microcirugía
Pinze per microchirurgia

diamantiertes Maul
diamond coated jaws
mors diamanté
boca diamantada
morso diamantato

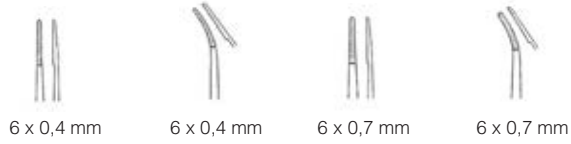

15 cm/6"	10.564.15	10.565.15	10.566.15	10.567.15
18 cm/7"	10.564.18	10.565.18	10.566.18	10.567.18
21 cm/8¼"			10.566.21	10.567.21
23 cm/9"			10.566.23	10.567.23

15 cm/6"	11.578.15	11.579.15	11.580.15	11.581.15
18 cm/7"	11.578.18	11.579.18	11.580.18	11.581.18
21 cm/8¼"			11.580.21	11.581.21

Titan
Titanium
Titane
Titanio
Titanio

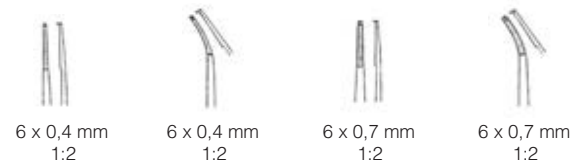

15 cm/6"	10.568.15	10.569.15	10.570.15	10.571.15
18 cm/7"	10.568.18	10.569.18	10.570.18	10.571.18
21 cm/8¼"			10.570.21	10.571.21
23 cm/9"			10.570.23	10.571.23

15 cm/6"	11.582.15	11.583.15	11.584.15	11.585.15
18 cm/7"	11.582.18	11.583.18	11.584.18	11.585.18
21 cm/8¼"			11.584.21	11.585.21

Titan
Titanium
Titane
Titanio
Titanio



ATRAUMA



DE BAKEY

15 cm/6"	10.574.15	10.576.15	10.589.15
18 cm/7"	10.574.18	10.576.18	10.589.18
21 cm/8¼"	10.574.21	10.576.21	10.589.21
23 cm/9"	10.574.23	10.576.23	

15 cm/6"	11.586.15	11.588.15	11.590.15
18 cm/7"	11.586.18	11.588.18	11.590.18
21 cm/8¼"	11.586.21	11.588.21	11.590.21

Titan
Titanium
Titane
Titanio
Titanio

07

◆ ARTERIENKLEMMEN

HEMOSTATIC FORCEPS

PINCES HÉMOSTATIQUES

PINZAS HEMOSTÁTICAS

PINZE EMOSTATICHE

Atraumatische Bulldogklemmen

Atraumatic Bulldog clamps
Clamps Bulldog atraumatiques
Clamps Bulldog atraumáticas
Pinze Bulldog atraumatiche

ATRAUMA



DE BAKEY



DE BAKEY



SATINSKY
12.059.07
7 cm/2¾"



DE BAKEY
12.061.09
9 cm/3½"



DE BAKEY
SATINSKY
12.063.10
10 cm/4"



GLOVER
12.065.06
5,5 cm/2¼", 35 mm



GLOVER
12.070.35
3,5 cm/1½"



GLOVER
12.071.35
3,5 cm/1½"



GLOVER
12.070.45
4,5 cm/1¾"



GLOVER
12.071.45
4,5 cm/1¾"



GLOVER
12.070.50
5 cm/2"



GLOVER
12.071.50
5 cm/2"

ATRAUMA



DE BAKEY

**DE BAKEY-
DIETHRICH**

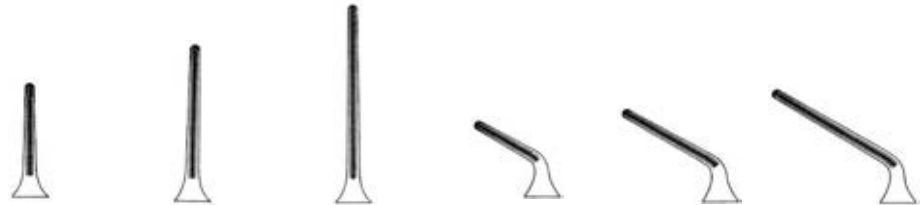

	12.078.10	12.078.14	12.078.20	12.079.10	12.079.14	12.079.20
Länge Length Longueur Longitud Lunghezza Maullänge Jaw length Longueur des mors Longitud de la boca Lunghezza del morso	5 cm/2"	5 cm/2"	6 cm/2½"	5 cm/2"	5 cm/2"	6 cm/2½"
Gewicht Weight Poids Peso	3 gr.	3 gr.	3 gr.	3 gr.	3 gr.	3 gr.
Schließdruck Closing pressure Pression d'occlusion Presión de oclusión Pression di occlusiva	180 gr.	180 gr.	180 gr.	180 gr.	180 gr.	180 gr.

DIETHRICH

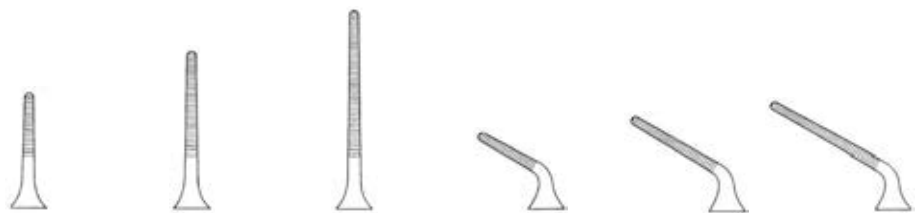

	12.082.08	12.082.12	12.082.16	12.083.08	12.083.12	12.083.16
Länge Length Longueur Longitud Lunghezza Maullänge Jaw length Longueur des mors Longitud de la boca Lunghezza del morso	5 cm/2"	5 cm/2"	6 cm/2½"	5 cm/2"	5 cm/2"	6 cm/2½"
Gewicht Weight Poids Peso	3 gr.	3 gr.	3 gr.	3 gr.	3 gr.	3 gr.
Schließdruck Closing pressure Pression d'occlusion Presión de oclusión Pression di occlusiva	50 gr.	50 gr.	50 gr.	50 gr.	50 gr.	50 gr.



Atraumatische Bulldogklemmen

Atraumatic Bulldog clamps
Clamps Bulldog atraumatiques
Clamps Bulldog atraumáticas
Pinze Bulldog atraumatiche

ATRAUMA



DE BAKEY



DE BAKEY



12.092.07
7,5 cm/3"



12.092.08
8,5 cm/3½"



12.092.10
10,5 cm/4¼"



12.092.12
12 cm/4¾"



12.093.07
7 cm/2¾"



12.093.08
8 cm/3¼"



12.093.10
10 cm/4"



12.093.12
11,5 cm/4¾"

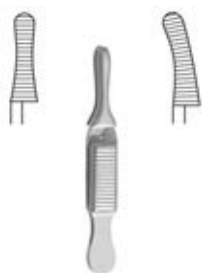

DIEFFENBACH

3,5 cm/1½"	12.102.04	12.103.04
5 cm/2"	12.102.05	12.103.05



DE BAKEY-HESS

Maullänge
 Jaw length
 Longueur des mors
 Longitud de la boca
 Lunghezza del morso

12.112.20	12.112.30
20 mm	30 mm



DIEFFENBACH

5,8 cm/2¼"	12.104.06	12.105.06
------------	-----------	-----------



JOHN-HOPKINS

5 cm/2"	12.110.50	12.111.50
5,5 cm/2¼"	12.110.55	12.111.55
6,5 cm/2½"	12.110.65	12.111.65
7 cm/2¾"	12.110.70	12.111.70
7,5 cm/3"	12.110.75	12.111.75
9 cm/3½"	12.110.90	12.111.90



Anlege- und Entfernungszange für Bulldogklemmen
 Applying and removing forceps for Bulldog clamps
 Pince pour poser et retirer les clamps Bulldog
 Pinza para poner y quitar clamps Bulldog
 Pinza per applicare e rimuovere clamps



12.091.23
 23 cm/8¼"

Atraumatische Bulldogklemmen

Atraumatic Bulldog clamps
Clamps Bulldog atraumatiques
Clamps Bulldog atraumáticas
Pinze Bulldog atraumatiche



schwache Schließkraft, für Venen
light closing pressure, for veins
force de fermeture faible, pour veines
fuerza de cierre débil, para venas
forza di chiusura debole, per vene

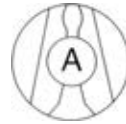

starke Schließkraft, für Arterien
strong closing pressure, for arteries
force de fermeture forte, pour artères
fuerza de cierre fuerte, para arterias
forza di chiusura forte, per arterie

	3 cm	3,5 cm	4 cm	5 cm	
Vena	12.132.30	12.132.35	12.132.40	12.132.50	Titan Titanium Titane Titanio
Arteria	12.142.30	12.142.35	12.142.40	12.142.50	



	3 cm	3,5 cm	4 cm	5 cm	
Vena	12.133.30	12.133.35	12.133.40	12.133.50	Titan Titanium Titane Titanio
Arteria	12.143.30	12.143.35	12.143.40	12.143.50	

	3 cm	3,5 cm	4 cm	5 cm	
Vena	12.135.30	12.135.35	12.135.40	12.135.50	Titan Titanium Titane Titanio
Arteria	12.145.30	12.145.35	12.145.40	12.145.50	



TERRIER
 12.206.08
 8,5 cm/3¼"



CARREL
 12.208.08
 8,5 cm/3¼"



HARTMANN (Baby-Mosquito)
 9 cm/3½"

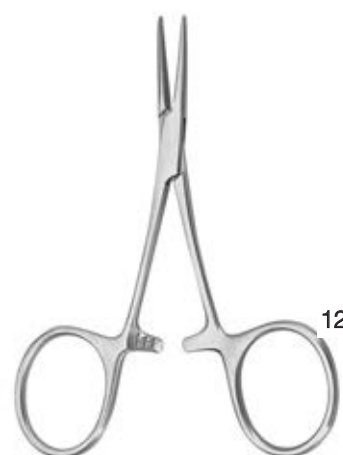
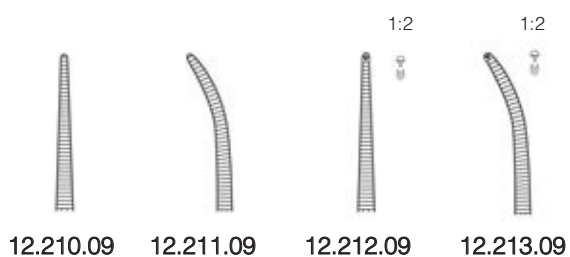

HARTMANN
 10 cm/4"

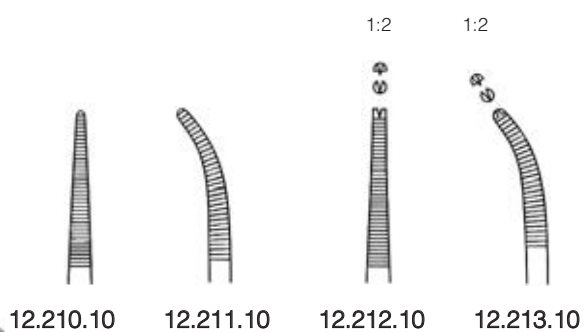

Arterienklemmen

Hemostatic forceps
 Pinces hémostatiques
 Pinzas hemostáticas
 Pinze emostatiche



HALSTED-MOSQUITO

12.220.12
12.224.12
 12,5 cm/5"



12.220.14
 14,5 cm/5¾"



12.221.12
12.225.12
 12,5 cm/5"



12.221.14
 14,5 cm/5½"



1:2



12.230.12
12.234.12
 12,5 cm/5"

1:2



12.230.14
 14,5 cm/5¾"

1:2



12.231.12
12.235.12
 12,5 cm/5"

1:2



12.231.14
 14,5 cm/5½"

Titan
 Titanium
 Titane
 Titanio
 Titanio



HALSTED-MOSQUITO micro

12.222.10
 10 cm/4"



12.222.12
 12 cm/4¾"



12.223.10
 10 cm/4"



12.223.12
 12 cm/4¾"



1:2



12.232.10
 10 cm/4"

1:2



12.232.12
 12 cm/4¾"

1:2



12.233.10
 10 cm/4"

1:2



12.233.12
 12 cm/4¾"

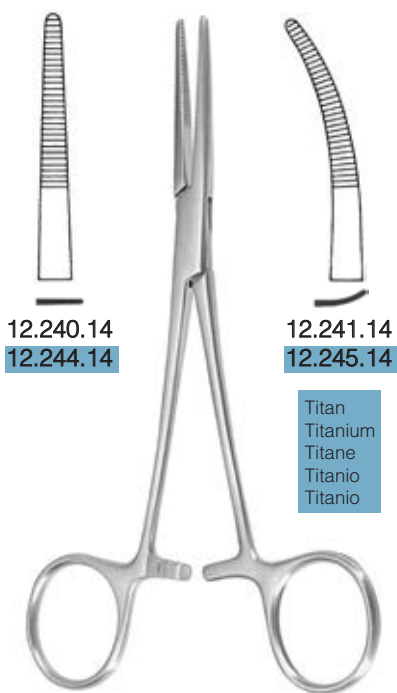

12.240.14
 12.244.14

12.241.14
 12.245.14

Titan
 Titanium
 Titane
 Titanio
 Titanio

KELLY
 14 cm/5½"

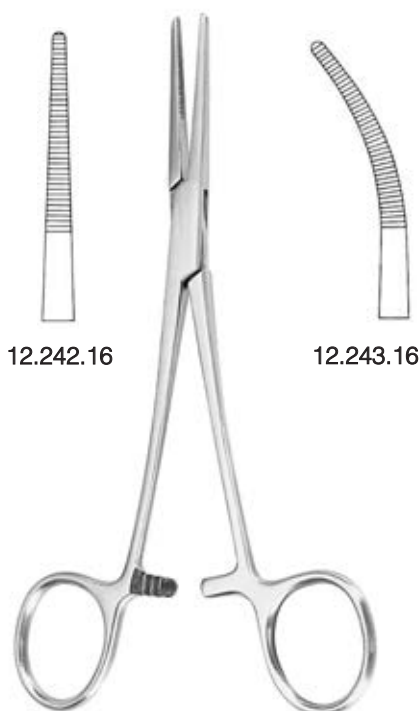

12.242.16

12.243.16

KELLY-RANKIN
 16 cm/6¼"

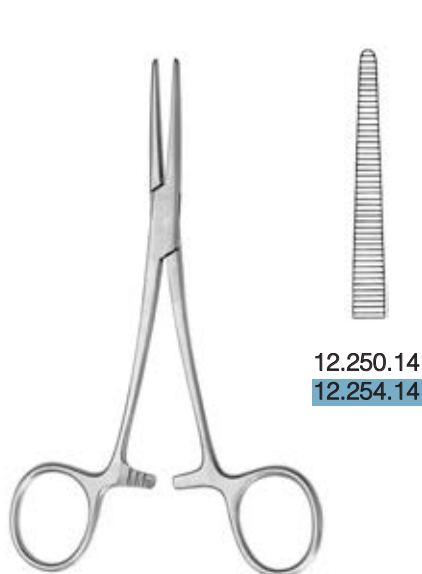

12.250.14
 12.254.14

12.251.14
 12.255.14

Titan
 Titanium
 Titane
 Titanio
 Titanio

CRILE
 14 cm/5½"

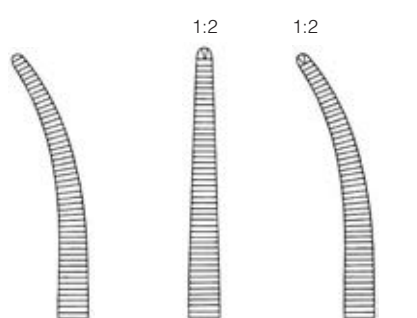

12.260.14

12.261.14

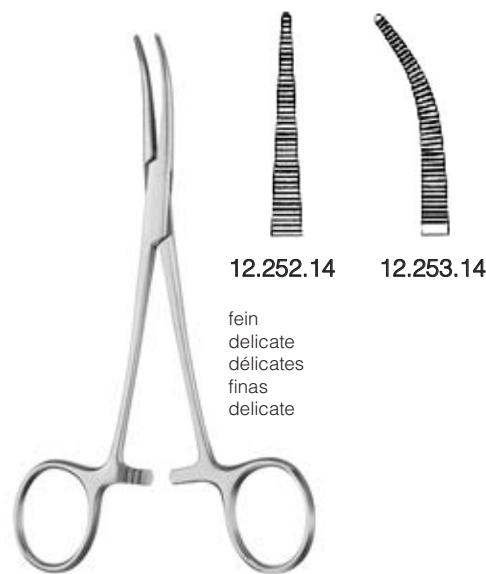

12.252.14

12.253.14

fein
 delicate
 délicates
 finas
 delicate

CRILE
 14 cm/5½"

Arterien- und Kopfhautklemmen

Hemostatic and scalp forceps

Pinces hémostatiques et pour cuir chevelu

Pinzas hemostáticas y para cuero cabelludo

Pinze emostatiche e per cuoio capelluto



CRILE-RANKIN
16 cm/6¼"

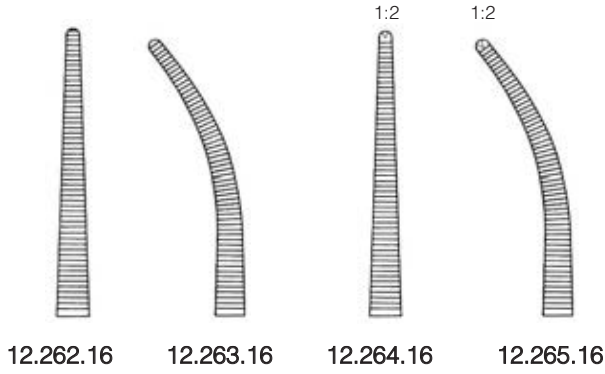

PROVIDENCE-HOSPITAL
14 cm/5½"

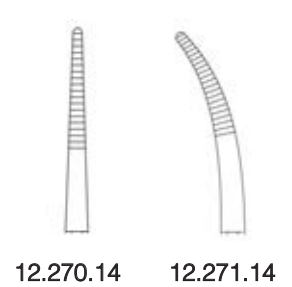

CAIRNS
15 cm/6"



DUNHILL
12.276.13 12.277.13
12,5 cm/5"



CUSHING
14,5 cm/5¾"

fein
delicate
délicates
finas
delicate

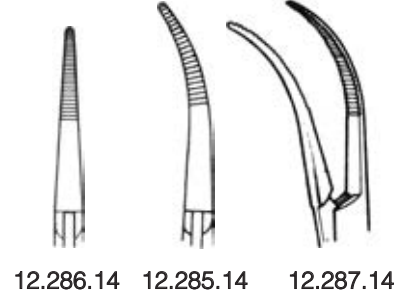

seitlich gebogen
laterally curved
courbée latéralement
curvada lateralmente
curva laterale



MOYNIHAN
 15 cm/6" 12.278.14 12.279.14



MOYNIHAN
 14,5 cm/5¾"

seitlich gebogen
 laterally curved
 courbée latéralement
 curvada lateralmente
 curva laterale



DANDY
 12.344.12
 12 cm/4¾"

seitlich gebogen
 laterally curved
 courbée latéralement
 curvada lateralmente
 curva laterale



12.345.14



12.347.14

seitlich gebogen
 laterally curved
 courbée latéralement
 curvada lateralmente
 curva laterale



LOVELACE
 16 cm/6¼"

12.354.15



12.356.15

1:2

Kopfschwartenzangen

Scalp flap forceps

Pinces pour le cuir chevelu

Pinzas para el cuero cabelludo

Pinze per il cuoio capelluto



seitlich gebogen
laterally curved
courbée latéralement
curvada lateralmente
curva laterale

RAIMONDI

12.346.13

12,5 cm/5"



seitlich gebogen
laterally curved
courbée latéralement
curvada lateralmente
curva laterale

HOEN

12.348.14

13,5 cm/5¼"



MARTEL

12.364.14

14 cm/5½"



WILLET-MARTEL

12.366.19

19 cm/7½"



LERICHE
 15 cm/6"

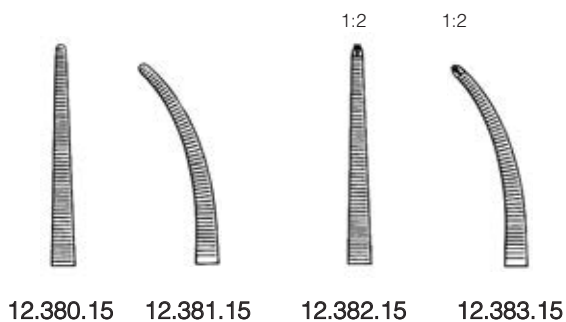

ADSON Baby



JACOBSON
 12,5 cm/5"

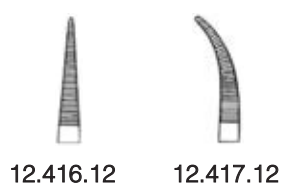

JACOBSON
 18 cm/7"

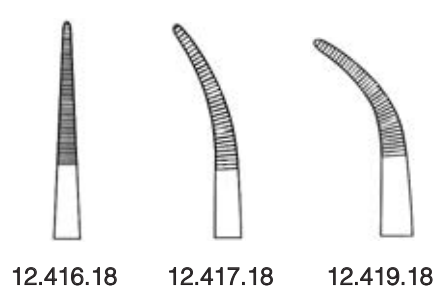

Präparier- und Ligaturklemmen

Dissecting and ligature forceps

Pinces à dissection et à ligatures

Pinzas para disección y ligaduras

Pinze per dissezione e per legature (passafili)



GEMINI



12.431.13
13 cm/5"

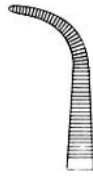

12.431.14
14 cm/5½"



12.431.16
16 cm/6¼"



12.431.18
18 cm/7"

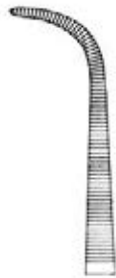

12.431.20
20 cm/8"



12.431.23
23 cm/9"



12.431.25
25 cm/10"



12.431.28
28 cm/11"



GEMINI mini



12.433.18
18 cm/7"



12.433.22
22 cm/8¾"



12.433.25
25 cm/10"



12.433.28
28 cm/11"



12.468.14

Baby MIXTER
 14 cm/5½"



12.469.14



MIXTER Baby
 12.475.14
 14 cm/5½"



MIXTER Baby
 12.475.18
 18 cm/7"



ALLIS

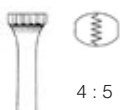

4 : 5

15 cm/6"	64.110.15
19 cm/7½"	64.110.19
25 cm/10"	64.110.25



5 : 6

15 cm/6"	64.120.15
19 cm/7½"	64.120.19
22 cm/8¾"	64.120.22
24 cm/9½"	64.120.24
30 cm/12"	64.120.30



ALLIS Atrauma



64.124.16
 16 cm/6¼"



64.124.20
 20 cm/8"



64.124.25
 25 cm/10"



64.124.30
 30 cm/12"

ATRAUMA



DE BAKEY

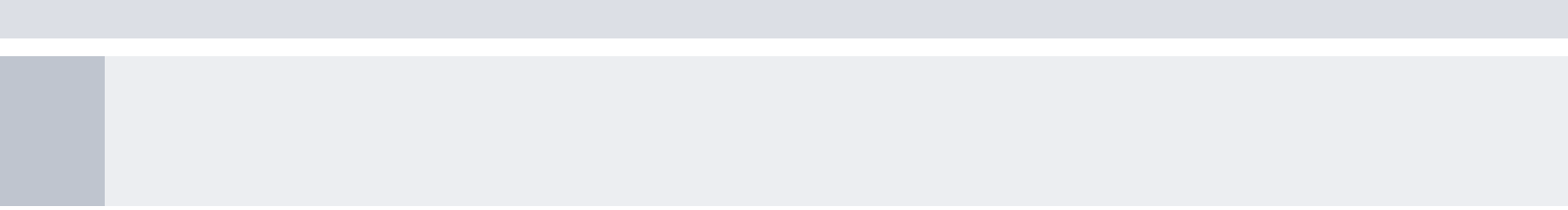

08



◆ **WUNDHAKEN**

RETRACTORS

ÉCARTEURS

SEPARADORES

DIVARICATORI



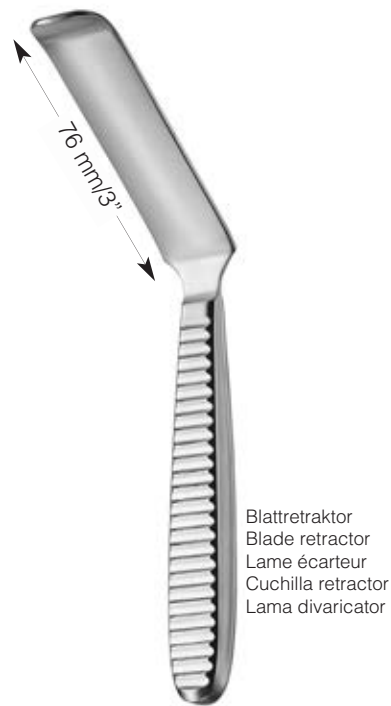
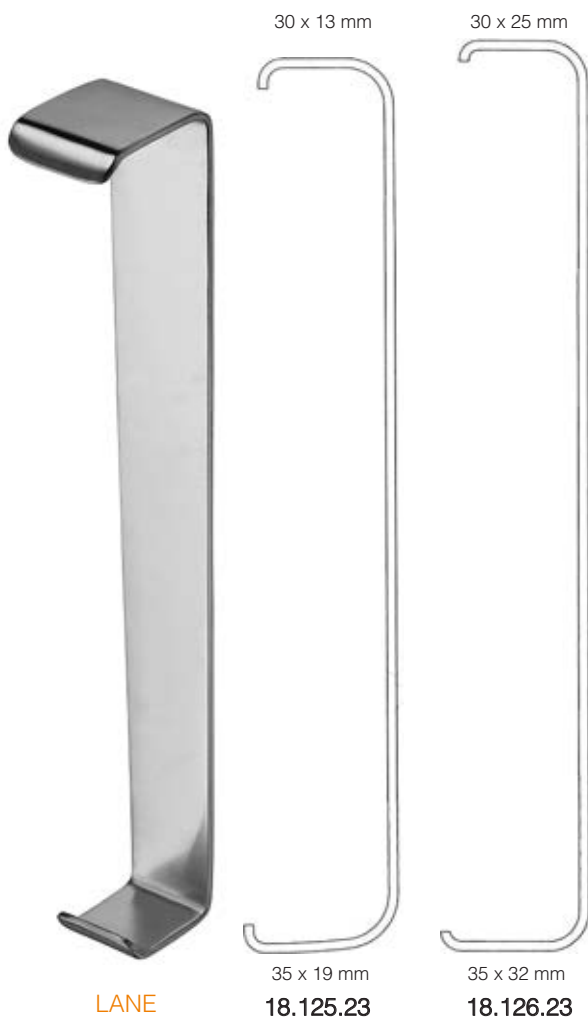

CLOWARD

18 mm	18.165.18
20 mm	18.165.20
23 mm	18.165.23



RAGNELL-DAVIS
18.242.14
 14 cm/5½"

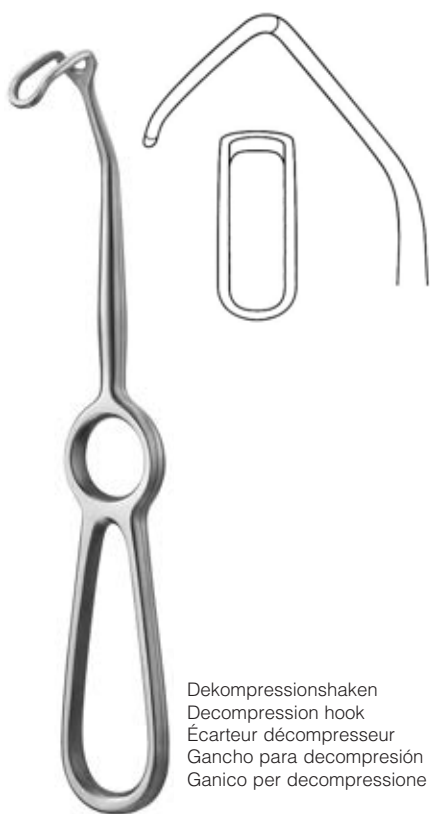

Dekompressionshaken
 Decompression hook
 Écarteur décompresseur
 Gancho para decompresión
 Ganico per decompressione

CUSHING
18.234.20
 20 cm/8"

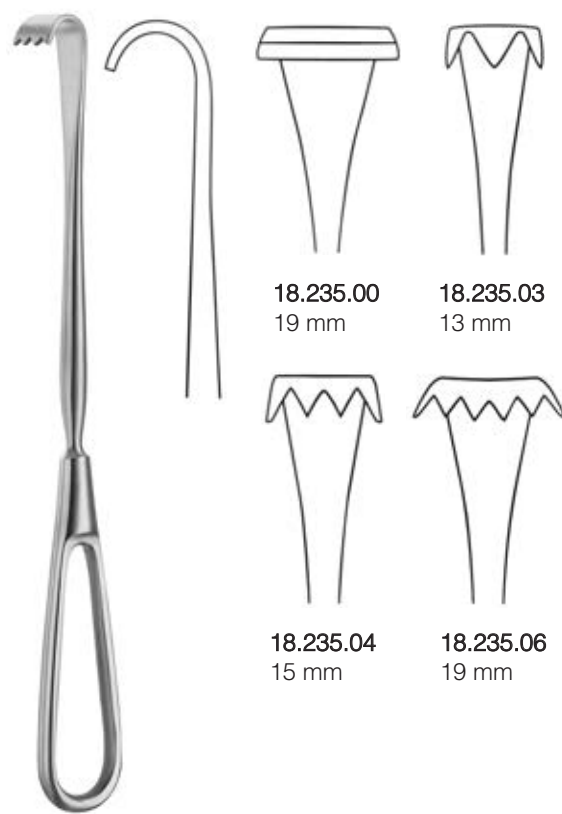

18.235.00
 19 mm

18.235.03
 13 mm

18.235.04
 15 mm

18.235.06
 19 mm

OLDBERG



KOCHER-LANGENBECK
22 cm/8½"

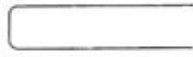

18.342.01
25x6 mm



18.342.04
35x15 mm



18.342.02
35x8 mm



18.342.05
40x11 mm



18.342.03
35x11 mm

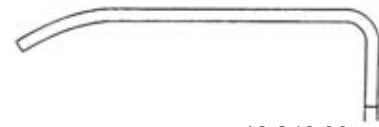

18.342.06
55x11 mm



18.342.07
70x14 mm



18.342.08
80x12 mm



18.342.09
80x16 mm



MEYERDING

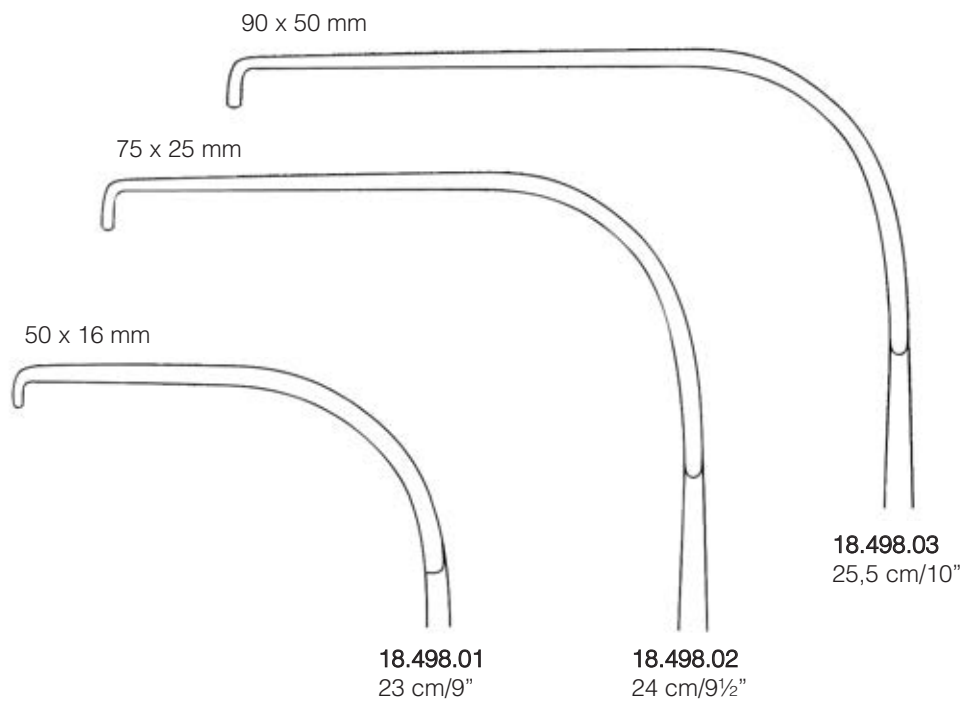

GELPI

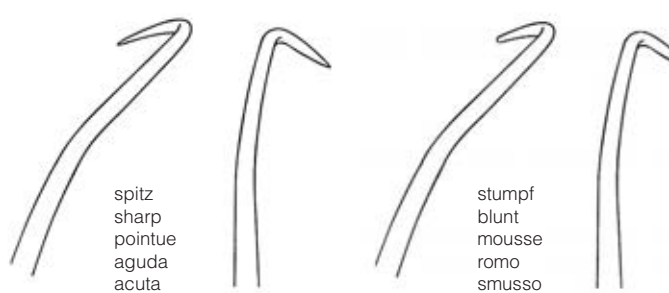

9 cm/3½"	18.802.09
11 cm/4¼"	18.802.11
14 cm/5½"	18.802.14
16 cm/6¼"	18.802.16
18 cm/7"	18.802.18

18 cm/7"	18.803.18
----------	------------------

Wundspreizer

Self-retaining retractors
Écarteurs autostatiques
Separadores autostáticos
Divaricatori autostatici



FINSEN

2 x 3



18.610.05
5 cm/2"

spitz
sharp
pointu
agudo
acuto

2 x 3



18.611.05
5 cm/2"

stumpf
blunt
mousse
romo
smusso

3 x 4



18.610.07
7 cm/2¾"

spitz
sharp
pointu
agudo
acuto

3 x 4



18.611.07
7 cm/2¾"

stumpf
blunt
mousse
romo
smusso

mit Stellschraube
with adjusting screw
avec vis d'ajustage
con tornillo de ajuste
con vite di arresto

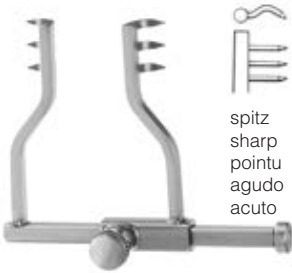

spitz
sharp
pointu
agudo
acuto

LOGAN
18.612.04
4 cm/1½"

mit Stellschraube
with adjusting screw
avec vis d'ajustage
con tornillo de ajuste
con vite di arresto



FINSEN
7 cm/2¾"



18.613.07
3 : 4

spitz
sharp
pointu
agudo
acuto



18.614.07
3 : 4

stumpf
blunt
mousse
romo
smusso



ALM



18.620.07
7 cm/2¾"

scharf
sharp
pointu
agudo
acuto



18.620.10
10 cm/4"

scharf
sharp
pointu
agudo
acuto



18.621.07
7 cm/2¾"

stumpf
blunt
mousse
romo
smusso



18.621.10
10 cm/4"

stumpf
blunt
mousse
romo
smusso



18.628.10

spitz
sharp
pointu
agudo
acuto

JANSEN-GIFFORD
10 cm/4"



18.629.10

stumpf
blunt
mousse
romo
smusso

JANSEN
10 cm/4"



18.630.10

spitz
sharp
pointu
agudo
acuto



18.631.10

stumpf
blunt
mousse
romo
smusso



JANSEN-WAGNER
18.632.11
11 cm/4 1/4"



18.636.10

spitz
sharp
pointu
agudo
acuto

JANSEN
10,5 cm/4 1/4"

18.637.10

stumpf
blunt
mousse
romo
smusso



18.634.10

spitz
sharp
pointu
agudo
acuto

DIMEDA
10 cm/4"

Wundspreizer

Self-retaining retractors
Écarteurs autostatiques
Separadores autostáticos
Divaricatori autostatici



HENLEY
16,5 cm/6½"

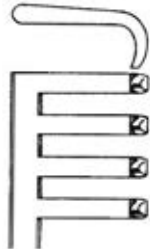

18.660.16
3 : 4

stumpf
blunt
mousse
romo
smusso

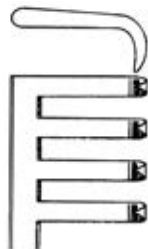

18.661.16
3 : 4

scharf
sharp
pointu
agudo
acuto

mit Mittelvalven
18.661.17 - 18.661.19

with central blades
18.661.17 - 18.661.19

avec lames centrales
18.661.17 - 18.661.19

con valvas centrales
18.661.17 - 18.661.19

con lamierine centrali
18.661.17 - 18.661.19



18.661.17
16x19 mm
5/8" x 3/4"



18.661.18
16x25 mm
5/8" x 1"



18.661.19
16x32 mm
5/8" x 1¼"



WEITLANER
18.667.13
13,5 cm/5¼"

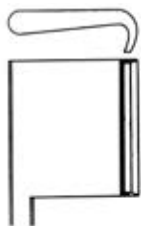

WEITLANER
13 cm/5"

3 x 4



18.668.13
scharf
sharp
pointu
agudo
acuto



18.669.13
stumpf
blunt
mousse
romo
smusso



18.672.13
halbscharf
semi-sharp
semi-pointu
semi agudo
semi acuto



WEITLANER

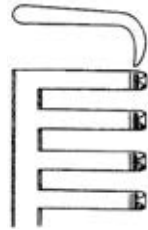

18.670.14
 14 cm/5½"
 3 : 4

scharf
 sharp
 pointu
 agudo
 acuto

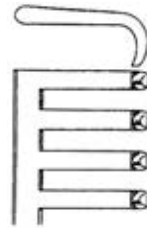

18.671.14
 14 cm/4½"
 3 : 4

stumpf
 blunt
 mousse
 romo
 smusso

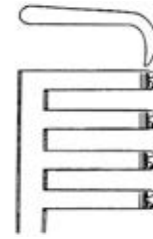

18.670.16
 16,5 cm/6½"
 3 : 4

scharf
 sharp
 pointu
 agudo
 acuto

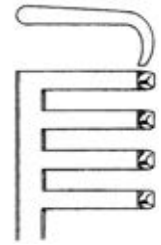

18.671.16
 16,5 cm/6½"
 3 : 4

stumpf
 blunt
 mousse
 romo
 smusso



WEITLANER
 20 cm/8"

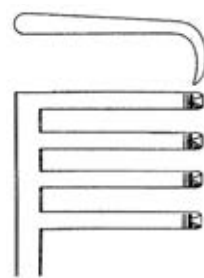

18.670.20
 3 : 4

scharf
 sharp
 pointu
 agudo
 acuto

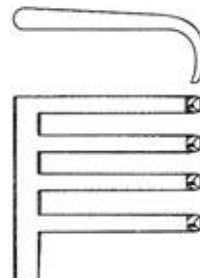

18.671.20
 3 : 4

stumpf
 blunt
 mousse
 romo
 smusso

Wundspreizer

Self-retaining retractors
Écarteurs autostatiques
Separadores autostáticos
Divaricatori autostatici



WEITLANER
25 cm/10"

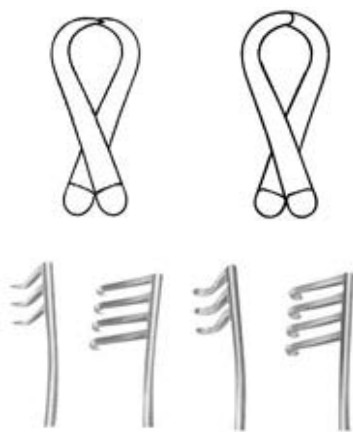

18.670.25
3 : 4

scharf
sharp
pointu
agudo
acuto



18.671.25
3 : 4

stumpf
blunt
mousse
romo
smusso



WEITLANER
26 cm/10¼"



18.670.26
5 : 6

scharf
sharp
pointu
agudo
acuto

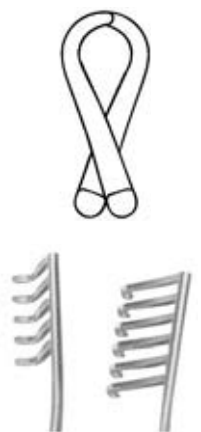

18.671.26
5 : 6

stumpf
blunt
mousse
romo
smusso

Cerebellum-Spreizer
 Cerebellar retractors
 Écarteurs pour opérations cérébelleuses
 Separadores para cerebello
 Divaricatori per il cervelletto



3 x 4

halbscharf
 semi-sharp
 semi-pointu
 semi agudo
 semi acuto

WEITLANER
18.672.16
 16,5 cm/6½"

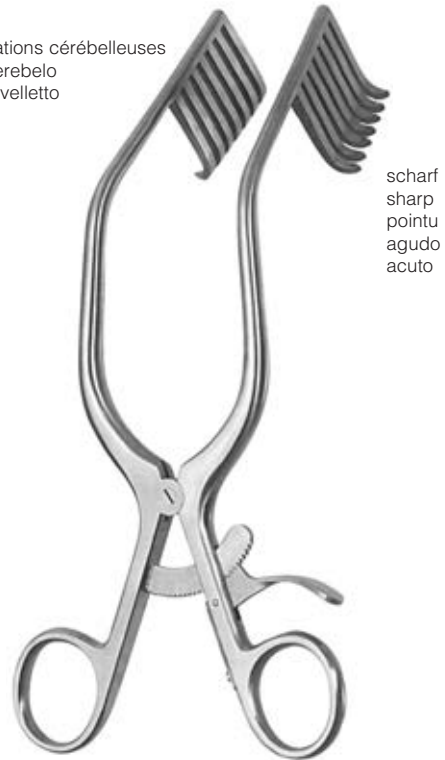

scharf
 sharp
 pointu
 agudo
 acuto

MISKIMON
18.676.22
 22 cm/8¼"
 35 mm

Cerebellum-Spreizer
 Cerebellar retractors
 Écarteurs pour opérations cérébelleuses
 Separadores para cerebello
 Divaricatori per il cervelletto

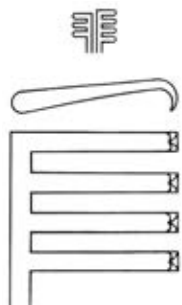

18.678.20
 4 : 4

scharf
 sharp
 pointu
 agudo
 acuto

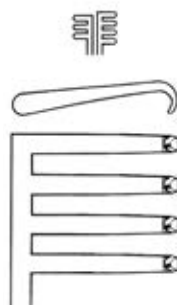

18.679.20
 4 : 4

stumpf
 blunt
 mousse
 romo
 smusso

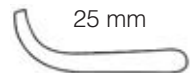

18.680.19

scharf
 sharp
 pointu
 agudo
 acuto

18.681.19

stumpf
 blunt
 mousse
 romo
 smusso

ANDERSON-ADSON
 20 cm/8"

ADSON
 19 cm/7½"

Wundspreizer

Self-retaining retractors
Écarteurs autostatiques
Separadores autostáticos
Divaricatori autostatici



ADSON
26,5 cm/10½"

80 mm
↔

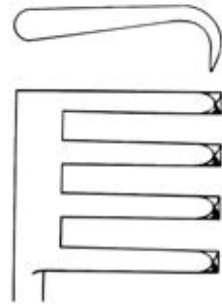

18.682.26
3 : 4

scharf
sharp
pointu
agudo
acuto

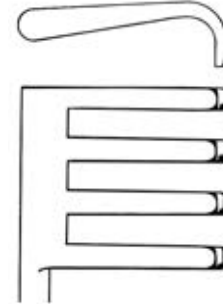

18.683.26
3 : 4

stumpf
blunt
mousse
romo
smusso

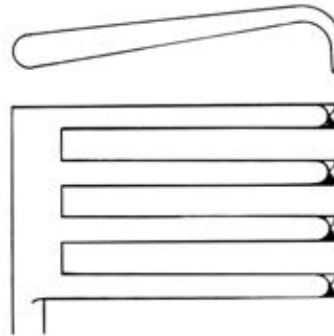

18.682.25
3 : 4

scharf
sharp
pointu
agudo
acuto

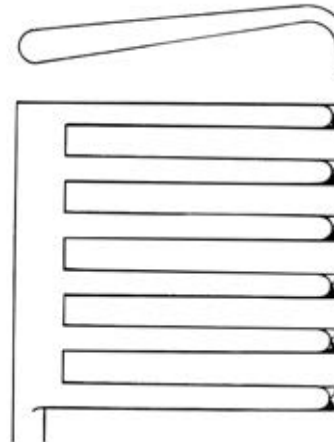

18.682.27
5 : 6

scharf
sharp
pointu
agudo
acuto

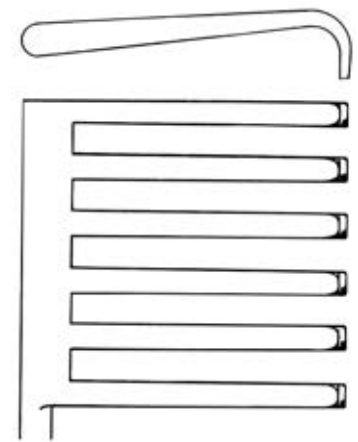

18.683.27
5 : 6

stumpf
blunt
mousse
romo
smusso



ADSON
 3 : 4



18.684.13
 13,5 cm/5¼"

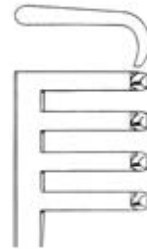

18.685.13
 13,5 cm/5¼"



18.684.16
 16,5 cm/6½"

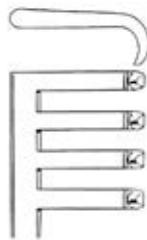

18.685.16
 16,5 cm/6½"



18.684.20
 21 cm/8¼"



18.685.20
 20 cm/8"

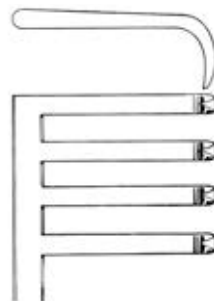

18.684.26
 24,5 cm/9¾"
 scharf
 sharp
 pointu
 agudo
 acuto



18.685.24
 24,5 cm/9¾"
 stumpf
 blunt
 mousse
 romo
 smusso

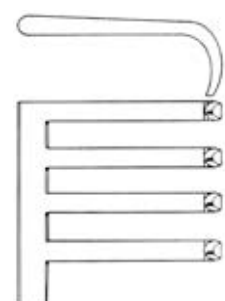

18.685.26
 26 cm/10¼"
 stumpf
 blunt
 mousse
 romo
 smusso

Wundspreizer

Self-retaining retractors
Écarteurs autostatiques
Separadores autostáticos
Divaricatori autostatici

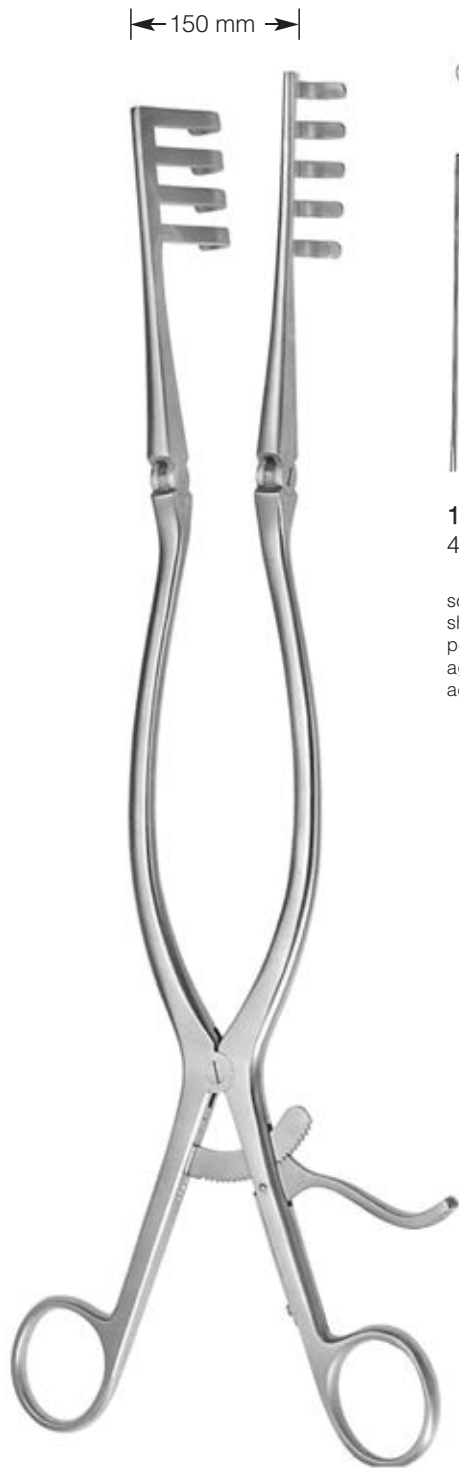

BECKMANN-ADSON
32 cm/12¾"

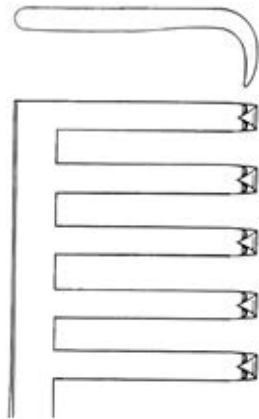

18.686.33
4 : 5

scharf
sharp
pointu
agudo
acuto

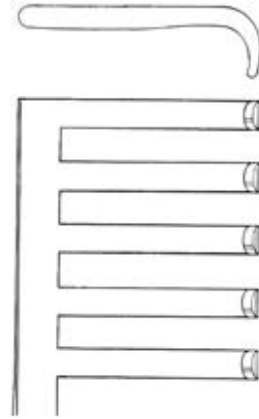

18.686.32
4 : 5

halbscharf
semi-sharp
semi-pointu
semi agudo
semi acuto



18.687.27
26,5 cm/10½"

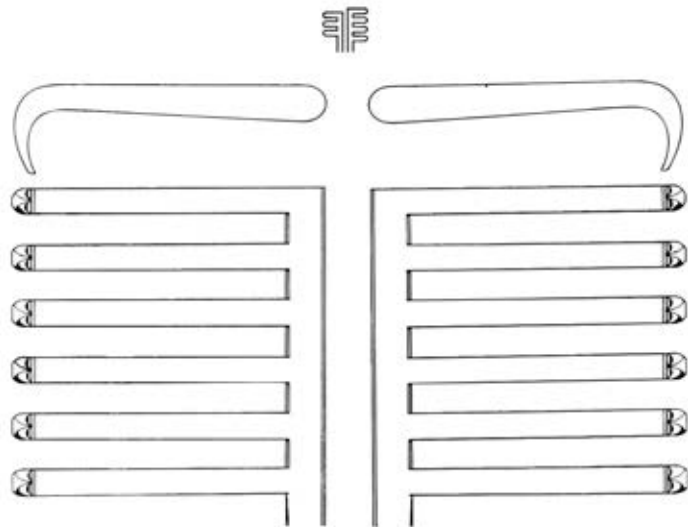

6 : 6

scharf
sharp
pointu
agudo
acuto

Hemilaminectomie-Wundspreizer

Hemilaminectomy retractors

Écarteurs pour hemilaminectomie

Separadores para hemilaminectomía

Divaricatori per hemilaminectomia

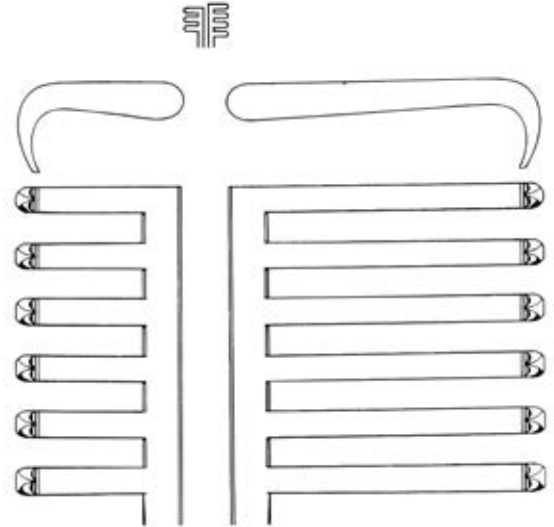
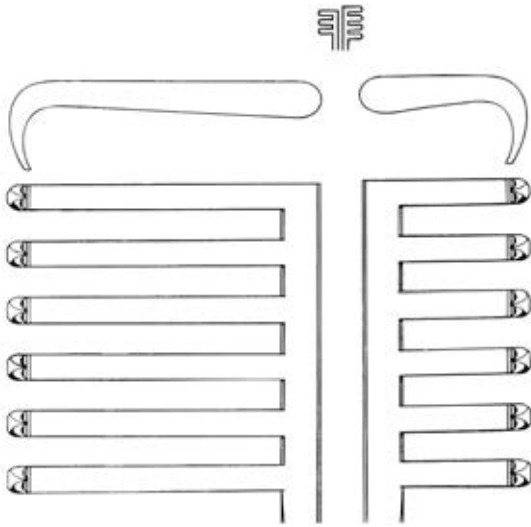

18.688.27

6 : 6

scharf, lange Zähne links
sharp, long teeth left
pointu, griffes longues à gauche
agudo, dientes largos a la izquierda
acuto, denti lunghe a sinistra

18.689.27

6 : 6

scharf, lange Zähne rechts
sharp, long teeth right
pointu, griffes longues à droite
agudo, dientes largos a la derecha
acuto, denti lunghe a destra



26,5 cm/10½"

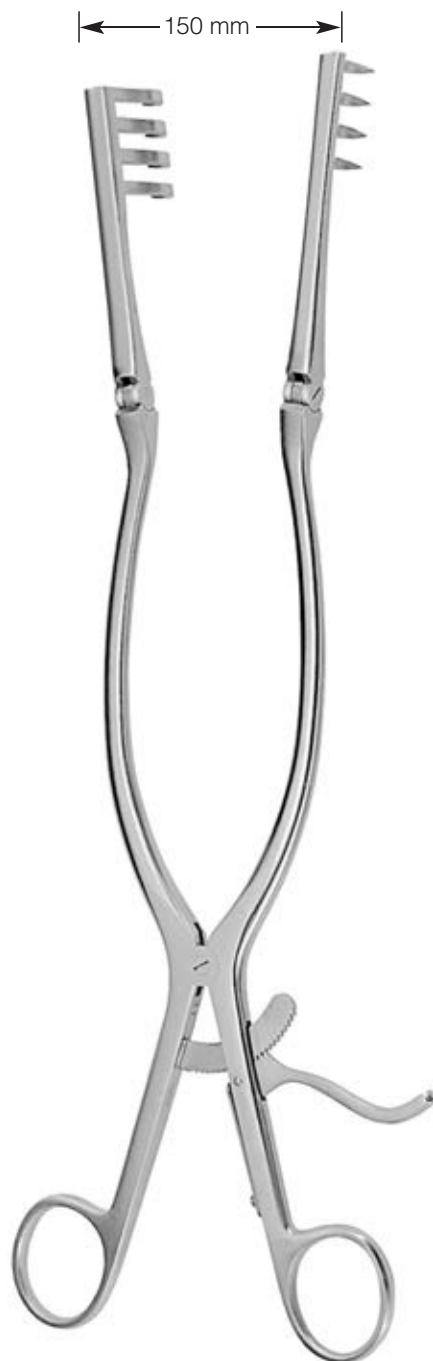

BECKMANN
 31 cm/30½"

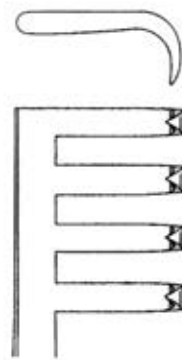

18.690.31
 4 : 4

scharf
 sharp
 pointu
 agudo
 acuto

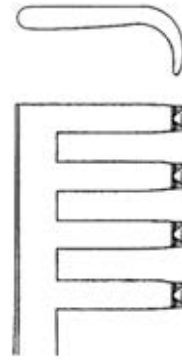

18.691.31
 4 : 4

halbscharf
 semi-sharp
 semi-pointu
 semi agudo
 semi acuto

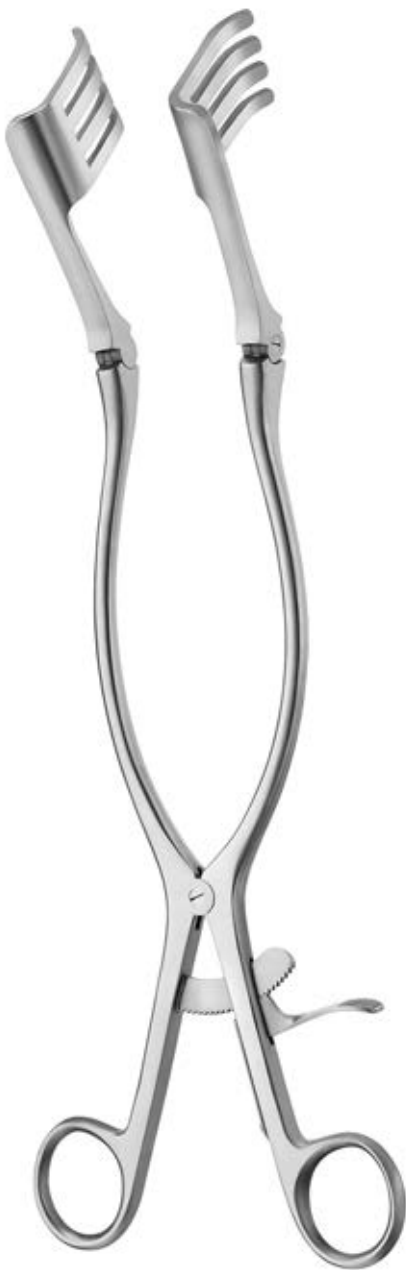

BECKMANN-ADSON
 30,5 cm/30¼"

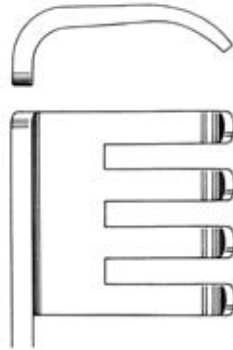

18.692.00
 30 mm
 4 : 4

stumpf
 blunt
 mousse
 romo
 smusso

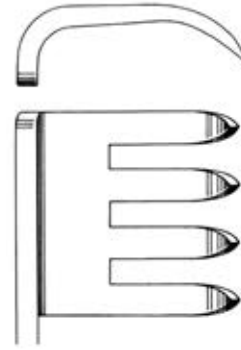

18.692.01
 30 mm
 4 : 4

scharf
 sharp
 pointu
 agudo
 acuto

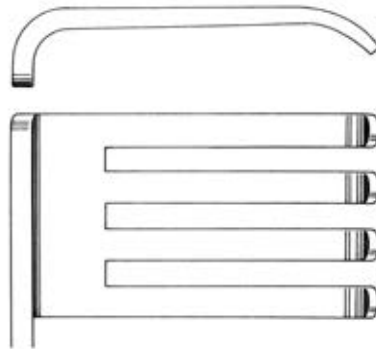

18.692.02
 50 mm
 4 : 4

stumpf
 blunt
 mousse
 romo
 smusso

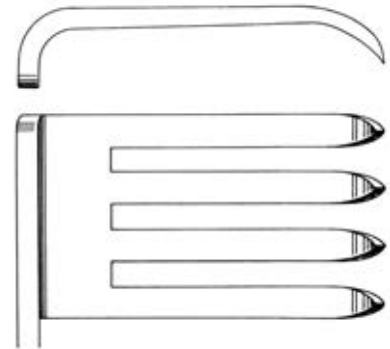

18.692.03
 50 mm
 4 : 4

scharf
 sharp
 pointu
 agudo
 acuto

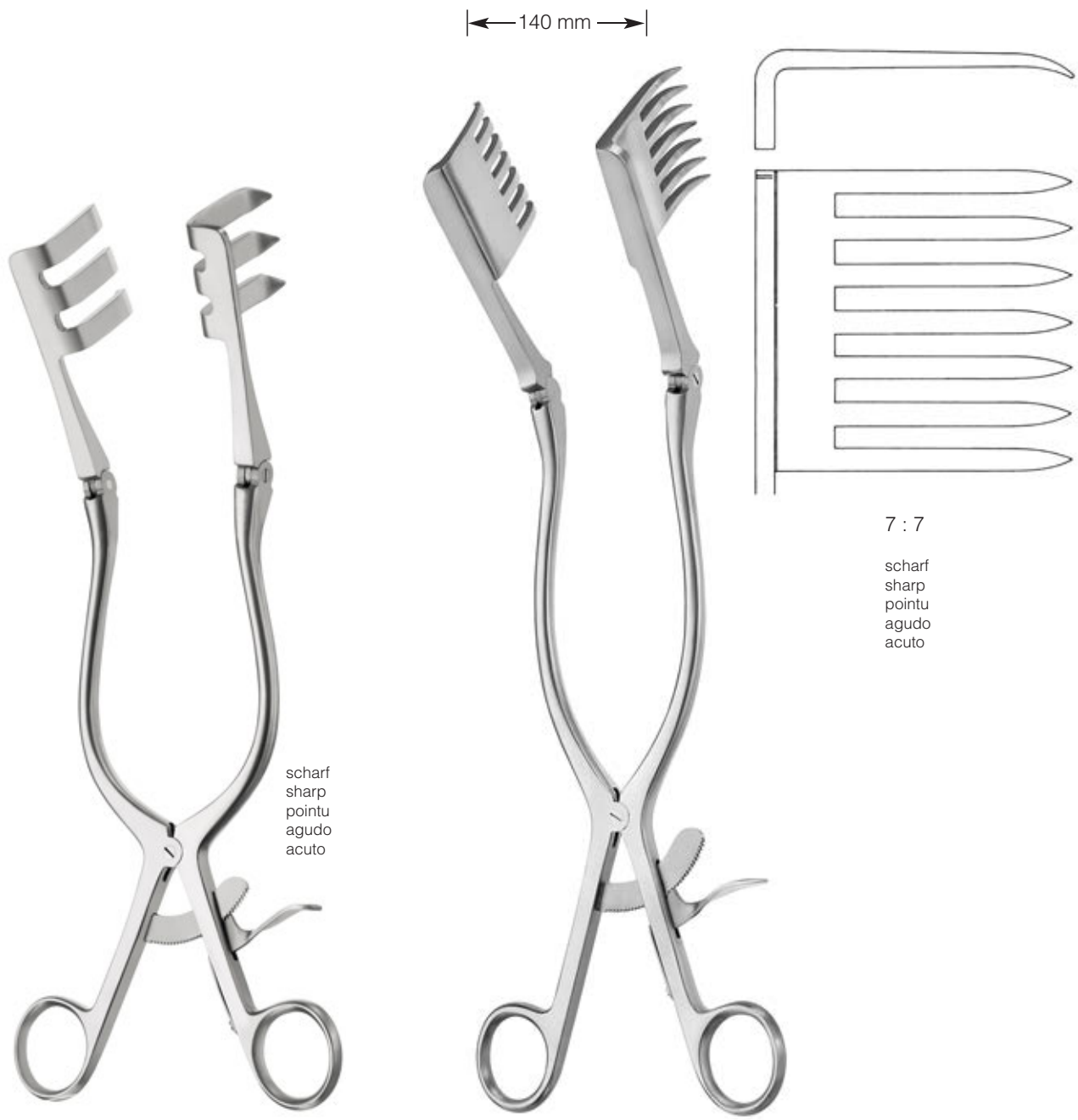

HARVEY-JACKSON
18.692.28
 28 cm/11"

BECKMANN-EATON
18.692.32
 32 cm/12¾"

Wundspreizer

Wound spreaders, self-retaining

Écarteurs autostatiques

Separadores autostáticos

Divaricatori autostatici

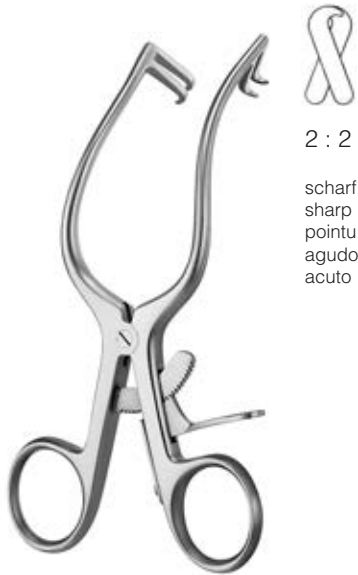

2 : 2

scharf
sharp
pointu
agudo
acuto

MOLLISON
18.693.13
14 cm/5½"



18.693.15
4 : 4

scharf
sharp
pointu
agudo
acuto

MOLLISON
15 cm/6"



18.693.16
4 : 4

stumpf
blunt
mousse
romo
smusso

gebogen
curved
courbée
curva
curva



3 : 4

stumpf
blunt
mousse
romo
smusso

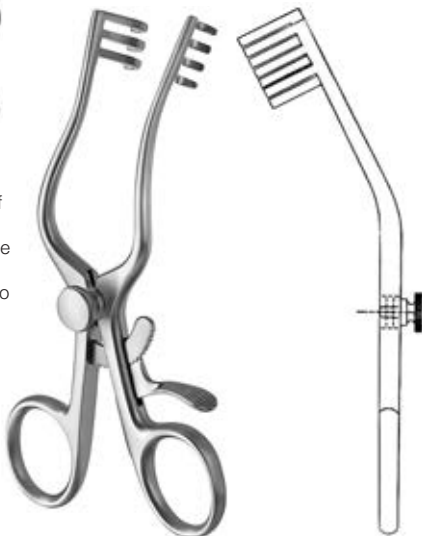

JEFFERSON
18.699.14
14 cm/5½"

Valve drehbar
Swivel blade
Lame pivotante
Hoja giratoria
Girevole lama



scharf
sharp
pointu
agudo
acuto



CAIRNS
18.699.15
14,5 cm/5¾"



13 cm/5"	18.694.13	18.695.13
16,5 cm/6½"	18.694.16	18.695.16
20 cm/8"	18.694.20	18.695.20
26,5 cm/10½"	18.694.25	

scharf	stumpf
sharp	blunt
pointu	mousse
agudo	romo
acuto	smusso

CONE



stumpf
 blunt
 mousse
 romo
 smusso

NORFOLK and NORWICH

18.699.22
 22 cm/8¼"



DARLING
18.696.18
 18 cm/7"



DARLING
18.698.18
 18 cm/7"

Laminektomie-Wundspreizer
 Laminectomy retractors
 Écarteurs pour laminectomie
 Separadores para laminectomía
 Divaricatori per laminectomia



Blätter rechts
 Blades right
 Valves à droite
 Valvas a la derecha
 Lame destra

WALTON
18.707.01
 18 cm/7"



Blätter links
 Blades left
 Valves à gauche
 Valvas a la izquierda
 Lame sinistra

WALTON
18.707.02
 18 cm/7"



Blätter rechts
 blades right
 Valves à droite
 Valvas a la derecha
 Lame destra

KNIGHTON
18.708.01
 18 cm/7"



Blätter links
 Blades left
 Valves à gauche
 Valvas a la izquierda
 Lame sinistra

KNIGHTON
18.708.02
 18 cm/7"



18.710.40
40 mm



18.710.45
45 mm



18.710.50
50 mm



18.710.55
55 mm



18.710.60
60 mm

18.710.01
25 cm/10"

Sperrer allein
 Spreader only
 Écarteur seul
 Separador suelto
 Divaricatore solo

18.710.00
25 cm/10"

komplett
 complete
 complet
 completo
 completo

mit je 5 Steckvalven
 with 5 plug-in blades each
 chacun avec 5 valves interchangeables
 cada uno con 5 valvas enchufables
 con 5 valve ad innesto



18.711.40
40 mm



18.711.45
45 mm



18.711.50
50 mm



18.711.55
55 mm



18.711.60
60 mm

18.711.01
15 cm/6"

Sperrer allein
 Spreader only
 Écarteur seul
 Separador suelto
 Divaricatore solo

18.711.00
17 cm/6¾"

komplett
 complete
 complet
 completo
 completo

mit je 5 Steckvalven
 with 5 plug-in blades each
 chacun avec 5 valves interchangeables
 cada uno con 5 valvas enchufables
 con 5 valve ad innesto

scharf
 sharp
 pointu
 agudo
 acuto

stumpf
 blunt
 mousse
 romo
 smusso



CLOWARD

CLOWARD

Hemilaminectomie-Wundspreizer

Hemilaminectomy retractors

Écarteurs pour hemilaminectomie

Separadores para hemilaminectomía

Divaricatori per hemilaminectomia



MARKHAM-MEYERDING

18.712.18

18 cm/7"

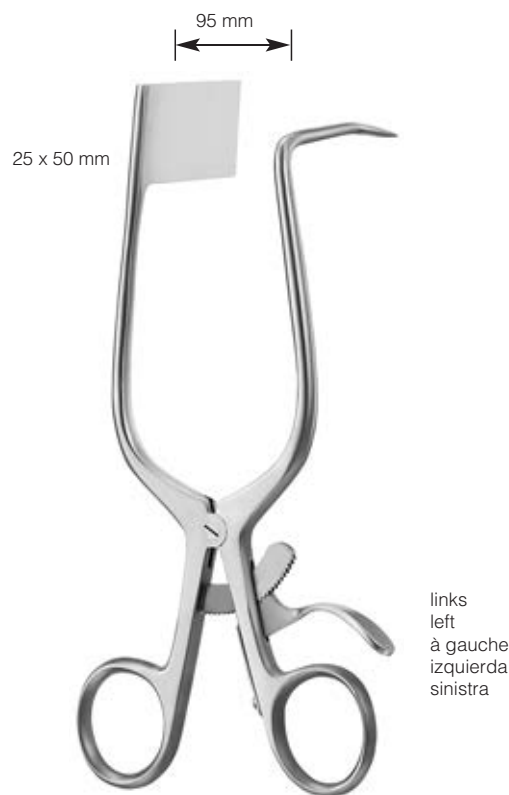

MARKHAM-MEYERDING

18.713.18

18 cm/7"



MEYERDING

32 x 25 mm 18.714.32

54 x 25 mm 18.714.54

60 x 25 mm 18.714.60

60 x 19 mm 18.714.61

Cervicalspreizer (Wirbelkörperspreizer)

Cervical retractor (lamina spreader)
 Écarteur cervical (écarteur pour corps vertébraux)
 Separador cervical (separador de cuerpos vertebrales)
 Divaricatore cervicale (divaricatore per corpi vertebrali)



rechts
right
à droite
derecha
destra

rechts
right
à droite
derecha
destra

links
left
à gauche
izquierda
sinistra

1 cm/5 cm	18.881.50	18.880.50
1 cm/6 cm	18.881.60	18.880.60
1 cm/7 cm	18.881.70	18.880.70
2 cm/5 cm	18.882.50	18.883.50
2 cm/6 cm	18.882.60	18.883.60
2 cm/7 cm	18.882.70	18.883.70

WILLIAMS



mit Sperre
with ratchet
avec cremaillère
con cierre
con serratura

Kopfhautspreizer
Scalp retractor
Écarteur autostatique pour le cuir chevelu
Separador para el cuero cabelludo
Divaricatore autostatico per il cuoio capelluto

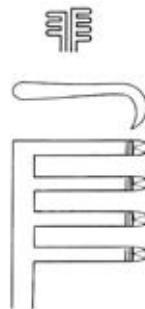

18.725.14
3 : 4

scharf
sharp
pointu
agudo
acuto

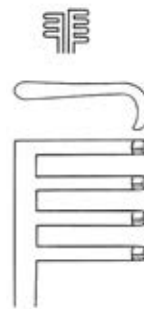

18.727.14
3 : 4

stumpf
blunt
mousse
romo
smusso

CONTOUR
13,5 cm/5¼"

Cervicalspreizer (Wirbelkörperspreizer)

Cervical retractor (lamina spreader)

Écarteur cervical (écarteur pour corps vertébraux)

Separador cervical (separador de cuerpos vertebrales)

Divaricatore cervicale (divaricatore per corpi vertebrali)



CASPAR
15 cm/6"

90 mm



CASPAR
16,5 cm/6½"

18.720.00

Gegensperrer komplett,
mit 5 Blättern **18.716.45 - 18.716.65**

Retractor complete,
with 5 blades **18.716.45 - 18.716.65**

Écarteur complet,
avec 5 valves **18.716.45 - 18.716.65**

Separador completo,
con 5 valvas enchufables **18.716.45 - 18.716.65**

Divaricatore completo,
con 5 valve ad innesto **18.716.45 - 18.716.65**

18.720.15

Sperrer allein
Spreader only
Écarteur seul
Separador suelto
Divaricatore solo



18.716.45 - 18.716.65

18.721.00

Gegensperrer komplett,
mit 5 Blättern **18.716.45 - 18.716.65**

Retractor complete,
with 5 blades **18.716.45 - 18.716.65**

Ecarteur complet,
avec 5 valves **18.716.45 - 18.716.65**

Separador completo,
con 5 valvas enchufables **18.716.45 - 18.716.65**

Divaricatore completo,
con 5 valve ad innesto **18.716.45 - 18.716.65**

18.721.15

Sperrer allein
Spreader only
Ecarteur seul
Separador suelto
Divaricatore solo



18.716.45 - 18.716.65



11 cm/4¼"

18.724.00

Spreizer komplett
mit 5 Blättern **18.716.45 - 18.716.65**

Retractor complete
with 5 blades **18.716.45 - 18.716.65**

Ecarteur complet
avec 5 valves **18.716.45 - 18.716.65**

Separador completo
con 5 valvas enchufables **18.716.45 - 18.716.65**

Divaricatore completo
con 5 valve ad innesto **18.716.45 - 18.716.65**

18.724.11

Sperrer allein
Spreader only
Ecarteur seul
Separador suelto
Divaricatore solo



18.716.45 - 18.716.65



CASPAR

18.725.00

Spreizer komplett,
mit 5 Blättern **18.716.45 - 18.716.65**

Retractor complete
with 5 blades **18.716.45 - 18.716.65**

Ecarteur complet
avec 5 valves **18.716.45 - 18.716.65**

Separador completo
con 5 valvas enchufables de c.u. **18.716.45 - 18.716.65**

Divaricatore completo
con 5 valve ad innesto **18.716.45 - 18.716.65**

18.725.11

Sperrer allein
Spreader only
Ecarteur seul
Separador suelto
Divaricatore solo



18.716.45 - 18.716.65

Cervicalspreizer (Wirbelkörperspreizer)

Cervical retractor (lamina spreader)

Écarteur cervical (écarteur pour corps vertébraux)

Separador cervical (separador de cuerpos vertebrales)

Divaricatore cervicale (divaricatore per corpi vertebrali)

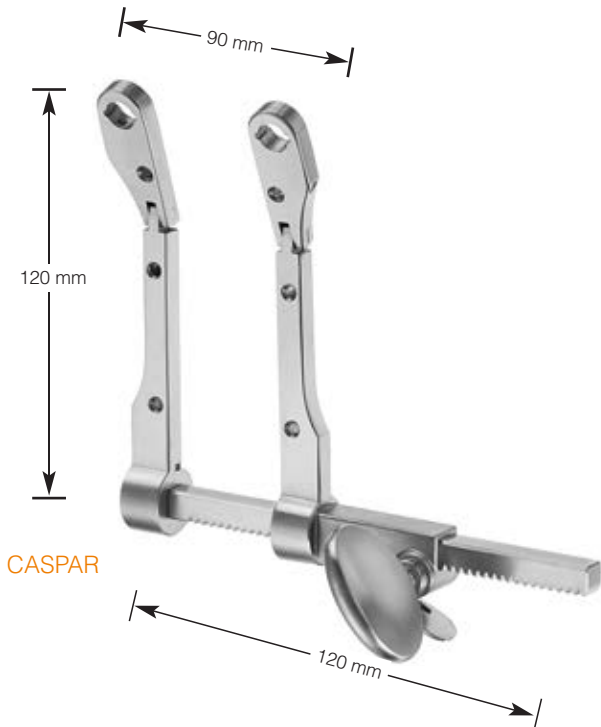

18.723.00

Sperrer komplett mit
5 medialen Blättern **18.718.40 - 18.718.60**
5 lateralen Blättern **18.719.40 - 18.719.60**

Retractor complete with
5 medial blades **18.718.40 - 18.718.60**
5 lateral blades **18.719.40 - 18.719.60**

Écarteur complet avec
5 valves médiales **18.718.40 - 18.718.60**
5 valves latérales **18.719.40 - 18.719.60**

Separador completo con
5 valvas mediales **18.718.40 - 18.718.60**
5 valvas laterales **18.719.40 - 18.719.60**

Divaricatore completo con
5 media valve **18.718.40 - 18.718.60**
5 laterale valve **18.719.40 - 18.719.60**

18.723.12

Sperrer allein
Spreader only
Écarteur seul
Separador suelto
Divaricatore solo



18.718.40 - 18.718.60



18.719.40 - 18.719.60

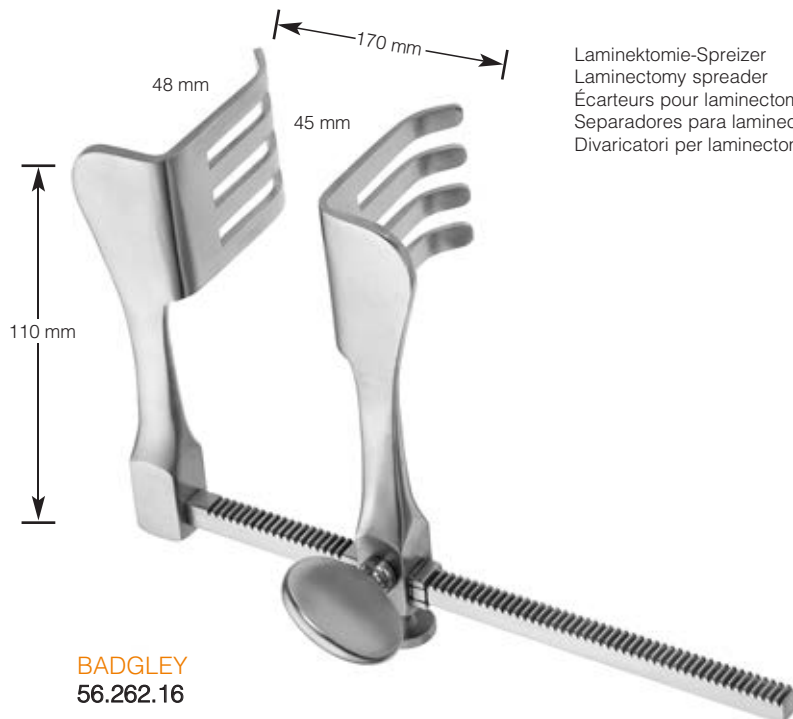

Laminectomie-Spreizer
Laminectomy spreader
Écarteurs pour laminectomie
Separadores para laminectomía
Divaricatori per laminectomia

Cervicalspreizer (Wirbelkörperspreizer)

Cervical retractor (lamina spreader)
Écarteur cervical (écarteur pour corps vertébraux)
Separador cervical (separador de cuerpos vertebrales)
Divaricatore cervicale (divaricatore per corpi vertebrali)



stumpfe Blätter
blunt blades
lames mousses
hojas romas
smusso lame

CASPAR

45 x 23 mm	18.716.45
50 x 23 mm	18.716.50
55 x 23 mm	18.716.55
60 x 23 mm	18.716.60
65 x 23 mm	18.716.65



mediale Blätter
medial blades
lames médiales
hojas mediales
mediale lame

CASPAR

40 x 23 mm	18.718.40
45 x 23 mm	18.718.45
50 x 23 mm	18.718.50
55 x 23 mm	18.718.55
60 x 23 mm	18.718.60



laterale Blätter
lateral blades
lames latérales
hojas laterales
lame laterali

CASPAR

40 x 23 mm	18.719.40
45 x 23 mm	18.719.45
50 x 23 mm	18.719.50
55 x 23 mm	18.719.55
60 x 23 mm	18.719.60



stumpfe Blätter, zur Spanentnahme am Beckenkamm

blunt blades, for harvesting of the fusion graft from the iliac crest

lames mousses, pour la récolte de la fusion greffe de la crête iliaque

hojas romas, para la recogida de la fusión del injerto de la cresta iliaca

lame smusso, per la raccolta della fusione il trapianto da cresta iliaca

CASPAR

50 x 25 mm	18.726.50
60 x 25 mm	18.726.60



Pinzette zum Wechseln der Valven
Blade ejector forceps
Pince pour le changement des valves
Pinza para cambiar las valvas
Pinza per cambiare le valve

18.722.11

11,5 cm/4½"

Cervicalspreizer (Wirbelkörperspreizer)

Cervical retractor (lamina spreader)

Écarteur cervical (écarteur pour corps vertébraux)

Separador cervical (separador de cuerpos vertebrales)

Divaricatore cervicale (divaricatore per corpi vertebrali)

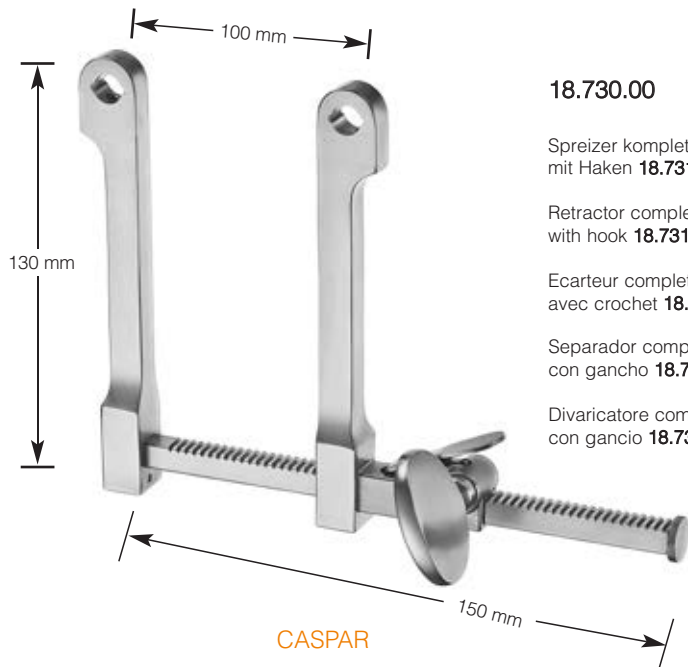

18.730.00

Spreizer komplett
mit Haken **18.731.50**; 5 Valven **18.732.40 - 18.732.60**

Retractor complete
with hook **18.731.50**; 5 blades **18.732.40 - 18.732.60**

Ecarteur complet
avec crochet **18.731.50**; 5 valves **18.732.40 - 18.732.60**

Separador completo
con gancho **18.731.50**; 5 valvas enchufables **18.732.40 - 18.732.60**

Divaricatore completo
con gancio **18.731.50**; 5 valve ad innesto **18.732.40 - 18.732.60**

18.730.15

Sperrer allein
Spreader only
Ecarteur seul
Separador suelto
Divaricatore solo

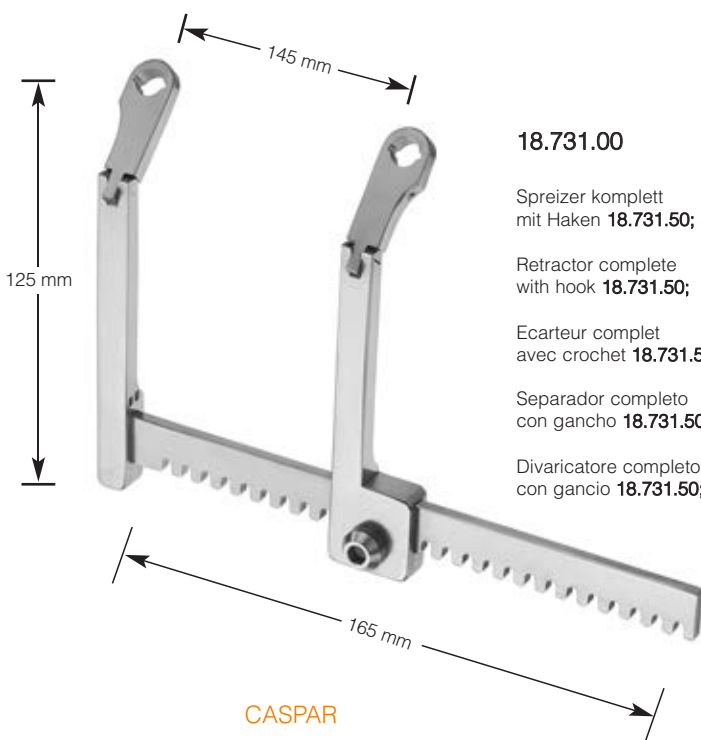

18.731.00

Spreizer komplett
mit Haken **18.731.50**; 5 Valven **18.732.40 - 18.732.60**

Retractor complete
with hook **18.731.50**; 5 blades **18.732.40 - 18.732.60**

Ecarteur complet
avec crochet **18.731.50**; 5 valves **18.732.40 - 18.732.60**

Separador completo
con gancho **18.731.50**; 5 valvas enchufables **18.732.40 - 18.732.60**

Divaricatore completo
con gancio **18.731.50**; 5 valve ad innesto **18.732.40 - 18.732.60**

18.731.14

Sperrer allein, mit Drehschlüssel
Retractor only, with key
Ecarteur seul, avec clé
Separador suelto, con llave
Divaricatore solo, con chiave

18.731.99

Drehschlüssel allein
Key only
Clé seule
Llave suelta
Chiave sola



Cervicalspreizer (Wirbelkörperspreizer)

Cervical retractor (lamina spreader)
 Écarteur cervical (écarteur pour corps vertébraux)
 Separador cervical (separador de cuerpos vertebrales)
 Divaricatore cervicale (divaricatore per corpi vertebrali)

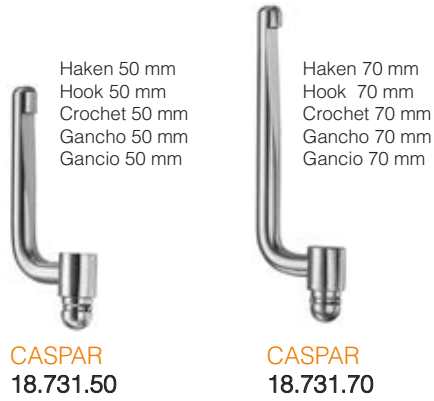

CASPAR

35 x 22 mm	18.732.35
40 x 22 mm	18.732.40
45 x 22 mm	18.732.45
50 x 22 mm	18.732.50
55 x 22 mm	18.732.55
60 x 22 mm	18.732.60
65 x 22 mm	18.732.65
70 x 22 mm	18.732.70



CASPAR

35 x 37 mm	18.733.35
40 x 37 mm	18.733.40
45 x 37 mm	18.733.45
50 x 37 mm	18.733.50
55 x 37 mm	18.733.55
60 x 37 mm	18.733.60
65 x 37 mm	18.733.65
70 x 37 mm	18.733.70



CASPAR

35 x 52 mm	18.734.35
40 x 52 mm	18.734.40
45 x 52 mm	18.734.45
50 x 52 mm	18.734.50
55 x 52 mm	18.734.55
60 x 52 mm	18.734.60
65 x 52 mm	18.734.65
70 x 52 mm	18.734.70

CASPAR (CCR) 132 - 136
 179 - 184

Siehe auch Seite: 199
 See also page: 212
 Voir aussi la page: 228
 Véase también la página: 228
 Vedere anche pagina: 230

CASPAR
18.736.01

Distraktor allein
 Distractor only
 Distracteur seule
 Distractor suelto
 Distractor solo



CASPAR
18.736.00

Wirbelkörperdistraktor für Eingriffe mittels rechtsseitigem Zugang zu C5 - T½ und linksseitigem Zugang zur oberen HWS, bestehend aus:

- 18.736.01** 1 Distraktor allein
- 18.736.02** 1 Bohrlehre
- 18.736.10** 1 Bohrer
- 18.736.16** 2 Distraktionsschrauben
- 18.736.20** 1 Schraubendreher

Vertebral body distractor for use in surgical procedures from the right approach for C 5 through T½ and from the left approach for the upper cervical spine, consisting of:

- 18.736.01** 1 distractor only
- 18.736.02** 1 drill guide
- 18.736.10** 1 twist drill
- 18.736.16** 2 distraction screws
- 18.736.20** 1 screw driver

Distracteur corps vertébral pour utilisation dans les interventions chirurgicales de la approche droite pour C 5 à T½ et de la approche gauche de la colonne cervicale supérieure, composée de:

- 18.736.01** 1 distracteur seul
- 18.736.02** 1 guide-mèche
- 18.736.10** 1 mèche
- 18.736.16** 2 vis à distraction
- 18.736.20** 1 tournevis

Cuerpo vertebral distractor para su uso en procedimientos quirúrgicos desde a la derecha enfoque para C 5 a T½ y de la izquierda enfoque para la parte superior de la columna cervical, consistente en:

- 18.736.01** 1 distractor suelto
- 18.736.02** 1 guía-taladro
- 18.736.10** 1 taladro
- 18.736.16** 2 tornillos de distraccion
- 18.736.20** 1 destornillador

Distractor corpo vertebrale per l'uso in procedure chirurgiche da il approccio dresto per C 5 - T½ e da sinistra per il rachide cervicale superiore, com-prendente:

- 18.736.01** 1 distrattore sole
- 18.736.02** 1 guida-trapano
- 18.736.10** 1 trapano
- 18.736.16** 2 vite per distrazione
- 18.736.20** 1 cacciavite

CASPAR
18.736.02

Bohrlehre
 zur parallelen Positionierung der
 Distraktionsschrauben, mit Distraktor **18.736.01**
 zu verwenden

Drill guide
 for parallel positioning of the distraction screws,
 to be used with distractor **18.736.01**

Guide-mèche
 pour le positionnement parallèle des vis de
 distraction, à utiliser avec distracteur
18.736.01

Guía-taladro
 para la colocación paralela de tornillos de
 distracción, para uso con distractor
18.736.01

Trapano guida
 parallelo per il posizionamento di distrazione viti,
 per essere utilizzata con distractor **18.736.01**

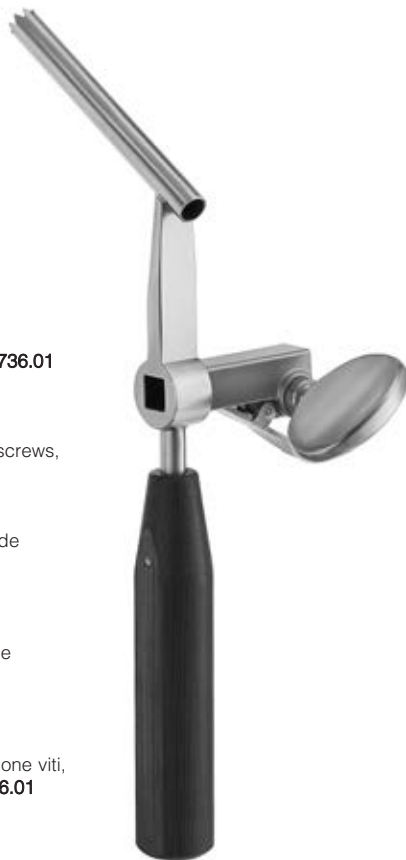



CASPAR
18.737.01

Distraktor allein
 Distractor only
 Distracteur seule
 Distractor suelto
 Distractor solo



CASPAR
18.737.02

Bohrlehre
 zur parallelen Positionierung der
 Distraktionsschrauben, mit Distraktor **18.737.01**
 zu verwenden

Drill guide
 for parallel positioning of the distraction screws,
 to be used with distractor **18.737.01**

Guide-mèche
 pour le positionnement parallèle des vis de
 distraction, à utiliser avec distracteur
18.737.01

Guía-taladro
 para la colocación paralela de tornillos de
 distracción, para uso con distractor
18.737.01

Trapano guida
 parallelo per il posizionamento di distrazione viti,
 per essere utilizzata con distractor **18.737.01**

CASPAR
18.737.00

Wirbelkörperdistraktor für Eingriffe mittels linksseitigem Zugang zu C5 -
 T½ und linksseitigem Zugang zur oberen HWS, bestehend aus:

- | | |
|------------------|-------------------------|
| 18.737.01 | 1 Distraktor allein |
| 18.737.02 | 1 Bohrlehre |
| 18.736.10 | 1 Bohrer |
| 18.736.16 | 2 Distraktionsschrauben |
| 18.736.20 | 1 Schraubendreher |

Vertebral body distractor for use in surgical procedures from the left
 approach for C 5 through T½ and from the left approach for the upper
 cervical spine, consisting of:

- | | |
|------------------|----------------------|
| 18.737.01 | 1 distractor only |
| 18.737.02 | 1 drill guide |
| 18.736.10 | 1 twist drill |
| 18.736.16 | 2 distraction screws |
| 18.736.20 | 1 screw driver |

Distracteur corps vertébral pour utilisation dans des interventions
 chirurgicales à partir de la gauche approche de C 5 à T½ et de la gauche
 approche de la colonne cervicale supérieure, composée de:

- | | |
|------------------|---------------------|
| 18.737.01 | 1 distracteur seul |
| 18.737.02 | 1 guide-mèche |
| 18.736.10 | 1 mèche |
| 18.736.16 | 2 vis à distraction |
| 18.736.20 | 1 tournevis |

Cuerpo vertebral distractor para su uso en procedimientos quirúrgicos de la
 izquierda enfoque de C 5 a T½ y de la izquierda enfoque para la parte
 superior de la columna cervical, consistente en:

- | | |
|------------------|----------------------------|
| 18.737.01 | 1 distractor suelto |
| 18.737.02 | 1 guía-taladro |
| 18.736.10 | 1 taladro |
| 18.736.16 | 2 tornillos de distraccion |
| 18.736.20 | 1 destornillador |

Distractor corpo vertebrale per l'uso in procedure chirurgiche a sinistra per
 C 5 - T½ e da sinistra per il rachide cervicale superiore, comprendente:

- | | |
|------------------|------------------------|
| 18.737.01 | 1 distrattore sole |
| 18.737.02 | 1 guida-trapano |
| 18.736.10 | 1 trapano |
| 18.736.16 | 2 vite per distrazione |
| 18.736.20 | 1 cacciavite |

CASPAR (CCR)	132 - 136
	179 - 184
Siehe auch Seite:	199
See also page:	212
Voir aussi la page:	228
Véase también la página:	230
Vedere anche pagina:	230

Bohrer, Ø 1,7 mm
 zum Vorbohren für Distractionsschrauben,
 Bohrtiefe: 8 mm,
 Schaft Ø 2,35 mm

Twist drill, Ø 1.7 mm
 for pre-drilling holes,
 drilling depth: 8 mm
 shank Ø 2.35 mm

Mèche Ø 1,7 mm,
 pour percer des avant-trous,
 profondeur de forage de 8 mm
 tige Ø 2,35 mm

Taladro Ø 1,7 mm,
 para perforar agujero,
 perforación de 8 mm de profundidad
 mango Ø 2,35 mm

Trapano Ø 1,7 mm,
 per la pre-alesatura fori per viti di
 distrazione, profondità di perforazione 8 mm
 gambo Ø 2,35 mm



CASPAR
18.736.10
 14,5 cm/5¾"

Distractionsschrauben zur Verwendung
 mit Distraktoren **18.736.01**, **18.737.01**. Mindestens 2 Schrauben
 werden benötigt.

Distraction screws to be used with
 distractors **18.736.01**, **18.737.01**. At least 2 screws are required.

Vis à distraction vis pour être utilisé avec distracteurs
18.736.01 et **18.737.01**. Au moins 2 vis sont nécessaires.

Tornillos de distracción para uso con distractores **18.736.01** y
18.737.01. Por lo menos 2 tornillos son necesarios.

Viti di distrazione per essere utilizzato con distractors
18.736.01 e **18.737.01**. Almeno ogni 2 viti sono necessari.



CASPAR
 7 cm/2¾"

12 mm	18.736.12
14 mm	18.736.14
16 mm	18.736.16
18 mm	18.736.18

Schraubendreher für
 Distractionsschrauben

Screw driver
 for distraction screws

Tournevis
 pour vis de distraction

Destornillador
 para tornillos de distracción

Cacciavite
 per viti distrazione



CASPAR
18.736.20
 20 cm/8"

CASPAR (CCR)	132 - 136
	179 - 184
Siehe auch Seite:	199
See also page:	212
Voir aussi la page:	228
Véase también la página:	230
Vedere anche pagina:	230

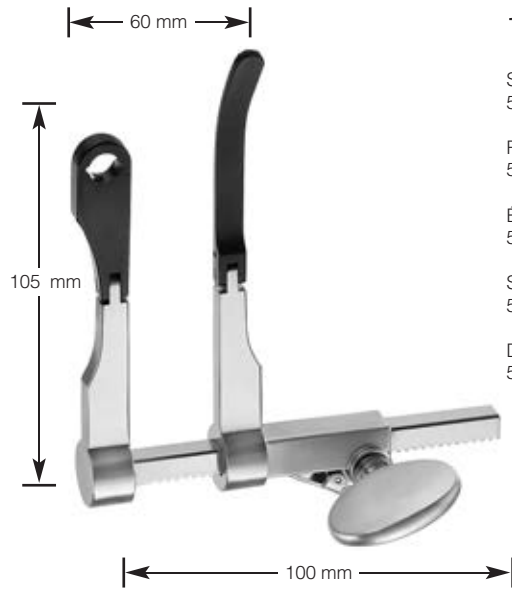

18.738.00

Sperrer komplett mit
 5 lateralen Blättern **18.738.35 - 18.738.60**

Retractor complete with
 5 lateral blades **18.738.35 - 18.738.60**

Écarteur complet avec
 5 valves latérales **18.738.35 - 18.738.60**

Separador completo con
 5 valvas laterales **18.738.35 - 18.738.60**

Divaricatore completo con
 5 laterale valve **18.738.35 - 18.738.60**

18.738.01

Sperrer allein
 Spreader only
 Écarteur seul
 Separador suelto
 Divaricatore solo

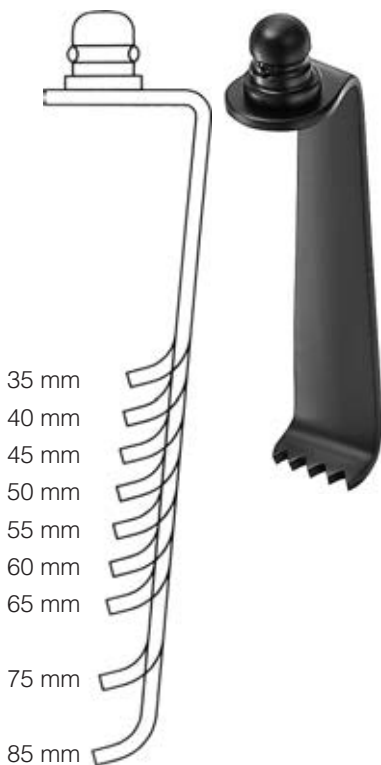

laterale Blätter
 lateral blades
 lames latérales
 hojas laterales
 lame laterali

CASPAR

35 mm	18.738.35
40 mm	18.738.40
45 mm	18.738.45
50 mm	18.738.50
55 mm	18.738.55
60 mm	18.738.60
65 mm	18.738.65
75 mm	18.738.75
85 mm	18.738.85

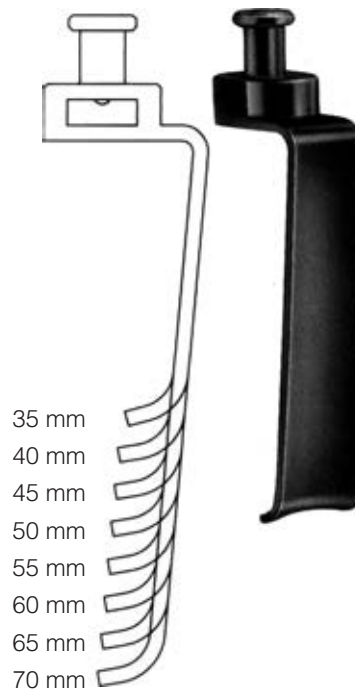

mediale Blätter
 medial blades
 lames médiales
 hojas mediales
 lame mediale

CASPAR

35 mm	18.739.35
40 mm	18.739.40
45 mm	18.739.45
50 mm	18.739.50
55 mm	18.739.55
60 mm	18.739.60
65 mm	18.739.65
70 mm	18.739.70

Lumbal-Wundspreizer

Lumbal retractors

Écarteurs autostatiques lombaires

Separadores lumbales autostáticos

Divaricatori autostatici lombari



CASPAR
17 cm/6¾"

CASPAR

18.744.00

Gegensperrerr komplett, mit 5 Blättern
18.745.40 - 18.745.60

Retractor complete, with 5 blades
18.745.40 - 18.745.60

Écarteur complet avec 5 valves
18.745.40 - 18.745.60

Separador completo con 5 valvas
18.745.40 - 18.745.60

Divaricatore completo con 5 valve
18.745.40 - 18.745.60

18.744.17

Gegensperrerr allein, mit 1 festen Blatt

Retractor only, with 1 fixed blade

Écarteur seul, con 1 valve fixe

Separador suelto, con 1 valva fija

Divaricatore solo, con 1 valve fissa



Blätter geschwärzt
Blades black-finish
Valves de couleur noir
Valvas de color negro
Valve di colore nero

CASPAR

40 mm	18.745.40
45 mm	18.745.45
50 mm	18.745.50
55 mm	18.745.55
60 mm	18.745.60
65 mm	18.745.65
70 mm	18.745.70

Muskelabspreizer für lumbale Bandscheiben Operation
Specula for lumbar vertebral operations
Spéculum pour les opérations de disques vertébrales
Espéculos para las operaciones lumbares de disco intervertebral
Specula per operazioni vertebrale lombare



Blätter geschwärzt
Blades black-finish
Valves de couleur noir
Valvas de color negro
Valve di colore nero

CASPAR

40 mm	18.748.40
45 mm	18.748.45
50 mm	18.748.50
55 mm	18.748.55
60 mm	18.748.60
65 mm	18.748.65
75 mm	18.748.75
85 mm	18.748.85

Hemilaminectomiespreizer

Hemilaminectomy retractors

Écarteurs pour hémilaminectomie

Separadores para hemilaminectomía

Divaricatori per emilaminectomia

18.751.25

Hemilaminectomiespreizer komplett, mit 2 Paar Blätter
Hemilaminectomy retractor complete, with 2 pairs of blades
Écarteur pour hémilaminectomie complet, con 2 paires de valves
Separador para hemilaminectomía completo, con 2 pares de valvas
Divaricatore per emilaminectomia completo, con 2 paio di valve



18.751.24

Rahmen allein
Frame only
Cadre seul
Cuadro suelto
Talaio solo

CLOWARD-HOEN
25 cm/10"

Valvenpaar
Pair of blades
Paire de valves
Par de valvas
Paio di valva

18.751.31
25 - 50 x 55 mm

18.751.32
25 - 50 x 65 mm

18.753.27

Hemilaminectomiespreizer komplett, mit 4 Blätter
Hemilaminectomy retractor complete, with 4 blades
Écarteur pour hémilaminectomie complet, con 4 valves
Separador para hemilaminectomía completo, con 4 valvas
Divaricatore per emilaminectomia completo, con 4 valve



18.753.26

Rahmen allein
Frame only
Cadre seul
Cuadro suelto
Talaio solo

HOEN
27 cm/10¾"

Valve allein
Blade only
Valve seule
Valva suelta
Valva solo



18.753.32
45 x 45 mm



18.753.30
45 x 35 mm



18.753.36
25 x 45 mm



18.753.34
25 x 35 mm



MALIS
 19 cm/7½"

18.860.19

Spreizer ohne Valven
 Retractor without blades
 Écarteur sans valves
 Separador sin valvas
 Divaricatore senza valve

18.861.00

Sperrer komplett
 Retractor complete
 Écarteur complet
 Separador completo
 Divaricatore completo

Fixiervorrichtung
 Fixation device
 Dispositiv de fixation
 Dispositivo de fijación
 Dispositivo di fissaggio



18.861.01

Stellarm
 Adjustable arm
 Bras réglable
 Soporte ajustable
 Braccio regolabile



18.861.02



18.862.09
 9 cm/3½"



18.862.12
 12 cm/4¾"



18.862.15
 15 cm/6"



18.863.09
 9 x 70 mm



18.863.14
 14 x 70 mm



18.863.16
 16 x 70 mm



18.863.19
 19 x 70 mm



18.863.25
 25 x 70 mm

Valven für MALIS
 Blades for MALIS
 Valves pour MALIS
 Valvas para MALIS
 Valve per MALIS

Wundspreizer

Wound spreaders, self-retaining
Écarteurs autostatiques
Separadores autostáticos
Divaricatori autostatici



18.870.19

Spreizer ohne Valven
Retractor without blades
Écarteur sans valves
Separador sin valvas
Divaricatore senza valve

18.870.00

Sperrer komplett, bestehend aus:
Retractor complete, consisting of:
Écarteur complet, composé de:
Separador completo, compuesto de:
Divaricatore completo, costituito da:

1 x	18.870.19
2 x	18.871.01
2 x	18.871.02
1 x	18.873.16
1 x	18.873.20
1 x	18.873.25
1 x	18.875.05
1 x	18.875.11
1 x	18.875.21

JANNETTA
19 cm/7½"

Fixiervorrichtung
Fixation device
Dispositif de fixation
Dispositivo de fijación
Dispositivo di fissaggio



18.871.01



18.871.02

Valven für JANNETTA
Blades for JANNETTA
Valves pour JANNETTA
Valvas para JANNETTA
Valve per JANNETTA



16 x 70 mm	18.873.16
20 x 70 mm	18.873.20
25 x 70 mm	18.873.25

5 x 90 mm	18.875.05
11 x 90 mm	18.875.11
21 x 90 mm	18.875.21

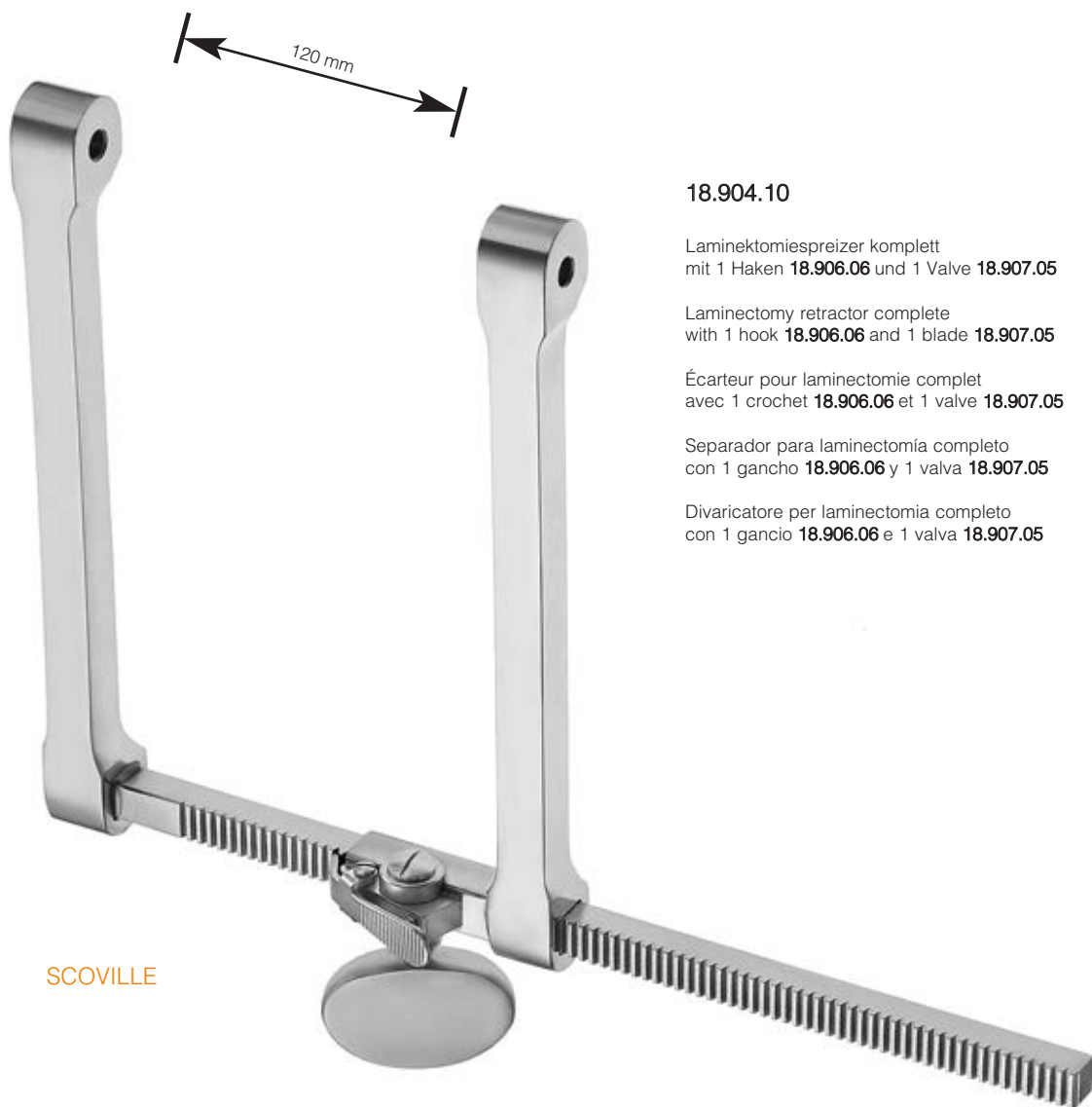

18.904.10

Laminektomiespreizer komplett
mit 1 Haken **18.906.06** und 1 Valve **18.907.05**

Laminectomy retractor complete
with 1 hook **18.906.06** and 1 blade **18.907.05**

Écarteur pour laminectomie complet
avec 1 crochet **18.906.06** et 1 valve **18.907.05**

Separador para laminectomía completo
con 1 gancho **18.906.06** y 1 valva **18.907.05**

Divaricatore per laminectomia completo
con 1 gancio **18.906.06** e 1 valva **18.907.05**

18.904.00

Rahmen allein
Frame only
Cadre seul
Cuadro suelto
Talaio solo

SCOVILLE



18.905.00

Laminektomiespreizer komplett
 mit 1 Haken **18.906.06** und 1 Valve **18.907.05**

Laminectomy retractor complete
 with 1 hook **18.906.06** and 1 blade **18.907.05**

Écarteur pour laminectomie complet
 avec 1 crochet **18.906.06** et 1 valve **18.907.05**

Separador para laminectomía completo
 con 1 gancho **18.906.06** y 1 valva **18.907.05**

Divaricatore per laminectomia completo
 con 1 gancio **18.906.06** e 1 valva **18.907.05**

18.905.10

Rahmen allein
 Frame only
 Cadre seul
 Cuadro suelto
 Talaio solo



VALIN

18.906.00

Laminektomiespreizer komplett
 mit 1 Haken **18.906.06** und 1 Valve **18.907.05**

Laminectomy retractor complete
 with 1 hook **18.906.06** and 1 blade **18.907.05**

Écarteur pour laminectomie complet
 avec 1 crochet **18.906.06** et 1 valve **18.907.05**

Separador para laminectomía completo
 con 1 gancho **18.906.06** y 1 valva **18.907.05**

Divaricatore per laminectomia completo
 con 1 gancio **18.906.06** e 1 valva **18.907.05**

18.906.09

Rahmen allein
 Frame only
 Cadre seul
 Cuadro suelto
 Talaio solo

Hakenvalve, spitz
 Hook, sharp
 Valve à griffes, pointu
 Gancho, agudo
 Gancio, acuto



SCOVILLE

50 mm	18.906.01
70 mm	18.906.02
75 mm	18.906.03

Hakenvalve, stumpf
 Hook, blunt
 Valve à griffes, mousse
 Gancho, romo
 Gancio, smusso



SCOVILLE

50 mm	18.906.06
70 mm	18.906.07
75 mm	18.906.08



TAYLOR

47 x 37 mm	3 Z.	18.906.40
48 x 50 mm	4 Z.	18.906.41
64 x 50 mm	4 Z.	18.906.42
64 x 64 mm	4 Z.	18.906.43
80 x 57 mm	4 Z.	18.906.44



SCOVILLE

41 x 38 mm	18.906.46
67 x 44 mm	18.906.47



SCOVILLE

50 x 25 mm	18.907.01
50 x 50 mm	18.907.02
57 x 25 mm	18.907.03
57 x 38 mm	18.907.04
64 x 25 mm	18.907.05
64 x 29 mm	18.907.06
64 x 50 mm	18.907.07
67 x 28 mm	18.907.08
67 x 30 mm	18.907.09
75 x 25 mm	18.907.10
75 x 50 mm	18.907.11
88 x 25 mm	18.907.12
100 x 50 mm	18.907.13



MEYERDING

44 x 25 mm	18.909.44
50 x 25 mm	18.909.50
57 x 25 mm	18.909.57
70 x 25 mm	18.909.70
75 x 25 mm	18.909.75
83 x 25 mm	18.909.83
88 x 50 mm	18.909.88



HIBBS

50 x 19 mm	18.910.01
50 x 25 mm	18.910.02
50 x 50 mm	18.910.03
64 x 25 mm	18.910.04
64 x 38 mm	18.910.05
75 x 25 mm	18.910.06
75 x 38 mm	18.910.07
75 x 50 mm	18.910.08
75 x 64 mm	18.910.09
88 x 25 mm	18.910.10
88 x 38 mm	18.910.11
100 x 25 mm	18.910.12
100 x 50 mm	18.910.13



TAYLOR

75 x 32 mm	18.912.01
100 x 42 mm	18.912.02

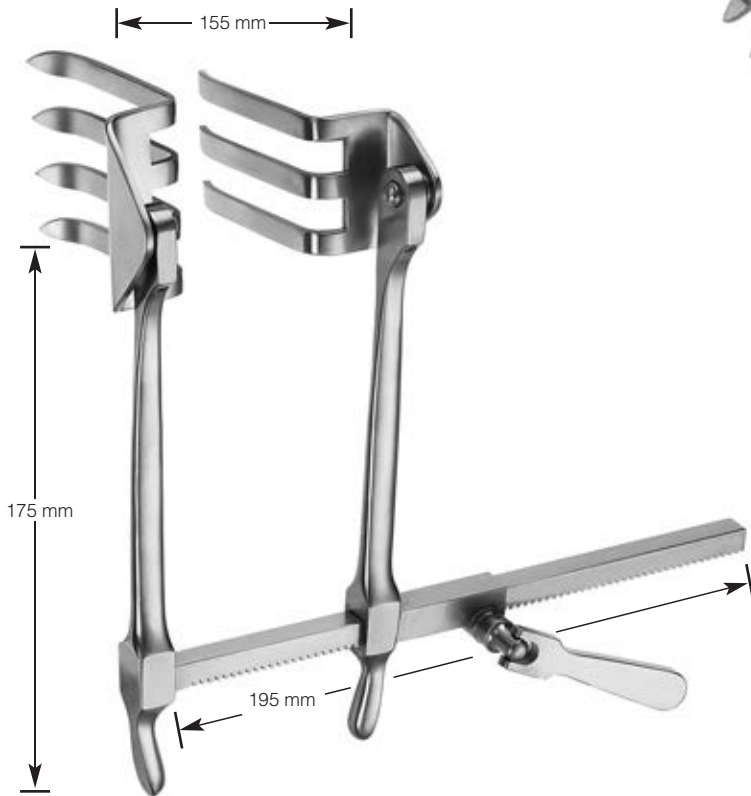

SCOVILLE-RICHTER
18.948.00

Laminektomiespreizer komplett
 mit 1 Paar Valven **18.948.11**

Laminectomy retractor complete
 with 1 pair of blades **18.948.11**

Écarteur pour laminectomie complet
 avec 1 paire de valves **18.948.11**

Separador para laminectomía completo
 con 1 par de valvas **18.948.11**

Divaricatore per laminectomia completo
 con 1 paio di valve **18.948.11**

18.948.10

Rahmen allein
 Frame only
 Cadre seul
 Cuadro suelto
 Talaio solo



62 x 52 mm

62 x 37 mm

18.948.11

Paar
 Pair
 Paire
 Par
 Paio



18.948.12
 47 x 51 mm

Paar
 Pair
 Paire
 Par
 Paio



18.948.13
 30 x 40 mm

Paar
 Pair
 Paire
 Par
 Paio



18.948.14
 37 x 62 mm

Paar
 Pair
 Paire
 Par
 Paio

Laminektomiespreizer
 Laminectomy retractors
 Écarteurs pour laminectomie
 Separadores para laminectomía
 Divaricatori per laminectomia



mit Sperre
 with ratchet
 avec cremaillère
 con cierre
 con serratura

CLOWARD
40.401.16
 16 cm/6¼"

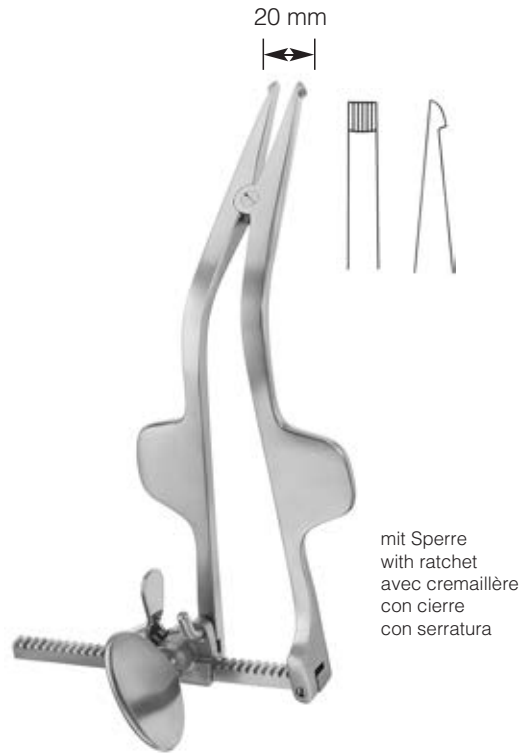

mit Sperre
 with ratchet
 avec cremaillère
 con cierre
 con serratura

CLOWARD
40.402.15
 15 cm/6"

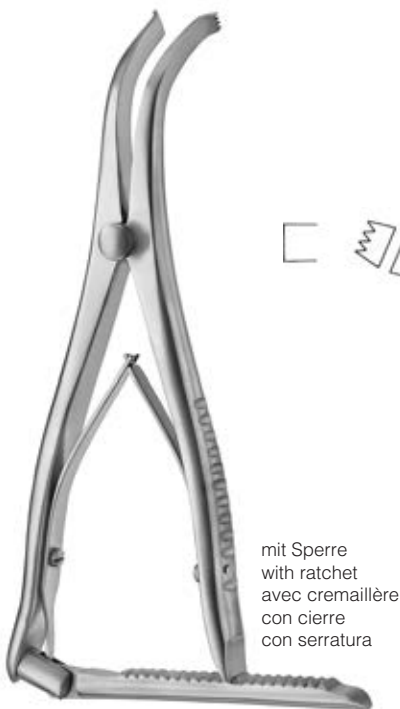

mit Sperre
 with ratchet
 avec cremaillère
 con cierre
 con serratura

INGE

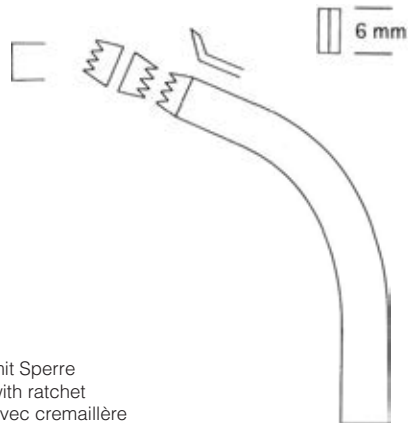

40.405.17
 17 cm/6¾"

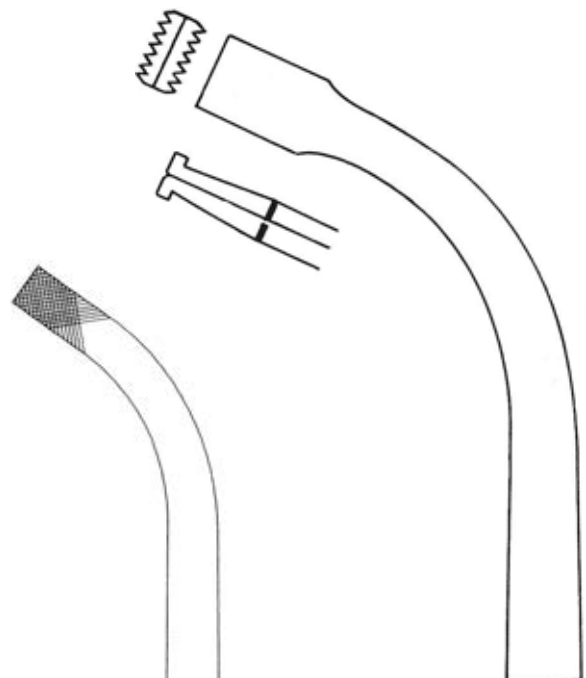

40.406.17
 17 cm/6¾"

40.405.27
 27 cm/10¾"

09



◆ **NADELHALTER**

NEEDLE HOLDERS

PORTE-AIGUILLES

PORTA-AGUJAS

PORT'AGHI







Nadelhalter mit Hartmetalleinlagen

Needle holders with tungsten carbide inserts
 Porte-aiguilles avec inserts en carbure tungstène
 Porta-agujas con plaquitas de carburo tungsteno
 Portaghi con morsi in carburo tungsteno

mit TC-Einsätzen
 with TC inserts
 avec mors TC
 con bocas TC
 con morso TC

Folgende Hartmetalleinlagen werden für **DIMEDA TC** Nadelhalter verwendet:
 The **DIMEDA TC** needle holders are equipped with the following tungsten carbide inserts:
 Les inserts suivants en metal dur sont utilisés pour les porte-aiguilles **DIMEDA TC**:
 Las porta-agujas **DIMEDA TC** están equipadas con las siguientes plaquitas de carburo de tungsteno:
 I portaghi **DIMEDA TC** dispongono delle seguenti placche in carburo di tungsteno:

		Teilung Structure Structure Estriatura Struttura	empfohlen für Nahtmaterial recommended for suture material recommandé pour matériel de suture recomandado para suturas raccomodato per materiale di suture
	normal regular regulaire regular regolare	0,5 mm	> 3,0
	mini mini mini mini mini	0,4 mm	4,0 - 6,0
	mikro micro micro micro micro	0,3 mm	7,0 - 10,0
	glatt smooth lisse lisa piatta	--	7,0 - 10,0

mit aufgebogenem Daumenring
with offset ring
à anneau décalé
con anillo acodado
con anelli sfalsati

mit TC-Einsätzen
with TC inserts
avec mors TC
con bocas TC
con morso TC

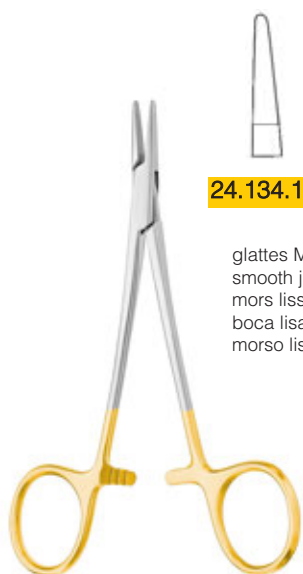

24.134.13

glattes Maul
smooth jaw
mors lisse
boca lisa
morso liscio

HALSEY
13 cm/5 1/8"



24.144.13

0,4
Miniprofil
Mini profile
Profil mini
Perfil mini
Profilo mini



24.147.13

0,4
Miniprofil
Mini profile
Profil mini
Perfil mini
Profilo mini

NEIVERT
13 cm/5 1/8"



24.147.13L

für Linkshänder
for left-handed
pour les gauchers
para zurdos
per mancini



0,5

Normalprofil
Regular profile
Profil regulare
Perfil regular
Profilo regolare

BAUMGARTNER
12,5 cm/5" **24.154.12**
14 cm/5 1/2" **24.154.14**



CRILE WOOD
15 cm/6" **24.160.15**
18 cm/7" **24.160.18**
20 cm/8" **24.160.20**
23 cm/9" **24.160.23**



0,4
Miniprofile
Mini profile
Profil mini
Perfil mini
Profilo mini

CRILE WOOD



24.164.15
15 cm/6"



24.164.15L
15 cm/6"



24.164.18
18 cm/7"



24.164.20
20 cm/7 3/4"

für Linkshänder
for left-handed
pour les gauchers
para zurdos
per mancini

mit TC-Einsätzen
 with TC inserts
 avec mors TC
 con bocas TC
 con morso TC



BABY CRILE WOOD
24.168.15
 15 cm/6"

0,4
 Miniprofil
 Mini profile
 Profil mini
 Perfil mini
 Profilo mini



MAYO HEGAR



24.184.14
 14 cm/5½"



24.184.16
 16 cm/6¼"



24.184.18
 18 cm/7"



24.184.20
 20 cm/8"



24.184.24
 24 cm/9½"



24.184.26
 26 cm/10¼"



24.184.30
 30 cm/12"

0,5
 Normalprofil
 Regular profile
 Profile regulare
 Perfil regular
 Profilo regolare



24.186.16
 16 cm/6¼"



24.186.18
 18 cm/7"

glattes Maul
 smooth jaw
 mors lisse
 boca lisa
 morso piatto



DE BAKEY
24.212.16
 16,5 cm/6½"

0,4
 Miniprofil
 Mini profile
 Profil mini
 Perfil mini
 Profilo mini



DE BAKEY



24.214.15
 15 cm/6"



24.214.18
 18 cm/7"



24.214.20
 20 cm/8"



24.214.23
 24 cm/9"



24.214.26
 26 cm/10¼"



24.214.31
 31 cm/12½"



24.214.37
 37 cm/14¾"

0,4
 Miniprofil
 Mini profile
 Profil mini
 Perfil mini
 Profilo mini

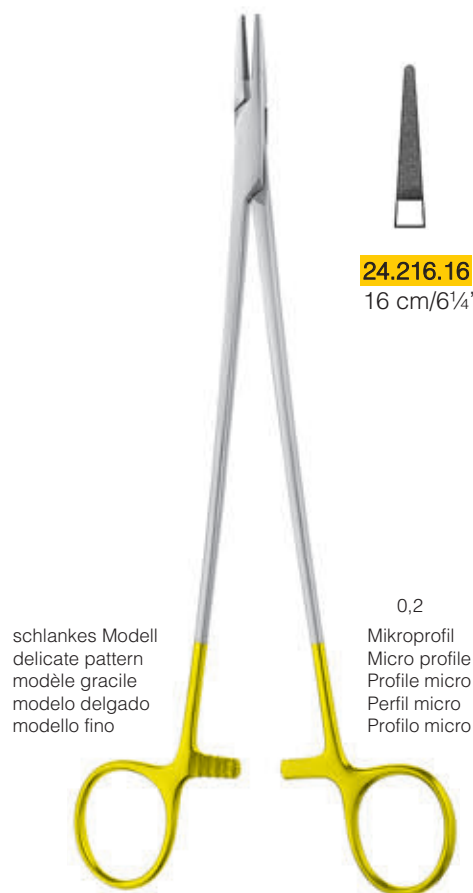

schlankes Modell
delicate pattern
modèle gracile
modelo delgado
modello fino

0,2
Mikroprofil
Micro profile
Profilo micro
Perfil micro
Profilo micro

DE BAKEY

24.216.16
16 cm/6¼"

24.216.18
18 cm/7"

24.216.21
21 cm/8¼"

24.216.23
23 cm/9"

0,4
Miniprofil
Mini profile
Profil mini
Perfil mini
Profilo mini

mit TC-Einsätzen
with TC inserts
avec mors TC
con bocas TC
con morso TC

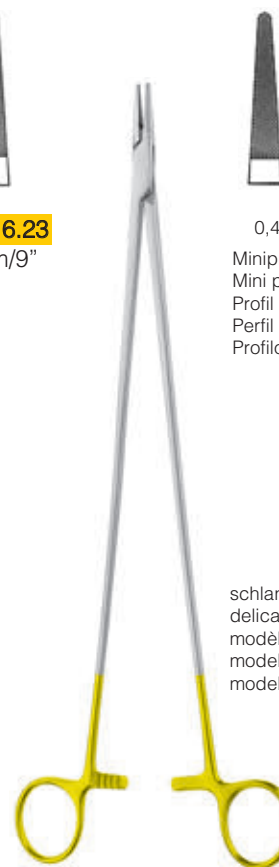

schlankes Modell
delicate pattern
modèle gracile
modelo delgado
modello fino

DE BAKEY
24.216.31
31 cm/12½"



RYDER

24.224.13
13 cm/5"

24.224.15
15 cm/6"

24.224.18
18 cm/7"

24.224.20
20 cm/8"

24.224.23
23 cm/9"

24.224.26
26 cm/10¼"

0,4
Miniprofil
Mini profile
Profil mini
Perfil mini
Profilo mini



RYDER VASCULAR

24.226.13
12,5 cm/5"

24.226.15
15,5 cm/6"

24.226.18
17,5 cm/7"

24.226.20
20 cm/8"

24.226.23
22,5 cm/9"

24.226.26
26 cm/10¼"

0,3
Mikroprofil
Micro profile
Profilo micro
Perfil micro
Profilo micro

schlankes Modell
delicate pattern
modèle gracile
modelo delgado
modello fino

Nadelhalter
 Needle holders
 Porte-aiguilles
 Porta-agujas
 Port'aghi

mit TC-Einsätzen
 with TC inserts
 avec mors TC
 con bocas TC
 con morso TC



JULIAN
 24.247.20
 20 cm/8"



TOENNIS
 24.364.18
 18 cm/7"

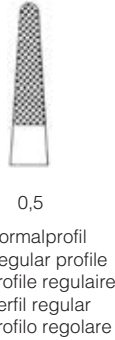

LANGENBECK

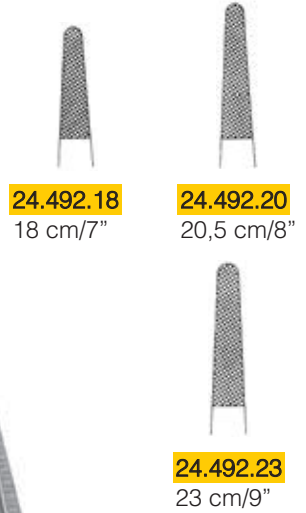

MATHIEU

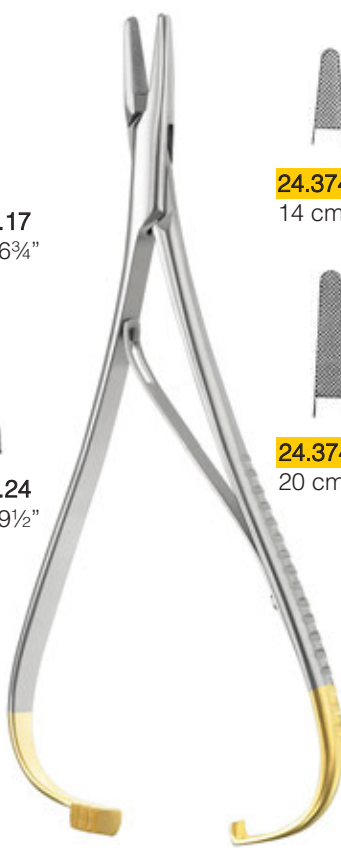
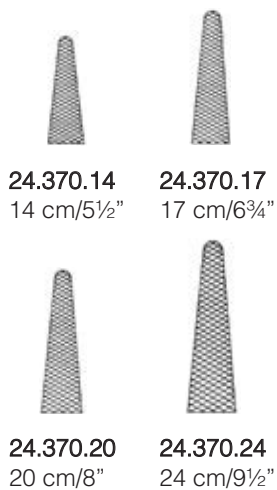

MATHIEU

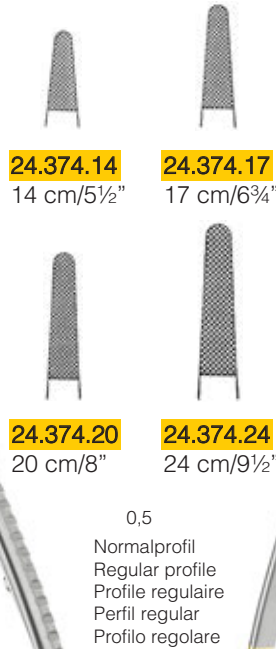

MATHIEU

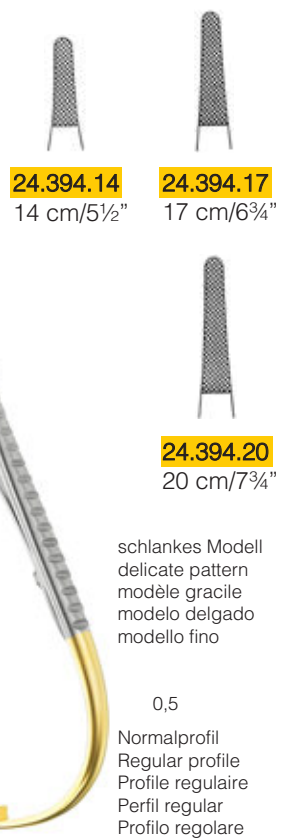



ohne Sperre
 without catch
 sans crémaillère
 sin cierre
 senza serratura



12 cm/4¾"	24.652.12	24.655.12	24.661.12
15 cm/6"	24.654.15	24.655.15	
18,5 cm/7¼"	24.656.18	24.653.18	



mit Sperre
 with catch
 avec crémaillère
 con cierre
 con serratura



12 cm/4¾"	24.662.12	24.667.12	24.663.12
15 cm/6"	24.664.15	24.667.15	
18,5 cm/7¼"	24.666.18	24.667.18	
23 cm/9"		24.667.23	



24.650.10 24.651.10

ohne Sperre
 without catch
 sans crémaillère
 sin cierre
 senza serratura

BARRAQUER
 10 cm/4"



24.636.10 24.637.10

mit Sperre
 with catch
 avec crémaillère
 con cierre
 con serratura

BARRAQUER-TROUTMAN
 10 cm/4"



24.672.09 24.673.09

ohne Sperre
 without catch
 sans crémaillère
 sin cierre
 senza serratura

CASTROVIEJO
 9 cm/3½"



24.674.09 24.675.09

mit Sperre
 with catch
 avec crémaillère
 con cierre
 con serratura

CASTROVIEJO
 9 cm/3½"



24.670.14



24.671.14

mit Sperre
with catch
avec crémaillère
con cierre
con serratura

CASTROVIEJO
14 cm/5½"



24.676.14



24.677.14

ohne Sperre
without catch
sans crémaillère
sin cierre
senza serratura

CASTROVIEJO
14 cm/5½"

Mikro-Nadelhalter

Micro needle holders
 Micro porte-aiguilles
 Micro porta-agujas
 Micro port'aghi

mit TC-Einsätzen
 with TC inserts
 avec mors TC
 con bocas TC
 con morso TC



glattes Maul
 smooth jaw
 mors lisse
 boca lisa
 morso liscio

Mikroprofil
 Micro profile
 Profil micro
 Perfil micro
 Profilo micro

diamantiertes Maul
 diamond-coated jaw
 mors diamanté
 boca diamantada
 morso diamantato

mit Sperre
 with catch
 avec crémaillère
 con cierre
 con serratura



0,3

0,3

14,5 cm/5¾"	24.674.14	24.675.14	24.678.14	24.679.14	24.682.14	24.683.14
18 cm/7"	24.674.18	24.675.18	24.678.18	24.679.18	24.682.18	24.683.18
21 cm/8¼"	24.674.21	24.675.21	24.678.21	24.679.21	24.682.21	24.683.21
23 cm/9"	24.674.23	24.675.23	24.678.23	24.679.23		

glattes Maul
 smooth jaw
 mors lisse
 boca lisa
 morso liscio

Mikroprofil
 Micro profile
 Profil micro
 Perfil micro
 Profilo micro

diamantiertes Maul
 diamond-coated jaw
 mors diamanté
 boca diamantada
 morso diamantato

ohne Sperre
 without catch
 sans crémaillère
 sin cierre
 senza serratura



0,3

0,3

14,5 cm/5¾"	24.694.14	24.695.14	24.698.14	24.699.14	24.696.14	24.697.14
18 cm/7"	24.694.18	24.695.18	24.698.18	24.699.18	24.696.18	24.697.18
21 cm/8¼"	24.694.21	24.695.21	24.698.21	24.699.21	24.696.21	24.697.21
23 cm/9"	24.694.23	24.695.23	24.698.23	24.699.23		

CASTROVIEJO-JACOBSON

mit TC-Einsätzen
 with TC inserts
 avec mors TC
 con bocas TC
 con morso TC



TOLEDO

glattes Maul
 smooth jaw
 mors lisse
 boca lisa
 morso liscio

Mikroprofil
 Micro profile
 Profil micro
 Perfil micro
 Profilo micro

diamantiertes Maul
 diamond-coated jaw
 mors diamanté
 boca diamantada
 morso diamantato

mit Sperre
 with catch
 avec crémaillère
 con cierre
 con serratura



0,3

0,3

14 cm/5½"	24.774.14	24.775.14	24.778.14	24.779.14	24.782.14	24.783.14
18 cm/7"	24.774.18	24.775.18	24.778.18	24.779.18	24.782.18	24.783.18
21 cm/8¼"	24.774.21	24.775.21	24.778.21	24.779.21	24.782.21	24.783.21
23 cm/9"	24.774.23	24.775.23	24.778.23	24.779.23	24.782.23	24.783.23

glattes Maul
 smooth jaw
 mors lisse
 boca lisa
 morso liscio

Mikroprofil
 Micro profile
 Profil micro
 Perfil micro
 Profilo micro

diamantiertes Maul
 diamond-coated jaw
 mors diamanté
 boca diamantada
 morso diamantato

ohne Sperre
 without catch
 sans crémaillère
 sin cierre
 senza serratura



0,3

0,3

14 cm/5½"	24.794.14	24.795.14	24.798.14	24.799.14	24.796.14	24.797.14
18 cm/7"	24.794.18	24.795.18	24.798.18	24.799.18	24.796.18	24.797.18
21 cm/8¼"	24.794.21	24.795.21	24.798.21	24.799.21	24.796.21	24.797.21
23 cm/9"	24.794.23	24.795.23	24.798.23	24.799.23	24.796.23	24.797.23

- ergonomischer Griff
- ansprechendes Design
- sichere und feinfühlig Handhabung
- leichtes Reinigen
- keine schmutzanfälligen Riefelungen

- ergonomic handle
- sophisticated design
- safe and fine feeling in hand, well balanced
- easy to clean
- no dirt catching knurlings

- poignée ergonomique
- aspect attrayant
- une manipulation délicate et en sécurité
- la précision du geste opératoire
- un nettoyage facile
- striure pas sensible à la saleté

- mango ergonómico
- diseño llamativo
- manipulación seguro y delicado
- limpieza fácil
- las estriadas no son susceptible a la suciedad

- manico ergonomico
- design appariscente
- maneggio sicuro e delicato
- purificazione facile
- non incline de la sporcizia

Mikro-Nadelhalter
 Micro needle holders
 Micro porte-aiguilles
 Micro porta-agujas
 Micro port'aghi

mit TC-Einsätzen
 with TC inserts
 avec mors TC
 con bocas TC
 con morso TC



glattes Maul
 smooth jaw
 mors lisse
 boca lisa
 morso liscio

24.684.13

0,4
 Miniprofil
 Mini profile
 Profil mini
 Perfil mini
 Profilo mini

24.686.13

mit Sperre
 with lock
 avec crémaillère
 con cierre
 con fermo

CASTROVIEJO
 13 cm/5"



24.690.16
 16 cm/6¼"



24.691.16
 16 cm/6¼"

24.690.18
 18,5 cm/7¼"

24.691.18
 18,5 cm/7¼"

24.693.16
 16 cm/6¼"
 diamantiertes Maul
 diamond-coated jaw
 mors diamanté
 boca diamantada
 morso diamantato



24.711.16
 16,5 cm/6½"

24.710.20
 20 cm/8"

24.711.20
 20cm/8"

24.710.22
 22,5 cm/9"

24.711.22
 22,5 cm/9"

24.711.24
 24cm/9½"

YASARGIL



JACOBSON
 18 cm/7"



24.720.18
 ohne Sperre
 without catch
 sans crémaillère
 sin cierre
 senza serratura



24.722.18
 mit Sperre
 with catch
 avec crémaillère
 con cierre
 con serratura

Leichtmetall Rundgriffe, gut ausbalanciert
 Light-weight round handles, well balanced
 Manches ronds en métal léger, bien équilibrés
 Mangos redondos de metal ligero, bien equilibrados
 Manici rotondi metallo leggero, equilibrio perfetto



18,5 cm/7¼"

ohne Sperre
 without catch
 sans crémaillère
 sin cierre
 senza serratura



15 cm/6"	24.870.15	24.871.15
18 cm/7"	24.870.18	24.871.18

mit Sperre
 with catch
 avec crémaillère
 con cierre
 con serratura



15 cm/6"	24.872.15	24.873.15
18 cm/7"	24.872.18	24.873.18

Mikro-Nadelhalter

Micro needle holders
Micro porte-aiguilles
Micro porta-agujas
Micro port'aghi

diamantiertes Maul
diamond-coated jaw
mors diamanté
boca diamantada
morso diamantato

mit Sperre
with catch
avec crémaillère
con cierre
con serratura



11 x 0,8 mm

mit Sperre
with catch
avec crémaillère
con cierre
con serratura



11 x 0,8 mm

ohne Sperre
without catch
sans crémaillère
sin cierre
senza serratura



11 x 0,8 mm

ohne Sperre
without catch
sans crémaillère
sin cierre
senza serratura



11 x 0,8 mm

18 cm/7"	24.920.18			24.923.18
21 cm/8¼"	24.920.21	24.921.21	24.922.21	24.923.21

Titan
Titanium
Titane
Titanio
Titanio



10



◆ ORTHOPÄDIE, BOHRAPPARATE
ORTHOPEDICS, DRILLS
ORTHOPÉDIE, PERFORATEURS
ORTOPEDÍA, PERFORADORES
ORTOPEDIA, PERFORATORI

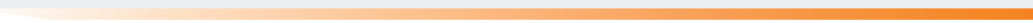

Hohlmeißelzangen

Bone rongeurs
Pincas-gouges
Pinzas-gubias
Pinze sgorbie



FRIEDMAN MINI
32.101.12
12 cm/5"



FRIEDMAN
32.101.14
14 cm/5½"



MEAD
32.109.16
16,5 cm/6½"



CLEVELAND
32.103.14
14 cm/5½"



CLEVELAND
32.105.17
17 cm/6¾"



MEAD
32.107.16
16 cm/6¼"

Hohlmeißelzangen

Bone rongeurs
Pincas-gouges
Pinzas-gubias
Pinze sgorbie

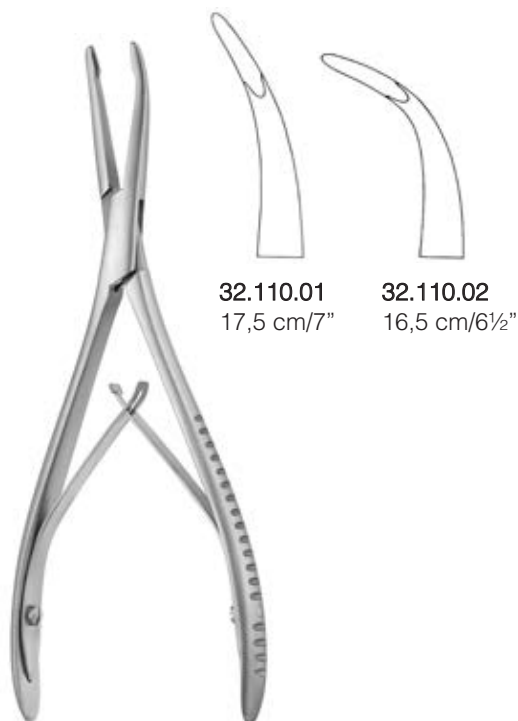

32.110.01
17,5 cm/7"

32.110.02
16,5 cm/6½"

STELLBRINK

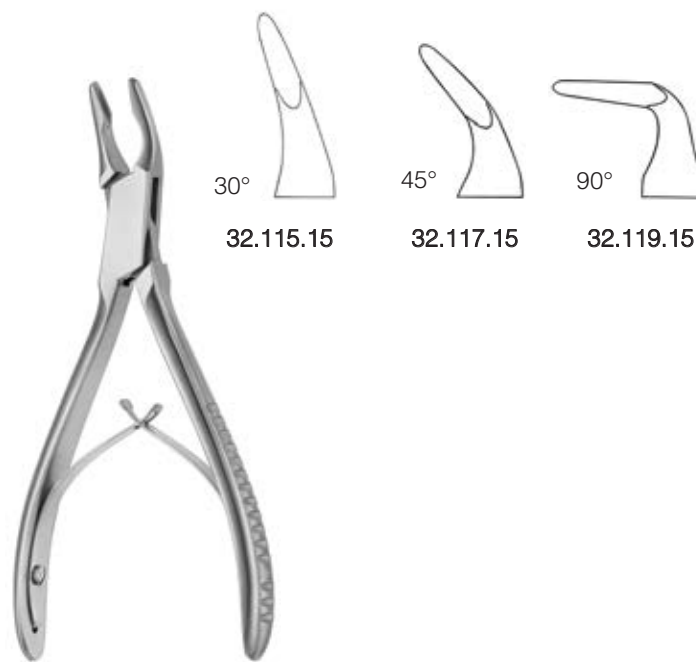

30°
32.115.15

45°
32.117.15

90°
32.119.15

BLUMENTHAL
15,5 cm/6¼"

Synovectomie-zangen
Synovectomy rongeurs
Synovectomie pincas-gouges
Synovectomy pinzas-gubias
Synovectomy pinze sgorbie

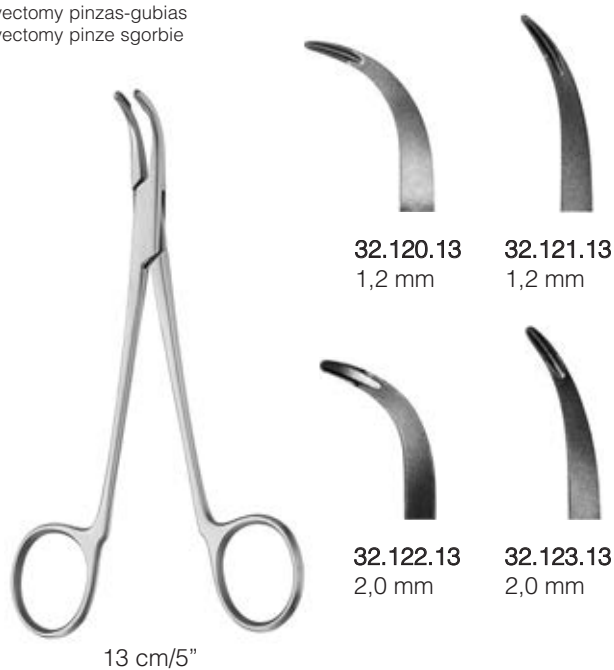

32.120.13
1,2 mm

32.121.13
1,2 mm

32.122.13
2,0 mm

32.123.13
2,0 mm

13 cm/5"

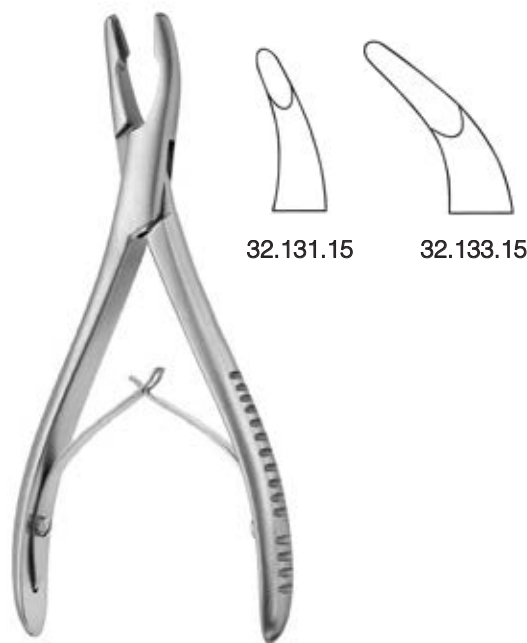

32.131.15

32.133.15

LUER
15 cm/6"

Hohlmeißelzangen

Bone rongeurs
Pincas-gouges
Pinzas-gubias
Pinze sgorbie



BANE-HARTMANN
32.135.18
18 cm/7"

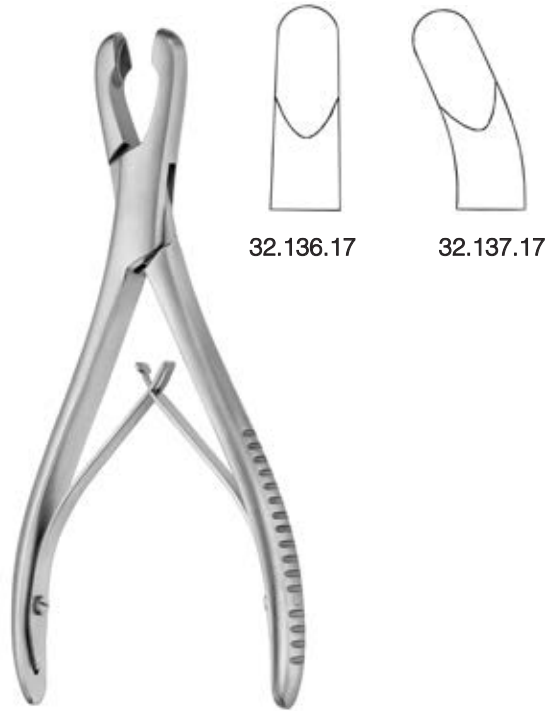

LUER
17 cm/6¾"

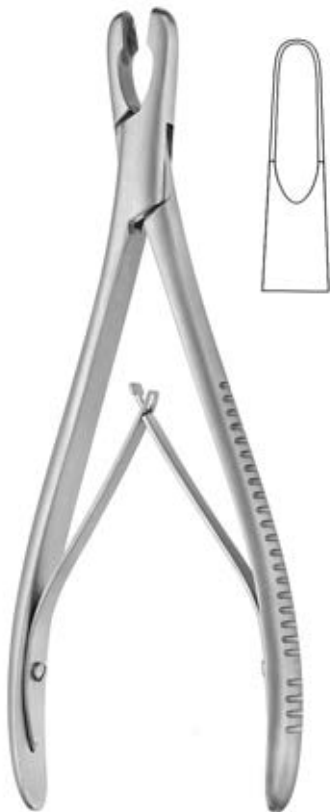

ADSON
20 cm/8" 32.142.20 32.143.20



OLIVECRONA
32.147.20
20 cm/8"

Hohlmeißelzangen

Bone rongeurs
Pinces-gouges
Pinzas-gubias
Pinze sgorbie



LEMPERT
18,5 cm/7¼"



BEYER
32.159.18
18 cm/7"

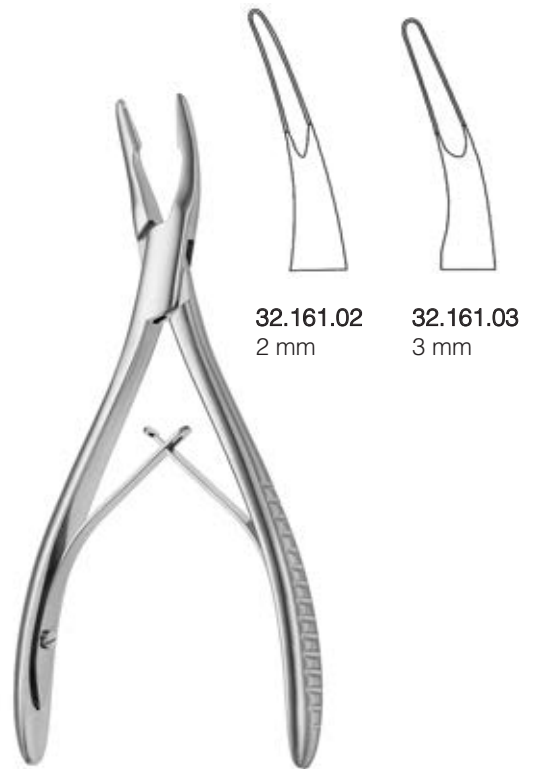

BEYER
32.161.02
17 cm/6¾"

seitwärts abgewinkelt
angled to side
coudés latéralement
acodadas hacia el lado
angolata lateralmente



BACON
32.165.20
20 cm/8"

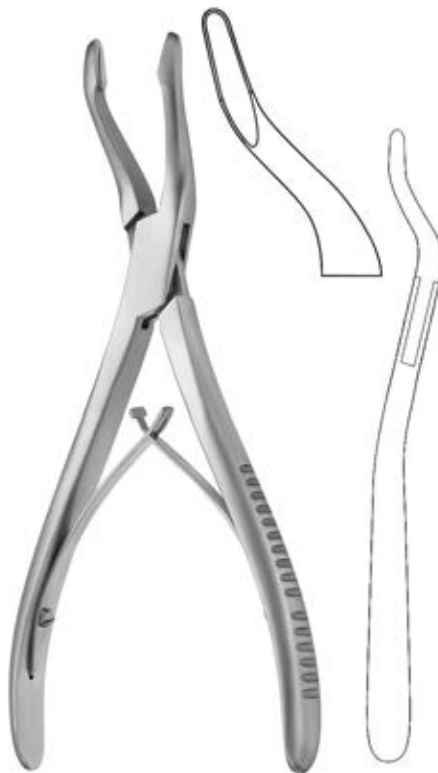

JANSEN
32.167.19
19 cm/7½"



GULEKE
32.169.20
20,5 cm/8¼"

Hohlmeißelzangen

Bone rongeurs
Pincas-gouges
Pinzas-gubias
Pinze sgorbie

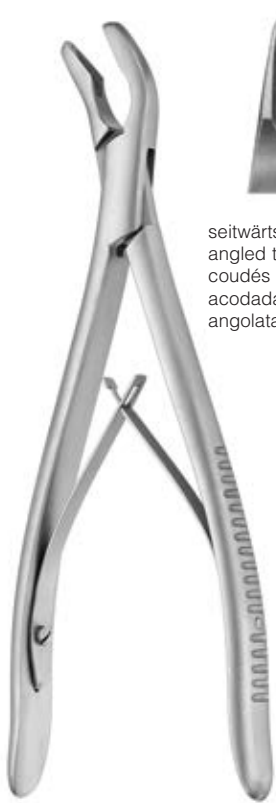

seitwärts abgewinkelt
angled to side
coudés latéralement
acodadas hacia el lado
angolata lateralmente

TROTTER
32.175.20
20,5 cm/8"



NORTHFIELD
32.176.21
21 cm/8¼"



PENNYBAKER
32.178.20
20 cm/8"



MAYFIELD
32.197.17
17 cm/6¾"



BEYER
32.201.18
18 cm/7"



ZAUFAL JANSEN
32.205.18
18 cm/7"



32.209.15
1,7 mm

BOEHLER
15 cm/5¾"



32.210.15
2 mm



32.211.15
2 mm



32.212.15
3 mm



32.213.15
3 mm



MARQUARDT
32.215.20
20 cm/8"



32.21

RUSKIN
18 cm/7"



32.217.18



RUSKIN
32.218.23
23 cm/9"



RUSKIN
32.219.23
23 cm/9"

Hohlmeißelzangen

Bone rongeurs
Pinces-gouges
Pinzas-gubias
Pinze sgorbie

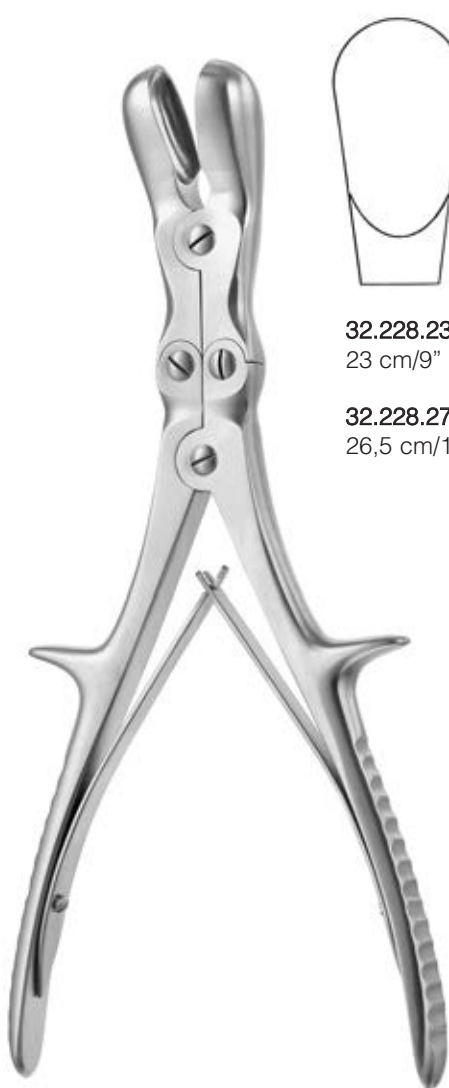

STILLE LUER



32.228.23
23 cm/9"

32.228.27
26,5 cm/10½"



32.229.23
23 cm/9"

32.229.27
26,5 cm/10½"



STILLE LUER



32.230.22
22 cm/8¾"

32.230.26
26 cm/10¼"



32.231.22
22 cm/8¾"

32.231.26
26 cm/10¼"

Hohlmeißelzangen

Bone rongeurs

Pinces-gouges

Pinzas-gubias

Pinze sgorbie



STILLE LUER
32.235.23
23 cm/9"



STILLE RUSKIN
32.237.23
23 cm/9"



SAUERBRUCH
31 cm/12¼"

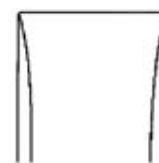

32.241.30



32.243.30

Hohlmeißelzangen

Bone rongeurs
Pincas-gouges
Pinzas-gubias
Pinze sgorbie



LEKSELL (STILLE)
23 cm/9"



LEKSELL
23 cm/9"

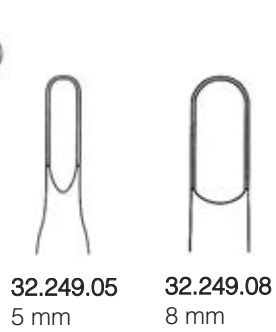

FRYKHOLM
32.255.24
24 cm/9½"

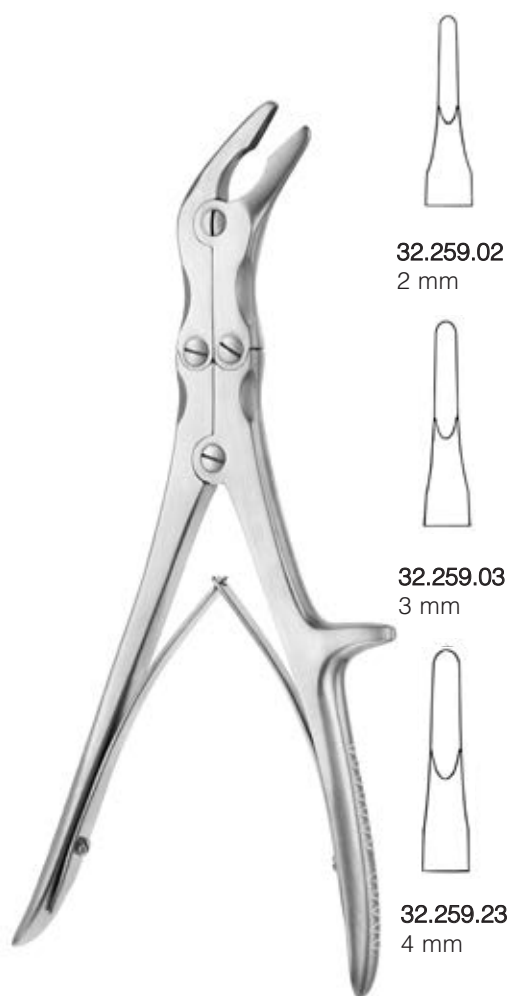

ECHLIN
23 cm/9"

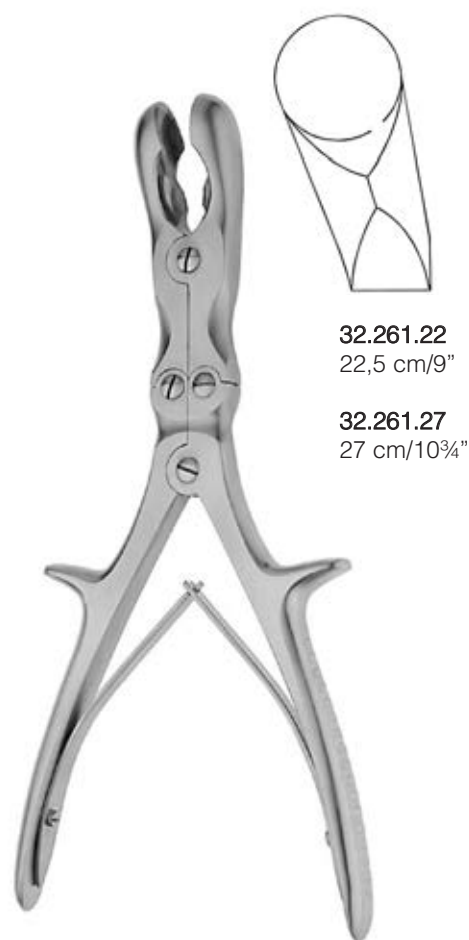

SEMB



SMITH PETERSEN
24 cm/9½"

Knochensplitterzangen
Bone cutting forceps
Pincès coupantes à os
Pinzas cortantes para hueso
Cesoie per ossa



McINDOE
32.284.17
17,5 cm/7"



RUSKIN LISTON
18,5 cm/7¼"



32.286.18



32.289.18



LISTON-KEY-HORSLEY
32.293.27
24,5 cm/9¾"



32.469.96
 Fig. 0000



32.470.02
 Fig. 2



32.480.97
 Fig. 000



32.481.03
 Fig. 3



32.469.97
 Fig. 000



32.470.03
 Fig. 3



32.480.98
 Fig. 00



32.481.04
 Fig. 4



32.469.98
 Fig. 00



32.470.04
 Fig. 4



32.481.00
 Fig. 0



32.481.05
 Fig. 5



32.470.00
 Fig. 0



32.470.05
 Fig. 5



32.481.01
 Fig. 1



32.481.06
 Fig. 6



32.470.01
 Fig. 1



32.470.06
 Fig. 6



32.481.02
 Fig. 2



VOLKMANN
 17 cm/6¾"

oval, mit Hohlheft
 oval, with hollow handle
 ovale, avec manche creux
 ovalada, con mango hueco
 ovale, con manico vuoto



BRUNS
 23 cm/9"

oval, massiv
 oval, solid
 ovale, solide
 ovalada, maciza
 ovale, solida



32.482.01

32.482.02

32.482.03

SCOVILLE
 25 cm/9¾"

oval, mit Hohlheft
 oval, with hollow handle
 ovale, avec manche creux
 ovalada, con mango hueco
 ovala, con manico vuoto

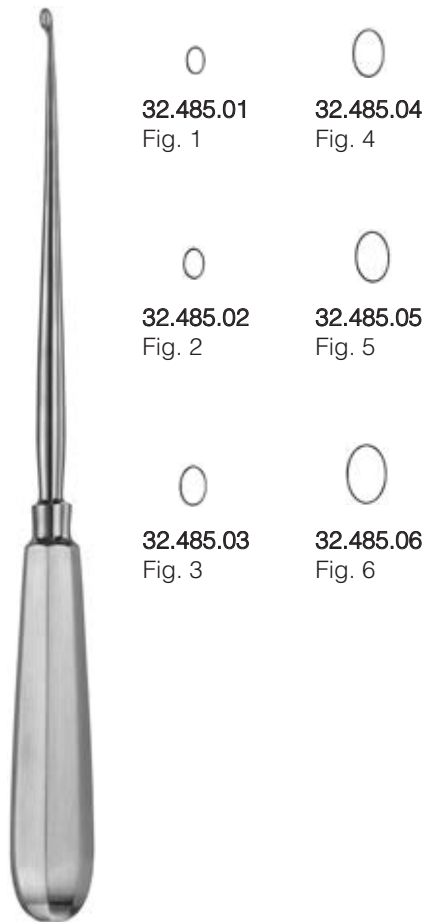

32.485.01
 Fig. 1

32.485.02
 Fig. 2

32.485.03
 Fig. 3

32.485.04
 Fig. 4

32.485.05
 Fig. 5

32.485.06
 Fig. 6

SIMON
 24 cm/9½"

oval, mit Hohlheft
 oval, with hollow handle
 ovale, avec manche creux
 ovalada, con mango hueco
 ovala, con manico vuoto

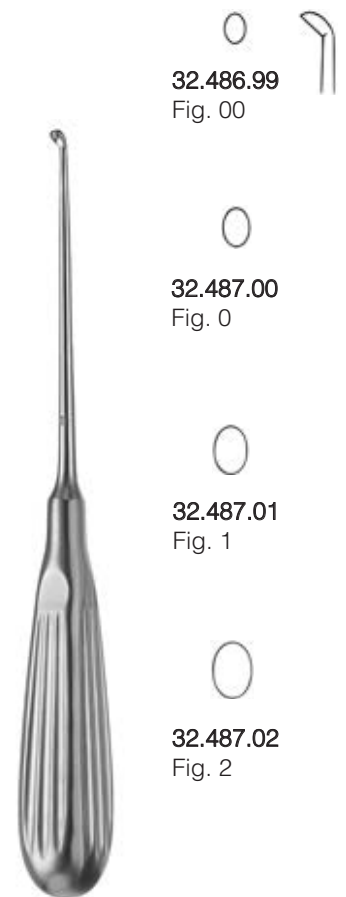

32.486.99
 Fig. 00

32.487.00
 Fig. 0

32.487.01
 Fig. 1

32.487.02
 Fig. 2

DAUBENSPECK
 20 cm/8"



- **32.490.10**
 Fig. 0
- **32.490.20**
 Fig. 00
- **32.490.30**
 Fig. 000
- **32.490.40**
 Fig. 0000
- **32.490.50**
 Fig. 00000

LEMPERT
 21,5 cm/8¼"



- **32.491.01**
 Fig. 1
- **32.491.02**
 Fig. 2
- **32.491.03**
 Fig. 3

oval, biegsamer Schaft, mit Hohlheft
 oval, malleable shaft, with hollow handle
 ovale, avec tige malléable, avec manche creux
 ovalada, vástago maleable, con mango hueco
 ovata, con gambo malleabile, con manico vuoto

HALLE
 21 cm/8¼"

Scharfe Doppellöffel

Bone curettes, double-ended
Curettes doubles
Cucharillas de doble extremo
Curette doppie



32.492.13
13 cm/5"



32.492.16
16 cm/6¼"



32.492.20
20 cm/8"

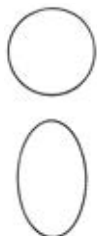

VOLKMANN



32.494.13
13 cm/5"



32.494.14
14 cm/5½"



32.494.17
17 cm/6¾"



32.494.20
20 cm/8"



VOLKMANN



32.496.00
Fig. 00/0



32.496.01
Fig. 0/1



32.496.12
Fig. 1/2



WILLIGER
13,5 cm/5¼"



32.498.00

00

0

32.498.01

0

1

32.498.12

1

2

MARTINI
13,5 cm/5¼"



32.502.21
21 cm/8¼"

Spinal-Fusionsküretten
 Spinal fusion curettes
 Curettes pour la fusion spinal
 Cucharillas para la fusión espinal
 Curette per la fusione spinale



COBB
 28 cm/11"

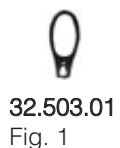

VOLKMANN
 27 cm/10¾"

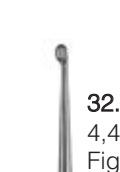
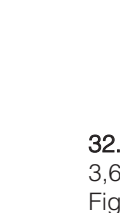
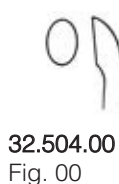

CASPAR
 22 cm/8¾"

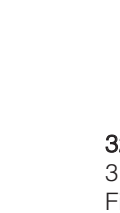

CASPAR
 22 cm/8¾"

CASPAR (CCR)	132 - 136
	179 - 184
Siehe auch Seite:	199
See also page:	212
Voir aussi la page:	228
Véase también la página:	228
Vedere anche pagina:	230



25 cm/9¾"

BUSHE
 25 cm/10"

EPSTEIN
 20 cm/8"

Fig. 0	3,0 mm	32.514.10
Fig. 00	2,5 mm	32.514.20
Fig. 000	2,0 mm	32.514.30

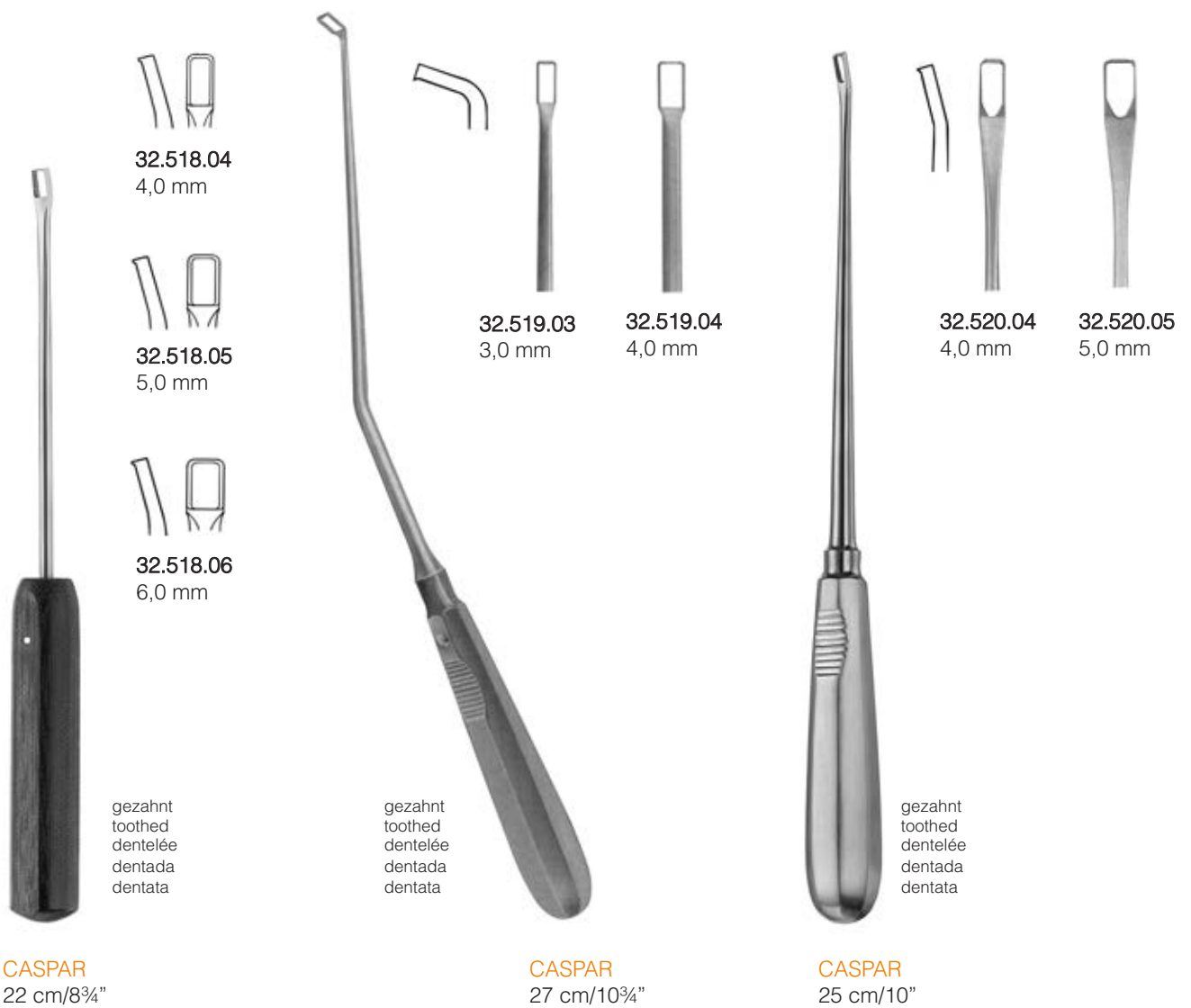

CASPAR
 22 cm/8³/₄"

CASPAR
 27 cm/10³/₄"

CASPAR
 25 cm/10"

CASPAR (CCR)	132 - 136
	179 - 184
Siehe auch Seite:	199
See also page:	212
Voir aussi la page:	228
Véase también la página:	230
Vedere anche pagina:	230

Spinal-Fusionsküretten

Spinal fusion curettes
 Curettes pour la fusion spinal
 Cucharillas para la fusión espinal
 Curette per la fusione spinale

Spinal-Fusionsküretten
 Spinal fusion curettes
 Curettes à fusion spinal
 Cucharillas para la fusión espinal
 Curette per la fusione spinale

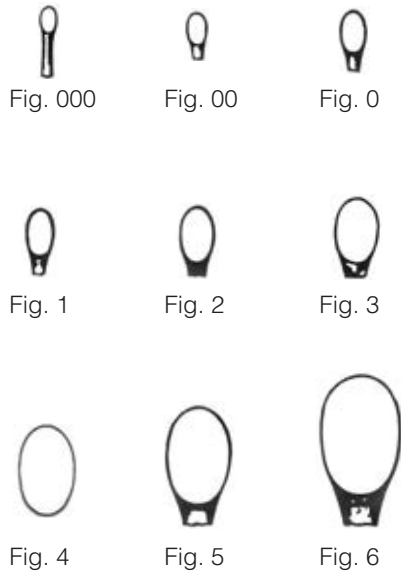

20 cm/8"

gerade
 straight
 droits
 rectas
 rette

20 cm/8"

gebogen
 curved
 courbées
 curvas
 curve

28 cm/11"

gerade
 straight
 droits
 rectas
 rette

Fig. 000	32.521.97	32.524.97	32.529.97
Fig. 00	32.521.98	32.524.98	32.529.98
Fig. 0	32.522.00	32.525.00	32.530.00
Fig. 1	32.522.01	32.525.01	32.530.01
Fig. 2	32.522.02	32.525.02	32.530.02
Fig. 3	32.522.03	32.525.03	32.530.03
Fig. 4	32.522.04	32.525.04	32.530.04
Fig. 5	32.522.05	32.525.05	32.530.05
Fig. 6	32.522.06	32.525.06	32.530.06

Hohlmeißel zur Knorpelentnahme aus der Rippe
 Gouges for taking grafts from the ribs
 Gouges pour la prise de greffons des côtes
 Gubias para la toma de injertos de las costillas
 Sgorbie per l'adozione di innesti dalla costola



28 cm/11"

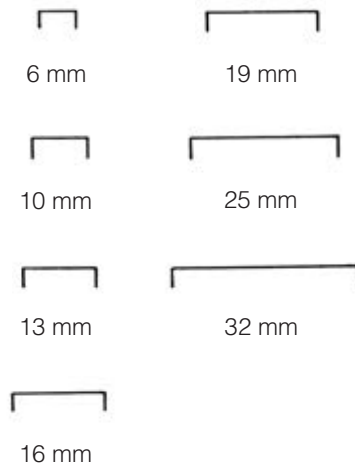

	gerade straight droits rectos rette	gebogen curved courbés curvos curve
6 mm/1/4"	32.550.06	32.551.06
10 mm/3/8"	32.550.10	32.551.10
13 mm/1/2"	32.550.13	32.551.13
16mm/5/8"	32.550.16	32.551.16
19 mm/3/4"	32.550.19	32.551.19
25 mm/1"	32.550.25	32.551.25
32 mm/1 1/4"	32.550.32	32.551.32

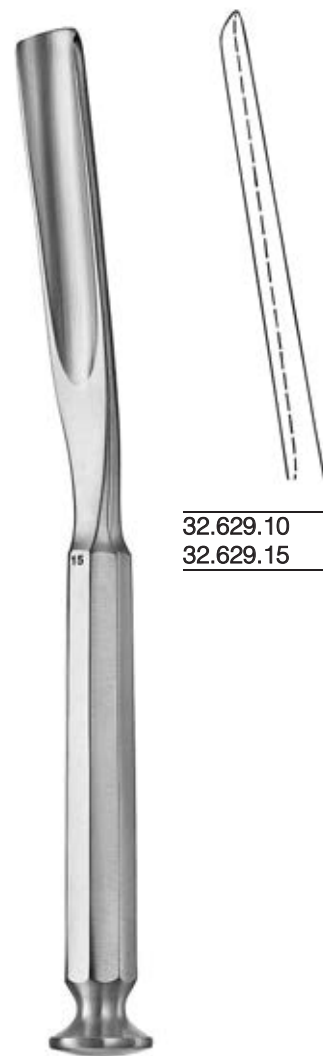

32.629.10 10 mm
 32.629.15 15 mm

WALTER
 20 cm/8"

Stößel

Tampers

Pilons métalliques

Punzones metálicos

Pestoni metallici



- 32.584.03
ø 3 mm
- 32.584.05
ø 5 mm
- 32.584.08
ø 8 mm

CASPAR
20 cm/8"



- 32.586.12
ø 12 mm
- 32.586.14
ø 14 mm
- 32.586.16
ø 16 mm

CASPAR
20 cm/8"



- 32.588.03
ø 3 x 8 mm
- 32.588.04
ø 4 x 10 mm
- 32.588.05
ø 5 x 15 mm
- 32.588.06
ø 6 x 20 mm

SYPERT
29 cm/11½"

CASPAR (CCR)	132 - 136 179 - 184
Siehe auch Seite:	199
See also page:	212
Voir aussi la page:	228
Véase también la página:	230
Vedere anche pagina:	230

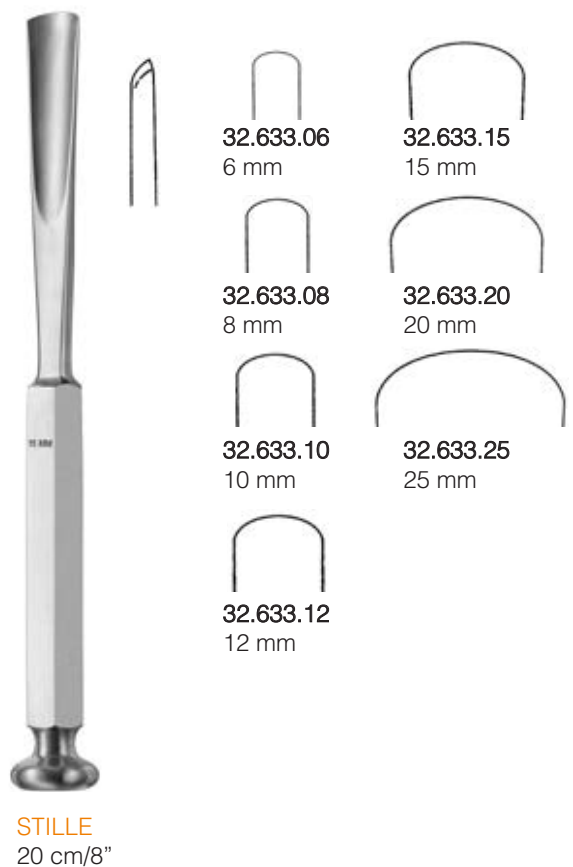
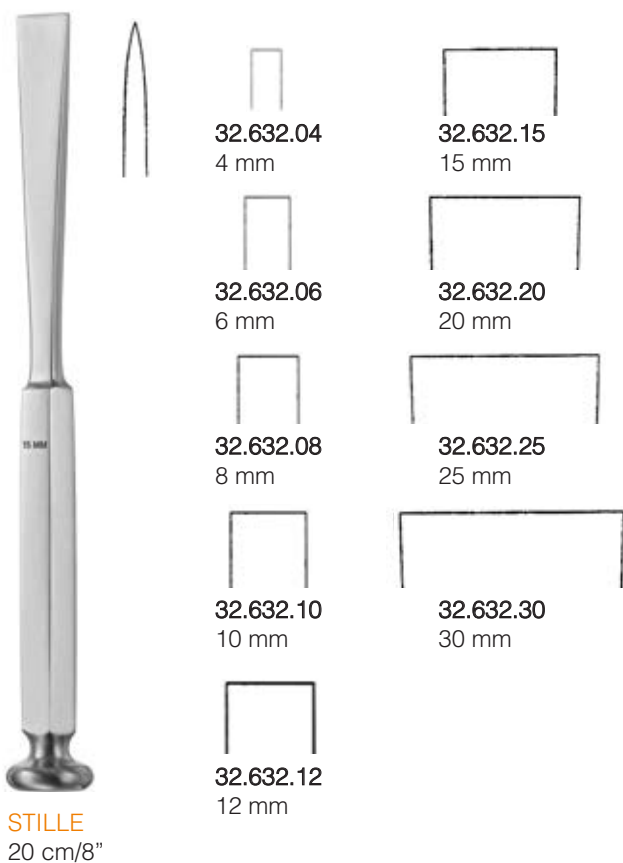
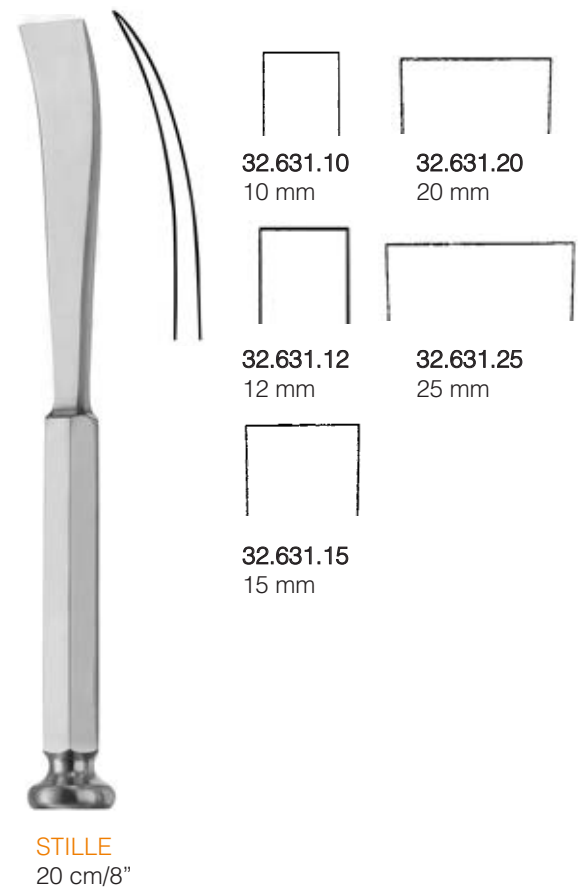
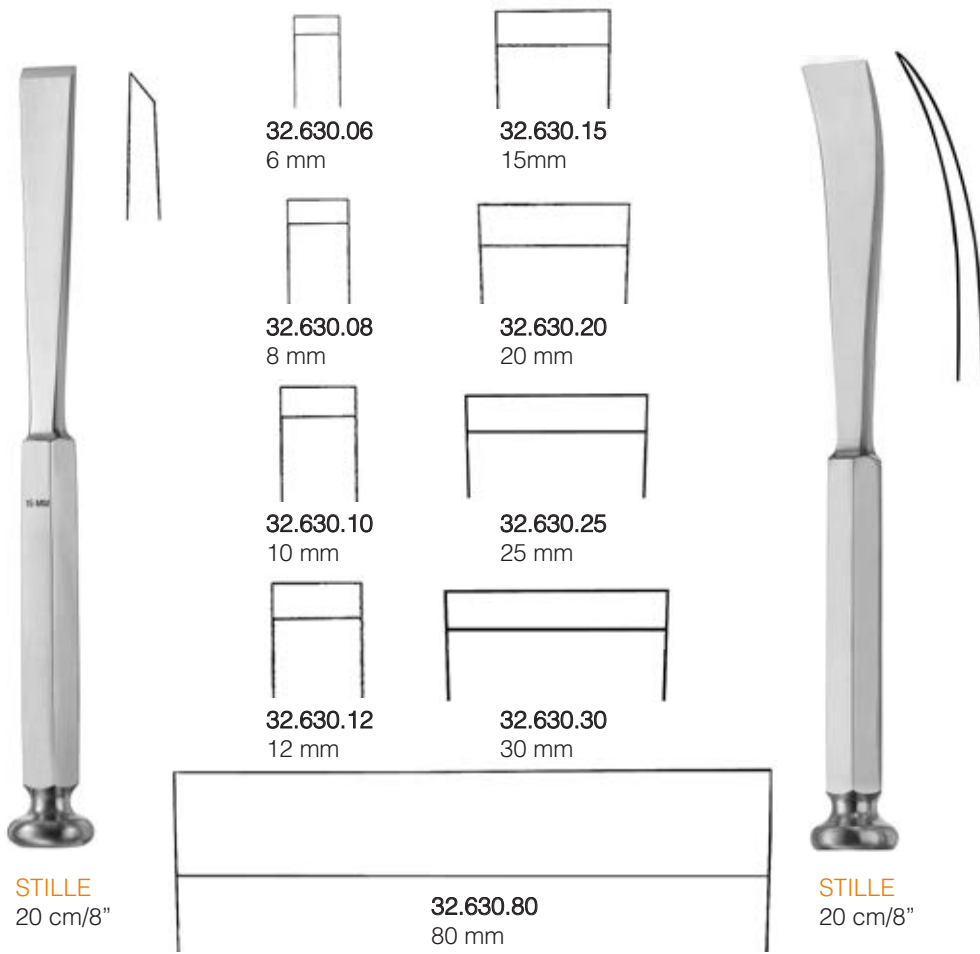

Osteotome

Osteotomes
Ostéotomes
Osteótomos
Osteotomi



32.650.04
4 mm

32.650.06
6 mm

32.650.08
8 mm

32.650.10
10 mm

32.650.13
13 mm

32.650.15
15 mm

32.650.18
18 mm

32.650.20
20 mm

32.650.25
25 mm

32.650.30
30 mm

32.650.38
38 mm

32.650.44
44 mm

32.650.50
50 mm

LAMBOTTE
24 cm/9½"



32.651.08
8 mm

32.651.10
10 mm

32.651.13
13 mm

32.650.18
18 mm

32.651.20
20 mm

32.651.25
25 mm

32.651.30
30 mm

32.651.38
38 mm

32.651.44
44 mm

32.651.50
50 mm

LAMBOTTE
24 cm/9½"

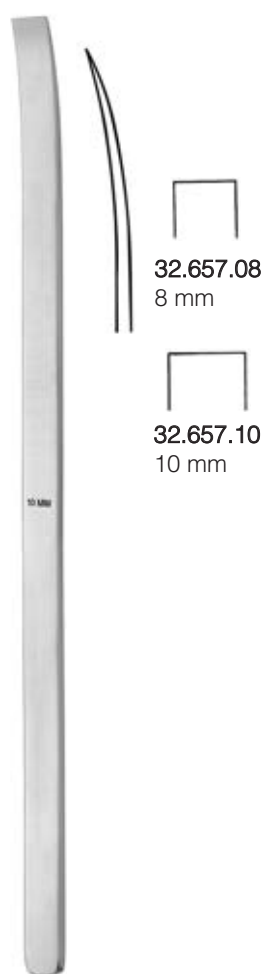

NIEDERDELMANN
 25 cm/9¾"

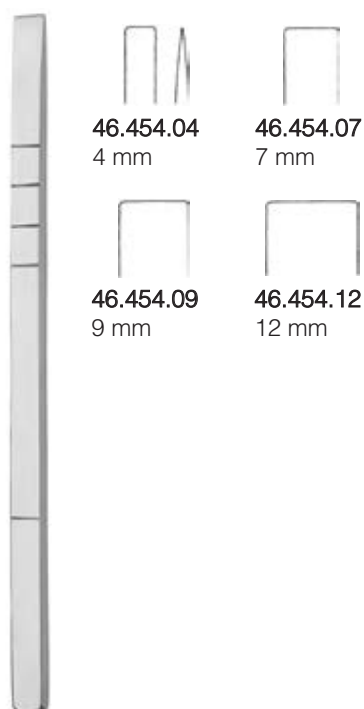

COTTLE
 18 cm/7"

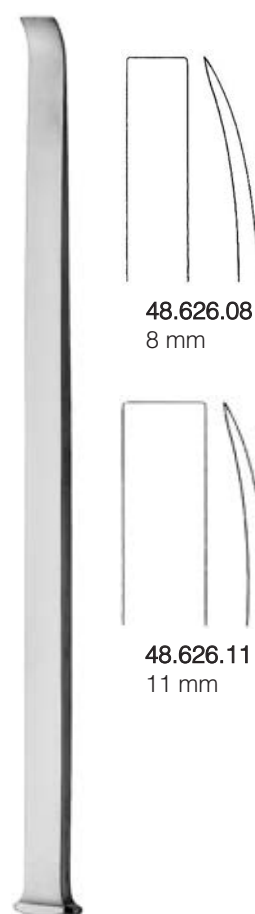

OBWEGESER
 23,5 cm/9¼"

Osteotome, Hohlmeißel

Osteotomes, gouges
 Ostéotomes, gouges
 Osteótomos, gubias
 Osteotomi, sgorbie

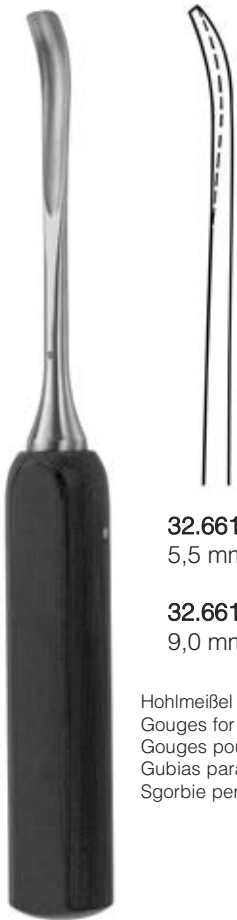

32.661.01
5,5 mm

32.661.02
9,0 mm

Hohlmeißel für Skoliose Operationen
 Gouges for scoliosis operations
 Gouges pour les opérations de scoliose
 Gubias para las operaciones de escoliosis
 Sgorbie per le operazioni di scoliosi

ZIELKE
23 cm/9"



32.662.06
6 mm

32.662.08
8 mm

32.662.11
11 mm

32.662.16
16 mm

Wirbelsäulenmeißel, bajonettförmig
 Lamina gouges, bayonet-shaped
 Gouges pour la colonne vertébrale, de forma baïonnette
 Gubias para la columna vertebral, en forma bayoneta
 Sgorbie per la colonna vertebrale, a forma di baionetta

23,5 cm/9¼"

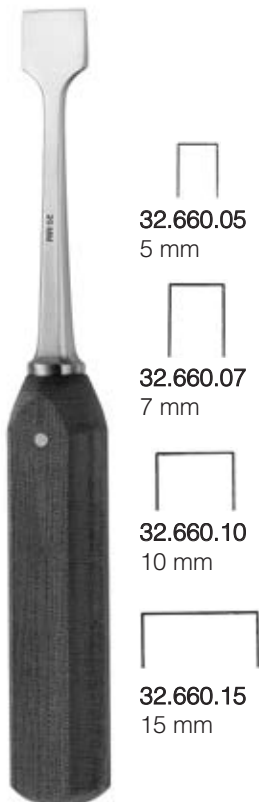

32.660.05
5 mm

32.660.07
7 mm

32.660.10
10 mm

32.660.15
15 mm

32.660.20
20 mm

32.660.25
25 mm

32.660.30
30 mm

LEXER
22 cm/8¾"

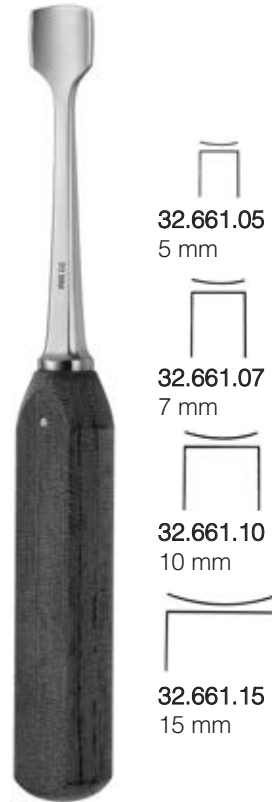

32.661.05
5 mm

32.661.07
7 mm

32.661.10
10 mm

32.661.15
15 mm

32.661.20
20 mm

32.661.25
25 mm

32.661.30
30 mm

LEXER
22 cm/8¾"

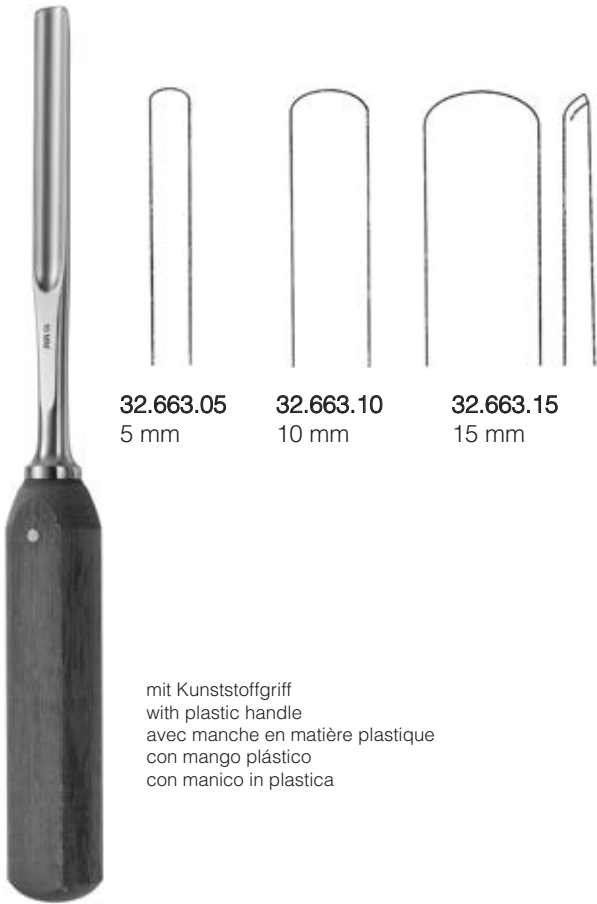

32.663.05
5 mm

32.663.10
10 mm

32.663.15
15 mm

mit Kunststoffgriff
 with plastic handle
 avec manche en matière plastique
 con mango plástico
 con manico in plastica

LEXER
25 cm/9¾"



32.663.55
5 mm

32.663.60
10 mm

32.663.65
15 mm

mit Kunststoffgriff
 with plastic handle
 avec manche en matière plastique
 con mango plástico
 con manico in plastica

LEXER
25 cm/9¾"

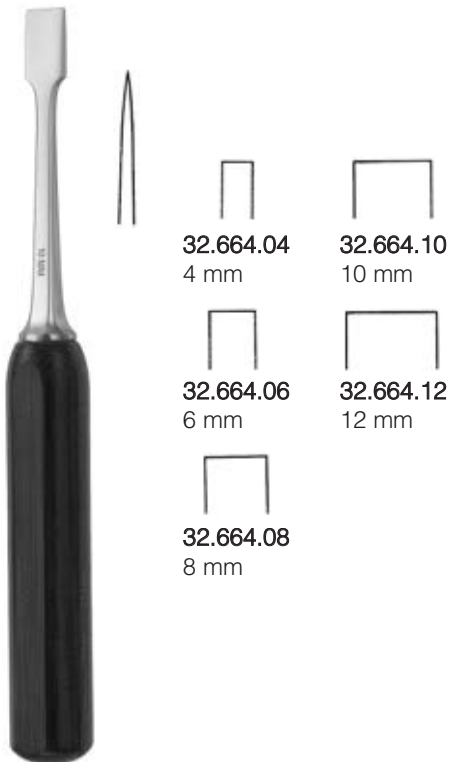

32.664.04
4 mm

32.664.10
10 mm

32.664.06
6 mm

32.664.12
12 mm

32.664.08
8 mm

LEXER-mini
18 cm/7"

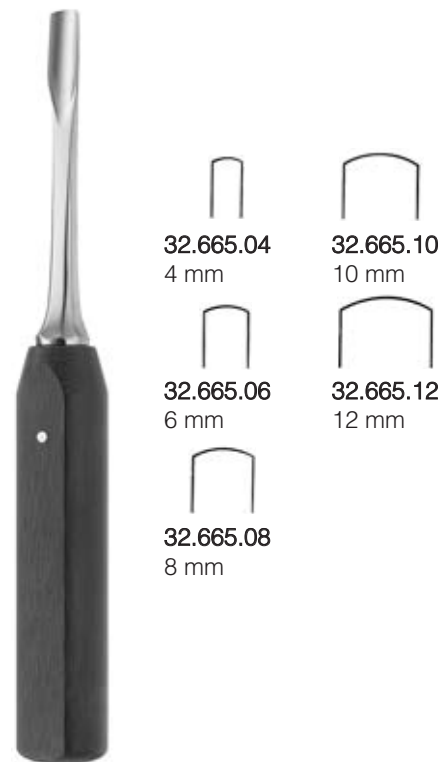

32.665.04
4 mm

32.665.10
10 mm

32.665.06
6 mm

32.665.12
12 mm

32.665.08
8 mm

LEXER-mini
18 cm/7"

Spongiosaentnahmemeißel

Spongiosa gouges
Ciseaux-burins pour spongiosa
Cinceles de esponjosa
Scalpelli per spongiosa

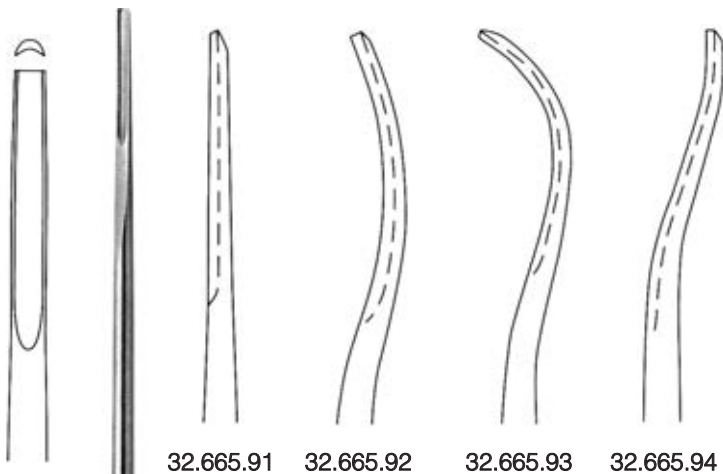

32.665.91 32.665.92 32.665.93 32.665.94



Spinal-Fusions-Hohlmeißel
Spinal fusion gouges
Gouges pour la fusion spinal
Gubias para la fusión espinal
Sgorbie per la fusione spinale

mit Kunststoffgriff
with plastic handle
avec manche en matière plastique
con mango plástico
con manico in plastica

COBB
28 cm/11"
4 mm

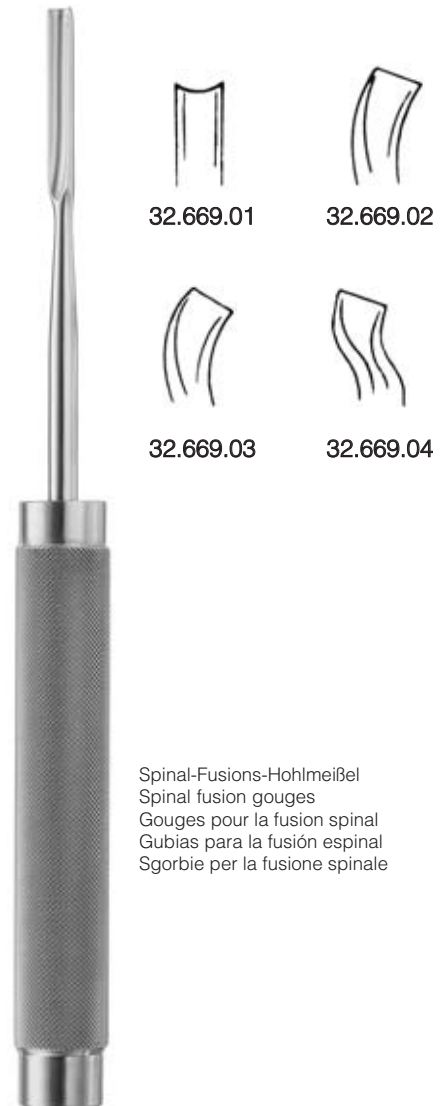

32.669.01 32.669.02

32.669.03 32.669.04

Spinal-Fusions-Hohlmeißel
Spinal fusion gouges
Gouges pour la fusion spinal
Gubias para la fusión espinal
Sgorbie per la fusione spinale

COBB
28 cm/11"
6 mm

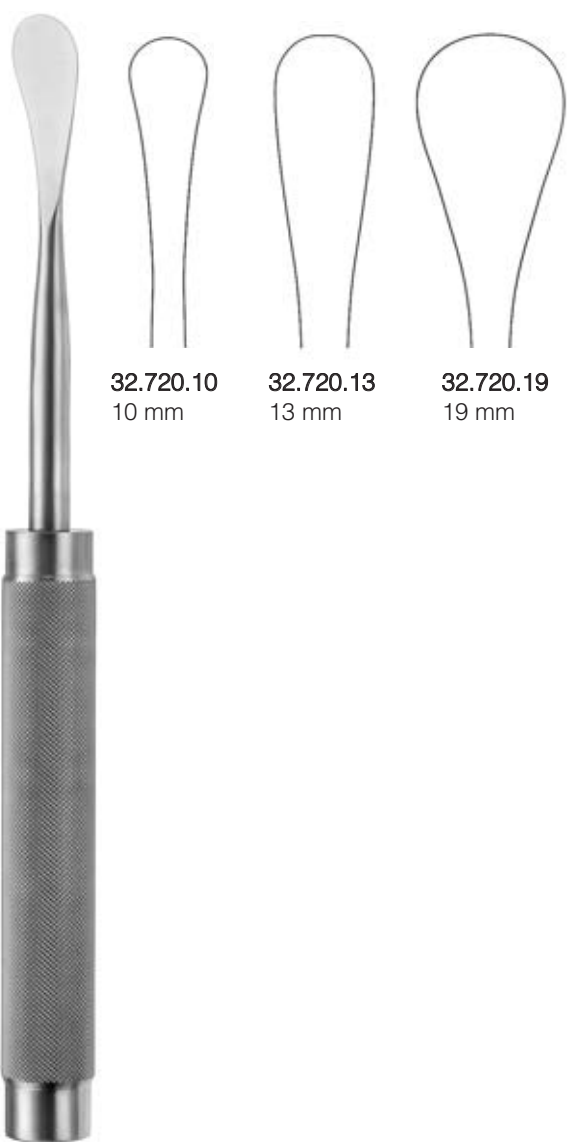

32.720.10
10 mm

32.720.13
13 mm

32.720.19
19 mm

COBB
28 cm/11"

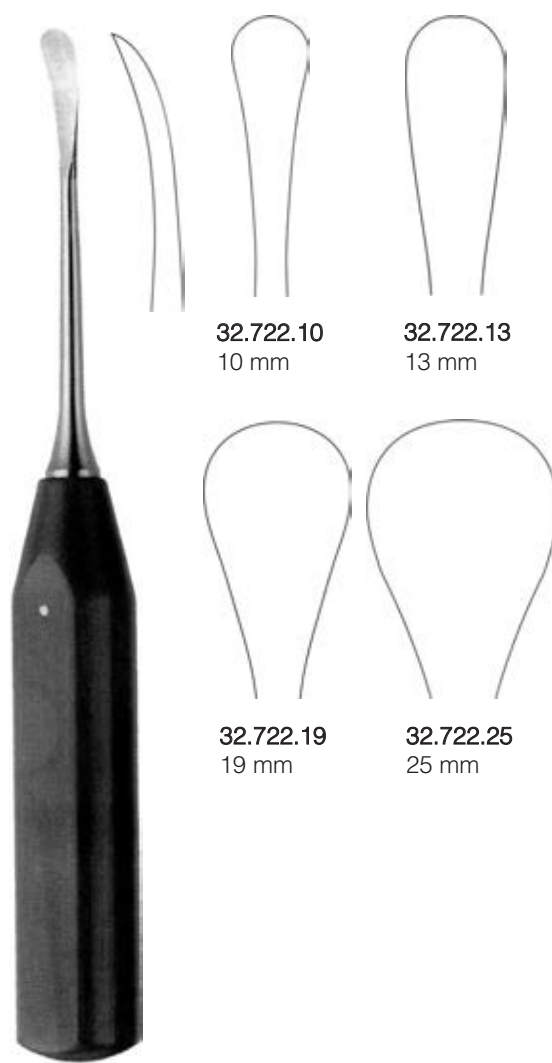

halbscharf
 semi-sharp
 semi-pointu
 semi-agudo
 semi acuto

32.722.10
10 mm

32.722.13
13 mm

32.722.19
19 mm

32.722.25
25 mm

COBB
25 cm/10"



WAGNER
32.687.00
24,5 cm/9¾"

Kopf
Head
Tête
Cabeza
Testa
Ø 35 mm

komplett mit:
1 Paar Metallbacken **32.687.01** und
1 Paar Kunststoffbacken **32.687.02** und
1 Schlüssel

complete with:
1 pair of metal disks **32.687.01** and
1 pair of plastic disks **32.687.02** and
1 wrench

complet avec:
1 paire de disques métalliques **32.687.01**
1 paire de disques en plastique **32.687.02**
1 clé

completo con:
1 par de discos de metal **32.687.01**
1 par de discos de plástico **32.687.02**
1 llave

completo di:
1 paio di dischi di metallo **32.687.01**
1 paio di dischi di plastica **32.687.02**
1 chiave

32.687.01
215 g

1 Metallbacke, plan
1 Metallbacke, convex

1 metal disk, plane
1 metal disk, convex

1 disque de métal, plan
1 disque de métal, convexe

1 disco de metal, plano
1 disco de metal, convexo

1 disco di metallo, piate
1 disco di metallo, convessa

32.687.02
30 g

1 Kunststoffbacke, plan
1 Kunststoffbacke, convex

1 plastic disk, plane
1 plastic disk, convex

1 disque en plastique, plan
1 disque en plastique, convexe

1 disco de plástico, plano
1 disco de plástico, convexo

1 disco di plastica, piate
1 disco di plastica, convessa



HAJEK
32.687.22
22 cm/8¾"

Kopf
Head
Tête
Cabeza
Testa
Ø 27 mm

Gewicht
Weight
Poids
Peso
Peso
140 g



Kopf
Head
Tête
Cabeza
Testa
ø 30 mm

Gewicht
Weight
Poids
Peso
Peso
300 g

COTTLE
32.689.24
19 cm/7½"

plan / konvex
plane / convex
plan / convexe
plano / convexo
plano / convesso



Kopf
Head
Tête
Cabeza
Testa
ø 25 mm

Gewicht
Weight
Poids
Peso
Peso
135 g

32.691.14
18,5 cm/7¼"
32.691.99

Ersatzbacken zu **32.691.14**, Paar
Spare disks to **32.691.14**, pair
Disques de rechange pour **32.691.14**, paire
Discos de repuesto para **32.691.14**, par
Dischi di ricambio per **32.691.14**, paio



Kopf
Head
Tête
Cabeza
Testa
ø 20 mm

Gewicht
Weight
Poids
Peso
Peso
140 g

WILLIGER
32.695.14
16,5 cm/6½"



Kopf
Head
Tête
Cabeza
Testa
ø 80 x 60 mm

Gewicht
Weight
Poids
Peso
Peso
400 g

STEINBACH
32.695.40
24 cm/9½"

Kunststoff, massiv
Plastic, solid
Matière plastique, solide
Plástico, sólido
Materia plastica, piena

Hämmer

Mallets
Maillets
Martillos
Martelli



WILLIGER
24 cm/9½"

bleigefüllt
lead filled
templi de plomb
relleno de plomo
ripieno di piombo

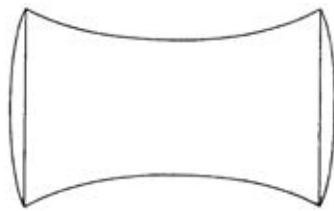

32.694.30

Kopf	Gewicht
Head	Weight
Tête	Poids
Cabeza	Peso
Testa	Peso
ø 26 mm	300 g=10oz

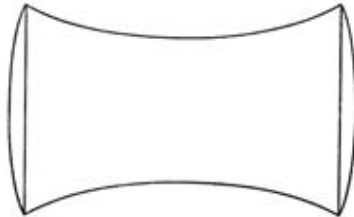

32.694.34

Kopf	Gewicht
Head	Weight
Tête	Poids
Cabeza	Peso
Testa	Peso
ø 28 mm	340 g=12oz

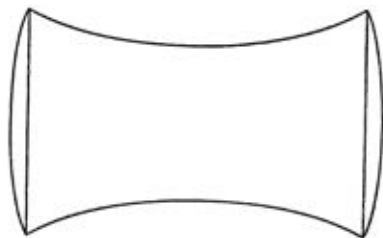

32.694.40

Kopf	Gewicht
Head	Weight
Tête	Poids
Cabeza	Peso
Testa	Peso
ø 30 mm	400 g=14oz



32.696.19
19 cm/7½"

bleigefüllt
lead filled
templi de plomb
relleno de plomo
ripieno di piombo

Kopf
Head
Tête
Cabeza
Testa
ø 22 mm

Gewicht
Weight
Poids
Peso
Peso
155 g

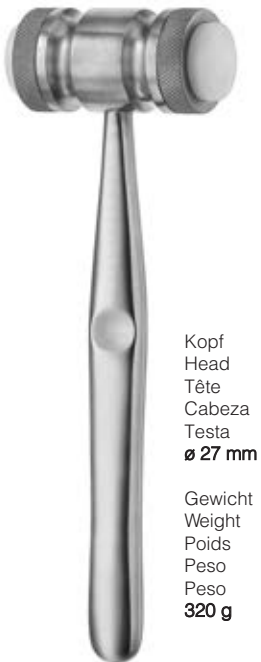

MEAD
32.696.32
17 cm/6¾"

Kopf
Head
Tête
Cabeza
Testa
ø 27 mm

Gewicht
Weight
Poids
Peso
Peso
320 g



32.697.02
Ersatzbacken (Paar)
Spare disks (pair)
Disques de rechange (paire)
Discos de repuesto (par)
Dischi di ricambio (paio)

Kunststoff (Nylon)
Plastic (nylon)
Matière plastique (nylon)
Plástico (nilón)
Plastica (nilon)

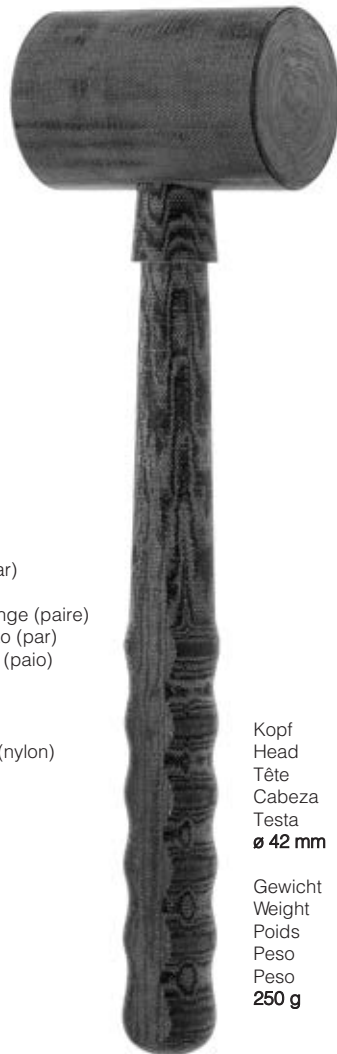

26 cm/10¼"

Kopf
Head
Tête
Cabeza
Testa
ø 42 mm

Gewicht
Weight
Poids
Peso
Peso
250 g

32.698.25

aus Kunststoff
ohne Blei

made of plastic
without lead

en matière plastique
sans plomb

de plástico
sin plomo

in plastica
senza piombo

Kopf
Head
Tête
Cabeza
Testa
ø 42 mm

Gewicht
Weight
Poids
Peso
Peso
400 g

32.698.40

aus Kunststoff
mit Bleifüllung

made of plastic
with lead filling

en matière plastique
templi de plomb

de plástico
relleno de plomo

in plastica
ripieno di piombo



32.701.18
18,5 cm/7"

Kopf
Head
Tête
Cabeza
Testa
ø 25 mm

Gewicht
Weight
Poids
Peso
Peso
240 g

mit einer flachen und einer
aufgerauhten Fläche

with one smooth and one
rough surface

avec une surface plane et
rugueuse

con una superficie plana y
rugosa

con superficie piana e
ruvida

Raspatorien

Periosteal elevators
Rugines-raspatoires
Periostótomos
Periostotomi

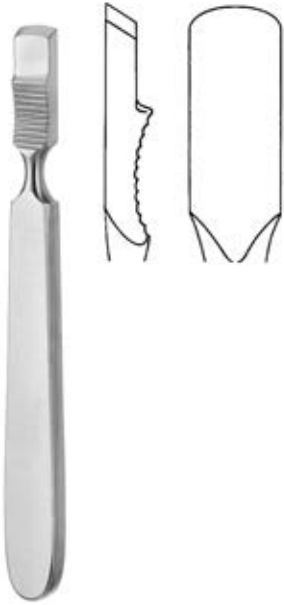

FARABEU
32.702.15
15 cm/5¾"

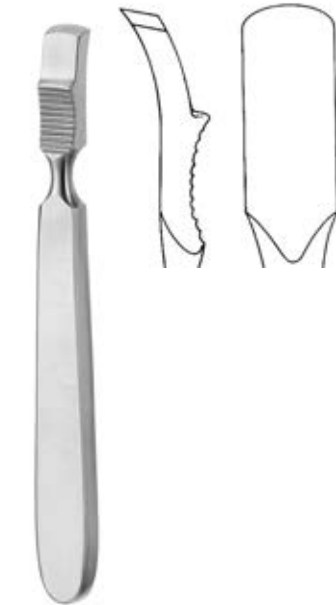

FARABEU
32.703.15
15 cm/5¾"

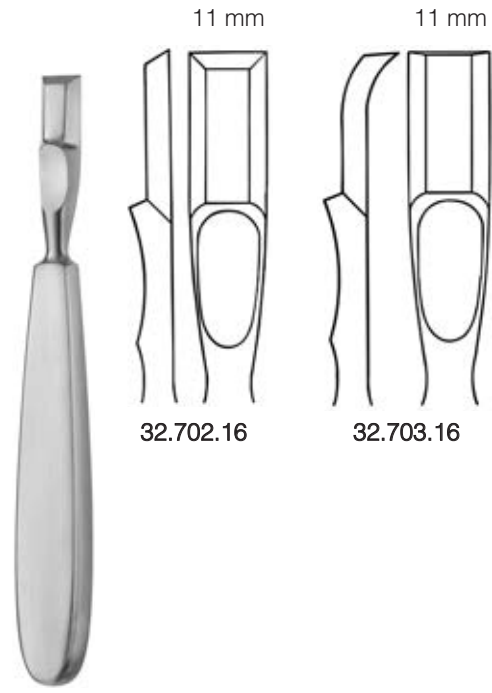

32.702.16

32.703.16

FARABEU - COLLIN
16 cm/6¼"

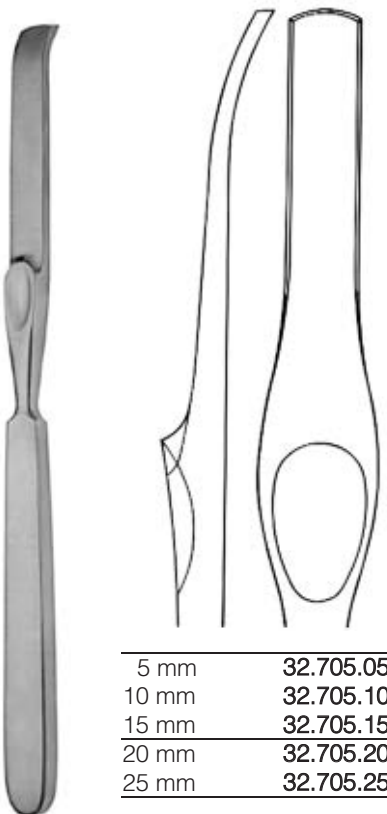

LAMBOTTE
21 cm/8¼"

5 mm	32.705.05
10 mm	32.705.10
15 mm	32.705.15
20 mm	32.705.20
25 mm	32.705.25



MCKISSOCK
32.708.19
19,5 cm/7¾"

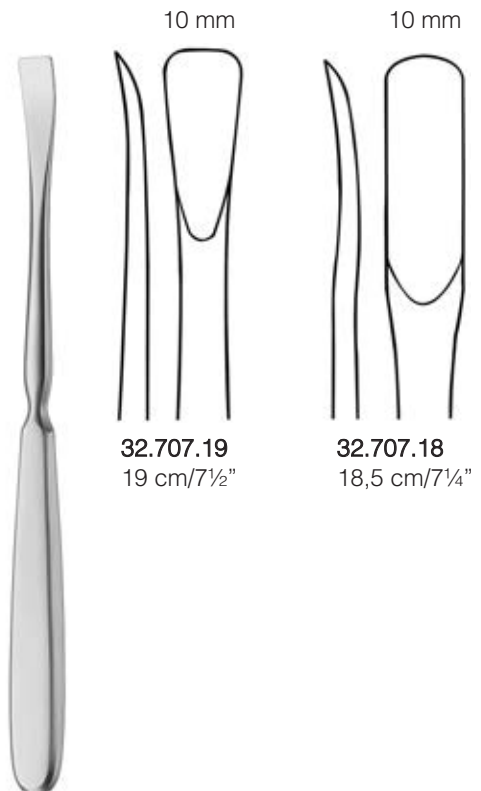

32.707.19
19 cm/7½"

32.707.18
18,5 cm/7¼"

KRÄMER

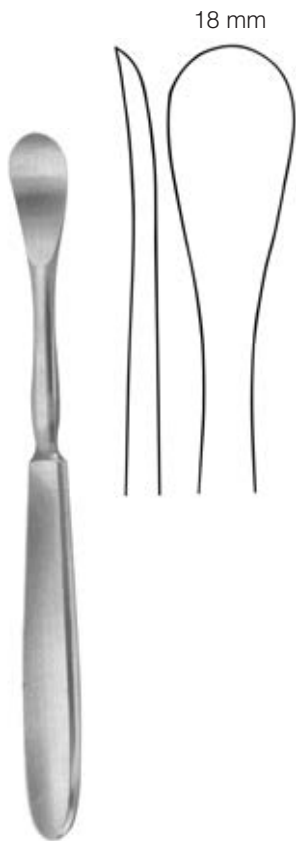

SEDILLOT
32.709.18
 18,5 cm/7"

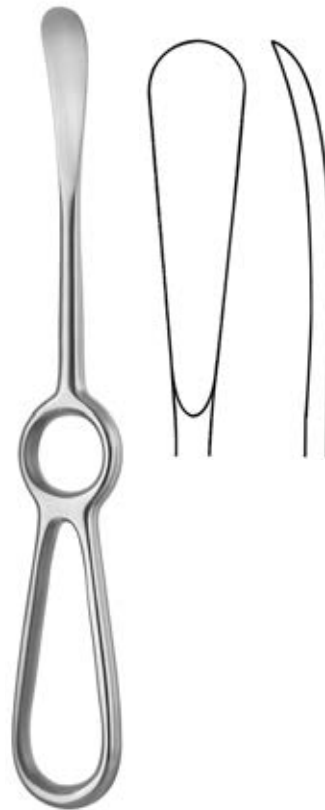

SEDILLOT
32.709.21
 21 cm/8¼"

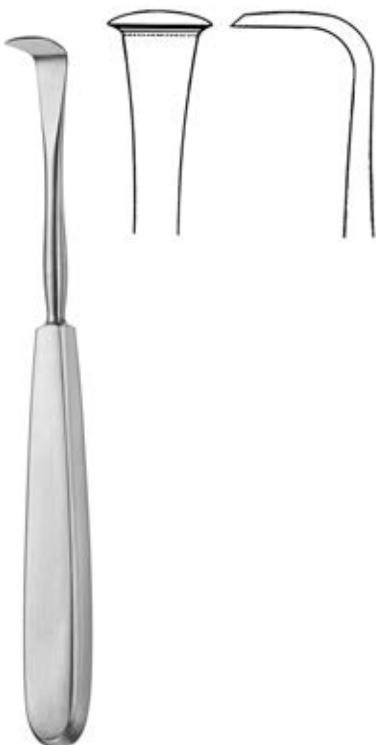

LANGENBECK
32.711.18
 18 cm/7"



LANGENBECK



32.712.01
 19 cm/7½"
 16 mm

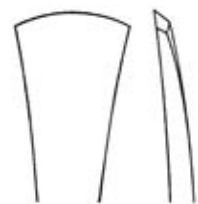

32.712.02
 19 cm/7½"
 16 mm



32.712.03
 18,5 cm/7¼"
 12 mm



32.712.04
 18 cm/7"
 12 mm

massiv
 solid
 solide
 macizo
 solido

Raspatorien

Periosteal elevators
Rugines-raspatoires
Periostótomos
Periostotomi



HOEN

32.712.10
16 cm/6¼"
7 mm

massiv
solid
solide
macizo
solido



32.712.11
18,5 cm/7¼"
15 mm



32.712.12
19 cm/7½"
20 mm

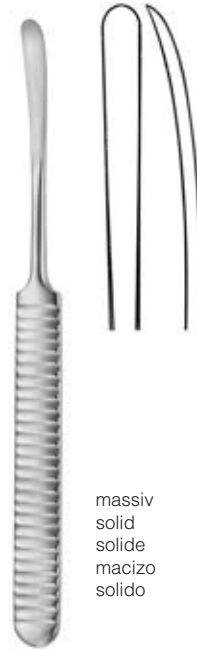

WILLIGER
32.713.16
16 cm/6¼"
5 mm

massiv
solid
solide
macizo
solido



JANSEN
32.714.16
16,5 cm/6½"

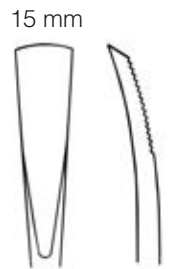

15 mm



17 cm/6¾"



32.715.06
6 mm

mit Hohlheft
with hollow handle
avec manche creux
con mango hueco
con manico vuoto



32.715.08
8 mm



JOSEPH
32.716.16
16 cm/6¼"



4 mm



BUECHS
32.719.19
19 cm/7½"

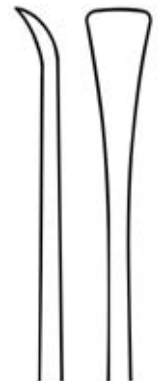

9,5 mm

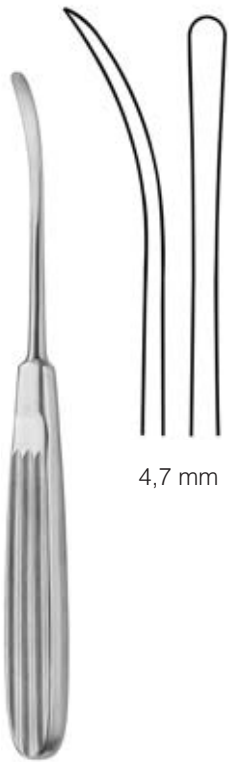

4,7 mm

LANDOLT
32.740.47
 17,5 cm/7"



32.741.62
 6,2 mm

scharf
 sharp
 pointue
 agudo
 acuto

CASPAR
 18 cm/7"



32.742.62
 6,2 mm

stumpf
 blunt
 mousse
 romo
 smusso



32.743.03
 3 mm

32.743.06
 6 mm

17 cm/6¾"



32.744.01

32.744.02

Wirbelkörperdissektoren, hilfreich zum Lösen des posterioren Längsbandes und zur Entfernung von Bandscheibenfragmenten und Osteophyten

Vertebral body dissectors, usable for loosening the posterior longitudinal ligament and removal of disk fragments and osteophytes

Dissecteurs corps vertébral, utilisable pour le relâchement postérieur ligament longitudinal et l'élimination des fragments de disque et osteophytes

Disectores de cuerpo vertebral, utilizable para soltar el ligamento longitudinal posterior y eliminar fragmentos de disco y osteophytes

Dissectors corpo vertebrale, utilizzabile per allentare il legamento longitudinale posteriore e la rimozione di frammenti disco e osteophytes

CASPAR
 20,5 cm/8"

Mikroelevatorium
 Micro elevator
 Micro elevateur
 Micro elevador
 Micro elevatorio



32.746.16
 16 cm/6¼"

extrem leicht
 extremely light
 extrêmement léger
 extremadamente ligero
 estremamente leggero



32.746.17
 17 cm/6¾"

Elevatoren, Dissektoren

Elevators, dissectors
Élévateurs, dissecteurs
Elevadores, disectores
Elevatori, dissestori

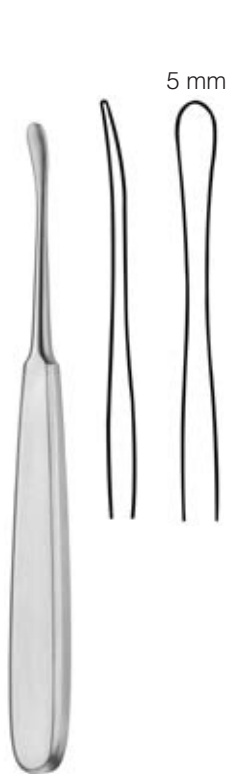

SEBILAU
32.748.17
17 cm/6¾"



QUERVAIN
32.750.20
20 cm/8"

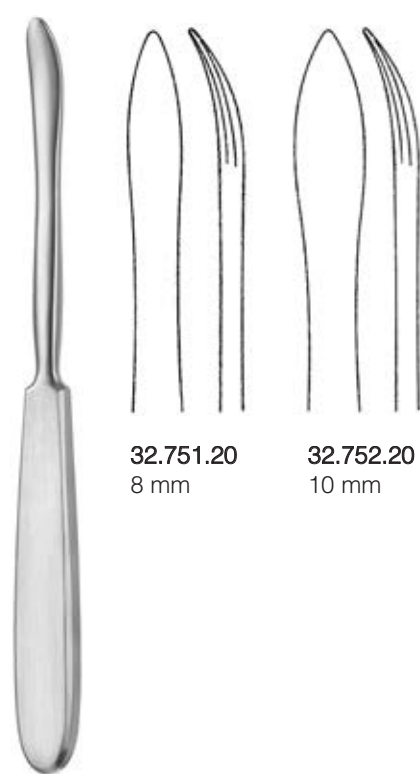

LANGENBECK
20 cm/8"

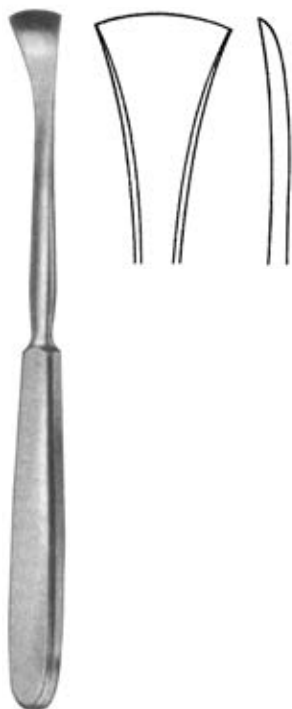

LANGENBECK
32.753.20
19,5 cm/7¾"



ADSON
17 cm/6¾"

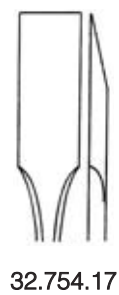

32.754.17



32.755.17



32.756.17
7 mm



32.757.17



SCHNEIDER
32.758.17
 17,5 cm/6¾"

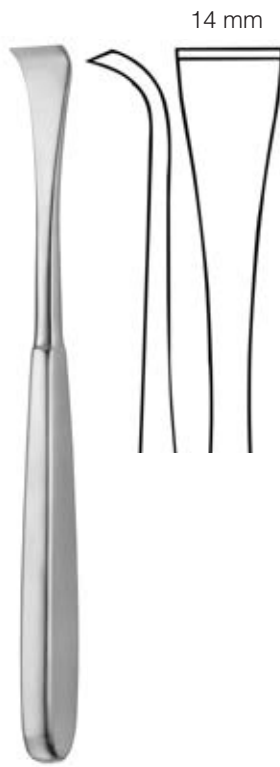

SCHNEIDER SAUERBRUCH
32.758.19
 19 cm/7½"



32.759.06
 6 mm



32.759.10
 10 mm

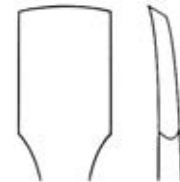

32.759.12
 12 mm

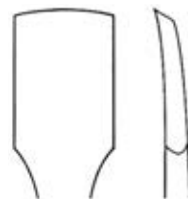

32.759.13
 13 mm

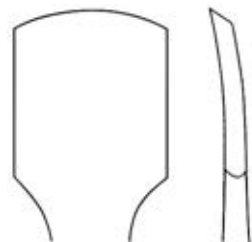

32.759.19
 19 mm

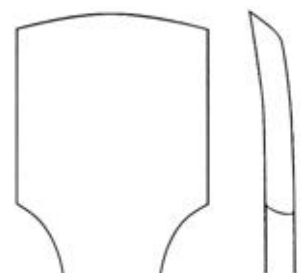

32.759.25
 25 mm



KEY
 19 cm/7½"



CUSHING (LITTLE-JOKER)
32.760.15
 15 cm/6"



CUSHING (LITTLE-JOKER)
32.761.19
 19 cm/7½"



CUSHING
32.762.19
 19,5 cm/7¾"

Elevatoren, Dissektoren

Elevators, dissectors
 Elevateurs, dissecteurs
 Elevadores, disectores
 Elevatori, dissectori

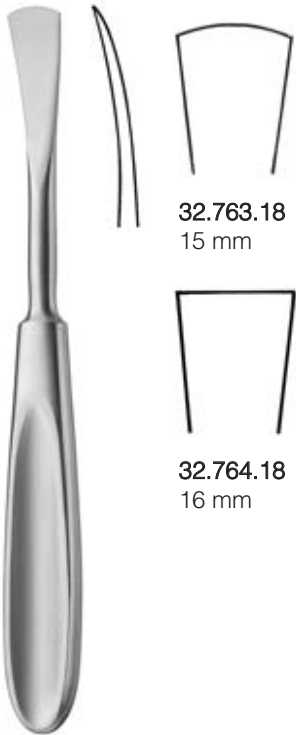

CUSHING
 18 cm/7"

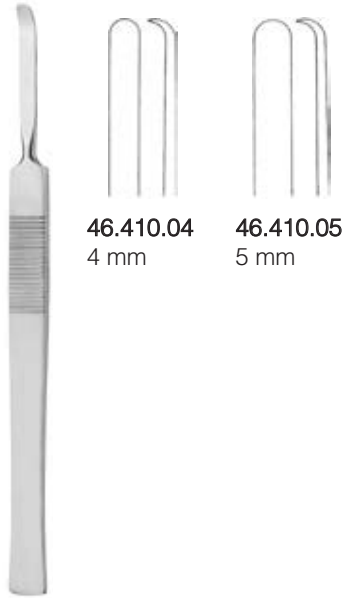

McKENY
 15 cm/6"



SEWALL
 46.436.20
 20 cm/8"

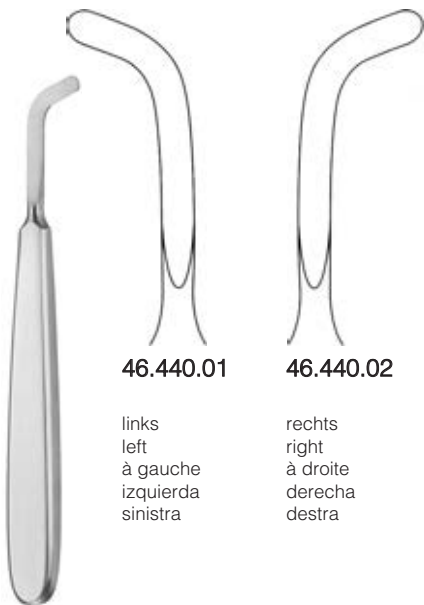

46.440.01

links
 left
 à gauche
 izquierda
 sinistra

46.440.02

rechts
 right
 à droite
 derecha
 destra

14 cm/5½"



WILLIGER
 32.713.13
 13 cm/5"



WILLIGER
 82.898.17
 17 cm/6¾"

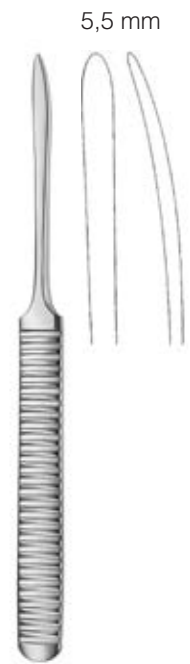

WILLIGER
 82.899.16
 16 cm/6¼"

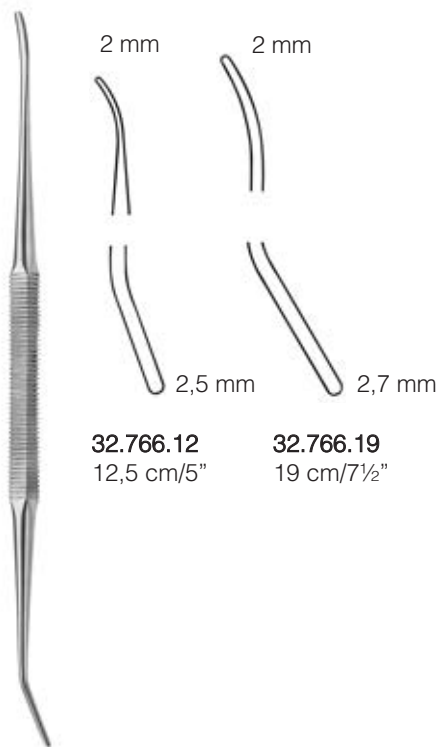

WATSON CHEYNE

32.766.12
12,5 cm/5"

32.766.19
19 cm/7½"

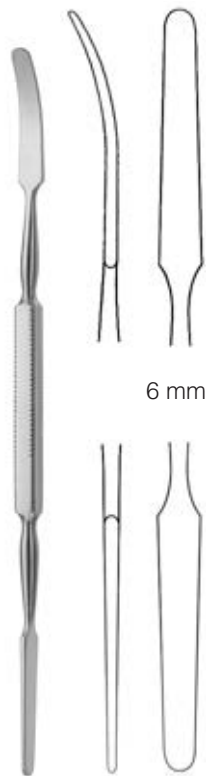

McDONALD
32.767.19
19 cm/7½"



HOWARTH
32.768.21
22 cm/8¾"

scharf / stumpf
sharp / blunt
pointu / mousse
agudo / romo
acuto / smusso

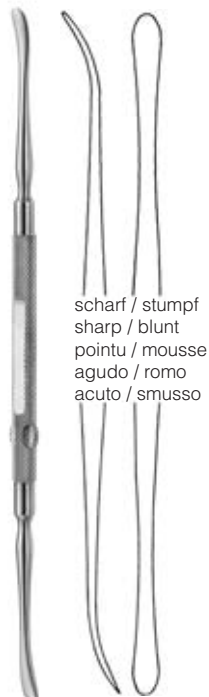

FREER
46.415.18
18,5 cm/7¼"

scharf / stumpf
sharp / blunt
pointu / mousse
agudo / romo
acuto / smusso

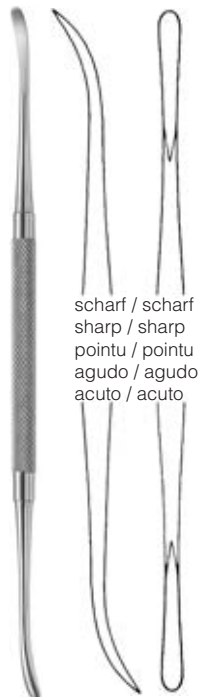

YASARGIL
46.416.18
18,5 cm/7¼"

scharf / scharf
sharp / sharp
pointu / pointu
agudo / agudo
acuto / acuto



FREER
46.417.19
19 cm/7½"

stumpf
blunt
mousse
romo
smusso



FREER
46.419.19
19 cm/7½"

scharf
sharp
pointu
agudo
acuto

Elevatoren, Doppeldissektoren
 Elevators, dissectors, double-ended
 Elévateurs, dissecteurs doubles
 Elevadores, disectores dobles
 Elevatori, dissettori doppi



5 / 5 mm

COTTLE
 46.421.23
 23,5 cm/9¼"



4 / 4 mm

KILLIAN
 46.426.18
 18 cm/7"



4,5 / 4,5 mm

KILLIAN
 46.426.22
 23 cm/9"

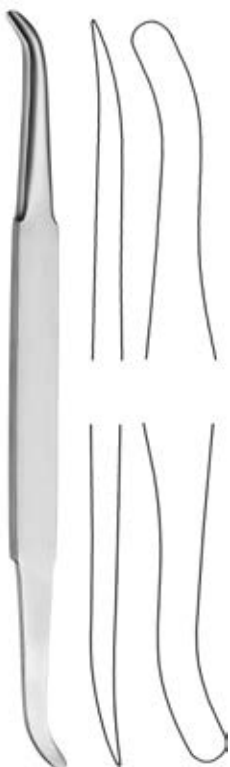

SELDIN
 82.905.22
 19 cm/7½"

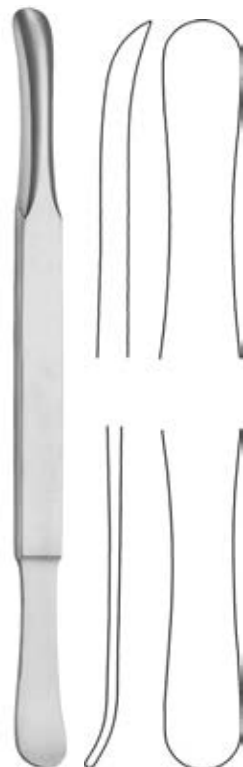

SELDIN
 82.905.22
 19 cm/7½"

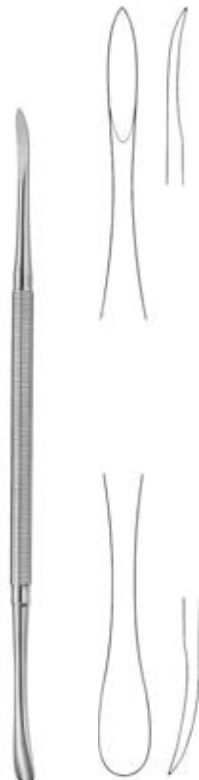

MOLT
 82.910.09
 18 cm/7"
 Nr. 9



32.774.14
 20 cm/8"



32.775.14
 20 cm/8"



32.776.13
 20 cm/8"



32.777.13
 18,5 cm/7¼"



32.778.06
 19 cm/7½"



32.779.06
 18 cm/7"

schmal
 narrow
 étroit
 estrecho
 stretto



32.781.06
 18 cm/7"



32.783.03
 18 cm/7"

extra schmal
 extra narrow
 très étroit
 muy estrecho
 molto stretto

Raspeln, Knochenhebel

Rasps, bone levers

Râpes, leviers à os

Escofinas, elevadores para hueso

Raspe, elevatori per ossa

Raspeln
Rasps
Râpes
Escofinas
Raspe

Knochenhebel
Bone levers
Leviers à os
Elevadores para hueso
Elevatori per ossa

mit TC-Einsätzen
with TC inserts
avec mors TC
con bocas TC
con morso TC



FOMON
20 cm/8"



46.522.01
Fig. 1/2



46.522.03
Fig. 3/4



46.522.05
Fig. 5/6



46.522.07
Fig. 7/8



46.522.09
Fig. 9/10

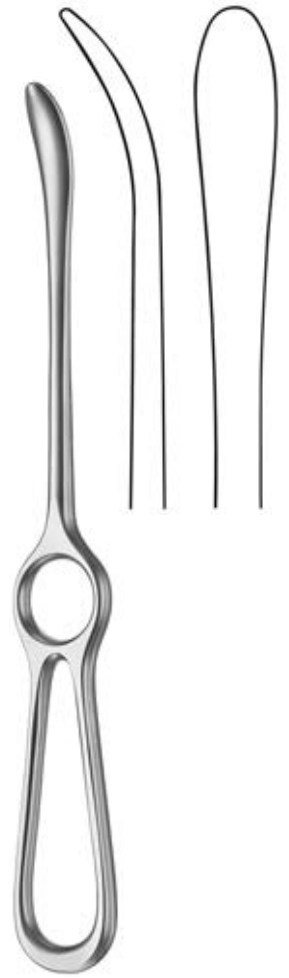

LANE
32.835.27
23 cm/9"
11 mm



TAYLOR
 16 cm/6¼"

spitzes Ende
 pointed end
 bout aigu
 punta aguda
 punta acuta

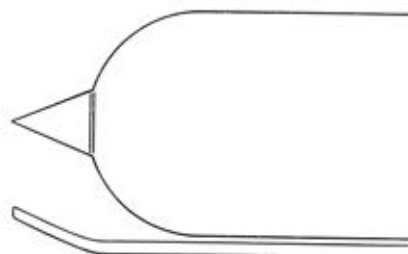

32.831.16
 75 x 30 mm

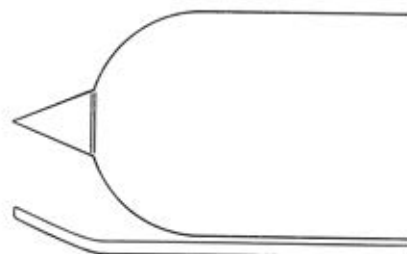

32.833.16
 100 x 30 mm

Knochenhebel
 Bone levers
 Leviers à os
 Elevadores para hueso
 Elevatori per ossa

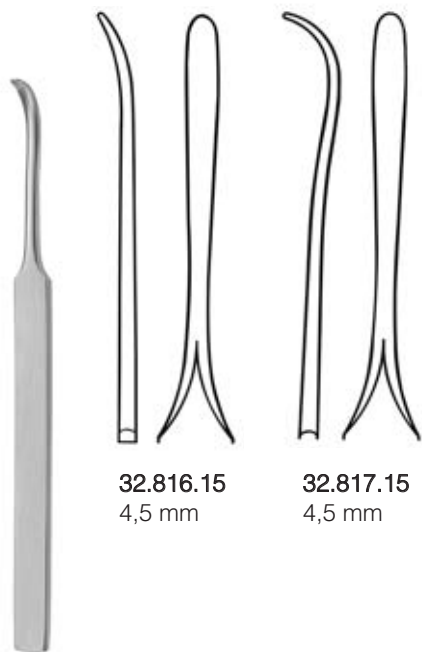

32.816.15
 4,5 mm

32.817.15
 4,5 mm

KOENIG
 15 cm/6"

Handbohrapparate

Hand drills

Perforateurs à main

Perforadores de mano

Perforatori a mano



33.210.95

Handbohrapparat allein
Hand drill only
Perforateur à main seul
Perforador de mano suelto
Perforatore a mano solo

STILLE
20,5 cm/8"

33.210.20

komplett mit 9 Bohrern/Fräsern
complete with 9 twist drills/burrs
complet avec 9 fraises
completo con 9 brocas
completo con 9 punte
33.212.25 - 33.214.16



Spiralbohrer
Twist drill
Mèche hélicoïdale
Broca espiral
Punta a spirale

33.212.25
Ø 2,5 mm
Fig. 1



Spiralbohrer
Twist drill
Mèche hélicoïdale
Broca espiral
Punta a spirale

33.212.30
Ø 3,0 mm
Fig. 2



Spiralbohrer
Twist drill
Mèche hélicoïdale
Broca espiral
Punta a spirale

33.212.35
Ø 3,5 mm
Fig. 3



Spiralbohrer
Twist drill
Mèche hélicoïdale
Broca espiral
Punta a spirale

33.212.40
Ø 4,0 mm
Fig. 4



Kugelfräser
Spherical burr
Fraise sphérique
Fresa esférica
Fresa sferica

33.214.05
Ø 5,0 mm
Fig. 6



Kugelfräser
Spherical burr
Fraise sphérique
Fresa esférica
Fresa sferica

33.214.08
Ø 8,0 mm
Fig. 7



Kugelfräser
Spherical burr
Fraise sphérique
Fresa esférica
Fresa sferica

33.214.12
Ø 12 mm
Fig. 8



Kugelfräser
Spherical burr
Fraise sphérique
Fresa esférica
Fresa sferica

33.214.16
Ø 16 mm
Fig. 9



Trepine
Tréphine
Trépan
Trépano
Trapano

33.214.10
Ø 10 mm
Fig. 5



Spiralbohrer
Twist drill
Mèche hélicoïdale
Broca espiral
Punta a spirale

33.216.10
Ø 1,0 mm
Fig. 10



Spiralbohrer
Twist drill
Mèche hélicoïdale
Broca espiral
Punta a spirale

33.216.15
Ø 1,5 mm
Fig. 11



Spiralbohrer
Twist drill
Mèche hélicoïdale
Broca espiral
Punta a spirale

33.216.20
Ø 2,0 mm
Fig. 12



komplett mit 3 Bohrern
complete with 3 twist drills
complet avec 3 fraises
completo con 3 brocas
completo con 3 punte
33.212.25 - 33.212.35

STILLE SHERMAN

33.220.24
24 cm/9½"



33.240.99

Handbohrapparat allein
 Hand drill only
 Perforateur à main seul
 Perforador de mano suelto
 Perforatore a mano solo

HUDSON
 27 cm/10³/₄"

33.240.27

komplett, mit Fräsern Fig. 1 - 4 **33.242.09 - 33.242.22** und Verlängerungsstück **33.246.00**

complete, with burrs no. 1 - 4 **33.242.09 - 33.242.22** and extension piece **33.246.00**

complet, avec fraises no. 1 - 4 **33.242.09 - 33.242.22** et pièce de rallonge **33.246.00**

completo, con fresas no. 1 - 4 **33.242.09 - 33.242.22** y pieza de prolongación **33.246.00**

completo, con frese fig. 1 - 4 **33.242.09 - 33.242.22** e giunto di prolungamento **33.246.00**



Kegelfräser
 Conical burr
 Fraise conique
 Fresa cónica
 Fresa cuneiforme

33.242.09

Ø9 mm

Fig. 1



Kegelfräser
 Conical burr
 Fraise conique
 Fresa cónica
 Fresa cuneiforme

33.242.14

Ø 14 mm

Fig. 2



Kugelfräser
 Spherical burr
 Fraise sphérique
 Fresa esférica
 Fresa sferica

33.242.16

Ø 16 mm

Fig. 3



Kugelfräser
 Spherical burr
 Fraise sphérique
 Fresa esférica
 Fresa sferica

33.242.22

Ø 22 mm

Fig. 4



Flachbohrer
 Flat trephine
 Fraise plate
 Taladro plano
 Trapano piatto

CUSHING

33.244.14

Ø14 mm

Fig. 5



Spiralbohrer
 Twist drill
 Mèche hélicoïdale
 Broca espiral
 Punta a spirale

33.245.00

Ø 2,0 mm

Fig. 6



Bohrer
 Burr
 Fraise
 Fresa
 Punta

MCKENZIE

33.248.00

Fig. 7



Bohrer
 Burr
 Fraise
 Fresa
 Punta

D'ERRICO

33.249.00

16 mm

Fig. 8

Verlängerungsstück
 Extension piece
 Pièce de rallonge
 Pieza de prolongación
 Giunto di prolungamento



33.246.00



33.246.01

Handbohrapparate

Hand drills
Perforateurs à main
Perforadores de mano
Perforatori a mano

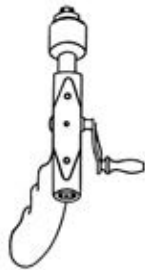
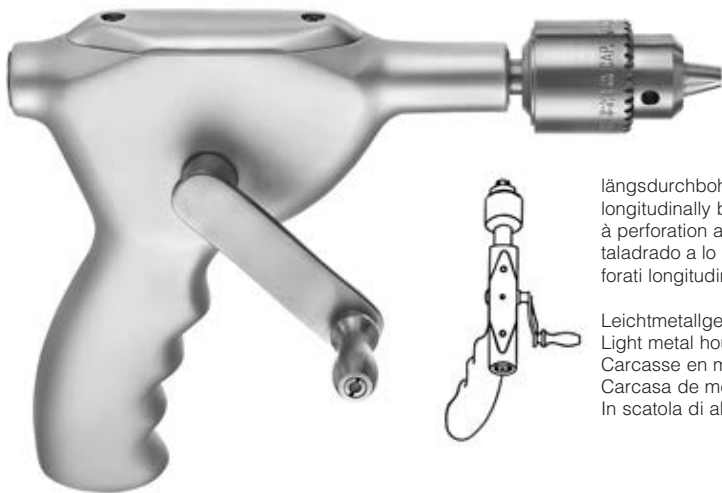

längsdurchbohrt
longitudinally bored
à perforation axiale
taladrado a lo largo
forati longitudinalmente

Leichtmetallgehäuse
Light metal housing
Carcasse en métal léger
Carcasa de metal ligero
In scatola di alluminio



RALK

33.280.00

16 cm/6¼"

33.296.00

Griff umstellbar
Adjustable handle
Manche ajustable
Mango ajustable
Manico reversibile



mit umstellbarem Handgriff und Dreibackenspannfutter, mit Schlüssel,
mit längsdurchbohrtem Kanal für KIRSCHNER Bohrdrähte

with adjustable handle and three-jaw chuck, with wrench,
with axial channel for passing KIRSCHNER wires

avec manche ajustable et mandrin à trois mâchoires, avec clé,
avec conduit longitudinal pour broches de KIRSCHNER

con mango ajustable y mandril de tres mordazas, con llave,
con conducto longitudinal para pasar brocas filiformes de KIRSCHNER

con manico reversibile e mandrino a tre ganasce, con chiave,
con cannulato per il passaggio di perforatori filiformi di KIRSCHNER

33.290.00



glatter Schaft
 smooth shaft
 tige lisse
 vástago liso
 asta liscia

Ø 1,0 mm	33.354.10
Ø 1,5 mm	33.354.15
Ø 2,0 mm	33.354.20
Ø 2,5 mm	33.354.25
Ø 2,8 mm	33.354.28
Ø 3,0 mm	33.354.30
Ø 3,2 mm	33.354.32
Ø 3,5 mm	33.354.35
Ø 4,0 mm	33.354.40



lieferbar in Packungen à 10 Stück
 available in packages with 10 pieces
 disponibles en paquets de 10 pièces
 disponibile en paquetes de 10 piezas
 disponibili in confezioni da 10 pezzi

Trokarspitze, rundes Ende
 Trocar point, round end
 Pointe de trocart, extrémité ronde
 Punta de trócar, cabo redondo
 Punta a trequarti, asta rotonda

KIRSCHNER
 16 cm/6¼"

Ø 0,7 mm	33.417.07
Ø 0,8 mm	33.417.08
Ø 0,9 mm	33.417.09
Ø 1,0 mm	33.417.10
Ø 1,1 mm	33.417.11
Ø 1,2 mm	33.417.12
Ø 1,3 mm	33.417.13
Ø 1,4 mm	33.417.14
Ø 1,5 mm	33.417.15
Ø 1,6 mm	33.417.16
Ø 1,7 mm	33.417.17
Ø 1,8 mm	33.417.18
Ø 1,9 mm	33.417.19
Ø 2,0 mm	33.417.20
Ø 2,2 mm	33.417.22
Ø 2,4 mm	33.417.24
Ø 2,5 mm	33.417.25
Ø 2,7 mm	33.417.27
Ø 3,0 mm	33.417.30
Ø 4,0 mm	33.417.40

Drahtschneidezangen

Wire cutting pliers

Pinces à couper le fil

Alicates para cortar alambre

Tenaglie tagliafili



33.545.22
22,5 cm/9"

mit TC-Einsätzen
with TC inserts
avec mors TC
con bocas TC
con morso TC



REILL
33.547.17
17,5 cm/7"



33.556.57
57,5 cm/22½"



SAUERBRUCH
56.131.26
26 cm/10¼"



GIERTZ-STILLE
56.137.27
27 cm/10½"

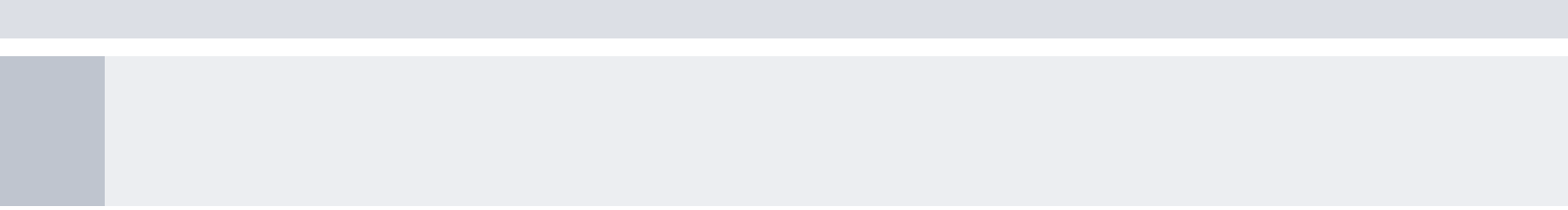

11

◆ SCHÄDEL INSTRUMENTE

SKULL INSTRUMENTS

INSTRUMENTS CRÂNIENNES

INSTRUMENTOS PARA CRANEOTOMÍA

STRUMENTI PER CRANIOTOME

Klammer-Anlegezange

Clips applying forceps

Pinças à poser agrafes

Pinzas para aplicar grapas

Pinza per applicare i fermagli d'argento



McKENZIE

15 cm/6"	40.011.15
19 cm/7½"	40.011.19



McKENZIE

15 cm/6"	40.013.15
19 cm/7½"	40.013.19



SMITHWICK

23 cm/9"	40.015.23
26 cm/10¼"	40.015.26



SWEET

23 cm/9"	40.017.23
26 cm/10¼"	40.017.26

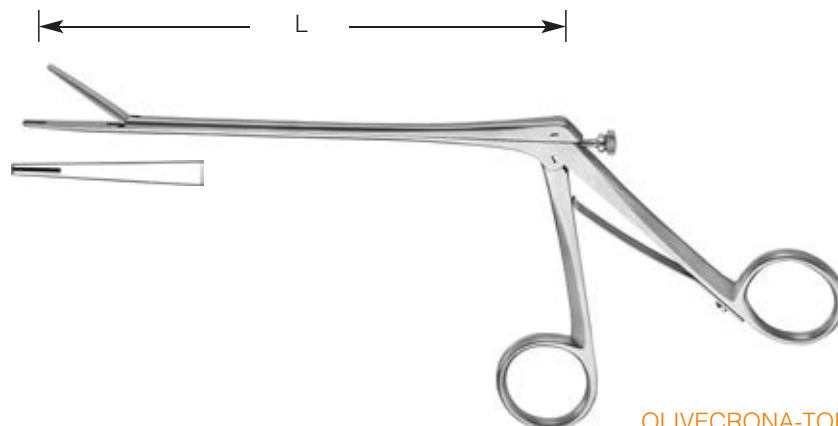

OLIVECRONA-TOENNIS

14 cm/5½"	40.019.14
20 cm/8"	40.019.20



40.021.00

Silberklammern in Plastikbehälter, Packung à 100 Stück
 Silver clips in plastic vial, package of 100 pieces
 Agrafes en argent, boîte de 100 pièces
 Grapas de plata en tubo de plástico, caja de 100 piezas
 Fermagli d'argento, scatole di 100 pezzi



40.022.00

Kölner Spar Klammer, Packung à 50 Stück
 Kölner clip reusable, package of 50 pieces
 Kölner agrafe économique, boîte de 50 pièces
 Kölner grapa económica, caja de 50 piezas
 Kölner agrafe economica, scatole di 50 pezzi



RANEY
40.027.00

Kopfhautklammer
 Scalp hemostasis clip
 Agrafes hémostatique pour cuir chevelu
 Pinza hemostática para cuero cabelludo
 Clip emostatici per cuoio capelluto



RANEY
40.028.00
 15,5 cm/6¼"

Anlege-und Abnehme-Zange für Kopfhautklammern
 Applying and removing forceps for scalp hemostasis clips
 Pince à poser et retirer les clips hémostatiques du cuir chevelu
 Pinza para aplicar y quitar clips hemostáticas de cuero cabelludo
 Pinza per applicare o togliere i clip emostatici al cuoio capelluto

Schädelhalter

Skull traction tongs

Portes crânes

Estribos de tracción craneal

Pinze per trazione craniale



40.024.00

großes Modell
large pattern
modèle grand
modelo grande
modello grande



40.024.10

Ersatzdorn
Spare pin
Pointe de rechange
Espina de repuesto
Punta di ricambio

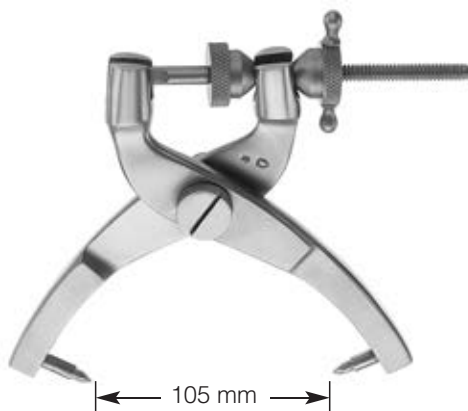

CRUTCHFIELD
40.025.01

kleines Modell
small pattern
modèle petit
modelo pequeño
modello piccolo



CRUTCHFIELD
40.025.02

mittleres Modell
medium pattern
modèle moyen
modelo mediano
modello medio



CRUTCHFIELD
40.026.35
7 cm/2¾"
Ø 3,5 mm

Vorbohrer
Drill point
Alésoir
Perforador
Alesatore



CRUTCHFIELD
40.026.50
7 cm/2¾"
Ø 5,0 mm

Vorbohrer
Drill point
Alésoir
Perforador
Alesatore

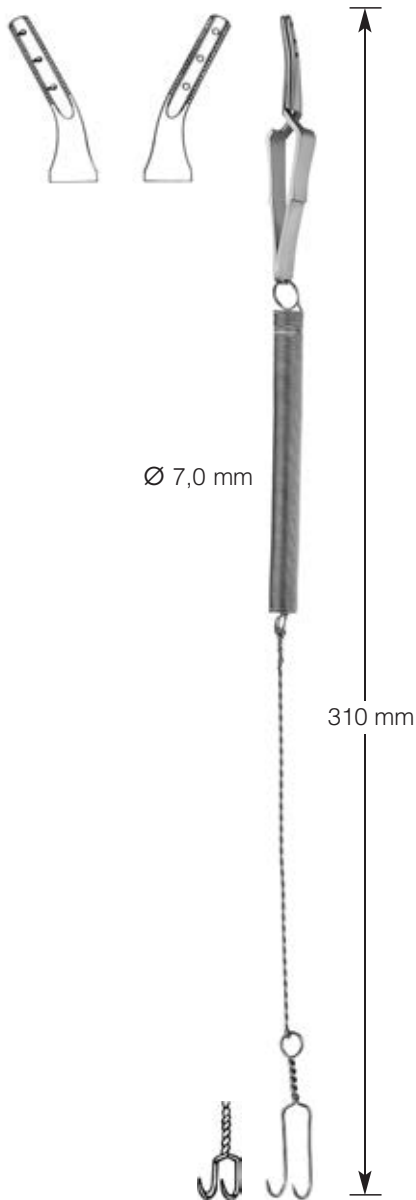

Ø 7,0 mm

310 mm

YASARGIL
40.030.31
31 cm/12¼"



Ø 9,0 mm

410 mm

YASARGIL
40.030.41
41 cm/16"

Drahtsägen

Wire saws
Scies à fil
Sierras de hilo
Fili sega

Einführinstrument
Wire saw guide
Conducteur pour scies à fil
Conductor para sierras de hilo
Introduttore



De MARTEL
40.090.33
33 cm/13"



LEBSCHKE
40.091.25
25 cm/10"



GIGLI
40.094.00

1 Paar
1 Pair
1 Paire
1 Par
1 Paio



GIGLI
40.094.01

1 Paar
1 Pair
1 Paire
1 Par
1 Paio

Drahtsägen-Handgriff
Wire saw handle
Manche à crochet
Mango de gancho
Manico con uncino

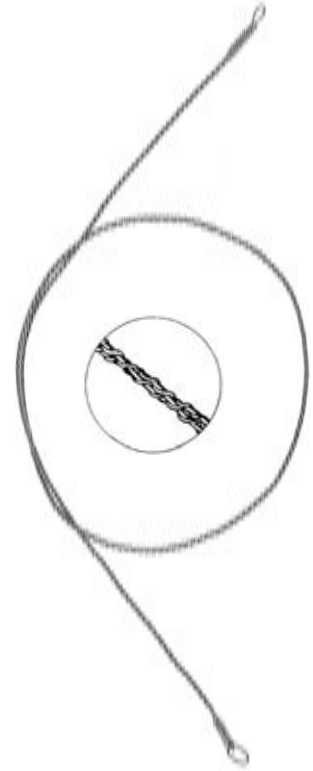

OLIVECRONA

23 cm/9"	40.092.22
30 cm/12"	40.092.30
40 cm/16"	40.092.40
50 cm/20"	40.092.50
60 cm/24"	40.092.60
70 cm/28"	40.092.70
75 cm/30"	40.092.75

2 x

GIGLI

25 cm/10"	40.093.25
30 cm/12"	40.093.30
40 cm/16"	40.093.40
50 cm/20"	40.093.50
60 cm/24"	40.093.60
70 cm/28"	40.093.70

3 x

OLIVECRONA-GIGLI

30 cm/12"	40.094.30
40 cm/16"	40.094.40
50 cm/20"	40.094.50
60 cm/24"	40.094.60
70 cm/28"	40.094.70

4 x

Bohrloch-Schutzzange, Schädeltrephinen

Bore hole protection forceps, skull trephines
Pinces pour protéger alésage, trépanes crâniennes
Pinzas para la protección de orificio, trépanos craneales
Pinze per la protezione di foro, trapano cranico

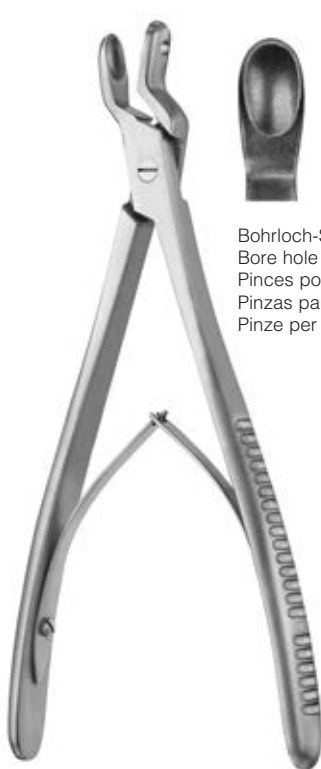

Bohrloch-Schutzzange
Bore hole protection forceps
Pinces pour protéger alésage
Pinzas para la protección de orificio
Pinze per la protezione di foro

40.095.20
20,5 cm/8"



bis 12 mm Schädelstärke
for skull thickness up to 12 mm
pour épaisseur de la boîte crânienne jusqu'à 12 mm
hasta 12 mm de espesor de la pared craneal
per spessore cranico fino a mm. 12

CONE
40.098.23
23 cm/9"

Schädelstanzen

Skull punches

Pinces emporte-pièce crâniennes

Pinzas saca-bocadas para craneotomía

Pinze craniotome



DeVILBISS
40.096.21
21 cm/8¼"

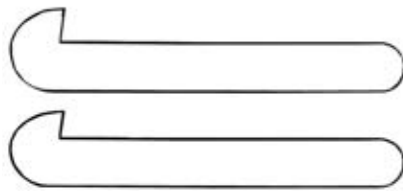

komplett mit je 1 kleinen und 1 großen Blatt
complete with 1 small and 1 large blade
complète avec 1 petit et 1 grand crochet
completa con 1 gancho pequeño y 1 gancho grande
completa di 1 uncino piccolo ed 1 uncino grande



DAHLGREN
40.097.20
21 cm/8¼"



komplett mit 2 Reserveblättern
complete with 2 spare blades
complète avec 2 crochets de rechange
completa con 2 ganchos de repuesto
completa di 2 uncini di ricambio

12



◆ **HAKEN, DISSEKTOREN**

HOOKS, DISSECTORS

CROCHETS, DISSECTEURS

GANCHOS, DISECTORES

UNCINI, DISSETTORI

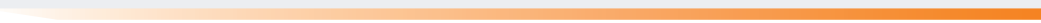

Schleimhauthäkchen

Mucosa hooklet
Crochet pour la muqueuse
Ganchito para mucosa
Uncino per mucosa

Hauthäkchen
Skin hooks
Crochets pour la peau
Ganchitos para piel
Uncini per la pelle



spitz
sharp
pointu
agudo
acuto

CAIRNS
18.206.13
13 cm/5"



LAHEY
18.213.13
13 cm/5"



CUSHING
18.213.14
14 cm/5½"



FRAZIER



18.214.13
13 cm/5"

spitz
sharp
pointu
agudo
acuto



18.214.18
18 cm/7"

spitz
sharp
pointu
agudo
acuto



18.215.13
13 cm/5"

stumpf
blunt
mousse
romo
smusso



18.215.18
18 cm/7"

stumpf
blunt
mousse
romo
smusso



spitz
sharp
pointu
agudo
acuto

JOSEPH
18.216.01
16 cm/6¼"



18.216.02
2 mm

18.216.07
7 mm

spitz
sharp
pointu
agudo
acuto

JOSEPH
16 cm/6¼"



18.216.05
5 mm

18.216.10
10 mm



spitz
sharp
pointu
agudo
acuto

FREER
18.218.15
15 cm/6"



spitz
sharp
pointu
agudo
acuto

TOENNIS
18.219.15
15 cm/6"



SCOVILLE
40.044.23
23 cm/9"



SCOVILLE
40.048.19
19 cm/7½"



O'CONNELL
40.046.22
22 cm/8¾"

Nerwurzelhaken

Nerve root retractors
Retracteurs pour racine des nerfs
Separadores para la raíz de nervio
Uncini per le radici di nervi



40.049.21
21 cm/8¼"



links
left
à gauche
a la izquierda
sinistra

DANDY
40.051.20
20 cm/8"



DANDY
40.052.20
20 cm/8"



rechts
right
à droite
a la derecha
destra

DANDY
40.053.20
20 cm/8"



CRILE
40.054.20
 20 cm/8"
 Fig. 1



CUSHING

Fig. 1
40.056.19
 19 cm/7½"
40.056.28
 28 cm/11"

Fig. 2
40.058.19
 19 cm/7½"
40.058.28
 28 cm/11"



HOEN
40.060.23
 23 cm/9"



stumpf
 blunt
 mousse
 romo
 smusso



GRAHAM
40.061.16
 16,5 cm/6½"

stumpf
 blunt
 mousse
 romo
 smusso



SACHS
40.064.18
 18,5 cm/7¼"

spitz
 sharp
 pointu
 agudo
 acuto

Explorations- und Koagulationshäkchen
 Exploration and coagulation hooks
 Crochets pour exploration et coagulation
 Ganchos para exploración y coagulación
 Uncini per esplorazione e coagulazione

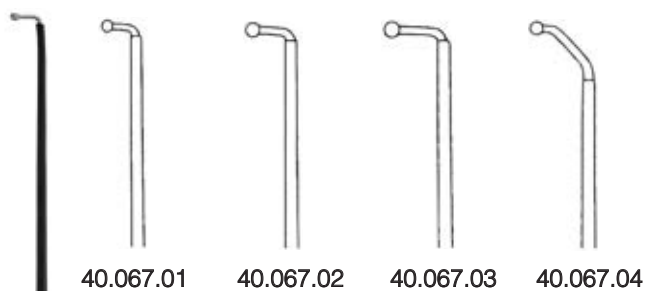

CASPAR
 24,5 cm/9¾"

CASPAR (CCR)	132 - 136
	179 - 184
Siehe auch Seite:	199
See also page:	212
Voir aussi la page:	228
Véase también la página:	228
Vedere anche pagina:	230

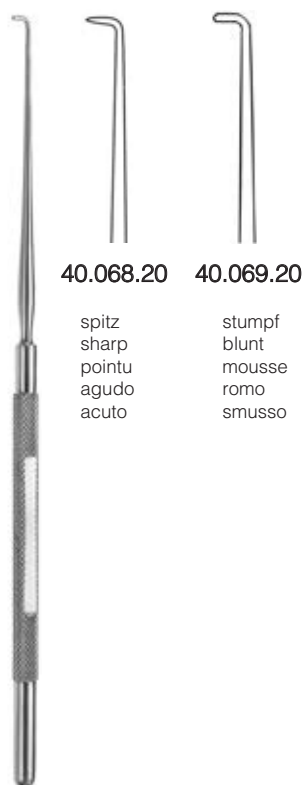

ADSON
 20 cm/8"



GRONINGEN
 26,5 cm/10½"

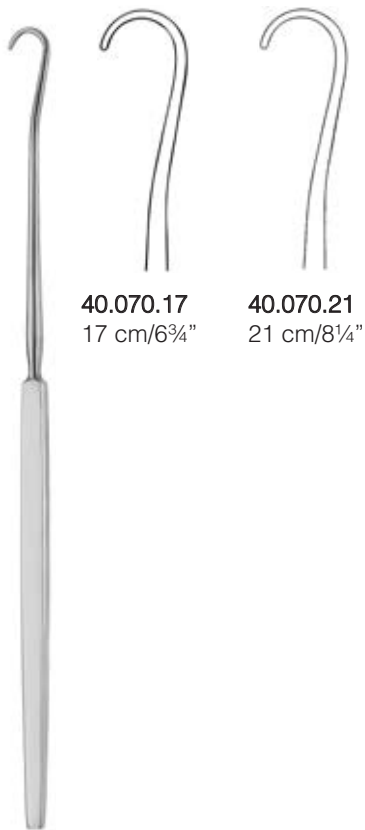

SMITHWICK



SMITHWICK
40.070.29
29 cm/11½"



SCOVILLE
40.070.30
30 cm/12"



SCOVILLE
40.071.30
30 cm/12"

Nerwurzelhaken

Nerve root retractors
Retractors pour racine des nerfs
Separadores para la raíz de nervio
Uncini per le radici di nervi



LOVE
40.071.21
21 cm/8¼"

CASPAR
24 cm/9½"
6 mm 40.072.06
8 mm 40.072.08
10 mm 40.072.10



40.073.03
3 mm

40.073.05
5 mm

40.073.07
7 mm

HESS (LOVE modif.)
17,5 cm/7"

CASPAR (CCR)	132 - 136
	179 - 184
Siehe auch Seite:	199
See also page:	212
Voir aussi la page:	228
Véase también la página:	228
Vedere anche pagina:	230

Aneurysmen-Nadel
 Aneurysm needle
 Aiguille d'anévrisme
 Aguja para aneurisma
 Ago da aneurisma



ADSON
40.078.22
 22 cm/8¾"
 2 mm



LOVE
40.080.19
 19 cm/7½"



45°

LOVE
40.081.19
 19 cm/7½"



90°

LOVE
40.083.19
 19 cm/7½"

Raspatorien

Periosteal elevators
Rugines-raspatoires
Periostótomos
Periostotomi

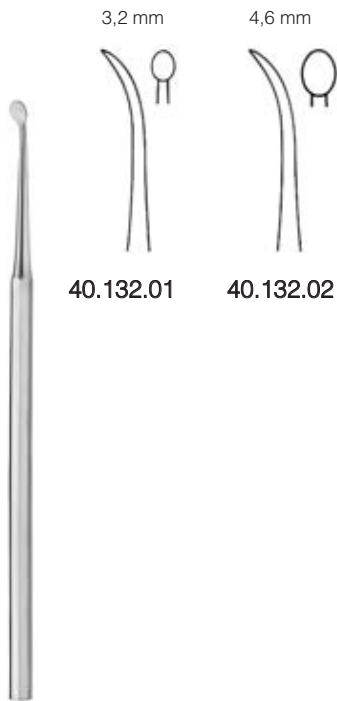

40.132.01

40.132.02

PARTSCH

15 cm/6"



LANGE

40.132.14

14,5 cm/5¾"

LEMPERT

40.133.16

16,5 cm/6½"

stumpf
blunt
mousse
romo
smusso



halbscharf
semi-sharp
semi-pointu
semi agudo
semi acuto

40.136.16

spitz
sharp
pointu
agudo
acuto

40.138.16

stumpf
blunt
mousse
romo
smusso

LEMPERT

40.134.18

18,5 cm/7¼"

ST CLAIR THOMPSON

16 cm/6¼"



HALLE

40.139.16

16 cm/6¼"

SUNDAY

40.140.23

23 cm/9"

stumpf
blunt
mousse
romo
smusso

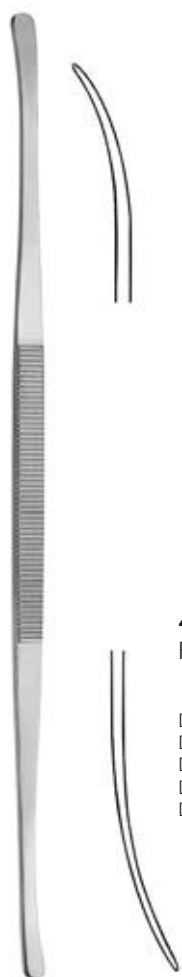

TOENNIS
 25 cm/10"



40.141.25
 Fig. 1

Dissektoren
 Dissectors
 Dissecteurs
 Disectores
 Dissettori



40.142.25
 Fig. 2



SACHS
40.143.21
 21 cm/8¼"



spitz
 sharp
 pointu
 agudo
 acuto



SACHS
40.145.21
 21 cm/8¼"



spitz
 sharp
 pointu
 agudo
 acuto



MILLIGAN
40.147.21
 21 cm/8¼"



Dissektoren

Dissectors
Dissecteurs
Disectores
Dissettori

Sonde und Dissektor
Probe and dissector
Sonde et dissecteur
Sonda y disector
Sonda e dissettore

Elevatoren
Separators
Separateurs
Separadores
Elevatori

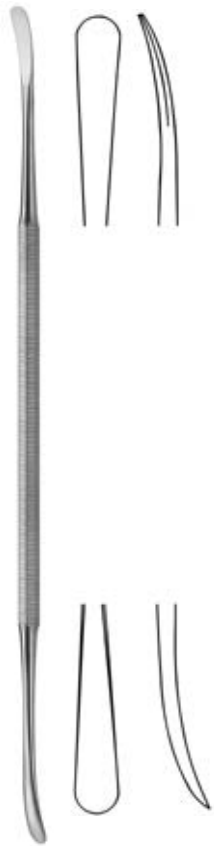

MILLIGAN
40.149.22
22 cm/8¾"



PENNYBAKER
40.149.23
23 cm/9"



DAVIS
40.151.24
24,5 cm/9¾"

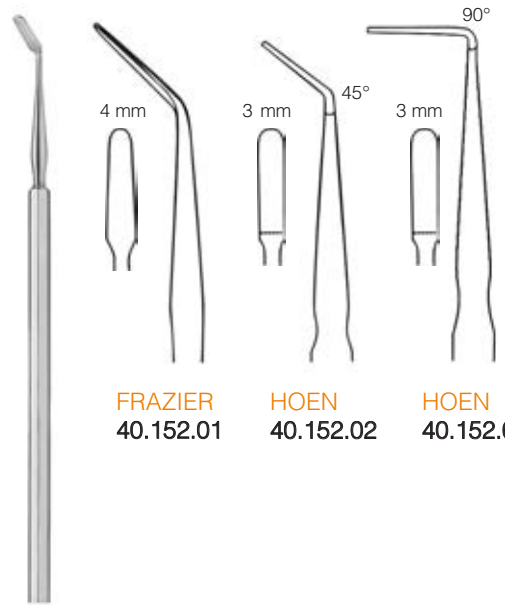

FRAZIER
40.152.01

HOEN
40.152.02

HOEN
40.152.03

15 cm/6"

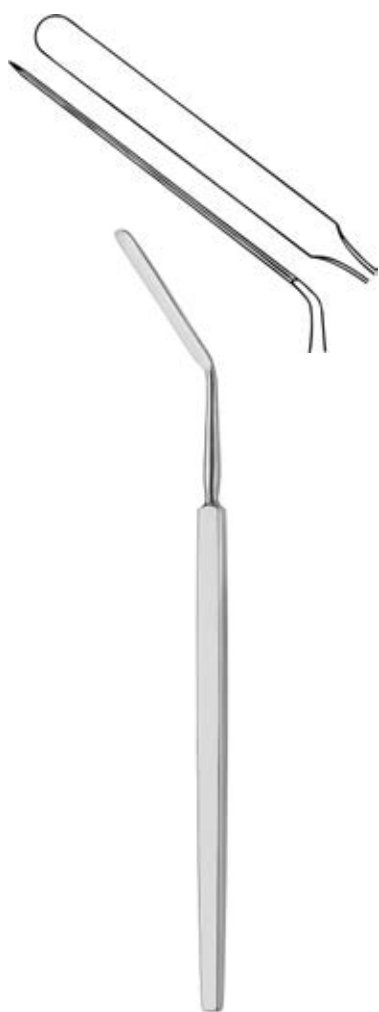

HORSLEY
40.155.20
20 cm/8"



SACHS
40.157.21
21 cm/8¼"

Dissektor mit flexiblem Schaft
Dissector with flexible shaft
Dissecteur à tige malléable
Dissector con vástago maleable
Dissector con asta flessibile



40.157.19
4 mm

für Kinder
for children
pour enfants
para niños
per i bambini

40.159.19
7 mm

für Erwachsene
for adults
pour adultes
para adultos
per adulti

YASARGIL
19,5 cm/7¾"

Dissektoren

Dissectors
Dissecteurs
Disectores
Dissettori



PENFIELD
40.161.01
17,5 cm/7"
Fig. 1



PENFIELD
40.161.02
19,5 cm/7¾"
Fig. 2



PENFIELD
40.161.03
19,5 cm/7¾"
Fig. 3



PENFIELD
40.161.04
20,5 cm/8"
Fig. 4



PENFIELD
40.161.05
18,5 cm/7¼"
Fig. 5

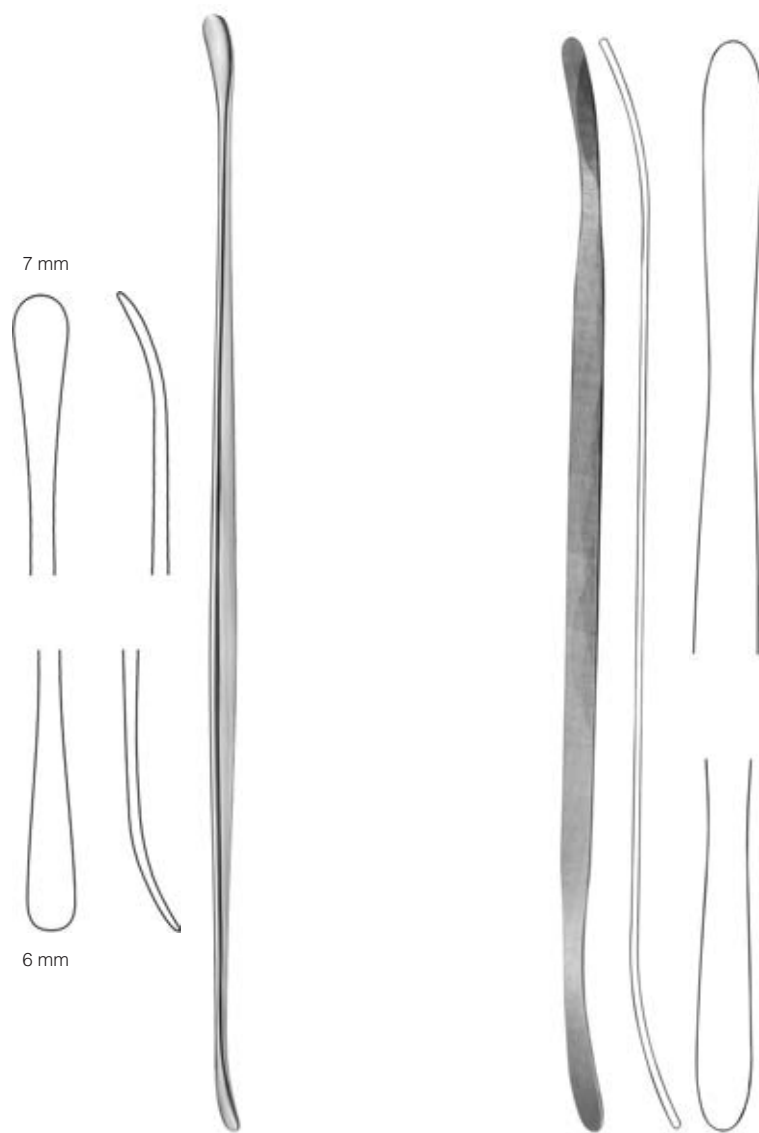

40.162.29
29 cm/11½"

40.163.29
29 cm/11½"

Trigeminusmesser
Trigeminal knife
Couteau pour trijumeau
Cuchillo para trigémino
Coltello per trigemino



40.167.23
23 cm/9"



TOENNIS

40.170.13
13 cm/5"



40.170.19
19 cm/7½"



HALLE
40.170.20
20 cm/8"

13



◆ **MIKRO-INSTRUMENTE MIT RUNDGRIFF**

MICRO INSTRUMENTS WITH ROUND HANDLES

MICRO-INSTRUMENTS À MANCHE ROND

INSTRUMENTOS PARA MICROCIURGÍA CON MANGOS REDONDOS

STRUMENTI PER MICROCHIRURGIA CON MANICO ROTONDO

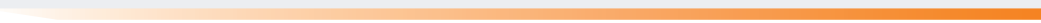

Mikro-Instrumente mit Rundgriff

Micro instruments with round handles

Micro-instruments à manche rond

Instrumentos para microcirugía con mangos redondos

Strumenti per microchirurgia con manico rotondo

Raspatorien
Raspatories
Rugines
Legras
Periostotomi



40.062.02
2,5 mm

40.062.03
2,0 mm

40.062.04
2,0 mm

Küretten
Curettes
Curettes
Curetas
Curette

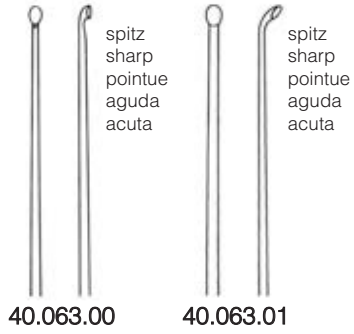

40.063.00

40.063.01

1,5 mm

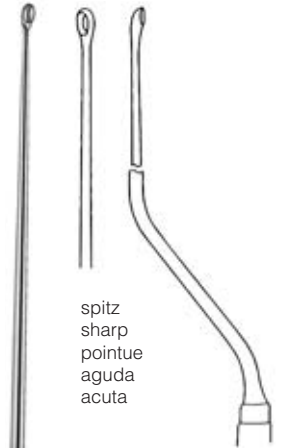

spitz
sharp
pointue
aguda
acuta

YASARGIL
18,5 cm/7¼"

YASARGIL
23 cm/9"

YASARGIL
40.063.19
18,5 cm/7¼"

Nerv- und Gefäßhäkchen
 Nerve and vessel hooks
 Crochets à nerfs et vasculaires
 Ganchos para nervios y vasos
 Uncini per nervi e vasi

Fadenführer, geknöpft
 Ligature guides and carriers, probe pointed
 Passe-fils, boutonné
 Guía-ligadura, abotonada
 Guide per legatura, abbottonato



18,5 cm/7¼"



KRAYENBÜHL
40.065.01
 Fig. 1



KRAYENBÜHL
40.065.02
 Fig. 2



KRAYENBÜHL
40.065.03
 Fig. 3



KRAYENBÜHL
40.065.04
 Fig. 4



YASARGIL
40.064.01
 Fig. 1



YASARGIL
40.064.02
 Fig. 2



YASARGIL
40.064.03
 Fig. 3



YASARGIL
40.064.04
 Fig. 4

Mikro-Instrumente mit Rundgriff

Micro instruments with round handles

Micro-instruments à manche rond

Instrumentos para microcirugía con mangos redondos

Strumenti per microchirurgia con manico rotondo

Gefäß-Messer
Vessel knife
Couteau pour vaisseaux
Cuchillo para vasos
Coltello per vasi



18,5 cm/7¼"



KOOS
40.065.51

aufgebogen
upwards curved
courbé vers le haut
curva hacia arriba
curvo in sú



KOOS
40.065.52

abgebogen
downwards curved
courbé vers le bas
curva hacia abajo
curvo in giú



KOOS
40.065.57

aufgebogen
upwards curved
courbé vers le haut
curva hacia arriba
curvo in sú



KOOS
40.065.56

abgebogen
downwards curved
courbé vers le bas
curva hacia abajo
curvo in giú



KOOS
40.065.53

aufgebogen
upwards curved
courbé vers le haut
curva hacia arriba
curvo in sú



KOOS
40.065.54

abgebogen
downwards curved
courbé vers le bas
curva hacia abajo
curvo in giú

Arachnoidea Messer
Arachnoid knife
Couteaux arachnoïdiens
Aracnoïdes cuchillos
Arachnoidea coltelli



YASARGIL
40.065.65

abgebogen
downwards curved
courbé vers le bas
curva hacia abajo
curvo in giú



YASARGIL
40.065.66

aufgebogen
upwards curved
courbé vers le haut
curva hacia arriba
curvo in sú

Raspatorien
Raspatories
Rugines
Legras
Periostotomi



40.066.01



40.066.02



40.066.03



40.066.04



40.066.05



40.066.06

YASARGIL
19 cm/7½"

Mikro-Instrumente mit Rundgriff

Micro instruments with round handles

Micro-instruments à manche rond

Instrumentos para microcirugía con mangos redondos

Strumenti per microchirurgia con manico rotondo



Gefäßspreizer
Vessel spreader
Écarteur pour vaisseaux
Separador para vasos
Divaricatore per vasi



BIEMER
40.066.10
16 cm/6¼"

Gefäßdilatoren
Vessel dilators
Dilatateurs vasculaires
Dilatadores vasculares
Dilattatori vascolari

Ø 0,5 mm



40.066.16
12,5 cm/5"

Ø 1,0 mm



40.066.17
12,5 cm/5"

Ø 1,5 mm



40.066.18
12,5 cm/5"

Knopfsonde
Buttoned probes
Sondes boutonnées
Sondas abotonadas
Sonda abbottonata



JACOBSON
40.066.19
18,5 cm/7¼"



JACOBSON
40.066.20
18,5 cm/7¼"



Tumormesser
 Tumor knives
 Couteaux à tumeurs
 Cuchillos para tumores
 Coltelli per tumori



40.075.10
 1,0 mm



40.075.11
 1,5 mm



40.075.12
 2,0 mm



40.075.13
 2,5 mm



40.075.14
 3,0 mm



40.075.15
 3,5 mm



40.075.16
 4,0 mm



40.075.18
 5,0 mm

Messer für Tumorgewebe
 Knives for tumor tissue
 Couteaux pour tissu de tumeur
 Cuchillos para tejidos con tumores
 Coltelli per tessuto tumorale



40.076.01
 1,5 mm



40.076.02
 3,0 mm



40.076.03
 4,5 mm



40.076.04
 6,0 mm

Lanzettenmesser für Tumorgewebe
 Lancet knives for tumor tissue
 Couteaux lancéolaires pour tissu de tumeur
 Cuchillos en forma de lanceta para tejidos con tumores
 Coltelli lanceolato per tessuto tumorale



40.077.18
 1,8 mm



40.077.25
 2,5 mm

Tumorgabeln
 Tumor forks
 Fourches à tumeurs
 Horquillas para tumores
 Forchette per tumori

5 mm

8 mm



40.079.05



40.079.08

SAMII
 23 cm/9"

YASARGIL
 20 cm/8"

Mikro-Instrumente mit Rundgriff

Micro instruments with round handles

Micro-instruments à manche rond

Instrumentos para microcirugía con mangos redondos

Strumenti per microchirurgia con manico rotondo



CASPAR



40.171.01
23 cm/9"
4,5 mm



40.171.02
23 cm/9"
4,5 mm



40.171.03
23 cm/9"
2 mm



CASPAR



40.173.01
20 cm/8"
1 mm

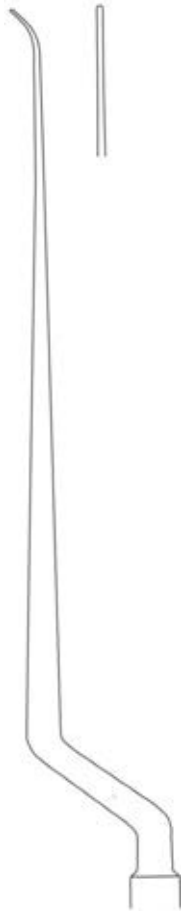

40.173.02
21 cm/8¼"
1 mm



40.173.03
21 cm/8¼"
1 mm

Mikro-Instrumente mit Rundgriff

Micro instruments with round handles

Micro-instruments à manche rond

Instrumentos para microcirugía con mangos redondos

Strumenti per microchirurgia con manico rotondo

Fadengabel
Knot tier and ligature pusher
Fourche pour fil à suturer
Horquilla para ligadura
Forchetta per legatura



JACOBSON
40.172.19
23 cm/9"



CASPAR
40.171.04
23 cm/9"

auswechselbares Gefäßmesser
interchangeable vessel knife
couteau à vaisseaux échangeable
cuchillo cambiabile
sostituibili nave coltello



JACOBSON
40.172.01
9,5 cm/3¾"



40.172.02
9,5 cm/3¾"

auswechselbares Häckchen
interchangeable hook
crochet échangeable
gancho cambiabile
sostituibili gancio

Griff mit Spannfutter
Handle with chuck
Manche avec mandrin
Mango con mandril
Maneggiare con chuck

40.172.10
10,5 cm/4"



Tumorgabeln
Tumor forks
Fourches à tumeurs
Horquillas para tumores
Forchette per tumori



40.174.03
3 mm



40.174.04
4 mm



40.174.05
5 mm



40.174.08
8 mm

OKONEK-YASARGIL
23 cm/9"



40.180.01
 Ø 1 mm

Dissektor, rund
 Dissector, round
 Dissecteur, ronde
 Disector, rondo
 Dissettora, rotondo



40.180.02
 Ø 2 mm

Dissektor, rund
 Dissector, round
 Dissecteur, ronde
 Disector, rondo
 Dissettora, rotondo



40.180.03
 Ø 3 mm

Dissektor, rund
 Dissector, round
 Dissecteur, ronde
 Disector, rondo
 Dissettora, rotondo



40.180.04
 1,2 mm

Elevator
 Elevator
 Elévateur
 Elevador
 Elevatori



40.180.05
 2,8 mm

Elevator
 Elevator
 Elévateur
 Elevador
 Elevatori



40.180.06
 1 mm

Dissektor, spatelförmig
 Dissector, spatula
 Dissecteur, spatulé
 Disector, espatulado
 Dissettora, spatulate



40.180.07
 1,5 mm

Dissektor, spatelförmig
 Dissector, spatula
 Dissecteur, spatulé
 Disector, espatulado
 Dissettora, spatulate



40.180.08
 2 mm

Dissektor, spatelförmig
 Dissector, spatula
 Dissecteur, spatulé
 Disector, espatulado
 Dissettora, spatulate

RHOTON
 19 cm/7½"

Mikro-Instrumente mit Rundgriff

Micro instruments with round handles

Micro-instruments à manche rond

Instrumentos para microcirugía con mangos redondos

Strumenti per microchirurgia con manico rotondo



RHOTON
19 cm/7½"



40.180.09
2 mm

Häckchen, halbscharf
Hook, semi-sharp
Crochet, semi-pointu
Gancho, semi agudo
Gancio, semi acuto



40.180.10
2 mm

Häckchen, stumpf
Hook, blunt
Crochet, mousse
Gancho, romo
Gancio, smusso



40.180.11
3 mm

Häckchen, halbscharf
Hook, semi-sharp
Crochet, semi-pointu
Gancho, semi agudo
Gancio, semi acuto



40.180.12

Nadel, halbscharf
Needle, semi-sharp
Aiguille, semi-pointu
Aguja, semi agudo
Ago, semi acuto



40.180.16

Knopfsonde
Buttoned probe
Sonde boutonnée
Sonda abotonada
Sonda abbottonata



40.180.13
1 x 2 mm

Kürette, oval
Curette, oval
Curette, oval
Cureta, oval
Curette, ovale

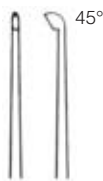

40.180.14
1 x 2 mm

Kürette, oval
Curette, oval
Curette, oval
Cureta, oval
Curette, ovale

Gewebekrallen
 Tissue claws
 Griffes tissulaires
 Garras para tejido
 Artiglie per tessuti

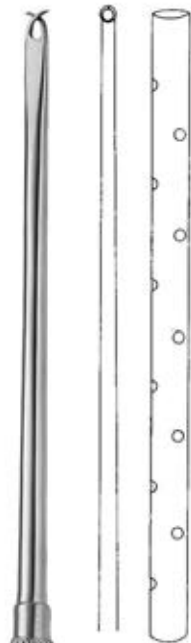

mit Schutzkappe
 with guard
 avec capuchon
 con una tapa protectora
 con un cappuccio protettivo

18,5 cm/7¼"

Ø 1,0 mm	40.190.10
Ø 1,8 mm	40.190.18



90° scharf
 90° sharp
 90° pointu
 90° agudo
 90° acuto

40.191.01
 18,5 cm/7¼"

90° stumpf
 90° blunt
 90° mousse
 90° romo
 90° smusso

FISCH
40.191.02
 18,5 cm/7¼"



40.191.23
 23 cm/9"

scharf
 sharp
 pointu
 agudo
 acuto



40.191.24
 23 cm/9"

stumpf
 blunt
 mousse
 romo
 smusso



Mikro-Gefäßmesser
 Micro vessel knife
 Micro couteau pour vaisseaux
 Micro cuchillo para vasos
 Micro coltello per vasi

JACOBSON
40.065.50
 18,5 cm/7¼"

Fußplattenhäkchen
 Hook
 Crochet
 Ganchito
 Uncino



FISCH
40.191.16
 16 cm/6¼"

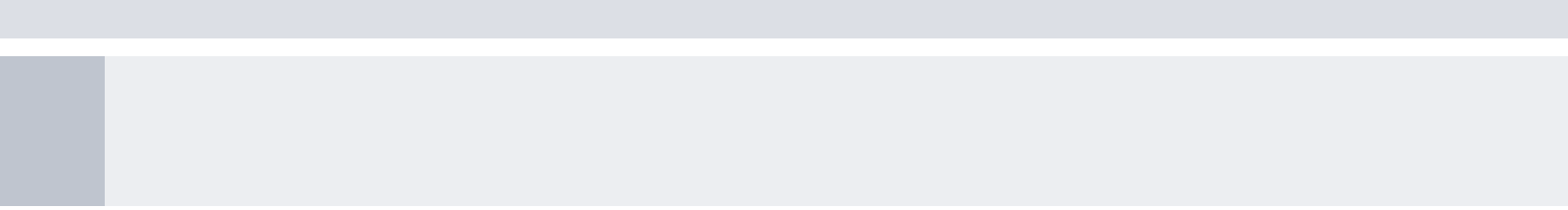

14



◆ SPATEL

SPATULAS

SPATULES

ESPÁTULAS

SPATOLE





biegsam
malleable
malléable
maleable
malleabile

CUSHING

40.250.07	7/9 x 180 mm
40.250.11	11/13 x 180 mm
40.250.15	15/18 x 180 mm
40.250.18	18/22 x 180 mm



konvex
convex
convexe
convexa
convessa

OLIVECRONA

40.252.13	7/9 x 180 mm
40.252.15	11/13 x 180 mm
40.252.17	15/18 x 180 mm
40.252.19	18/22 x 180 mm

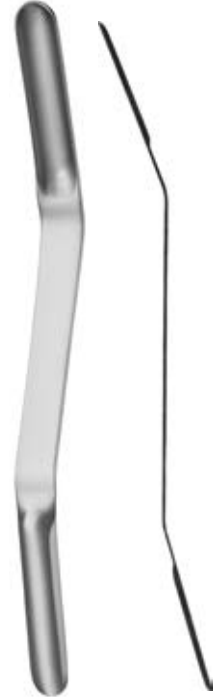

konkav
concave
concave
côncava
concava

OLIVECRONA

40.253.07	7/9 x 180 mm
40.253.11	11/13 x 180 mm
40.253.15	15/18 x 180 mm
40.253.18	18/22 x 180 mm



biegsam
malleable
malléable
maleable
malleabile

SCOVILLE

40.254.10	10/13 x 200 mm
40.254.16	16/19 x 200 mm



biegsam
malleable
malléable
maleable
malleabile

AACHEN

40.256.07	7/8 x 200 mm
40.256.10	10/11 x 200 mm
40.256.13	13/14 x 200 mm
40.256.16	16/17 x 200 mm
40.256.19	19/20 x 200 mm
40.256.22	22/25 x 200 mm



biegsam
malleable
malléable
maleable
malleabile

40.257.01	9 x 200 mm
40.257.02	12 x 200 mm
40.257.03	12 x 250 mm

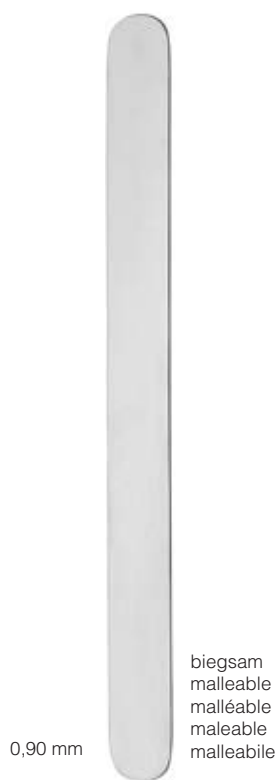

CAIRNS

40.258.06	6 x 200 mm
40.258.08	8 x 200 mm
40.258.10	10 x 200 mm
40.258.11	11 x 200 mm
40.258.13	13 x 200 mm
40.258.16	16 x 200 mm
40.258.19	19 x 200 mm
40.258.25	25 x 200 mm

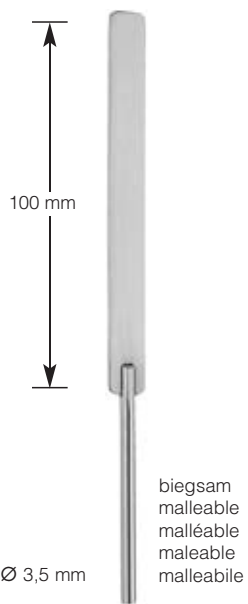

HEIFETZ

40.259.08	8 x 155 mm
40.259.11	11 x 155 mm
40.259.14	14 x 155 mm
40.259.17	17 x 155 mm

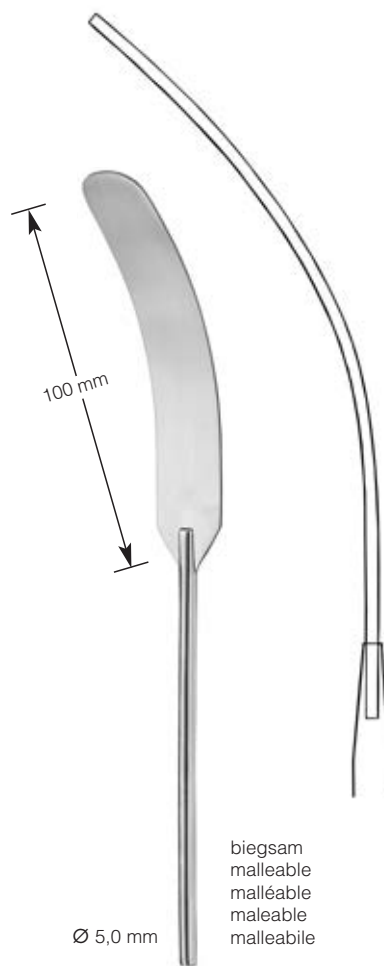

HEIFETZ

40.260.08	8 x 200 mm
40.260.11	11 x 200 mm
40.260.14	14 x 200 mm
40.260.17	17 x 200 mm
40.260.20	20 x 200 mm

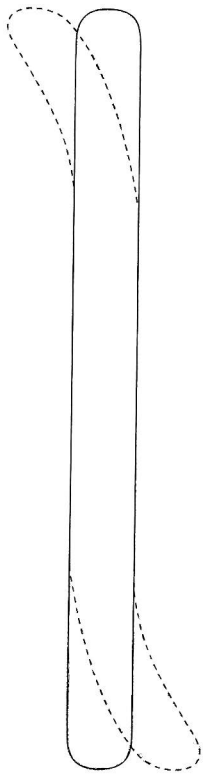

biegsam
malleable
malléable
maleable
malleabile

RIBBON

18.168.06	6 x 200 mm
18.168.07	7 x 200 mm
18.168.09	9 x 200 mm
18.168.12	12 x 200 mm
18.168.17	17 x 200 mm
18.168.20	20 x 200 mm
18.168.24	25 x 200 mm
18.168.25	25 x 250 mm



biegsam
malleable
malléable
maleable
malleabile

RIBBON

18.170.13	13 x 330 mm
18.170.19	19 x 330 mm
18.170.25	25 x 330 mm
18.170.30	30 x 330 mm
18.170.32	32 x 330 mm
18.170.40	40 x 330 mm
18.170.45	45 x 330 mm
18.170.50	50 x 330 mm
18.170.64	64 x 330 mm
18.170.75	75 x 330 mm



biegsam, sehr weich
malleable, very soft
malléable, très souple
maleable, muy blando
malleabile, molto dolci

MARTIN

18.173.06	6,5 x 200 mm
18.173.09	9,5 x 200 mm
18.173.13	13 x 200 mm
18.173.16	16 x 200 mm
18.173.19	19 x 200 mm
18.173.25	25 x 200 mm

15



◆ SAUGROHRE

SUCTION TUBES

TUBES D'ASPIRATION

TUBOS DE ASPIRACIÓN

TUBI D'ASPIRAZIONE

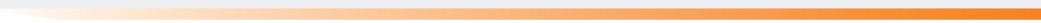

Saugrohre

Suction tubes
 Tubes d'aspiration
 Tubos de aspiración
 Tubi d'aspirazione

Nutzlänge
 Working length
 Longueur utile
 Largo útil
 Lunghezza utile

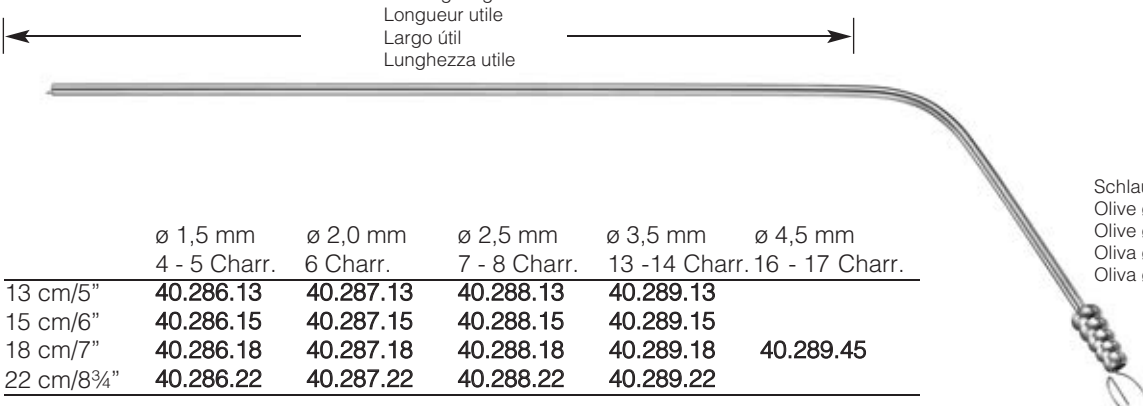

	ø 1,5 mm 4 - 5 Charr.	ø 2,0 mm 6 Charr.	ø 2,5 mm 7 - 8 Charr.	ø 3,5 mm 13 - 14 Charr.	ø 4,5 mm 16 - 17 Charr.
13 cm/5"	40.286.13	40.287.13	40.288.13	40.289.13	
15 cm/6"	40.286.15	40.287.15	40.288.15	40.289.15	
18 cm/7"	40.286.18	40.287.18	40.288.18	40.289.18	40.289.45
22 cm/8¾"	40.286.22	40.287.22	40.288.22	40.289.22	

Schlaucholive ø 6,5 - 9 mm
 Olive ø 6,5 - 9 mm
 Oliva ø 6,5 - 9 mm
 Oliva ø 6,5 - 9 mm

LUER

YASARGIL

Saugkanülen mit Unterbrecher und Mandrin
 Suction cannulas with finger cut-off and stylet
 Canules d'aspiration avec interrupteur à doigt
 Cánulas para aspiración con interruptor y estilete
 Cannule per aspirazione con interruttore e stiletto

mit zentraler Bohrung
 with central bore
 avec perçage central
 con perforación central
 con un agujero central

04.149.27
 ø 2,0 mm

04.148.27
 ø 4,8 mm

YANKAUER
 28,5 cm/11¼"

04.155.30
 ø 3,0 mm
 Fig. 1

04.155.35
 ø 3,5 mm
 Fig. 2

04.155.40
 ø 4,0 mm
 Fig. 3

04.155.99
 Mandrin
 Stylet
 Doigt
 Estilete
 Stiletto

MAGILL
 24,5 cm/9¾"

ADSON
40.290.16
 16,5 cm/6½"
 ø 3 mm

ADSON
40.290.21
 21 cm/8¼"
 ø 4 mm

FRAZIER
40.290.10
 24 cm/9½"
 ø 3,3 mm

FRAZIER
40.292.08
 ø 2,7 mm/8 charr.

12 cm/4¾"

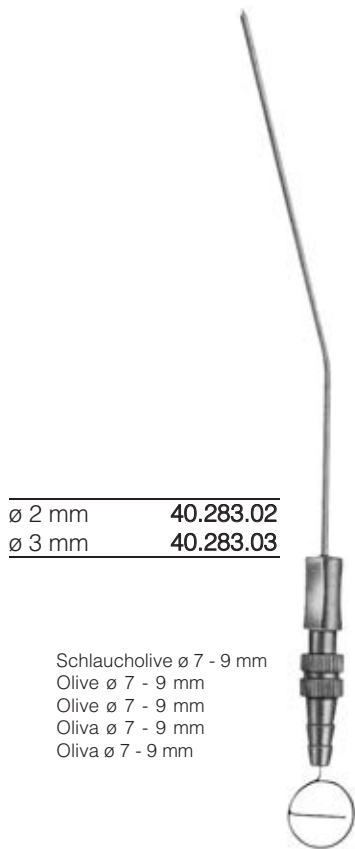

Ø 2 mm **40.283.02**
Ø 3 mm **40.283.03**

Schlaucholive ø 7 - 9 mm
Olive ø 7 - 9 mm
Olive ø 7 - 9 mm
Oliva ø 7 - 9 mm
Oliva ø 7 - 9 mm

LEMPERT
20 cm/8"

Ø mm	F.G. Charr.	11 cm/4¼"	13 cm/5"	16 cm/6¼"	20 cm/8"
Ø 1,5 mm	4 - 5	40.270.15	40.271.15	40.272.15	40.273.15
Ø 2,0 mm	6	40.270.20	40.271.20	40.272.20	40.273.20
Ø 2,5 mm	7 - 8	40.270.25	40.271.25	40.272.25	40.273.25
Ø 3,0 mm	9	40.270.30	40.271.30	40.272.30	40.273.30
Ø 4,0 mm	12	40.270.40	40.271.40	40.272.40	40.273.40
Ø 5,0 mm	15	40.270.50	40.271.50	40.272.50	40.273.50

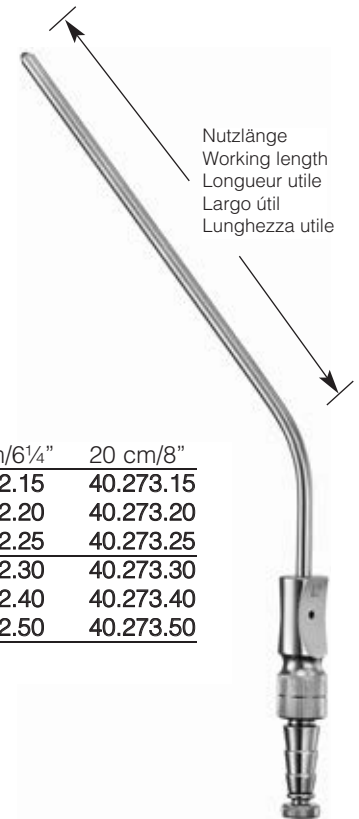

Nutzlänge
Working length
Longueur utile
Largo útil
Lunghezza utile

FERGUSSON



isoliert
insulated
isolée
aislado
isolato

FERGUSSON
40.291.04
18 cm/7"
Ø 4 mm

Schlaucholive ø 6 - 9 mm
Olive ø 6 - 9 mm
Olive ø 6 - 9 mm
Oliva ø 6 - 9 mm
Oliva ø 6 - 9 mm

Saugkanülen mit Unterbrecher und Mandrin
Suction cannulas with finger cut-off and stylet
Canules d'aspiration avec interrupteur à doigt
Cánulas para aspiración con interruptor y estilete
Cannule per aspirazione con interruttore e stiletto

F.G. Charr.	Ø mm	30°	75°
6	2,0	40.295.06	40.297.06
7	2,3	40.295.07	40.297.07
8	2,7	40.295.08	40.297.08
9	3,0	40.295.09	40.297.09
10	3,3	40.295.10	40.297.10
11	3,7	40.295.11	40.297.11
12	4,0	40.295.12	40.297.12
15	5,0	40.295.15	40.297.15

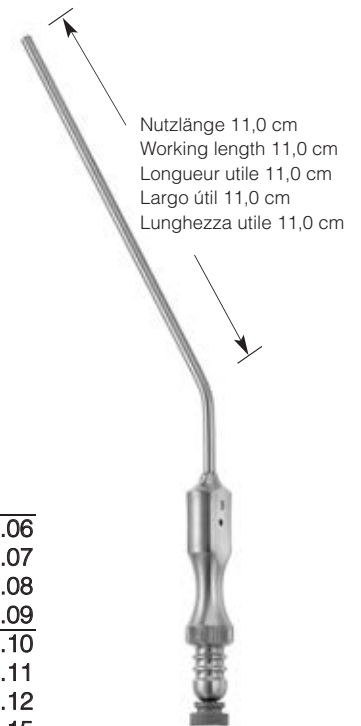

Nutzlänge 11,0 cm
Working length 11,0 cm
Longueur utile 11,0 cm
Largo útil 11,0 cm
Lunghezza utile 11,0 cm

FRAZIER
19 cm/7½"

Saugrohre

Suction tubes

Tubes d'aspiration

Tubos de aspiración

Tubi d'aspirazione

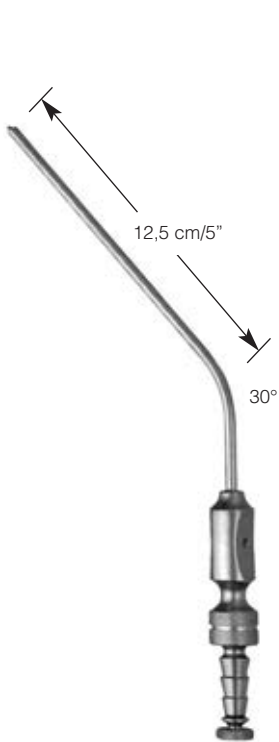

FRAZIER

6 Charr.	40.293.06
8 Charr.	40.293.08
9 Charr.	40.293.09
10 Charr.	40.293.10
12 Charr.	40.293.12

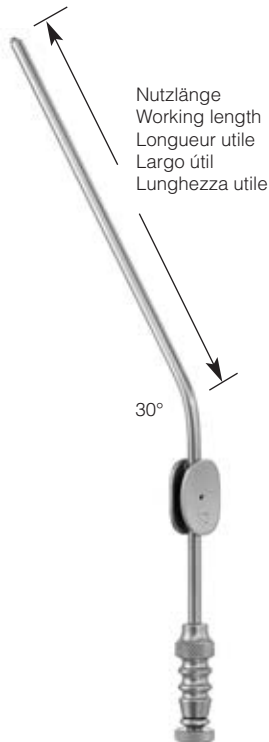

FRAZIER

F.G. Charr.	ø mm	12,5 cm/5"	18 cm/7"
6	2,0	40.296.06	40.296.16
8	2,7	40.296.08	40.296.18
10	3,3	40.296.10	40.296.30
12	4,0	40.296.12	40.296.32

Spitze 6,5 mm breit
Tip 6.5 mm wide
Pointe 6,5 mm de large
Punta 6,5 mm de ancho
Punta 6,5 mm di larghezza

40.294.05
18 cm/7"
ø 5 mm

Schlaucholive ø 6 - 9 mm
Olive ø 6 - 9 mm
Olive ø 6 - 9 mm
Oliva ø 6 - 9 mm
Oliva ø 6 - 9 mm

ø 4,5 mm	40.307.45
ø 5,5 mm	40.307.55

4-5 charr.	ø 1,5 mm	40.313.15
6 charr.	ø 2,0 mm	40.313.20
7-8 charr.	ø 2,5 mm	40.313.25
9 charr.	ø 3,0 mm	40.313.30

Schlaucholive ø 6 - 9 mm
Olive ø 6 - 9 mm
Olive ø 6 - 9 mm
Oliva ø 6 - 9 mm
Oliva ø 6 - 9 mm

LUER
17,5 cm/7"

Schlaucholive ø 6 - 9 mm
Olive ø 6 - 9 mm
Olive ø 6 - 9 mm
Oliva ø 6 - 9 mm
Oliva ø 6 - 9 mm

PLESTER
19 cm/7½"



FRAZIER
 12 cm/4¾"

ø 2,0 mm	40.298.08
ø 2,5 mm	40.298.10
ø 3,0 mm	40.298.12

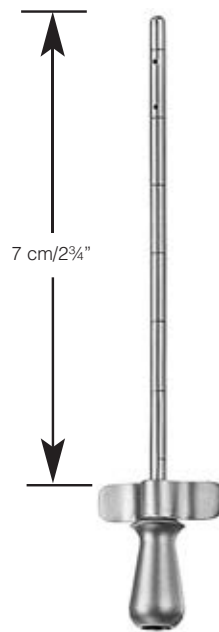

ø 2,0 mm	40.300.20
ø 2,5 mm	40.300.25

Saugrohre

Suction tubes
Tubes d'aspiration
Tubos de aspiración
Tubi d'aspirazione



ZOELLNER
40.283.70
18 cm/7"



Verpackungseinheit 10 Stück
Packing unit 10 pieces
Boîtes de 10 pièces
Cajas de 10 piezas
Scatole di 10 pezzi

ZOELLNER
5,5 cm/2"

ø 1,2 mm / 18 swg	40.283.71
ø 1,0 mm / 20 swg	40.283.72
ø 0,7 mm / 22 swg	40.283.73
ø 0,5 mm / 24 swg	40.283.74
ø 0,4 mm / 26 swg	40.283.75

Schlaucholive ø 8 mm
Olive ø 8 mm
Olive ø 8 mm
Oliva ø 8 mm
Oliva ø 8 mm



WULLSTEIN

40.308.00

komplett, mit Griff und drei Aufsätzen
complete, with handle and 3 tips
complet, avec manche et 3 pointes
completo, con mango y 3 puntas
completo, con manico e 3 punte

40.308.01

14 cm/5½"

Saugerhandgriff
Suction handle
Manche pour canule
Mango para cánula
Manico d'aspirazione

Mikro-Saugkanüle
Micro suction cannula
Tube micro d'aspiration
Micro tubo de aspiración
Micro-cannula d'aspirazione



40.308.04
4,5 cm/1¾"
ø 0,4 mm



40.308.06
4,5 cm/1¾"
ø 0,6 mm



40.308.08
4,5 cm/1¾"
ø 0,8 mm

40.309.00

komplett, mit Griff und 4 Aufsätzen (x 2)
complete, with handle and 4 tips (x 2)
complet, avec manche et 4 pointes (x 2)
completo, con mango y 4 puntas (x 2)
completo, con manico e 4 punte (x 2)



40.309.01

Saughandgriff
Suction handle
Manche pour canule
Mango para cánula
Manico d'aspirazione



ø 0,5 mm	40.309.02
ø 0,7 mm	40.309.03
ø 1,0 mm	40.309.04
ø 1,3 mm	40.309.05



BELLUCCI
40.310.01
15,5 cm/6"

BELLUCCI

40.310.00

komplett, mit Griff und drei Aufsätzen
complete, with handle and 3 tips
complet, avec manche et 3 pointes
completo, con mango y 3 puntas
completo, con manico e 3 punte

Schlaucholive ø 8 mm
Olive ø 8 mm
Olive ø 8 mm
Oliva ø 8 mm
Oliva ø 8 mm

ø 1,0 mm / 20 swg	40.310.02
ø 0,7 mm / 22 swg	40.310.03
ø 0,5 mm / 24 swg	40.310.04

mit Saugunterbrecher und Mandrin
 with finger cut-off and stylet
 avec interrupteur à doigt
 con interruptor y estilete
 con interruttore e stiletto

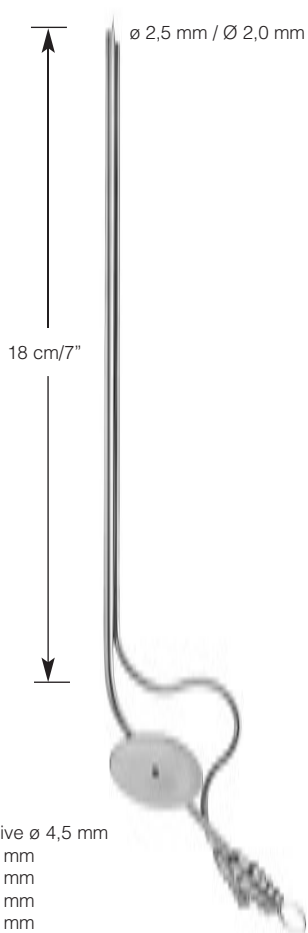

FISCH
40.331.17

Saug- und Spülkanüle
 Suction and irrigation cannula
 Canule d'aspiration et d'irrigation
 Cánula de aspiración y de irrigación
 Strumenti per aspirazione e lavaggio



YASARGIL
40.332.20
 20 cm / 8"
 Ø 2,0 / 4,5 mm

Präpariersauger
 Suction raspatory
 Aspirateur pour préparation
 Aspirador para preparación
 Aspiratore per preparazione



LANDOLT
40.333.20
 20 cm / 8"
 Ø 3,2 mm

Saugrohre

Suction tubes
Tubes d'aspiration
Tubos de aspiración
Tubi d'aspirazione

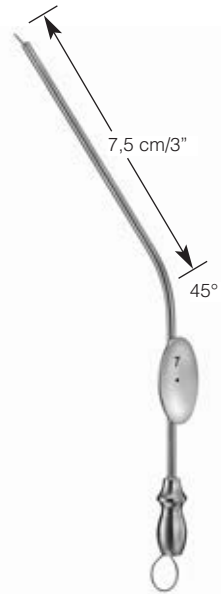

BARON

mit Unterbrecher
with finger cut-off
avec plaque interrupteur
con placa desconectadora
con placa interruttore

44.101.03
ø 1,0 mm

44.101.05
ø 1,7 mm

44.101.07
ø 2,3 mm



SCHUHKNECHT
13 cm/5"

Schlaucholive ø 8 mm
Olive ø 8 mm
Olive ø 8 mm
Oliva ø 8 mm
Oliva ø 8 mm

Saugadapter mit Saugunterbrecher
Suction adapter with finger cut-off
Adaptateur d'aspiration avec interrupteur
Adaptador para aspiración con interruptor
Adattatore per aspirazione con interruttore



Schlaucholive ø 7 mm
Olive ø 7 mm
Olive ø 7 mm
Oliva ø 7 mm
Oliva ø 7 mm

HOUSE
44.104.00
5,5 cm/2¼"

ø 0,9 mm / 20 swg	44.102.20
ø 0,6 mm / 24 swg	44.102.24

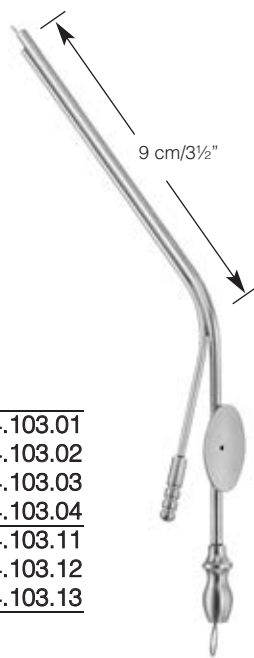

HOUSE

Saugrohr	Spülrohr
Suction tube	Irrigation tube
À aspiration	À irrigation
De aspiración	De irrigación
Per aspirazione	Per lavaggio

ø 1,8 mm	ø 1,8 mm	44.103.01
ø 2,5 mm	ø 2,0 mm	44.103.02
ø 3,0 mm	ø 2,0 mm	44.103.03
ø 4,5 mm	ø 2,0 mm	44.103.04
ø 0,9 mm	ø 0,7 mm	44.103.11
ø 1,2 mm	ø 0,9 mm	44.103.12
ø 1,5 mm	ø 1,2 mm	44.103.13



VERHOEVEN
10 cm/4"

ø 1,6 mm / 16 swg	44.105.16
ø 1,2 mm / 18 swg	44.105.18
ø 0,9 mm / 20 swg	44.105.20
ø 0,7 mm / 22 swg	44.105.22
ø 0,6 mm / 24 swg	44.105.24

16

◆ STANZEN

RONGEURS

GOUGES

GUBIAS

SGORBIE

Rongeurs

Rongeurs

Gouges

Gubias

Sgorbie



BECK
40.413.02



PENNYBACKER
40.423.03

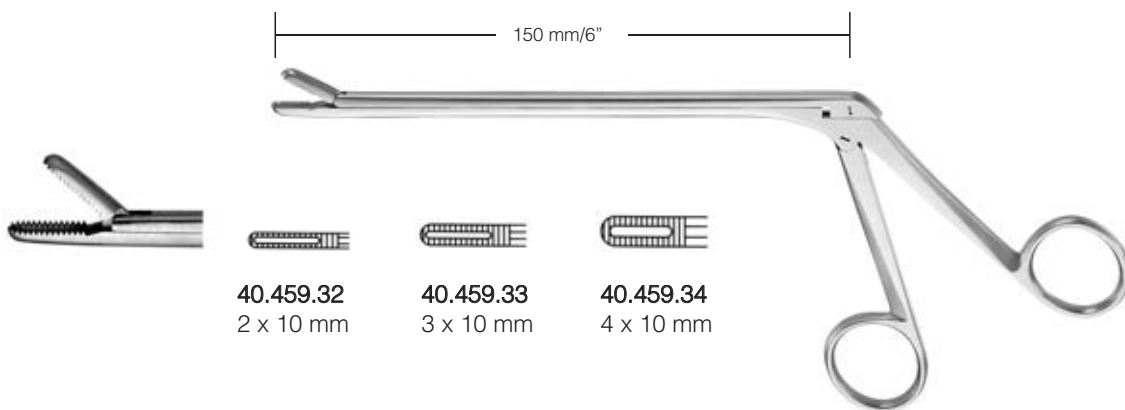

SCHLESINGER

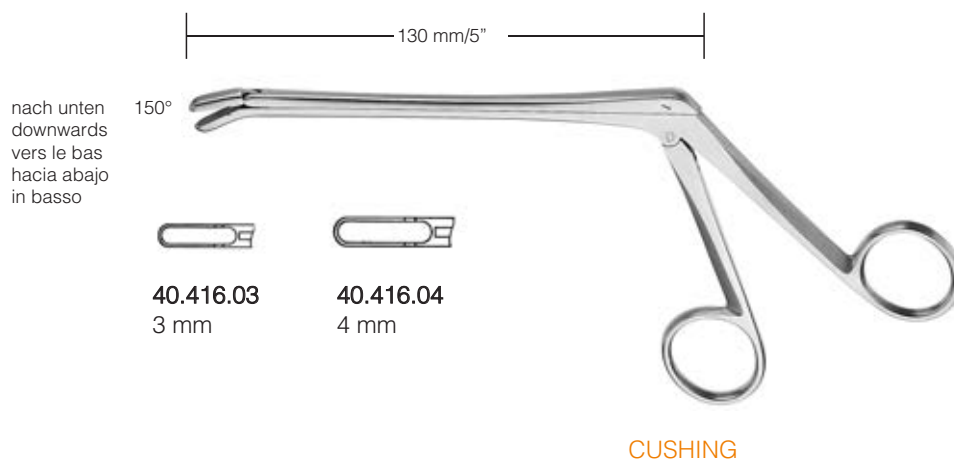
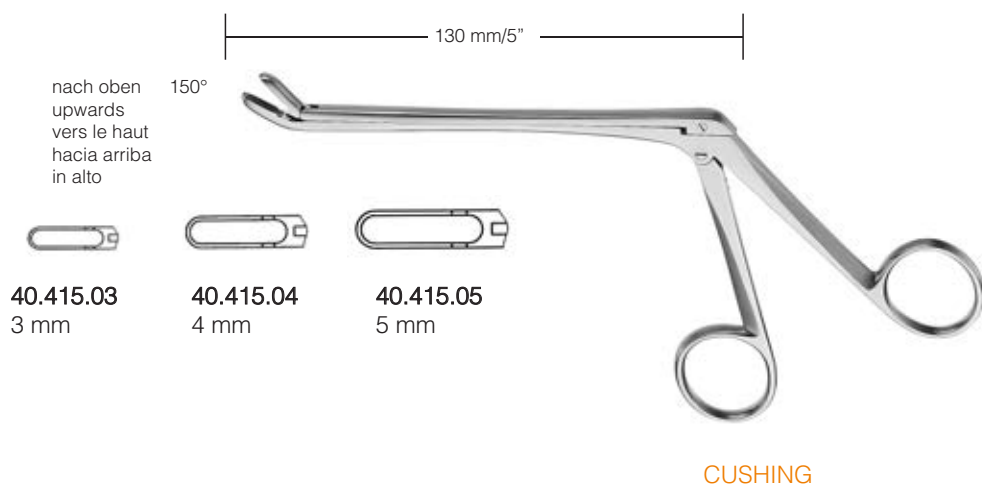
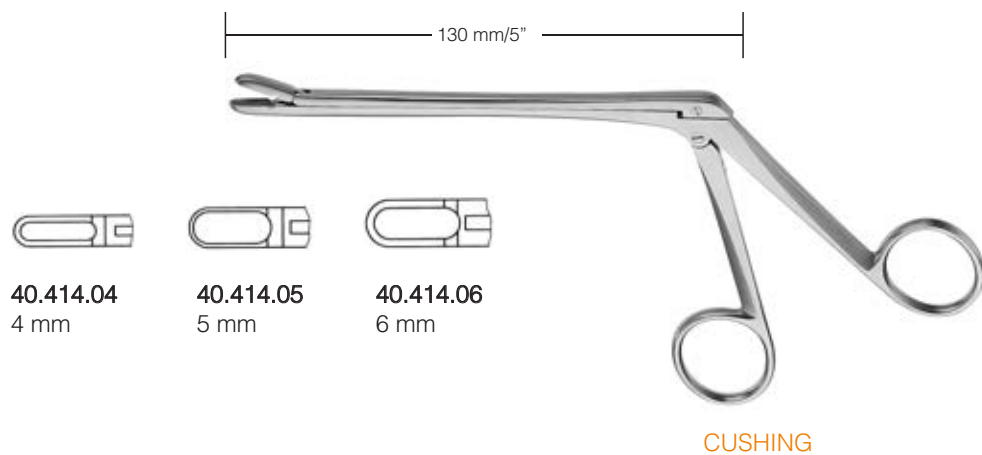

Laminektomiezangen

Laminectomy rongeurs
Pincas para laminectomia
Pinze per laminectomia

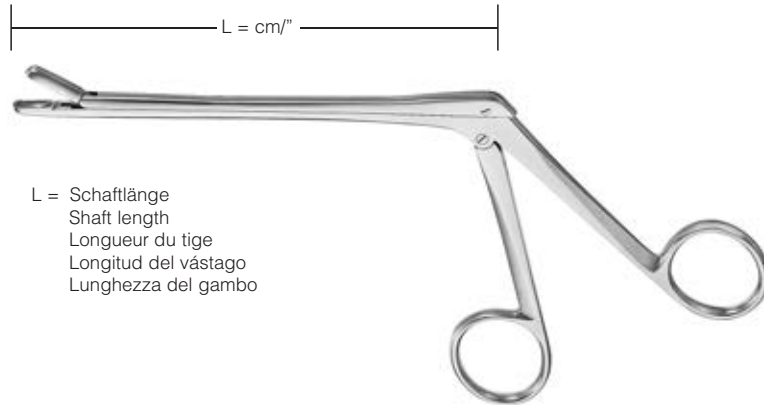

L = Schaftlänge
Shaft length
Longueur du tige
Longitud del vástago
Lunghezza del gambo

2 x 10 mm



gerade
straight
droit
recta
diritta

CUSHING

12,5 cm/5"	40.420.01
15,0 cm/6"	40.421.01
18,0 cm/7"	40.422.01

nach oben
upwards
vers le haut
hacia arriba
in alto

2 x 10 mm



CUSHING

12,5 cm/5"	40.420.02
15,0 cm/6"	40.421.02
18,0 cm/7"	40.422.02

nach unten
downwards
vers le bas
hacia abajo
in basso

2 x 10 mm

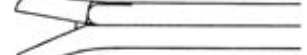

CUSHING

12,5 cm/5"	40.420.03
15,0 cm/6"	40.421.03
18,0 cm/7"	40.422.03

3 x 10 mm



gerade
straight
droit
recta
diritta

LOVE-GRUENWALD

12,5 cm/5"	40.430.01
15,0 cm/6"	40.431.01
18,0 cm/7"	40.432.01

nach oben
upwards
vers le haut
hacia arriba
in alto

3 x 10 mm

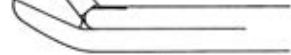

LOVE-GRUENWALD

12,5 cm/5"	40.430.02
15,0 cm/6"	40.431.02
18,0 cm/7"	40.432.02

nach unten
downwards
vers le bas
hacia abajo
in basso

3 x 10 mm

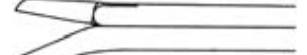

LOVE-GRUENWALD

12,5 cm/5"	40.430.03
15,0 cm/6"	40.431.03
18,0 cm/7"	40.432.03

4 x 10 mm



gerade
straight
droit
recta
diritta

SPURLING

12,5 cm/5"	40.440.01
15,0 cm/6"	40.441.01
18,0 cm/7"	40.442.01

nach oben
upwards
vers le haut
hacia arriba
in alto

4 x 10 mm

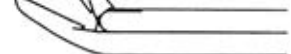

SPURLING

12,5 cm/5"	40.440.02
15,0 cm/6"	40.441.02
18,0 cm/7"	40.442.02

nach unten
downwards
vers le bas
hacia abajo
in basso

4 x 10 mm



SPURLING

12,5 cm/5"	40.440.03
15,0 cm/6"	40.441.03
18,0 cm/7"	40.442.03

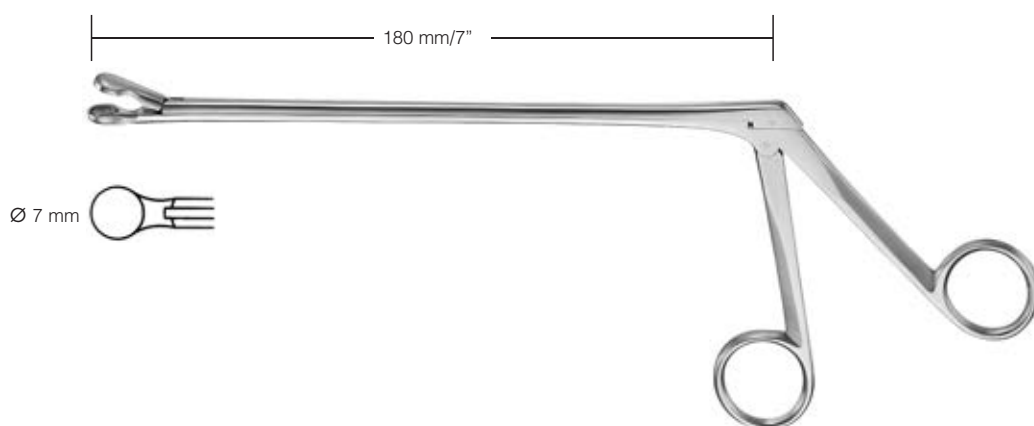

OLDBERG
 40.445.25
 25 cm/10"

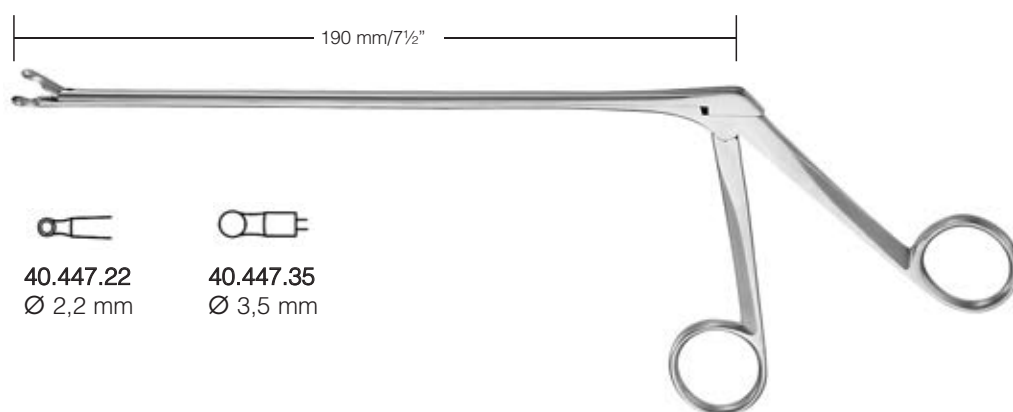

YASARGIL

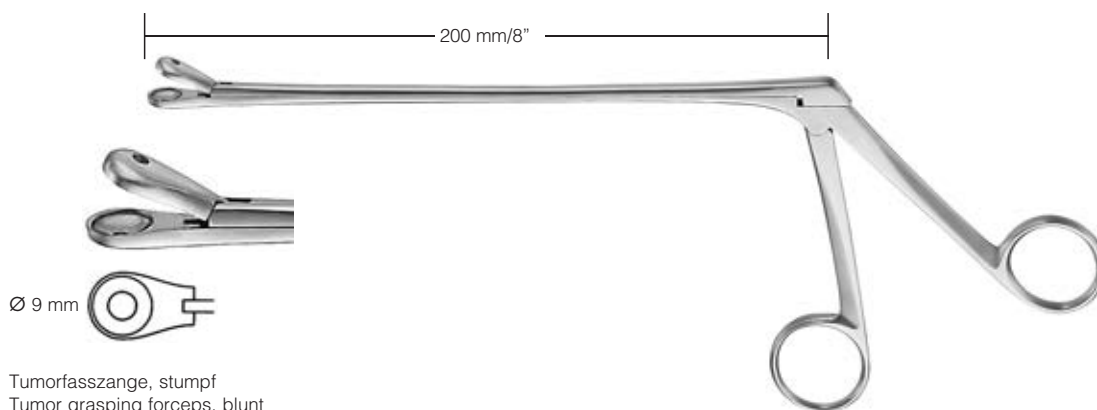

Tumorfasszange, stumpf
 Tumor grasping forceps, blunt
 Pinces pour préhension de tumeurs, mousse
 Pinzas para agarrar tumores, romo
 Pinze per afferrare tumori, smusso

LANDOLT
 40.448.20

Bandscheiben-Rongeure

Rongeurs for intervertebral discs

Rongeurs pour disques intervertébraux

Pinzas cortantes para discos intervertebrales

Pinze spezzatrici per dischi intervertebrali

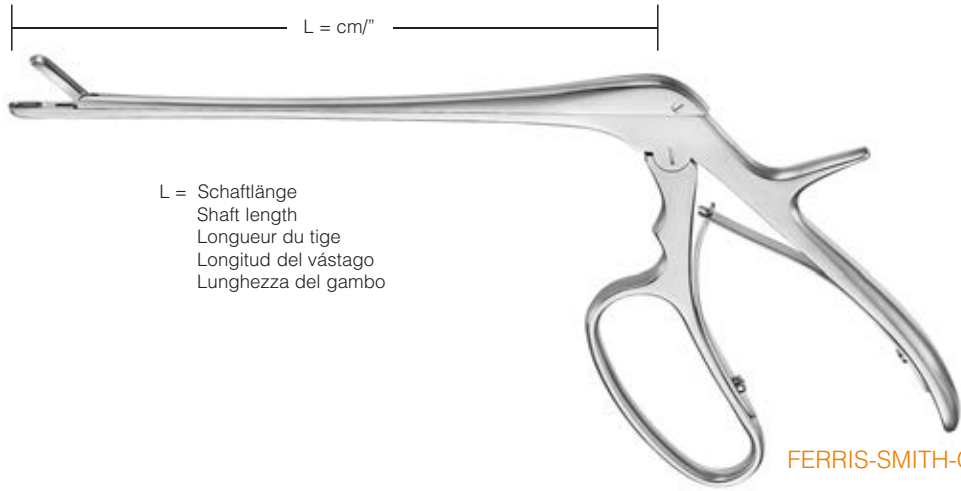

L = Schaftlänge
Shaft length
Longueur du tige
Longitud del vástago
Lunghezza del gambo

FERRIS-SMITH-CUSHING

gerade
straight
droit
recta
diritta

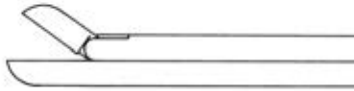

nach oben
upwards
vers le haut
hacia arriba
in alto



nach unten
downwards
vers le bas
hacia abajo
in basso

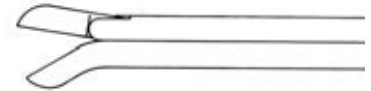

	16 cm/6¼"	18 cm/7"	16 cm/6¼"	18 cm/7"	16 cm/6¼"	18 cm/7"
2 x 10 mm		40.451.01		40.451.02		40.451.03
3 x 10 mm	40.450.01	40.452.01	40.450.02	40.452.02	40.450.03	40.452.03
4 x 10 mm		40.453.01		40.453.02		40.453.03

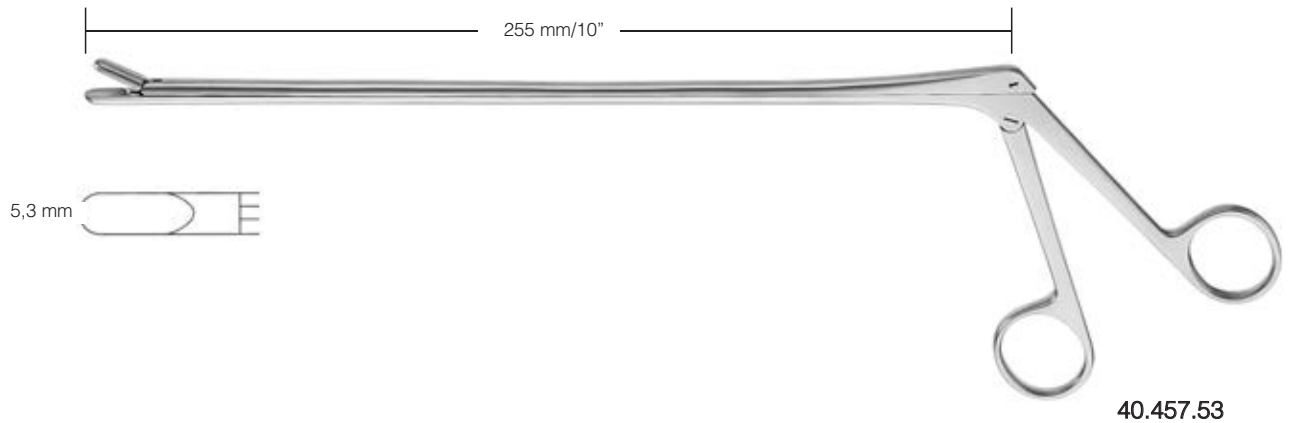

5,3 mm

40.457.53

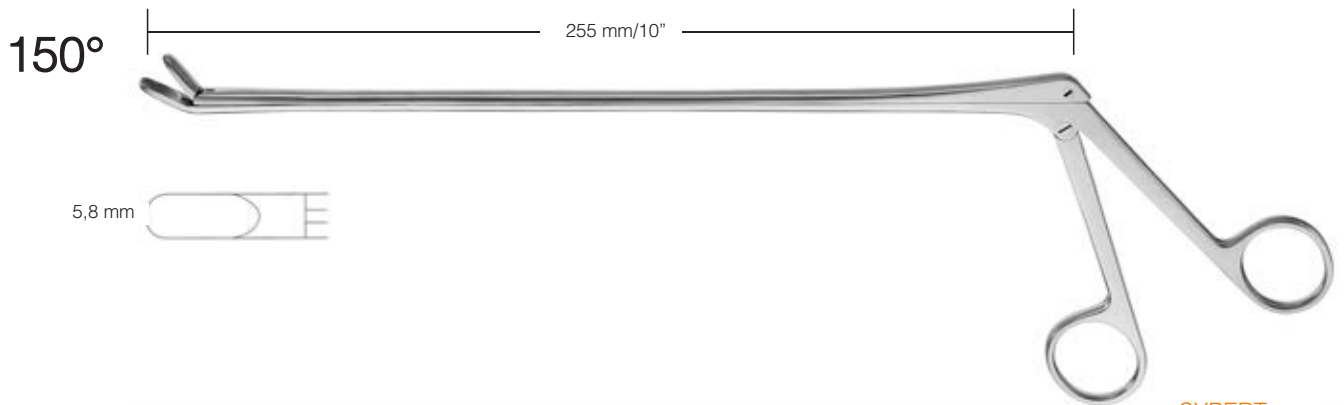

5,8 mm

SYPERT
40.457.58

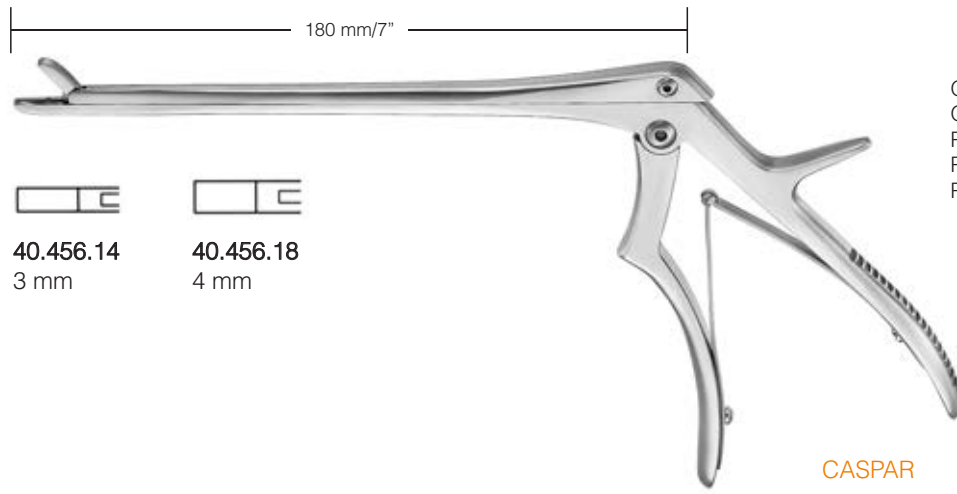

Osteophytenzange
 Osteophyte rongeur
 Pince à ostéophytes
 Pinza para osteofitos
 Pinza per osteofiti

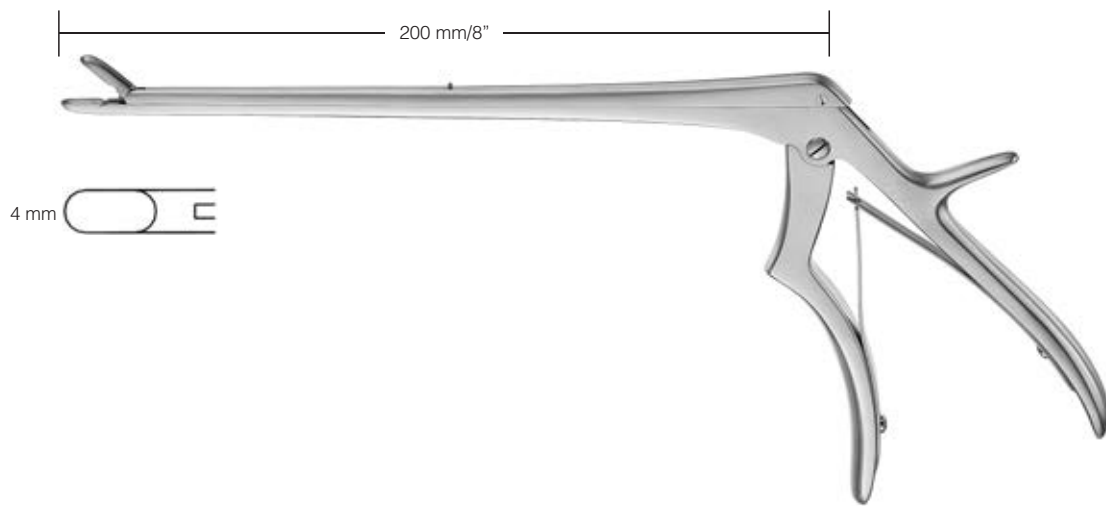

WAGNER
 40.458.20

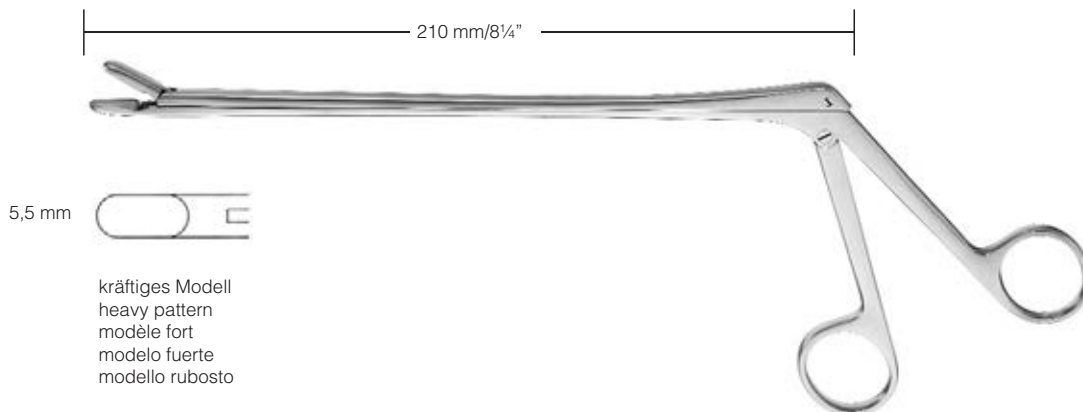

kräftiges Modell
 heavy pattern
 modèle fort
 modelo fuerte
 modello rubosto

WAGNER
 40.458.21

Bandscheiben-Rongeure

Rongeurs for intervertebral discs

Rongeurs pour disques intervertébraux

Pinzas cortantes para discos intervertebrales

Pinze spezzatrici per dischi intervertebrali

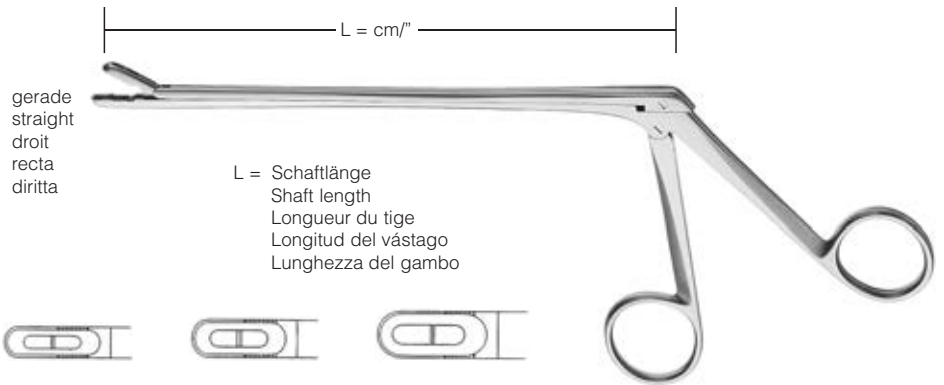

L = Schaftlänge
Shaft length
Longueur du tige
Longitud del vástago
Lunghezza del gambo



	2 x 12 mm	3 x 12 mm	4 x 14 mm	5 x 14 mm	6 x 16 mm
14 cm/5½"	40.460.20	40.460.30	40.460.40	40.460.50	40.460.60
16 cm/6¼"	40.464.20	40.464.30	40.464.40	40.464.50	40.464.60
18,5 cm/7¼"	40.468.20	40.468.30	40.468.40	40.468.50	40.468.60

CASPAR

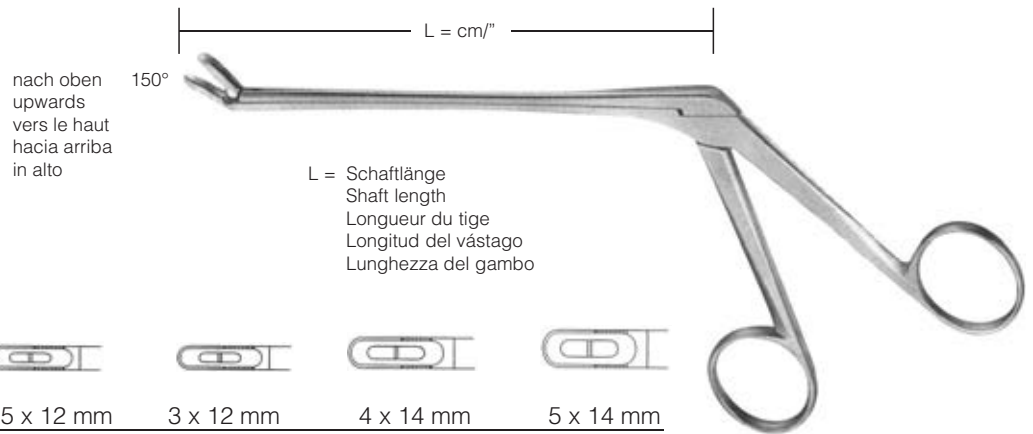

L = Schaftlänge
Shaft length
Longueur du tige
Longitud del vástago
Lunghezza del gambo



	2 x 12 mm	2,5 x 12 mm	3 x 12 mm	4 x 14 mm	5 x 14 mm
14 cm/5½"	40.461.20	40.461.25		40.461.40	40.461.50
16 cm/6¼"	40.465.20	40.465.25		40.465.40	40.465.50
18,5 cm/7¼"			40.469.30	40.469.40	40.469.50

CASPAR

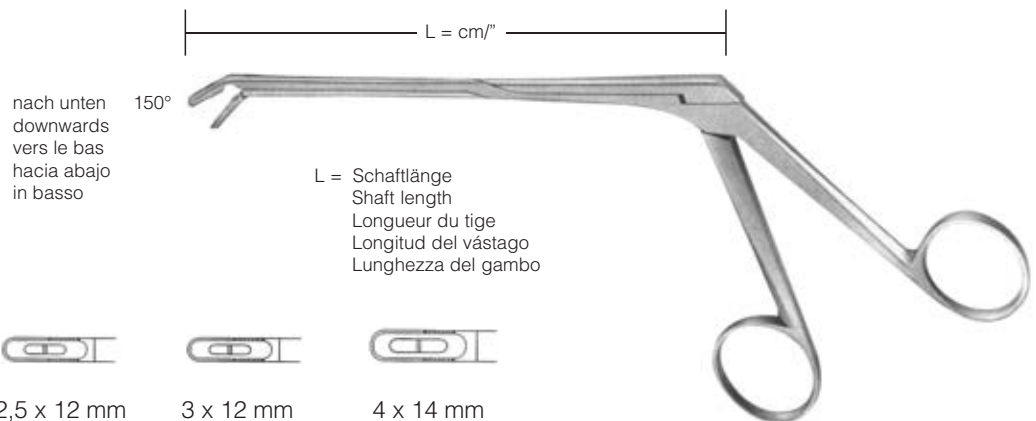

L = Schaftlänge
Shaft length
Longueur du tige
Longitud del vástago
Lunghezza del gambo



	2 x 12 mm	2,5 x 12 mm	3 x 12 mm	4 x 14 mm
14 cm/5½"	40.463.20	40.463.25		40.463.40
16 cm/6¼"	40.467.20	40.467.25		40.467.40
18,5 cm/7¼"			40.475.30	40.475.40

CASPAR

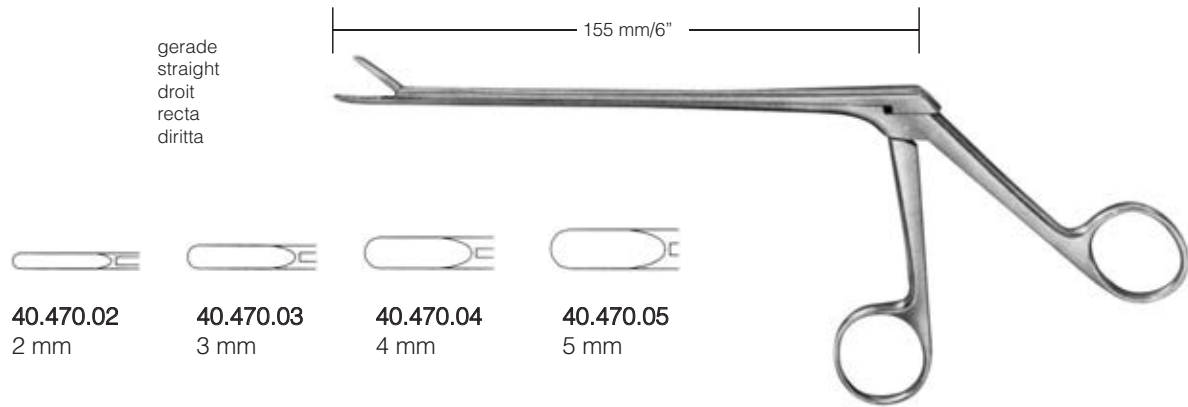

CASPAR

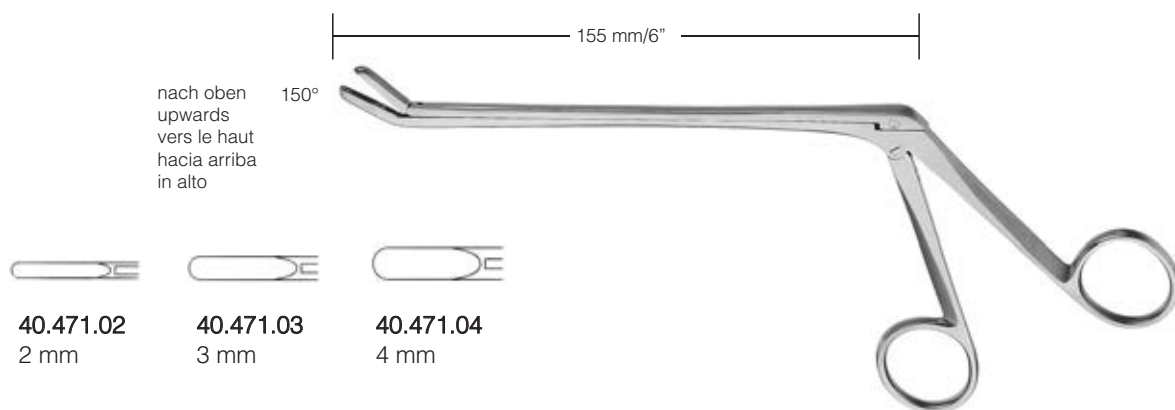

CASPAR

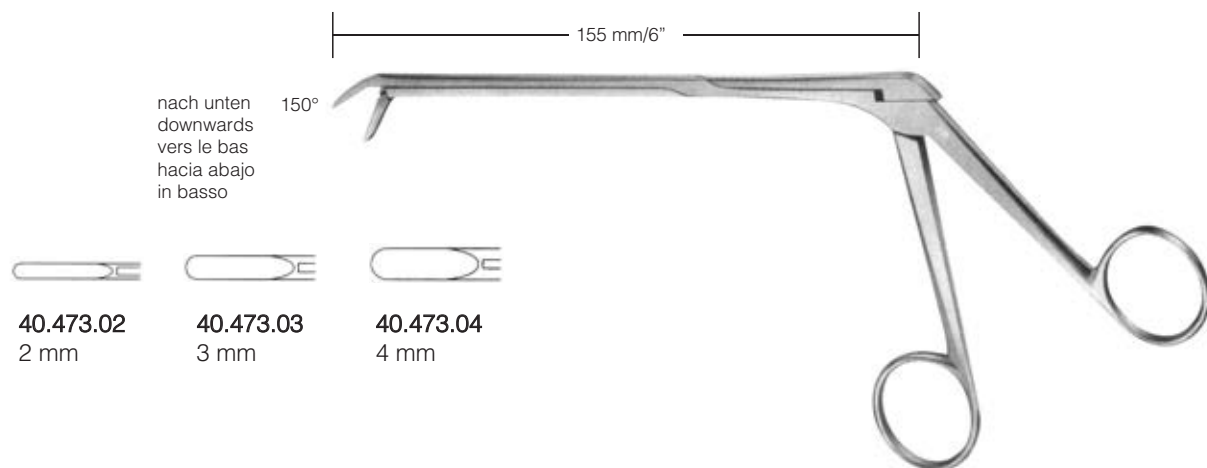

CASPAR

KERRISON Laminectomiestanzen

KERRISON Laminectomy rongeurs

KERRISON Pinces emporte-pièce pour laminectomie

KERRISON Pinzas saca-bocadas para laminectomía

KERRISON Pinze taglianti per laminectomia

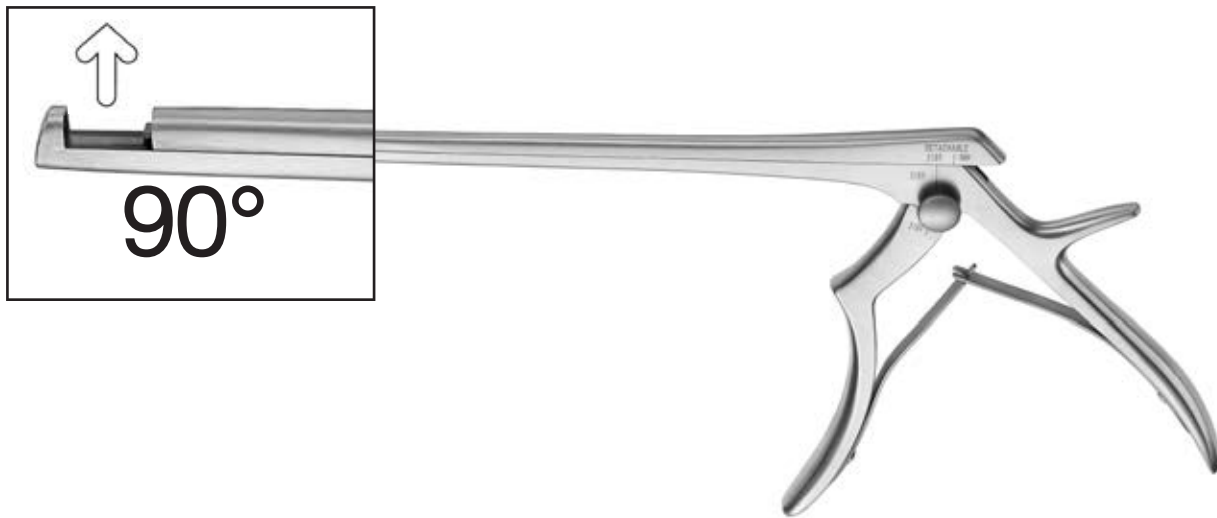

	Maul (mm) Jaw Size (mm) Mors (mm) Boca (mm) Morso (mm)	Standard	Zerlegbar Dismantable Démontable Desmontable Smontabile	Auswerfer Ejector Éjecteur Expulsor Espulsore	Zerlegbar (Keramik) Dismantable (Ceramic) Démontable (Ceramic) Desmontable (Cerámica) Smontabile (Ceramica)	Auswerfer Ejector Éjecteur Expulsor Espulsore	
180 mm / 7"	1	40.510.01	40.496.01	-	40.496.01C	-	
	2	40.510.02	40.496.02	-	40.496.02C	-	
	3	40.510.03	40.496.03	☑	40.496.03C	☑	
	4	40.510.04	40.496.04	☑	40.496.04C	☑	
	5	40.510.05	40.496.05	☑	40.496.05C	☑	
	6	40.510.06	40.496.06	☑	40.496.06C	☑	
200 mm / 8"	1	40.510.11	40.496.11	-	40.496.11C	-	
	2	40.510.12	40.496.12	-	40.496.12C	-	
	3	40.510.13	40.496.13	☑	40.496.13C	☑	
	4	40.510.14	40.496.14	☑	40.496.14C	☑	
	5	40.510.15	40.496.15	☑	40.496.15C	☑	
	6	40.510.16	40.496.16	☑	40.496.16C	☑	
230 mm / 9"	1	40.510.21					
	2	40.510.22	40.497.02	-	40.497.02C	-	
	3	40.510.23	40.497.03	☑	40.497.03C	☑	
	4	40.510.24	40.497.04	☑	40.497.04C	☑	
	5	40.510.25	40.497.05	☑	40.497.05C	☑	
	6	40.510.26	40.497.06	☑	40.497.06C	☑	
dünnfuß thin foot plate	180 mm / 7"	1	40.510.31	40.496.21	-	40.496.21C	-
		2	40.510.32	40.496.22	-	40.496.22C	-
		3	40.510.33	40.496.23	☑	40.496.23C	☑
		4	40.510.34	40.496.24	☑	40.496.24C	☑
		5	40.510.35	40.496.25	☑	40.496.25C	☑
poinçonnage étroite	200 mm / 8"	2	40.510.42	40.496.32	-	40.496.32C	-
		3	40.510.43	40.496.33	☑	40.496.33C	☑
		4	40.510.44	40.496.34	☑	40.496.34C	☑
		5	40.510.45	40.496.35	☑	40.496.35C	☑
punzonar estrecha	230 mm / 9"	2	40.510.52	40.497.12	-	40.497.12C	-
		3	40.510.53	40.497.13	☑	40.497.13C	☑
		4	40.510.54	40.497.14	☑	40.497.14C	☑
		5	40.510.55	40.497.15	☑	40.497.15C	☑
sottile	230 mm / 9"	6	40.510.56	40.497.16	☑	40.497.16C	☑



	Maul (mm) Jaw Size (mm) Mors (mm) Boca (mm) Morso (mm)	Standard	Zerlegbar Dismantable Démontable Desmontable Smontabile	Auswerfer Ejector Éjecteur Expulsor Espulsore	Zerlegbar (Keramik) Dismantable (Ceramic) Démontable (Céramic) Desmontable (Cerámica) Smontabile (Ceramica)	Auswerfer Ejector Éjecteur Expulsor Espulsore	
	180 mm / 7"	1	40.511.01	40.498.01	-	40.498.01C	-
		2	40.511.02	40.498.02	-	40.498.02C	-
		3	40.511.03	40.498.03	☑	40.498.03C	☑
		4	40.511.04	40.498.04	☑	40.498.04C	☑
		5	40.511.05	40.498.05	☑	40.498.05C	☑
		6	40.511.06	40.498.06	☑	40.498.06C	☑
	200 mm / 8"	1	40.499.11	40.498.11	-	40.498.11C	-
		2	40.499.12	40.498.12	-	40.498.12C	-
		3	40.499.13	40.498.13	☑	40.498.13C	☑
		4	40.499.14	40.498.14	☑	40.498.14C	☑
		5	40.499.15	40.498.15	☑	40.498.15C	☑
		6	40.499.16	40.498.16	☑	40.498.16C	☑
	230 mm / 9"	2	40.499.42	40.499.02	-	40.499.02C	-
		3	40.499.43	40.499.03	☑	40.499.03C	☑
		4	40.499.44	40.499.04	☑	40.499.04C	☑
		5	40.499.45	40.499.05	☑	40.499.05C	☑
		6	40.499.46	40.499.06	☑	40.499.06C	☑
	dünnfuß thin foot plate	180 mm / 7"	1	40.499.21	40.498.21	-	40.498.21C
		2	40.499.22	40.498.22	-	40.498.22C	-
		3	40.499.23	40.498.23	☑	40.498.23C	☑
		4	40.499.24	40.498.24	☑	40.498.24C	☑
		5	40.499.25	40.498.25	☑	40.498.25C	☑
poinçonnage étroite	200 mm / 8"	1	40.499.31	40.498.31	-	40.498.31C	-
		2	40.499.32	40.498.32	-	40.498.32C	-
		3	40.499.33	40.498.33	☑	40.498.33C	☑
		4	40.499.34	40.498.34	☑	40.498.34C	☑
		5	40.499.35	40.498.35	☑	40.498.35C	☑
punzonar estrecha	230 mm / 9"	2	40.499.52	40.498.52	☑	40.498.52C	☑
		3	40.499.53	40.498.53	☑	40.498.53C	☑
		4	40.499.54	40.498.54	☑	40.498.54C	☑
		5	40.499.55	40.498.55	☑	40.498.55C	☑
	sottile		4	40.499.54	40.498.54	☑	40.498.54C
		5	40.499.55	40.498.55	☑	40.498.55C	☑

KERRISON Laminectomiestanzen

KERRISON Laminectomy rongeurs

KERRISON Pinces emporte-pièce pour laminectomie

KERRISON Pinzas saca-bocadas para laminectomía

KERRISON Pinze taglianti per laminectomia

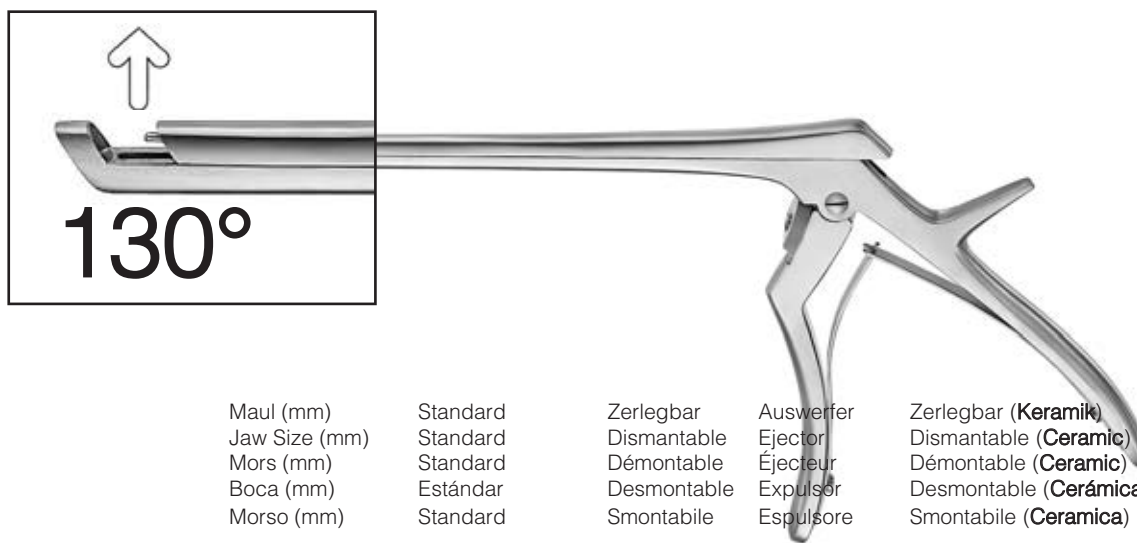

	Maul (mm) Jaw Size (mm) Mors (mm) Boca (mm) Morso (mm)	Standard	Zerlegbar Dismantable Démontable Desmontable Smontabile	Auswerfer Ejector Éjecteur Expulsor Espulsore	Zerlegbar (Keramik) Dismantable (Ceramic) Démontable (Ceramic) Desmontable (Cerámica) Smontabile (Ceramica)	Auswerfer Ejector Éjecteur Expulsor Espulsore	
180 mm / 7"	1	40.512.01	40.500.01	-	40.500.01C	-	
	2	40.512.02	40.500.02	-	40.500.02C	-	
	3	40.512.03	40.500.03	☑	40.500.03C	☑	
	4	40.512.04	40.500.04	☑	40.500.04C	☑	
	5	40.512.05	40.500.05	☑	40.500.05C	☑	
	6	40.512.06	40.500.06	☑	40.500.06C	☑	
200 mm / 8"	2	40.511.22	40.501.02	-	40.501.02C	-	
	3	40.511.23	40.501.03	☑	40.501.03C	☑	
	4	40.511.24	40.501.04	☑	40.501.04C	☑	
	5	40.511.25	40.501.05	☑	40.501.05C	☑	
	6	40.511.26	40.501.06	☑	40.501.06C	☑	
230 mm / 9"	2	40.542.02	40.502.02	-	40.502.02C	-	
	3	40.542.03	40.502.03	☑	40.502.03C	☑	
	4	40.542.04	40.502.04	☑	40.502.04C	☑	
	5	40.542.05	40.502.05	☑	40.502.05C	☑	
280 mm / 11" 4 5 6	2 3	40.511.32					
		40.511.33					
		40.511.34					
		40.511.35					
		40.511.36					
dünnpfuß thin foot plate	180 mm / 7"	1	40.511.11	40.500.11	-	40.500.11C	-
		2	40.511.12	40.500.12	-	40.500.12C	-
		3	40.511.13	40.500.13	☑	40.500.13C	☑
		4	40.511.14	40.500.14	☑	40.500.14C	☑
		5	40.511.15	40.500.15	☑	40.500.15C	☑
poinçonnage étroite	200 mm / 8"	1	40.511.41	40.501.11	-	40.501.11C	-
		2	40.511.42	40.501.12	-	40.501.12C	-
		3	40.511.43	40.501.13	☑	40.501.13C	☑
		4	40.511.44	40.501.14	☑	40.501.14C	☑
		5	40.511.45	40.501.15	☑	40.501.15C	☑
punzonar estrecha sottile	230 mm / 9"	2	40.542.12	40.502.12	-	40.502.12C	-
		3	40.542.13	40.502.13	☑	40.502.13C	☑
		4	40.542.14	40.502.14	☑	40.502.14C	☑
		5	40.542.15	40.502.15	☑	40.502.15C	☑



	Maul (mm) Jaw Size (mm) Mors (mm) Boca (mm) Morso (mm)	Standard	Zerlegbar Dismantable Démontable Desmontable Smontabile	Auswerfer Ejector Éjecteur Expulsor Espulsore	Zerlegbar (Keramik) Dismantable (Ceramic) Démontable (Ceramic) Desmontable (Cerámica) Smontabile (Ceramica)	Auswerfer Ejector Éjecteur Expulsor Espulsore	
180 mm / 7"	1	40.514.01	40.503.01	-	40.503.01C	-	
	2	40.514.02	40.503.02	-	40.503.02C	-	
	3	40.514.03	40.503.03	☑	40.503.03C	☑	
	4	40.514.04	40.503.04	☑	40.503.04C	☑	
	5	40.514.05	40.503.05	☑	40.503.05C	☑	
200 mm / 8"	1	40.514.21	40.503.21	-	40.503.21C	-	
	2	40.514.22	40.503.22	-	40.503.22C	-	
	3	40.514.23	40.503.23	☑	40.503.23C	☑	
	4	40.514.24	40.503.24	☑	40.503.24C	☑	
	5	40.514.25	40.503.25	☑	40.503.25C	☑	
	6	40.514.26	40.503.26	☑	40.503.26C	☑	
230 mm / 9"	2	40.543.02	40.504.02	-	40.504.02C	-	
	3	40.543.03	40.504.03	☑	40.504.03C	☑	
	4	40.543.04	40.504.04	☑	40.504.04C	☑	
	5	40.543.05	40.504.05	☑	40.504.05C	☑	
	6	40.543.06	40.504.06	☑	40.504.06C	☑	
	dünnpfuß thin foot plate	180 mm / 7"	1	40.514.11	40.503.11	-	40.503.11C
2		40.514.12	40.503.12	-	40.503.12C	-	
3		40.514.13	40.503.13	☑	40.503.13C	☑	
4		40.514.14	40.503.14	☑	40.503.14C	☑	
5		40.514.15	40.503.15	☑	40.503.15C	☑	
poinçonnage étroite	200 mm / 8"	1	40.514.31	40.503.31	-	40.503.31C	-
	2	40.514.32	40.503.32	-	40.503.32C	-	
	3	40.514.33	40.503.33	☑	40.503.33C	☑	
	4	40.514.34	40.503.34	☑	40.503.34C	☑	
	5	40.514.35	40.503.35	☑	40.503.35C	☑	
punzonar estrecha	230 mm / 9"	2	40.543.12	40.504.12	-	40.504.12C	-
	3	40.543.13	40.504.13	☑	40.504.13C	☑	
	4	40.543.14	40.504.14	☑	40.504.14C	☑	
	5	40.543.15	40.504.15	☑	40.504.15C	☑	
	sottile	230 mm / 9"	2	40.543.12	40.504.12	-	40.504.12C
3		40.543.13	40.504.13	☑	40.504.13C	☑	
4		40.543.14	40.504.14	☑	40.504.14C	☑	
5		40.543.15	40.504.15	☑	40.504.15C	☑	

Laminektomiestanzen

Laminectomy rongeurs

Pinces emporte-pièce pour laminectomie

Pinzas saca-bocadas para laminectomía

Pinze taglianti per laminectomia

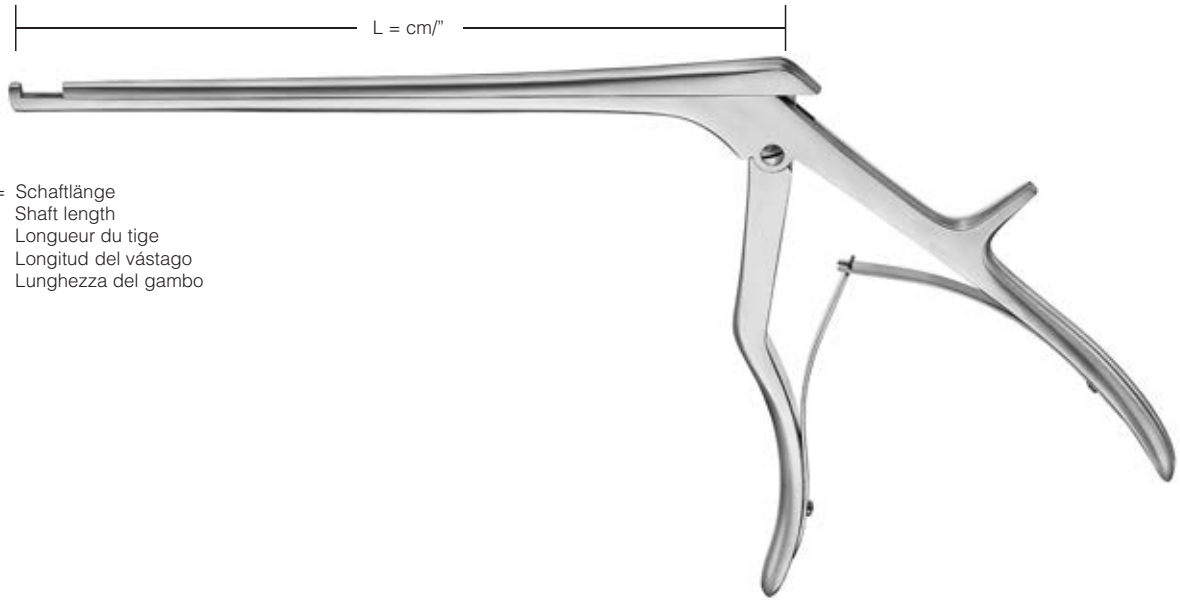

L = Schaftlänge
Shaft length
Longueur du tige
Longitud del vástago
Lunghezza del gambo

COLCLOUGH

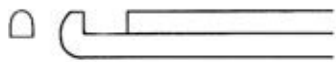

3 mm

15 cm/6"	40.520.03
20 cm/8"	40.522.03

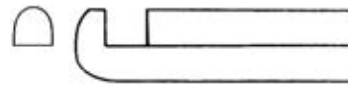

5 mm

15 cm/6"	40.520.05
20 cm/8"	40.522.05

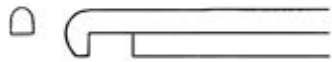

3 mm

15 cm/6"	40.524.03
20 cm/8"	40.526.03



5 mm

15 cm/6"	40.524.05
20 cm/8"	40.526.05

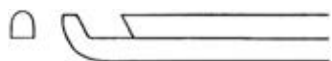

3 mm

15 cm/6"	40.527.03
20 cm/8"	40.529.03



5 mm

15 cm/6"	40.527.05
20 cm/8"	40.529.05

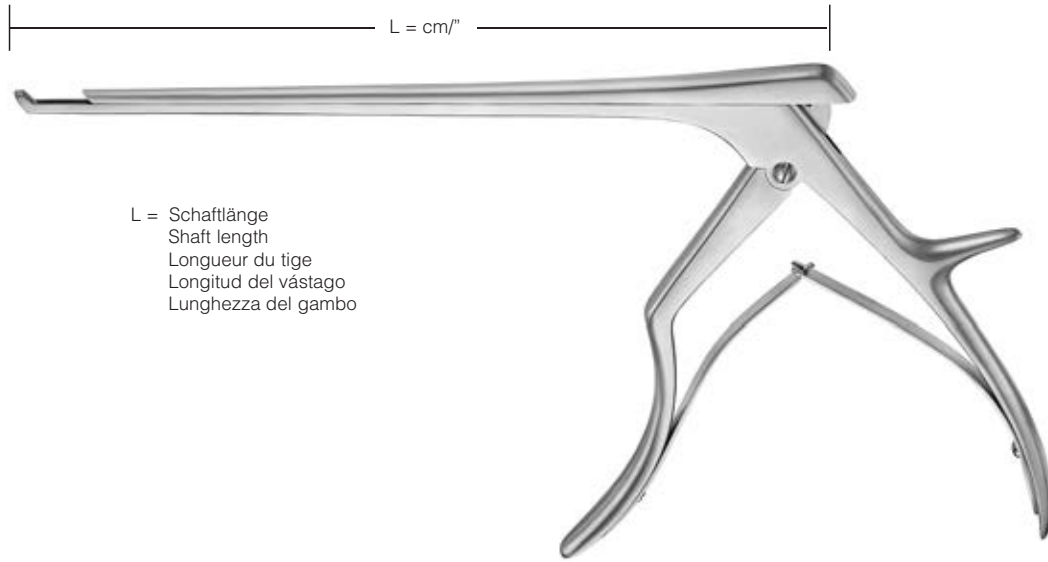

L = Schaftlänge
 Shaft length
 Longueur du tige
 Longitud del vástago
 Lunghezza del gambo

SCHLESINGER



15 cm/6"

20 cm/8"



15 cm/6"

20 cm/8"



40°



15 cm/6"

20 cm/8"



Laminektomiestanzen

Laminectomy rongeurs

Pinces emporte-pièce pour laminectomie

Pinzas saca-bocadas para laminectomía

Pinze taglianti per laminectomia

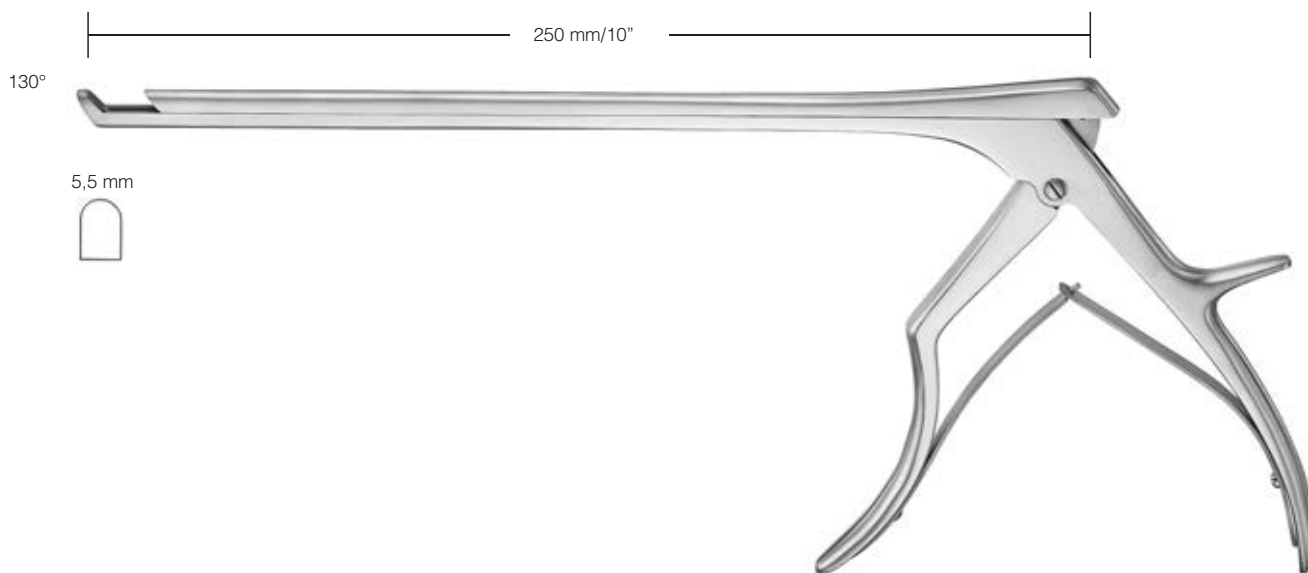

SYPERT
40.546.55

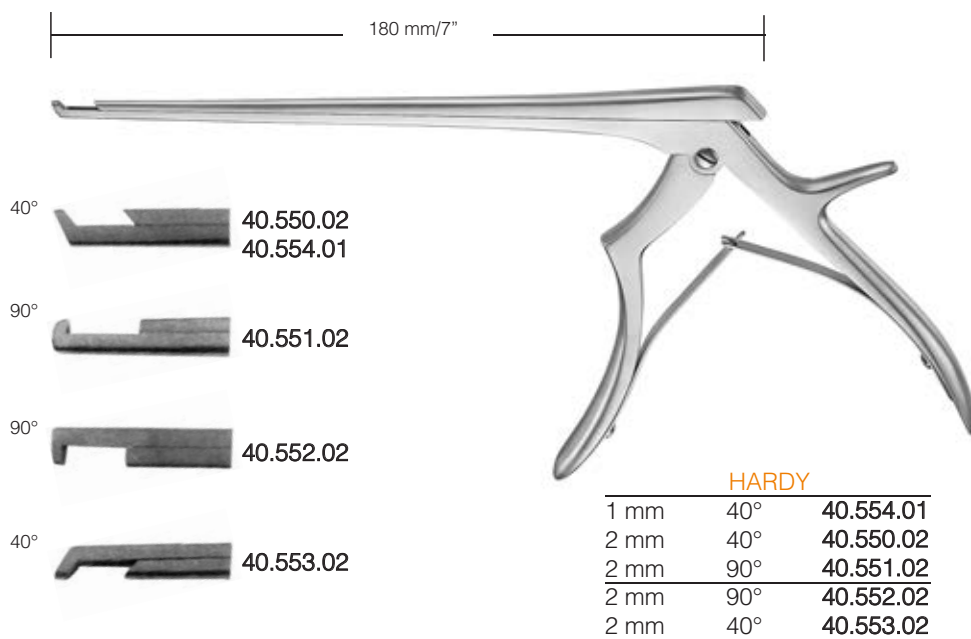

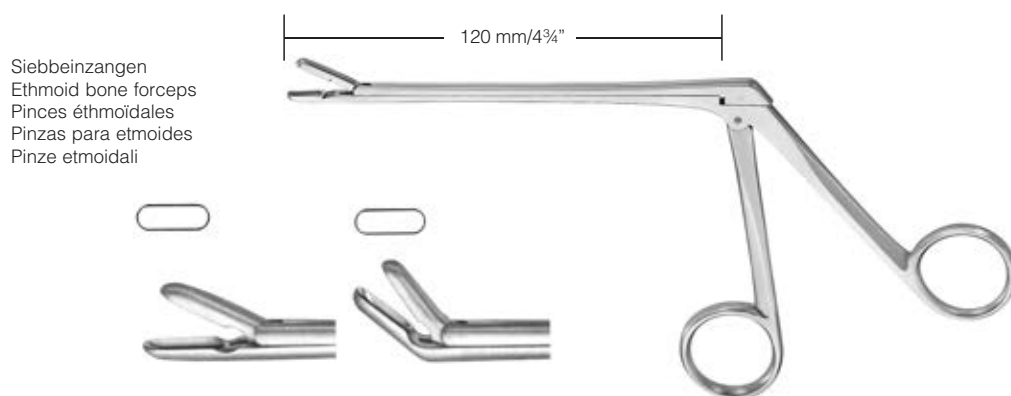

Siebbeinzangen
 Ethmoid bone forceps
 Pinces éthmoidales
 Pinzas para etmoides
 Pinze etmoidali

2 x 10 mm	46.175.02	
3 x 10 mm	46.175.03	46.175.04

gerade
 straight
 droit
 recta
 diritta

nach oben
 upwards
 vers le haut
 hacia arriba
 in alto

TAKAHASHI
 19 cm/7 1/2"

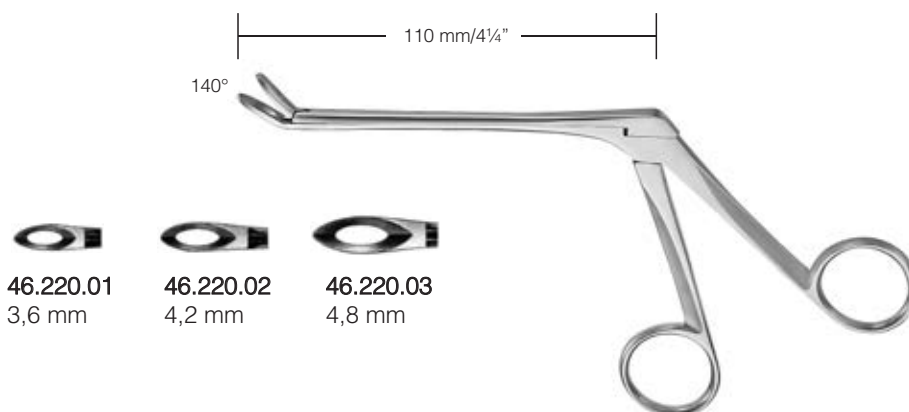

46.220.01
 3,6 mm

46.220.02
 4,2 mm

46.220.03
 4,8 mm

WEIL-BLAKESLEY
 18 cm/7"

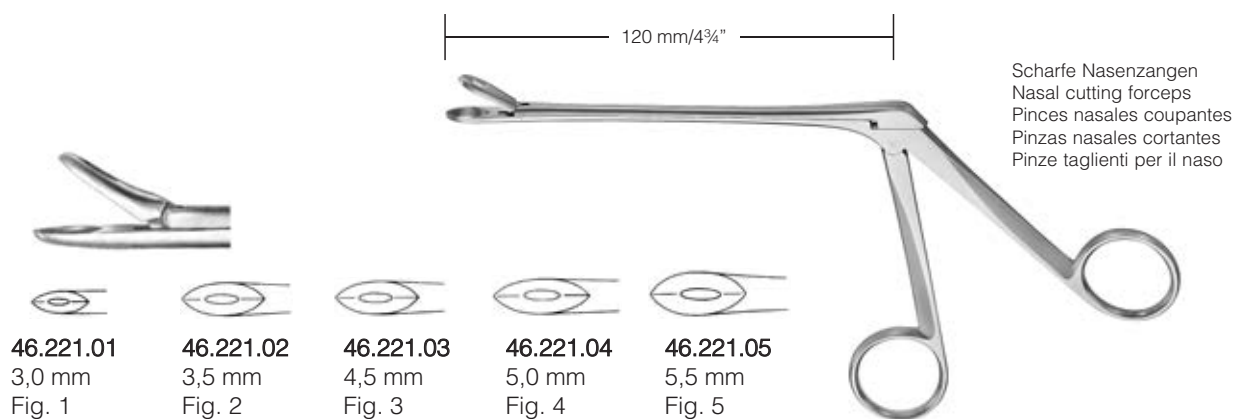

Scharfe Nasenzangen
 Nasal cutting forceps
 Pinces nasales coupantes
 Pinzas nasales cortantes
 Pinze taglianti per il naso

46.221.01
 3,0 mm
 Fig. 1

46.221.02
 3,5 mm
 Fig. 2

46.221.03
 4,5 mm
 Fig. 3

46.221.04
 5,0 mm
 Fig. 4

46.221.05
 5,5 mm
 Fig. 5





WEIL-BLAKESLEY
 19 cm/7 1/2"

Knochenstanzen

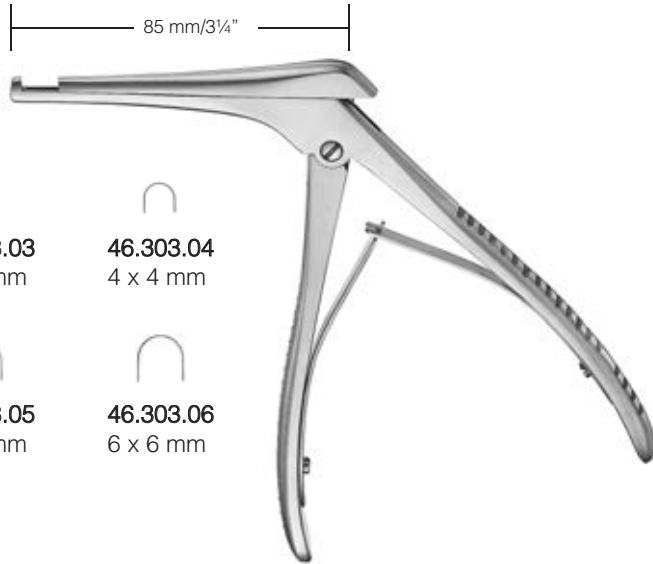
Mastoid rongeurs
Pincas emporte-pièce pour os
Pinzas cortantes para huesos
Pinze ossivore

oben schneidend
up cutting
tranchant en haut
cortante por arriba
tagliente in alto



- | | |
|---|---|
|  |  |
| 46.303.03
3 x 3 mm | 46.303.04
4 x 4 mm |
|  |  |
| 46.303.05
5 x 5 mm | 46.303.06
6 x 6 mm |

KERRISON
17 cm/6 3/4"



CITELLI

1,0 mm	46.311.10
2,5 mm	46.311.25
4,0 mm	46.311.40

Keilbeinstanzen
Sphenoid bone punches
Pincas emporte-pièces pour sinus sphénoïdal
Pinzas sacabocadas para esfenoides
Pinze taglienti per seno sfenoidale

2,0 mm 

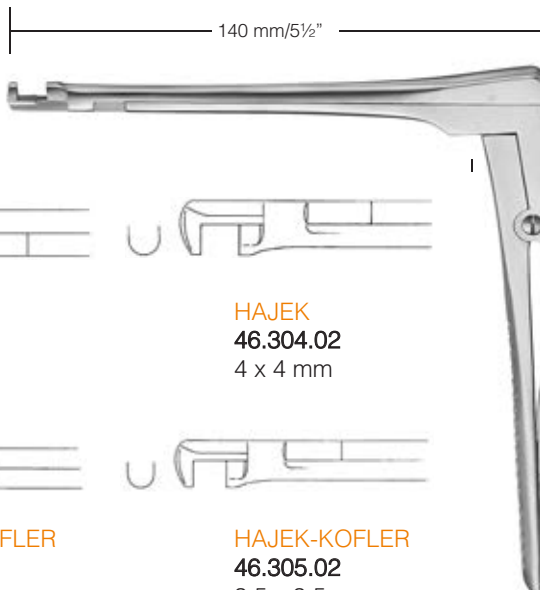

BEYER
46.315.20



HAJEK
46.304.01
4 x 4 mm

HAJEK
46.304.02
4 x 4 mm



HAJEK-KOFLER
46.305.01
3,5 x 3,5 mm

HAJEK-KOFLER
46.305.02
3,5 x 3,5 mm

17

◆ ANEURYSMEN - GEFÄß CLIPS

ANEURYSM - VESSEL CLIPS

ANEURYSM - CLIPS VASCULAIRES

ANEURYSM - CLIPS VASCULARES

ANEURYSM - CLIPS VASCOLARI

für permanenten Verschluss
 for permanent closure
 pour la fermeture permanente
 para el cierre permanente
 per la chiusura permanente

Titan / Titanium	40.920.63	40.920.71	40.920.79	40.920.93	40.760.93	40.770.91
PHYNOX	40.920.62	40.920.70	40.920.78	40.920.92	40.760.92	40.770.90
Öffnung/max. opening	6,2 mm	7,0 mm	7,8 mm	9,2 mm	10,6 mm	11,4 mm
Druck / Force	150 gms	180 gms	180 gms	200 gms	200 gms	200 gms

40.780.41	40.922.61	40.922.69	40.922.76	40.920.88	40.920.11	40.924.56
40.780.40	40.922.60	40.922.68	40.742.98	40.920.87	40.920.10	40.924.55
13,3 mm	6,0 mm	6,8 mm	7,5 mm	8,7 mm	11,0 mm	5,5 mm
200 gms	150 gms	180 gms	180 gms	200 gms	200 gms	150 gms

40.924.62	40.924.66	40.920.74	40.920.00	40.924.57	40.924.59	40.924.64
40.924.61	40.924.65	40.920.73	40.920.99	40.924.54	40.924.58	40.924.63
6,1 mm	6,5 mm	7,4 mm	9,9 mm	5,4 mm	5,8 mm	6,2 mm
180 gms	180 gms	200 gms	200 gms	180 gms	180 gms	180 gms

STANDARD

YASARGIL Aneurysmen Clips
 YASARGIL Aneurysm clips
 YASARGIL Clips d'anévrisme
 YASARGIL Clips de aneurisma
 YASARGIL Clips per aneurisma

für permanenten Verschluss
 for permanent closure
 pour la fermeture permanente
 para el cierre permanente
 per la chiusura permanente

Titan / Titanium	40.922.80	40.922.88	40.728.70	40.920.20	40.920.31	40.561.63
PHYNOX	40.922.79	40.922.87	40.728.69	40.920.19	40.920.30	40.561.62
Öffnung/max. opening	7,9 mm	8,7 mm	10,2 mm	11,9 mm	13,0 mm	6,2 mm
Druck / Force	200 gms	200 gms	200 gms	180 gms	180 gms	200 gms

40.561.66	40.561.79	40.920.85	40.920.56	40.920.58	40.920.52	40.780.55
40.561.65	40.561.78	40.920.84	40.920.55	40.920.57	40.920.51	40.780.54
6,5 mm	7,8 mm	8,4 mm	5,6 mm	5,6 mm	5,6 mm	5,4 mm
200 gms	200 gms	200 gms	200 gms	200 gms	200 gms	200 gms

40.780.57	40.924.76	40.924.80	40.924.83	40.726.57	40.920.81	40.727.48
40.780.56	40.924.75	40.924.79	40.924.82	40.726.56	40.920.80	40.727.47
5,6 mm	7,2 mm	7,2 mm	8,2 mm	5,7 mm	8,0 mm	6,2 mm
200 gms	200 gms	200 gms	200 gms	200 gms	200 gms	200 gms

für permanenten Verschluss
 for permanent closure
 pour la fermeture permanente
 para el cierre permanente
 per la chiusura permanente

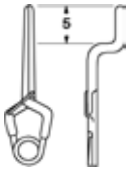
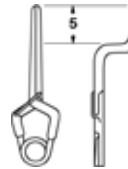
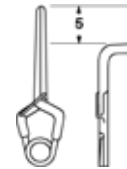
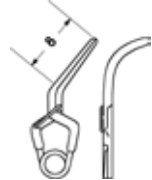
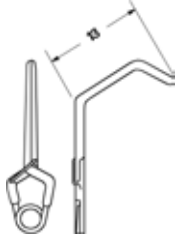
Titan / Titanium	40.724.26	40.724.36	40.724.46	40.724.56	40.920.76
PHYNOX	40.724.25	40.724.35	40.724.45	40.724.55	40.920.75
	Stufenhöhe 2,5 mm Height of step 2,5 mm 	Stufenhöhe 3,5 mm Height of step 3,5 mm 	Stufenhöhe 4,5 mm Height of step 4,5 mm 		
Öffnung/max. opening	8,0 mm	8,0 mm	8,0 mm	6,5 mm	7,5 mm
Druck / Force	200 gms	200 gms	200 gms	180 gms	200 gms

STANDARD

YASARGIL Aneurysmen Clips
 YASARGIL Aneurysm clips
 YASARGIL Clips d'anévrisme
 YASARGIL Clips de aneurisma
 YASARGIL Clips per aneurisma

für temporären Verschluss
 for temporary closure
 pour la fermeture temporaire
 para el cierre temporal
 per la chiusura temporaneo

Titan / Titanium	40.731.63	40.731.71	40.731.79	40.731.93	40.731.07	40.731.15
PHYNOX	40.731.62	40.731.70	40.731.78	40.731.92	40.731.06	40.731.14
Öffnung/max. opening	6,2 mm	7,0 mm	7,8 mm	9,2 mm	10,6 mm	11,4 mm
Druck / Force	110 gms	90 gms	90 gms	90 gms	90 gms	110 gms

40.731.34	40.731.61	40.731.69	40.753.92	40.731.88	40.763.12	40.731.56
40.731.33	40.731.60	40.731.68	40.753.91	40.731.87	40.763.11	40.731.55
13,3 mm	6,0 mm	6,8 mm	7,5 mm	8,7 mm	11,0 mm	5,5 mm
110 gms	110 gms	90 gms	90 gms	110 gms	90 gms	110 gms

40.733.62	40.731.66	40.731.75	40.731.00	40.732.55	40.732.59	40.732.63
40.733.61	40.731.65	40.731.74	40.731.99	40.732.54	40.732.58	40.732.62
6,1 mm	6,5 mm	7,4 mm	9,9 mm	5,4 mm	5,8 mm	6,2 mm
110 gms	110 gms	110 gms	90 gms	110 gms	110 gms	110 gms

für temporären Verschluss
 for temporary closure
 pour la fermeture temporaire
 para el cierre temporal
 per la chiusura temporaneo

Titan / Titanium	40.732.80	40.732.88	40.731.03	40.731.20	40.731.31	40.734.63
PHYNOX	40.732.79	40.732.87	40.731.02	40.731.19	40.731.30	40.734.62
Öffnung/max. opening	7,9 mm	8,7 mm	10,2 mm	11,9 mm	13,0 mm	6,2 mm
Druck / Force	90 gms	90 gms	90 gms	90 gms	90 gms	110 gms



40.577.66	40.573.79	40.731.85	40.731.51	40.732.71	40.731.11	40.733.55
40.577.65	40.573.78	40.731.84	40.731.50	40.732.70	40.731.10	40.733.54
6,5 mm	7,8 mm	8,4 mm	5,6 mm	5,6 mm	5,6 mm	5,4 mm
110 gms	110 gms	110 gms	130 gms	130 gms	130 gms	130 gms

40.733.57	40.732.73	40.734.73	40.731.83	40.731.58	40.731.81	40.731.91
40.733.56	40.732.72	40.734.72	40.731.82	40.731.57	40.731.80	40.731.90
5,6 mm	7,2 mm	7,2 mm	8,2 mm	5,7 mm	8,0 mm	6,2 mm
130 gms	90 gms	90 gms	90 gms	90 gms	90 gms	90 gms





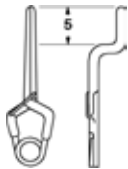
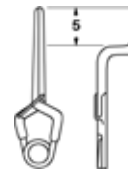
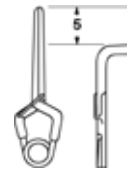
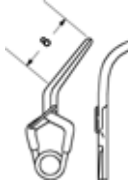

STANDARD



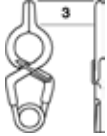

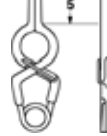

YASARGIL Aneurysmen Clips
 YASARGIL Aneurysm clips
 YASARGIL Clips d'anévrisme
 YASARGIL Clips de aneurisma
 YASARGIL Clips per aneurisma

für temporären Verschluss
 for temporary closure
 pour la fermeture temporaire
 para el cierre temporal
 per la chiusura temporaneo

Titan / Titanium	40.735.26	40.735.36	40.735.46	40.735.51	40.732.76
PHYNOX	40.735.25	40.735.35	40.735.45	40.735.55	40.732.75
	Stufenhöhe 2,5 mm Height of step 2,5 mm	Stufenhöhe 3,5 mm Height of step 3,5 mm	Stufenhöhe 4,5 mm Height of step 4,5 mm		
					
Öffnung/max. opening	8,0 mm	8,0 mm	8,0 mm	6,5 mm	7,5 mm
Druck / Force	90 gms	90 gms	90 gms	90 gms	90 gms

für permanenten Verschluss, gefenstert 3,5 mm
 for permanent closure, fenestrated 3,5 mm
 pour la fermeture permanente, fenêtré 3,5 mm
 para el cierre permanente, fenestrado 3,5 mm
 per la chiusura permanente, fenestrato 3,5 mm

Titan / Titanium	40.563.75	40.564.75	40.565.75	40.560.12	40.560.15	40.560.18
PHYNOX	40.563.74	40.564.74	40.565.74	40.560.11	40.560.14	40.560.17
						
Öffnung/max. opening	7,4 mm	7,4 mm	7,4 mm	7,4 mm	8,4 mm	9,6 mm
Druck / Force	150 gms	150 gms	150 gms	150 gms	150 gms	180 gms

40.561.10	40.561.12	40.561.15	40.562.10	40.562.13	40.562.15
40.561.09	40.561.11	40.561.14	40.562.09	40.562.12	40.562.14
					
5,8 mm	6,5 mm	7,2 mm	4,9 mm	4,9 mm	4,9 mm
150 gms	150 gms	180 gms	150 gms	150 gms	180 gms





STANDARD



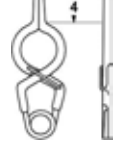

für temporären Verschluss, gefenstert 3,5 mm
 for temporary closure, fenestrated 3,5 mm
 pour la fermeture temporaire, fenêtré 3,5 mm
 para el cierre temporal, fenestrado 3,5 mm
 per la chiusura temporaneo, fenestrato 3,5 mm

Titan / Titanium	40.731.38	40.731.48	40.734.58	40.732.78	40.573.85	40.573.97
PHYNOX	40.731.37	40.731.47	40.734.57	40.732.77	40.573.84	40.573.96
Öffnung/max. opening	7,4 mm	7,4 mm	7,4 mm	7,4 mm	8,4 mm	9,6 mm
Druck / Force	110 gms	110 gms	110 gms	110 gms	110 gms	90 gms

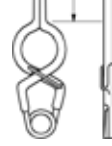
40.734.66	40.573.66	40.573.73	40.735.50	40.577.50	40.574.50
40.734.65	40.573.65	40.573.72	40.735.49	40.577.49	40.574.49
5,8 mm	6,5 mm	7,2 mm	4,9 mm	4,9 mm	4,9 mm
110 gms	110 gms	110 gms	110 gms	110 gms	110 gms

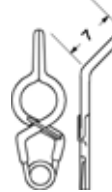
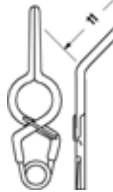
für permanenten Verschluss, gefenstert 5,0 mm
 for permanent closure, fenestrated 5,0 mm
 pour la fermeture permanente, fenêtré 5,0 mm
 para el cierre permanente, fenestrado 5,0 mm
 per la chiusura permanente, fenestrato 5,0 mm

Titan / Titanium	40.564.31	40.564.41	40.564.51	40.564.13	40.564.16	40.564.19
PHYNOX	40.564.30	40.564.40	40.564.50	40.564.12	40.564.15	40.564.18
						
Öffnung/max. opening	7,4 mm	7,4 mm	7,4 mm	7,9 mm	9,1 mm	10,3 mm
Druck / Force	150 gms	150 gms	150 gms	150 gms	150 gms	180 gms

40.565.11	40.565.14	40.565.16	40.566.12	40.566.14	40.566.17
40.565.10	40.565.13	40.565.15	40.566.11	40.566.13	40.566.16
					
6,5 mm	7,2 mm	7,8 mm	5,5 mm	5,5 mm	5,5 mm
150 gms	150 gms	180 gms	150 gms	150 gms	180 gms

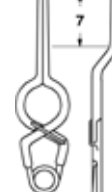
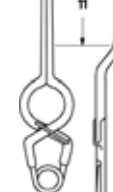
40.568.15	40.568.18	40.568.20
40.568.14	40.568.17	40.568.19
		
7,9 mm	8,8 mm	10,0 mm
150 gms	150 gms	180 gms

STANDARD

YASARGIL Aneurysmen Clips
 YASARGIL Aneurysm clips
 YASARGIL Clips d'anévrisme
 YASARGIL Clips de aneurisma
 YASARGIL Clips per aneurisma

für temporären Verschluss, gefenstert 5,0 mm
 for temporary closure, fenestrated 5,0 mm
 pour la fermeture temporaire, fenêtré 5,0 mm
 para el cierre temporal, fenestrado 5,0 mm
 per la chiusura temporaneo, fenestrato 5,0 mm

Titan / Titanium	40.573.75	40.574.75	40.575.75	40.577.75	40.579.92	40.572.04
PHYNOX	40.573.74	40.574.74	40.575.74	40.577.74	40.579.91	40.572.03
Öffnung/max. opening	7,4 mm	7,4 mm	7,4 mm	7,9 mm	9,1 mm	10,3 mm
Druck / Force	110 gms	110 gms	110 gms	110 gms	110 gms	90 gms

40.575.66	40.577.73	40.571.79	40.575.56	40.577.56	40.571.56
40.575.65	40.577.72	40.571.78	40.575.55	40.577.55	40.571.55
6,5 mm	7,2 mm	7,8 mm	5,5 mm	5,5 mm	5,5 mm
110 gms	110 gms	110 gms	110 gms	110 gms	90 gms

40.575.80	40.577.89	40.571.01
40.575.79	40.577.88	40.571.00
7,9 mm	8,8 mm	10,0 mm
90 gms	90 gms	90 gms

für permanenten Verschluss, gefenstert 5,0 mm
 for permanent closure, fenestrated 5,0 mm
 pour la fermeture permanente, fenêtré 5,0 mm
 para el cierre permanente, fenestrado 5,0 mm
 per la chiusura permanente, fenestrato 5,0 mm

Titan / Titanium	40.724.59	40.727.59	40.721.59	40.755.59	40.757.59	40.751.59
PHYNOX	40.724.58	40.727.58	40.721.58	40.755.58	40.757.58	40.751.58
Öffnung/max. opening	5,8 mm	5,8 mm	5,8 mm	5,8 mm	5,8 mm	5,8 mm
Druck / Force	150 gms	150 gms	150 gms	150 gms	150 gms	150 gms

40.785.71	40.787.79	40.781.89	40.785.59	40.787.63	40.786.59	40.788.63
40.785.70	40.787.78	40.781.88	40.785.58	40.787.62	40.786.58	40.788.62
7,0 mm	7,8 mm	8,8 mm	5,8 mm	6,2 mm	5,8 mm	6,2 mm
150 gms	150 gms	150 gms	150 gms	150 gms	150 gms	150 gms

40.785.57	40.787.57	40.786.57	40.789.57
40.785.56	40.787.56	40.786.56	40.789.56
5,6 mm	5,6 mm	5,6 mm	5,6 mm
150 gms	150 gms	150 gms	150 gms

STANDARD

für temporären Verschluss, gefenstert 5,0 mm
 for temporary closure, fenestrated 5,0 mm
 pour la fermeture temporaire, fenêtré 5,0 mm
 para el cierre temporal, fenestrado 5,0 mm
 per la chiusura temporaneo, fenestrato 5,0 mm

Titan / Titanium	40.735.59	40.737.59	40.730.59	40.745.59	40.747.59	40.740.59
PHYNOX	40.735.52	40.737.58	40.730.58	40.745.58	40.747.58	40.740.58
Öffnung/max. opening	5,8 mm	5,8 mm	5,8 mm	5,8 mm	5,8 mm	5,8 mm
Druck / Force	110 gms	110 gms	110 gms	110 gms	110 gms	110 gms

40.735.71	40.737.79	40.730.89	40.736.59	40.737.63	40.735.42	40.739.63
40.735.70	40.737.78	40.730.88	40.736.58	40.737.62	40.735.41	40.739.62
7,0 mm	7,8 mm	8,8 mm	5,8 mm	6,2 mm	5,8 mm	6,2 mm
110 gms	110 gms	110 gms	110 gms	110 gms	110 gms	110 gms

40.735.57	40.737.57	40.736.57	40.739.57
40.735.56	40.737.56	40.736.56	40.739.56
5,6 mm	5,6 mm	5,6 mm	5,6 mm
110 gms	110 gms	110 gms	110 gms

für permanenten Verschluss
 for permanent closure
 pour la fermeture permanente
 para el cierre permanente
 per la chiusura permanente

Titan / Titanium	40.570.31	40.580.36	40.690.31	40.692.36	40.710.41	40.572.31
PHYNOX	40.570.30	40.580.35	40.690.30	40.692.35	40.710.40	40.572.30
Öffnung/max. opening	3,3 mm	4,0 mm	3,3 mm	4,0 mm	4,6 mm	3,2 mm
Druck / Force	110 gms	110 gms	110 gms	110 gms	110 gms	110 gms

40.584.39	40.582.32	40.694.38	40.694.37	40.694.41	40.712.39	40.584.37
40.584.38	40.582.31	40.694.35	40.694.36	40.694.40	40.712.38	40.584.36
3,8 mm	3,6 mm	3,8 mm	3,6 mm	4,0 mm	4,4 mm	3,6 mm
110 gms	110 gms	110 gms	110 gms	110 gms	110 gms	110 gms

40.694.32	40.715.41	40.698.31	40.698.61	40.698.71	40.697.14	40.766.41
40.694.31	40.715.40	40.698.30	40.698.60	40.698.70	40.697.13	40.766.40
3,5 mm	4,0 mm	3,5 mm	6,0 mm	7,0 mm	5,7 mm	4,5 mm
110 gms	110 gms	130 gms	130 gms	130 gms	130 gms	130 gms

MINI

YASARGIL Aneurysmen Clips
YASARGIL Aneurysm clips
YASARGIL Clips d'anévrisme
YASARGIL Clips de aneurisma
YASARGIL Clips per aneurisma

für permanenten Verschluss
for permanent closure
pour la fermeture permanente
para el cierre permanente
per la chiusura permanente

Titan / Titanium	40.698.66
PHYNOX	40.698.65
	
Öffnung/max. opening	4,0 mm
Druck / Force	130 gms

für temporären Verschluss
 for temporary closure
 pour la fermeture temporaire
 para el cierre temporal
 per la chiusura temporaneo

Titan / Titanium	40.573.34	40.575.41	40.571.34	40.693.36	40.697.47	40.573.31
PHYNOX	40.573.33	40.575.40	40.571.33	40.693.35	40.697.46	40.573.30
Öffnung/max. opening	3,3 mm	4,0 mm	3,3 mm	4,0 mm	4,6 mm	3,2 mm
Druck / Force	90 gms	70 gms	90 gms	70 gms	70 gms	90 gms

40.574.39	40.693.44	40.695.36	40.695.44	40.695.75	40.697.45	40.574.37
40.574.38	40.693.43	40.695.35	40.695.43	40.695.74	40.697.44	40.574.36
3,8 mm	3,6 mm	3,8 mm	3,6 mm	4,0 mm	4,4 mm	3,6 mm
70 gms	80 gms	70 gms	80 gms	70 gms	70 gms	80 gms

40.697.34	40.695.41	40.695.71	40.696.71	40.694.71	40.697.58	40.731.46
40.697.33	40.695.40	40.695.70	40.696.70	40.694.70	40.697.57	40.731.45
3,5 mm	4,0 mm	3,5 mm	6,0 mm	7,0 mm	5,7 mm	4,5 mm
80 gms	70 gms	70 gms	70 gms	70 gms	70 gms	70 gms

für temporären Verschluss
 for temporary closure
 pour la fermeture temporaire
 para el cierre temporal
 per la chiusura temporaneo

Titan / Titanium	40.731.41
PHYNOX	40.731.40
	
Öffnung/max. opening	4,0 mm
Druck / Force	70 gms

Anlegezangen für YASARGIL Aneurysmen Clips

YASARGIL Clip applying forceps

Pinces à appliquer les clips anévrismaux YASARGIL

Pinza aplicadora para YASARGIL clips de aneurisma



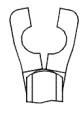
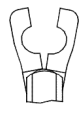
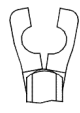
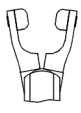
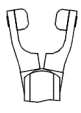
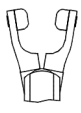

Pinza per applicare i YASARGIL clips per aneurisma

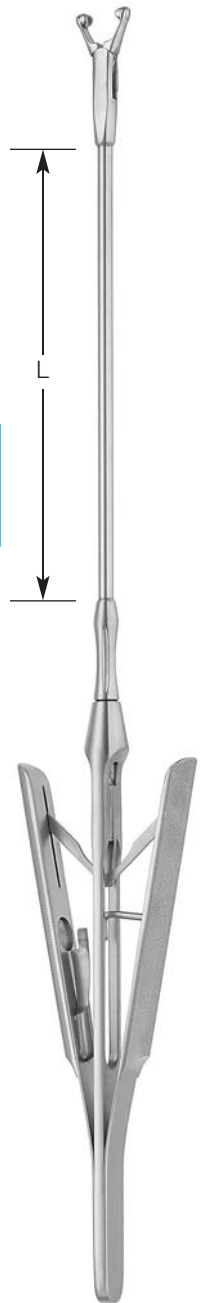
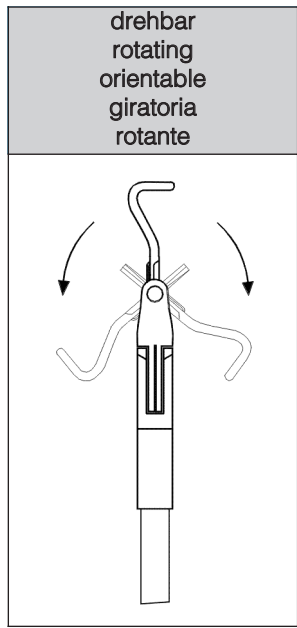
	nicht drehbar / non rotating / non orientable / no giratoria / non rotante			drehbar / rotating / orientable / giratoria / rotante		
						
	70 mm 2¾"	90 mm 3½"	110 mm 4⅓"	70 mm 2¾"	90 mm 3½"	110 mm 4⅓"
MINI	40.795.07	40.795.09	40.795.11	40.794.07	40.794.09	40.794.11
	40.795.17	40.795.19	40.795.21	40.794.17	40.794.19	40.794.21
STANDARD	40.791.07	40.791.09	40.791.11	40.790.07	40.790.09	40.790.11
	40.791.17	40.791.19	40.791.21	40.790.17	40.790.19	40.790.21

Titan
Titanium
Titane
Titanio
Titanio

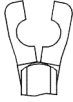
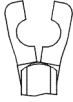
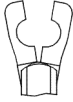

MEMORY

	nicht drehbar / non rotating / non orientable / no giratoria / non rotante			drehbar / rotating / orientable / giratoria / rotante		
						
	70 mm 2¾"	90 mm 3½"	110 mm 4⅓"	70 mm 2¾"	90 mm 3½"	110 mm 4⅓"
MINI	40.797.07	40.797.09	40.797.11	40.796.07	40.796.09	40.796.11
	40.797.17	40.797.19	40.797.21	40.796.17	40.796.19	40.796.21
STANDARD	40.793.07	40.793.09	40.793.11	40.792.07	40.792.09	40.792.11
	40.793.17	40.793.19	40.793.21	40.792.17	40.792.19	40.792.21

Titan
 Titanium
 Titane
 Titanio
 Titanio

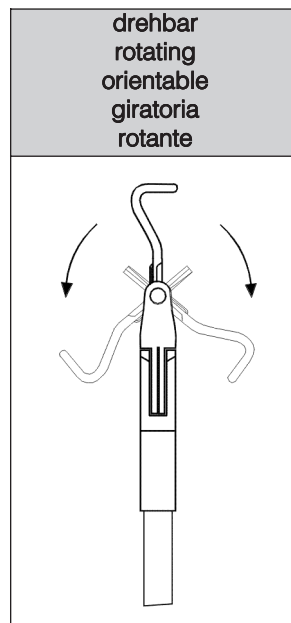

MEMORY



Anlegezangen für YASARGIL Aneurysmen Clips

YASARGIL Clip applying forceps

Pinces à appliquer les clips anévrismaux YASARGIL

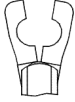

Pinza aplicadora para YASARGIL clips de aneurisma

Pinza per applicare i YASARGIL clips per aneurisma

	nicht drehbar / non rotating / non orientable / no giratoria / non rotante				drehbar / rotating / orientable / giratoria / rotante			
								
	70 mm 2¾"	90 mm 3½"	110 mm 4⅓"	130 mm 5⅓"	70 mm 2¾"	90 mm 3½"	110 mm 4⅓"	130 mm 5⅓"
MINI	40.775.50	40.775.60	40.775.70	40.775.80	40.775.52	40.775.62	40.775.72	40.775.82
	40.775.51	40.775.61	40.775.71	40.775.81	40.775.53	40.775.63	40.775.73	40.775.83
STANDARD		40.777.00	40.777.10	40.777.20	40.775.92	40.777.02	40.777.12	
	40.775.91	40.777.01	40.777.11	40.777.21	40.775.93	40.777.03	40.777.13	40.777.23

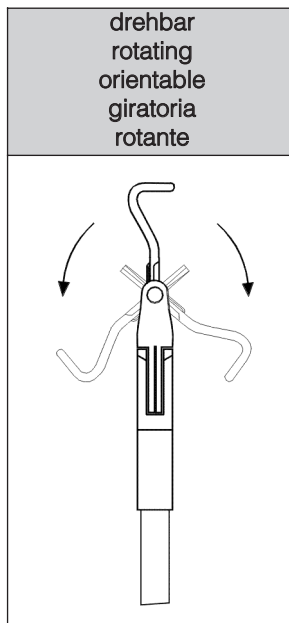
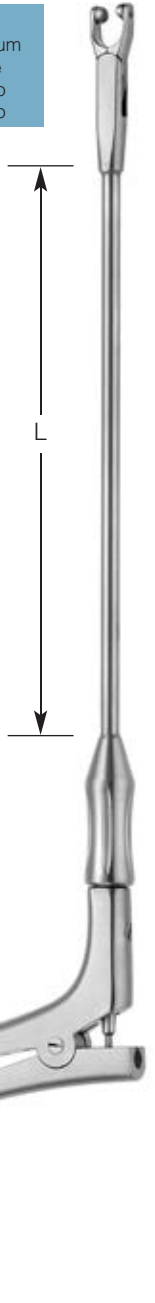
Titan
Titanium
Titane
Titanio
Titanio





		nicht drehbar / non rotating / non orientable / no giratoria / non rotante			drehbar / rotating / orientable / giratoria / rotante		
							
		*190 mm 7½"	210 mm 8¼"	230 mm 9"	*190 mm 7½"	210 mm 8¼"	230 mm 9"
STANDARD				40.773.01		40.771.83	40.773.03
		40.773.11		40.773.31	40.773.13	40.773.23	40.773.33
MINI		40.771.02	40.771.11	40.771.21	40.771.04	40.771.13	40.771.23
		40.771.31	40.780.19	40.771.41	40.771.33	40.780.21	40.771.43

Titan
 Titanium
 Titane
 Titanio
 Titanio

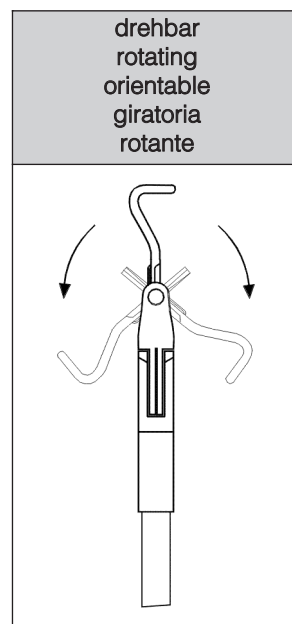
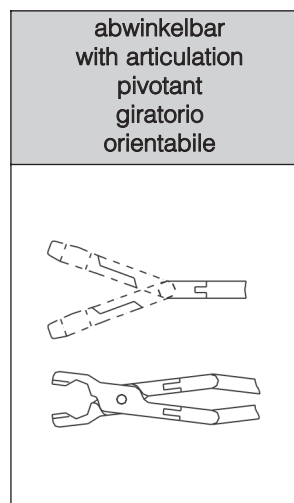

- * Nur in gerader Modellvariante erhältlich.
- * Only available in straight pattern.
- * Disponible uniquement en droit.
- * Sólo disponible en forma recta.
- * Disponibile solo in rettilineo.

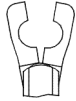





Anlegezangen für YASARGIL Aneurysmen Clips
 YASARGIL Clip applying forceps
 Pincès à appliquer les clips anévrismaux YASARGIL
 Pinza aplicadora para YASARGIL clips de aneurisma
 Pinza per applicare i YASARGIL clips per aneurisma

	nicht drehbar / non rotating / non orientable / no giratoria / non rotante	drehbar / rotating / orientable / giratoria / rotante
		
	180 mm 7"	180 mm 7"
MINI	40.776.18	40.776.20
STANDARD	40.778.18	

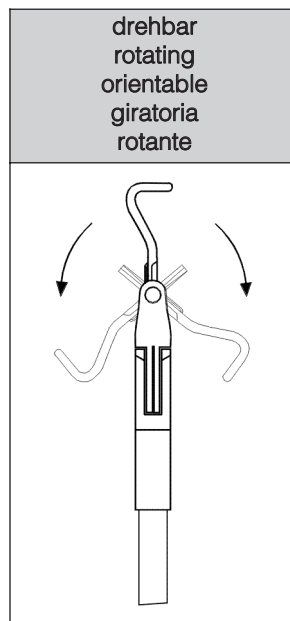

	nicht drehbar / non rotating / non orientable / no giratoria / non rotante			drehbar / rotating / orientable / giratoria / rotante		
						
	170 mm 6¾"	210 mm 8¼"	230 mm 9"	170 mm 6¾"	210 mm 8¼"	230 mm 9"
MINI	40.772.17	40.772.21	40.772.23	40.772.18	40.772.31	40.772.24
STANDARD	40.774.17	40.774.21	40.774.23	40.774.19	40.774.22	



BIEMER	Maulöffnung Opening of jaw Ouverture des mors Apertura de boca Apertura di morsi	Maullänge Length of jaws Longuer des mors Longitud de boca Lunhg. di morsi	Schließkraft Closing force Force d'occlusion Fuerza de oclusión Forza di occlusiva
			
	4,0 mm	6,0 mm	30 - 40 gms 0,29 - 0,39 Newton
12.040.01			
	5,0 mm	9,0 mm	30 - 40 gms 0,29 - 0,39 Newton
12.040.02			
	5,0 mm	9,0 mm	30 - 40 gms 0,29 - 0,39 Newton
12.040.03			



Anlegepinzette ohne Schloss
 Applying forceps without lock
 Pince à appliquer sans blocage
 Pinza sin cierre
 Applicatore senza serratura

BIEMER
 12.046.14
 14,5 cm/5¾"



Anlegepinzette mit Schloss
 Applying forceps with lock
 Pince à appliquer avec blocage
 Pinza con cierre
 Applicatore con serratura

BIEMER
 12.048.14
 14,5 cm/5¾"





MEHDORN Gefäßclips - für temporären Gebrauch

MEHDORN Vessel clips - for temporary occlusion

MEHDORN Serre-Fines - pour occlusion temporaire

MEHDORN Clips vasculares - para oclusión temporal

MEHDORN Pinze - per occlusioni temporari

MEHDORN	Maullänge Length of jaws Longuer des mors Longitud de boca Lunghg. di morsi	Schließkraft Closing force Force d'occlusion Fuerza de oclusión Forza di occlusiva
 12.043.01	4 x 1,0 mm	10 - 15 gms 0,10 - 0,15 Newton
 12.043.02	4 x 1,4 mm	10 - 15 gms 0,10 - 0,15 Newton
 12.043.03	6 x 1,0 mm	10 - 15 gms 0,10 - 0,15 Newton
 12.043.04	6 x 1,4 mm	15 - 20 gms 0,15 - 0,20 Newton

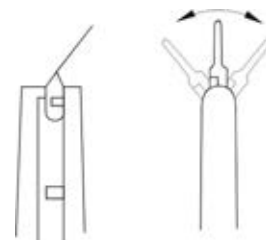

Anlegepinzette ohne Schloss
Applying forceps without lock
Pince à appliquer sans blocage
Pinza sin cierre
Applicatore senza serratura

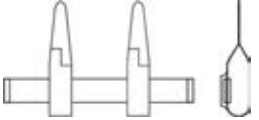
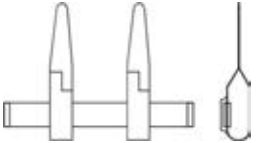
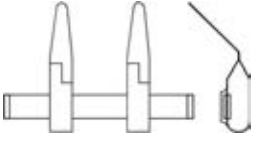
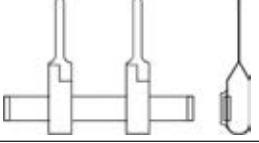
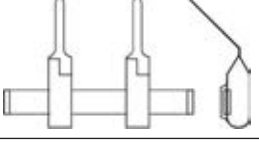

MEHDORN
12.050.15
15 cm/6"

BIEMER - MÜLLER	Maulöffnung Opening of jaw Ouverture des mors Apertura de boca Apertura di morsi	Maullänge Length of jaws Longuer des mors Longitud de boca Lunhg. di morsi	Schließkraft Closing force Force d'occlusion Fuerza de oclusión Forza di occlusiva
 12.014.00	4,0 mm	6,0 mm	30 - 40 gms 0,29 - 0,39 Newton
 12.010.00	5,0 mm	9,0 mm	30 - 40 gms 0,29 - 0,39 Newton
 12.011.00	5,0 mm	9,0 mm	30 - 40 gms 0,29 - 0,39 Newton
 12.012.00	5,0 mm	9,0 mm	30 - 40 gms 0,29 - 0,39 Newton
 12.013.00	5,0 mm	9,0 mm	30 - 40 gms 0,29 - 0,39 Newton



BIEMER
12.046.14
 14,5 cm/5¾"

Anlegepinzette ohne Schloss
 Applying forceps without lock
 Pince à appliquer sans blocage
 Pinza sin cierre
 Applicatore senza serratura



BIEMER
12.048.14
 14,5 cm/5¾"

Anlegepinzette mit Schloss
 Applying forceps with lock
 Pince à appliquer avec blocage
 Pinza con cierre
 Applicatore con serratura

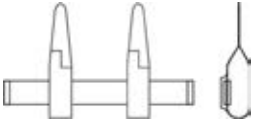
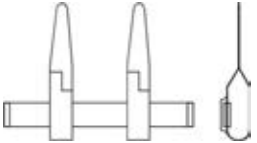
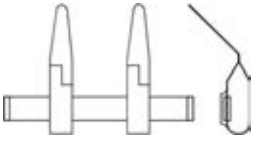
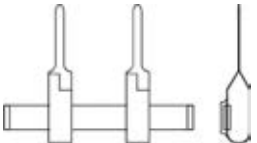
MÜLLER	Ø	Schließkraft Closing force Force d'occlusion Fuerza de oclusión Forza di occlusiva
 12.028.01	1 mm	25 - 30 gms 0,25 - 0,29 Newton
 12.028.02	2 mm	25 - 30 gms 0,25 - 0,29 Newton
 12.028.03	3 mm	25 - 30 gms 0,25 - 0,29 Newton
 12.028.04	4 mm	25 - 30 gms 0,25 - 0,29 Newton

Anlegepinzette ohne Schloss
 Applying forceps without lock
 Pince à appliquer sans blocage
 Pinza sin cierre
 Applicatore senza serratura

Anlegepinzette mit Schloss
 Applying forceps with lock
 Pince à appliquer avec blocage
 Pinza con cierre
 Applicatore con serratura



BIEMER
12.046.14
 14,5 cm/5³/₄"

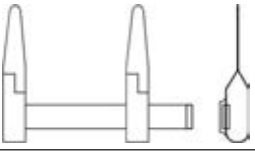

BIEMER
12.048.14
 14,5 cm/5³/₄"

BIEMER	Maulöffnung Opening of jaw Ouverture des mors Apertura de boca Apertura di morsi	Maullänge Length of jaws Longuer des mors Longitud de boca Lunhg. di morsi	Schließkraft Closing force Force d'occlusion Fuerza de oclusión Forza di occlusiva
 12.016.00	5,0 mm	9,0 mm	30 - 40 gms 0,29 - 0,39 Newton



12.016.00

12.050.14

BIEMER Approximator Set aus Artikel **12.016.00** & **12.044.14**
 BIEMER Approximator set consisting of **12.016.00** & **12.044.14**
 BIEMER Approximateurs set **12.016.00** & **12.044.14**
 BIEMER Aproximadores set **12.016.00** & **12.044.14**
 BIEMER Approssimatori set **12.016.00** & **12.044.14**

Anlegepinzette ohne Schloss
 Applying forceps without lock
 Pince à appliquer sans blocage
 Pinza sin cierre
 Applicatore senza serratura



12.024.00

BIEMER Approximator mit Schlüssel **12.041.01**
 BIEMER Approximator with key **12.041.01**
 BIEMER Approximateurs avec clé **12.041.01**
 BIEMER Aproximadores con llave **12.041.01**
 BIEMER Approssimatori con chiave **12.041.01**



12.041.00

BIEMER Approximator mit Schlüssel **12.041.01** und Nadeln **12.041.02**
 BIEMER Approximator with key **12.041.01** and needles **12.041.02**
 BIEMER Approximateurs avec clé **12.041.01** et d'aiguilles **12.041.02**
 BIEMER Aproximadores con llave **12.041.01** y agujas **12.041.02**
 BIEMER Approssimatori con chiave **12.041.01** e aghi **12.041.02**



12.041.01

Schlüssel allein
 Key only
 Clé seule
 Llave suelta
 Sola chiave









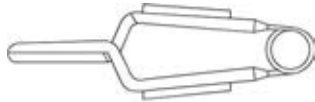

12.041.02

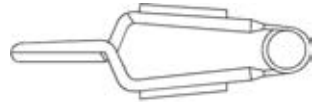

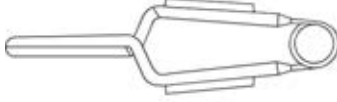
1 Paar Ersatznadeln
 1 Pair of spare needles
 1 Paire d'aiguilles de rechange
 1 Par de agujas de recambio
 1 Paio di aghi di ricambio

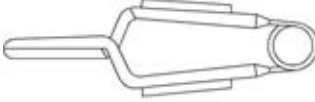

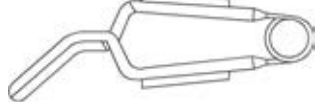

BIEMER
12.044.14
 14,5 cm/5¾"

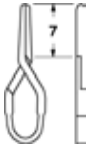
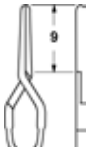
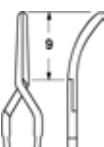
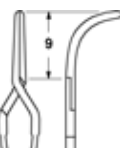
MÜLLER Gefäßclips - für temporären Gebrauch
 MÜLLER Vessel clips - for temporary occlusion
 MÜLLER Serre-Fines - pour occlusion temporaire
 MÜLLER Clips vasculares - para oclusión temporal
 MÜLLER Pinze - per occlusioni temporari



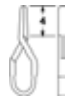

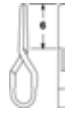
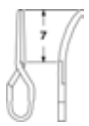
MÜLLER		Schließkraft Closing force Force d'occlusion Fuerza de oclusión Forza di occlusiva
	12.030.50	50 gms 0,49 Newton
		12.030.80
		12.031.50
		12.031.80
		12.033.50
		12.033.80
		12.035.50
		12.035.80
		12.037.50
		12.037.80



BULLDOG STANDARD	Schließkraft Closing force Force d'occlusion Fuerza de oclusión Forza di occlusiva
	120-150 gms.
40.567.40	
	120-150 gms.
40.567.50	
	120-150 gms.
40.567.52	
	120-150 gms.
40.567.54	
	120-150 gms.
40.567.46	

BULLDOG MINI	Schließkraft Closing force Force d'occlusion Fuerza de oclusión Forza di occlusiva
	70-100 gms.
40.567.10	
	70-100 gms.
40.567.12	
	70-100 gms.
40.567.20	
	70-100 gms.
40.567.22	





ACLAND Mikro-Gefäßclips
 ACLAND Micro vessel clips
 ACLAND Micro clips vasculaires
 ACLAND Micro clips vasculares
 ACLAND Micro clips vascolari



Länge / Length / Longueur Longitud / Lunghezza		8 mm	11 mm	16 mm	24 mm	35 mm
Gefäß / Vessel / Vaisseaux Vaso / Vaso	Ø	0,3 - 1,0 mm	0,6 - 1,4 mm	1,0 - 2,2 mm	1,5 - 3,3 mm	2,0 - 5,0 mm



Vene / Vein / Veine Vena / Vena	V	12.052.11	12.052.12	12.052.13	12.052.14	12.052.15
Arterie / Artery / Artère Arteria/ Arteria	A	12.052.01	12.052.02	12.052.03	12.052.04	12.052.05
Einzel Clips Single Clips Clips simples Clip singular Clips singoli Verpackungseinheit 2 Stück Packing unit 2 pieces Boîtes de 2 pièces Cajas con 2 piezas Unità di 2 pezzi						

Vene / Vein / Veine Vena / Vena	V	12.052.31	12.052.32	12.052.33
Arterie / Artery / Artère Arteria/ Arteria	A	12.052.21	12.052.22	12.052.23
Einzel Clips Single Clips Clips simples Clip singular Clips singoli Verpackungseinheit 2 Stück Packing unit 2 pieces Boîtes de 2 pièces Cajas con 2 piezas Unità di 2 pezzi				

Länge / Length / Longueur Longitud / Lunghezza		8 mm	11 mm	16 mm	24 mm	35 mm
Gefäß / Vessel / Vaisseaux Vaso / Vaso	Ø	0,3 - 1,0 mm	0,6 - 1,4 mm	1,0 - 2,2 mm	1,5 - 3,3 mm	2,0 - 5,0 mm

Vene / Vein / Veine Vena / Vena	V	12.052.51	12.052.52	12.052.53	12.052.54	12.052.55
Arterie / Artery / Artère Arteria/ Arteria	A	12.052.41	12.052.42	12.052.43	12.052.44	12.052.45
Approximatoren Approximators Approximateurs Aproximadores Aprossimatori						

Vene / Vein / Veine Vena / Vena	V	12.052.71	12.052.72	12.052.73
Arterie / Artery / Artère Arteria/ Arteria	A	12.052.61	12.052.62	12.052.63
Approximatoren Approximators Approximateurs Aproximadores Aprossimatori				

Vene / Vein / Veine Vena / Vena	V	12.052.91	12.052.92	12.052.93
Arterie / Artery / Artère Arteria/ Arteria	A	12.052.81	12.052.82	12.052.83
Approximatoren Approximators Approximateurs Aproximadores Aprossimatori				

ACLAND Clip-Anlegepinzetten

ACLAND Clip applying forceps

ACLAND Pinces pour poser les clips

ACLAND Pinzas para aplicar clips

ACLAND Pinze per applicare clips

für Clips 8 - 11 mm
for clips 8 - 11 mm
pour clips 8 - 11 mm
para clips 8 - 11 mm
per clips 8 - 11 mm

ohne Schloss
without lock
sans blocage
sin cierre
senza serratura

mit Schloss
with lock
avec blocage
con cierre
con serratura



ACLAND
12.053.00
14 cm/5½"

ACLAND
12.053.10
14 cm/5½"

für Clips 16 - 35 mm
for clips 16 - 35 mm
pour clips 16 - 35 mm
para clips 16 - 35 mm
per clips 16 - 35 mm

ohne Schloss
without lock
sans blocage
sin cierre
senza serratura

mit Schloss
with lock
avec blocage
con cierre
con serratura



ACLAND
12.053.02
14 cm/5½"

ACLAND
12.053.12
14 cm/5½"

für Clips 8 - 11 mm
for clips 8 - 11 mm
pour clips 8 - 11 mm
para clips 8 - 11 mm
per clips 8 - 11 mm

ohne Schloss
without lock
sans blocage
sin cierre
senza serratura

mit Schloss
with lock
avec blocage
con cierre
con serratura



ACLAND
12.053.01
14 cm/5½"

ACLAND
12.053.11
14 cm/5½"



88.765.02
18 Clips
150 x 95 x 13 mm

Edelstahl
Stainless steel
Acier inoxydable
Acero inoxidable
Acciaio inox



88.765.03
42 Clips
210 x 125 x 17 mm

Edelstahl
Stainless steel
Acier inoxydable
Acero inoxidable
Acciaio inox

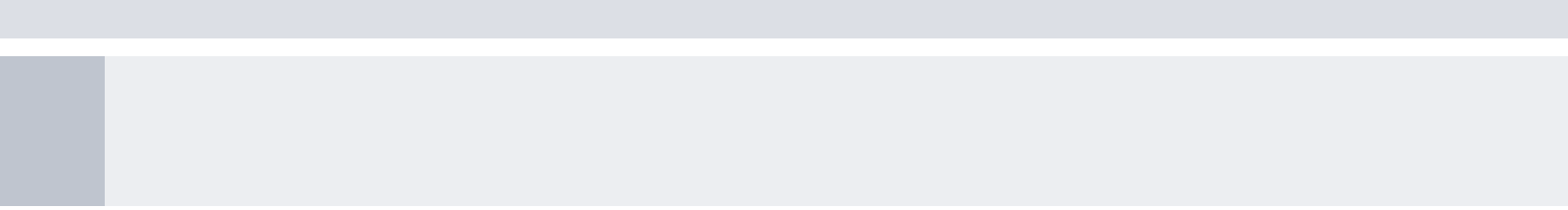

18

◆ HYPOPHYSEKTOMIE-INSTRUMENTE

PITUITARY INSTRUMENTS

INSTRUMENTS POUR L'HYPOPHYSECTOMIE

INSTRUMENTOS PARA HIPOFISECTOMÍA

STRUMENTI PER IPOFISECTOMIA

Spekula zur transsphenoïdalen Hypophysektomie

Specula for trans-sphenoidal hypophysectomy

Spéculum pour l'hypophysectomie transsphénoïdale

Espéculo para la hipofisectomía trans-esfenoidal

Specolo per ipofisectomia transfenoidale



CUSHING-LANDOLT

70 x 15 mm	40.801.70
90 x 15 mm	40.801.90
110 x 15 mm	40.802.10



PAPAVERO-CASPAR

80 x 11 mm	40.803.11
90 x 13 mm	40.803.13
100 x 15 mm	40.803.15



HARDY

70 mm	40.805.70
80 mm	40.805.80
90 mm	40.805.90



Spreizzange für Spekula
Spreading forceps for specula
Pince écartante pour spéculum
Pinza dilatadora para espéculos
Pinza divaricatrice per specoli

LANDOLT
40.804.21
21 cm/8¼"



Lamina-Meißel
Lamina chisel
Ciseau burin pour les lames de l'arc vertébral
Cinzel para lámina
Scalpello per lamina



PAPAVERO
40.803.22
22 cm/8¾"



RAY
40.810.04
 19 cm/7½"

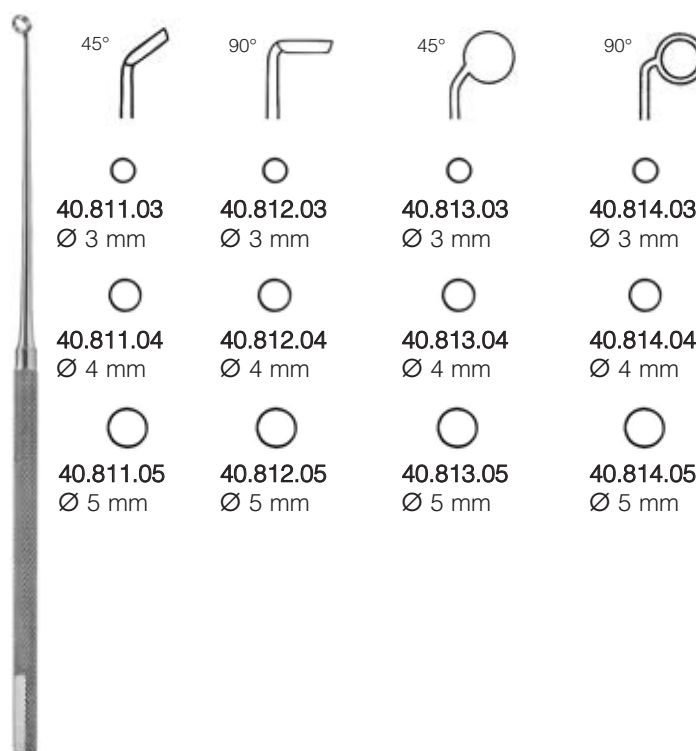

RAY
 19 cm/7½"

Hypophysenküretten
 Pituitary curettes
 Curettes à hypophyse
 Curetas para hipófisis
 Curetta per ipofisix

Hypophysenküretten, biegsam
 Pituitary curettes, malleable
 Curettes à hypophyse, flexibles
 Curetas para hipófisis, maleables
 Curette per ipofisi, malleabile



HARDY
 26 cm/10¼" **40.815.04**
 Ø 4 mm

40.815.06
 Ø 6 mm

Küretten, biegsam
 Curettes, malleable
 Curettes, flexibles
 Curetas, maleables
 Curette, malleabile

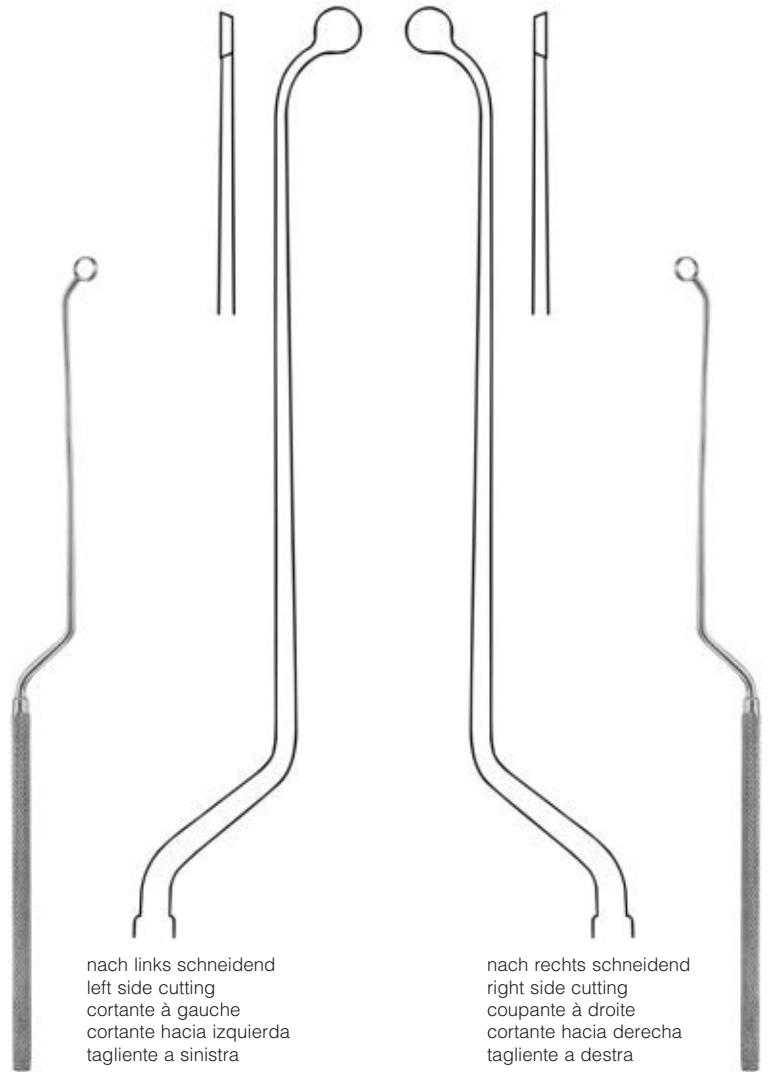

nach links schneidend
 left side cutting
 cortante à gauche
 cortante hacia izquierda
 tagliente a sinistra

nach rechts schneidend
 right side cutting
 coupante à droite
 cortante hacia derecha
 tagliente a destra

NICOLA
40.817.65
 26 cm/10¼" Ø 6,5 mm

NICOLA
40.819.65
 26 cm/10¼" Ø 6,5 mm

Küretten
 Curettes
 Curettes
 Curetas
 Curette

Ø 6,5 mm

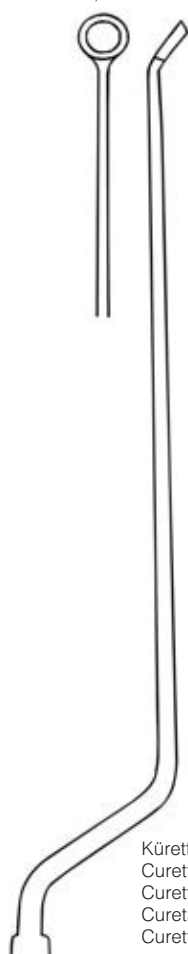

Küretten, biegsam
 Curettes, malleable
 Curettes, flexibles
 Curetas, maleables
 Curette, malleabile

NICOLA
40.821.65
 26 cm/10¼"



Raspatorium
 Raspatory
 Rugine
 Legras
 Periostotomo

NICOLA
40.823.00
 21,5 cm/8¼"



CONE
 23 cm/9"

3 mm	40.824.03
4 mm	40.824.04
6 mm	40.824.06
7 mm	40.824.07
8 mm	40.824.08
9 mm	40.824.09

CONE
 23 cm/9"

3 mm	40.825.03
4 mm	40.825.04
6 mm	40.825.06
7 mm	40.825.07
8 mm	40.825.08
9 mm	40.825.09

Hypophysektomie-Instrumente
 Hypophysectomy instruments
 Instruments pour l'hypophysectomie
 Instrumentos para hipofisectomía
 Strumenti per ipofisectomia

Enukleatoren, stumpf
 Enucleators, blunt
 Enucleateurs, mousés
 Enucleadores, romos
 Enucleatore, smusso

Dissektoren, innen scharf
 Dissectors, inner edge sharp
 Dissecteur, pointu à l'intérieur
 Disectores, agudo en el interior
 Dissettori, bordo interno acuto

Implantationsgabel
 Implant fork
 Fourchette pour implants
 Horquilla para implantar
 Forchetta per trapianto

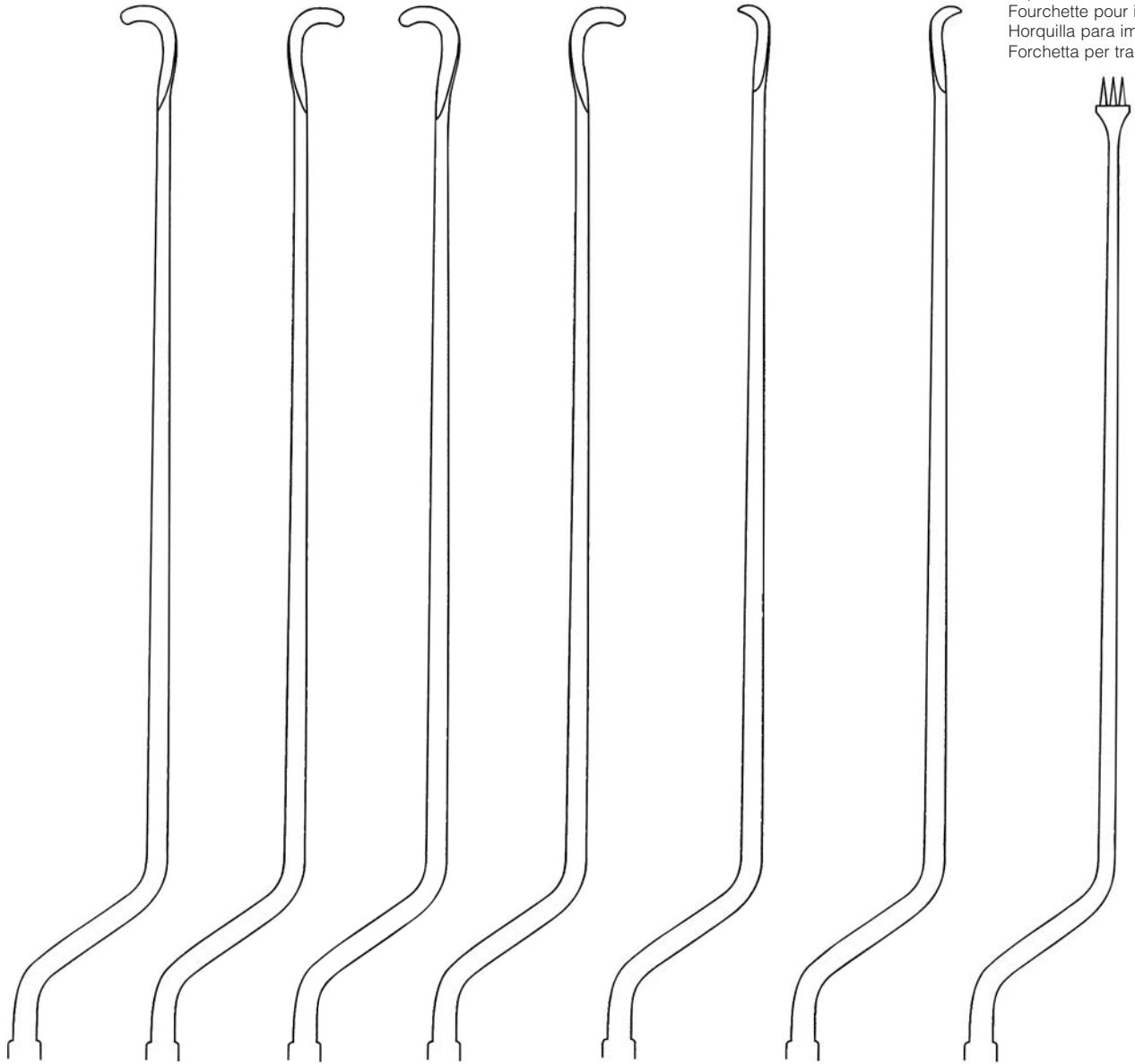

HARDY
 24,5 cm/9¾"

40.831.00

40.831.01

40.831.02

40.831.03

HARDY-FAHLBUSCH
 40.832.01

40.832.02

40.831.04



LANDOLT
 26 cm/10¼"

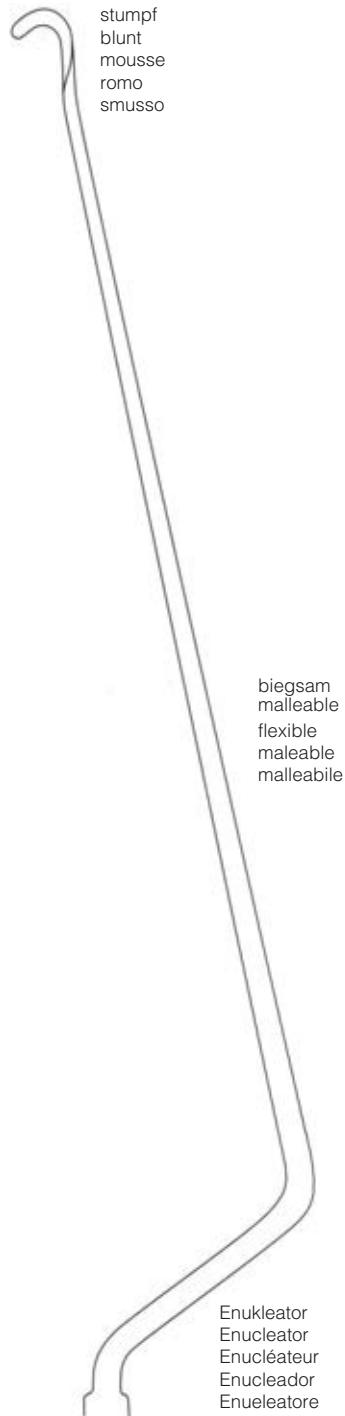

40.835.00

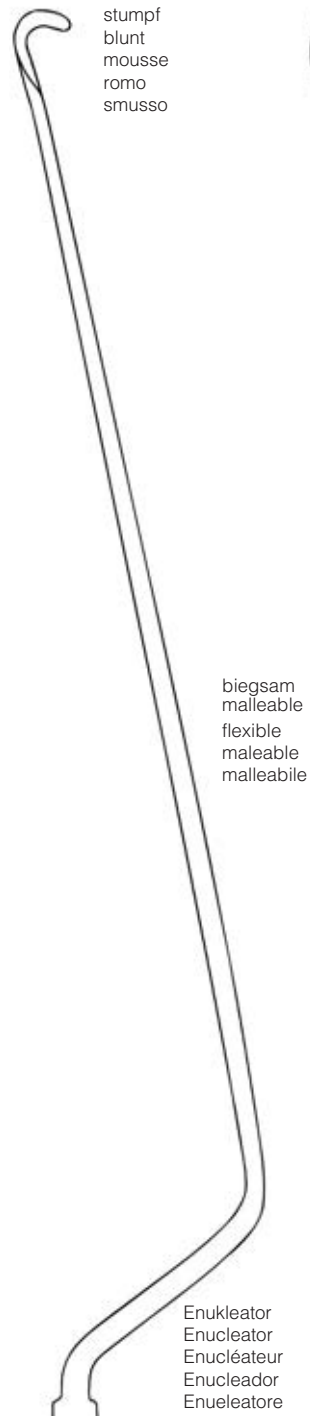

40.835.01

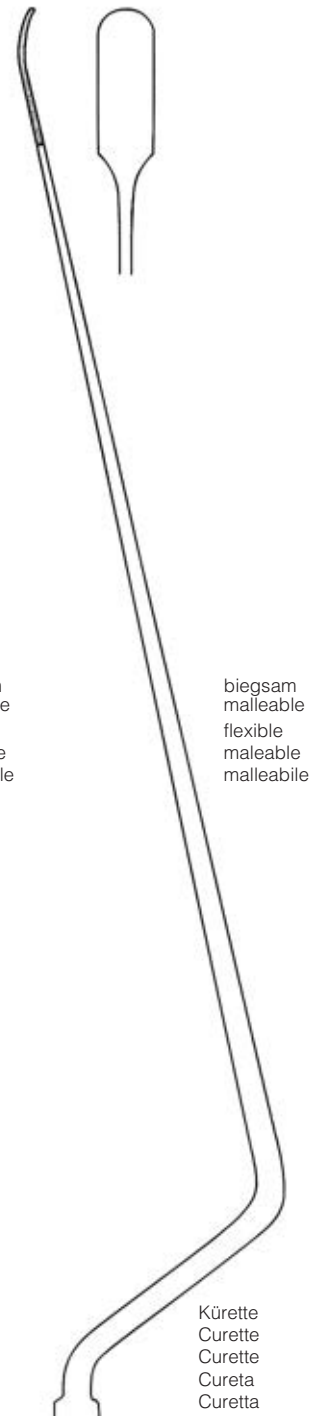

40.835.02

Hypophysektomie-Instrumente

Hypophysectomy instruments
Instruments pour l'hypophysectomie
Instrumentos para hipofisectomía
Strumenti per ipofisectomia



LANDOLT
26 cm/10 1/4"

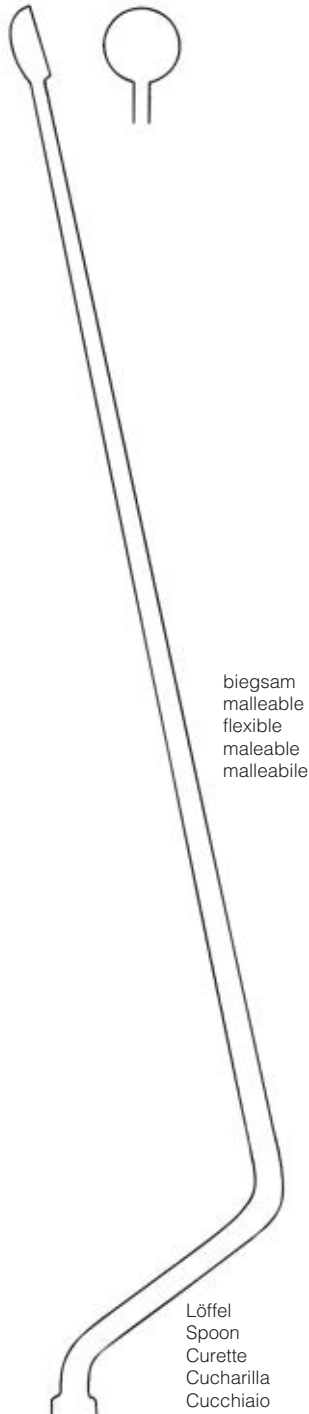

40.835.03

Löffel
Spoon
Curette
Cucharilla
Cucchiaio

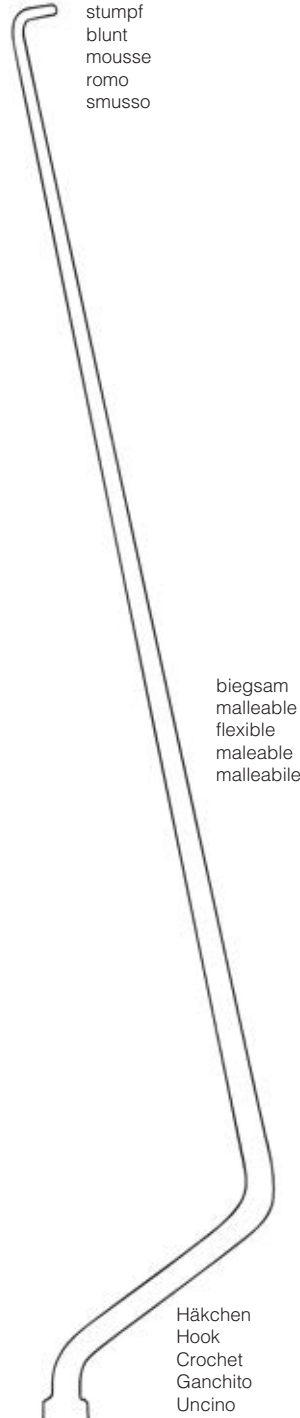

40.835.04

Häkchen
Hook
Crochet
Ganchito
Uncino

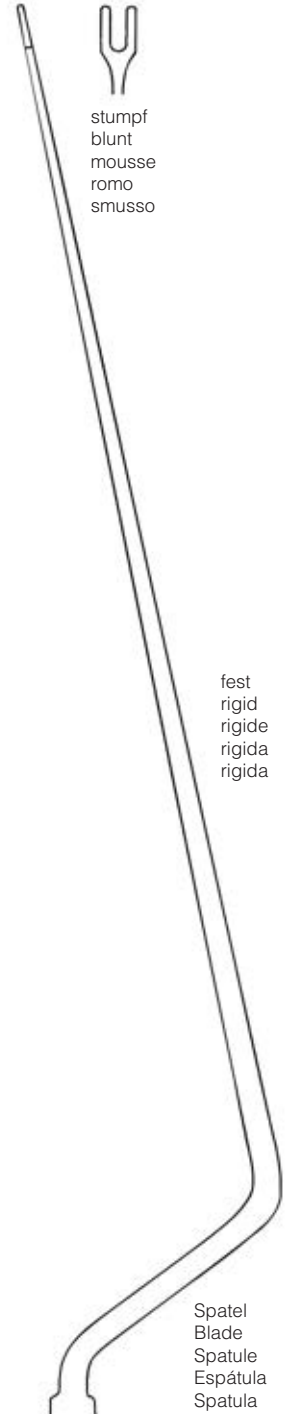

HOSOBUCHI
40.836.00

Spatel
Blade
Spatule
Espátula
Spatula



26 cm/10¼"

Ø 2,5 mm



FAHLBUSCH
40.841.25

Kürette, biegsam
Curette, malleable
Rugine, flexible
Legra, maleable
Periostotomo, malleabile

Ø 2,2 mm



LANDOLT REULEN
40.843.22

Raspatorium
Raspatory
Rugine
Legras
Periostotomo

Ø 3,2 mm



LANDOLT REULEN
40.843.32

Raspatorium
Raspatory
Rugine
Legras
Periostotomo

Ø 2,5 mm



LANDOLT REULEN
40.845.25

Kürette
Curette
Curette
Cureta
Curetta



LANDOLT REULEN
40.847.17

Stumpfes Häkchen
Blunt hook
Crochet mousse
Ganchito romo
Uncino smusso

2,0 mm



LANDOLT REULEN
40.849.20

Dissektor
Dissector
Dissecteur
Disector
Dissettore

Ø 2,0 mm



FAHLBUSCH
40.840.20

Löffel, biegsam
Spoon, malleable
Curette, flexible
Cucharilla, maleable
Cucchiaio, malleabile

Hypophysenküretten
 Pituitary curettes
 Curettes à hypophyse
 Curetas para hipófisis
 Curette per ipofisi

Küretten
 Curettes
 Curettes
 Curetas
 Curette

Küretten
 Curettes
 Curettes
 Curetas
 Curette



aufgewinkelt
 angled up
 vers le haut
 hacia arriba
 verso l'alto



abgewinkelt
 angled down
 vers le bas
 hacia baja
 verso il basso



45°
 rechts gebogen
 curved right
 courbé à droite
 curvada a la derecha
 curvo destro



90°
 links gebogen
 curved left
 courbé à gauche
 curvada a la izquierda
 curvo sinistro

HARDY
 24 cm/9½"

3 mm	40.850.03
5 mm	40.850.05

HARDY
 24 cm/9½"

3 mm	40.851.03
5 mm	40.851.05

HARDY
 24 cm/9½"

3 mm	40.852.03
5 mm	40.852.05

HARDY
 24 cm/9½"

3 mm	40.853.03
5 mm	40.853.05

Küretten
 Currettes
 Curettes
 Curetas
 Curette

Mikro-Dissektoren
 Micro dissectors
 Micro dissecteurs
 Micro disectores
 Micro dissectori

5 mm



rechts gebogen
 curved right
 courbé à droite
 curvada a la derecha
 curvo destro

HARDY
40.854.05
 24 cm/9½"

5 mm



links gebogen
 curved left
 courbé à gauche
 curvada a la izquierda
 curvo sinistro

HARDY
40.855.05
 24 cm/9½"

2 mm



aufgewinkelt
 angled up
 vers le haut
 hacia arriba
 verso l'alto

HARDY
40.833.02
 24 cm/9½"

2 mm



abgewinkelt
 angled down
 vers le bas
 hacia baja
 verso il basso

HARDY
40.834.02
 24 cm/9½"

Hypophysektomie-Instrumente

Hypophysectomy instruments
Instruments pour l'hypophysectomie
Instrumentos para hipofisectomía
Strumenti per ipofisectomia

Löffel, biegsam
Spoon, malleable
Curette, flexible
Cucharilla, maleable
Cucchiaio, malleabile



HARDY
40.856.24
23,5 cm/9¼"

Mikrospiegel, beweglich, zur retrospektiven Inspektion
Micro mirror, moveable, for retrospective inspection
Micro miroir, mobile, pour retrospective inspection
Micro espejo, móvil, de inspección retrospective
Micro-specchio, mobili, per l'ispezione retrospective

6 mm



HARDY
40.830.00
23 cm/9"



ADSON
40.210.23
23 cm/9"



ADSON
40.211.23
23 cm/9"

ADSON
40.213.23
23 cm/9"



LANDOLT
40.875.22
21,5 cm/8½"



HARDY
40.876.21
21 cm/8¼"

Hypophysektomie-Instrumente

Hypophysectomy instruments
 Instruments pour l'hypophysectomie
 Instrumentos para hipofisectomía
 Strumenti per ipofisectomia

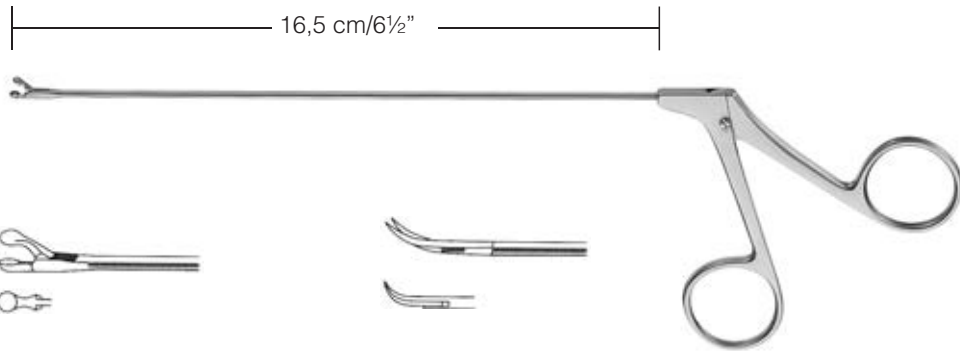

NICOLA
40.882.16
 Ø 2,5 mm

Scharfe Zange mit löffelförmigem Maul
 Forceps, scoop-shaped
 Pince, en forme de cuillère
 Pinza, en forma de cuchara
 Pinze, a forma di cucchiaio

FAHLBUSCH
40.881.16

Schere, horizontal schneidend
 Schere, horizontal cutting, curved on flat
 Ciseaux, coupe horizontale
 Tijeras, corte horizontal
 Forbici, taglio orizzontale



YASARGIL-NICOLA
40.886.16

Fasszange mit feinem Maul
 Forceps, long conical jaws, delicate
 Pince, conique long mâchoires, fine
 Pinza, cónico largo mandíbulas, fina
 Pinze, lungo conico mascelle, fina



NICOLA
40.884.16

Schere, gerade
 Scissors, straight
 Ciseaux, droits
 Tijeras, rectas
 Forbici, diritta

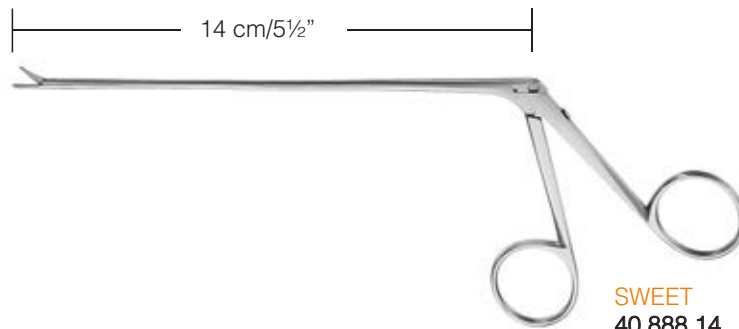

SWEET
40.888.14
 10 mm



40.892.14
 5 mm

gerade
 straight
 droit
 recta
 diritta

40.893.14
 5 mm

links gebogen
 curved left
 courbé à gauche
 curvada a la izquierda
 curvo sinistro

40.895.14
 5 mm

rechts gebogen
 curved right
 courbé à droite
 curvada a la derecha
 curvo destro

DECKER

19

◆ HOCHFREQUENZ-CHIRURGIE

HIGH FREQUENCY SURGERY

CHIRURGIE À HAUTE FRÉQUENCE

ELECTROCIRUGÍA

ELECTTROCHIRURIGA

Koagulationspinzetten, bipolar
 Coagulation forceps, bipolar
 Pincés pour coagulation, bipolaires
 Pinzas de coagulación, bipolares
 Pinze per coagulazione, bipolari



90.316.03	155 mm	0,3 mm
90.316.06	155 mm	0,6 mm
90.316.01	155 mm	1,0 mm
90.316.02	155 mm	2,0 mm



90.330.03	180 mm	0,3 mm
90.330.06	180 mm	0,6 mm
90.330.01	180 mm	1,0 mm
90.330.02	180 mm	2,0 mm



90.352.03	200 mm	0,3 mm
90.352.06	200 mm	0,6 mm
90.352.01	200 mm	1,0 mm
90.352.02	200 mm	2,0 mm

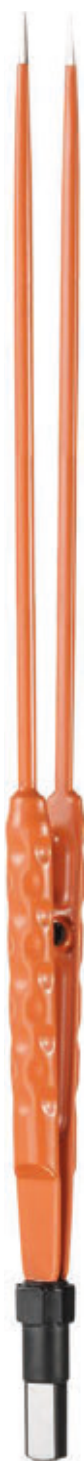

90.370.03	225 mm	0,3 mm
90.370.06	225 mm	0,6 mm
90.370.01	225 mm	1,0 mm
90.370.02	225 mm	2,0 mm



90.344.03	180 mm	0,3 mm
90.344.06	180 mm	0,6 mm
90.344.01	180 mm	1,0 mm
90.344.02	180 mm	2,0 mm



90.332.03	200 mm	0,3 mm
90.332.06	200 mm	0,6 mm
90.332.01	200 mm	1,0 mm
90.332.02	200 mm	2,0 mm

Koagulationspinzetten, bipolar

Coagulation forceps, bipolar
Pincas pour coagulation, bipolaires
Pinzas de coagulación, bipolares
Pinze per coagulazione, bipolari



90.372.03	225 mm	0,3 mm
90.372.06	225 mm	0,6 mm
90.372.01	225 mm	1,0 mm
90.372.02	225 mm	2,0 mm



90.382.03	250 mm	0,3 mm
90.382.06	250 mm	0,6 mm
90.382.01	250 mm	1,0 mm
90.382.02	250 mm	2,0 mm



90.317.03	155 mm	0,3 mm
90.317.06	155 mm	0,6 mm
90.317.01	155 mm	1,0 mm
90.317.02	155 mm	2,0 mm



90.331.03	180 mm	0,3 mm
90.331.06	180 mm	0,6 mm
90.331.01	180 mm	1,0 mm
90.331.02	180 mm	2,0 mm



90.357.03	200 mm	0,3 mm
90.357.06	200 mm	0,6 mm
90.357.01	200 mm	1,0 mm
90.357.02	200 mm	2,0 mm



90.371.03	225 mm	0,3 mm
90.371.06	225 mm	0,6 mm
90.371.01	225 mm	1,0 mm
90.371.02	225 mm	2,0 mm

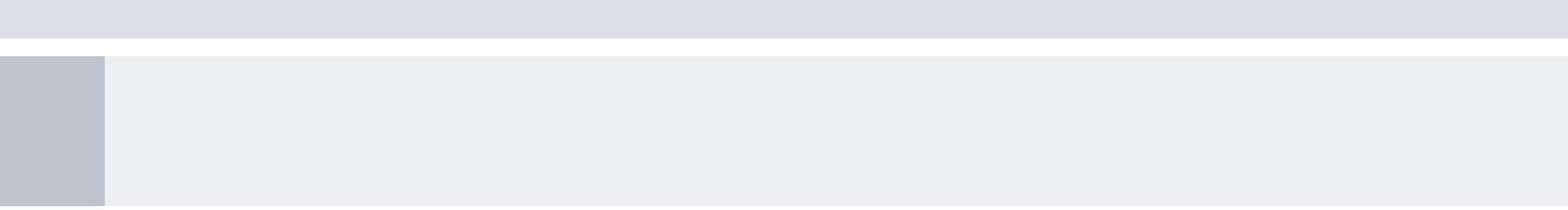

20

◆ CONTAINER

CONTAINERS

CONTAINER

CONTENEDORES

CONTAINER

Container

Containers
Container
Contenedores
Container

Aluminium
Aluminium
Aluminium
Aluminio
Alluminio



285 x 280 x 100 mm

Deckel gelocht - Boden ungelocht
Lid perforated - Bottom non perforated
Courvercle perforé - Fond non perforé
Tapa perforada - Fondo no perforado
Coperchio forato - Fondo non forato

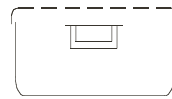

88.620.01

Deckel gelocht - Boden gelocht
Lid perforated - Bottom perforated
Courvercle perforé - Fond perforé
Tapa perforada - Fondo perforado
Coperchio forato - Fondo forato

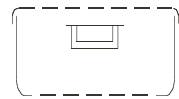

88.621.01

Siebkörbe Edelstahl
Wire baskets, stainless steel
Paniers grillagés, acier inoxydable
Cestillos de acero inoxidable
Cestelli in acciaio inox



88.629.01

255 x 245 x 30 mm

88.629.02

255 x 245 x 50 mm

88.629.03

255 x 245 x 70 mm

88.629.04

255 x 245 x 100 mm

Siebboden
Separate floor
Fond du crible
Fondo de la cesta
Fondo di cestello



88.629.11

255 x 245 x 30 mm

Silikon-Noppenmatte
Silicone mats
Tapis en silicone
Esterilla de silicona
Stuoia di silicone

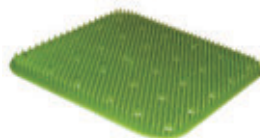

88.695.21

245 x 245 mm

Deckel gelocht - Boden gelocht
Lid perforated - Bottom perforated
Couvercle perforé - Fond perforé
Tapa perforada - Fondo perforado
Coperchio forato - Fondo forato

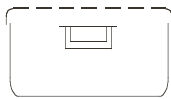

Edelstahl
Stainless steel
Acier inoxydable
Acero inoxidable
Acciaio inox

Innenmaß
Internal dimensions
Dimension interne
Dimensión interna
Dimensione interna

L x B x H

88.290.01	200 x 140 x 50 mm
88.290.02	400 x 100 x 50 mm
88.290.03	400 x 150 x 50 mm
88.290.04	280 x 195 x 50 mm
88.290.05	265 x 255 x 50 mm
88.290.06	370 x 190 x 50 mm
88.290.07	380 x 260 x 50 mm
88.290.08	430 x 230 x 50 mm
88.290.09	380 x 125 x 50 mm
88.290.10	470 x 250 x 50 mm

Sterilisierkassetten mit Silikon-Noppenstreifen
Sterilization cases with silicone cushioning stripes
Cassettes de stérilisation avec picots en silicone
Casetes de esterilización con bandas de silicona acolchada
Sterilizzazione dei cassette con imbottitura strisce di silicone

L x B x H

88.291.01	200 x 140 x 65 mm
88.291.02	400 x 100 x 65 mm
88.291.03	400 x 150 x 65 mm
88.291.04	280 x 195 x 65 mm
88.291.05	265 x 255 x 65 mm
88.291.06	370 x 190 x 65 mm
88.291.07	380 x 260 x 65 mm
88.291.08	430 x 230 x 65 mm
88.291.09	380 x 125 x 65 mm
88.291.10	470 x 250 x 65 mm

Sterilisierkassetten mit Silikon-Noppenstreifen und Zweifach-Lagerung
Sterilization cases with silicone cushioning stripes and dual storage
Cassettes de stérilisation avec rembourrage en silicone à double stockage
Casetes de esterilización con relleno de silicona en doble almacenamiento
Sterilizzazione dei cassette con imbottitura di silicone sul strisce due scaffalature

L x B x H

88.292.01	200 x 140 x 55 mm
88.292.02	400 x 100 x 55 mm
88.292.03	400 x 150 x 55 mm
88.292.04	280 x 195 x 55 mm
88.292.05	265 x 255 x 55 mm
88.292.06	370 x 190 x 55 mm
88.292.07	380 x 260 x 55 mm
88.292.08	430 x 230 x 55 mm
88.292.09	380 x 125 x 55 mm
88.292.10	470 x 250 x 55 mm

Sterilisierkassetten mit Silikon-Bank
Sterilization cases with silicone bench
Cassettes de stérilisation avec banc en silicone
Casetes de esterilización con banco de silicona
Sterilizzazione dei cassette con banco di silicone

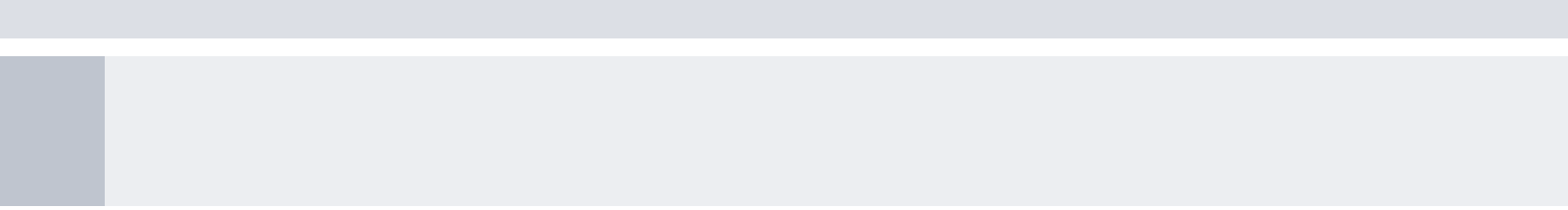

21

◆ INHALTSVERZEICHNIS

INDEX

INDEX

ÍNDICE ALFABÉTICO

INDICE

A	C	D
AACHEN Spatel 254	CAIRNS Arterienklemmen 96	DAHLGREN Schädelstanzen 222
ACLAND Anlegepinzette für Gefäß-Clips 314	CAIRNS Häkchen 224	DANDY Arterienklemmen 97
ACLAND Approximatoren 313	CAIRNS Spatel 255	DANDY Nerven-Haken 226
ACLAND Gefäß-Clips 312	CAIRNS Wundspreizer 122	DANDY Trigeminiusschere 44
ADSON (DEBAKEY) Atraumatische-Pinzetten... 79	CAROTID Bulldogklemmen 88	DARLING Laminektomiespreizer 123
ADSON Aneurysmen-Nadel 231	CARREL Arterienklemmen 93	DAUBENSPECK Scharfelöffel 176
ADSON Haken 228	CASPAR Bandscheiben-Rongeurs 271-273	DAVIS Dissektor 234
ADSON Elevatorium 200	CASPAR Blätter 131, 133	De MARTEL Einführinstrument 220
ADSON Hohlmeißelzangen 166	CASPAR Bohrer 136	DEBAKEY Arteriotomie-Schere 25
ADSON Pinzette 61-62	CASPAR Bohrlehre 134-135	DEBAKEY Atraumatische-Pinzetten 75-81, 86
ADSON Pinzette, Mikro 61	CASPAR Cervicales	DEBAKEY Bulldogklemmen 90
ADSON Pinzetten für Hypophysektomie 329	Wirbelkörperdistractionssystem 134-136	DEBAKEY Nadelhalter 152-153
ADSON Saugrohr 258	CASPAR Cervicalspreizer 129-133	DEBAKEY Schere 41
ADSON Wundspreizer 113-115	CASPAR Distractionsschrauben 136	DEBAKEY-DIETHRICH
ADSON-BABY Arterienklemmen 99	CASPAR Distraktor 134-135	Atraumatische-Pinzetten 78
ADSON-BIEMER Pinzette 62	CASPAR Explorationsund	DEBAKEY-DIETHRICH Bulldogklemmen 89
Aesthesiometer 4	Koagulationshäkchen 228	DEBAKEY-GLOVER Bulldogklemmen 88
ALLIS Fasszange 101	CASPAR Fadengabel 248	DECKER Scheren für Hypophysektomie 330
ALM Wundspreizer 108	CASPAR Lumbal-Wundspreizer 137-138	DEJERINE Hammer 3
ANDERSON-ADSON Wundspreizer 113	CASPAR Mikro-Dissektor 246	Dekompressionshaken 105
Aneurysmen-Clips 284-299	CASPAR Muskelabspreizer (Spekula) 139	D'ERRICO Bohrer 209
Aneurysmen-Nadel 231	CASPAR Nervwurzelhaken 230	DeVILBISS Schädelstanzen 222
Anlege- und Entfernungszange für	CASPAR Raspatorium 199	Diagnostik 1-4
Bulldogklemmen 91	CASPAR Scharfelöffel 179, 181	DIEFFENBACH Bulldogklemmen 91
Anlegepinzette für Gefäß-Clips 305-309, 314	CASPAR Schraubendreher 136	DIEFFENBACH feine Skalpelle 16
Anlegezangen für Aneurysmen-Clips 300-304	CASPAR Skalpellgriff, mikro 12	DIETHRICH Bulldogklemmen 89
Approximatoren 307-309, 313	CASPAR Stößel 184	DIETHRICH Schere 40
Arachnoidea-Messer 242	CASPAR Wirbelkörperdissektor 199	DIMEDA Klingenbrecher 14
Arterienklemmen 93-101	CASTROVIEJO Iridectomie Schere 48	DIMEDA Wundspreizer 109
Arteriotomie-Schere 25	CASTROVIEJO Klingenbrecher 15	Dissektor mit flexiblem Schaft 235
Atraumatische-Bulldogklemmen 88-90, 92	CASTROVIEJO Mikro-Nadelhalter 156-158, 160	Dissektoren 200-204, 246
Atraumatische-Pinzetten, mikro 75-81, 86	Cerebellum-Spreizer 112	Dissektoren, mikro 246, 249, 322, 325, 327
AUSTIN Mikropinzetten 73	Cervicales	Distractionsschrauben 136
B	Wirbelkörperdistractionssystem 134-136	Distraktor 134-135
BABINSKY Hammer 2	Cervicalspreizer 128-133	Draht Scheren 45
BABY CRILE-WOOD Nadelhalter 152	Chirurgische-Schere 18-21	Drahtsägen 220
Baby-MIXTER Arterienklemmen 101	Chirurgische-Schere, grazil 21	Drahtsägen-Handgriff 220
BACON Hohlmeißelzangen 167	CITELLI Knochenstanzen 282	Drehschlüssel allein 132, 309
BADGLEY Laminektomie-Wundspreizer 130	CLEVELAND Hohlmeißelzangen 164	DUEHRSSSEN Pinzette 67
Bandscheiben-Rongeurs 270-273	Clip-Anlegezange 215-216	DUNHILL Arterienklemmen 96
BANE-HARTMANN Hohlmeißelzangen 166	CLOWARD Blattretractor 104	Dynamometer 2
BARON Saugrohr 264	CLOWARD Laminektomiespreizer 125	
BARRAQUER Mikro-Nadelhalter 156	CLOWARD Laminektomiespreizer 148	E
BARRAQUER-TROUTMAN Mikro-	CLOWARD-HOEN Hemilaminektomie-	ECHLIN Hohlmeißelzangen 173
Nadelhalter 156	Wundspreizer 140	Einführinstrument 220
BAUMGARTNER Nadelhalter 151	COBB Spinal-Elevatorien 191	Elevatorien 200-204
BECK Rongeurs 266	COBB Spinal-Fusions-Hohlmeißel 190	Enukleatoren 322-323
BECKMANN Laminektomiespreizer 119	COBB Spinal-Fusionsküretten 179	EPSTEIN Scharfelöffel 180
BECKMANN-ADSON	COLCLOUGH Laminektomiestanzen 278	Explorations- und Koagulationshäkchen 228
Laminektomiespreizer 120	COLLIN Dynamometer 2	
BECKMANN-ADSON Wundspreizer 116	CONE Hypophysenküretten 321	F
BECKMANN-EATON Laminektomiespreizer 121	CONE Laminektomiespreizer 123	Fadenführer 241
BELLUCI Mikro-Saugkanülen 262	CONE Schädeltrephinen 221	Fadenführungsschere 25
BELLUCI Saugrohr 262	Container 338-339	Fadengabel 248
BERLINER Hammer 3	Container aus Aluminium 338	FAHLBUSCH Hypophysenküretten 325
BEYER Hohlmeißelzangen 167	Container aus Edelstahl 339	FAHLBUSCH Hypophysenöffel 325
BEYER Knochenstanzen 282	Container für Aneurysmen-	FAHLBUSCH Scheren für
BEYER Synovektomie zangen 168	& Mikro-Clips 315	Hypophysektomie 330
BIEMER Anlegepinzette	CONTOUR Kopfhautspreizer 127	FARABEUF Raspatorium 196
für Gefäß-Clips 305, 307-309	COOLEY Atraumatische-Pinzetten 78	FARABEUF-COLLIN Raspatorium 196
BIEMER Approximatoren 309	COTTLE Elevatorium 204	Feine Präparierschere 31
BIEMER Gefäß-Clips 305	COTTLE Hammer 193	FERGUSON Saugrohr 259
BIEMER Gefäßdilator 244	COTTLE Pinzette 70	FERRIS-SMITH-CHUSHING
BIEMER Mikro-Schere 54	CRILE Arterienklemmen 95	Bandscheiben-Rongeurs 270
BIEMER-MÜLLER Approximatoren 307	CRILE Nerven-Haken 227	FINSSEN Wundspreizer 108
Bipolar-Koagulationspinzetten 332-336	CRILE-RANKIN Arterienklemmen 96	FISCH Häkchen 251
Blattretractor 104	CRILE-WOOD Nadelhalter 151	FISCH Fußplattenhäkchen 251
BLUMENTHAL Hohlmeißelzangen 165	CRUTCHFIELD Schädelhalter 218	FISCH Saug- und Spülkanüle 263
BOEHLER Hohlmeißelzangen 169	CRUTCHFIELD Vorbohrer 218	Flachmeißel 185
Bohrer 136	CUSHING Arterienklemmen 96	FOMON Raspeln 206
Bohrer 209	CUSHING Dekompressionshaken 105	FRAZIER Elevatorium 234
Bohrlehre 134-135	CUSHING Häkchen 224	FRAZIER Häkchen 224
Bohrloch-Schutz zange 221	CUSHING Flachbohrer 209	FRAZIER Ventrikelpunktionskanülen 261
BROPHY Pinzette 66	CUSHING Spatel 254	FRAZIER Saugrohr 258-261
BROWN Pinzette 62	CUSHING Laminektomie zangen 268	FREER Elevatorium 203
BRUNS Scharfelöffel 175	CUSHING Nerven-Haken 227	FREER Schleimhauthäkchen 224
BUCK Hammer 3	CUSHING Pinzette 63	FRIEDMAN Hohlmeißelzangen 164
BUECHS Raspatorium 198	CUSHING Raspatorium 201-202	FRIEDMAN-MINI Hohlmeißelzangen 164
BULLDOG Gefäß-Clips 311	CUSHING Rongeurs 267	FRYKHOLM Hohlmeißelzangen 172
Bulldogklemmen 88-92	CUSHING-LANDOLT	Fußplattenhäkchen 251
BUSHE Scharfelöffel 180	Hypophysektomie-Spekula 318	
	CUSHING-TAYLOR Pinzette 64	

G

Galeahaken 219
Gefäß-Clips 283-315
Gefäßdilator 244
Gefäßmesser 242, 248
Gefäßscheren 37-41
Gefäßscheren, micro 50, 58
GELPI Perineal-Sperrer 107
GEMINI Präparier- und Ligaturklemmen 100
GEMINI-MINI Präparier- und Ligaturklemmen 100
GERALD (DEBAKEY) Atraumatische-Pinzetten 79
GERALD Pinzette 67
Gewebekrallen 251
GIERTZ STILLE Rippenschere 213
GIGLI Drahtsägen 220
GIGLI Drahtsägen-Handgriff 220
GILLIES Pinzette 65
GLASSMAN Atraumatische-Pinzetten 79
GLOVER Bulldogklemmen 88
GOLDMAN-FOX Zahnfleisch-Schere 44
GOMEL Mikropinzetten 74
GOMEL Mikro-Schere 49
GORNEY Schere 25
GRAEFE Iris Pinzette 69
GRAHAM Nerven-Haken 227
GRONINGEN Nerven-Haken 228
GRUENWALD Pinzette 64
GRUENWALD Pinzette 70
GULEKE Hohlmeißelzangen 167

H

HAJEK Hammer 192
HAJEK Keilbeinstanzen 282
HAJEK-KOFLER Keilbeinstanzen 282
HALLE Messer 238
HALLE Elevatorium 232
HALLE Scharfelöffel 177
HALSEY Nadelhalter 151
HALSTED-MOSQUITO Arterienklemmen 94
Haltehülse, für Optik 336
Hämmer 2-3, 192-195
Hämmer, aus Kunststoff 193-195
Handbohrapparate 208-210
Handgriff mit Jacobs-Futter 210
HARDY ENUKLEATOREN 322
HARDY Hypophysektomie-Spekula 318
HARDY Hypophysenküretten 320, 326-327
HARDY Hypophysenlöffel 328
HARDY Laminektomiestanzen 280
HARDY Mikro-Dissektor 327
HARDY Mikroskop 328
HARDY Pinzetten für Hypophysektomie 329
HARDY-FAHLBUSCH Mikro-Dissektor 322
HARTMANN Arterienklemmen 93
HARVEY-JACKSON Laminektomiespreizer 121
Hauthäkchen 224
HEIFETZ Spatel 255
HEIFETZ Tumorfasspinzetten 85
Hemilaminektomie-Wundspreizer 117-118
HENLY Wundspreizer 110
HESS (DEBAKEY) Bulldogklemmen 91
HESS (LOVE modif.) Nervwurzelhaken 230
HIBBS Blätter 146
Spatel 254-256
Ventrikelpunktionskanülen 261
HOEN Elevatorium 234
HOEN Hemilaminektomie-Wundspreizer 140
HOEN Kopfschwartenzangen 98
HOEN Nerven-Haken 227
HOEN Raspatorium 198
Hohlmeißel 183, 188-190
Hohlmeißel für Skoliose Operationen 188
Hohlmeißel zur Knorpelentnahme aus der Rippe 183
Hohlmeißelzangen 164-173
HORSLEY Dissektor 235
HOSOBUCHI Hypophysenlöffel 324
HOUSE Saug- und Spülkanüle 264
HOUSE Saugadapter 264
HOWARTH Elevatorium 203

HUDSON Handbohrapparat 209
HUNT Tumorfasspinzetten 84-85
Hypophysektomie-Instrumente 317-330
Hypophysenküretten 319-321, 325-327
Hypophysenlöffel 324-325, 328

I

Implantationsgabel 322
INGE Laminektomiespreizer 148
Iridectomie Scheren 48
Iris Pinzette 69
IRIS Schere 34

J

JACOBS Futter 210
JACOBSON Arterienklemmen 99
JACOBSON Fadengabel 248
JACOBSON Gefäß-Messer 248, 251
JACOBSON Knopfsonde 244
JACOBSON Mikro-Nadelhalter 158, 161
JACOBSON Mikro-Schere 55
JACOBSON Pinzette 63
JAMESON Präparierschere 42
JAMESON-WERBER Präparierschere 42
JANNETTA Wundspreizer 142
JANSEN Hohlmeißelzangen 167
JANSEN Pinzette 70
JANSEN Raspatorium 198
JANSEN Wundspreizer 109
JANSEN-GIFFORD Wundspreizer 109
JANSEN-WAGNER Wundspreizer 109
JEFFERSON Pinzette 63
JEFFERSON Wundspreizer 122
JOHNS HOPKINS Bulldogklemmen 91
JOSEPH Raspatorium 198
JOSEPH Schere 31
JOSEPH Schleimhauthäkchen 224
JULIAN Nadelhalter 154

K

Keilbeinstanzen 282
KELLY Arterienklemmen 95
KELLY-RANKIN Arterienklemmen 95
KERRISON Knochenstanzen 282
KERRISON Laminektomiestanzen 274-277
KEY Elevatorium 201
KILNER Schere 32
KIRSCHNER Draht 211
Klammernblock 217
Klemmen, Arterien 93-101
Klingendreher 14-15
KNIGHTON Laminektomiespreizer 124
Knochenheber 206-207
Knochen splitterzangen 174
Knochenstanzen 282
Knopfsonde 244, 250
Knüpfpinzetten, mikro 72-75, 86
KOCHER-LANGENBECK Wundhaken 106
KOENIG Knochenheber 207
Kölner-Klammern 217
KOOS Gefäßmesser 242
Kopfhautklammer 217
Kopfhautspreizer 127
Kopfschwartenzangen 98
KRÄMER Raspatorium 196
KRAYENBÜHL Nerv- und Gefäßhäkchen 241
Kugelfraser 208-209
Küretten, mikro 240, 24

L

LAHEY Häkchen 224
LAMBOTTE Osteotom 186
LAMBOTTE Raspatorium 196
Lamina-Meißel 318
Laminektomiespreizer 117-127, 140, 148
Laminektomiestanzen 274-280
Laminektomie zangen 268
LANDOLT ENUKLEATOREN 323
LANDOLT Hypophysenküretten 324
LANDOLT Pinzetten für Hypophysektomie 329
LANDOLT Präpariersauger 263
LANDOLT Raspatorium 199
LANDOLT Skalpellgriff, mikro 12-13
LANDOLT Spreizzange für Spekula 318

LANDOLT Tumorfasszange 269
LANDOLT-REULEN Hypophysenküretten 325
LANDOLT-REULEN Mikro-Dissektor 325
LANDOLT-REULEN Mikrohäkchen 325
LANDOLT-REULEN Raspatorium 325
LANE Knochenheber 206
LANE Wundhaken 104
LANGE Raspatorium 232
LANGENBECK Elevatorium 200
LANGENBECK Nadelhalter 154
LANGENBECK Raspatorium 197, 200
Lanzettenmesser für Tumorgewebe 245
LAZAR Pinzette 73
LEBSCHKE Einführinstrument 220
LEKSELL (STILLE) Hohlmeißelzangen 172
LEKSELL Hohlmeißelzangen 172
LEMPERT Hohlmeißelzangen 167
LEMPERT Raspatorium 232
LEMPERT Saugrohr 259
LEMPERT Scharfelöffel 177
LERICHE Arterienklemmen 99
LEXER Hohlmeißel 189
LEXER Osteotom 187-188
LEXER Schere 24
LEXER-mini Osteotom 189
Ligaturpinzetten 82
LISTER Verbandsschere 46
LITTLE-JOKER (CUSHING) Raspatorium 201
LITTLER Fadenführungsschere 25
LOGAN Wundspreizer 108
LOVE Nervwurzelhaken 230-231
LOVE-GRUENWALD Laminektomie zangen 268
LOVELACE Arterienklemmen 97
LUCAE Pinzette 70
LUER Hohlmeißelzangen 165-166
LUER Saugrohr 260
Lumbal-Wundspreizer 137-139

M

MALIS Wundspreizer 141
MARKHAM-MEYERDING Laminektomiespreizer 126
MARQUARDT Hohlmeißelzangen 169
MARTEL Kopfschwartenzangen 98
MARTIN Spatel 256
MARTINI Scharfelöffel 178
Mass-Stab 4
MATHIEU Nadelhalter 154
MAYFIELD Hohlmeißelzangen 168
MAYO (HARRINGTON) Schere 22
MAYO Schere 22
MAYO-HEGAR Nadelhalter 152
MAYO-STILLE Schere 23
McDONALD Elevatorium 203
McINDOE Knochen splitterzangen 174
McINDOE Pinzette 64
McKENY Elevatorium 202
McKENZIE Bohrer 209
McKENZIE Clip-Anlegezange 216
McKISSOCK Raspatorium 196
MEAD Hammer 195
MEAD Hohlmeißelzangen 164
MEHDORN Anlegepinzette für Gefäß-Clips 306
MEHDORN Gefäß-Clips 306
MEMORY Anlegezangen für Aneurysmen-Clips 300-301
METZENBAUM Präparierschere 26
METZENBAUM-BABY Präparierschere 26
METZENBAUM-FINO Präparierschere 27-30
MEYERDING Blätter 146
MEYERDING Laminektomiespreizer 126
MEYERDING Wundhaken 107
Mikro-Atraumatische-Pinzetten 75-81, 86
Mikro-Bulldogklemmen 92
Mikro-Elevatoren 199, 249
Mikro-Häkchen 248-251
Mikro-Nadelhalter 155-162
Mikro-Nadelhalter, Leichtmetall 161
Mikro-Nadelhalter, Titan 162
Mikro-Pinzette, Leichtmetall 72, 74
Mikro-Pinzetten 72-86
Mikro-Pinzetten, Titan 86
Mikro-Präparierschere 49, 52-53
Mikro-Schere 48-58

Mikro-Scheren, Leichtmetall	56-57
Mikro-Scheren, SuperCut	56
MILLESÍ Mikroscheren	54
MILLIGAN Dissektor	233-234
MILLS Schere	37
MINI (YASARGIL) Aneurysmen-Clips	296-295
MISKIMON Wundspreizer	113
MIXTER-BABY Arterienklemmen	101
MOLLISON Wundspreizer	122
MOLT Raspatorium	204
MOYNIHAN Arterienklemmen	97
MÜLLER Approximatoren	308
MÜLLER Gefäß-Clips	310
Muskelabspreizer für lumbale Bandscheiben operation	139

N

Nadel	250
Nadelhalter	150-162
Nadelhalter, mikro	155-162
Nadelrad	4
NAGEL Mikro-Scheren	51
Nasenzangen	281
NEIVERT Nadelhalter	151
Nerv- und Gefäßhäkchen	241
Nervenhaken	226-229, 233-235
Nervhäkchen und Dissektoren	229
Nerv-Präparierschere	42
Nervwurzelhaken	225-231
NICOLA Hypophysenküretten	320-321
NICOLA Raspatorium	321
NICOLA Scheren für Hypophysektomie	330
NICOLA Zangen für Hypophysektomie	330
NIEDERDELLMANN Osteotom	187
NORFOLK-NORWICH Laminektomiespreizer	123
NORTHFIELD Hohlmeißelzangen	168

O

O' CONNELL Nervwurzelhaken	225
OBWEGESER Osteotom	187
OKONEK-YASARGIL Tumorgabeln	248
OLDBERG Rongeurs	269
OLDBERG Wundhaken	105
OLIVECRONA Drahtsägen	220
OLIVECRONA Spatel	254
OLIVECRONA Hohlmeißelzangen	166
OLIVECRONA Trigeminiusspreizer	238
OLIVECRONA Trigeminiusschere	36
OLIVECRONA-TOENNIS Clip-Anlegezange	216
Osteotome	183-189

P

PAPAVERO Lamina-Meißel	318
PAPAVERO-CASPAR Hypophysektomie-Spekula	318
PARKER feine Skalpelle	16
PARTSCH Raspatorium	232
PENFIELD Dissektor	236-237
PENNYBACKER Rongeurs	266
PENNYBAKER Hohlmeißelzangen	168
PENNYBAKER Sonde und Dissektor	234
Perineal-Sperrer	107
Pinzette, anatomisch	60-61
Pinzette, chirurgische	60-67
Pinzetten	60-86
Pinzetten für Hypophysektomie	329-330
Pinzetten, mikro	72-86
PLESTER Saugrohr	260
POTTS-DE MARTEL Schere	37
POTTS-SMITH Pinzette	60
POTTS-SMITH Schere	37-39
POTTS-YASARGIL Mikro-Scheren	54
Präparier- und Ligaturklemmen	100
Präpariersauger	263
Präparierschere, mikro	49, 52-53
Präparierscheren	22-33
PROVIDENCE-HOSPITAL Arterienklemmen	96
Punktionskanülen	261

Q

QUERVAIN Elevatorium	200
----------------------------	-----

R

RABINER Hammer	3
RAGNELL Schere	31
RAGNELL-DAVIS Wundhaken	104
RAIMONDI Kopfschwanzzangen	98
RALK Handbohrapparat	210
RANEY Clip-Anlegezange	217
RANEY Kopfhautklammer	217
Rasier Klinge	14
Raspatorien	196-204, 232
Raspatorien, mikro	240, 243, 321, 325
Raspeln	206
RAY Hypophysenküretten	319
REILL Zwickzange	212
REYNOLDS Schere	33
RHOTON Knopfschere	250
RHOTON Mikro-Dissektor	249
RHOTON Mikro-Elevatorium	249
RHOTON Mikrohäkchen	250
RHOTON Mikrokürette	250
RHOTON Nadel	250
RHOTON Kürette	250
RIBBON Spatel	256
Ring-Pinzetten	75, 86
Rippenscheren	213
Rongeurs, Kräftiges-Modell	271
RUSKIN Hohlmeißelzangen	169
RUSKIN-LISTON Knochensplitterzangen	174
RYDER (VASCULAR) Nadelhalter	153
RYDER Nadelhalter	153

S

SACHS Dissektor	233, 235
SACHS Nerven-Haken	227
SAMII Tumorfasspinzetten	83
SAMII Tumormesser	245
SANVENERO Schere	31
SATINSKY Bulldogklemmen	88
SAUERBRUCH Hohlmeißelzangen	171
SAUERBRUCH Rippenschere	213
Saug- und Spülkanüle	263-264
Saugadapter	264
Saugkanülen	257-264
Saugkanülen, mikro	262, 264
Saugrohre	257-264
Schädel Instrumente	215-222
Schädelhalter	218
Schädelstanzen	222
Schädeltrephinen	221
Scharfelföbel	175-182
Schere, fein	31, 42, 45
Scheren	18-46
Scheren für Hypophysektomie	330
Scheren für Neurochirurgie	43-44
Scheren, mikro	48-58
Schieblehre speziell für Neurochirurgie	4
Schleimhauthäkchen	224
SCHLESINGER Laminektomiestanzen	279
SCHLESINGER Rongeurs	266
SCHMIEDEN-TAYLOR Schere	44
SCHNEIDER Raspatorium	201
SCHNEIDER-SAUERBRUCH Raspatorium	201
Schraubendreher für Distractionsschrauben	136
SCHUHKNECHT Saugrohr	264
SCOVILLE Blätter	146
SCOVILLE Sp a t e l	254
SCOVILLE Laminektomiespreizer	143-146
SCOVILLE Nervhäkchen und Dissektor	229
SCOVILLE Nervwurzelhaken	225
SCOVILLE Scharfelföbel	176
SCOVILLE-HAVERFIELD Laminektomiespreizer	144
SCOVILLE-RICHTER Laminektomiespreizer	147
SEBILAU Elevatorium	200
SEDILLOT Raspatorium	197
SELDIN Raspatorium	204
SEMB Hohlmeißelzangen	173
SEMKEN Pinzette	64-65
SEWALL Elevatorium	202
Siebbeinzangen	281
Silberklammern	217
SIMON Scharfelföbel	176
Skalpelle, feine	16

Skalpelligriffe	6-9
Skalpelligriffe, mikro	12-13
Skalpelligingen, mikro, steril	13
Skalpelligingen, steril	10-11
Skalpelligingen-Entferner	11
SMITH-PETERSEN Hohlmeißelzangen	173
SMITHWICK Clip-Anlegezange	216
SMITHWICK Nerven-Haken	229
Sonde und Dissektor	234
Spekula zur transspheoideale Hypophysektomie	318
Spiegel	328
Spinal-Elevatorien	191
Spinal-Fusions-Hohlmeißel	190
Spinal-Fusionsküretten	179, 182
Spinal-Haken	207
Spiralbohrer	208-209, 211
Spreizzange für Spekula	318
SPURLING Laminektomiezangen	268
ST. CLAIR-THOMPSON Raspatorium	232
STANDARD (YASARGIL) Aneurysmen-Clips	284-295
Stanzen	265-282
STEINBACH Hammer	193
STELLBRINK Hohlmeißelzangen	165
Sterilisierkassetten	339
STEVENS Tenotomie-Schere	35
STILLE Flachmeißel	185
STILLE Handbohrapparat	208
STILLE Hohlmeißel	185
STILLE Osteotom	185
STILLE RUSKIN Hohlmeißelzangen	171
LISTON-KEY-HORSLEY Knochensplitterzange	174
STILLE-LUER Hohlmeißelzangen	170-171
STILLE-SHERMANN Handbohrapparat	208
Stimmgabel	4
Stößel	184
Strabismusscheren	36
STRULLY Trigeminiusschere	43
SUNDAY Elevatorium	232
SWEET Clip-Anlegezange	216
SWEET Scheren für Hypophysektomie	330
Synovektomie zangen	165, 168
SYPERT Laminektomiestanzen	280
SYPERT Stößel	184

T

TAKAHASHI Siebbeinzangen	281
TAYLOR Blätter	146
TAYLOR Hammer	2
TAYLOR Pinzette	66
TAYLOR Spinal-Haken	207
TAYLOR-CUSHING Pinzette	64
Tenotomie-Schere	35
TERRIER Arterienklemmen	93
TOENNIS Dissektor	233
TOENNIS Häkchen	224
TOENNIS Messer	238
TOENNIS Nadelhalter	154
TOENNIS-ADSON Neurochirurgiescheren	43
TOLEDO Mikro-Gefäßschere	50
TOLEDO Mikro-Nadelhalter	159
TOLEDO Mikropinzetten	75
TOLEDO Mikro-Scheren	57
TRAUBE Hammer	2
Trays für Aneurysmen- & Mikro-Clips	315
Trephine	208-209
Trigeminiusspreizer	238
Trigeminiusschere	36, 44
TROEMNER Hammer	2
TROTTER Hohlmeißelzangen	168
TROUTMAN-CHRIS Klingenbrecher	14
Tumorfasspinzetten	83-85, 269
Tumorfäßzangen	269
Tumorgabeln	245, 248
Tumormesser	245

U

Uhrmacher Pinzette	68
ULTRA-LIGHT Atraumatische-Pinzetten	81
UNIVERSAL Draht-Scheren	45
UNIVERSAL Verband Schere	46

V

VALIN Laminektomiespreizer 145
 VANNAS Iridectomie Schere..... 48
 VANNAS Mikro-Scheren..... 49, 53-55
 Venenschere..... 54
 Verbandsscheren 46
 VERHOEVEN Mikro-Saugkanülen 264
 Verlängerungsstück 209
 Vertebroskop..... 336
 VISE Mikropinzetten..... 73
 VOLKMANN Doppelscharfelöffel 178
 VOLKMANN Scharfelöffel 175, 178-179
 Vorbohrer 218

W

WAGNER Bandscheiben-Rongeure 271
 WAGNER Hammer..... 192
 WAGNER Schere 45
 WALTER Hohlmeißel..... 183
 WALTON Laminektomiespreizer 124
 WANGENSTEEN Pinzette 67
 WARTENBERG Nadelrad 4
 WATSON-CHEYNE Dissektor 203
 WAUGH Pinzette..... 65
 WEBER Aesthesiometer 4
 WEIL-BLAKESLEY Nasenzangen..... 281
 WEITLANER Wundspreizer 110-113
 WHEELER (DEBAKEY)
 Atraumatische-Pinzetten..... 79
 WILLET-MARTEL Kopfschwanzzangen 98
 WILLIAMS Laminektomiespreizer 127
 WILLIGER Elevatorium 202
 WILLIGER Hammer..... 193-194
 WILLIGER Raspatorium 198
 WILLIGER Scharfelöffel 178
 Wirbelkörperdissektoren..... 199
 Wirbelkörperpreizer 128-133
 Wirbelsäulenmeißel, bajonettförmig 188
 Wundhaken 104-107
 Wundspreizer..... 108-116, 122, 141-142

Y

YANKAUER Saugrohr..... 258
 YASARGIL Aneurysmen-Clips 284-299
 YASARGIL Arachnoidea-Messer 242
 YASARGIL Clips für permanenten
 Verschluss 284-286, 290
 292, 294, 296-297
 YASARGIL Clips für temporären
 Verschluss 287-289, 291
 293, 295, 298-299
 YASARGIL Dissektor mit flexiblem Schaft..... 235
 YASARGIL Fadenführer..... 241
 YASARGIL Galeahaken 219
 YASARGIL Kürette 240
 YASARGIL Mikro-Nadelhalter 160
 YASARGIL Mikropinzetten 82-83
 YASARGIL Mikro-Präparierschere 52-53
 YASARGIL Mikro-Scheren 52-54
 YASARGIL Raspatorium 240, 243
 YASARGIL Rongeure 269
 YASARGIL Saug- und Spülkanüle 263
 YASARGIL Saugrohr..... 258
 YASARGIL Tumorfasspinzetten..... 83, 85
 YASARGIL Tumorgabeln..... 245
 YASARGIL-NICOLA Zangen für
 Hypophysektomie 330

Z

Zahnfleisch-Schere 44
 Zangen für Hypophysektomie..... 330
 ZAUFAL-JANSEN Hohlmeißelzangen..... 168
 ZIELKE Hohlmeißel..... 188
 ZOELLNER Mikro-Saugkanülen 262
 ZOELLNER Saugrohr 262
 Zwickzange 212

A		BROWN forceps 62	CUSHING decompression hook 105	
AACHEN spatulas..... 254	ACLAND applying forceps vessel clips..... 314	BRUNS bone curettes 175	CUSHING hook..... 224	
ACLAND approximators..... 313	ACLAND vessel clips..... 312	BUCK hammer 3	CUSHING flat trephine..... 209	
ADSON (DEBAKEY) atraumatic forceps..... 79	ADSON aneurysm needle 231	BUECHS periosteal elevator 198	CUSHING forceps 63	
ADSON retractor 228	ADSON elevator 200	Bulldog clamps 88-92	CUSHING hemostatic forceps 96	
ADSON forceps 61-62	ADSON forceps, for hypophysectomy..... 329	BULLDOG vessel clips 311	CUSHING laminectomy rongeur..... 268	
ADSON forceps, micro 61	ADSON retractor 113-115	Burrs 209	CUSHING-LANDOLT hypophysectomy specula 318	
ADSON rongeurs 166	ADSON suction tube..... 258	BUSHE bone curettes 180	CUSHING nerve hook 227	
ADSON-BABY hemostatic forceps..... 99	ADSON-BIEMER forceps..... 62	Buttoned probes 244, 250	CUSHING periosteal elevator..... 201-202	
Aesthesiometer 4	ALLIS tissue forceps 101	C		
ALM retractor 108	ANDERSON-ADSON retractor 113	CAIRNS spatulas..... 255	CAIRNS hook 224	
Aneurysm clip applying forceps..... 300-304	Aneurysm clips 284-299	CAIRNS hemostatic forceps 96	CAIRNS retractor..... 122	
Aneurysm needle..... 231	Applying and removing forceps for Bulldog clamps 91	Caliper special for neurosurgery 4	CAROTID bulldog clamps 88	
Applying forceps vessel clips..... 305-309, 314	Approximators..... 307-309, 313	CARREL hemostatic forceps 93	CASPAR blades 131, 133	
Arachnoid knife 242	Arteriectomy scissors 25	CASPAR bone curettes 179, 181	CASPAR bone curettes 179, 181	
Aspiration cannulas 257-264	Aspiration cannulas, micro 262, 264	CASPAR cervical retractor..... 128-133	CASPAR cervical vertebral body distraction system 134-136	
Atraumatic Bulldog Clamps..... 88-90, 92	Atraumatic forceps, micro 75-81, 86	CASPAR cervical vertebral body distraction system 134-136	CASPAR distraction screws 136	
AUSTIN micro forceps..... 73	B		CASPAR distractor..... 134-135	
BABINSKY hammer..... 2	BABY CRILE-WOOD needle holder 152	CASPAR exploration and coagulation hooks 228	CASPAR exploration and coagulation hooks 228	
Baby-MIXTER hemostatic forceps..... 101	BACON rongeurs 167	CASPAR ligature fork 248	CASPAR lumbal retractor 137-138	
BADGLEY laminectomy spreader 130	Bandage scissors 46	CASPAR micro dissector 246	CASPAR nerve root retractor 230	
BANE-HARTMANN rongeurs 166	BARON suction tube 264	CASPAR periosteal elevator 199	CASPAR rongeurs for intervertebral discs 271-273	
BARRAQUER micro needle holder 156	BARRAQUER-TROUTMAN micro needle holder 156	CASPAR saw driver 136	CASPAR scalp handle, micro 12	
BAUMGARTNER needle holder 151	BECK rongeurs 266	CASPAR specula..... 139	CASPAR screw driver 136	
BECKMANN laminectomy retractor 119	BECKMANN-ADSON laminectomy retractor..... 120	CASPAR tamper 184	CASPAR twist drill..... 136	
BECKMANN-ADSON retractor 116	BECKMANN-EATON laminectomy retractor 121	CASPAR vertebral body dissector 199	CASTROVIEJO blade breaker 15	
BELLUCI micro cannulas 262	BELLUCI suction tube 262	CASTROVIEJO iridectomy scissors 48	CASTROVIEJO micro needle holder 156-158, 160	
BERLINER hammer 3	BEYER mastoid rongeurs..... 282	Cerebellar retractors 112	Cervical retractor 128-133	
BEYER rongeurs 167	BEYER synovectomy rongeurs 168	Cervical vertebral body distraction system 134-136	Chisels 185	
BIEMER applying forceps for vessel clips 305, 307-309	BIEMER approximators 309	CITELLI mastoid rongeurs 282	CLEVELAND rongeurs 164	
BIEMER micro scissors 54	BIEMER vessel clips..... 305	Clip applying forceps 215-216	Clip Carrier 217	
BIEMER vessel dilator 244	BIEMER-MÜLLER approximators 307	CLOWARD blade retractor 104	CLOWARD laminectomy retractor..... 125	
Bipolar coagulation forceps 332-336	Blade breaker..... 14-15	CLOWARD laminectomy spreader 148	CLOWARD-HOEN hemilaminectomy retractor 140	
Blade retractor 104	Bloodletting scissors 25	COBB spinal elevators 191	COBB spinal fusion curettes 179	
BLUMENTHAL rongeurs 165	BOEHLER rongeurs 169	COBB spinal fusion gouges 190	COLCLOUGH laminectomy punches 278	
Bone Curettes 175-182	Bone cutting forceps..... 174	COLLIN dynamometre 2	COLLIN dynamometre 2	
Bone flap elevator 232	Bone Levers 206-207	CONE laminectomy retractor 123	CONE pituitary curettes 321	
Bone rongeurs 164-173	Bore hole protection forceps 221	CONE skull trephines..... 221	Containers 338-339	
Spatulas..... 254-256	BROPHY forceps..... 66	Containers for aneurysm & micro Clips 315	Containers, aluminium..... 338	
		Containers, aluminium..... 338	Containers, stainless steel 339	
		CONTOUR scalp retractor..... 127	COOLEY atraumatic forceps 78	
		COTTLE elevator..... 204	COTTLE forceps..... 70	
		COTTLE mallet..... 193	CRILE hemostatic forceps 95	
		CRILE nerve hook 227	CRILE-RANKIN hemostatic forceps 96	
		CRILE-WOOD needle holder 151	CRUTCHFIELD drill point..... 218	
		CRUTCHFIELD skull traction tongs 218	Curettes, micro 240, 250	
		Curettes, micro 240, 250	CUSHING spatulas 254	
		CUSHING spatulas 254	DAHLGREN skull punches..... 222	
		DANDY hemostatic forceps..... 97	DANDY nerve hook 226	
		DANDY trigeminal scissors 44	DARLING laminectomy retractor 123	
		DAUBENSPECK bone curettes 176	DAVIS dissector..... 234	
		De MARTEL wire saw guide 220	DEBAKEY arteriotomy scissors 25	
		DEBAKEY atraumatic forceps..... 75-81, 86	DEBAKEY bulldog clamps 90	
		DEBAKEY needle holder 152-153	DEBAKEY scissors 41	
		DEBAKEY-DIETHRICH atraumatic forceps 78	DEBAKEY-DIETHRICH bulldog clamps..... 89	
		DEBAKEY-GLOVER bulldog clamps 88	DECKER scissors, for hypophysectomy 330	
		Decompression hook..... 105	DEJERINE hammer 3	
		DEJERINE hammer 3	Delicate dissecting scissors 31	
		D'ERRICO burr 209	DeVILBISS skull punches 222	
		Diagnostics 1-4	DIEFFENBACH bulldog clamps..... 91	
		DIEFFENBACH delicate scalpels 16	DIETHRICH bulldog clamps 89	
		DIETHRICH scissors 40	DIMEDA blade breaker 14	
		DIMEDA retractor 109	Dissecting scissors..... 22-33	
		Dissecting-ligature forceps..... 100	Dissector with flexible shaft 235	
		Dissectors..... 200-204, 246	Dissectors, micro 246, 249, 322, 325, 327	
		Dissectors, micro 246, 249, 322, 325, 327	Distraction screws 136	
		Distraction screws 136	Distractor 134-135	
		Distractor 134-135	Drill 136	
		Drill 136	Drill guide 134-135	
		Drill guide 134-135	Drill point 218	
		Drill point 218	DUEHRSEN forceps..... 67	
		DUEHRSEN forceps..... 67	DUNHILL hemostatic forceps 96	
		DUNHILL hemostatic forceps 96	Dynamometre..... 2	
		Dynamometre..... 2	E	
		ECHLIN rongeurs..... 173	Elevators 200-204	
		Elevators 200-204	Elevators, micro..... 199, 249	
		Elevators, micro..... 199, 249	Enucleators..... 322-323	
		Enucleators..... 322-323	EPSTEIN bone curettes 180	
		EPSTEIN bone curettes 180	Ethmoid bone forceps 281	
		Ethmoid bone forceps 281	Exploration- and coagulation hooks 228	
		Exploration- and coagulation hooks 228	Extension piece 209	
		Extension piece 209	F	
		FAHLBUSCH pituitary curettes 325	FAHLBUSCH pituitary spoon 325	
		FAHLBUSCH pituitary spoon 325	FAHLBUSCH scissors, for hypophysectomy... 330	
		FAHLBUSCH scissors, for hypophysectomy... 330	FARABEUFG periosteal elevator 196	
		FARABEUFG periosteal elevator 196	FARABEUFG-COLLIN periosteal elevator 196	
		FARABEUFG-COLLIN periosteal elevator 196	FERGUSON suction tube 259	
		FERGUSON suction tube 259	FERRIS-SMITH-CUSHING rongeurs for intervertebral discs 270	
		FERRIS-SMITH-CUSHING rongeurs for intervertebral discs 270	FINSEN retractor 108	
		FINSEN retractor 108	FISCH hook..... 251	
		FISCH hook..... 251	FISCH micro hook..... 251	
		FISCH micro hook..... 251	FISCH suction und irrigation cannula 263	
		FISCH suction und irrigation cannula 263	FOMON rasps 206	
		FOMON rasps 206	Forceps, dressing 60-61	

Forceps, for hypophysectomy 329-330
Forceps, micro..... 72-86
Forceps, thumb & tissue 60-86
Forceps, tissue 60-67
Forceps, Tumor grasping 83-85, 269
FRAZIER hook 224
FRAZIER separator 234
FRAZIER suction tube 258-261
FRAZIER ventricle puncture cannula 261
FREER elevator 203
FREER mucosa hooklet..... 224
FRIEDMAN rongeurs 164
FRIEDMAN-MINI rongeurs 164
Forceps, hemostatic..... 93-101
FRYKHOLM rongeurs 172

G

Galea hooks 219
GELPI perineal retractor..... 107
GEMINI dissecting-ligature forceps 100
GEMINI-MINI dissecting-ligature forceps 100
GERALD (DEBAKEY) atraumatic forceps 79
GERALD forceps 67
GIERTZ STILLE rib shear 213
GIGLI wire saw handle 220
GIGLI wire saws 220
GILLIES forceps 65
GLASSMAN atraumatic forceps 79
GLOVER bulldog clamps 88
GOLDMAN-FOX gum scissors..... 44
GOMEL micro forceps..... 74
GOMEL micro scissors 49
GORNEY scissors 25
Gouge for taking grafts from the ribs 183
Gouges 183, 188-190
Gouges for scoliosis operations..... 188
GRAEFE iris forceps 69
GRAHAM nerve hook 227
GRONINGEN nerve hook..... 228
GRUENWALD forceps 64
GRUENWALD forceps 70
Guide for GIGLI saw..... 220
GULEKE rongeurs 167
Gum scissors..... 44

H

HAJEK mallet 192
HAJEK sphenoid bone punches 282
HAJEK-KOFLER sphenoid bone punches 282
HALLE bone curettes 177
HALLE knife 238
HALLE elevator 232
HALSEY needle holder 151
HALSTED-MOSQUITO hemostatic forceps 94
Hammers 2-3
Hand Drills..... 208-210
Handle with Jacobs chuck 210
HARDY enucleators..... 322
HARDY forceps, for hypophysectomy 329
HARDY hypophysectomy specula 318
HARDY laminectomy punches 280
HARDY micro dissector 327
HARDY micro mirror 328
HARDY pituitary curettes..... 320, 326-327
HARDY pituitary spoon 328
HARDY-FAHLBUSCH micro dissector..... 322
HARTMANN hemostatic forceps..... 93
HARVEY-JACKSON laminectomy retractor 121
HEIFETZ spatulas 255
HEIFETZ tumor grasping forceps..... 85
Hemilaminectomy retractors 117-118
Hemostatic Forceps 93-101
HENLY retractor..... 110
HESS (DEBAKEY) bulldog clamps 91
HESS (LOVE modif.) nerve root retractor 230
HIBBS blades 146
HOEN separator..... 234
HOEN hemilaminectomy retractor 140
HOEN nerve hook..... 227
HOEN periosteal elevator..... 198
HOEN scalp flap forceps 98
Hooks, micro..... 248-251
HORSLEY dissector..... 235

HOSOBUCHI pituitary spoon..... 324
HOUSE suction adapter 264
HOUSE suction and irrigation cannula 264
HOWARTH elevator..... 203
HUDSON hand drill 209
HUNT tumor grasping forceps 84-85
Hypophysectomy instruments 317-330

I

Implant fork..... 322
INGE laminectomy spreader 148
Iridectomy scissors 48
Iris forceps 69
IRIS scissors 34

J

JACOBS chuck 210
JACOBSON buttoned probes..... 244
JACOBSON forceps 63
JACOBSON hemostatic forceps 99
JACOBSON ligature fork..... 248
JACOBSON micro needle holder 158, 161
JACOBSON micro scissors 55
JACOBSON vessel knife 248, 251
JAMESON dissecting scissors 42
JAMESON-WERBER dissecting scissors 42
JANNETTA retractor 142
JANSEN forceps..... 70
JANSEN periosteal elevator 198
JANSEN retractor 109
JANSEN rongeurs..... 167
JANSEN-GIFFORD retractor 109
JANSEN-WAGNER retractor 109
JEFFERSON forceps 63
JEFFERSON retractor..... 122
JOHNS HOPKINS bulldog clamps..... 91
JOSEPH mucosa hooklet 224
JOSEPH periosteal elevator..... 198
JOSEPH scissors 31
JULIAN needle holder 154

K

KELLY hemostatic forceps 95
KELLY-RANKIN hemostatic forceps..... 95
KERRISON laminectomy punches 274-277
KERRISON mastoid rongeurs 282
KEY elevator 201
Key only..... 132, 309
KILNER scissors 32
KIRSCHNER wire..... 211
KNIGHTON laminectomy retractor 124
Knot tier and ligature pusher 248
KOCHER-LANGENBECK retractor..... 106
KOENIG bone lever..... 207
Köln clips..... 217
KOOS vessel knife..... 242
KRÄMER periosteal elevator..... 196
KRAYENBÜHL nerve and vessel hooks 241

L

LAHEY hook 224
LAMBOTTE osteotome 186
LAMBOTTE periosteal elevator 196
Lamina chisel 318
Lamina gouge, cranked..... 188
Lamina spreaders..... 128-133
Laminectomy punches..... 274-280
Laminectomy retractors 117-126, 140, 148
Laminectomy rongeurs 265-282
Lancet knives for tumor tissue 245
LANDOLT enucleators..... 323
LANDOLT forceps, for hypophysectomy..... 329
LANDOLT periosteal elevator 199
LANDOLT pituitary curettes 324
LANDOLT scalp handle, micro 12-13
LANDOLT spreading forceps for specula 318
LANDOLT suction raspatory 263
LANDOLT tumor grasping forceps..... 269
LANDOLT-REULEN micro dissector 325
LANDOLT-REULEN micro hook..... 325
LANDOLT-REULEN pituitary curettes 325
LANDOLT-REULEN raspatory 325
LANE bone lever 206
LANE retractor 104
LANGE periosteal elevator..... 232
LANGENBECK elevator..... 200

LANGENBECK needle holder..... 154
LANGENBECK periosteal elevator..... 197, 200
LAZAR forceps 73
LEBSCHÉ wire saw guide 220
LEKSELL (STILLE) rongeurs..... 172
LEKSELL rongeurs 172
LEMPERT bone curettes 177
LEMPERT periosteal elevator..... 232
LEMPERT rongeurs 167
LEMPERT suction tube 259
LERICHE hemostatic forceps 99
LEXER gouge 189
LEXER osteotome 187-188
LEXER scissors 24
LEXER-mini osteotome 189
Ligature forceps 82
Ligature fork..... 248
Ligature guides and carriers..... 241
LISTER bandage scissors 46
LITTLE-JOKER (CUSHING) periosteal elevator 201
LITTLER suture carrying scissors..... 25
LOGAN retractor 108
LOVE nerve root retractor 230-231
LOVE-GRUENWALD laminectomy rongeur 268
LOVELACE hemostatic forceps..... 97
LUCAE forceps 70
LUER rongeurs 165-166
LUER suction tube 260
Lumbar retractors..... 137-139

M

MAGILL suction tube 258
MALIS retractor 141
Mallets..... 2-3, 192-195
Mallets, plastic 193-195
MARKHAM-MEYERDING laminectomy retractor 126
MARQUARDT rongeurs 169
MARTEL scalp flap forceps..... 98
MARTIN spatulas..... 256
MARTINI bone curettes..... 178
Mastoid rongeurs 282
MATHIEU needle holder 154
MAYFIELD rongeurs..... 168
MAYO (HARRINGTON) scissors..... 22
MAYO scissors 22
MAYO-HEGAR needle holder..... 152
MAYO-STILLE scissors 23
McDONALD elevator 203
McINDOE bone cutting forceps..... 174
McINDOE forceps 64
McKENY elevator..... 202
McKENZIE burr 209
McKENZIE clip applying forceps 216
McKISSOCK periosteal elevator 196
MEAD mallet 195
MEAD rongeurs..... 164
MEHDORN applying forceps vessel clips 306
MEHDORN vessel clips 306
MEMORY aneurysm clip applying forceps 300-301
METZENBAUM dissecting scissors 26
METZENBAUM-BABY dissecting scissors 26
METZENBAUM-FINO dissecting scissors 27-30
MEYERDING blades 146
MEYERDING laminectomy retractor 126
MEYERDING retractor 107
Micro atraumatic forceps 75-81, 86
Micro bulldog clamps 92
Micro dissecting scissors..... 49, 52-53
Micro elevators 199, 249
Micro forceps 72-86
Micro forceps, light-weight 72, 74
Micro forceps, Titanium 86
Micro needle holders..... 155-162
Micro needle holders, lightweight..... 161
Micro needle holders, titanium 162
Micro scissors..... 48-58
Micro scissors, light-weight..... 56-57
Micro scissors, SuperCut 56
MILLES micro scissors 54
MILLIGAN dissector 233-234

MILLS scissors.....	37
MINI (YASARGIL) aneurysm clips	296-295
Mirror.....	328
MISKIMON retractor.....	113
MIXTER-BABY hemostatic forceps	101
MOLLISON retractor	122
MOLT periosteal elevator	204
MOYNIHAN hemostatic forceps.....	97
Mucosa hooklets.....	224
MÜLLER approximators.....	308
MÜLLER vessel clips	310

N

NAGEL micro scissors	51
Nasal cutting forceps	281
Needle.....	250
Needle holders.....	150-162
Needle holders, micro	155-162
NEIVERT needle holder.....	151
Nerve and vessel hooks	241
Nerve hooks.....	226-229, 233-235
Nerve hooks and dissectors	229
Nerve root retractors	225-231
Never dissecting scissors	42
NICOLA forceps, for hypophysectomy	330
NICOLA pituitary curettes	320-321
NICOLA raspatory.....	321
NICOLA scissors, for hypophysectomy	330
NIEDERDELLMANN osteotome	187
NORFOLK and NORWICH laminectomy retractor	123
NORTHFIELD rongeurs	168

O

O'CONNELL nerve root retractor	225
OBWEGESER osteotome	187
OKONEK-YASARGIL tumor forks	248
OLDBERG retractor	105
OLDBERG rongeurs.....	269
OLIVECRONA spatulas.....	254
OLIVECRONA rongeurs	166
OLIVECRONA trigeminal knife	238
OLIVECRONA trigeminal scissors	36
OLIVECRONA wire saws.....	220
OLIVECRONA-TOENNIS clip applying forceps	216
Operating scissors	18-21
Operating scissors, delicate	21
Osteotomes	183-189

P

PAPAVERO lamina chisel	318
PAPAVERO-CASPAR hypophysectomy specula	318
PARKER delicate scalpels	16
PARTSCH periosteal elevator.....	232
PENFIELD dissector	236-237
PENNYBACKER rongeurs	266
PENNYBAKER probe dissector	234
PENNYBAKER rongeurs.....	168
Perineal retractor	107
Periosteal elevators	196-204, 232
Pinwheel.....	4
Pituitary curettes.....	319-321, 325-327
Pituitary instruments.....	317-330
Pituitary spoon.....	324-325, 328
PLESTER suction tube	260
POTTS-DE MARTEL scissors	37
POTTS-SMITH forceps.....	60
POTTS-SMITH scissors.....	37-39
POTTS-YASARGIL micro scissors	54
Probe dissector.....	234
Probes, buttoned	244, 250
PROVIDENCE-HOSPITAL hemostatic forceps	96
Puncture cannulas for ventricle	261

Q

QUERVAIN elevator	200
-------------------------	-----

R

RABINER hammer	3
RAGNELL scissors	31
RAGNELL-DAVIS retractor	104
RAIMONDI scalp flap forceps.....	98

RALK hand drill	210
RANEY clip applying forceps	217
RANEY Scalp hemostasis clip.....	217
Raspatories, micro.....	240, 243, 321, 325
Rasps	206
RAY pituitary curettes	319
Razor blades.....	14
REILL wire cutting forceps.....	212
Retractors.....	104-107
Retractors, self-retaining	108-116, 122, 141-142
REYNOLDS scissors	33
RHOTON buttoned probe.....	250
RHOTON micro curette	250
RHOTON micro dissector	249
RHOTON micro elevator	250
RHOTON micro hook	250
RHOTON needle.....	250
Rib Shears	213
RIBBON spatulas	256
Ring forceps.....	75, 86
Rongeurs.....	164-173
Rongeurs for intervertebral discs	270-273
Rongeurs, heavy duty.....	271
Ruler, metal.....	4
RUSKIN rongeurs.....	169
RUSKIN-LISTON bone cutting forceps.....	174
RYDER (VASCULAR) needle holder.....	153
RYDER needle holder	153

S

SACHS dissector.....	233, 235
SACHS tumor hook.....	227
SAMII nerve grasping forceps.....	83
SAMII tumor knives	245
SANVENERO scissors	31
SATINSKY bulldog clamps	88
SAUERBRUCH rib shear	213
SAUERBRUCH rongeurs.....	171
Scalp flap forceps.....	98
Scalp hemostasis clip	217
Scalp retractor.....	127
Scalpel Blade Remover.....	11
Scalpel blades, micro, sterile	13
Scalpel blades, sterile	10-11
Scalpel handles	6-9
Scalpel handles, micro	12-13
Scalpels, delicate.....	16
SCHLESINGER laminectomy punches.....	279
SCHLESINGER rongeurs	266
SCHMIEDEN-TAYLOR scissors	44
SCHNEIDER periosteal elevator.....	201
SCHNEIDER SAUERBRUCH periosteal elevator.....	201
SCHUHKNECHT suction tube.....	264
Scissors.....	18-46
Scissors, delicate	31, 42, 45
Scissors, for hypophysectomy.....	330
Scissors, micro.....	48-58
Scissors, micro dissecting.....	49, 52-53
Scissors, micro vascular.....	50, 58
Scissors, neurosurgical.....	43-44
Scissors, vascular.....	37-41
SCOVILLE blades	146
SCOVILLE bone curettes	176
SCOVILLE spatulas	254
SCOVILLE laminectomy retractor	143-146
SCOVILLE nerve hook and dissector	229
SCOVILLE nerve root retractor	225
SCOVILLE-HAVERFIELD laminectomy retractor	144
SCOVILLE-RICHTER laminectomy retractor	147
Screw driver for distraction screws	136
Screws, distraction.....	136
SEBILAU elevator	200
SEDILLOT periosteal elevator.....	197
SELDIN periosteal elevator	204
SEMB rongeurs.....	173
SEMKEN forceps	64-65
SEWALL elevator	202
Sheath and tube, for endoscope.....	336
Silver clips.....	217
SIMON bone curettes	176
Skin hooks	224
Skull instruments	215-222

Skull punches	222
Skull traction tongs.....	218
Skull trephines.....	221
SMITH-PETERSEN rongeurs	173
SMITHWICK clip applying forceps	216
SMITHWICK nerve hook	229
Specula for lumbar vertebral operations	139
Specula for trans-sphenoidal hypophysectomy	318
Sphenoid bone punches	282
Spherical Burr.....	208-209
Spinal elevators.....	191
Spinal fusion curettes	179, 182
Spinal fusion gouges.....	190
Spinal retractors	207
Spreading forceps for specula.....	318
SPURLING laminectomy rongeur.....	268
ST. CLAIR-THOMPSON periosteal elevator	232
STANDARD (YASARGIL) aneurysm clips.....	284-295
STEINBACH mallet	193
STELLBRINK rongeurs	165
Sterilization cases	339
STEVENS tenotomy scissors	35
STILLE chisels	185
STILLE gouge	185
STILLE hand drill	208
STILLE osteotome.....	185
STILLE RUSKIN rongeurs	171
LISTON-KEY-HORSLEY bone cutting forceps ..	174
STILLE-LUER rongeurs	170-171
STILLE-SHERMANN hand drill	208
Strabismus Scissors	36
STRULLY trigeminal scissors	43
Suction adapter	264
Suction raspatory	263
Suction tubes	257-264
Suction and irrigation cannula	263-264
SUNDAY elevator	232
Suture carrying scissors	25
Suture Tying Forceps, micro	72-75, 86
SWEET clip applying forceps	216
SWEET scissors, for hypophysectomy.....	330
Synovectomy rongeurs	165, 168
SYPERT laminectomy punches.....	280
SYPERT tampers.....	184

T

TAKAHASHI ethmoid bone forceps	281
Tampers.....	184
TAYLOR blades	146
TAYLOR forceps	66
TAYLOR hammer.....	2
TAYLOR spinal retractor	207
TAYLOR-CUSHING forceps	64
Tenotomy scissors	35
TERRIER hemostatic forceps	93
Tissue claws	251
TOENNIS dissector	233
TOENNIS hook.....	224
TOENNIS knife.....	238
TOENNIS needle holder.....	154
TOENNIS-ADSON neurosurgical scissors	43
TOLEDO micro forceps.....	75
TOLEDO micro needle holder.....	159
TOLEDO micro scissors	57
TOLEDO micro-vascular scissors	50
TRAUBE hammer	2
Trays for aneurysm & micro Clips	315
Trephine.....	208-209
Trigeminal knife	238
Trigeminal scissors	36, 44
TROEMNER hammer.....	2
TROTTER rongeurs	168
TROUTMAN-CHRIS blade breaker.....	14
Tumor forks	245, 248
Tumor grasping forceps	83-85, 269
Tumor knives	245
Tuning fork.....	4
Twist Drill	208-209, 211

U

ULTRA-LIGHT atraumatic forceps 81
 UNIVERSAL bandage scissors 46
 UNIVERSAL wire cutting scissors..... 45

V

VALIN laminectomy retractor 145
 VANNAS iridectomy scissors 48
 VANNAS micro scissors 49, 53-55
 Vein scissors..... 54
 Ventricle of puncture cannulas..... 261
 VERHOEVEN micro cannulas..... 264
 Vertebral body dissectors..... 199
 Vertebroscopy 336
 Vessel clips..... 283-315
 Vessel dilator..... 244
 Vessel knife 242, 248
 VISE micro forceps..... 73
 VOLKMANN bone curettes 175, 178-179
 VOLKMANN double curettes 178

W

WAGNER mallet 192
 WAGNER rongeurs for intervertebral discs 271
 WAGNER scissors 45
 WALTER gouge..... 183
 WALTON laminectomy retractor 124
 WANGENSTEEN forceps 67
 WARTENBERG pinwheel 4
 Watchmaker's forceps..... 68
 WATSON-CHEYNE dissector 203
 WAUGH forceps 65
 WEBER aesthesiometer..... 4
 WEIL-BLAKESLEY casual cutting forceps 281
 WEITLANER retractor 110-113
 WHEELER (DEBAKEY) atraumatic forceps 79
 WILLET-MARTEL scalp flap forceps 98
 WILLIAMS laminectomy retractor 127
 WILLIGER bone curettes..... 178
 WILLIGER elevator 202
 WILLIGER mallet 193-194
 WILLIGER periosteal elevator 198
 Wire cutting forceps 212
 Wire cutting scissors 45
 Wire saw guide 220
 Wire saw handle..... 220
 Wire saws 220

Y

YANKAUER suction tube..... 258
 YASARGIL aneurysm clips 284-299
 YASARGIL arachnoid knife 242
 YASARGIL clips for permanent closure 284-286, 290, 292, 294, 296-297
 YASARGIL clips for temporary closure 287-289, 291, 293, 295, 298-299
 YASARGIL curette 240
 YASARGIL dissector with flexible shaft..... 235
 YASARGIL galea hooks 219
 YASARGIL ligature guides and carriers..... 241
 YASARGIL micro dissecting scissors..... 52-53
 YASARGIL micro forceps 82-83
 YASARGIL micro needle holder 160
 YASARGIL micro scissors..... 52-54
 YASARGIL raspatory 240, 243
 YASARGIL rongeurs 269
 YASARGIL suction tube 258
 YASARGIL suction und irrigation cannula..... 263
 YASARGIL tumor forks 245
 YASARGIL tumor grasping forceps 83, 85
 YASARGIL-NICOLA forceps,
 for hypophysectomy 330

Z

ZAUFAL-JANSEN rongeurs..... 168
 ZIELKE gouge..... 188
 ZOELLNER micro cannulas 262
 ZOELLNER suction tube 262

A		C	
AACHEN spatules.....	254	CAIRNS crochet à dure-mère	224
ACLAND approximateurs	313	CAIRNS écarteur	122
ACLAND clips vasculaires	312	CAIRNS pinces hémostatiques.....	96
ACLAND pinces à appliquer		CAIRNS spatules.....	255
les clips vasculaires	314	Canules à aspiration et à irrigation.....	263-264
Adaptateur d'aspiration	264	Canules d'aspiration	257-264
ADSON (DEBAKEY) atrauma pince	79	Canules d'aspiration, micro	262, 264
ADSON aiguille d'anévrisme.....	231	Canules pour la ponction des ventricules	261
ADSON écarteur	113-115	CAROTID clamps bulldog	88
ADSON élévateur.....	200	CARREL pinces hémostatiques	93
ADSON pince	61-62	CASPAR crochets pour exploration	
ADSON pince, micro.....	61	et coagulations	228
ADSON pinces pour l'hypophysectomie.....	329	CASPAR curettes tranchantes.....	179, 181
ADSON pinces-gouges	166	CASPAR dissecteur corps vertébral	199
ADSON retracteur à dure-mère	228	CASPAR distracteur	134-135
ADSON tube d'aspiration	258	CASPAR distraction vis	136
ADSON-BABY pinces hémostatiques	99	CASPAR du col de l'utérus corps	
ADSON-BIEMER pince	62	vertébral système de distraction	134-136
Agrafes en argent pur	217	CASPAR écarteur de tissu cervical	128-133
Agrafes hémostatique pour cuir chevelu	217	CASPAR Écarteurs autostatiques	
Aiguille.....	250	lomaires	137-138
Aiguille d'anévrisme	231	CASPAR fourche pour fil à suturer	248
Alésoir	218	CASPAR guide-m è c h e	134-135
ALLIS pinces hémostatiques	101	CASPAR lames	131, 133
ALM écarteur	108	CASPAR manche de bistouris, micro	12
ANDERSON-ADSON écarteur	113	CASPAR meche	136
Anneau pince	75, 86	CASPAR micro dissecteur.....	246
Approximateurs	307-309, 313	CASPAR pilons métalliques	184
Arthrodèse curettes	179, 182	CASPAR retracteur pour radici die nervi.....	230
Arthrodèse élévateurs.....	191	CASPAR rongeurs	
Arthrodèse gouges.....	190	pour disques intervertébraux.....	271-273
Aspirateur pour préparation.....	263	CASPAR rugines-raspatoire	199
Atrauma Clamps Bulldog	88-90, 92	CASPAR spéculums	139
Atrauma pince, micro.....	75-81, 86	CASPAR tournevis	136
AUSTIN micro pince	73	Casse-lames	14-15
B		CASTROVIEJO casse-lames.....	15
BABINSKY marteau	2	CASTROVIEJO ciseaux iridectomie	48
BABY CRILE-WOOD porte-aiguilles.....	152	CASTROVIEJO porte-aiguilles,	
Baby-MIXTER pinces hémostatiques.....	101	micro	156-158, 160
BACON pinces-gouges	167	Ciseau burin pour les lames	
BADGLEY écarteurs pour laminectomie	130	de l'arc vertébral	318
BANE-HARTMANN pinces-gouges.....	166	Ciseaux	18-46
BARON tube d'aspiration	264	Ciseaux à bandages.....	46
BARRAQUER porte-aiguilles, micro	156	Ciseaux à chirurgie.....	18-21
BARRAQUER-TROUTMAN		Ciseaux à chirurgie, fins.....	21
porte-aiguilles, micro	156	Ciseaux à dissection	22-33
BAUMGARTNER porte-aiguilles	151	Ciseaux à dissection, micro	49, 52-53
BECK rongeur	266	Ciseaux a gencives.....	44
BECKMANN écarteur pour laminectomie	119	Ciseaux a préparation de nerfs.....	42
BECKMANN-ADSON écarteur.....	116	Ciseaux à strabisme.....	36
BECKMANN-ADSON écarteur		Ciseaux coupe-fil	45
pour laminectomie.....	120	Ciseaux de saignée	25
BECKMANN-EATON écarteur		Ciseaux délicats à préparation.....	31
pour laminectomie.....	121	Ciseaux guide-fil.....	25
BELLUCI micro canules d'aspiration	262	Ciseaux iridectomie	48
BELLUCI tube d'aspiration.....	262	Ciseaux neurochirurgicaux.....	43-44
BERLINER marteau	3	Ciseaux pour dure-mère.....	44
BEYER pinces emporte-pièce pour os	282	Ciseaux pour l'hypophysectomie	330
BEYER pinces-gouges	167	Ciseaux pour le nerf trigeminal	36, 44
BEYER synovectomie pinces-gouges	168	Ciseaux pour veines.....	54
BIEMER approximateurs	309	Ciseaux tenotonomie.....	35
BIEMER clips vasculaires.....	305	Ciseaux vasculaires.....	37-41
BIEMER dilateurs vasculaires	244	Ciseaux vasculaires, micro	50, 58
BIEMER micro ciseaux	54	Ciseaux, fin	31, 42, 45
BIEMER pinces à appliquer		Ciseaux, micro	48-58
les clips vasculaires	305, 307-309	Ciseaux-burins.....	185
BIEMER-MÜLLER approximateurs	307	CITELLI pinces emporte-pièce pour os	282
Bistouris délicats	16	Clamps bulldog	88-92
BLUMENTHAL pinces-gouges	165	Clamps bulldog, micro	92
BOEHLER pinces-gouges.....	169	Clé seule	132, 309
BROPHY pince	66	CLEVELAND pinces-gouges.....	164
BROWN pince.....	62	Clips d'anévrisme.....	284-299
BRUNS curettes tranchantes	175	Clips vasculaires	283-315
BUCK marteau	3	CLOWARD écarteur pour laminectomie.....	125
BUECHS rugines-raspatoire.....	198	CLOWARD écarteur pour laminectomie.....	148
BULLDOG clips vasculaires	311	CLOWARD lame écarteur	104
BUSHE curettes tranchantes	180	CLOWARD-HOEN écarteur	
		pour hemilaminectomie.....	140
		COBB arthrodèse curettes.....	179
		COBB arthrodèse élévateurs	191
		COBB arthrodèse gouges	190
		COLCLOUGH pinces emporte-pièce	
		pour laminectomie.....	278
		COLLIN dynamometre	2
		Cologne agrafe.....	217
		Conducteur pour scies à fil	220
		CONE Curettes à hypophyse	321
		CONE écarteur pour laminectomie	123
		CONE tréphines crâniennes.....	221
		Container.....	338-339
		Container, aluminium	338
		Container, acier inoxydable.....	339
		CONTOUR écarteur pour le cuir chevelu.....	127
		COOLEY atrauma pince	78
		Costotomes	213
		COTTLE élévateur	204
		COTTLE marteau	193
		COTTLE pince	70
		Couteau pour dure-mère.....	238
		Couteau pour trijumeau.....	238
		Couteau pour vaisseau	242, 248
		Couteaux à tumeurs	245
		Couteaux arachnoïdiens.....	242
		Couteaux lancéolaires pour tissu de tumeur ..	245
		CRILE écarteur a nerfs	227
		CRILE pinces hémostatiques	95
		CRILE-RANKIN pinces hémostatiques.....	96
		CRILE-WOOD porte-aiguilles.....	151
		Crochets à dure-mère.....	224, 228, 251
		Crochets à gales	219
		Crochets à nerfs et à vasculaires.....	241
		Crochets à nerfs et dissecteurs	229
		Crochets dermatologiques	224
		Crochets pour exploration et coagulations	228
		Crochets pour la muqueuse.....	224
		Crochets, micro	248-251
		CRUTCHFIELD alésoir.....	218
		CRUTCHFIELD pinces de traction crânienne ..	218
		Curettes à hypophyse.....	319-321, 325-327
		Curettes à hypophyse	324-325, 328
		Curettes tranchantes	175-182
		Curettes, micro	240, 249
		CUSHING crochet à dure-mère	224
		CUSHING écarteur a nerfs	227
		CUSHING écarteur décompresseur.....	105
		CUSHING fraise plate.....	209
		CUSHING pince	63
		CUSHING pince pour laminectomie	268
		CUSHING pinces hémostatiques	96
		CUSHING rongeur	267
		CUSHING rugines-raspatoire.....	201-202
		CUSHING spatules	254
		CUSHING-LANDOLT hypophysectomie-	
		spéculums	318
		CUSHING-TAYLOR pince	64
D			
DAHLGREN pinces		emporte-pièce crâniennes.....	222
DANDY ciseaux pour le nerf trigeminal.....	44	DANDY écarteur a nerfs.....	226
DANDY écarteur a nerfs.....	97	DANDY pinces hémostatiques	97
DARLING écarteur pour laminectomie	123	DARLING écarteur pour laminectomie	123
DAUBENSPECK curettes tranchantes	176	DAVIS dissecteur à dure-mère.....	234
DAVIS dissecteur à dure-mère.....	234	De MARTEL conducteur pour scies à fil.....	220
DEBAKEY atrauma pince	75-81, 86	DEBAKEY ciseaux	41
DEBAKEY ciseaux	41	DEBAKEY ciseaux de saignée	25
DEBAKEY ciseaux de saignée	25	DEBAKEY clamps bulldog	90
DEBAKEY clamps bulldog	90	DEBAKEY porte-aiguilles	152-153
DEBAKEY porte-aiguilles	152-153	DEBAKEY-DIETRICH atrauma pince	78
DEBAKEY-DIETRICH atrauma pince	78	DEBAKEY-DIETRICH clamps bulldog.....	89
DEBAKEY-DIETRICH clamps bulldog.....	89	DEBAKEY-GLOVER clamps bulldog	88
DEBAKEY-GLOVER clamps bulldog	88	DECKER ciseaux pour l'hypophysectomie	330
DECKER ciseaux pour l'hypophysectomie	330	DEJERINE marteau	3
DEJERINE marteau	3	D'ERRICO fraise	209
D'ERRICO fraise	209	DeVILBISS pinces	
DeVILBISS pinces		emporte-pièce crâniennes.....	222
Diagnostic.....	1-4	Diapason.....	4
Diapason.....	4	DIEFFENBACH bistouris délicats.....	16
DIEFFENBACH bistouris délicats.....	16	DIEFFENBACH clamps bulldog.....	91
DIEFFENBACH clamps bulldog.....	91	DIETRICH ciseaux.....	40
DIETRICH ciseaux.....	40	DIETRICH clamps bulldog	89
DIETRICH clamps bulldog	89	Dilateurs vasculaires	244
Dilateurs vasculaires	244	DIMEDA casse-lames.....	14
DIMEDA casse-lames.....	14	DIMEDA écarteur.....	109

Dissecteur à arbre flexible	235
Dissecteurs	200-204, 246
Dissecteurs à dure-mère.....	233
Dissecteurs corps vertébral.....	199
Dissecteurs, mikro.....	246, 249, 322, 325, 327
Distracteur.....	134-135
Distraction vis.....	136
Du col de l'utérus corps vertébral système de distraction	134-136
DUEHRSEN pince	67
DUNHILL pinces hémostatiques.....	96
Dynamometre.....	2

E

Écarteur autostatique pour le cuir chevelu.....	127
Écarteur de tissu cervical	128-133
Écarteur décompresseur	105
Écarteur perineal	107
Écarteur pour corps vertébraux.....	128-133
Écarteurs pour opérations cérébelleuses	112
Écarteurs.....	104-107
Écarteurs a nerfs	226-229, 233-235
Écarteurs autostatiques	108-116, 122, 141-142
Écarteurs autostatiques lomaires	137-139
Écarteurs pour hemilaminectomie.....	117-118
Écarteurs pour laminectomie	117-126, 140, 148
Écarteurs pour le spinale	207
ECHLIN pinces-gouges	173
Élévateurs	200-204
Élévateurs, micro	199, 249
Enlève-lame.....	11
Enucléateurs	322-323
EPSTEIN curettes tranchantes	180
Estésiomètre	4

F

FAHLBUSCH ciseaux pour l'hypophysectomie	330
FAHLBUSCH Curettes à hypophyse	325
FAHLBUSCH Curettes à hypophyse	325
FARABEUF rugines-raspatoire	196
FARABEUF-COLLIN rugines-raspatoire	196
FERGUSON tube d'aspiration	259
FERRIS-SMITH-CHUSHING rongeurs pour disques intervertébraux	270
Scies à fil	220
FINSEN écarteur	108
FISCH canules à aspiration et à irrigation	263
FISCH crochet à dure-mère	251
FISCH micro crochet	251
FOMON râpes.....	206
Fourche pour fil à suturer.....	248
Fourches à tumeurs	245, 248
Fourchette pour implants.....	322
Fraise	209
Fraise sphérique	208-209
FRAZIER canules pour la ponction des ventricules	261
FRAZIER crochet à dure-mère	224
FRAZIER séparateur per dure-mère.....	234
FRAZIER tube d'aspiration.....	258-261
FREER crochet pour la muqueuse	224
FREER élévateur	203
FRIEDMAN pinces-gouges	164
FRIEDMAN-MINI pinces-gouges	164
FRYKHOLM pinces-gouges.....	172

G

GELPI écarteur perineal	107
GEMINI pinces à dissection et à ligatures	100
GEMINI-MINI pinces à dissection et à ligatures	100
GERALD (DEBAKEY) atrauma pince	79
GERALD pince.....	67
GIERTZ STILLE Costotome.....	213
GIGLI Scies à fil	220
GIGLI manche à crochet.....	220
GILLIES pince	65
GLASSMAN atrauma pince	79
GLOVER clamps bulldog	88
GOLDMAN-FOX ciseaux a gencives.....	44
GOMEL micro ciseaux	49
GOMEL micro pince	74
GORNEY ciseaux	25
Gouge pour la colonne vertébrale	188

Gouge pour la prise de greffons les côtes	183
Gouge pour les opérations de scoliose	188
Gouges	183, 188-190
GRAEFE pince à iris.....	69
GRAHAM écarteur a nerfs.....	227
Griffes tissulaires	251
GRONINGEN écarteur a nerfs	228
GRUENWALD pince	64
GRUENWALD pince	70
Guide-mèche	134-135
GULEKE pinces-gouges.....	167

H

HAJEK marteau	192
HAJEK pinces emporte-pièces pour sinus sphénoïdal.....	282
HAJEK-KOFER pinces emporte-pièces pour sinus sphénoïdal.....	282
HALLE couteau pour dure-mère.....	238
HALLE curettes tranchantes.....	177
HALLE élévateur.....	232
HALSEY porte-aiguilles	151
HALSTED-MOSQUITO pinces hémostatiques.....	94
HARDY Curettes à hypophyse	320, 326-328
HARDY enucléateurs	322
HARDY hypophysectomie-spéculums	318
HARDY micro dissecteur	327
HARDY micro miroir.....	328
HARDY pinces emporte-pièce pour laminectomie.....	280
HARDY pinces pour l'hypophysectomie	329
HARDY-FAHLBUSCH micro dissecteur	322
HARTMANN pinces hémostatiques.....	93
HARVEY-JACKSON écarteur pour laminectomie.....	121
HEIFETZ pinces pour saisir des tumeurs	85
HEIFETZ spatules.....	255
HENLY écarteur.....	110
HESS (DEBAKEY) clamps bulldog	91
HESS (LOVE modif.) retracteur pour radici die nervi	230
HIBBS lames	146
HOEN écarteur a nerfs	227
HOEN écarteur pour hemilaminectomie	140
HOEN pinces pour le cuir chevelu.....	98
HOEN rugines-raspatoire	198
HOEN séparateur per dure-mère	234
HORSLEY dissecteur à dure-mère.....	235
HOSOBUCHI Curettes à hypophyse	324
HOUSE adaptateur d'aspiration	264
HOUSE canules à aspiration et à irrigation	264
HOWARTH élévateur	203
HUDSON perforateur	209
HUNT pinces pour saisir des tumeurs	84-85

I

INGE écarteur pour laminectomie.....	148
Instruments crâniennes	215-222
Instruments pour l'hypophysectomie.....	317-330
IRIS ciseaux	34

J

JACOBS mandrin	210
JACOBSON couteau pour vaisseaux	248, 251
JACOBSON fourche pour fil à suturer.....	248
JACOBSON micro ciseaux	55
JACOBSON pince	63
JACOBSON pinces hémostatiques.....	99
JACOBSON porte-aiguilles, micro	158, 161
JACOBSON sondes boutonnées.....	244
JAMESON ciseaux à dissection.....	42
JAMESON-WERBER ciseaux à dissection	42
JANNETTA écarteur	142
JANSEN écarteur	109
JANSEN pince	70
JANSEN pinces-gouges	167
JANSEN rugines-raspatoire.....	198
JANSEN-GIFFORD écarteur	109
JANSEN-WAGNER écarteur	109
JEFFERSON écarteur.....	122
JEFFERSON pince.....	63
JOHNS HOPKINS clamps bulldog	91
JOSEPH ciseaux	31
JOSEPH crochet pour la muqueuse	224

JOSEPH rugines-raspatoire.....	198
JULIAN porte-aiguilles	154

K

KELLY pinces hémostatiques	95
KELLY-RANKIN pinces hémostatiques.....	95
KERRISON pinces emporte-pièce pour laminectomie	274-277
KERRISON pinces emporte-pièce pour os	282
KEY élévateur.....	201
KILNER ciseaux	32
KIRSCHNER broche	211
KNIGHTON écarteur pour laminectomie	124
KOCHER-LANGENBECK écarteur.....	106
KOENIG levier à os.....	207
KOOS couteau pour vaisseaux	242
KRÄMER rugines-raspatoire.....	196
KRAYENBÜHL crochets à nerfs et à vasculaires	241

L

LAHEY crochet à dure-mère	224
LAMBOTTE osteotome	186
LAMBOTTE rugines-raspatoire	196
Lame écarteur	104
Lames a rasoir.....	14
Lames des bistouris, micro, stériles.....	13
Lames des bistouris, stériles.....	10-11
LANDOLT aspirateur pour préparation	263
LANDOLT Curettes à hypophyse	324
LANDOLT enucléateurs	323
LANDOLT manche de bistouris, micro.....	12-13
LANDOLT pince écartante pour spéculums.....	318
LANDOLT pinces pour l'hypophysectomie.....	329
LANDOLT pinces pour préhension de tumeurs	269
LANDOLT rugines-raspatoire	199
LANDOLT-REULEN curettes pour hypophyse	325
LANDOLT-REULEN micro crochet	325
LANDOLT-REULEN micro dissecteur	325
LANDOLT-REULEN rugine.....	325
LANE écarteur.....	104
LANE levier à os	206
LANGE rugines-raspatoire	232
LANGENBECK élévateur	200
LANGENBECK porte-aiguilles	154
LANGENBECK rugines-raspatoire.....	197, 200
LAZAR pince	73
LEBSCHÉ conducteur pour scies à fil.....	220
LEKSELL (STILLE) pinces-gouges	172
LEKSELL pinces-gouges	172
LEMPERT curettes tranchantes	177
LEMPERT pinces-gouges.....	167
LEMPERT rugines-raspatoire.....	232
LEMPERT tube d'aspiration.....	259
LERICHE pinces hémostatiques	99
Leviers à os	206-207
LEXER ciseaux	24
LEXER gouge	189
LEXER osteotome	187-188
LEXER-mini osteotome	189
LISTER ciseaux a bandages.....	46
LITTLE-JOKER (CUSHING) rugines-raspatoire.....	201
LITTLER ciseaux guide-fil.....	25
LOGAN écarteur.....	108
LOVE retracteur pour radici die nervi	230-231
LOVE-GRUENWALD pince pour laminectomie.....	268
LOVELACE pinces hémostatiques	97
LUCAE pince.....	70
LUER pinces-gouges.....	165-166
LUER tube d'aspiration	260

M

MAGILL tube d'aspiration	258
Maillets	2-3, 192-195
Maillets, en matière plastique	193-195
MALIS écarteur.....	141
Manche à crochet.....	220
Manches de bistouris.....	6-9
Manches de bistouris, micro.....	12-13

MARKHAM-MEYERDING écarteur pour laminectomie.....	126	OLIVECRONA-TOENNIS pince à poser clips	216	Regle, metal.....	4
MARQUARDT pinces-gouges.....	169	Ostéotomes	183-189	REILL pince a couper le fil	212
MARTEL pinces pour le cuir chevelu.....	98			Retracteurs à dure-mère	228
MARTIN spatules	256	P		Retracteurs pour radici die nervi	225-231
MARTINI curettes tranchantes.....	178	PAPAVERO ciseau burin pour les lames de l'arc vertébral.....	318	REYNOLDS ciseaux	33
MATHIEU porte-aiguilles	154	PAPAVERO-CASPAR hypophysectomiespécumls	318	RHOTON aiguille	250
MAYFIELD pinces-gouges	168	PARKER bistouris délicats	16	RHOTON micro crochet	250
MAYO (HARRINGTON) ciseaux.....	22	PARTSCH rugines-raspatoire.....	232	RHOTON micro curette	250
MAYO ciseaux	22	Passe-fils	241	RHOTON micro dissecteur.....	249
MAYO-HEGAR porte-aiguilles.....	152	PENFIELD dissecteur à dure-mère	236-237	RHOTON micro élévateur.....	249
MAYO-STILLE ciseaux	23	PENNYBACKER rongeur.....	266	RHOTON sondes boutonnées	250
McDONALD élévateur.....	203	PENNYBAKER pinces-gouges	168	RIBBON spatules	256
McINDOE pince.....	64	PENNYBAKER sonde et dissecteur	234	Rongeur, forte	271
McINDOE pinces coupantes à os	174	Perforateurs à main	208-210	Rongeurs.....	265-282
McKENTY élévateur	202	Pièce de rallonge	209	Rongeurs pour disques intervertébraux ..	270-273
McKENZIE fraise	209	Pied à coulisse pour neurochirurgie	4	Rugines-raspatoires	196-204, 232
McKENZIE pince à poser clips	216	Pilons métalliques	184	Rugines-raspatoires pour lambeau osseux ..	232
McKISSOCK rugines-raspatoire	196	Pince a couper le fil	212	RUSKIN pinces-gouges	169
MEAD marteau	195	Pince a dissection	60-61	RUSKIN-LISTON pinces coupantes à os.....	174
MEAD pinces-gouges	164	Pince à iris.....	69	RYDER (VASCULAR) porte-aiguilles.....	153
Mèche.....	136	Pince à poser clips	215-216	RYDER porte-aiguilles	153
Mèche hélicoïdale	208-209, 211	Pince d'horloger	68		
MEHDORN clips vasculaires	306	Pince écartante pour spécumls	318	S	
MEHDORN pinces à appliquer les clips vasculaires	306	Pince pour poser et retirer les clamps Bulldog	91	SACHS dissecteur à dure-mère.....	233, 235
MEMORY pinces à appliquer les clips anévrismaux	300-301	Pince, micro	72-86	SACHS écarteur a nerfs	227
METZENBAUM ciseaux à dissection	26	Pinces.....	60-86	SAMII couteaux à tumeurs	245
METZENBAUM-BABY ciseaux à dissection	26	Pinces à appliquer les clips anévrismaux	300-304	SAMII pinces pour saisir des tumeurs	83
METZENBAUM-FINO ciseaux à dissection	27-30	Pinces à appliquer les clips vasculaires	305-309, 314	SANVENERO ciseaux	31
MEYERDING écarteur	107	Pinces à dissection et à ligatures	100	SATINSKY clamps bulldog	88
MEYERDING écarteur pour laminectomie	126	Pinces à ligatures.....	82	SAUERBRUCH Costotome	213
MEYERDING lames.....	146	Pinces coupantes à os	174	SAUERBRUCH pinces-gouges	171
Micro atrauma pince.....	75-81, 86	Pinces de traction crânienne	218	SCHLESINGER pinces emporte-pièce pour laminectomie.....	279
Micro ciseau.....	48-58	Pinces emporte-pièce crâniennes	222	SCHLESINGER rongeur	266
Micro ciseaux à dissection.....	49, 52-53	Pinces emporte-pièce pour laminectomie	274-280	SCHMIEDEN-TAYLOR ciseaux pour dure-mère	44
Micro ciseaux, métal léger.....	56-57	Pinces emporte-pièce pour os.....	282	SCHNEIDER rugines-raspatoire.....	201
Micro ciseaux, SuperCut	56	Pinces emporte-pièces pour sinus sphénoïdal.....	282	SCHNEIDER SAUERBRUCH rugines-raspatoire.....	201
Micro pince.....	72-86	Pinces éthmoïdales.....	281	SCHUHKNIGHT tube d'aspiration.....	264
Micro pince, métal léger	72, 74	Pinces hémostatiques.....	93-101	SCOVILLE crochets à nerfs et dissecteur	229
Micro pince, titane	86	Pinces nasales coupantes.....	281	SCOVILLE curettes tranchantes.....	176
Micro porte-aiguilles.....	155-162	Pinces pour coagulation, bipolaires.....	332-336	SCOVILLE écarteur pour laminectomie ..	143-146
Micro porte-aiguilles, métal léger	161	Pinces pour l'hypophysectomie	329-330	SCOVILLE lames	146
Micro porte-aiguilles, titane.....	162	Pinces pour laminectomie	268	SCOVILLE retracteur pour radici die nervi.....	225
Micro-élévateurs	199, 249	Pinces pour le cuir chevelu.....	98	SCOVILLE spatules	254
MILLES micro ciseaux	54	Pinces pour nouer les fils, micro	72-75, 86	SCOVILLE-HAVERFIELD écarteur pour laminectomie.....	144
MILLIGAN dissecteur à dure-mère	233-234	Pinces pour protéger alésage	221	SCOVILLE-RICHTER écarteur pour laminectomie.....	147
MILLS ciseaux.....	37	Pinces pour saisir des tumeurs	83-85, 269	SEBILAU élévateur.....	200
MINI (YASARGIL) clips d'anévrisme.....	296-295	Pinces-gouges	164-173	SEDILLOT rugines-raspatoire.....	197
Miroir.....	328	Pinces-gouges	164-173	SELDIN rugines-raspatoire.....	204
MISKIMON écarteur.....	113	Plateaux pour micro clips d'anévrisme	315	SEMB pinces-gouges	173
MIXTER-BABY pinces hémostatiques	101	PLESTER tube d'aspiration.....	260	SEMKEN pince	64-65
MOLLISON écarteur	122	Poignée avec mandrin Jacobs	210	Separeteur per dure-mère	234
MOLT rugines-raspatoire.....	204	Pontion des ventricules, canules	261	SEWALL élévateur	202
MOYNIHAN pinces hémostatiques.....	97	Porte-aiguilles	150-162	SIMON curettes tranchantes	176
MÜLLER approximateurs	308	Porte-aiguilles, micro	155-162	SMITH-PETERSEN pinces-gouges.....	173
MÜLLER clips vasculaires	310	POTTS-DE MARTEL ciseaux	37	SMITHWICK écarteur a nerfs.....	229
		POTTS-SMITH ciseaux.....	37-39	SMITHWICK pince à poser clips	216
N		POTTS-SMITH pince	60	Sonde et dissecteur	234
NAGEL micro ciseaux	51	POTTS-YASARGIL micro ciseaux	54	Sondes boutonnées.....	244, 250
NEIVERT porte-aiguilles	151	PROVIDENCE-HOSPITAL pinces hémostatiques.....	96	Spatules	254-256
NICOLA ciseaux pour l'hypophysectomie.....	330			Spécumls pour l'hypophysectomie transsphénoïdale.....	318
NICOLA Curettes à hypophyse.....	320-321	Q		spécumls pour les opérations de vertébrale lombaire	139
NICOLA pinces pour l'hypophysectomie	330	QUERVAIN élévateur.....	200	SPURLING pince pour laminectomie	268
NICOLA rugine	321			ST. CLAIR-THOMPSON rugines-raspatoire ..	232
NIEDERDELLMANN ostéotome	187	R		STANDARD (YASARGIL) clips anévrismaux	284-295
NORFOLK-NORWICH écarteur pour laminectomie	123	RABINER marteau.....	3	STEINBACH marteau	193
NORTHFIELD pinces-gouges.....	168	RAGNELL ciseaux	31	STELLBRINK pinces-gouges.....	165
		RAGNELL-DAVIS écarteur.....	104	Stérilisation des cas	339
O		RAIMONDI pinces pour le cuir chevelu	98	STEVENS ciseaux tenotonomie	35
O'CONNELL retracteur pour radici die nervi ..	225	RALK perforateur	210	STILLE ciseaux-burins	185
OBWEGESER ostéotome	187	RANEY agrafes hémostatique pour cuir chevelu	217	STILLE gouge	185
OKONEK-YASARGIL fourches à tumeurs.....	248	RANEY pince à poser clips.....	217	STILLE osteotome.....	185
OLDBERG écarteur	105	Râpes.....	206	STILLE perforateur	208
OLDBERG rongeur	269	Raspatoires.....	240, 243, 321, 325	STILLE RUSKIN pinces-gouges.....	171
OLIVECRONA ciseaux pour le nerf trigéminale.....	36	RAY Curettes à hypophyse	319	LISTON-KEY-HORSLEY pinces coupantes à os ...	174
OLIVECRONA couteau pour trijumeau	238			STILLE-LUER pinces-gouges.....	170-171
OLIVECRONA scies à fil.....	220				
OLIVECRONA pinces-gouges.....	166				
OLIVECRONA spatules.....	254				

STILLE-SHERMANN perforateur	208
STRULLY ciseaux pour le nerf trigeminal	43
SUNDAY élévateur.....	232
Support porte-agrafes.....	217
SWEET ciseaux pour l'hypophysectomie.....	330
SWEET pince à poser clips.....	216
Synovectomie pinces-gouges.....	165, 168
SYPERT pilons métalliques.....	184
SYPERT pinces emporte-pièce pour laminectomie.....	280

T

TAKAHASHI pinces éthmoïdales	281
TAYLOR écarteurs pour le spinale	207
TAYLOR lames	146
TAYLOR marteau.....	2
TAYLOR pince.....	66
TAYLOR-CUSHING pince	64
Tenue de disque	336
TERRIER pinces hémostatiques	93
TOENNIS couteau pour dure-mère	238
TOENNIS crochet à dure-mère.....	224
TOENNIS dissecteur à dure-mère	233
TOENNIS porte-aiguilles	154
TOENNIS-ADSON ciseaux neurochirurgicaux	43
TOLEDO micro ciseaux	57
TOLEDO micro pince	75
TOLEDO micro-ciseaux vasculaires	50
TOLEDO porte-aiguilles, micro	159
Tournevis vis de distraction	136
TRAUBE marteau	2
Trépan	208-209
Tréphines crâniennes.....	221
TROEMNER marteau.....	2
TROTTER pinces-gouges.....	168
TROUTMAN-CHRIS casse-lames	14
Tubes d'aspiration.....	257-264

U

ULTRA-LIGHT atrauma pince.....	81
UNIVERSAL ciseaux a bandages	46
UNIVERSAL ciseaux coupe-fill	45

V

VALIN écarteur pour laminectomie.....	145
VANNAS ciseaux iridectomie	48
VANNAS micro ciseaux	49, 53-55
VERHOEVEN micro canules d'aspiration	264
Vertebroscope	336
Vis pour distraction	136
VISE micro pince	73
VOLKMANN curette double tranchantes	178
VOLKMANN curettes tranchantes	175, 178-179

W

WAGNER ciseaux	45
WAGNER marteau	192
WAGNER rongeurs pour disques intervertébraux	271
WALTER gouge.....	183
WALTON écarteur pour laminectomie	124
WANGENSTEEN pince.....	67
WARTENBERG algesimetre	4
WATSON-CHEYNE dissecteur.....	203
WAUGH pince.....	65
WEBER estésiometre	4
WEIL-BLAKESLEY pinces nasales coupantes.....	281
WEITLANER écarteur.....	110-113
WHEELER (DEBAKEY) atrauma pince	79
WILLET-MARTEL pinces pour le cuir chevelu.....	98
WILLIAMS écarteurs pour laminectomie.....	127
WILLIGER curettes tranchantes.....	178
WILLIGER élévateur.....	202
WILLIGER marteau	193-194
WILLIGER rugines-raspatoire	198

Y

YANKAUER tube d'aspiration.....	258
YASARGIL canules à aspiration et à irrigation	263
YASARGIL clips anévrismaux	284-299

YASARGIL clips pour la fermeture permanente	284-286, 290
.....	292, 294, 296-297

YASARGIL clips pour la fermeture temporaire.....	287-289, 291
.....	293, 295, 298-299
YASARGIL couteaux arachnoïdiens	242
YASARGIL crochets à gales.....	219
YASARGIL curette	240
YASARGIL dissecteur à arbre flexible	235
YASARGIL fourches à tumeurs	245
YASARGIL micro ciseaux.....	52-54
YASARGIL micro ciseaux à dissection.....	52-53
YASARGIL micro pince	82-83
YASARGIL passe-fils	241
YASARGIL pinces pour saisir des tumeurs	83, 85
YASARGIL porte-aiguilles, micro	160
YASARGIL raspatoire	240, 243
YASARGIL rongeur.....	269
YASARGIL tube d'aspiration.....	258
YASARGIL-NICOLA pinces pour l'hypophysectomie	330
ZAUFAL-JANSEN pinces-gouges	168

Z

ZIELKE gouge.....	188
ZOELLNER micro canules d'aspiration.....	262
ZOELLNER tube d'aspiration	262

A

AACHEN espátulas.....	254
ACLAND aproximadores.....	313
ACLAND clips vasculares.....	312
ACLAND pinza aplicadora para clips vasculares.....	314
Adaptador para aspiración.....	264
ADSON (DEBAKEY) atrauma pinza.....	79
ADSON aguja para aneurisma.....	231
ADSON elevador.....	200
ADSON pinzas.....	61-62
ADSON pinzas para hipofisectomía.....	329
ADSON pinzas, micro.....	61
ADSON pinzas-gubias.....	166
ADSON separador.....	228
ADSON separadore.....	113-115
ADSON tubo de aspiración.....	258
ADSON-BABY pinzas hemostáticas.....	99
ADSON-BIEMER pinzas.....	62
Aguja.....	250
Aguja para aneurisma.....	231
Alicate para cortar alambre.....	212
ALLIS pinzas hemostáticas.....	101
ALM separadore.....	108
ANDERSON-ADSON separadore.....	113
Anillo pinza.....	75, 86
Aproximadores.....	307-309, 313
Arachnoidea cuchillos.....	242
Aspirador para preparación.....	263
Atrauma Clamps Bulldog.....	88-90, 92
Atrauma pinza, micro.....	75-81, 86
AUSTIN micro pinza.....	73

B

BABINSKY martillo.....	2
BABY CRILE-WOOD porta-agujas.....	152
Baby-MIXTER pinzas hemostáticas.....	101
BACON pinzas-gubias.....	167
BADGLEY separadore para laminectomía.....	130
BANE-HARTMANN pinzas-gubias.....	166
BARON tubo de aspiración.....	264
BARRAQUER porta-agujas, micro.....	156
BARRAQUER-TROUTMAN porta-agujas, micro.....	156
BAUMGARTNER porta-agujas.....	151
BECK pinza saca-bocadas.....	266
BECKMANN separadore para laminectomía.....	119
BECKMANN-ADSON separadore.....	116
BECKMANN-ADSON separadore para laminectomía.....	120
BECKMANN-EATON separadore para laminectomía.....	121
BELLUCI micro cánulas.....	262
BELLUCI tubo de aspiración.....	262
BERLINER martillo.....	3
BEYER pinzas cortantes para huesos.....	282
BEYER pinzas-gubias.....	167
BEYER synovectomy pinzas-gubias.....	168
BIEMER aproximadores.....	309
BIEMER clips vasculares.....	305
BIEMER Dilatadores vasculares.....	244
BIEMER micro tijeras.....	54
BIEMER pinza aplicadora para clips vasculares.....	305, 307-309
BIEMER-MÜLLER aproximadores.....	307
Bisturís delicados.....	16
BLUMENTHAL pinzas-gubias.....	165
BOEHLER pinzas-gubias.....	169
Broca espiral.....	208-209, 211
BROPHY pinzas.....	66
BROWN pinzas.....	62
BRUNS cucharillas cortantes.....	175
BUCK martillo.....	3
BUECHS periostótomo.....	198
BULLDOG clips vasculares.....	311
BUSHE cucharillas cortantes.....	180

C

CAIRNS espátulas.....	255
CAIRNS ganchito.....	224
CAIRNS pinzas hemostáticas.....	96
CAIRNS separadore.....	122
Calibre especial para neurocirugía.....	4

Cánulas de aspiración y de irrigación.....	263-264
Cánulas para aspiración.....	257-264
Cánulas para aspiración, micro.....	262, 264
Cánulas para la punción del vebtrículo.....	261
CAROTID clamps bulldog.....	88
CARREL pinzas hemostáticas.....	93
CASPAR cucharillas cortantes.....	179, 181
CASPAR destornillador.....	136
CASPAR disector cuerpo vertebral.....	199
CASPAR distracción tornillos.....	136
CASPAR distractor.....	134-135
CASPAR el cáncer cérvico-uterino cuerpo vertebral sistema de distracción.....	134-136
CASPAR el taladro guía.....	134-135
CASPAR especulativo.....	139
CASPAR ganchos pour exploración y coagulación.....	228
CASPAR hojas.....	131, 133
CASPAR horquilla para ligadura.....	248
CASPAR mango de bisturís, micro.....	12
CASPAR micro disector.....	246
CASPAR periostótomo.....	199
CASPAR pinzas cortantes para discos intervertebrales.....	271-273
CASPAR punzones metálicos.....	184
CASPAR separador cervical.....	128-133
CASPAR separador para la raíz de nervio.....	230
CASPAR Separadores lumbales autostáticos.....	137-138
CASPAR taladro.....	136
CASTROVIEJO porta-agujas, micro.....	156-158, 160
CASTROVIEJO rompe hojas.....	15
CASTROVIEJO tijeras iridectomía.....	48
Cinzel para lámina.....	318
Cinceles.....	185
CITELLI pinzas cortantes para huesos.....	282
Clamps bulldog.....	88-92
Clamps bulldog, micro.....	92
CLEVELAND pinzas-gubias.....	164
Clips de aneurisma.....	284-299
Clips vasculares.....	283-315
CLOWARD cuchilla retractor.....	104
CLOWARD separadore para laminectomía.....	125
CLOWARD separadore para laminectomía.....	148
CLOWARD-HOEN separadore para hemilaminectomía.....	140
COBB espinal elevadores.....	191
COBB fusión espinal cucharillas.....	179
COBB fusión espinal gubias.....	190
COLCLOUGH pinzas saca-bocadas para laminectomía.....	278
COLLIN dinamometro.....	2
Conductor para sierras de hilo.....	220
CONE cureta para hipófisis.....	321
CONE separadore para laminectomía.....	123
CONE trépanos craneales.....	221
Contenedores.....	338-339
Contenedores para micro Clips de aneurisma.....	315
Contenedores, acero inoxidable.....	339
Contenedores, aluminio.....	338
CONTOUR separador para el cuero cabelludo.....	127
COOLEY atrauma pinza.....	78
Costótomos.....	213
COTTLE elevador.....	204
COTTLE martillo.....	193
COTTLE pinzas.....	70
CRILE pinzas hemostáticas.....	95
CRILE separador para nervios.....	227
CRILE-RANKIN pinzas hemostáticas.....	96
CRILE-WOOD porta-agujas.....	151
CRUTCHFIELD estribos de tracción craneal.....	218
CRUTCHFIELD perforador.....	218
Cucharilla para hipófisis.....	324-325, 328
Cucharillas cortantes.....	175-182
Cuchilla retractor.....	104
Cuchillo.....	238
Cuchillo para trigémino.....	238
Cuchillo para vasos.....	242, 248
Cuchillos en forma de lanceta para tejidos con tumores.....	245

Cuchillos para tumores.....	245
Curetas para hipófisis.....	319-321, 325-327
Curetas, micro.....	240, 250
CUSHING espátulas.....	254
CUSHING ganchito.....	224
CUSHING gancho para decompresión.....	105
CUSHING periostótomo.....	201-202
CUSHING pinza para laminectomía.....	268
CUSHING pinza saca-bocadas.....	267
CUSHING pinzas.....	63
CUSHING pinzas hemostáticas.....	96
CUSHING separador para nervios.....	227
CUSHING taladro plano.....	209
CUSHING-LANDOLT hipofisectomíaespeculo	318
CUSHING-TAYLOR pinzas.....	64

D

DAHLGREN pinzas saca-bocadas para craneotomía.....	222
DANDY pinzas hemostáticas.....	97
DANDY separador para nervios.....	226
DANDY Tijeras para nervio trigémino.....	44
DARLING separadore para laminectomía.....	123
DAUBENSPECK cucharillas cortantes.....	176
DAVIS disector.....	234
De MARTEL conductor para sierras de hilo.....	220
DEBAKEY atrauma pinza.....	75-81, 86
DEBAKEY clamps bulldog.....	90
DEBAKEY porta-agujas.....	152-153
DEBAKEY Tijeras de la sangría.....	25
DEBAKEY tijeras.....	41
DEBAKEY-DIETHRICH atrauma pinza.....	78
DEBAKEY-DIETHRICH clamps bulldog.....	89
DEBAKEY-GLOVER clamps bulldog.....	88
DECKER tijeras para la hipofisectomía.....	330
DEJERINE martillo.....	3
D'ERRICO fresa.....	209
Destornillador para tornillos de distracción.....	136
DeVLBISS pinzas saca-bocadas para craneotomía.....	222
Diagnóstico.....	1-4
Diapason.....	4
DIEFFENBACH bisturís delicados.....	16
DIEFFENBACH clamps bulldog.....	91
DIETHRICH clamps bulldog.....	89
DIETHRICH tijeras.....	40
Dilatadores vasculares.....	244
DIMEDA rompe hojas.....	14
DIMEDA separadore.....	109
Dinamometro.....	2
Disectores.....	200-204, 246
Disectores, micro.....	246, 249, 322, 325, 327
Disector con eje flexible.....	235
Dissectors cuerpo vertebral.....	199
Distracción tornillos.....	136
Distractor.....	134-135
DUEHRSEN pinzas.....	67
DUNHILL pinzas hemostáticas.....	96

E

ECHLIN pinzas-gubias.....	173
El cáncer cérvico-uterino cuerpo vertebral sistema de distracción.....	134-136
El taladro guía.....	134-135
Elevadores.....	200-204
Elevadores para hueso.....	206-207
Elevadores, micro.....	199, 249
Enucleadores.....	322-323
EPSTEIN cucharillas cortantes.....	180
Escofinas.....	206
Espátulas.....	254-256
especulativo de las operaciones vertebral lumbar.....	139
Especulo para la hipofisectomía trans-esfenoidal.....	318
Espejo.....	328
Espinal elevadores.....	191
Esterilización casos.....	339
Estesiómetro.....	4
Estribos de tracción craneal.....	218

F

FAHLBUSCH cucharilla para hipófisis.....	325
FAHLBUSCH cureta para hipófisis.....	325

FAHLBUSCH tijeras para la hipofisectomía ...	330
FARABEUF periostótomo	196
FARABEUF-COLLIN periostótomo	196
FERGUSON tubo de aspiración	259
FERRIS-SMITH-CHUSHING pinzas cortantes para discos intervertebrales.....	270
FINSEN separadore	108
FISCH cánulas de aspiración y de irrigación.....	263
FISCH ganchito	251
FISCH micro ganchito	251
FOMON escofinas	206
fórceps para la protección de orificio	221
FRAZIER cánulas para la punción del vebtrículo	261
FRAZIER ganchito	224
FRAZIER separador	234
FRAZIER tubo de aspiración	258-261
FREER elevador	203
FREER ganchito para mucosa.....	224
Fresa	209
Fresa esférica.....	208-209
FRIEDMAN pinzas-gubias.....	164
FRIEDMAN-MINI pinzas-gubias	164
FRYKHOLM pinzas-gubias	172
Fusión espinal cucharillas	179, 182
Fusión espinal gubias.....	190

G

Ganchito para nervios y disectores.....	229
Ganchitos	224, 228, 251
Ganchitos para mucosa	224
Ganchitos para piel	224
Ganchitos, micro	248-251
Gancho para decompresión	105
Gancho para galea	219
Ganchos para nervios y vasos	241
Ganchos pour exploratción y coagulación	228
Garras para tejido	251
GELPI separador perineal	107
GEMINI pinzas para disección y ligaduras	100
GEMINI-MINI pinzas para disección y ligaduras.....	100
GERALD (DEBAKEY) atrauma pinza	79
GERALD pinzas	67
GIERTZ STILLE Costotomo	213
GIGLI mango de gancho	220
GIGLI sierras de hilo	220
GILLIES pinzas.....	65
GLASSMAN atrauma pinza.....	79
GLOVER clamps bulldog	88
GOLDMAN-FOX Tijeras para encias	44
GOMEL micro pinza	74
GOMEL micro tijeras	49
GORNEY tijeras	25
GRAEFE pinza para iris	69
GRAHAM separador para nervios	227
Grapa Colonia.....	217
Grapas de plata.....	217
GRONINGEN separador para nervios	228
GRUENWALD pinzas.....	64
GRUENWALD pinzas.....	70
Gubias	183, 188-190
Gubias para la columna vertebral	188
Gubias para la toma de injertos de las costillas	183
Gubias para las operaciones de escoliosis.....	188
Guía-ligadura	241
GULEKE pinzas-gubias	167

H

HAJEK martillo	192
HAJEK pinzas sacabocadas para esfenoides	282
HAJEK-KOFLER pinzas sacabocadas para esfenoides	282
HALLE cucharillas cortantes.....	177
HALLE cuchillo	238
HALLE elevador	232
HALSEY porta-agujas	151
HALSTED-MOSQUITO pinzas hemostáticas.....	94
HARDY cucharilla para hipófisis.....	328
HARDY cureta para hipófisis	320, 326-327
HARDY enucleadores	322

HARDY hipofisectomía-espéculo	318
HARDY micro disector.....	327
HARDY micro espejo.....	328
HARDY pinzas para hipofisectomía	329
HARDY pinzas saca-bocadas para laminectomía	280
HARDY-FAHLBUSCH micro disector.....	322
HARTMANN pinzas hemostáticas	93
HARVEY-JACKSON separadore para laminectomía.....	121
HEIFETZ espátulas.....	255
HEIFETZ pinzas para agarrar tumores.....	85
HENLY separadore	110
HESS (DEBAKEY) clamps bulldog	91
HESS (LOVE modif.) separador para la raíz de nervio	230
HIBBS hojas	146
HOEN periostótomo	198
HOEN pinzas para el cuero cabelludo	98
HOEN separador	234
HOEN separador para nervios	227
HOEN separadore para hemilaminectomía	140
Hojas de afeitar	14
Hojas de bisturís estériles.....	10-11
Hojas de bisturís, micro estériles.....	13
Horquilla para implantar	322
Horquilla para ligadura	248
Horquillas para tumores	245, 248
HORSLEY disector	235
HOSOBUCHI cucharilla para hipófisis	324
HOUSE adaptador para aspiración.....	264
HOUSE cánulas de aspiración y de irrigación.....	264
HOWARTH elevador.....	203
HUDSON perforadores	209
HUNT pinzas para agarrar tumores.....	84-85

I

INGE separadore para laminectomía	148
Instrumentos para craneotomía	215-222
Instrumentos para hipofisectomía	317-330
IRIS tijeras.....	34

J

JACOBS mandril	210
JACOBSON cuchillo para vasos	248, 251
JACOBSON horquilla para ligadura	248
JACOBSON micro tijeras	55
JACOBSON pinzas	63
JACOBSON pinzas hemostáticas	99
JACOBSON porta-agujas, micro	158, 161
JACOBSON sondas abotonadas.....	244
JAMESON tijeras de disección	42
JAMESON-WERBER tijeras de disección	42
JANNETTA separadore	142
JANSEN periostótomo.....	198
JANSEN pinzas.....	70
JANSEN pinzas-gubias	167
JANSEN separadore.....	109
JANSEN-GIFFORD separadore.....	109
JANSEN-WAGNER separadore.....	109
JEFFERSON pinzas	63
JEFFERSON separadore	122
JOHNS HOPKINS clamps bulldog.....	91
JOSEPH ganchito para mucosa	224
JOSEPH periostótomo.....	198
JOSEPH tijeras	31
JULIAN porta-agujas	154

K

KELLY pinzas hemostáticas	95
KELLY-RANKIN pinzas hemostáticas	95
KERRISON pinzas cortantes para huesos	282
KERRISON pinzas saca-bocadas para laminectomía	274-277
KEY elevador	201
KILNER tijeras.....	32
KIRSCHNER brocas	211
KNIGHTON separadore para laminectomía.....	124
KOCHER-LANGENBECK separadore	106
KOENIG elevador para hueso	207
KOOS cuchillo para vasos	242
KRÄMER periostótomo.....	196
KRAYENBÜHL ganchos para nervios y vasos	241

L

LAHEY ganchito	224
LAMBOTTE osteotomo	186
LAMBOTTE periostótomo	196
LANDOLT aspirador para preparación.....	263
LANDOLT cureta para hipófisis	324
LANDOLT enucleadores	323
LANDOLT mango de bisturís, micro	12-13
LANDOLT periostótomo	199
LANDOLT pinza dilatadora para espéculos	318
LANDOLT pinzas para agarrar tumores.....	269
LANDOLT pinzas para hipofisectomía	329
LANDOLT-REULEN cureta para hipófisis.....	325
LANDOLT-REULEN legtras	325
LANDOLT-REULEN micro disector.....	325
LANDOLT-REULEN micro ganchito	325
LANE elevador para hueso.....	206
LANE separadore	104
LANGE periostótomo	232
LANGENBECK elevador	200
LANGENBECK periostótomo.....	197, 200
LANGENBECK porta-agujas	154
LAZAR pinzas	73
LEBSCHKE conductor para sierras de hilo	220
LEKSELL (STILLE) pinzas-gubias.....	172
LEKSELL pinzas-gubias.....	172
LEMPERT cucharillas cortantes	177
LEMPERT periostótomo.....	232
LEMPERT pinzas-gubias	167
LEMPERT tubo de aspiración	259
LERICHE pinzas hemostáticas.....	99
LEXER gubia.....	189
LEXER osteotomo.....	187-188
LEXER tijeras	24
LEXER-mini osteotomo	189
LISTER tijeras para vendajes	46
LITTLE-JOKER (CUSHING) periostótomo	201
LITTNER Tijeras guía-hilo	25
Llave suelta	132, 309
LOGAN separadore	108
LOVE separador para la raíz de nervio.....	230-231
LOVE-GRUENWALD pinza para laminectomía	268
LOVELACE pinzas hemostáticas	97
LUCAE pinzas	70
LUER pinzas-gubias	165-166
LUER tubo de aspiración	260

M

MAGILL tubo de aspiración	258
MALIS separadore	141
Mango con mandril Jacobs.....	210
Mango de gancho	220
Mangos de bisturís	6-9
Mangos de bisturís, micro	12-13
MARKHAM-MEYERDING separadore para laminectomía	126
MARQUARDT pinzas-gubias	169
MARTEL pinzas para el cuero cabelludo	98
Martillos.....	2-3, 192-195
Martillos, de plástico.....	193-195
MARTIN espátulas	256
MARTINI cucharillas cortantes.....	178
MATHIEU porta-agujas	154
MAYFIELD pinzas-gubias	168
MAYO (HARRINGTON) tijeras.....	22
MAYO tijeras	22
MAYO-HEGAR porta-agujas	152
MAYO-STILLE tijeras	23
McDONALD elevador	203
McINDOE pinzas	64
McINDOE pinzas cortantes para hueso	174
McKENTY elevador.....	202
McKENZIE fresa	209
McKENZIE pinza para poner grapas.....	216
McKISSOCK periostótomo.....	196
MEAD martillo.....	195
MEAD pinzas-gubias.....	164
MEHDORN clips vasculares.....	306
MEHDORN pinza aplicadora para clips vasculares	306
MEMORY pinza aplicadora para clips de aneurisma.....	300-301
METZENBAUM tijeras de disección	26

METZENBAUM-BABY tijeras de disección	26	Pinza para poner grapas.....	215-216	SCHMIEDEN-TAYLOR Tijeras	44
METZENBAUM-FINO tijeras de disección	27-30	Pinza para poner y quitar clamps Bulldog.....	91	SCHNEIDER periostótomo.....	201
MEYERDING hojas	146	Pinza, micro	72-86	SCHNEIDER-SAUERBRUCH periostótomo.....	201
MEYERDING separadore.....	107	Pinzas	60-86	SCHUHKNECHT tubo de aspiración.....	264
MEYERDING separadore para laminectomía	126	Pinzas cortantes para discos intervertebrales.....	270-273	SCOVILLE cucharillas cortantes.....	176
Micro atrauma pinza	75-81, 86	Pinzas cortantes para hueso	174	SCOVILLE espátulas	254
Micro elevadores.....	199, 249	Pinzas cortantes para huesos	282	SCOVILLE ganchito para nervios y disector	229
Micro pinza	72-86	Pinzas de coagulación, bipolares	332-336	SCOVILLE hojas.....	146
Micro pinza, metal ligero	72, 74	Pinzas hemostáticas	93-101	SCOVILLE separador para la raíz de nervio ..	225
Micro pinza, titanio	86	Pinzas nasales cortantes.....	281	SCOVILLE separadore para laminectomía	143-146
Micro porta-agujas.....	155-162	Pinzas para agarrar tumores.....	83-85, 269	SCOVILLE-HAVERFIELD separadore para laminectomía	144
Micro porta-agujas, metal ligero	161	Pinzas para disección y ligaduras	100	SCOVILLE-RICHTER separadore para laminectomía	147
Micro porta-agujas, titanio	162	Pinzas para el cuero cabelludo	98	SEBILAU elevador	200
Micro tijeras.....	48-58	Pinzas para enlazar, micro	72-75, 86	SEDILLOT periostótomo.....	197
Micro tijeras de disección.....	49, 52-53	Pinzas para etmoides.....	281	SELDIN periostótomo.....	204
Micro tijeras, metal ligero	56-57	Pinzas para hipofisectomía.....	329-330	SEMB pinzas-gubias	173
Micro tijeras, SuperCut	56	Pinzas para laminectomía.....	268	SEMKEN pinzas	64-65
MILLESÍ micro tijeras	54	Pinzas para ligaduras	82	Separador cervical	128-133
MILLIGAN disector	233-234	Pinzas saca-bocadas	265-282	Separador de cuerpos vertebrales	128-133
MILLS tijeras.....	37	Pinzas saca-bocadas para craneotomía	222	Separador perineal.....	107
MINI (YASARGIL) clips de aneurisma	296-295	Pinzas sacabocadas para esfenoides.....	282	Separadores.....	104-107
MISKIMON separadore	113	Pinzas saca-bocadas para laminectomía	274-280	Separadores autostáticos	108-116, 122, 141-142
MIXTER-BABY pinzas hemostáticas.....	101	Pinzas-gubias	164-173	Separadores lumbales autostáticos.....	137-139
MOLLISON separadore.....	122	Pinzas-gubias	164-173	Separadores	228
MOLT periostótomo.....	204	PLESTER tubo de aspiración	173	Separadores para el cuero cabelludo	127
MOYNIHAN pinzas hemostáticas	97	Porta-agujas	150-162	Separadores para espinal	207
MÜLLER aproximadores.....	308	Porta-agujas, micro	155-162	Separadores para hemilaminectomía	117-118
MÜLLER clips vasculares	310	Porta-grapas	217	Separadores para la raíz de nervio	225-231
N		POTTS-DE MARTEL tijeras	37	Separadores para laminectomía	117-127, 140, 148
NAGEL micro tijeras	51	POTTS-SMITH pinzas	60	Separadores para nervios.....	226-229, 233-235
NEIVERT porta-agujas	151	POTTS-SMITH tijeras.....	37-39	Separadores para cerebelo	112
NICOLA cureta para hipófisis	320-321	POTTS-YASARGIL micro tijeras	54	SEWALL elevador	202
NICOLA legras	321	PROVIDENCE-HOSPITAL pinzas hemostáticas	96	Sierras de hilo	220
NICOLA pinzas para hipofisectomía.....	330	Punción del vbrtrículo, cánulas.....	261	SIMON cucharillas cortantes	176
NICOLA tijeras para la hipofisectomía.....	330	Punzones metálicos.....	184	SMITH-PETERSEN pinzas-gubias	173
NIEDERDELLMANN osteotomo	187	Q		SMITHWICK pinza para poner grapas	216
NORFOLK-NORWICH separadore para laminectomía	123	QUERVAIN elevador	200	SMITHWICK separador para nervios.....	229
NORTHFIELD pinzas-gubias	168	Quita hojas.....	1	Sonda y disector	234
O		R		Sondas abotonadas.....	244, 250
O'CONNELL separador para la raíz de nervio	225	RABINER martillo.....	3	Soporte para optica.....	336
OBWEGESER osteotomo	187	RAGNELL tijeras	31	SPURLING pinza para laminectomía.....	268
OKONEK-YASARGIL horquillas para tumores	248	RAGNELL-DAVIS separadore	104	ST. CLAIR-THOMPSON periostótomo	232
OLDBERG pinza saca-bocadas	269	RAIMONDI pinzas para el cuero cabelludo	98	STANDARD (YASARGIL) clips de aneurisma	284-295
OLDBERG separadore.....	105	RALK perforadores.....	210	STEINBACH martillo	193
OLIVECRONA cuchillo para trigémino	238	RANEY pinza hemostática para cuero cabelludo	217	STELLBRINK pinzas-gubias	165
OLIVECRONA e s p á t u l a s	254	RANEY pinza para poner grapas.....	217	STEVENS Tijeras tenotomía.....	35
OLIVECRONA pinzas-gubias	166	Raspadores	240, 243, 321, 325	STILLE cinceles.....	185
OLIVECRONA sierras de hilo	220	RAY cureta para hipófisis	319	STILLE gubia.....	185
OLIVECRONA Tijeras para nervio trigémino.....	36	Regla, metal.....	4	STILLE osteotomo	185
OLIVECRONA-TOENNIS pinza para poner grapas.....	216	REILL alicate para cortar alambre	212	STILLE perforadores.....	208
Osteótomos	183-189	REYNOLDS tijeras.....	33	STILLE RUSKIN pinzas-gubias	171
P		RHOTON aguja	250	LISTON-KEY-HORSLEY pinzas cortantes para hueso.....	174
PAPAVERO cincel para lámina	318	RHOTON micro cureta.....	250	STILLE-LUER pinzas-gubias	170-171
PAPAVERO-CASPAR hipofisectomíaespéculo	318	RHOTON micro disector	249	STILLE-SHERMANN perforadores.....	208
PARKER bisturís delicados	16	RHOTON micro elevador	249	STRULLY Tijeras para nervio trigémino.....	43
PARTSCH periostótomo.....	232	RHOTON micro ganchito	250	SUNDAY elevador	232
PENFIELD disector	236-237	RHOTON sondas abotonadas	250	SWEET pinza para poner grapas.....	216
PENNYBACKER pinza saca-bocadas	266	RIBBON espátulas	256	SWEET tijeras para la hipofisectomía	330
PENNYBAKER pinzas-gubias	168	Rompe hojas	14-15	Synovectomy pinzas-gubias	165, 168
PENNYBAKER sonda y disector	234	Rongeur, potente	271	SYPERT pinzas saca-bocadas para laminectomía	280
Perforador	218	Rueda de espigas.....	4	SYPERT punzones metálicos	184
Perforadores de mano	208-210	RUSKIN pinzas-gubias	169	T	
Periostótomos	196-204, 232	RUSKIN-LISTON pinzas cortantes para hueso.....	174	TAKAHASHI pinzas para etmoides	281
Periostótomos para hueso solapa	232	RYDER (VASCULAR) porta-agujas.....	153	Taladro.....	136
Pieza de prolongación	209	RYDER porta-agujas	153	TAYLOR hojas.....	146
Pinza aplicadora para clips de aneurisma.....	300-304	S		TAYLOR martillo.....	2
Pinza aplicadora para clips vasculares	305-309, 314	SACHS disector	233, 235	TAYLOR pinzas	66
Pinza de disección.....	60-61	SACHS separador para nervios	227	TAYLOR separadores para espinal.....	207
Pinza de relojero	68	SAMII cuchillos para tumores	245	TAYLOR-CUSHING pinzas	64
Pinza dilatadora para espéculos	318	SAMII pinzas para agarrar tumores.....	83	TERRIER pinzas hemostáticas.....	93
Pinza hemostática para cuero cabelludo	217	SANVENERO tijeras	31	Tijara para preparación del nervio.....	42
Pinza para iris	69	SATINSKY clamps bulldog	88	Tijeras de la sangría	25
		SAUERBRUCH Costotomo	213	Tijeras guía-hilo	25
		SAUERBRUCH pinzas-gubias	171		
		SCHLESINGER pinzas saca-bocadas para laminectomía	279		
		SCHLESINGER pinza saca-bocadas.....	266		

Tijeras para encias.....	44
Tijeras para nervio trigémino	36, 44
Tijeras para venas	54
Tijeras tenotomía.....	35
Tijeras	18-46
Tijeras de disección.....	22-33
Tijeras de disección, micro.....	49, 52-53
Tijeras finas para preparaciones	31
Tijeras iridectomía	48
Tijeras para cirugía.....	18-21
Tijeras para cirugía neurocirugía	43-44
Tijeras para cirugía, gracil	21
Tijeras para cortar hilo.....	45
Tijeras para estrabismo	36
Tijeras para la hipofisectomía	330
Tijeras para vendajes.....	46
Tijeras vasculares.....	37-41
Tijeras vasculares, micro	50, 58
Tijeras, fino.....	31, 42, 45
Tijeras, micro.....	48-58
TOENNIS cuchillo	238
TOENNIS disector	233
TOENNIS ganchito	224
TOENNIS porta-agujas	154
TOENNIS-ADSON tijeras para cirugía neurocirugía	43
TOLEDO micro pinza	75
TOLEDO micro tijeras.....	57
TOLEDO micro-tijeras vasculares	50
TOLEDO porta-agujas, micro	159
Tornillos para distracción.....	136
TRAUBE martillo	2
Trepano	208-209
Trépanos craneales	221
TROEMNER martillo.....	2
TROTTER pinzas-gubias	168
TROUTMAN-CHRIS rompe hojas	14
Tubos de aspiración	257-264

U

ULTRA-LIGHT atrauma pinza	81
UNIVERSAL tijeras para cortar hilo.....	45
UNIVERSAL tijeras para vendajes.....	46

V

VALIN separadore para laminectomía.....	145
VANNAS micro tijeras.....	49, 53-55
VANNAS tijeras iridectomía	48
VERHOEVEN micro cánulas.....	264
Vertebroscopio	336
WISE micro pinza	73
VOLKMANN cucharillas cortantes	175, 178-179
VOLKMANN cureta doble cortantes	178

W

WAGNER martillo	192
WAGNER pinzas cortantes para discos intervertebrales	271
WAGNER tijeras	45
WALTER gubia	183
WALTON separadore para laminectomía.....	124
WANGENSTEEN pinzas	67
WARTENBERG rueda de espigas	4
WATSON-CHEYNE disector.....	203
WAUGH pinzas	65
WEBER estesiómetro	4
WEIL-BLAKESLEY pinzas nasales cortantes	281
WEITLANER separadore	110-113
WHEELER (DEBAKEY) atrauma pinza.....	79
WILLET-MARTEL pinzas para el cuero cabelludo.....	98
WILLIAMS separadore para laminectomía.....	127
WILLIGER cucharillas cortantes.....	178
WILLIGER elevador	202
WILLIGER martillo	193-194
WILLIGER periostótomo	198

Y

YANKAUER tubo de aspiración.....	258
YASARGIL arachnoidea cuchillos	242
YASARGIL cánulas de aspiración y de irrigación.....	263
YASARGIL clips de aneurisma	284-299

YASARGIL clips para el cierre permanente	284-286, 290
.....	292, 294, 296-297
YASARGIL clips para el cierre temporal	287-289, 291, 293, 295, 298-299
YASARGIL cureta	240
YASARGIL disector con eje flexible.....	235
YASARGIL gancho para galea	219
YASARGIL guía-ligadura	241
YASARGIL horquillas para tumores	245
YASARGIL micro pinza	82-83
YASARGIL micro tijeras.....	52-54
YASARGIL micro tijeras de disección.....	52-53
YASARGIL pinza saca-bocadas	269
YASARGIL pinzas para agarrar tumores.....	83, 85
YASARGIL porta-agujas, micro	160
YASARGIL raspadore	240, 243
YASARGIL tubo de aspiración	258
YASARGIL-NICOLA pinzas para hipofisectomía.....	330

Z

ZAUFAL-JANSEN pinzas-gubias.....	168
ZIELKE gubia.....	188
ZOELLNER micro cánulas	262
ZOELLNER tubo de aspiración	262

A	
AACHEN spatulas.....	254
AACHEN s p a t o l e	254
ACLAND approssimatori	313
ACLAND clips vascolari	312
ACLAND pinza per applicare i clips vascolari.....	314
Adattor per aspirazione.....	264
ADSON (DEBAKEY) atrauma pinza	79
ADSON ago da aneurisma	231
ADSON divaricatore.....	113-115
ADSON elevatorio	200
ADSON periostotomo	199
ADSON pinze.....	61-62
ADSON pinze per ipofisectomia	329
ADSON pinze sgorbie	166
ADSON pinze, micro.....	61
ADSON tubo d'aspirazione.....	258
ADSON uncino.....	228
ADSON-BABY pinze emostatiche	99
ADSON-BIEMER pinze	62
Ago	250
Ago da aneurisma.....	231
Agrafe mod. Colonia	217
Alesatore	218
ALLIS pinze emostatiche	101
ALM divaricatore	108
ANDERSON-ADSON divaricatore.....	113
Anello pinza	75, 86
Approssimatori	307-309, 313
Arachnoidea coltelli	242
Artiglie per tessuti.....	251
Aspiratore per preparazione.....	263
Atrauma pinza, micro	75-81, 86
Atrauma Pinze Bulldog	88-90, 92
AUSTIN micro pinza	73
B	
BABINSKY martello.....	2
BABY CRILE-WOOD port'aghi	152
Baby-MIXTER pinze emostatiche	101
BACON pinze sgorbie.....	167
BADGLEY divaricatore per laminectomia.....	130
BANE-HARTMANN pinze sgorbie	166
BARON tubo d'aspirazione	264
BARRAQUER port'aghi, micro	156
BARRAQUER-TROUTMAN port'aghi, micro	156
BAUMGARTNER port'aghi.....	151
BECK pinze taglienti	266
BECKMANN divaricatore per laminectomia	119
BECKMANN-ADSON divaricatore	116
BECKMANN-ADSON divaricatore per laminectomia	120
BECKMANN-EATON divaricatore per laminectomia	121
BELLUCI micro cannule	262
BELLUCI tubo d'aspirazione	262
BERLINER martello	3
BEYER pinze ossivore.....	282
BEYER pinze sgorbie.....	167
BEYER synovectomy pinze sgorbie.....	168
BIEMER approssimatori	309
BIEMER clips vascolari	305
BIEMER Dialtatori vascolari.....	244
BIEMER micro forbici.....	54
BIEMER pinza per applicare i clips vascolari	305, 307-309
BIEMER-MÜLLER approssimatori.....	307
Bisturi delicati.....	16
BLUMENTHAL pinze sgorbie.....	165
BOEHLER pinze sgorbie	169
BROPHY pinze	66
BROWN pinze.....	62
BRUNS curette taglienti	175
BUCK martello	3
BUECHS periostotomo.....	198
BULLDOG clips vascolari	311
BUSHE curette taglienti.....	180
C	
Cacciavite per viti Distraction.....	136
CAIRNS divaricatore.....	122
CAIRNS pinze emostatiche	96
CAIRNS s p a t o l e	255
CAIRNS uncino	224
Calibro speciale per neurochirurgia.....	4
Cannule per aspirazione	257-264
Cannule per aspirazione e lavaggio	263-264
Cannule per aspirazione, micro	262, 264
Cannule per la puntura del ventricolo	261
CAROTID pinze bulldog	88
CARREL pinze emostatiche.....	93
CASPAR cacciavite	136
CASPAR corpo vertebrale cervicale distrazione sistema	134-136
CASPAR curette taglienti.....	179, 181
CASPAR dissector corpo vertebrale.....	199
CASPAR distractor.....	134-135
CASPAR divaricatore cervicale	128-133
CASPAR Divaricatori autostatici lombari	137-138
CASPAR forchetta per legatura.....	248
CASPAR lame.....	131, 133
CASPAR manico per bisturi, micro.....	12
CASPAR micro dissectorio	246
CASPAR periostotomo	199
CASPAR pestoni metallici.....	184
CASPAR pinze spezzatrici per dischi intervertebrali	271-273
CASPAR specula.....	139
CASPAR trapano	136
CASPAR trapano guida	134-135
CASPAR uncini per esplorazione e coagulazione.....	228
CASPAR uncini per le radici die nervi	230
CASPAR viti di distrazione	136
Cassetta per micro clips per aneurisma	315
CASTROVIEJO forbici iridectomia.....	48
CASTROVIEJO port'aghi, micro.....	156-158, 160
CASTROVIEJO rompe lamette	15
Cesoio per ossa	174
Chiave sola	132, 309
CITELLI pinze ossivore	282
CLEVELAND pinze sgorbie	164
Clip emostatici per cuoio capelluto	217
Clips per aneurisma	284-299
Clips vascolari.....	283-315
CLOWARD divaricatore per laminectomia	125
CLOWARD divaricatore per laminectomia	148
CLOWARD lama divaricator	104
CLOWARD-HOEN divaricatore per hemilaminectomia	140
COBB fusione spinale curette	179
COBB fusione spinale sgorbie.....	190
COBB spinale elevatori	191
COLCLOUGH pinze taglienti per laminectomia	278
COLLIN dinamometro.....	2
Coltelli lanceolato per tessuto tumolare	245
Coltelli per tumori	245
Coltello	238
Coltello per trigemino.....	238
Coltello per vasi	242, 248
CONE curetta per ipofisi.....	321
CONE divaricatore per laminectomia	123
CONE trapano cranico	221
Container.....	338-339
Container, acciaio inossidabile	339
Container, alluminio	338
CONTOUR divaricatore per il cuoio capelluto.....	127
COOLEY atrauma pinza.....	78
Corpo vertebrale cervicale distrazione sistema	134-136
Costotomi.....	213
COTTLE elevatorio	204
COTTLE martello.....	193
COTTLE pinze	70
CRILE pinze emostatiche	95
CRILE uncino per nervi	227
CRILE-RANKIN pinze emostatiche	96
CRILE-WOOD port'aghi	151
CRUTCHFIELD alesatore	218
CRUTCHFIELD pinze per trazione craniale.....	218
Cucchiaio per ipofisi	324-325, 328
Curette per ipofisi	319-321, 325-327
Curette taglienti	175-182
Curette, micro	240, 250
CUSHING ganico per decompressione	105
CUSHING periostotomo	201-202
CUSHING pinze	63
CUSHING pinze emostatiche.....	96
CUSHING pinze per laminectomia	268
CUSHING pinze taglienti	267
CUSHING spatole.....	254
CUSHING trapano piatto	209
CUSHING uncino	224
CUSHING uncino per nervi	227
CUSHING-LANDOLT ipofisectomia-specolo.....	318
CUSHING-TAYLOR pinze	64
D	
DAHLGREN pinze craniotome.....	222
DANDY forbici per il nervo trigemino	44
DANDY pinze emostatiche	97
DANDY uncino per nervi.....	226
DARLING divaricatore per laminectomia	123
DAUBENSPECK curette taglienti	176
DAVIS dissectorio.....	234
De MARTEL introduttore.....	220
DEBAKEY atrauma pinza	75-81, 86
DEBAKEY forbici	41
DEBAKEY forbici del Bloodletting	25
DEBAKEY pinze bulldog	90
DEBAKEY port'aghi.....	152-153
DEBAKEY-DIETHRICH atrauma pinza.....	78
DEBAKEY-DIETHRICH pinze bulldog.....	89
DEBAKEY-GLOVER pinze bulldog	88
DECKER forbici per ipofisectomia	330
DEJERINE martello	3
D'ERRICO punta	209
DeVILBISS pinze craniotome	222
Diagnostica.....	1-4
Dialtatori vascolari.....	244
Diapason	4
DIEFFENBACH bisturi delicati	16
DIEFFENBACH pinze bulldog.....	91
DIETHRICH forbici	40
DIETHRICH pinze bulldog	89
DIMEDA divaricatore	109
DIMEDA rompe lamette	14
dinamometro.....	2
Dissector con asta flessibile.....	235
Dissectors corpo vertebrale	199
Dissettori.....	200-204, 246
Dissettori, micro	246, 249, 322, 325, 327
Distractor	134-135
Distributore lame	11
Divaricatore autostatico per il cuoio capelluto.....	127
Divaricatore cervicale.....	128-133
Divaricatore per corpi vertebrali	128-133
Divaricatori	104-107
Divaricatori autostatici	108-116, 122, 141-142
Divaricatori autostatici lombari	137-139
Divaricatori per hemilaminectomia	117-118
Divaricatori per il cervelletto	112
Divaricatori per il spinale	207
Divaricatori per laminectomia	117-127, 140, 148
Divaricatori perineale.....	107
DUEHRSSSEN pinze	67
DUNHILL pinze emostatiche	96
E	
ECHLIN pinze sgorbie.....	173
Elevatore	234
Elevatori	200-204
Elevatori per ossa	206-207
Elevatori, micro	199, 249
Enucleatore	322-323
EPSTEIN curette taglienti.....	180
Estesiometro	4
F	
FAHLBUSCH cucchiaio per ipofisi.....	325
FAHLBUSCH curetta per ipofisi.....	325
FAHLBUSCH forbici per ipofisectomia	330
FARABEUF periostotomo	196
FARABEUF-COLLIN periostotomo	196
FERGUSON tubo d'aspirazione	259
Fermagli d'argento	217
FERRIS-SMITH-CHUSHING pinze spezzatrici per dischi intervertebrali	270

Fili sega	220
FINSEN divaricatore	108
FISCH cannule per aspirazione e lavaggio.....	263
FISCH micro uncini	251
FISCH uncino	251
FOMON raspe	206
Forbice guida filo	25
Forbici	18-46
Forbici del Bloodletting.....	25
Forbici delicate per dissezione	31
Forbici iridectomia.....	48
Forbici neurochirurgiche	43-44
Forbici per bendaggi	46
Forbici per guance.....	18-21
Forbici per chirurgia, gracili	21
Forbici per dissezione	22-33
Forbici per dissezione, micro	49, 52-53
Forbici per guance	44
Forbici per il nervo trigemino.....	36, 44
Forbici per ipofisectomia	330
Forbici per preparazione di nervi	42
Forbici per strabismo	36
Forbici per tagilare fili.....	45
Forbici per tenotomia	35
Forbici per vene	54
Forbici vascolari	37-41
Forbici vascolari, micro	50, 58
Forbici, fino	31, 42, 45
Forbici, micro	48-58
Forchetta per legatura	248
Forchetta per trapianto	322
Forchette per tumori	245, 248
FRAZIER cannule per la puntura del ventricolo	261
FRAZIER elevatore.....	234
FRAZIER tubo d'aspirazione	258-261
FRAZIER uncino	224
FREER elevatorio.....	203
FREER uncino per mucosa.....	224
Fresa sferica.....	208-209
FRIEDMAN pinze sgorbie.....	164
FRIEDMAN-MINI pinze sgorbie	164
FRYKHOLM pinze sgorbie	172
Fusione spinale curette	179, 182
Fusione spinale sgorbie	190
G	
Ganico per decompressione	105
GELPI divaricatori perineale.....	107
GEMINI passafili	100
GEMINI-MINI passafili	100
GERALD (DEBAKEY) atrauma pinza	79
GERALD pinze	67
GIERTZ STILLE Costotomo	213
GIGLI fili sega.....	220
GIGLI manico con uncino	220
GILLIES pinze	65
Giunto di prolungamento	209
GLASSMAN atrauma pinza.....	79
GLOVER pinze bulldog	88
GOLDMAN-FOX forbici per guance	44
GOMEL micro forbici	49
GOMEL micro pinza	74
GORNEY forbici.....	25
GRAEFE pinza per iride	69
GRAHAM uncino per nervi.....	227
GRONINGEN uncino per nervi	228
GRUENWALD pinze	64
GRUENWALD pinze	70
Guide per legatura	241
GULEKE pinze sgorbie	167
H	
HAJEK martello.....	192
HAJEK pinze taglienti per seno sfenoidale.....	282
HAJEK-KOFLER pinze taglienti per seno sfenoidale	282
HALLE coltello	238
HALLE curette taglienti	177
HALLE elevatorio	232
HALSEY port'aghi	151
HALSTED-MOSQUITO pinze emostatiche	94
HARDY cucchiaino per ipofisi	328
HARDY curetta per ipofisi	320, 326-327

HARDY enucleatore.....	322
HARDY ipofisectomia-specolo.....	318
HARDY micro dissettorio.....	327
HARDY micro-specchio.....	328
HARDY pinze per ipofisectomia	329
HARDY pinze taglienti per laminectomia	280
HARDY-FAHLBUSCH micro dissettorio.....	322
HARTMANN pinze emostatiche	93
HARVEY-JACKSON divaricatore per laminectomia	121
HEIFETZ pinze da presa per tumori	85
HEIFETZ s p a t o l e	255
HENLY divaricatore.....	110
HESS (DEBAKEY) pinze bulldog	91
HESS (LOVE modif.) uncini per le radici die nervi.....	230
HIBBS lame.....	146
HOEN divaricatore per hemilaminectomia	140
HOEN elevatore	234
HOEN periostotomo	198
HOEN pinze per il cuoio capelluto	98
HOEN uncino per nervi	227
HORSLEY dissettorio.....	235
HOSOBUCHI cucchiaino per ipofisi	324
HOUSE adattatore per aspirazione	264
HOUSE cannule per aspirazione e lavaggio	264
HOWARTH elevatorio	203
HUDSON perforatore	209
HUNT pinze da presa per tumori.....	84-85

I

INGE divaricatore per laminectomia.....	148
Introduttore	220
IRIS forbici	34

J

JACOBS mandrino.....	210
JACOBSON coltello per vasi	248, 251
JACOBSON forchetta per legatura	248
JACOBSON micro forbici.....	55
JACOBSON pinze.....	63
JACOBSON pinze emostatiche	99
JACOBSON port'aghi, micro.....	158, 161
JACOBSON sonda abbottonata	244
JAMESON forbici per dissezione	42
JAMESON-WERBER forbici per dissezione	42
JANNETTA divaricatore.....	142
JANSEN divaricatore	109
JANSEN periostotomo.....	198
JANSEN pinze	70
JANSEN pinze sgorbie	167
JANSEN-GIFFORD divaricatore	109
JANSEN-WAGNER divaricatore	109
JEFFERSON divaricatore.....	122
JEFFERSON pinze.....	63
JOHNS HOPKINS pinze bulldog.....	91
JOSEPH forbici	31
JOSEPH periostotomo.....	198
JOSEPH uncino per mucosa	224
JULIAN port'aghi	154

K

KELLY pinze emostatiche	95
KELLY-RANKIN pinze emostatiche	95
KERRISON pinze ossivore	282
KERRISON pinze taglienti per laminectomia	274-277
KEY elevatorio.....	201
KILNER forbici	32
KIRSCHNER perforatore	211
KNIGHTON divaricatore per laminectomia	124
KOCHER-LANGENBECK divaricatore	106
KOENIG elevatorio per ossa	207
KOOS coltello per vasi	242
KRAMER periostotomo.....	196
KRAYENBUHL uncini per nervi e vasi	241

L

LAHEY uncino	224
Lama divaricator	104
LAMBOTTE osteotomo	186
LAMBOTTE periostotomo	196
Lame da bisturi, micro, sterili	13
Lame da bisturi, sterili	10-11
Lamette da rasoio	14
LANDOLT aspiratore per preparazione	263

LANDOLT curetta per ipofisi.....	324
LANDOLT enucleatore	323
LANDOLT manico per bisturi, micro	12-13
LANDOLT periostotomo	199
LANDOLT pinza divaricatrice per specoli	318
LANDOLT pinze per afferrare tumori.....	269
LANDOLT pinze per ipofisectomia	329
LANDOLT-REULEN curetta per ipofisi	325
LANDOLT-REULEN micro dissettorio.....	325
LANDOLT-REULEN micro uncini	325
LANDOLT-REULEN periostotomo	325
LANE divaricatore	104
LANE elevatorio per ossa	206
LANGE periostotomo	232
LANGENBECK elevatorio	200
LANGENBECK periostotomo.....	197, 200
LANGENBECK port'aghi	154
LAZAR pinze	73
LEBSCHE introduttore	220
LEKSELL (STILLE) pinze sgorbie.....	172
LEKSELL pinze sgorbie.....	172
LEMPERT curette taglienti	177
LEMPERT periostotomo	232
LEMPERT pinze sgorbie	167
LEMPERT tubo d'aspirazione	259
LERICHE pinze emostatiche.....	99
LEXER forbici	24
LEXER osteotomo.....	187-188
LEXER sgorbie	189
LEXER-mini osteotomo	189
LISTER forbici per bendaggi	46
LITTLE-JOKER (CUSHING) periostotomo	201
LITTLER forcice guida filo	25
LOGAN divaricatore.....	108
LOVE uncini per le radici die nervi	230-231
LOVE-GRUENWALD pinze per laminectomia	268
LOVELACE pinze emostatiche	97
LUCAE pinze.....	70
LUER pinze sgorbie	165-166
LUER tubo d'aspirazione.....	260

M

MAGILL tubo d'aspirazione	258
MALIS divaricatore	141
Manici per bisturi.....	6-9
Manici per bisturi, micro.....	12-13
Manico con mandrino Jacobs	210
Manico con uncino	220
MARKHAM-MEYERDING divaricatore per laminectomia	126
MARQUARDT pinze sgorbie	169
MARTEL pinze per il cuoio capelluto	98
Martelli	2-3, 192-195
Martelli, in plastica	193-195
MARTIN spatole	256
MARTINI curette taglienti	178
MATHIEU port'aghi.....	154
MAYFIELD pinze sgorbie	168
MAYO (HARRINGTON) forbici	22
MAYO forbici.....	22
MAYO-HEGAR port'aghi	152
MAYO-STILLE forbici.....	23
McDONALD elevatorio	203
McINDOE cesoie per ossa	174
McINDOE pinze.....	64
McKENY elevatorio	202
McKENZIE pinza per applicare agrafes	216
McKENZIE punta	209
McKISSOCK periostotomo	196
MEAD martello.....	195
MEAD pinze sgorbie.....	164
MEHDORN clips vascolari.....	306
MEHDORN pinza per applicare i clips vascolari.....	306
MEMORY pinza per applicare i clips per aneurisma	300-301
METZENBAUM forbici per dissezione.....	26
METZENBAUM-BABY forbici per dissezione	26
METZENBAUM-FINO forbici per dissezione	27-30
MEYERDING divaricatore	107
MEYERDING divaricatore per laminectomia	126
MEYERDING lame	146
Micro atrauma pinza	75-81, 86

Micro elevatori.....	199, 249
Micro forbici	48-58
Micro forbici per dissezione.....	49, 52-53
Micro forbici, leggero	56-57
Micro forbici, SuperCut	56
Micro pinza	72-86
Micro pinza, titanio	86
Micro pinze, leggero	72, 74
Micro port'aghi	155-162
Micro port'aghi, metallo leggero	161
Micro port'aghi, titanio	162
MILLESÌ micro forbici.....	54
MILLIGAN dissesttorio	233-234
MILLS forbici	37
MINI (YASARGIL) clips per aneurisma	296-295
MISKIMON divaricatore.....	113
MIXTER-BABY pinze emostatiche.....	101
MOLLISON divaricatore	122
MOLT periostotomo.....	204
MOYNIHAN pinze emostatiche	97
MÜLLER approssimatori	308
MÜLLER clips vascolari	310
N	
NAGEL micro forbici.....	51
NEIVERT port'aghi	151
NICOLA curretta per ipofisi.....	320-321
NICOLA forbici per ipofisectomia.....	330
NICOLA periostotomo	321
NICOLA pinze per ipofisectomia.....	330
NIEDERDELLMANN osteotomo	187
NORFOLK-NORWICH divaricatore per laminectomia	123
NORTHFIELD pinze sgorbie	168
O	
O'CONNELL uncini per le radici die nervi	225
OBWEGESER osteotomo	187
OKONEK-YASARGIL forchette per tumori	248
OLDBERG divaricatore	105
OLDBERG pinze taglienti.....	269
OLIVECRONA coltello per trigemino.....	238
OLIVECRONA fili sega.....	220
OLIVECRONA forbici per il nervo trigemino	36
OLIVECRONA pinze sgorbie	166
OLIVECRONA spatole	254
OLIVECRONA-TOENNIS pinza per applicare agrafes.....	216
Osteotomi	183-189
P	
PAPAVERO scalpello per lamina	318
PAPAVERO-CASPAR ipofisectomia-specolo	318
PARKER bisturi delicati.....	16
PARTSCH periostotomo.....	232
Passafili	100
PENFIELD dissesttorio	236-237
PENNYBACKER pinze taglienti	266
PENNYBAKER pinze sgorbie	168
PENNYBAKER sonda e dissesttorio	234
Perforatori a mano	208-210
Periostotomi.....	196-204, 232
Periostotomi per lembo osseo.....	232
Pestoni metallici.....	184
Pinza di orologio.....	68
Pinza divaricatrice per specoli	318
Pinza per applicare agrafes.....	215-216
Pinza per applicare e rimuovere clamps.....	91
Pinza per applicare i clips per aneurisma	300-304
Pinza per applicare i clips vascolari	305-309, 314
Pinza per dissezione	60-61
Pinza per iride	69
Pinza tagliafilari	212
Pinze	60-86
Pinze bulldog	88-92
Pinze bulldog, micro	92
Pinze craniotome	222
Pinze da presa per tumori.....	83-85, 269
Pinze emostatiche	93-101
Pinze etmoidali.....	281
Pinze ossivore	282
Pinze per annodare fili, micro	72-75, 86
Pinze per coagulazione, bipolari	332-336
Pinze per il cuoio capelluto	98
Pinze per ipofisectomia	329-330
Pinze per la protezione di foro.....	221
Pinze per laminectomia	268
Pinze per legatura	82
Pinze per trazione craniale.....	218
Pinze sgorbie	164-173
Pinze sgorbie	164-173
Pinze spezzatrici per dischi intervertebrali.....	270-273
Pinze taglienti.....	265-282
Pinze taglienti per il naso	281
Pinze taglienti per laminectomia	274-280
Pinze taglienti per seno sfenoidale	282
Pinze, mikro	72-86
PLESTER tubo d'aspirazione	260
Port'aghi	150-162
Port'aghi, micro	155-162
POTTS-DE MARTEL forbici.....	37
POTTS-SMITH forbici	37-39
POTTS-SMITH pinze	60
POTTS-YASARGIL micro forbici	54
PROVIDENCE-HOSPITAL pinze emostatiche	96
Punta.....	209
Punta a spirale	208-209, 211
Puntura del ventricolo, cannule	261
Q	
QUERVAIN elevatorio	200
R	
RABINER martello	3
RAGNELL forbici.....	31
RAGNELL-DAVIS divaricatore	104
RAIMONDI pinze per il cuoio capelluto	98
RALK perforatore	210
RANEY clip emostatici per cuoio capelluto	217
RANEY pinza per applicare agrafes.....	217
Raspe.....	206
Raspi.....	240, 243, 321, 325
RAY curretta per ipofisi.....	319
Regolo, metallo	4
REILL pinza tagliafilari	212
REYNOLDS forbici	33
RHOTON ago.....	250
RHOTON micro curretta	250
RHOTON micro dissesttorio	249
RHOTON micro elevatorio	249
RHOTON micro uncini	250
RHOTON sonda abbottonata.....	250
RIBBON spatole	256
Rompe lamette.....	14-15
Rongeur, potente	271
RUSKIN pinze sgorbie	169
RUSKIN-LISTON cesoie per ossa	174
RYDER (VASCULAR) port'aghi	153
RYDER port'aghi	153
S	
SACHS dissesttorio.....	233, 235
SACHS uncino per nervi	227
SAMII coltelli per tumori	245
SAMII pinze da presa per tumori	83
SANVENERO forbici.....	31
SATINSKY pinze bulldog	88
SAUERBRUCH Costotomo	213
SAUERBRUCH pinze sgorbie	171
Scalpellini	185
Scalpello per lamina	318
SCHLESINGER pinze taglienti per laminectomia	279
SCHLESINGER pinze taglienti	266
SCHMIEDEN-TAYLOR forbici	44
SCHNEIDER periostotomo.....	201
SCHNEIDER-SAUERBRUCH periostotomo.....	201
SCHUHKNIGHT tubo d'aspirazione.....	264
SCOVILLE curretta taglienti.....	176
SCOVILLE divaricatore per laminectomia	143-146
SCOVILLE lame	146
SCOVILLE spatole.....	254
SCOVILLE uncini per le radici die nervi.....	225
SCOVILLE uncino per nervi e dissesttor.....	229
SCOVILLE-HAVERFIELD divaricatore per laminectomia	144
SCOVILLE-RICHTER divaricatore per laminectomia	147
SEBILAU elevatorio	200
SEDILLOT periostotomo.....	197
SELDIN periostotomo.....	204
SEMB pinze sgorbie	173
SEMKEN pinze.....	64-65
SEWALL elevatorio	202
Sgorbie	183, 188-190
Sgorbie per la colonna vertebrale	188
Sgorbie per l'adozione di innesti dalla costola.....	183
Sgorbie per le operazioni di scoliosi	188
SIMON curretta taglienti.....	176
SMITH-PETERSEN pinze sgorbie	173
SMITHWICK pinza per applicare agrafes	216
SMITHWICK uncino per nervi	229
sonda e dissesttorio.....	234
Sonda abbottonata	244, 250
Sopperto per ottica.....	336
spatole	254-256
Specchio	328
Specolo per ipofisectomia transfenoidale	318
specula per operazioni vertebrale lombare.....	139
Spinale elevatori.....	191
SPURLING pinze per laminectomia	268
ST. CLAIR-THOMPSON periostotomo	232
STANDARD (YASARGIL) clips per aneurisma.....	284-295
STEINBACH martello.....	193
STELLBRINK pinze sgorbie	165
Sterilizzazione dei casi	339
STEVENS forbici per tenotomia	35
STILLE osteotomo	185
STILLE perforatore	208
STILLE RUSKIN pinze sgorbie	171
STILLE scalpelli	185
STILLE sgorbie	185
LISTON-KEY-HORSLEY cesoie per ossa.....	174
STILLE-LUER pinze sgorbie	170-171
STILLE-SHERMANN perforatore	208
STRULLY forbici per il nervo trigemino	43
Strumenti per craniotome	215-222
Strumenti per ipofisectomia	317-330
SUNDAY elevatorio	232
Supporto metallico, clips	217
SWEET forbici per ipofisectomia	330
SWEET pinza per applicare agrafes.....	216
Synovectomy pinze sgorbie	165, 168
SYPERT pestoni metallici	184
SYPERT pinze taglienti per laminectomia	280
T	
TAKAHASHI pinze etmoidali	281
TAYLOR divaricatori per il spinale.....	207
TAYLOR lame	146
TAYLOR martello	2
TAYLOR pinze	66
TAYLOR-CUSHING pinze	64
TERRIER pinze emostatiche.....	93
TOENNIS coltello	238
TOENNIS dissesttorio	233
TOENNIS port'aghi	154
TOENNIS uncino	224
TOENNIS-ADSON forbici neurochirurgiche	43
TOLEDO micro forbici	57
TOLEDO micro pinza	75
TOLEDO micro-forbici vascolari.....	50
TOLEDO port'aghi, micro	159
Trapano.....	136
Trapano	208-209
Trapano cranico	221
Trapano guida	134-135
TRAUBE martello	2
TROEMNER martello	2
TROTTER pinze sgorbie	168
TROUTMAN-CHRIS rompe lamette.....	14
Tubi d'aspirazione	257-264

U

ULTRA-LIGHT atrauma pinza	81
Uncini	224, 228, 251
Uncini per esplorazione e coagulazione	228
Uncini per la pelle	224
Uncini per le radici die nervi.....	225-231
Uncini per mucosa.....	224
Uncini per nervi	226-229, 233-235
Uncini per nervi e dissectori	229
Uncini per nervi e vasi	241
Uncini, micro.....	248-251
Uncino per galea	219
UNIVERSAL forbici per bendaggi	46
UNIVERSAL forbici per tagliare fili.....	45

V

VALIN divaricatore per laminectomia	145
VANNAS forbici iridectomia	48
VANNAS micro forbici	49, 53-55
VERHOEVEN micro cannule	264
VertebroscoPIO	336
WISE micro pinza	73
Viti di distrazione	136
VOLKMANN curetta doppia taglienti.....	178
VOLKMANN curette taglienti	175, 178-179
WAGNER forbici.....	45
WAGNER martello	192
WAGNER pinze spezzatrici per dischi intervertebrali	271
WALTER sgorbie	183
WALTON divaricatore per laminectomia	124
WANGENSTEEN pinze	67
WARTENBERG algesimetro.....	4
WATSON-CHEYNE dissectorio	203
WAUGH pinze.....	65
WEBER estesimetro	4
WEIL-BLAKESLEY pinze taglienti per il naso ..	281
WEITLANER divaricatore	110-113
WHEELER (DEBAKEY) atrauma pinza.....	79
WILLET-MARTEL pinze per il cuoio capelluto ...	98
WILLIAMS divaricatori per laminectomia	127
WILLIGER curette taglienti	178
WILLIGER elevatorio.....	202
WILLIGER martello	193-194
WILLIGER periostotomo	198

Y

YANKAUER tubo d'aspirazione.....	258
YASARGIL arachnoidea coltelli.....	242
YASARGIL cannule per aspirazione e lavaggio	263
YASARGIL clips per aneurisma	284-299
YASARGIL clips per la chiusura permanente	284-286, 290 292, 294, 296-297
YASARGIL clips per la chiusura temporaneo	287-289, 291 293, 295, 298-299
YASARGIL curette	240
YASARGIL dissector con asta flessibile	235
YASARGIL forchette per tumori	245
YASARGIL guide per legatura	241
YASARGIL micro forbici	52-54
YASARGIL micro forbici per dissezione.....	52-53
YASARGIL micro pinza	82-83
YASARGIL pinze da presa per tumori	83, 85
YASARGIL pinze taglienti.....	269
YASARGIL port'aghi, micro	160
YASARGIL raspino	240, 243
YASARGIL tubo d'aspirazione	258
YASARGIL uncino per galea	219
YASARGIL-NICOLA pinze per ipofisectomia	330

Z

ZAUFAL-JANSEN pinze sgorbie.....	168
ZIELKE sgorbie	188
ZOELLNER micro cannule	262
ZOELLNER tubo d'aspirazione	262

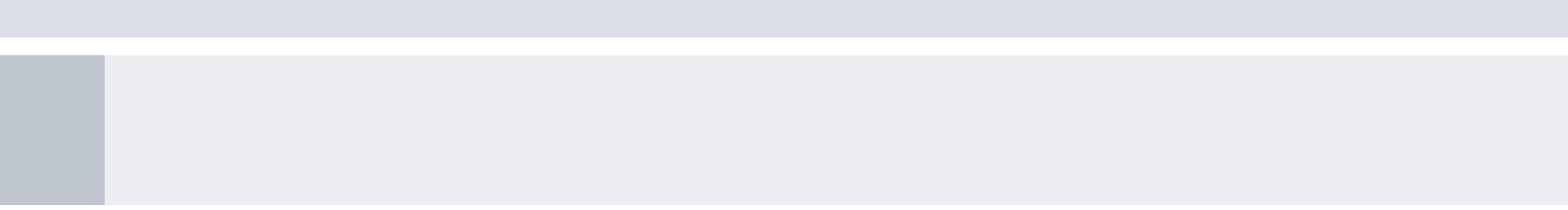

22

◆ NUMMERNVERZEICHNIS

NUMERICAL INDEX

INDEX NUMÉRIQUE

ÍNDICE NUMÉRICO

INDICE NUMERICO

02

02.140.01.....	2
02.140.02.....	2
02.288.17.....	2
02.288.20.....	2
02.288.29.....	2
02.288.30.....	2
02.290.16.....	2
02.290.99.....	2
02.292.22.....	2
02.292.99.....	2
02.294.24.....	2
02.294.99.....	2
02.296.23.....	3
02.302.20.....	3
02.304.20.....	3
02.304.99.....	3
02.306.17.....	3
02.306.20.....	3
02.308.18.....	3
02.308.97.....	3
02.308.98.....	3
02.308.99.....	3
02.318.00.....	4
02.320.09.....	4
02.320.19.....	4
02.340.10.....	4
02.340.15.....	4
02.340.20.....	4
02.340.25.....	4
02.340.30.....	4
02.340.40.....	4
02.340.50.....	4

04

04.148.27.....	258
04.149.27.....	258
04.155.30.....	258
04.155.35.....	258
04.155.40.....	258
04.155.99.....	258

06

06.103.00.....	6
06.103.01.....	6
06.103.02.....	6
06.103.03.....	6
06.103.06.....	6
06.103.33.....	6
06.104.00.....	9
06.104.01.....	9
06.104.02.....	9
06.104.06.....	9
06.105.00.....	7
06.106.00.....	7
06.106.01.....	7
06.107.00.....	8
06.107.01.....	8
06.107.02.....	8
06.109.00.....	8
06.110.00.....	10
06.111.00.....	10
06.112.00.....	10
06.115.00.....	10
06.120.00.....	11
06.121.00.....	11
06.122.00.....	11
06.123.00.....	11
06.124.00.....	11
06.199.00.....	11
06.290.09.....	14
06.291.09.....	14
06.291.11.....	14
06.292.18.....	15
06.294.13.....	15
06.296.00.....	14
06.302.13.....	12
06.304.15.....	12
06.306.18.....	12
06.308.20.....	12
06.404.01.....	16
06.404.02.....	16
06.404.03.....	16
06.404.07.....	16
06.404.08.....	16

06.404.09.....	16
06.408.01.....	16
06.408.02.....	16

07

07.102.10.....	18
07.102.11.....	18
07.102.13.....	18
07.102.14.....	18
07.102.15.....	18
07.102.16.....	18
07.102.18.....	18
07.102.20.....	18
07.103.10.....	18
07.103.11.....	18
07.103.13.....	18
07.103.14.....	18
07.103.15.....	18
07.103.16.....	18
07.103.18.....	18
07.103.20.....	18
07.104.14.....	18
07.104.16.....	18
07.105.14.....	18
07.105.16.....	18
07.110.11.....	19
07.110.13.....	19
07.110.14.....	19
07.110.15.....	19
07.110.16.....	19
07.110.18.....	19
07.110.20.....	19
07.111.11.....	19
07.111.13.....	19
07.111.14.....	19
07.111.15.....	19
07.111.16.....	19
07.111.18.....	19
07.111.20.....	19
07.114.14.....	19
07.114.16.....	19
07.115.14.....	19
07.115.16.....	19
07.120.10.....	20
07.120.11.....	20
07.120.13.....	20
07.120.14.....	20
07.120.15.....	20
07.120.16.....	20
07.120.18.....	20
07.120.20.....	20
07.121.10.....	20
07.121.11.....	20
07.121.13.....	20
07.121.14.....	20
07.121.15.....	20
07.121.16.....	20
07.121.18.....	20
07.121.20.....	20
07.124.14.....	20
07.124.16.....	20
07.125.14.....	20
07.125.16.....	20
07.160.14.....	22
07.160.17.....	22
07.160.23.....	22
07.161.14.....	22
07.161.17.....	22
07.161.23.....	22
07.164.14.....	22
07.164.17.....	22
07.164.23.....	22
07.165.14.....	22
07.165.17.....	22
07.165.23.....	22
07.190.16.....	24
07.190.21.....	24
07.191.16.....	24
07.191.21.....	24
07.194.16.....	24
07.194.21.....	24
07.195.16.....	24
07.195.21.....	24
07.280.11.....	26
07.280.15.....	26

07.280.18.....	26
07.280.20.....	26
07.280.23.....	26
07.280.25.....	26
07.280.28.....	26
07.280.30.....	26
07.281.11.....	26
07.281.15.....	26
07.281.18.....	26
07.281.20.....	26
07.281.23.....	26
07.281.25.....	26
07.281.28.....	26
07.281.30.....	26
07.282.15.....	28
07.282.18.....	28
07.282.20.....	28
07.282.23.....	28
07.282.25.....	28
07.282.28.....	28
07.283.15.....	28
07.283.18.....	28
07.283.20.....	28
07.283.23.....	28
07.283.25.....	28
07.283.28.....	28
07.284.11.....	26
07.284.15.....	26
07.284.18.....	26
07.284.20.....	26
07.284.23.....	26
07.284.25.....	26
07.284.28.....	26
07.284.30.....	26
07.285.11.....	26
07.285.15.....	26
07.285.18.....	26
07.285.20.....	26
07.285.23.....	26
07.285.25.....	26
07.285.28.....	26
07.285.30.....	26
07.286.15.....	28
07.286.18.....	28
07.286.20.....	28
07.286.23.....	28
07.286.25.....	28
07.286.28.....	28
07.287.15.....	28
07.287.18.....	28
07.287.20.....	28
07.287.23.....	28
07.287.28.....	28
07.310.12.....	32
07.310.15.....	32
07.314.12.....	32
07.314.15.....	32
07.480.25.....	39
07.480.40.....	39
07.480.60.....	39
07.484.25.....	39
07.484.40.....	39
07.484.60.....	39

08

08.102.10.....	18
08.102.11.....	18
08.102.13.....	18
08.102.14.....	18
08.102.15.....	18
08.102.16.....	18
08.102.18.....	18
08.102.20.....	18
08.103.10.....	18
08.103.11.....	18
08.103.13.....	18
08.103.14.....	18
08.103.15.....	18
08.103.16.....	18
08.103.18.....	18
08.103.20.....	18
08.104.14.....	18
08.104.16.....	18
08.104.18.....	18
08.105.14.....	18

08.105.16.....	18
08.105.18.....	18
08.110.10.....	19
08.110.11.....	19
08.110.13.....	19
08.110.14.....	19
08.110.15.....	19
08.110.16.....	19
08.110.18.....	19
08.110.20.....	19
08.111.10.....	19
08.111.11.....	19
08.111.13.....	19
08.111.14.....	19
08.111.15.....	19
08.111.16.....	19
08.111.18.....	19
08.111.20.....	19
08.114.14.....	19
08.114.16.....	19
08.114.18.....	19
08.115.14.....	19
08.115.16.....	19
08.115.18.....	19
08.120.10.....	20
08.120.11.....	20
08.120.13.....	20
08.120.14.....	20
08.120.15.....	20
08.120.16.....	20
08.120.18.....	20
08.120.20.....	20
08.121.10.....	20
08.121.11.....	20
08.121.13.....	20
08.121.14.....	20
08.121.15.....	20
08.121.16.....	20
08.121.18.....	20
08.121.20.....	20
08.122.01.....	21
08.122.02.....	21
08.122.03.....	21
08.123.01.....	21
08.123.02.....	21
08.123.03.....	21
08.124.14.....	20
08.124.16.....	20
08.124.18.....	20
08.125.14.....	20
08.125.16.....	20
08.125.18.....	20
08.160.14.....	22
08.160.15.....	22
08.160.17.....	22
08.160.19.....	22
08.160.23.....	22
08.160.28.....	22
08.161.14.....	22
08.161.15.....	22
08.161.17.....	22
08.161.19.....	22
08.161.23.....	22
08.161.28.....	22
08.164.14.....	22
08.164.17.....	22
08.164.23.....	22
08.165.14.....	22
08.165.17.....	22
08.165.23.....	22
08.170.15.....	23
08.170.17.....	23
08.171.15.....	23
08.171.17.....	23
08.174.15.....	23
08.174.17.....	23
08.175.15.....	23
08.175.17.....	23
08.190.16.....	24
08.190.21.....	24
08.191.16.....	24
08.191.21.....	24
08.194.16.....	24
08.194.21.....	24
08.195.16.....	24

08.195.21.....	24
08.205.12.....	25
08.205.14.....	25
08.210.11.....	26
08.210.15.....	26
08.211.11.....	26
08.211.15.....	26
08.212.12.....	25
08.212.19.....	25
08.213.19.....	25
08.215.17.....	25
08.280.14.....	26
08.280.15.....	26
08.280.18.....	26
08.280.20.....	26
08.280.23.....	26
08.280.25.....	26
08.280.28.....	26
08.280.30.....	26
08.281.14.....	26
08.281.15.....	26
08.281.18.....	26
08.281.20.....	26
08.281.23.....	26
08.281.25.....	26
08.281.28.....	26
08.281.30.....	26
08.282.15.....	27
08.282.18.....	27
08.282.20.....	27
08.282.23.....	27
08.282.25.....	27
08.282.28.....	27
08.283.15.....	27
08.283.18.....	27
08.283.20.....	27
08.283.23.....	27
08.283.25.....	27
08.283.28.....	27
08.284.11.....	26
08.284.15.....	26
08.284.18.....	26
08.284.20.....	26
08.284.23.....	26
08.284.25.....	26
08.284.28.....	26
08.284.30.....	26
08.285.11.....	26
08.285.15.....	26
08.285.18.....	26
08.285.20.....	26
08.285.23.....	26
08.285.25.....	26
08.285.28.....	26
08.285.30.....	26
08.286.15.....	27
08.286.18.....	27
08.286.20.....	27
08.286.23.....	27
08.286.25.....	27
08.286.28.....	27
08.287.15.....	27
08.287.18.....	27
08.287.20.....	27
08.287.23.....	27
08.287.25.....	27
08.287.28.....	27
08.292.14.....	29
08.292.18.....	29
08.292.20.....	29
08.292.23.....	29
08.293.14.....	29
08.293.18.....	29
08.293.20.....	29
08.293.23.....	29
08.296.14.....	30
08.296.18.....	30
08.296.20.....	30
08.296.23.....	30
08.297.14.....	30
08.297.18.....	30
08.297.20.....	30
08.297.23.....	30
08.300.11.....	31
08.301.11.....	31

10.570.15.....	86	11.302.16.....	76	11.430.18.....	79	12.031.50.....	310	12.079.14.....	89
10.570.18.....	86	11.302.20.....	76	11.456.24.....	79	12.031.80.....	310	12.079.20.....	89
10.570.21.....	86	11.302.24.....	76	11.462.15.....	79	12.033.50.....	310	12.082.08.....	89
10.570.23.....	86	11.304.16.....	77	11.462.24.....	79	12.033.80.....	310	12.082.12.....	89
10.571.15.....	86	11.304.20.....	77	11.502.03.....	83	12.035.50.....	310	12.082.16.....	89
10.571.18.....	86	11.304.24.....	77	11.502.04.....	83	12.035.80.....	310	12.083.08.....	89
10.571.21.....	86	11.304.30.....	77	11.502.05.....	83	12.037.50.....	310	12.083.12.....	89
10.571.23.....	86	11.306.16.....	77	11.503.03.....	83	12.037.80.....	310	12.083.16.....	89
10.574.15.....	86	11.306.20.....	77	11.503.04.....	83	12.040.01.....	305	12.091.23.....	91
10.574.18.....	86	11.306.24.....	77	11.503.05.....	83	12.040.02.....	305	12.092.07.....	90
10.574.21.....	86	11.306.30.....	77	11.504.01.....	81	12.040.03.....	305	12.092.08.....	90
10.574.23.....	86	11.308.16.....	77	11.504.02.....	81	12.041.00.....	309	12.092.10.....	90
10.576.15.....	86	11.308.20.....	77	11.504.03.....	81	12.041.01.....	309	12.092.12.....	90
10.576.18.....	86	11.308.24.....	77	11.505.19.....	82	12.041.02.....	309	12.093.07.....	90
10.576.21.....	86	11.308.30.....	77	11.506.16.....	82	12.043.01.....	306	12.093.08.....	90
10.576.23.....	86	11.309.16.....	78	11.506.18.....	82	12.043.02.....	306	12.093.10.....	90
10.589.15.....	86	11.309.20.....	78	11.506.20.....	82	12.043.03.....	306	12.093.12.....	90
10.589.18.....	86	11.309.24.....	78	11.506.22.....	82	12.043.04.....	306	12.102.04.....	91
10.589.21.....	86	11.309.30.....	78	11.506.24.....	82	12.044.14.....	309	12.102.05.....	91
10.818.14.....	69	11.310.16.....	77	11.509.16.....	82	12.046.14.....	305	12.103.04.....	91
10.820.14.....	69	11.310.20.....	77	11.509.18.....	82	12.046.14.....	307	12.103.05.....	91
		11.310.24.....	77	11.509.20.....	82	12.046.14.....	308	12.104.06.....	91
		11.310.30.....	77	11.509.22.....	82	12.048.14.....	305	12.105.06.....	91
		11.310.35.....	77	11.509.24.....	82	12.048.14.....	307	12.110.50.....	91
		11.310.40.....	77	11.510.18.....	82	12.048.14.....	308	12.110.55.....	91
		11.314.16.....	78	11.513.22.....	83	12.050.14.....	309	12.110.65.....	91
		11.314.20.....	78	11.513.24.....	83	12.050.15.....	306	12.110.70.....	91
		11.314.24.....	78	11.515.22.....	83	12.052.01.....	312	12.110.75.....	91
		11.315.15.....	78	11.515.24.....	83	12.052.02.....	312	12.110.90.....	91
		11.315.19.....	78	11.517.24.....	83	12.052.03.....	312	12.111.50.....	91
		11.315.24.....	78	11.521.22.....	83	12.052.04.....	312	12.111.55.....	91
		11.316.16.....	78	11.522.22.....	83	12.052.05.....	312	12.111.65.....	91
		11.316.20.....	78	11.523.20.....	85	12.052.11.....	312	12.111.70.....	91
		11.316.24.....	78	11.523.22.....	83	12.052.12.....	312	12.111.75.....	91
		11.318.12.....	79	11.524.22.....	84	12.052.13.....	312	12.111.90.....	91
		11.318.15.....	79	11.525.22.....	83	12.052.14.....	312	12.112.20.....	91
		11.322.16.....	77	11.527.22.....	84	12.052.15.....	312	12.112.30.....	91
		11.322.20.....	77	11.529.20.....	84	12.052.21.....	312	12.132.30.....	92
		11.322.24.....	77	11.531.20.....	85	12.052.22.....	312	12.132.35.....	92
		11.322.30.....	77	11.533.22.....	85	12.052.23.....	312	12.132.40.....	92
		11.324.15.....	77	11.535.22.....	85	12.052.31.....	312	12.132.50.....	92
		11.324.20.....	77	11.578.15.....	86	12.052.32.....	312	12.133.30.....	92
		11.324.24.....	77	11.578.18.....	86	12.052.33.....	312	12.133.35.....	92
		11.324.30.....	77	11.579.15.....	86	12.052.41.....	313	12.133.40.....	92
		11.332.15.....	77	11.579.18.....	86	12.052.42.....	313	12.133.50.....	92
		11.332.20.....	77	11.580.15.....	86	12.052.43.....	313	12.135.30.....	92
		11.332.24.....	77	11.580.18.....	86	12.052.44.....	313	12.135.35.....	92
		11.332.30.....	77	11.580.21.....	86	12.052.45.....	313	12.135.40.....	92
		11.333.15.....	78	11.581.15.....	86	12.052.51.....	313	12.135.50.....	92
		11.333.20.....	78	11.581.18.....	86	12.052.52.....	313	12.142.30.....	92
		11.333.24.....	78	11.581.21.....	86	12.052.53.....	313	12.142.35.....	92
		11.333.30.....	78	11.582.15.....	86	12.052.54.....	313	12.142.40.....	92
		11.334.15.....	77	11.582.18.....	86	12.052.55.....	313	12.142.50.....	92
		11.334.20.....	77	11.583.15.....	86	12.052.61.....	313	12.143.30.....	92
		11.334.24.....	77	11.583.18.....	86	12.052.62.....	313	12.143.35.....	92
		11.334.30.....	77	11.584.15.....	86	12.052.63.....	313	12.143.40.....	92
		11.334.35.....	77	11.584.18.....	86	12.052.71.....	313	12.143.50.....	92
		11.402.15.....	80	11.584.21.....	86	12.052.72.....	313	12.145.30.....	92
		11.402.20.....	80	11.585.15.....	86	12.052.73.....	313	12.145.35.....	92
		11.402.24.....	80	11.585.18.....	86	12.052.81.....	313	12.145.40.....	92
		11.404.15.....	80	11.585.21.....	86	12.052.82.....	313	12.145.50.....	92
		11.404.19.....	80	11.586.15.....	86	12.052.83.....	313	12.206.08.....	93
		11.404.24.....	80	11.586.18.....	86	12.052.91.....	313	12.208.08.....	93
		11.412.15.....	80	11.586.21.....	86	12.052.92.....	313	12.210.09.....	93
		11.412.19.....	80	11.588.15.....	86	12.052.93.....	313	12.210.10.....	93
		11.412.24.....	80	11.588.18.....	86	12.053.00.....	314	12.211.09.....	93
		11.414.15.....	80	11.588.21.....	86	12.053.01.....	314	12.211.10.....	93
		11.414.19.....	80	11.590.15.....	86	12.053.02.....	314	12.212.09.....	93
		11.414.24.....	80	11.590.18.....	86	12.053.10.....	314	12.212.10.....	93
		11.416.15.....	80	11.590.21.....	86	12.053.11.....	314	12.213.09.....	93
		11.416.19.....	80			12.053.12.....	314	12.213.10.....	93
		11.416.24.....	80			12.059.07.....	88	12.220.12.....	94
		11.422.15.....	80	12.010.00.....	307	12.061.09.....	88	12.220.14.....	94
		11.422.19.....	80	12.011.00.....	307	12.063.10.....	88	12.221.12.....	94
		11.422.24.....	80	12.012.00.....	307	12.065.06.....	88	12.221.14.....	94
		11.424.15.....	80	12.013.00.....	307	12.070.35.....	88	12.222.10.....	94
		11.424.19.....	80	12.014.00.....	307	12.070.45.....	88	12.222.12.....	94
		11.424.24.....	80	12.016.00.....	309	12.070.50.....	88	12.223.10.....	94
		11.426.15.....	80	12.024.00.....	309	12.071.35.....	88	12.223.12.....	94
		11.426.19.....	80	12.028.01.....	308	12.071.45.....	88	12.224.12.....	94
		11.426.24.....	80	12.028.02.....	308	12.071.50.....	88	12.225.12.....	94
		11.428.15.....	81	12.028.03.....	308	12.078.10.....	89	12.230.12.....	94
		11.428.20.....	81	12.028.04.....	308	12.078.14.....	89	12.230.14.....	94
		11.428.24.....	81	12.030.50.....	310	12.078.20.....	89	12.231.12.....	94
		11.428.30.....	81	12.030.80.....	310	12.079.10.....	89	12.231.14.....	94

12

12.232.10.....	94	18.168.24.....	256	18.671.25.....	112	18.718.40.....	131	18.738.40.....	137
12.232.12.....	94	18.168.25.....	256	18.671.26.....	112	18.718.45.....	131	18.738.45.....	137
12.233.10.....	94	18.170.13.....	256	18.672.13.....	110	18.718.50.....	131	18.738.50.....	137
12.233.12.....	94	18.170.19.....	256	18.672.16.....	113	18.718.55.....	131	18.738.55.....	137
12.234.12.....	94	18.170.25.....	256	18.676.22.....	113	18.718.60.....	130	18.738.60.....	137
12.235.12.....	94	18.170.30.....	256	18.678.20.....	113	18.718.60.....	131	18.738.65.....	137
12.240.14.....	95	18.170.32.....	256	18.679.20.....	113	18.719.40.....	130	18.738.75.....	137
12.241.14.....	95	18.170.40.....	256	18.680.19.....	113	18.719.40.....	131	18.738.85.....	137
12.242.16.....	95	18.170.45.....	256	18.681.19.....	113	18.719.40.....	137	18.739.35.....	137
12.243.16.....	95	18.170.50.....	256	18.682.25.....	114	18.719.45.....	131	18.739.40.....	137
12.244.14.....	95	18.170.64.....	256	18.682.26.....	114	18.719.50.....	131	18.739.45.....	137
12.245.14.....	95	18.170.75.....	256	18.682.27.....	114	18.719.55.....	131	18.739.50.....	137
12.250.14.....	95	18.173.06.....	256	18.683.26.....	114	18.719.60.....	130	18.739.55.....	137
12.251.14.....	95	18.173.09.....	256	18.683.27.....	114	18.719.60.....	131	18.739.60.....	137
12.252.14.....	95	18.173.13.....	256	18.684.13.....	115	18.719.60.....	137	18.739.65.....	137
12.253.14.....	95	18.173.16.....	256	18.684.16.....	115	18.720.00.....	128	18.739.70.....	137
12.254.14.....	95	18.173.19.....	256	18.684.20.....	115	18.720.15.....	128	18.744.00.....	138
12.255.14.....	95	18.173.25.....	256	18.684.26.....	115	18.721.00.....	128	18.744.17.....	138
12.260.14.....	95	18.206.13.....	224	18.685.13.....	115	18.721.15.....	128	18.745.40.....	138
12.261.14.....	95	18.213.13.....	224	18.685.16.....	115	18.722.11.....	131	18.745.45.....	138
12.262.16.....	96	18.213.14.....	224	18.685.20.....	115	18.723.00.....	130	18.745.50.....	138
12.263.16.....	96	18.214.13.....	224	18.685.24.....	115	18.723.12.....	130	18.745.55.....	138
12.264.16.....	96	18.214.18.....	224	18.685.26.....	115	18.724.00.....	129	18.745.60.....	138
12.265.16.....	96	18.215.13.....	224	18.686.32.....	116	18.724.11.....	129	18.745.65.....	138
12.270.14.....	96	18.215.18.....	224	18.686.33.....	116	18.725.00.....	129	18.745.70.....	138
12.271.14.....	96	18.216.01.....	224	18.687.27.....	117	18.725.11.....	129	18.748.40.....	139
12.274.14.....	96	18.216.02.....	224	18.688.27.....	118	18.725.14.....	127	18.748.45.....	139
12.275.14.....	96	18.216.05.....	224	18.689.27.....	118	18.726.50.....	131	18.748.50.....	139
12.276.13.....	96	18.216.07.....	224	18.690.31.....	119	18.726.60.....	131	18.748.55.....	139
12.277.13.....	96	18.216.10.....	224	18.691.31.....	119	18.727.14.....	127	18.748.60.....	139
12.278.14.....	97	18.218.15.....	224	18.692.00.....	120	18.730.00.....	132	18.748.65.....	139
12.279.14.....	97	18.219.15.....	224	18.692.01.....	120	18.730.15.....	132	18.748.75.....	139
12.279.15.....	97	18.234.20.....	105	18.692.02.....	120	18.731.00.....	132	18.748.85.....	139
12.285.14.....	96	18.235.00.....	105	18.692.03.....	120	18.731.14.....	132	18.751.24.....	140
12.286.14.....	96	18.235.03.....	105	18.692.28.....	121	18.731.50.....	132	18.751.25.....	140
12.287.14.....	96	18.235.04.....	105	18.692.32.....	121	18.731.50.....	133	18.751.31.....	140
12.345.12.....	97	18.235.06.....	105	18.693.13.....	122	18.731.70.....	133	18.751.32.....	140
12.345.14.....	97	18.242.14.....	104	18.693.15.....	122	18.731.99.....	132	18.753.26.....	140
12.346.13.....	98	18.342.01.....	106	18.693.16.....	122	18.732.35.....	133	18.753.27.....	140
12.347.14.....	97	18.342.02.....	106	18.694.13.....	123	18.732.40.....	132	18.753.30.....	140
12.348.14.....	98	18.342.03.....	106	18.694.16.....	123	18.732.40.....	133	18.753.32.....	140
12.354.15.....	97	18.342.04.....	106	18.694.20.....	123	18.732.45.....	133	18.753.34.....	140
12.356.15.....	97	18.342.05.....	106	18.694.25.....	123	18.732.50.....	133	18.753.36.....	140
12.364.14.....	98	18.342.06.....	106	18.695.13.....	123	18.732.55.....	133	18.802.09.....	107
12.366.19.....	98	18.342.07.....	106	18.695.16.....	123	18.732.60.....	132	18.802.11.....	107
12.380.15.....	99	18.342.08.....	106	18.695.20.....	123	18.732.60.....	133	18.802.14.....	107
12.381.15.....	99	18.342.09.....	106	18.696.18.....	123	18.732.65.....	133	18.802.16.....	107
12.382.15.....	99	18.498.01.....	107	18.698.18.....	123	18.732.70.....	133	18.802.18.....	107
12.383.15.....	99	18.498.02.....	107	18.699.14.....	122	18.733.35.....	133	18.803.18.....	107
12.415.14.....	99	18.498.03.....	107	18.699.15.....	122	18.733.40.....	133	18.860.19.....	141
12.415.18.....	99	18.610.05.....	108	18.699.22.....	123	18.733.45.....	133	18.861.00.....	141
12.416.12.....	99	18.610.07.....	108	18.707.01.....	124	18.733.50.....	133	18.861.01.....	141
12.416.18.....	99	18.611.05.....	108	18.707.02.....	124	18.733.55.....	133	18.861.02.....	141
12.417.12.....	99	18.611.07.....	108	18.708.01.....	124	18.733.60.....	133	18.862.09.....	141
12.417.18.....	99	18.612.04.....	108	18.708.02.....	124	18.733.65.....	133	18.862.12.....	141
12.419.18.....	99	18.613.07.....	108	18.710.00.....	125	18.733.70.....	133	18.862.15.....	141
12.431.13.....	100	18.614.07.....	108	18.710.01.....	125	18.734.35.....	133	18.863.09.....	141
12.431.14.....	100	18.620.07.....	108	18.710.40.....	125	18.734.40.....	133	18.863.14.....	141
12.431.16.....	100	18.620.10.....	108	18.710.45.....	125	18.734.45.....	133	18.863.16.....	141
12.431.18.....	100	18.621.07.....	108	18.710.50.....	125	18.734.50.....	133	18.863.19.....	141
12.431.20.....	100	18.621.10.....	108	18.710.55.....	125	18.734.55.....	133	18.863.25.....	141
12.431.23.....	100	18.628.10.....	109	18.710.60.....	125	18.734.60.....	133	18.870.00.....	142
12.431.25.....	100	18.629.10.....	109	18.711.00.....	125	18.734.65.....	133	18.870.19.....	142
12.431.28.....	100	18.630.10.....	109	18.711.01.....	125	18.734.70.....	133	18.871.01.....	142
12.433.18.....	100	18.631.10.....	109	18.711.40.....	125	18.736.00.....	134	18.871.02.....	142
12.433.22.....	100	18.632.11.....	109	18.711.45.....	125	18.736.01.....	134	18.873.16.....	142
12.433.25.....	100	18.634.10.....	109	18.711.50.....	125	18.736.01.....	136	18.873.20.....	142
12.433.28.....	100	18.636.10.....	109	18.711.55.....	125	18.736.02.....	134	18.873.25.....	142
12.468.14.....	101	18.637.10.....	109	18.711.60.....	125	18.736.10.....	134	18.875.05.....	142
12.469.14.....	101	18.660.16.....	110	18.712.18.....	126	18.736.10.....	135	18.875.11.....	142
12.475.14.....	101	18.661.16.....	110	18.713.18.....	126	18.736.10.....	136	18.875.21.....	142
12.475.18.....	101	18.661.17.....	110	18.714.32.....	126	18.736.12.....	136	18.880.50.....	127
		18.661.18.....	110	18.714.54.....	126	18.736.14.....	136	18.880.60.....	127
		18.661.19.....	110	18.714.60.....	126	18.736.16.....	134	18.880.70.....	127
		18.667.13.....	110	18.714.61.....	126	18.736.16.....	135	18.881.50.....	127
		18.668.13.....	110	18.716.45.....	128	18.736.16.....	136	18.881.60.....	127
		18.669.13.....	110	18.716.45.....	129	18.736.18.....	136	18.881.70.....	127
		18.670.14.....	111	18.716.45.....	131	18.736.20.....	136	18.882.50.....	127
		18.670.16.....	111	18.716.50.....	131	18.737.00.....	135	18.882.60.....	127
		18.670.20.....	111	18.716.55.....	131	18.737.01.....	135	18.882.70.....	127
		18.670.25.....	112	18.716.60.....	131	18.737.01.....	136	18.883.50.....	127
		18.670.26.....	112	18.716.65.....	128	18.737.02.....	135	18.883.60.....	127
		18.671.14.....	111	18.716.65.....	129	18.738.00.....	137	18.883.70.....	127
		18.671.16.....	111	18.716.65.....	131	18.738.01.....	137	18.904.00.....	143
		18.671.20.....	111	18.718.40.....	130	18.738.35.....	137	18.904.10.....	143
18.125.23.....	104								
18.126.23.....	104								
18.165.18.....	104								
18.165.20.....	104								
18.165.23.....	104								
18.168.06.....	256								
18.168.07.....	256								
18.168.09.....	256								
18.168.12.....	256								
18.168.17.....	256								
18.168.20.....	256								

18.905.00.....	144	24.212.16.....	152	24.683.14.....	158	24.799.18.....	159	32.259.23.....	173
18.905.10.....	144	24.214.15.....	152	24.683.18.....	158	24.799.21.....	159	32.261.22.....	173
18.906.00.....	145	24.214.18.....	152	24.683.21.....	158	24.799.23.....	159	32.261.27.....	173
18.906.01.....	145	24.214.20.....	152	24.684.13.....	160	24.870.15.....	161	32.262.24.....	173
18.906.02.....	145	24.214.23.....	152	24.686.13.....	160	24.870.18.....	161	32.263.24.....	173
18.906.03.....	145	24.214.26.....	152	24.690.16.....	160	24.871.15.....	161	32.265.24.....	173
18.906.06.....	144	24.214.31.....	152	24.690.18.....	160	24.871.18.....	161	32.284.17.....	174
18.906.06.....	145	24.214.37.....	152	24.691.16.....	160	24.872.15.....	161	32.286.18.....	174
18.906.07.....	145	24.216.16.....	153	24.691.18.....	160	24.872.18.....	161	32.289.18.....	174
18.906.08.....	145	24.216.18.....	153	24.693.16.....	160	24.873.15.....	161	32.293.27.....	174
18.906.09.....	145	24.216.21.....	153	24.694.14.....	158	24.873.18.....	161	32.469.96.....	175
18.906.40.....	146	24.216.23.....	153	24.694.18.....	158	24.920.18.....	162	32.469.97.....	175
18.906.41.....	146	24.216.31.....	153	24.694.21.....	158	24.920.21.....	162	32.469.98.....	175
18.906.42.....	146	24.224.13.....	153	24.694.23.....	158	24.921.21.....	162	32.470.00.....	175
18.906.43.....	146	24.224.15.....	153	24.695.14.....	158	24.922.21.....	162	32.470.01.....	175
18.906.44.....	146	24.224.18.....	153	24.695.18.....	158	24.923.18.....	162	32.470.02.....	175
18.906.46.....	146	24.224.20.....	153	24.695.21.....	158	24.923.21.....	162	32.470.03.....	175
18.906.47.....	146	24.224.23.....	153	24.695.23.....	158			32.470.04.....	175
18.907.01.....	146	24.224.26.....	153	24.696.14.....	158			32.470.05.....	175
18.907.02.....	146	24.226.13.....	153	24.696.18.....	158	32.101.12.....	164	32.470.06.....	175
18.907.03.....	146	24.226.15.....	153	24.696.21.....	158	32.101.14.....	164	32.480.97.....	175
18.907.04.....	146	24.226.18.....	153	24.697.14.....	158	32.103.14.....	164	32.480.98.....	175
18.907.05.....	144	24.226.20.....	153	24.697.18.....	158	32.105.17.....	164	32.481.00.....	175
18.907.05.....	145	24.226.23.....	153	24.697.21.....	158	32.107.16.....	164	32.481.01.....	175
18.907.05.....	146	24.226.26.....	153	24.698.14.....	158	32.109.16.....	164	32.481.02.....	175
18.907.06.....	146	24.247.20.....	154	24.698.18.....	158	32.110.01.....	165	32.481.03.....	175
18.907.07.....	146	24.364.18.....	154	24.698.21.....	158	32.110.02.....	165	32.481.04.....	175
18.907.08.....	146	24.370.14.....	154	24.698.23.....	158	32.115.15.....	165	32.481.05.....	175
18.907.09.....	146	24.370.17.....	154	24.699.14.....	158	32.117.15.....	165	32.481.06.....	175
18.907.10.....	146	24.370.20.....	154	24.699.18.....	158	32.119.15.....	165	32.482.01.....	176
18.907.11.....	146	24.370.24.....	154	24.699.21.....	158	32.120.13.....	165	32.482.02.....	176
18.907.12.....	146	24.374.14.....	154	24.699.23.....	158	32.121.13.....	165	32.482.03.....	176
18.907.13.....	146	24.374.17.....	154	24.710.20.....	160	32.122.13.....	165	32.485.01.....	176
18.909.44.....	146	24.374.20.....	154	24.710.22.....	160	32.123.13.....	165	32.485.02.....	176
18.909.50.....	146	24.374.24.....	154	24.711.16.....	160	32.131.15.....	165	32.485.03.....	176
18.909.57.....	146	24.394.14.....	154	24.711.20.....	160	32.133.15.....	165	32.485.04.....	176
18.909.70.....	146	24.394.17.....	154	24.711.22.....	160	32.135.18.....	166	32.485.05.....	176
18.909.75.....	146	24.394.20.....	154	24.711.24.....	160	32.136.17.....	166	32.485.06.....	176
18.909.83.....	146	24.492.18.....	154	24.720.18.....	161	32.137.17.....	166	32.486.99.....	176
18.909.88.....	146	24.492.20.....	154	24.722.18.....	161	32.142.20.....	166	32.487.00.....	176
18.910.01.....	146	24.492.23.....	154	24.774.14.....	159	32.143.20.....	166	32.487.01.....	176
18.910.02.....	146	24.636.10.....	156	24.774.18.....	159	32.147.20.....	166	32.487.02.....	176
18.910.03.....	146	24.637.10.....	156	24.774.21.....	159	32.154.18.....	167	32.490.10.....	177
18.910.04.....	146	24.650.10.....	156	24.774.23.....	159	32.155.18.....	167	32.490.20.....	177
18.910.05.....	146	24.651.10.....	156	24.775.14.....	159	32.159.18.....	167	32.490.30.....	177
18.910.06.....	146	24.652.12.....	155	24.775.18.....	159	32.161.02.....	167	32.490.40.....	177
18.910.07.....	146	24.653.18.....	155	24.775.21.....	159	32.161.03.....	167	32.490.50.....	177
18.910.08.....	146	24.654.15.....	155	24.775.23.....	159	32.165.20.....	167	32.491.01.....	177
18.910.09.....	146	24.655.15.....	155	24.778.14.....	159	32.167.19.....	167	32.491.02.....	177
18.910.10.....	146	24.656.18.....	155	24.778.18.....	159	32.169.20.....	167	32.491.03.....	177
18.910.11.....	146	24.661.12.....	155	24.778.21.....	159	32.175.20.....	168	32.492.13.....	178
18.910.12.....	146	24.662.12.....	155	24.778.23.....	159	32.176.21.....	168	32.492.16.....	178
18.910.13.....	146	24.663.12.....	155	24.779.14.....	159	32.178.20.....	168	32.492.20.....	178
18.912.01.....	146	24.664.15.....	155	24.779.18.....	159	32.197.17.....	168	32.494.13.....	178
18.912.02.....	146	24.666.18.....	155	24.779.21.....	159	32.201.18.....	168	32.494.14.....	178
18.948.00.....	147	24.667.15.....	155	24.779.23.....	159	32.205.18.....	168	32.494.17.....	178
18.948.10.....	147	24.667.18.....	155	24.782.14.....	159	32.209.15.....	169	32.494.20.....	178
18.948.11.....	147	24.667.23.....	155	24.782.18.....	159	32.210.15.....	169	32.496.00.....	178
18.948.12.....	147	24.670.14.....	157	24.782.21.....	159	32.211.15.....	169	32.496.01.....	178
18.948.13.....	147	24.671.14.....	157	24.782.23.....	159	32.212.15.....	169	32.496.12.....	178
18.948.14.....	147	24.672.09.....	156	24.783.14.....	159	32.213.15.....	169	32.498.00.....	178
		24.673.09.....	156	24.783.18.....	159	32.215.20.....	169	32.498.01.....	178
		24.674.09.....	156	24.783.21.....	159	32.216.18.....	169	32.498.12.....	178
		24.674.14.....	158	24.783.23.....	159	32.217.18.....	169	32.501.00.....	179
		24.674.18.....	158	24.794.14.....	159	32.218.23.....	169	32.502.00.....	179
		24.674.21.....	158	24.794.18.....	159	32.219.23.....	169	32.502.21.....	178
		24.674.23.....	158	24.794.21.....	159	32.228.23.....	170	32.503.00.....	179
		24.675.09.....	156	24.794.23.....	159	32.228.27.....	170	32.503.01.....	179
		24.675.14.....	158	24.795.14.....	159	32.229.23.....	170	32.503.02.....	179
		24.675.18.....	158	24.795.18.....	159	32.229.27.....	170	32.503.03.....	179
		24.675.21.....	158	24.795.21.....	159	32.230.22.....	170	32.503.04.....	179
		24.675.23.....	158	24.795.23.....	159	32.230.26.....	170	32.503.05.....	179
		24.676.14.....	157	24.796.14.....	159	32.231.22.....	170	32.503.06.....	179
		24.677.14.....	157	24.796.18.....	159	32.231.26.....	170	32.504.00.....	179
		24.678.14.....	158	24.796.21.....	159	32.235.23.....	171	32.504.01.....	179
		24.678.18.....	158	24.796.23.....	159	32.237.23.....	171	32.504.02.....	179
		24.678.21.....	158	24.797.14.....	159	32.241.30.....	171	32.504.03.....	179
		24.678.23.....	158	24.797.18.....	159	32.243.30.....	171	32.504.04.....	179
		24.679.14.....	158	24.797.21.....	159	32.245.23.....	172	32.504.10.....	179
		24.679.18.....	158	24.797.23.....	159	32.247.23.....	172	32.504.97.....	179
		24.679.21.....	158	24.797.25.....	159	32.249.05.....	172	32.504.98.....	179
		24.679.23.....	158	24.798.14.....	159	32.249.08.....	172	32.505.00.....	179
		24.682.14.....	158	24.798.18.....	159	32.255.24.....	172	32.505.97.....	179
		24.682.18.....	158	24.798.21.....	159	32.259.02.....	173	32.505.98.....	179
		24.682.21.....	158	24.798.23.....	159	32.259.03.....	173	32.506.00.....	179
				24.799.14.....	159				

32.510.36.....	180	32.631.15.....	185	32.669.03.....	190	32.763.18.....	202	40	
32.510.44.....	180	32.631.20.....	185	32.669.04.....	190	32.764.18.....	202	40.011.15.....	216
32.510.52.....	180	32.631.25.....	185	32.687.00.....	192	32.766.12.....	203	40.011.19.....	216
32.510.60.....	180	32.632.04.....	185	32.687.01.....	192	32.766.19.....	203	40.013.15.....	216
32.511.36.....	180	32.632.06.....	185	32.687.02.....	192	32.767.19.....	203	40.013.19.....	216
32.511.44.....	180	32.632.08.....	185	32.687.22.....	192	32.768.21.....	203	40.015.23.....	216
32.511.52.....	180	32.632.10.....	185	32.689.24.....	193	32.774.14.....	205	40.015.26.....	216
32.511.60.....	180	32.632.12.....	185	32.691.14.....	193	32.775.14.....	205	40.017.23.....	216
32.513.03.....	180	32.632.15.....	185	32.691.99.....	193	32.776.13.....	205	40.017.26.....	216
32.513.04.....	180	32.632.20.....	185	32.694.30.....	194	32.777.13.....	205	40.019.14.....	216
32.513.05.....	180	32.632.25.....	185	32.694.34.....	194	32.778.06.....	205	40.019.20.....	216
32.514.10.....	180	32.632.30.....	185	32.694.40.....	194	32.779.06.....	205	40.021.00.....	217
32.514.20.....	180	32.633.06.....	185	32.695.14.....	193	32.781.06.....	205	40.022.00.....	217
32.514.30.....	180	32.633.08.....	185	32.695.40.....	193	32.783.03.....	205	40.024.00.....	218
32.518.04.....	181	32.633.10.....	185	32.696.19.....	194	32.816.15.....	207	40.024.10.....	218
32.518.05.....	181	32.633.12.....	185	32.696.32.....	195	32.817.15.....	207	40.025.01.....	218
32.518.06.....	181	32.633.15.....	185	32.697.02.....	195	32.831.16.....	207	40.025.02.....	218
32.519.03.....	181	32.633.20.....	185	32.698.25.....	195	32.833.16.....	207	40.026.35.....	218
32.519.04.....	181	32.633.25.....	185	32.698.40.....	195	32.835.27.....	206	40.026.50.....	218
32.520.04.....	181	32.650.04.....	186	32.701.18.....	195			40.027.00.....	217
32.520.05.....	181	32.650.06.....	186	32.702.15.....	196	33		40.028.00.....	217
32.521.97.....	182	32.650.08.....	186	32.702.16.....	196	33.210.20.....	208	40.030.31.....	219
32.521.98.....	182	32.650.10.....	186	32.703.15.....	196	33.210.95.....	208	40.030.41.....	219
32.522.00.....	182	32.650.13.....	186	32.703.16.....	196	33.212.25.....	208	40.044.23.....	225
32.522.01.....	182	32.650.15.....	186	32.705.05.....	196	33.212.30.....	208	40.046.22.....	225
32.522.02.....	182	32.650.18.....	186	32.705.10.....	196	33.212.35.....	208	40.048.19.....	225
32.522.03.....	182	32.650.20.....	186	32.705.15.....	196	33.212.40.....	208	40.049.21.....	226
32.522.04.....	182	32.650.25.....	186	32.705.20.....	196	33.214.05.....	208	40.051.20.....	226
32.522.05.....	182	32.650.30.....	186	32.705.25.....	196	33.214.08.....	208	40.052.20.....	226
32.522.06.....	182	32.650.38.....	186	32.707.18.....	196	33.214.10.....	208	40.052.20.....	226
32.524.97.....	182	32.650.44.....	186	32.707.19.....	196	33.214.12.....	208	40.053.20.....	226
32.524.98.....	182	32.650.50.....	186	32.708.19.....	196	33.214.16.....	208	40.054.20.....	227
32.525.00.....	182	32.651.08.....	186	32.709.18.....	197	33.214.16.....	208	40.056.19.....	227
32.525.01.....	182	32.651.10.....	186	32.709.21.....	197	33.216.10.....	208	40.056.28.....	227
32.525.02.....	182	32.651.13.....	186	32.711.18.....	197	33.216.15.....	208	40.058.19.....	227
32.525.03.....	182	32.651.20.....	186	32.712.01.....	197	33.216.20.....	208	40.058.28.....	227
32.525.04.....	182	32.651.25.....	186	32.712.02.....	197	33.220.24.....	208	40.060.23.....	227
32.525.05.....	182	32.651.30.....	186	32.712.03.....	197	33.240.27.....	209	40.061.16.....	227
32.525.06.....	182	32.651.38.....	186	32.712.04.....	197	33.240.99.....	209	40.062.02.....	240
32.529.97.....	182	32.651.44.....	186	32.712.10.....	198	33.242.09.....	209	40.062.03.....	240
32.529.98.....	182	32.651.50.....	186	32.712.11.....	198	33.242.14.....	209	40.062.04.....	240
32.530.00.....	182	32.657.08.....	187	32.712.12.....	198	33.242.16.....	209	40.062.00.....	240
32.530.01.....	182	32.657.10.....	187	32.713.13.....	202	33.242.22.....	209	40.063.01.....	240
32.530.02.....	182	32.660.05.....	188	32.713.16.....	198	33.244.14.....	209	40.063.01.....	240
32.530.03.....	182	32.660.07.....	188	32.714.16.....	198	33.245.00.....	209	40.063.19.....	240
32.530.04.....	182	32.660.10.....	188	32.715.06.....	198	33.246.00.....	209	40.064.01.....	241
32.530.05.....	182	32.660.15.....	188	32.715.08.....	198	33.246.01.....	209	40.064.02.....	241
32.530.06.....	182	32.660.20.....	188	32.716.16.....	198	33.248.00.....	209	40.064.03.....	241
32.550.06.....	183	32.660.25.....	188	32.719.19.....	198	33.249.00.....	209	40.064.04.....	241
32.550.10.....	183	32.660.30.....	188	32.720.10.....	191	33.280.00.....	210	40.064.18.....	227
32.550.13.....	183	32.661.01.....	188	32.720.13.....	191	33.290.00.....	210	40.065.01.....	241
32.550.16.....	183	32.661.02.....	188	32.720.19.....	191	33.296.00.....	210	40.065.02.....	241
32.550.19.....	183	32.661.05.....	188	32.722.10.....	191	33.354.10.....	211	40.065.03.....	241
32.550.25.....	183	32.661.07.....	188	32.722.13.....	191	33.354.15.....	211	40.065.04.....	241
32.550.32.....	183	32.661.10.....	188	32.722.19.....	191	33.354.20.....	211	40.065.50.....	251
32.551.06.....	183	32.661.15.....	188	32.722.25.....	191	33.354.25.....	211	40.065.51.....	242
32.551.10.....	183	32.661.20.....	188	32.740.47.....	199	33.354.28.....	211	40.065.52.....	242
32.551.13.....	183	32.661.25.....	188	32.741.62.....	199	33.354.30.....	211	40.065.53.....	242
32.551.16.....	183	32.661.30.....	188	32.742.62.....	199	33.354.32.....	211	40.065.54.....	242
32.551.19.....	183	32.662.06.....	188	32.743.03.....	199	33.354.35.....	211	40.065.56.....	242
32.551.25.....	183	32.662.08.....	188	32.743.06.....	199	33.354.40.....	211	40.065.57.....	242
32.551.32.....	183	32.662.11.....	188	32.744.01.....	199	33.417.07.....	211	40.065.65.....	242
32.584.05.....	184	32.662.16.....	188	32.744.02.....	199	33.417.08.....	211	40.065.66.....	242
32.584.08.....	184	32.663.05.....	189	32.746.16.....	199	33.417.09.....	211	40.066.01.....	243
32.585.02.....	184	32.663.10.....	189	32.746.17.....	199	33.417.10.....	211	40.066.02.....	243
32.586.12.....	184	32.663.15.....	189	32.748.17.....	200	33.417.11.....	211	40.066.03.....	243
32.586.14.....	184	32.663.55.....	189	32.750.20.....	200	33.417.12.....	211	40.066.04.....	243
32.586.16.....	184	32.663.60.....	189	32.751.20.....	200	33.417.13.....	211	40.066.05.....	243
32.588.03.....	184	32.663.65.....	189	32.752.20.....	200	33.417.14.....	211	40.066.06.....	243
32.588.04.....	184	32.664.04.....	189	32.753.20.....	200	33.417.15.....	211	40.066.10.....	244
32.588.05.....	184	32.664.06.....	189	32.754.17.....	200	33.417.16.....	211	40.066.16.....	244
32.588.06.....	184	32.664.08.....	189	32.755.17.....	200	33.417.17.....	211	40.066.17.....	244
32.629.10.....	183	32.664.10.....	189	32.756.17.....	200	33.417.18.....	211	40.066.18.....	244
32.629.15.....	183	32.664.12.....	189	32.757.17.....	200	33.417.19.....	211	40.066.19.....	244
32.630.06.....	185	32.665.04.....	189	32.758.17.....	201	33.417.20.....	211	40.066.20.....	244
32.630.08.....	185	32.665.06.....	189	32.758.19.....	201	33.417.22.....	211	40.067.01.....	228
32.630.10.....	185	32.665.08.....	189	32.759.06.....	201	33.417.24.....	211	40.067.02.....	228
32.630.12.....	185	32.665.10.....	189	32.759.10.....	201	33.417.25.....	211	40.067.03.....	228
32.630.15.....	185	32.665.12.....	189	32.759.12.....	201	33.417.27.....	211	40.067.04.....	228
32.630.20.....	185	32.665.91.....	190	32.759.13.....	201	33.417.30.....	211	40.068.20.....	228
32.630.25.....	185	32.665.92.....	190	32.759.19.....	201	33.417.40.....	211	40.068.26.....	228
32.630.30.....	185	32.665.93.....	190	32.759.25.....	201	33.545.22.....	212	40.069.20.....	228
32.630.80.....	185	32.665.94.....	190	32.760.15.....	201	33.547.17.....	212	40.069.26.....	228
32.631.10.....	185	32.669.01.....	190	32.761.19.....	201	33.556.57.....	212	40.070.17.....	229
32.631.12.....	185	32.669.02.....	190	32.762.19.....	201			40.070.21.....	229
								40.070.29.....	229

Nummernverzeichnis

Numerical index
Index numérique
Índice numérico
Indice numerico

40.070.30.....	229	40.163.29.....	237	40.270.15.....	259	40.298.10.....	261	40.452.03.....	270
40.071.21.....	230	40.167.23.....	238	40.270.20.....	259	40.298.12.....	261	40.453.01.....	270
40.071.30.....	229	40.170.13.....	238	40.270.25.....	259	40.300.20.....	261	40.453.02.....	270
40.072.06.....	230	40.170.19.....	238	40.270.30.....	259	40.300.25.....	261	40.453.03.....	270
40.072.08.....	230	40.170.20.....	238	40.270.40.....	259	40.303.20.....	261	40.456.14.....	271
40.072.10.....	230	40.171.01.....	246	40.270.50.....	259	40.304.23.....	261	40.456.18.....	271
40.073.03.....	230	40.171.02.....	246	40.271.15.....	259	40.304.26.....	261	40.457.53.....	270
40.073.05.....	230	40.171.03.....	246	40.271.20.....	259	40.307.45.....	260	40.457.58.....	270
40.073.07.....	230	40.171.04.....	248	40.271.25.....	259	40.307.55.....	260	40.458.20.....	271
40.075.10.....	245	40.172.01.....	248	40.271.30.....	259	40.308.00.....	262	40.458.21.....	271
40.075.11.....	245	40.172.02.....	248	40.271.40.....	259	40.308.01.....	262	40.459.32.....	266
40.075.12.....	245	40.172.10.....	248	40.271.50.....	259	40.308.04.....	262	40.459.33.....	266
40.075.13.....	245	40.172.19.....	248	40.272.15.....	259	40.308.06.....	262	40.459.34.....	266
40.075.14.....	245	40.173.01.....	246	40.272.20.....	259	40.308.08.....	262	40.460.20.....	272
40.075.15.....	245	40.173.02.....	246	40.272.25.....	259	40.309.00.....	262	40.460.30.....	272
40.075.16.....	245	40.173.03.....	246	40.272.30.....	259	40.309.01.....	262	40.460.40.....	272
40.075.18.....	245	40.174.03.....	248	40.272.40.....	259	40.309.02.....	262	40.460.50.....	272
40.076.01.....	245	40.174.04.....	248	40.272.50.....	259	40.309.03.....	262	40.460.60.....	272
40.076.02.....	245	40.174.05.....	248	40.273.15.....	259	40.309.04.....	262	40.461.20.....	272
40.076.03.....	245	40.174.08.....	248	40.273.20.....	259	40.309.05.....	262	40.461.25.....	272
40.076.04.....	245	40.180.01.....	249	40.273.25.....	259	40.310.00.....	262	40.461.40.....	272
40.077.18.....	245	40.180.02.....	249	40.273.30.....	259	40.310.01.....	262	40.461.50.....	272
40.077.25.....	245	40.180.03.....	249	40.273.40.....	259	40.310.02.....	262	40.463.20.....	272
40.078.22.....	231	40.180.04.....	249	40.273.50.....	259	40.310.03.....	262	40.463.25.....	272
40.079.05.....	245	40.180.05.....	249	40.283.02.....	259	40.310.04.....	262	40.463.40.....	272
40.079.08.....	245	40.180.06.....	249	40.283.03.....	259	40.313.15.....	260	40.464.20.....	272
40.080.19.....	231	40.180.07.....	249	40.283.70.....	262	40.313.20.....	260	40.464.30.....	272
40.081.19.....	231	40.180.08.....	249	40.283.71.....	262	40.313.25.....	260	40.464.40.....	272
40.083.19.....	231	40.180.09.....	250	40.283.72.....	262	40.313.30.....	260	40.464.50.....	272
40.090.33.....	220	40.180.10.....	250	40.283.73.....	262	40.331.17.....	263	40.464.60.....	272
40.091.25.....	220	40.180.11.....	250	40.283.74.....	262	40.332.20.....	263	40.465.20.....	272
40.092.22.....	220	40.180.12.....	250	40.283.75.....	262	40.401.16.....	148	40.465.25.....	272
40.092.30.....	220	40.180.13.....	250	40.286.13.....	258	40.402.15.....	148	40.465.40.....	272
40.092.40.....	220	40.180.14.....	250	40.286.15.....	258	40.405.17.....	148	40.465.50.....	272
40.092.50.....	220	40.180.16.....	250	40.286.18.....	258	40.405.27.....	148	40.467.20.....	272
40.092.60.....	220	40.190.10.....	251	40.286.22.....	258	40.406.17.....	148	40.467.25.....	272
40.092.70.....	220	40.190.18.....	251	40.287.13.....	258	40.413.02.....	266	40.467.40.....	272
40.092.75.....	220	40.191.01.....	251	40.287.15.....	258	40.414.04.....	267	40.468.20.....	272
40.093.25.....	220	40.191.02.....	251	40.287.18.....	258	40.414.05.....	267	40.468.30.....	272
40.093.30.....	220	40.191.16.....	251	40.287.22.....	258	40.414.06.....	267	40.468.40.....	272
40.093.40.....	220	40.191.23.....	251	40.288.13.....	258	40.415.03.....	267	40.468.50.....	272
40.093.50.....	220	40.191.24.....	251	40.288.15.....	258	40.415.04.....	267	40.468.60.....	272
40.093.60.....	220	40.210.23.....	329	40.288.18.....	258	40.415.05.....	267	40.469.30.....	272
40.093.70.....	220	40.211.23.....	329	40.288.22.....	258	40.416.03.....	267	40.469.40.....	272
40.094.00.....	220	40.213.23.....	329	40.289.13.....	258	40.416.04.....	267	40.469.50.....	272
40.094.01.....	220	40.250.07.....	254	40.289.15.....	258	40.420.01.....	268	40.470.02.....	273
40.094.30.....	220	40.250.11.....	254	40.289.18.....	258	40.420.02.....	268	40.470.03.....	273
40.094.40.....	220	40.250.15.....	254	40.289.22.....	258	40.420.03.....	268	40.470.04.....	273
40.094.50.....	220	40.250.18.....	254	40.289.45.....	258	40.421.01.....	268	40.470.05.....	273
40.094.60.....	220	40.252.13.....	254	40.290.16.....	258	40.421.02.....	268	40.471.02.....	273
40.094.70.....	220	40.252.15.....	254	40.290.21.....	258	40.421.03.....	268	40.471.03.....	273
40.095.20.....	221	40.252.17.....	254	40.290.10.....	258	40.422.01.....	268	40.471.04.....	273
40.096.21.....	222	40.252.19.....	254	40.291.04.....	259	40.422.02.....	268	40.473.02.....	273
40.097.20.....	222	40.253.07.....	254	40.292.08.....	258	40.422.03.....	268	40.473.03.....	273
40.098.23.....	221	40.253.11.....	254	40.293.06.....	260	40.423.03.....	266	40.473.04.....	273
40.132.01.....	232	40.253.15.....	254	40.293.08.....	260	40.430.01.....	268	40.475.30.....	272
40.132.02.....	232	40.253.18.....	254	40.293.09.....	260	40.430.02.....	268	40.475.40.....	272
40.132.14.....	232	40.254.10.....	254	40.293.10.....	260	40.430.03.....	268	40.496.01.....	274
40.133.16.....	232	40.254.16.....	254	40.293.12.....	260	40.431.01.....	268	40.496.01C.....	274
40.134.18.....	232	40.256.07.....	254	40.294.05.....	260	40.431.02.....	268		
40.136.16.....	232	40.256.10.....	254	40.295.06.....	259	40.431.03.....	268		
40.138.16.....	232	40.256.13.....	254	40.295.07.....	259	40.432.01.....	268		
40.139.16.....	232	40.256.16.....	254	40.295.08.....	259	40.432.02.....	268		
40.140.23.....	232	40.256.19.....	254	40.295.09.....	259	40.432.03.....	268		
40.141.25.....	233	40.256.22.....	254	40.295.10.....	259	40.440.01.....	268		
40.142.25.....	233	40.257.01.....	254	40.295.11.....	259	40.440.02.....	268		
40.143.21.....	233	40.257.02.....	254	40.295.12.....	259	40.440.03.....	268		
40.145.21.....	233	40.257.03.....	254	40.295.15.....	259	40.441.01.....	268		
40.147.21.....	233	40.258.06.....	255	40.296.06.....	260	40.441.02.....	268		
40.149.22.....	234	40.258.08.....	255	40.296.08.....	260	40.441.03.....	268		
40.149.23.....	234	40.258.10.....	255	40.296.10.....	260	40.442.01.....	268		
40.151.24.....	234	40.258.11.....	255	40.296.12.....	260	40.442.02.....	268		
40.152.01.....	234	40.258.13.....	255	40.296.16.....	260	40.442.03.....	268		
40.152.02.....	234	40.258.16.....	255	40.296.18.....	260	40.445.25.....	269		
40.152.03.....	234	40.258.19.....	255	40.296.30.....	260	40.447.22.....	269		
40.155.20.....	235	40.258.25.....	255	40.296.32.....	260	40.447.35.....	269		
40.157.19.....	235	40.259.08.....	255	40.297.06.....	259	40.448.20.....	269		
40.157.21.....	235	40.259.11.....	255	40.297.07.....	259	40.450.01.....	270		
40.159.19.....	235	40.259.14.....	255	40.297.08.....	259	40.450.02.....	270		
40.161.01.....	236	40.259.17.....	255	40.297.09.....	259	40.450.03.....	270		
40.161.02.....	236	40.260.08.....	255	40.297.10.....	259	40.451.01.....	270		
40.161.03.....	236	40.260.11.....	255	40.297.11.....	259	40.451.02.....	270		
40.161.04.....	236	40.260.14.....	255	40.297.12.....	259	40.451.03.....	270		
40.161.05.....	236	40.260.17.....	255	40.297.15.....	259	40.452.01.....	270		
40.162.29.....	237	40.260.20.....	255	40.298.08.....	261	40.452.02.....	270		

40.496.02.....	274	40.498.16C.....	275	40.500.15C.....	276	40.504.05.....	277	40.514.14.....	277
40.496.02C.....	274	40.498.21.....	275	40.501.02.....	276	40.504.05C.....	277	40.514.15.....	277
40.496.03.....	274	40.498.21C.....	275	40.501.02C.....	276	40.504.06.....	277	40.514.21.....	277
40.496.03C.....	274	40.498.22.....	275	40.501.03.....	276	40.504.06C.....	277	40.514.22.....	277
40.496.04.....	274	40.498.22C.....	275	40.501.03C.....	276	40.504.12.....	277	40.514.23.....	277
40.496.04C.....	274	40.498.23.....	275	40.501.04.....	276	40.504.12C.....	277	40.514.24.....	277
40.496.05.....	274	40.498.23C.....	275	40.501.04C.....	276	40.504.13.....	277	40.514.25.....	277
40.496.05C.....	274	40.498.24.....	275	40.501.05.....	276	40.504.13C.....	277	40.514.26.....	277
40.496.06.....	274	40.498.24C.....	275	40.501.05C.....	276	40.504.14.....	277	40.514.31.....	277
40.496.06C.....	274	40.498.25.....	275	40.501.06.....	276	40.504.14C.....	277	40.514.32.....	277
40.496.11.....	274	40.498.25C.....	275	40.501.06C.....	276	40.504.15.....	277	40.514.33.....	277
40.496.11C.....	274	40.498.31.....	275	40.501.11.....	276	40.504.15C.....	277	40.514.34.....	277
40.496.12.....	274	40.498.31C.....	275	40.501.11C.....	276	40.510.01.....	274	40.514.35.....	277
40.496.12C.....	274	40.498.32.....	275	40.501.12.....	276	40.510.02.....	274	40.520.03.....	278
40.496.13.....	274	40.498.32C.....	275	40.501.12C.....	276	40.510.03.....	274	40.520.05.....	278
40.496.13C.....	274	40.498.33.....	275	40.501.13.....	276	40.510.04.....	274	40.522.03.....	278
40.496.14.....	274	40.498.33C.....	275	40.501.13C.....	276	40.510.05.....	274	40.522.05.....	278
40.496.14C.....	274	40.498.34.....	275	40.501.14.....	276	40.510.06.....	274	40.524.03.....	278
40.496.15.....	274	40.498.34C.....	275	40.501.14C.....	276	40.510.11.....	274	40.524.05.....	278
40.496.15C.....	274	40.498.35.....	275	40.501.15.....	276	40.510.12.....	274	40.526.03.....	278
40.496.16.....	274	40.498.35C.....	275	40.501.15C.....	276	40.510.13.....	274	40.526.05.....	278
40.496.16C.....	274	40.498.52.....	275	40.502.02.....	276	40.510.14.....	274	40.527.03.....	278
40.496.21.....	274	40.498.52C.....	275	40.502.02C.....	276	40.510.15.....	274	40.527.05.....	278
40.496.21C.....	274	40.498.53.....	275	40.502.03.....	276	40.510.16.....	274	40.529.03.....	278
40.496.22.....	274	40.498.53C.....	275	40.502.03C.....	276	40.510.21.....	274	40.529.05.....	278
40.496.22C.....	274	40.498.54.....	275	40.502.04.....	276	40.510.22.....	274	40.530.03.....	279
40.496.23.....	274	40.498.54C.....	275	40.502.04C.....	276	40.510.23.....	274	40.530.05.....	279
40.496.23C.....	274	40.498.55.....	275	40.502.05.....	276	40.510.24.....	274	40.532.03.....	279
40.496.24.....	274	40.498.55C.....	275	40.502.05C.....	276	40.510.25.....	274	40.532.05.....	279
40.496.24C.....	274	40.499.02.....	275	40.502.12.....	276	40.510.26.....	274	40.534.03.....	279
40.496.25.....	274	40.499.02C.....	275	40.502.12C.....	276	40.510.31.....	274	40.534.05.....	279
40.496.25C.....	274	40.499.03.....	275	40.502.13.....	276	40.510.32.....	274	40.536.03.....	279
40.496.32.....	274	40.499.03C.....	275	40.502.13C.....	276	40.510.33.....	274	40.536.05.....	279
40.496.33.....	274	40.499.04.....	275	40.502.14.....	276	40.510.34.....	274	40.538.03.....	279
40.496.33C.....	274	40.499.04C.....	275	40.502.14C.....	276	40.510.35.....	274	40.538.05.....	279
40.496.34.....	274	40.499.05.....	275	40.502.15.....	276	40.510.42.....	274	40.540.03.....	279
40.496.34C.....	274	40.499.05C.....	275	40.502.15C.....	276	40.510.43.....	274	40.540.05.....	279
40.496.35.....	274	40.499.06.....	275	40.503.01.....	277	40.510.44.....	274	40.542.02.....	276
40.496.35C.....	274	40.499.06C.....	275	40.503.01C.....	277	40.510.45.....	274	40.542.03.....	276
40.496.36.....	274	40.499.11.....	275	40.503.02.....	277	40.510.46.....	274	40.542.04.....	276
40.496.36C.....	274	40.499.12.....	275	40.503.02C.....	277	40.510.52.....	274	40.542.05.....	276
40.497.02.....	274	40.499.13.....	275	40.503.03.....	277	40.510.53.....	274	40.542.12.....	276
40.497.02C.....	274	40.499.14.....	275	40.503.03C.....	277	40.510.54.....	274	40.542.13.....	276
40.497.03.....	274	40.499.15.....	275	40.503.04.....	277	40.510.55.....	274	40.542.14.....	276
40.497.03C.....	274	40.499.16.....	275	40.503.04C.....	277	40.510.56.....	274	40.542.15.....	276
40.497.04.....	274	40.499.21.....	275	40.503.05.....	277	40.511.01.....	275	40.543.02.....	277
40.497.04C.....	274	40.499.22.....	275	40.503.05C.....	277	40.511.02.....	275	40.543.03.....	277
40.497.05.....	274	40.499.23.....	275	40.503.11.....	277	40.511.03.....	275	40.543.04.....	277
40.497.05C.....	274	40.499.24.....	275	40.503.11C.....	277	40.511.04.....	275	40.543.05.....	277
40.497.06.....	274	40.499.25.....	275	40.503.12.....	277	40.511.05.....	275	40.543.06.....	277
40.497.06C.....	274	40.499.31.....	275	40.503.12C.....	277	40.511.06.....	275	40.543.12.....	277
40.497.12.....	274	40.499.32.....	275	40.503.13.....	277	40.511.11.....	276	40.543.13.....	277
40.497.12C.....	274	40.499.33.....	275	40.503.13C.....	277	40.511.12.....	276	40.543.14.....	277
40.497.13.....	274	40.499.34.....	275	40.503.14.....	277	40.511.13.....	276	40.543.15.....	277
40.497.13C.....	274	40.499.35.....	275	40.503.14C.....	277	40.511.14.....	276	40.546.55.....	280
40.497.14.....	274	40.499.42.....	275	40.503.15.....	277	40.511.15.....	276	40.550.02.....	280
40.497.14C.....	274	40.499.43.....	275	40.503.15C.....	277	40.511.22.....	276	40.551.02.....	280
40.497.15.....	274	40.499.44.....	275	40.503.21.....	277	40.511.23.....	276	40.552.02.....	280
40.497.15C.....	274	40.499.45.....	275	40.503.21C.....	277	40.511.24.....	276	40.553.02.....	280
40.497.16.....	274	40.499.46.....	275	40.503.22.....	277	40.511.25.....	276	40.554.01.....	280
40.497.16C.....	274	40.499.52.....	275	40.503.22C.....	277	40.511.26.....	276	40.560.11.....	290
40.498.01.....	275	40.499.53.....	275	40.503.23.....	277	40.511.32.....	276	40.560.12.....	290
40.498.01C.....	275	40.499.54.....	275	40.503.23C.....	277	40.511.33.....	276	40.560.14.....	290
40.498.02.....	275	40.499.55.....	275	40.503.24.....	277	40.511.34.....	276	40.560.15.....	290
40.498.02C.....	275	40.500.01.....	276	40.503.24C.....	277	40.511.35.....	276	40.560.17.....	290
40.498.03.....	275	40.500.01C.....	276	40.503.25.....	277	40.511.36.....	276	40.560.18.....	290
40.498.03C.....	275	40.500.02.....	276	40.503.25C.....	277	40.511.41.....	276	40.561.09.....	290
40.498.04.....	275	40.500.02C.....	276	40.503.26.....	277	40.511.42.....	276	40.561.10.....	290
40.498.04C.....	275	40.500.03.....	276	40.503.26C.....	277	40.511.43.....	276	40.561.11.....	290
40.498.05.....	275	40.500.03C.....	276	40.503.31.....	277	40.511.44.....	276	40.561.12.....	290
40.498.05C.....	275	40.500.04.....	276	40.503.31C.....	277	40.511.45.....	276	40.561.14.....	290
40.498.06.....	275	40.500.04C.....	276	40.503.32.....	277	40.512.01.....	276	40.561.15.....	290
40.498.11.....	275	40.500.05.....	276	40.503.32C.....	277	40.512.02.....	276	40.561.62.....	285
40.498.11C.....	275	40.500.05C.....	276	40.503.33.....	277	40.512.03.....	276	40.561.63.....	285
40.498.12.....	275	40.500.06.....	276	40.503.33C.....	277	40.512.04.....	276	40.561.65.....	285
40.498.12C.....	275	40.500.06C.....	276	40.503.34.....	277	40.512.05.....	276	40.561.66.....	285
40.498.13.....	275	40.500.11.....	276	40.503.34C.....	277	40.512.06.....	276	40.561.78.....	285
40.498.13C.....	275	40.500.11C.....	276	40.503.35.....	277	40.514.01.....	277	40.561.79.....	285
40.498.14.....	275	40.500.12.....	276	40.503.35C.....	277	40.514.02.....	277	40.562.09.....	290
40.498.14C.....	275	40.500.12C.....	276	40.504.02.....	277	40.514.03.....	277	40.562.10.....	290
40.498.15.....	275	40.500.13.....	276	40.504.02C.....	277	40.514.04.....	277	40.562.12.....	290
40.498.15C.....	275	40.500.13C.....	276	40.504.03.....	277	40.514.05.....	277	40.562.13.....	290
40.498.16.....	275	40.500.14.....	276	40.504.03C.....	277	40.514.11.....	277	40.562.14.....	290
		40.500.14C.....	276	40.504.04.....	277	40.514.12.....	277	40.562.15.....	290
		40.500.15.....	276	40.504.04C.....	277	40.514.13.....	277	40.563.74.....	290

Nummernverzeichnis

Numerical index
Index numérique
Índice numérico
Indice numerico

40.563.75.....	290	40.575.56.....	293	40.724.25.....	286	40.732.71.....	288	40.771.13.....	303
40.564.12.....	292	40.575.65.....	293	40.724.26.....	286	40.732.72.....	288	40.771.21.....	303
40.564.13.....	292	40.575.66.....	293	40.724.35.....	286	40.732.73.....	288	40.771.23.....	303
40.564.15.....	292	40.575.74.....	293	40.724.36.....	286	40.732.75.....	289	40.771.31.....	303
40.564.16.....	292	40.575.75.....	293	40.724.45.....	286	40.732.76.....	289	40.771.33.....	303
40.564.18.....	292	40.575.79.....	293	40.724.46.....	286	40.732.77.....	291	40.771.41.....	303
40.564.19.....	292	40.575.80.....	293	40.724.55.....	286	40.732.78.....	291	40.771.43.....	303
40.564.30.....	292	40.577.49.....	291	40.724.56.....	286	40.732.79.....	288	40.771.83.....	303
40.564.31.....	292	40.577.50.....	291	40.724.58.....	294	40.732.80.....	288	40.772.17.....	304
40.564.40.....	292	40.577.55.....	293	40.724.59.....	294	40.732.87.....	288	40.772.18.....	304
40.564.41.....	292	40.577.56.....	293	40.726.56.....	285	40.732.88.....	288	40.772.21.....	304
40.564.50.....	292	40.577.65.....	288	40.726.57.....	285	40.733.54.....	288	40.772.23.....	304
40.564.51.....	292	40.577.66.....	288	40.727.47.....	285	40.733.55.....	288	40.772.24.....	304
40.564.74.....	290	40.577.72.....	293	40.727.48.....	285	40.733.56.....	288	40.772.31.....	304
40.564.75.....	290	40.577.73.....	293	40.727.58.....	294	40.733.57.....	288	40.773.01.....	303
40.565.10.....	292	40.577.74.....	293	40.727.59.....	294	40.733.61.....	287	40.773.03.....	303
40.565.11.....	292	40.577.75.....	293	40.728.69.....	285	40.733.62.....	287	40.773.11.....	303
40.565.13.....	292	40.577.88.....	293	40.728.70.....	285	40.734.57.....	291	40.773.13.....	303
40.565.14.....	292	40.577.89.....	293	40.730.58.....	295	40.734.58.....	291	40.773.23.....	303
40.565.15.....	292	40.579.91.....	293	40.730.59.....	295	40.734.62.....	288	40.773.31.....	303
40.565.16.....	292	40.579.92.....	293	40.730.88.....	295	40.734.63.....	288	40.773.33.....	303
40.565.74.....	290	40.580.35.....	296	40.730.89.....	295	40.734.65.....	291	40.774.17.....	304
40.565.75.....	290	40.580.36.....	296	40.731.00.....	287	40.734.66.....	291	40.774.19.....	304
40.566.11.....	292	40.582.31.....	296	40.731.02.....	288	40.734.72.....	288	40.774.21.....	304
40.566.12.....	292	40.582.32.....	296	40.731.03.....	288	40.734.73.....	288	40.774.22.....	304
40.566.13.....	292	40.584.36.....	296	40.731.06.....	287	40.735.25.....	289	40.774.23.....	304
40.566.14.....	292	40.584.37.....	296	40.731.07.....	287	40.735.26.....	289	40.775.50.....	302
40.566.16.....	292	40.584.38.....	296	40.731.10.....	288	40.735.35.....	289	40.775.51.....	302
40.566.17.....	292	40.584.39.....	296	40.731.11.....	288	40.735.36.....	289	40.775.52.....	302
40.567.10.....	311	40.690.30.....	296	40.731.14.....	287	40.735.41.....	295	40.775.53.....	302
40.567.12.....	311	40.690.31.....	296	40.731.15.....	287	40.735.42.....	295	40.775.60.....	302
40.567.20.....	311	40.692.35.....	296	40.731.19.....	288	40.735.45.....	289	40.775.61.....	302
40.567.22.....	311	40.692.36.....	296	40.731.20.....	288	40.735.46.....	289	40.775.62.....	302
40.567.40.....	311	40.693.35.....	298	40.731.30.....	288	40.735.49.....	291	40.775.63.....	302
40.567.46.....	311	40.693.36.....	298	40.731.31.....	288	40.735.50.....	291	40.775.70.....	302
40.567.50.....	311	40.693.43.....	298	40.731.33.....	287	40.735.51.....	289	40.775.71.....	302
40.567.52.....	311	40.693.44.....	298	40.731.34.....	287	40.735.52.....	295	40.775.72.....	302
40.567.54.....	311	40.694.31.....	296	40.731.37.....	291	40.735.55.....	289	40.775.73.....	302
40.568.14.....	292	40.694.32.....	296	40.731.38.....	291	40.735.56.....	295	40.775.80.....	302
40.568.15.....	292	40.694.35.....	296	40.731.40.....	299	40.735.57.....	295	40.775.81.....	302
40.568.17.....	292	40.694.36.....	296	40.731.41.....	299	40.735.59.....	295	40.775.82.....	302
40.568.18.....	292	40.694.37.....	296	40.731.45.....	298	40.735.70.....	295	40.775.83.....	302
40.568.19.....	292	40.694.38.....	296	40.731.46.....	298	40.735.71.....	295	40.775.91.....	302
40.568.20.....	292	40.694.40.....	296	40.731.47.....	291	40.736.56.....	295	40.775.92.....	302
40.570.30.....	296	40.694.41.....	296	40.731.48.....	291	40.736.57.....	295	40.775.93.....	302
40.570.31.....	296	40.694.70.....	298	40.731.50.....	288	40.736.58.....	295	40.776.18.....	304
40.571.00.....	293	40.694.71.....	298	40.731.51.....	288	40.736.59.....	295	40.776.20.....	304
40.571.01.....	293	40.695.35.....	298	40.731.55.....	287	40.737.56.....	295	40.777.00.....	302
40.571.33.....	298	40.695.36.....	298	40.731.56.....	287	40.737.57.....	295	40.777.01.....	302
40.571.34.....	298	40.695.40.....	298	40.731.57.....	288	40.737.58.....	295	40.777.02.....	302
40.571.55.....	293	40.695.41.....	298	40.731.58.....	288	40.737.59.....	295	40.777.03.....	302
40.571.56.....	293	40.695.43.....	298	40.731.60.....	287	40.737.62.....	295	40.777.10.....	302
40.571.78.....	293	40.695.44.....	298	40.731.61.....	287	40.737.63.....	295	40.777.11.....	302
40.571.79.....	293	40.695.70.....	298	40.731.62.....	287	40.737.78.....	295	40.777.12.....	302
40.572.03.....	293	40.695.71.....	298	40.731.63.....	287	40.737.79.....	295	40.777.13.....	302
40.572.04.....	293	40.695.74.....	298	40.731.65.....	287	40.739.56.....	295	40.777.20.....	302
40.572.30.....	296	40.695.75.....	298	40.731.66.....	287	40.739.57.....	295	40.777.21.....	302
40.572.31.....	296	40.696.70.....	298	40.731.68.....	287	40.739.62.....	295	40.777.23.....	302
40.573.30.....	298	40.696.71.....	298	40.731.69.....	287	40.739.63.....	295	40.778.18.....	304
40.573.31.....	298	40.697.13.....	296	40.731.70.....	287	40.740.58.....	295	40.780.19.....	303
40.573.33.....	298	40.697.14.....	296	40.731.71.....	287	40.740.59.....	295	40.780.21.....	303
40.573.34.....	298	40.697.33.....	298	40.731.74.....	287	40.742.98.....	284	40.780.40.....	284
40.573.65.....	291	40.697.34.....	298	40.731.75.....	287	40.745.58.....	295	40.780.41.....	284
40.573.66.....	291	40.697.44.....	298	40.731.78.....	287	40.745.59.....	295	40.780.54.....	285
40.573.72.....	291	40.697.45.....	298	40.731.79.....	287	40.747.58.....	295	40.780.55.....	285
40.573.73.....	291	40.697.46.....	298	40.731.80.....	288	40.747.59.....	295	40.780.56.....	285
40.573.74.....	293	40.697.47.....	298	40.731.81.....	288	40.751.58.....	294	40.780.57.....	285
40.573.75.....	293	40.697.57.....	298	40.731.82.....	288	40.751.59.....	294	40.781.88.....	294
40.573.78.....	288	40.697.58.....	298	40.731.83.....	288	40.753.91.....	287	40.781.89.....	294
40.573.79.....	288	40.698.30.....	296	40.731.84.....	288	40.753.92.....	287	40.785.56.....	294
40.573.84.....	291	40.698.31.....	296	40.731.85.....	288	40.755.58.....	294	40.785.57.....	294
40.573.85.....	291	40.698.60.....	296	40.731.87.....	287	40.755.59.....	294	40.785.58.....	294
40.573.96.....	291	40.698.61.....	296	40.731.88.....	287	40.757.58.....	294	40.785.59.....	294
40.573.97.....	291	40.698.65.....	297	40.731.90.....	288	40.757.59.....	294	40.785.70.....	294
40.574.36.....	298	40.698.66.....	297	40.731.91.....	288	40.760.92.....	284	40.785.71.....	294
40.574.37.....	298	40.698.70.....	296	40.731.92.....	287	40.760.93.....	284	40.786.56.....	294
40.574.38.....	298	40.698.71.....	296	40.731.93.....	287	40.763.11.....	287	40.786.57.....	294
40.574.39.....	298	40.710.40.....	296	40.731.99.....	287	40.763.12.....	287	40.786.58.....	294
40.574.49.....	291	40.710.41.....	296	40.732.54.....	287	40.766.40.....	296	40.786.59.....	294
40.574.50.....	291	40.712.38.....	296	40.732.55.....	287	40.766.41.....	296	40.787.56.....	294
40.574.74.....	293	40.712.39.....	296	40.732.58.....	287	40.770.90.....	284	40.787.57.....	294
40.574.75.....	293	40.715.40.....	296	40.732.59.....	287	40.770.91.....	284	40.787.62.....	294
40.575.40.....	298	40.715.41.....	296	40.732.62.....	287	40.771.02.....	303	40.787.63.....	294
40.575.41.....	298	40.721.58.....	294	40.732.63.....	287	40.771.04.....	303	40.787.78.....	294
40.575.55.....	293	40.721.59.....	294	40.732.70.....	288	40.771.11.....	303	40.787.79.....	294

40.788.62.....	294	40.824.07.....	321	40.920.81.....	285	46.303.06.....	282	88.292.05.....	339
40.788.63.....	294	40.824.08.....	321	40.920.84.....	285	46.304.01.....	282	88.292.06.....	339
40.789.56.....	294	40.824.09.....	321	40.920.85.....	285	46.304.02.....	282	88.292.07.....	339
40.789.57.....	294	40.825.03.....	321	40.920.87.....	284	46.305.01.....	282	88.292.08.....	339
40.790.07.....	300	40.825.04.....	321	40.920.88.....	284	46.305.02.....	282	88.292.09.....	339
40.790.09.....	300	40.825.06.....	321	40.920.92.....	284	46.311.10.....	282	88.292.10.....	339
40.790.11.....	300	40.825.07.....	321	40.920.93.....	284	46.311.25.....	282	88.620.01.....	338
40.790.17.....	300	40.825.08.....	321	40.920.99.....	284	46.311.40.....	282	88.621.01.....	338
40.790.19.....	300	40.825.09.....	321	40.922.60.....	284	46.315.20.....	282	88.629.01.....	338
40.790.21.....	300	40.830.00.....	328	40.922.61.....	284	46.410.04.....	202	88.629.02.....	338
40.791.07.....	300	40.831.00.....	322	40.922.68.....	284	46.410.05.....	202	88.629.03.....	338
40.791.09.....	300	40.831.01.....	322	40.922.69.....	284	46.415.18.....	203	88.629.04.....	338
40.791.11.....	300	40.831.02.....	322	40.922.76.....	284	46.416.18.....	203	88.629.11.....	338
40.791.17.....	300	40.831.03.....	322	40.922.79.....	285	46.417.19.....	203	88.695.21.....	338
40.791.19.....	300	40.831.04.....	322	40.922.80.....	285	46.419.19.....	203	88.765.02.....	315
40.791.21.....	300	40.832.01.....	322	40.922.87.....	285	46.421.23.....	204	88.765.03.....	315
40.792.07.....	301	40.832.02.....	322	40.922.88.....	285	46.426.18.....	204		
40.792.09.....	301	40.833.02.....	327	40.924.54.....	284	46.426.22.....	204	90	
40.792.11.....	301	40.834.02.....	327	40.924.55.....	284	46.436.20.....	202	90.316.01.....	332
40.792.17.....	301	40.835.00.....	323	40.924.56.....	284	46.440.01.....	202	90.316.02.....	332
40.792.19.....	301	40.835.01.....	323	40.924.57.....	284	46.440.02.....	202	90.316.03.....	332
40.792.21.....	301	40.835.02.....	323	40.924.58.....	284	46.454.04.....	187	90.316.06.....	332
40.793.07.....	301	40.835.03.....	324	40.924.59.....	284	46.454.07.....	187	90.317.01.....	334
40.793.09.....	301	40.835.04.....	324	40.924.61.....	284	46.454.09.....	187	90.317.02.....	334
40.793.11.....	301	40.836.00.....	324	40.924.62.....	284	46.454.12.....	187	90.317.03.....	334
40.793.17.....	301	40.840.20.....	325	40.924.63.....	284	46.522.01.....	206	90.317.06.....	334
40.793.19.....	301	40.841.25.....	325	40.924.64.....	284	46.522.03.....	206	90.330.01.....	332
40.793.21.....	301	40.843.22.....	325	40.924.65.....	284	46.522.05.....	206	90.330.02.....	332
40.794.07.....	300	40.843.32.....	325	40.924.66.....	284	46.522.07.....	206	90.330.03.....	332
40.794.09.....	300	40.845.25.....	325	40.924.75.....	285	46.522.09.....	206	90.330.06.....	332
40.794.11.....	300	40.847.17.....	325	40.924.76.....	285	46.581.14.....	70	90.331.01.....	335
40.794.17.....	300	40.849.20.....	325	40.924.79.....	285			90.331.02.....	335
40.794.19.....	300	40.850.03.....	326	40.924.80.....	285	48		90.331.03.....	335
40.794.21.....	300	40.850.05.....	326	40.924.82.....	285	48.626.08.....	187	90.331.06.....	335
40.795.07.....	300	40.851.03.....	326	40.924.83.....	285	48.626.11.....	187	90.332.01.....	333
40.795.09.....	300	40.851.05.....	326			56		90.332.02.....	333
40.795.11.....	300	40.852.03.....	326	42		56.131.26.....	213	90.332.03.....	333
40.795.17.....	300	40.852.05.....	326	42.810.10.....	69	56.137.27.....	213	90.332.06.....	333
40.795.19.....	300	40.853.03.....	326	42.811.10.....	69	56.262.16.....	130	90.344.01.....	333
40.795.21.....	300	40.853.05.....	326	42.813.10.....	69			90.344.02.....	333
40.796.07.....	301	40.854.05.....	327			64		90.344.03.....	333
40.796.09.....	301	40.855.05.....	327	44		64.110.15.....	101	90.344.06.....	333
40.796.11.....	301	40.856.24.....	328	44.075.00.....	4	64.110.19.....	101	90.352.01.....	332
40.796.17.....	301	40.857.25.....	13	44.101.03.....	264	64.110.25.....	101	90.352.02.....	332
40.796.19.....	301	40.858.21.....	12	44.101.05.....	264	64.120.15.....	101	90.352.03.....	332
40.796.21.....	301	40.859.01.....	13	44.101.07.....	264	64.120.19.....	101	90.352.06.....	332
40.797.07.....	301	40.859.02.....	13	44.102.20.....	264	64.120.19.....	101	90.352.06.....	332
40.797.09.....	301	40.859.04.....	13	44.102.24.....	264	64.120.22.....	101	90.357.01.....	335
40.797.11.....	301	40.859.05.....	13	44.103.01.....	264	64.120.24.....	101	90.357.02.....	335
40.797.17.....	301	40.859.07.....	13	44.103.02.....	264	64.120.30.....	101	90.357.03.....	335
40.797.19.....	301	40.859.09.....	13	44.103.03.....	264	64.124.16.....	101	90.357.06.....	335
40.797.21.....	301	40.875.22.....	329	44.103.04.....	264	64.124.20.....	101	90.370.01.....	333
40.801.70.....	318	40.876.21.....	329	44.103.11.....	264	64.124.25.....	101	90.370.02.....	333
40.801.90.....	318	40.881.16.....	330	44.103.12.....	264	64.124.30.....	101	90.370.03.....	333
40.802.10.....	318	40.882.16.....	330	44.103.13.....	264			90.370.06.....	333
40.803.11.....	318	40.884.16.....	330	44.104.00.....	264	82		90.371.01.....	335
40.803.13.....	318	40.886.16.....	330	44.105.16.....	264	82.898.17.....	202	90.371.02.....	335
40.803.15.....	318	40.888.14.....	330	44.105.18.....	264	82.899.16.....	202	90.371.03.....	335
40.803.22.....	318	40.892.14.....	330	44.105.20.....	264	82.905.22.....	204	90.371.06.....	335
40.804.21.....	318	40.893.14.....	330	44.105.22.....	264	82.910.09.....	204	90.372.01.....	334
40.805.70.....	318	40.895.14.....	330	44.105.24.....	264			90.372.02.....	334
40.805.80.....	318	40.920.00.....	284	44.206.14.....	70	88		90.372.03.....	334
40.805.90.....	318	40.920.10.....	284	44.206.15.....	70	88.290.01.....	339	90.372.06.....	334
40.810.04.....	319	40.920.11.....	284	44.206.16.....	70	88.290.02.....	339	90.382.01.....	334
40.811.03.....	319	40.920.19.....	285	44.206.18.....	70	88.290.03.....	339	90.382.02.....	334
40.811.04.....	319	40.920.20.....	285			88.290.04.....	339	90.382.03.....	334
40.811.05.....	319	40.920.30.....	285	46		88.290.05.....	339	90.382.06.....	334
40.812.03.....	319	40.920.31.....	285	46.154.20.....	70	88.290.06.....	339		
40.812.04.....	319	40.920.51.....	285	46.156.16.....	70	88.290.07.....	339		
40.812.05.....	319	40.920.52.....	285	46.158.18.....	70	88.290.08.....	339		
40.813.03.....	319	40.920.55.....	285	46.158.19.....	70	88.290.09.....	339		
40.813.04.....	319	40.920.56.....	285	46.175.02.....	281	88.290.10.....	339		
40.813.05.....	319	40.920.57.....	285	46.175.03.....	281	88.291.01.....	339		
40.814.03.....	319	40.920.58.....	285	46.175.04.....	281	88.291.02.....	339		
40.814.04.....	319	40.920.62.....	284	46.220.01.....	281	88.291.03.....	339		
40.814.05.....	319	40.920.63.....	284	46.220.02.....	281	88.291.04.....	339		
40.815.04.....	320	40.920.70.....	284	46.220.03.....	281	88.291.05.....	339		
40.815.06.....	320	40.920.71.....	284	46.221.01.....	281	88.291.06.....	339		
40.817.65.....	320	40.920.73.....	284	46.221.02.....	281	88.291.07.....	339		
40.819.65.....	320	40.920.74.....	284	46.221.03.....	281	88.291.08.....	339		
40.821.65.....	321	40.920.75.....	286	46.221.04.....	281	88.291.09.....	339		
40.823.00.....	321	40.920.76.....	286	46.221.05.....	281	88.291.10.....	339		
40.824.03.....	321	40.920.78.....	284	46.303.03.....	282	88.292.01.....	339		
40.824.04.....	321	40.920.79.....	284	46.303.04.....	282	88.292.02.....	339		
40.824.06.....	321	40.920.80.....	285	46.303.05.....	282	88.292.03.....	339		
						88.292.04.....	339		

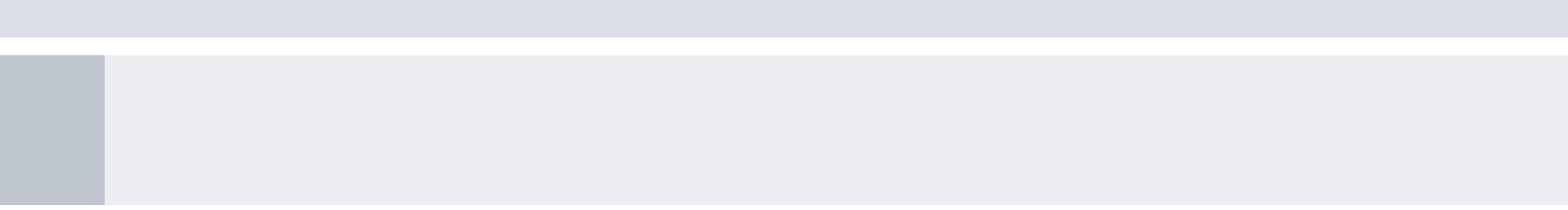



info@dimeda.de
www.dimeda.de

DIMEDA Instrumente GmbH
Gänsäcker 54+58
78532 Tuttlingen
Germany

+49 (0) 7462 | 94 61 - 0
+49 (0) 7462 | 94 61 - 33

© DIMEDA Instrumente GmbH
Art. Nr. 99.999.13 | V2
06.2019 | Printed in Germany

Technische Änderungen vorbehalten
subject to technical modifications