

***dimedda***<sup>®</sup>  
SURGICAL INSTRUMENTS



# HERZ-, GEFÄß- UND THORAXCHIRURGIE

CARDIOVASCULAR AND THORACIC SURGERY  
CHIRURGIE CARDIOVASCULAIRE ET THORACIQUE  
CIRUGÍA CARDIOVASCULAR Y TORÁCICA  
CHIRURGIA CARDIOVASCOLARE E TORACICA











# [ DAS UNTERNEHMEN ]

„Mit unseren Instrumenten wird nicht gespielt, sie retten Leben.“

*„Our instruments are not to play, they save lives.“*

## [DEUTSCH]

Seit 1976 sind wir erfolgreich in der Medizinbranche tätig. Wir bieten ein komplettes Programm chirurgischer Instrumente an. Im Mittelpunkt aller Maßnahmen und Aktivitäten unseres Hauses steht der Kunde. Seine Wünsche, Ansprüche und Anforderungen sind für uns eine tägliche Herausforderung. Deshalb ist absolute Kundenorientierung für uns oberstes Prinzip. Sie prägt unsere Geschäftspolitik und ist jederzeit Ansporn für das Handeln und Denken unserer Mitarbeiter. Daher sind wir stets für morgen gerüstet. Unser Qualitätsmanagement ist ein essentieller Bestandteil unserer langfristigen Unternehmensstrategie, in die jeder einzelne Mitarbeiter eingebunden ist und die von einem Wir-Gefühl getragen wird. Unabhängig vom jeweiligen Arbeitsplatz, fühlt sich jeder DIMEDA-Mitarbeiter für die Einhaltung der Qualität verantwortlich.

Wir verfügen über modernste Logistik. Unser umfassendes Lager garantiert schnelle Lieferzeiten. Sollten Artikel nicht lagermäßig vorrätig sein, so können diese durch einen speziellen Service kurzfristig zur Verfügung gestellt und versendet werden. Alle Instrumente und Geräte aus unserem Sortiment werden von geschulten und erfahrenen Fachkräften mit handwerklichem Geschick unter Einsatz modernster Maschinen und Anlagen hergestellt. Dabei kommen ausnahmslos Materialien zum Einsatz, die unseren besonders hohen Qualitätsstandards genügen. Unsere Produktpalette mit mehr als 23.000 verschiedenen Standardinstrumenten für die Human-, Dental und Veterinärmedizin wird durch die enge Zusammenarbeit mit unseren Kunden, Ärzten und Wissenschaftlern im In- und Ausland ständig erweitert und nach dem neuesten Stand der Technik optimiert.

## [ENGLISH]

*Since 1976 we have been working successfully in the medical field. The focus of all our measures and activities is the customer. His wishes, demands and requirements are a daily challenge for us. Therefore, customer service is our top priority. It effects our business policy and is a permanent task for every member of our team. For this reason we are prepared for the future at any time. Our Quality Management is an essential component in our long-term company strategy in which every single employee is involved and which is supported by a common feeling. Every DIMEDA employee feels himself responsible for observance of quality no matter in which department he is working.*

*Our extensive warehouse guarantees quick delivery times. Articles which are not available ex stock can be supplied in a short time due to a special service. All instruments and devices of our product range are manufactured by well-trained and experienced skilled workers with special craftsmanship and by use of most modern machines and equipment. We only use materials which meet our high quality standards. Our product range with more than 23,000 different standard instruments for Human, Dental and Veterinary medical applications is permanently increased and optimized as per the state of the art by the close cooperation of our domestic and foreign customers, physicians and scientists.*

# [ LOGISTIK ]

„Einmal um die ganze Welt“

*„All around the world.“*



## [DEUTSCH]

Seit 40 Jahren nutzen Ärzte weltweit unsere chirurgischen Instrumente. Es gibt kaum ein Land, in dem wir nicht vertreten sind. Von unserem Lager bis zu ihrem Bestimmungsort hat unsere Ware oft einen langen Weg hinter sich. Wir setzen logistisch alles daran, dass Ihre Bestellung rechtzeitig und zu Ihrer Zufriedenheit eintrifft.

## [ENGLISH]

*Since 40 years physicians and surgeons all over the world are using our surgical instruments. There is hardly a country where we do not have a distributor.*

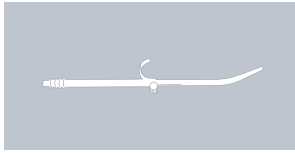
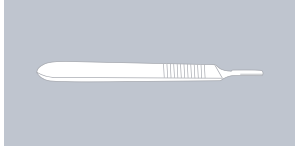
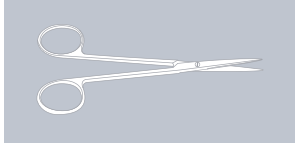
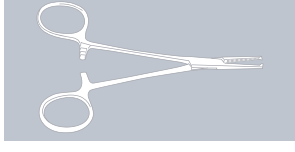
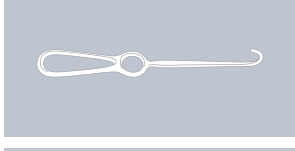
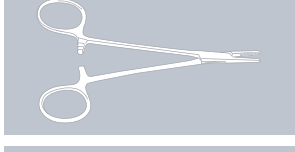
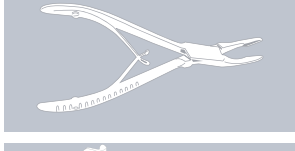
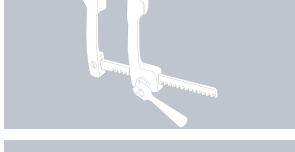
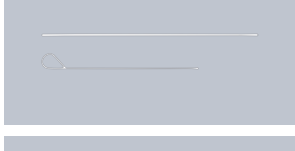

01	<b>SAUGROHRE</b> SUCTION TUBES TUBES D'ASPIRATION TUBOS DE ASPIRACIÓN TUBI D'ASPIRAZIONE		1 - 8
02	<b>SKALPELLE, AORTASTANZEN</b> SCALPELS, AORTIC PUNCHES BISTOURIS, PERFORATEURS POUR L'AORTE BISTURÍS, PERFORADORES AÓRTICOS BISTURI, PINZE TAGLIENTI PER AORTA		9 - 18
03	<b>SCHEREN</b> SCISSORS CISEAUX TIJERAS FORBICI		19 - 46
04	<b>PINZETTEN &amp; KLEMMEN</b> FORCEPS AND CLAMPS PINCES ET CLAMPS PINZAS Y CLAMPS PINZE E CLAMPS		47 - 184
05	<b>WUNDHAKEN</b> RETRACTORS ÉCARTEURS SEPARADORES DIVARICATORI		185 - 228
06	<b>NADELHALTER</b> NEEDLE HOLDERS PORTE-AIGUILLES PORTA-AGUJAS PORT'AGHI		229 - 246
07	<b>ORTHOPÄDIE</b> ORTHOPAEDICS CHIRURGIE OSSEUSE CIRUGÍA ÓSEA CHIRURGIA OSSEA		247 - 280
08	<b>RIPPENSPERRER</b> RIB SPREADERS ECARTEURS POUR COSTAUX SEPARADORES COSTALES DIVARICATORI COSTALI		281 - 308
09	<b>SONDEN, DILATATOREN</b> PROBES, DILATORS SONDES, DILATATEURS SONDAS, DILATADORES SONDA, DILATATORI		309 - 324
10	<b>THORAKOSKOPIE</b> THORACOSCOPY THORACOSCOPIE TORACOSCOPIA TORACOSCOPIA		325 - 330
11	<b>INHALTSVERZEICHNIS</b> INDEX INDEX ÍNDICE ALFABÉTICO INDICE ALFABETICO		331 - 348
12	<b>NUMMERNVERZEICHNIS</b> NUMERICAL INDEX INDEX NUMÉRIQUE ÍNDICE NUMÉRICO INDICE NUMERICO		349 - 357

# 01

◆ SAUGROHRE

SUCTION TUBES

TUBES D'ASPIRATION

TUBOS DE ASPIRACIÓN

TUBI D'ASPIRAZIONE







### Saugrohre

Suction tubes  
Tubes d'aspiration  
Tubos de aspiración  
Tubi d'aspirazione

Ø 10 mm  
30 Fr.



**POOLE**  
04.130.10  
23 cm/8¾"

Ø 5,5 mm  
16-17 Fr.



**BABY-POOLE**  
04.140.06  
20 cm/10"

Ø 8 mm  
23-24 Fr.



**POOLE**  
04.140.08  
23 cm/8¾"

Länge  
Total length  
Longueur  
Largura  
Lunghezza

Nutzlänge  
Working length  
Longueur utile  
Largura útil  
Lunghezza utile



#### D'AMICO

45 cm/17¾"	32 cm/12½"	04.182.01	04.182.02
------------	------------	-----------	-----------

#### WOLF

31 cm/12¼"	17 cm/6¾"	04.184.02	04.184.03
36 cm/14¼"	22 cm/8¾"	04.184.00	04.184.01

Ø 3,2 mm

Ø 5 mm



**WOLF**



**D'AMICO**

Ø 8 mm



**COOLEY**  
 04.141.35  
 35 cm/14"

Ø 9 mm



**COOLEY**  
 04.143.31  
 31 cm/12½"

Ø 8 mm



**COOLEY**  
 04.145.30  
 30 cm/12"

Ø 9 mm      13cm/5½"      90°



Ø 8 mm

**COOLEY**  
 04.147.33  
 33 cm/13¼"

**COOLEY**  
 04.147.90  
 25 cm/10"



**Saugrohre**

Suction tubes

Tubes d'aspiration

Tubos de aspiración

Tubi d'aspirazione

**04.150.98**

Saugspitze

Suction tip

Pointe de succion

Cabezal para aspiración

Punta per aspirazione



mit zentraler Bohrung  
Ø 2,0 mm

with central bore  
Ø 2.0 mm

avec trou central  
Ø 2,0 mm

con un agujero central  
Ø 2,0 mm

con un foro centrale  
Ø 2,0 mm

**YANKAUER-BABY**

**04.150.22**  
22 cm/8¾"



komplett mit Saugspitze  
und Schlaucholive

complete with suction tip  
and connector

complet avec pointe de  
suction et raccord

completo con punta de  
succión y conector

completo con punte d'a-  
spirazione e raccordo

**YANKAUER**

**04.149.27**  
28,5  
cm/11¼"



**04.150.99**

Schlaucholive  
Olive  
Olive  
Oliva  
Oliva

**YANKAUER**

**04.150.27**  
27 cm/10¼"



mit Absperrventil und  
abschraubbarem Rohr

with stopcock and tube  
to be screwed off

avec robinet et canule  
extérieure démontable

con interruptor y tubo  
desenroscable

con interruttore e tubo  
svitabile

**WALTON YANKAUER**

**04.152.33**  
ø 10 mm (30 Charr.)  
33 cm/13"



Saug- und Spülkanülen  
Suction and irrigation cannulas  
Canules d'aspiration et d'irrigation  
Cánulas para aspiración e irrigación  
Canula per aspirazione e irrigazione

Saugkanülen mit  
Unterbrecher

Suction cannulas  
with finger cut-off

Canules d'aspiration  
avec interrupteur à doigt

Cánulas para aspiración  
con interruptor

Canula per aspirazione con  
interruttore



Ø 5 mm

Ø 9 mm

**DE BAKEY**  
16 cm/6¼"    **04.154.16**  
26 cm/10¼"   **04.154.26**

Ø 6 mm



**ANDREWS-PYNCHON**  
**04.153.24**  
24 cm/9½"



**DE BAKEY**  
**04.154.27**  
28 cm/11"



Ø 7 mm

**FINSTERER**  
**04.158.00**  
32 cm/12½"



Ø 5 mm

**BRAUN-RALPH**  
**04.181.31**  
31 cm/12¼"

## Saugrohre

Suction tubes

Tubes d'aspiration

Tubos de aspiración

Tubi d'aspirazione

Ø 4 mm

isoliert  
insulated  
isolé  
aislados  
isolato



Ø 6 - 9 mm

**FERGUSSON**  
**40.291.04**  
18 cm/7"

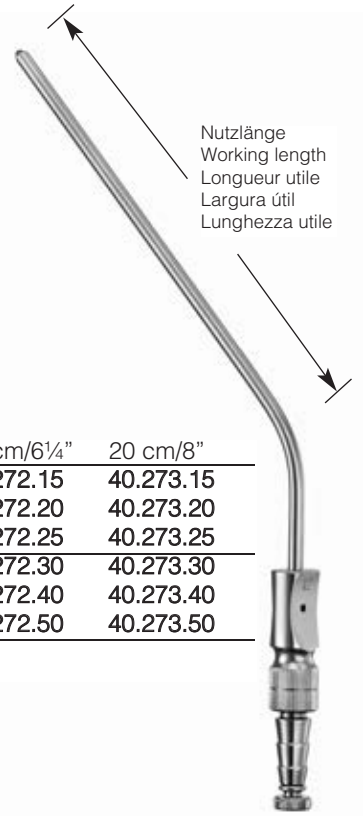

Nutzlänge  
Working length  
Longueur utile  
Largura útil  
Lunghezza utile

**FERGUSSON**

Ø mm	F.G. Charr.	11 cm/4¼"	13 cm/5"	16 cm/6¼"	20 cm/8"
Ø 1,5 mm	4 - 5	40.270.15	40.271.15	40.272.15	40.273.15
Ø 2,0 mm	6	40.270.20	40.271.20	40.272.20	40.273.20
Ø 2,5 mm	7 - 8	40.270.25	40.271.25	40.272.25	40.273.25
Ø 3,0 mm	9	40.270.30	40.271.30	40.272.30	40.273.30
Ø 4,0 mm	12	40.270.40	40.271.40	40.272.40	40.273.40
Ø 5,0 mm	15	40.270.50	40.271.50	40.272.50	40.273.50

Saugkanülen mit Unterbrecher und Mandrin  
Suction cannulas with finger cut-off and stylet  
Canules d'aspiration avec interrupteur à doigt  
Cánulas para aspiración con interruptor y estilete  
Cannule per aspirazione con interruttore e stiletto

F.G. Charr.	Ø mm	
6	2,0	40.275.06
8	2,7	40.275.08
10	3,3	40.275.10
12	4,0	40.275.12

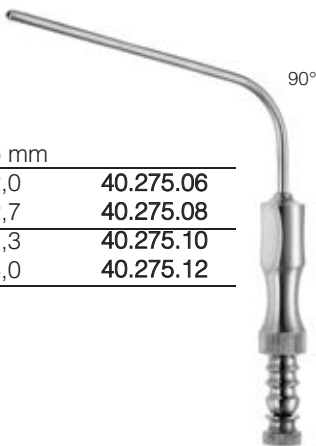

**POPPEN**  
13 cm/5"

F.G. Charr.	Ø mm	30°	75°
6	2,0	40.295.06	40.297.06
7	2,3	40.295.07	40.297.07
8	2,7	40.295.08	40.297.08
9	3,0	40.295.09	40.297.09
10	3,3	40.295.10	40.297.10
11	3,7	40.295.11	40.297.11
12	4,0	40.295.12	40.297.12
15	5,0	40.295.15	40.297.15



**FRAZIER**  
19 cm/7½"



**ADSON**  
**40.290.21**  
Ø 4 mm (12 Charr.)  
21 cm/8¼"

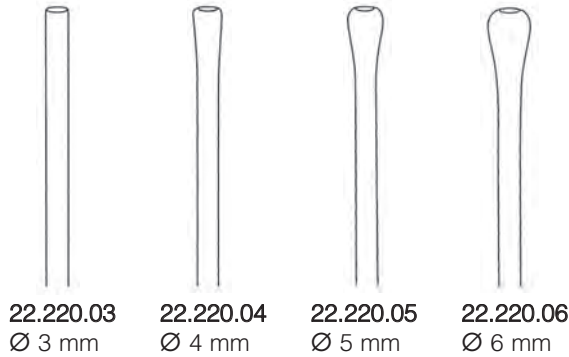

Gefäßspülkanülen  
 biegsam, versilbert, mit LUER-LOCK Ansatz

Vascular irrigation cannulas  
 malleable, silver plated, LUER-LOCK connection

Aiguilles vasculaires pour irrigation, malléables,  
 argentées, avec cône LUER-LOCK

Cánulas vasculares para irrigación, maleables,  
 plateadas, con conexión LUER-LOCK

Cannule vascolari per irrigazione, malleabile,  
 argentées, attacco LUER-LOCK

**SCHMID**  
 15 cm/6"



Venenkanülen  
 Vein cannulas  
 Canules veineuses  
 Cánulas para venas  
 Cannule per vene

Knopfende mit Schlaucholive  
 Button end with tube connector  
 Aboutonné avec connection pour tubes  
 Abotonado con conexión para tubos a  
 Bottone con raccordo per tubi

1,2 x 80 mm	<b>22.225.12</b>
1,5 x 80 mm	<b>22.225.15</b>

Heparinnadel, LUER-LOCK Ansatz  
 Heparin flushing needle, LUER-LOCK connection  
 Aiguille pour héparine, cône LUER-LOCK  
 Aguja para heparina, conexión LUER-LOCK  
 Ago per eparina, raccordo LUER-LOCK



**MOCK-DEBAKEY**

1,5 x 53 mm	<b>22.370.15</b>	<b>I.M.A.</b>
2,0 x 45 mm	<b>22.370.02</b>	
3,0 x 45 mm	<b>22.370.03</b>	
3,0 x 65 mm	<b>22.372.06</b>	<b>MOCK</b>
3,7 x 54 mm	<b>22.370.37</b>	
4,0 x 63 mm	<b>22.370.04</b>	<b>ZANGER</b>
5,0 x 160 mm	<b>22.370.05</b>	

Heparininjektor, LUER-LOCK Ansatz  
 Heparin injector, LUER-LOCK connection  
 Injecteur pour héparine, cône LUER-LOCK  
 Injector para heparina, conexión LUER-LOCK  
 Iniettore per eparina, raccordo LUER-LOCK



**DEBAKEY**

4,0 x 150 mm	<b>22.373.04</b>
--------------	------------------



**GARRETT**

8,0 x 109 mm	<b>22.375.08</b>
15,0 x 120 mm	<b>22.375.12</b>

## Brustfell-Trokare, Pleurabiopsie-Nadel

Thoracic trocars, pleural biopsy needle

Trocarts, aiguille de biopsie pleurale

Trócares, aguja de la biopsia pleural

Trequarti, ago per biopsia pleurica



**OCHSNER**  
14,5 cm/5¾"

Trokare	für Katheter	
Trocars	for catheters	
Trocarts	pour cathéters	
Trócares	para catéteres	
Trequarti	per cateteri	
10 Charr.	6 Charr.	<b>22.150.10</b>
12 Charr.	8 Charr.	<b>22.150.12</b>
14 Charr.	10 Charr.	<b>22.150.14</b>
16 Charr.	12 Charr.	<b>22.150.16</b>
17 Charr.		<b>22.150.17</b>
18 Charr.	14 Charr.	<b>22.150.18</b>
20 Charr.	16 Charr.	<b>22.150.20</b>
22 Charr.	18 Charr.	<b>22.150.22</b>
24 Charr.	20 Charr.	<b>22.150.24</b>
28 Charr.		<b>22.150.28</b>



**NELSON**  
21 cm/8¼"

Außen-Ø	Innen-Ø	
Outer Ø	Inner Ø	
Ø extérieur	Ø intérieur	
Ø exterior	Ø interior	
Ø esterno	Ø interno	
8,3 mm/25 Charr.	7,3 Charr.	<b>22.170.25</b>
10 mm/30 Charr.	9,0 Charr.	<b>22.170.30</b>
11 mm/33 Charr.	12 Charr.	<b>22.170.33</b>
11,7 mm/35 Charr.	10,7 Charr.	<b>22.170.35</b>

Pleurabiopsie-Nadel, mit LUER-Lock Ansatz  
Pleural biopsy needle, LUER-LOCK connection  
Aiguille de biopsie pleurale, avec cône LUER-LOCK  
Aguja de biopsia pleural, con conexión LUER-LOCK  
Ago per biopsia pleurica, attacco LUER-LOCK

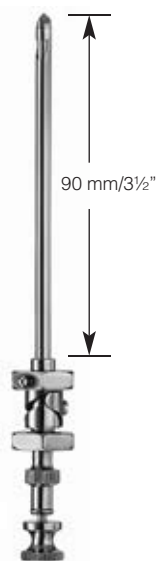

**ABRAMS**  
**22.260.00**  
ø 4 mm (8 G)  
14 cm/5½"

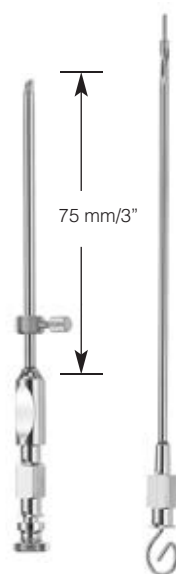

**COPE**  
**22.264.00**  
ø 3 mm (11 G)

# 02

◆ SKALPELLE, AORTASTANZEN

SCALPELS, AORTIC PUNCHES

BISTOURIS, PERFORATEURS POUR L'AORTE

BISTURÍS, PERFORADORES AÓRTICOS

BISTURI, PINZE TAGLIENTI PER AORTA





### Skalpellgriffe

Scalpel handles  
Manches de bistouris  
Mangos de bisturís  
Manici per bisturi

Skalpellgriffe, passend für  
auswechselbare Skalpellklingen  
Fig. 10, 11, 12, 13, 15

Scalpel handles for scalpel  
blades fig. 10, 11, 12, 13, 15

Manches pour lames de  
bistouris interchangeables  
fig. 10, 11, 12, 13, 15

Mangos de bisturí para  
hojas intercambiables  
fig. 10, 11, 12, 13, 15

Manici per bisturi, per fissare le  
lame intercambiabili  
fig. 10, 11, 12, 13, 15

massiv, mit Zentimeter Graduierung  
solid, cm-graduation  
solide, gradué en cm  
macizo, graduado en cm  
pieno, graduato in cm

lang  
long  
long  
largo  
lungo

abgewinkelt, lang  
angled, long  
coudé, long  
angulado, largo  
angolare, lungo

rund  
round  
rond  
redondo  
rotondo

rund, abgewinkelt  
round, angled  
rond, coudé  
redondo, angulado  
rotondo, angolare

Fig.  
3



06.103.00  
12 cm/4¾"  
Fig. 3



06.103.01  
12 cm/4¾"  
No. 3



06.103.02  
21,5 cm/8½"  
Fig. 3 L



06.103.06  
21 cm/8¼"  
Fig. 3 L



06.103.03  
14,5 cm/5¾"  
Fig. 3 R



06.103.33  
14 cm/5½"  
Fig. 3 R

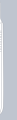

Fig.  
3

Skalpellgriffe, passend für  
auswechselbare Skalpellklingen  
Fig. 10, 11, 12, 13, 15

Scalpel handles for scalpel  
blades fig. 10, 11, 12, 13, 15

Manches pour lames de  
bistouris interchangeables  
fig. 10, 11, 12, 13, 15

Mangos de bisturí para  
hojas intercambiables  
fig. 10, 11, 12, 13, 15

Manici per bisturi, per fissare le  
lame intercambiabili  
fig. 10, 11, 12, 13, 15

abgewinkelt  
angled  
coudé  
angulado  
angolare



06.105.00  
16 cm/6¼"  
No. 5



06.106.00  
21,5 cm/8½"  
No. 5



06.106.01  
21 cm/8¼"  
No. 5



## Skalpellgriffe

Scalpel handles  
Manches de bistouris  
Mangos de bisturis  
Manici per bisturi

Skalpellgriffe, passend für  
auswechselbare Skalpellschneiden  
Fig. 10, 11, 12, 13, 15

Scalpel handles for scalpel  
blades fig. 10, 11, 12, 13, 15

Manches pour lames de  
bistouris interchangeables  
fig. 10, 11, 12, 13, 15

Mangos de bisturí para  
hojas intercambiables  
fig. 10, 11, 12, 13, 15

Manici per bisturi, per fissare le  
lame intercambiabili  
fig. 10, 11, 12, 13, 15

Fig.  
3







Fig.  
4

Skalpellegriffe, passend für  
 auswechselbare Skalpellklingen  
 Fig. 18, 19, 20, 21, 22, 23, 24, 25, 34, 36

Scalpel handles for scalpel  
 blades fig. 18, 19, 20, 21, 22, 23, 24, 25, 34, 36

Manches pour lames de bistouris  
 interchangeables  
 fig. 18, 19, 20, 21, 22, 23, 24, 25, 34, 36

Mangos de bisturí para  
 hojas intercambiables  
 fig. 18, 19, 20, 21, 22, 23, 24, 25, 34, 36

Manici per bisturi, per fissare  
 le lame intercambiabili  
 fig. 18, 19, 20, 21, 22, 23, 24, 25, 34, 36

mit Zentimeter-Graduierung  
 cm-graduation  
 gradué en cm  
 graduado en cm  
 graduato in cm

lang  
 long  
 long  
 longo

abgewinkelt, lang  
 angled, long  
 coudé, long  
 angulado, largo  
 angolare, lungo



06.104.00  
 13,5 cm/5¼"  
 Fig. 4



06.104.01  
 13,5 cm/5¼"  
 Fig. 4



06.104.02  
 21 cm/8¼"  
 Fig. 4 L



06.104.06  
 21 cm/8¼"  
 Fig. 4 L



**Skalpellslingen, steril**  
 Scalpel blades, sterile  
 Lames des bistouris, stériles  
 Hojas de bisturis estériles  
 Lame da bisturi, sterile

**Fig.  
3**

für Skalpellgriff Fig. 3  
 for scalpel handle fig. 3  
 pour manche de bistouris fig. 3  
 para mango de bisturis fig. 3  
 per manico per bisturi fig. 3



06.110.00  
Fig. 10



06.111.00  
Fig. 11

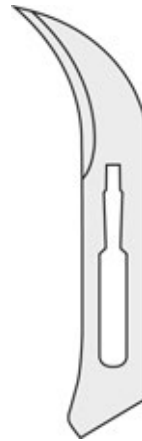

06.112.00  
Fig. 12

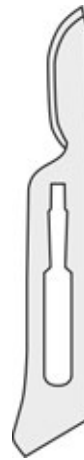

06.115.00  
Fig. 15

in Packungen à 100 Stück  
 in packages of 100 pieces  
 en boîtes de 100 pièces  
 en cajas de 100 piezas  
 in scatole di 100 pezzi



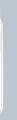
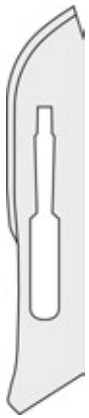

Fig.  
4

für Skalpellgriff Fig. 4  
for scalpel handle fig. 4  
pour manche de bistouris fig. 4  
para mango de bisturís fig. 4  
per manico per bisturi fig. 4



06.120.00  
Fig. 20



06.121.00  
Fig. 21



06.122.00  
Fig. 22



06.123.00  
Fig. 23

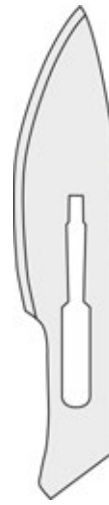

06.124.00  
Fig. 24

Skalpellklingen-Entferner  
Scalpel blade remover  
Enlève-lame  
Quita hojas  
Distributore lame

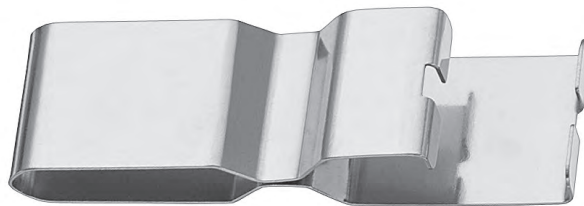

06.199.00



### Mikro Skalpellgriffe, Mikro-Skalpellklingen

Micro scalpel handles, micro scalpel blades

Micro manches pour bistouris, micro lames de bistouris

Micro mangos de bisturí, micro hojas de bisturí

Micro manici per bisturi, micro lame per bisturi

in Packungen à 10 Stück, steril  
in packages of 10 pieces, sterile  
en boîtes de 10 pièces, stériles  
en cajas de 10 piezas, estériles  
in scatole di 10 pezzi, sterile



06.302.13  
13,5 cm/5¼"

06.304.15  
15,5 cm/6"



40.859.01  
Fig. 61



40.859.02  
Fig. 62



40.859.04  
Fig. 64



40.859.05  
Fig. 65



40.859.07  
Fig. 67



40.859.09  
Fig. 69

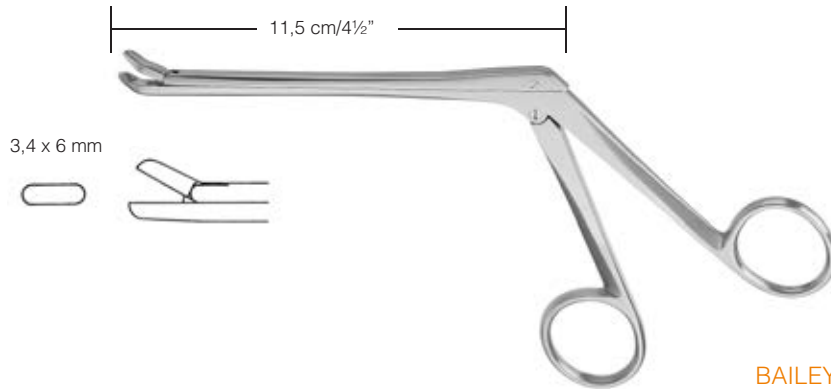

**BAILEY**

**56.298.00**

gerade  
 straight  
 droit  
 recta  
 diritto

**56.298.02**

25° nach unten  
 25° downwards  
 25° vers le bas  
 25° hacia abajo  
 25° in basso

**56.298.04**

70° nach unten  
 70° downwards  
 70° vers le bas  
 70° hacia abajo  
 70° in basso

**56.298.06**

90° nach rechts unten  
 90° right downwards  
 90° vers le bas à droite  
 90° hacia derecha abajo  
 90° in destra basso

**56.298.08**

45° nach links schneidend  
 45° left side cutting  
 45° coupe à gauche  
 45° cortante hacia izquierda  
 45° tagliente a sinistra

**56.298.10**

45° nach rechts schneidend  
 45° right side cutting  
 45° coupe à droite  
 45° cortante hacia derecha  
 45° tagliente a destra

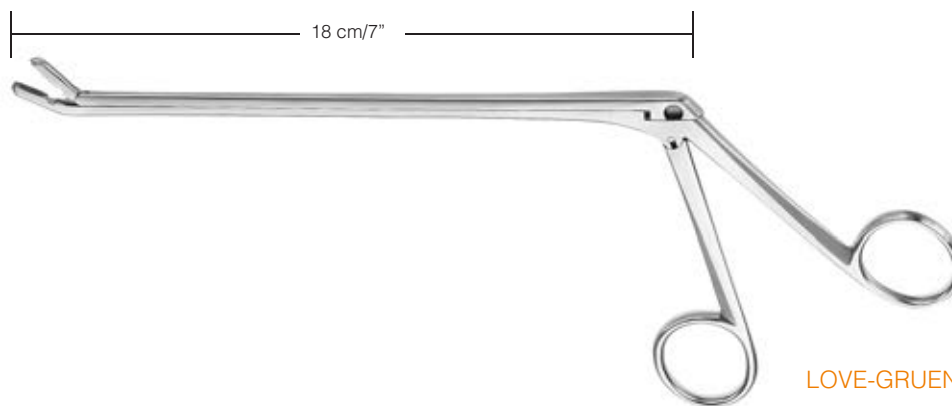

**LOVE-GRUENWALD**

3 x 10 mm



gerade  
 straight  
 droit  
 recta  
 diritto

**40.432.01**

3 x 10 mm

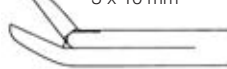
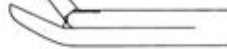

nach oben  
 upwards  
 vers le haut  
 hacia arriba  
 in alto

**40.432.02**

3 x 10 mm

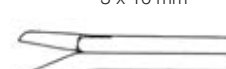

nach unten  
 downwards  
 vers le bas  
 hacia abajo  
 in basso

**40.432.03**

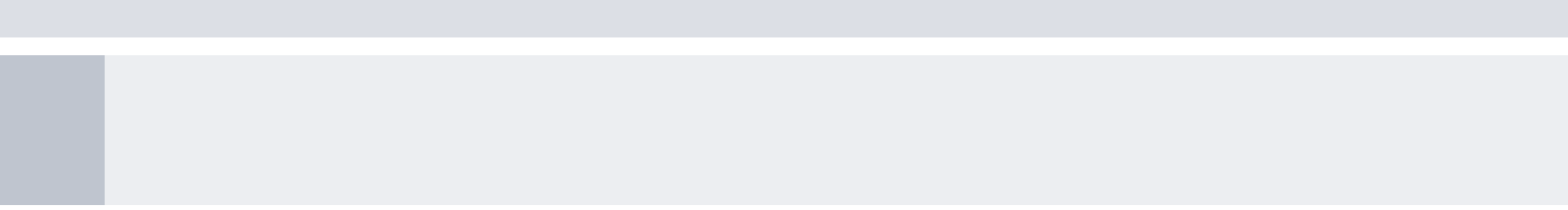

# 03

◆ SCHEREN

SCISSORS

CISEAUX

TIJERAS

FORBICI

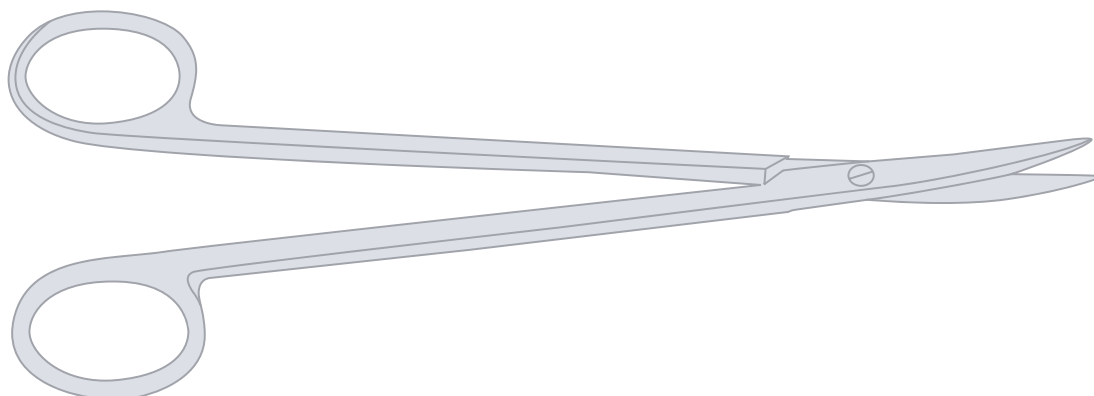



## Chirurgische Scheren

Operating scissors  
Ciseaux à chirurgie  
Tijeras para cirugía  
Forbici per chirurgia

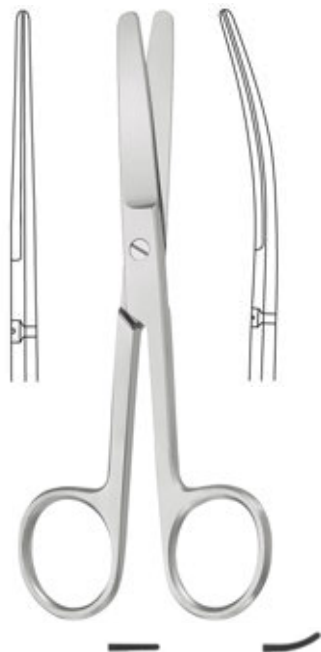

10,5 cm/4¼"	08.102.10	08.103.10
11,5 cm/4½"	08.102.11	08.103.11
13 cm/5"	08.102.13	08.103.13
14,5 cm/5¾"	08.102.14	08.103.14
15,5 cm/6¼"	08.102.15	08.103.15
16,5 cm/6½"	08.102.16	08.103.16
18,5 cm/7¼"	08.102.18	08.103.18
20 cm/8"	08.102.20	08.103.20



TC-Schneiden  
TC cutting edges  
Tranchant TC  
Filos de corte TC  
Taglio TC

14,5 cm/5¾"	08.104.14	08.105.14
16,5 cm/6½"	08.104.16	08.105.16
18,5 cm/7¼"	08.104.18	08.105.18

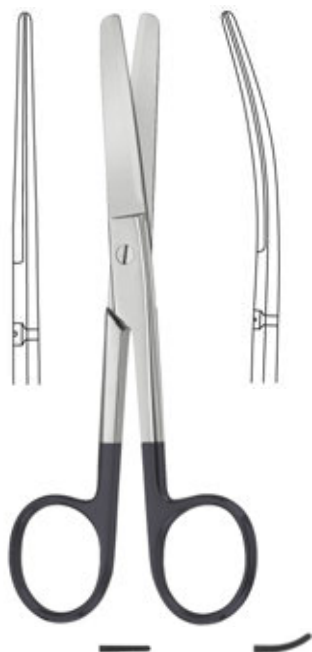

**SUPERCUT**

10,5 cm/4¼"	07.102.10	07.103.10
11,5 cm/4½"	07.102.11	07.103.11
13 cm/5"	07.102.13	07.103.13
14,5 cm/5¾"	07.102.14	07.103.14
15,5 cm/6¼"	07.102.15	07.103.15
16,5 cm/6½"	07.102.16	07.103.16
18,5 cm/7¼"	07.102.18	07.103.18
20 cm/8"	07.102.20	07.103.20



TC-Schneiden  
TC cutting edges  
Tranchant TC  
Filos de corte TC  
Taglio TC

14,5 cm/5¾"	07.104.14	07.105.14
16,5 cm/6½"	07.104.16	07.105.16



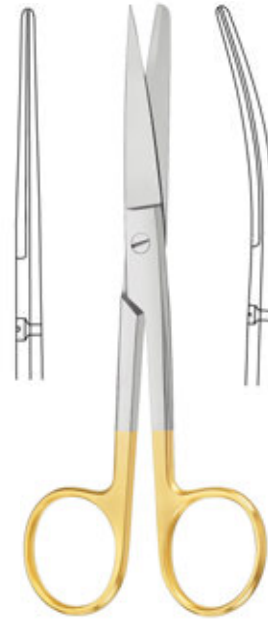
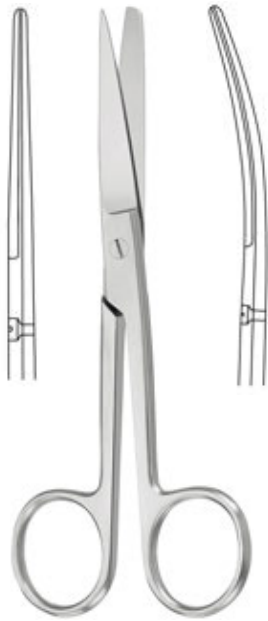

TC-Schneiden  
TC cutting edges  
Tranchant TC  
Filos de corte TC  
Taglio TC

10,5 cm/4¼"	08.110.10	08.111.10
11,5 cm/4½"	08.110.11	08.111.11
13 cm/5"	08.110.13	08.111.13
14,5 cm/5¾"	08.110.14	08.111.14
15,5 cm/6¼"	08.110.15	08.111.15
16,5 cm/6½"	08.110.16	08.111.16
18,5 cm/7¼"	08.110.18	08.111.18
20 cm/8"	08.110.20	08.111.20

14,5 cm/5¾"	08.114.14	08.115.14
16,5 cm/6½"	08.114.16	08.115.16
18,5 cm/7¼"	08.114.18	08.115.18

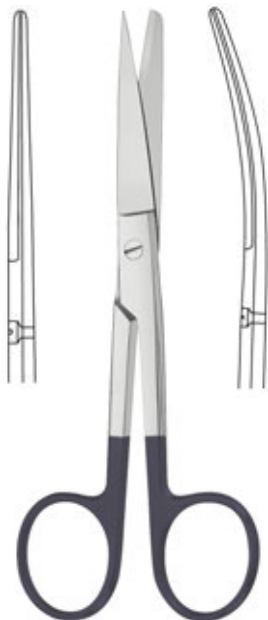

**SUPERCUT**

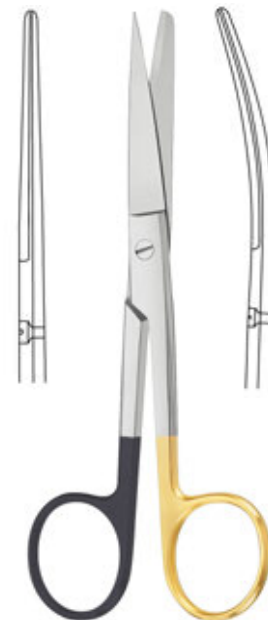

TC-Schneiden  
TC cutting edges  
Tranchant TC  
Filos de corte TC  
Taglio TC

11,5 cm/4½"	07.110.11	07.111.11
13 cm/5"	07.110.13	07.111.13
14,5 cm/5¾"	07.110.14	07.111.14
15,5 cm/6¼"	07.110.15	07.111.15
16,5 cm/6½"	07.110.16	07.111.16
18,5 cm/7¼"	07.110.18	07.111.18
20 cm/8"	07.110.20	07.111.20

14,5 cm/5¾"	07.114.14	07.115.14
16,5 cm/6½"	07.114.16	07.115.16



## Chirurgische Scheren

Operating scissors  
Ciseaux à chirurgie  
Tijeras para cirugía  
Forbici per chirurgia

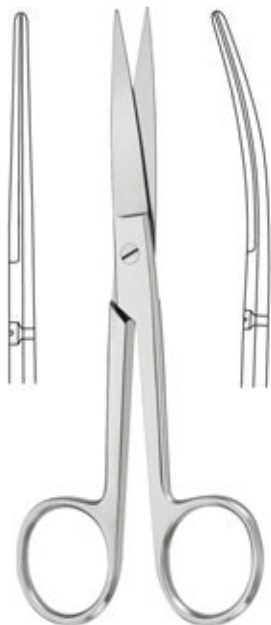

10,5 cm/4 $\frac{1}{4}$ "	08.120.10	08.121.10
11,5 cm/4 $\frac{1}{2}$ "	08.120.11	08.121.11
13 cm/5"	08.120.13	08.121.13
14,5 cm/5 $\frac{3}{4}$ "	08.120.14	08.121.14
15,5 cm/6 $\frac{1}{4}$ "	08.120.15	08.121.15
16,5 cm/6 $\frac{1}{2}$ "	08.120.16	08.121.16
18,5 cm/7 $\frac{1}{4}$ "	08.120.18	08.121.18
20 cm/8"	08.120.20	08.121.20

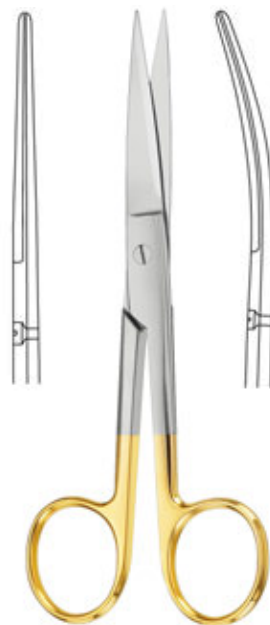

14,5 cm/5 $\frac{3}{4}$ "	08.124.14	08.125.14
16,5 cm/6 $\frac{1}{2}$ "	08.124.16	08.125.16
18,5 cm/7 $\frac{1}{4}$ "	08.124.18	08.125.18

TC-Schneiden  
TC cutting edges  
Tranchant TC  
Filos de corte TC  
Taglio TC

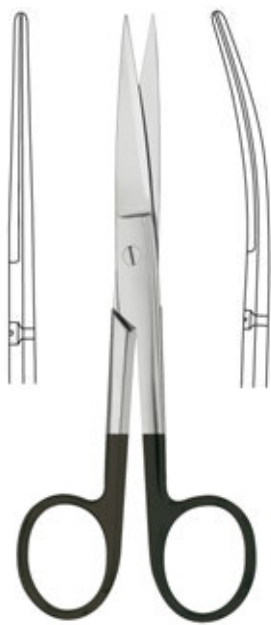

10,5 cm/4 $\frac{1}{4}$ "	07.120.10	07.121.10
11,5 cm/4 $\frac{1}{2}$ "	07.120.11	07.121.11
13 cm/5"	07.120.13	07.121.13
14,5 cm/5 $\frac{3}{4}$ "	07.120.14	07.121.14
15,5 cm/6 $\frac{1}{4}$ "	07.120.15	07.121.15
16,5 cm/6 $\frac{1}{2}$ "	07.120.16	07.121.16
18,5 cm/7 $\frac{1}{4}$ "	07.120.18	07.121.18
20 cm/8"	07.120.20	07.121.20

**SUPERCUT**



14,5 cm/5 $\frac{3}{4}$ "	07.124.14	07.125.14
16,5 cm/6 $\frac{1}{2}$ "	07.124.16	07.125.16

TC-Schneiden  
TC cutting edges  
Tranchant TC  
Filos de corte TC  
Taglio TC

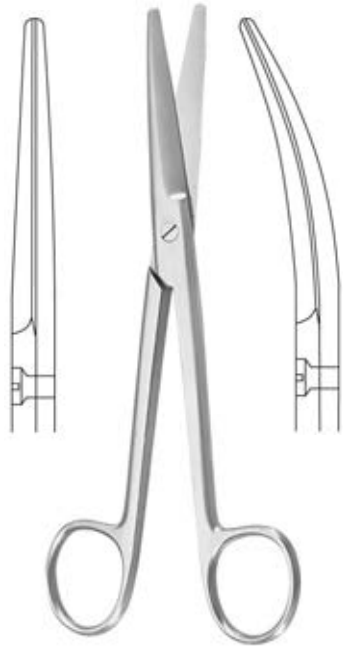

MAYO

14,5 cm/5¾"	08.160.14	08.161.14
17 cm/6¾"	08.160.17	08.161.17
19 cm/7½"	08.160.19	08.161.19
23 cm/9"	08.160.23	08.161.23
28 cm/11"	08.160.28	08.161.28

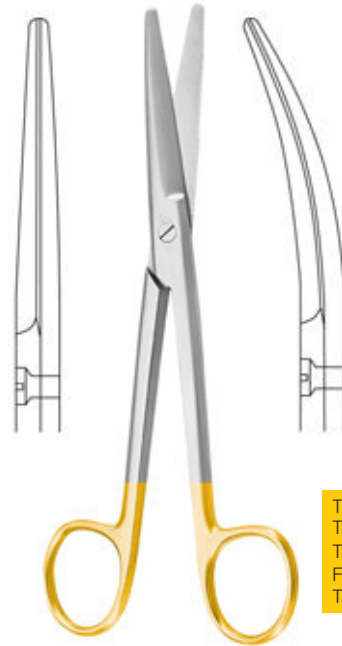

MAYO

14,5 cm/5¾"	08.164.14	08.165.14
17 cm/6¾"	08.164.17	08.165.17
23 cm/9"	08.164.23	08.165.23

TC-Schneiden  
 TC cutting edges  
 Tranchant TC  
 Filos de corte TC  
 Taglio TC

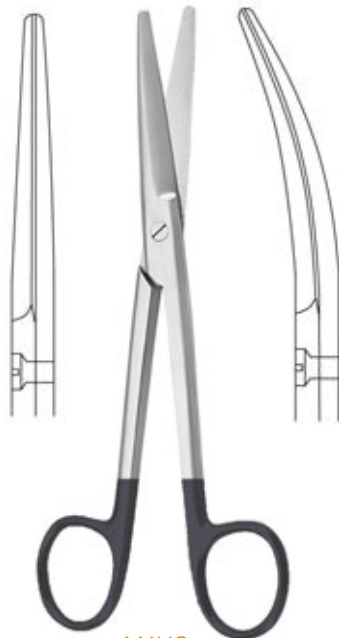

MAYO

14,5 cm/5¾"	07.160.14	07.161.14
17 cm/6¾"	07.160.17	07.161.17
23 cm/9"	07.160.23	07.161.23

**SUPERCUT**

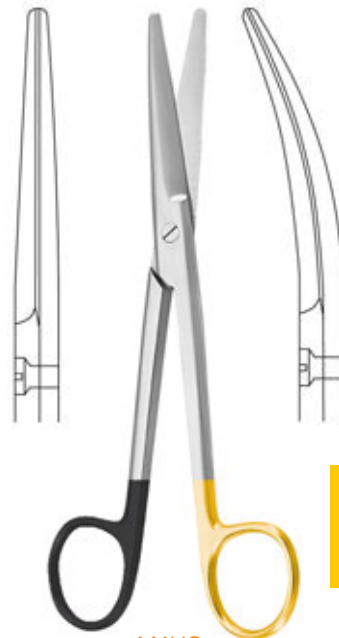

MAYO

14,5 cm/5¾"	07.164.14	07.165.14
17 cm/6¾"	07.164.17	07.165.17
23 cm/9"	07.164.23	07.165.23

TC-Schneiden  
 TC cutting edges  
 Tranchant TC  
 Filos de corte TC  
 Taglio TC



### Präparierscheren

Dissecting scissors  
Ciseaux à dissection  
Tijeras de disección  
Forbici per dissezione

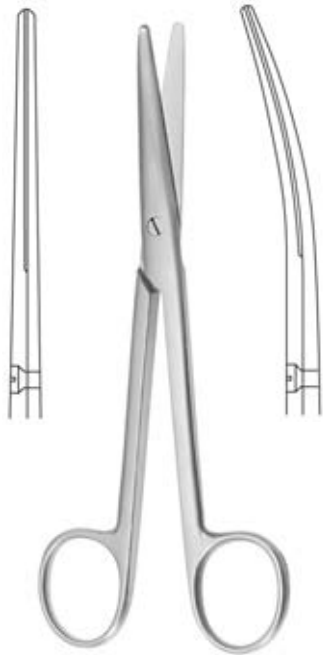

MAYO-STILLE

15 cm/6"	<b>08.170.15</b>	<b>08.171.15</b>
17 cm/6¾"	<b>08.170.17</b>	<b>08.171.17</b>

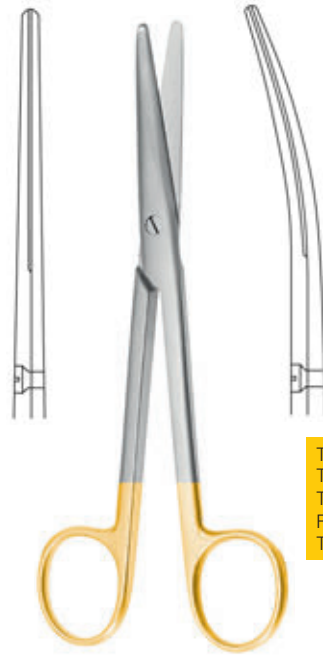

MAYO-STILLE

15 cm/6"	<b>08.174.15</b>	<b>08.175.15</b>
17 cm/6¾"	<b>08.174.17</b>	<b>08.175.17</b>

TC-Schneiden  
TC cutting edges  
Tranchant TC  
Filos de corte TC  
Taglio TC

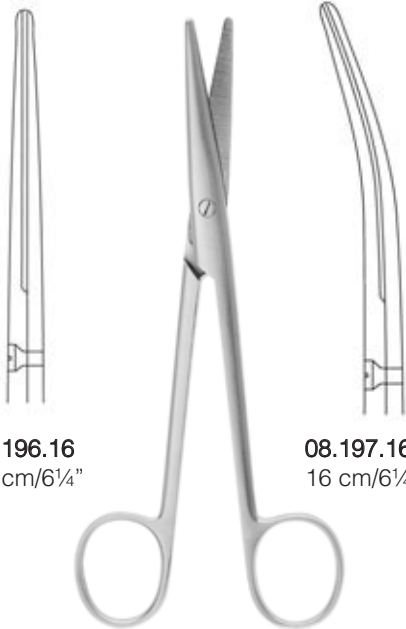

LEXER-FINO

**08.196.16**  
16 cm/6¼"

**08.197.16**  
16 cm/6¼"

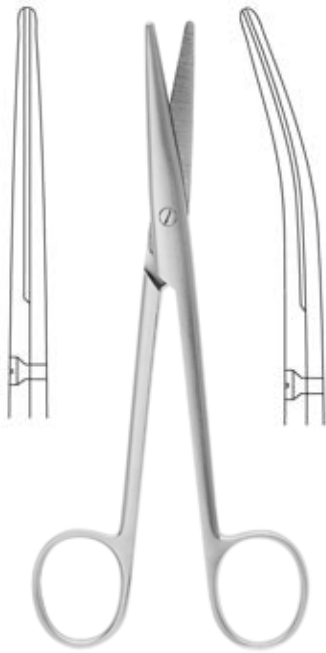

LEXER

16 cm/6¼"	08.190.16	08.191.16
21 cm/8¼"	08.190.21	08.191.21



LEXER

16 cm/6¼"	08.194.16	08.195.16
21 cm/8¼"	08.194.21	08.195.21

TC-Schneiden  
 TC cutting edges  
 Tranchant TC  
 Filos de corte TC  
 Taglio TC

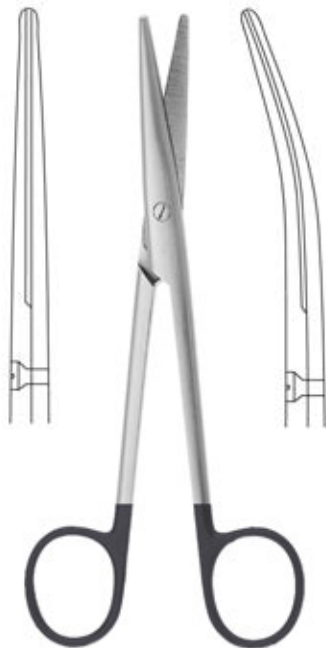

LEXER

16 cm/6¼"	07.190.16	07.191.16
21 cm/8¼"	07.190.21	07.191.21

**SUPERCUT**

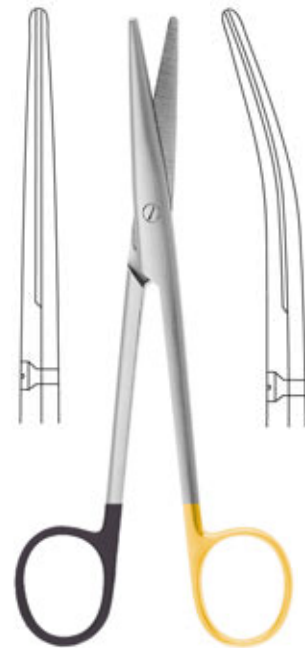

LEXER

16 cm/6¼"	07.194.16	07.195.16
21 cm/8¼"	07.194.21	07.195.21

TC-Schneiden  
 TC cutting edges  
 Tranchant TC  
 Filos de corte TC  
 Taglio TC



**Präparierscheren**

Dissecting scissors  
Ciseaux à dissection  
Tijeras de disección  
Forbici per dissezione



METZENBAUM

14,5 cm/5¾"	08.280.15	08.281.15
18 cm/7"	08.280.18	08.281.18
20 cm/8"	08.280.20	08.281.20
23 cm/9"	08.280.23	08.281.23
25 cm/10"	08.280.25	08.281.25
28 cm/11"	08.280.28	08.281.28
30 cm/12"	08.280.30	08.281.30



METZENBAUM

14,5 cm/5¾"	08.284.15	08.285.15
18 cm/7"	08.284.18	08.285.18
20 cm/8"	08.284.20	08.285.20
23 cm/9"	08.284.23	08.285.23
25 cm/10"	08.284.25	08.285.25
28 cm/11"	08.284.28	08.285.28
30 cm/12"	08.284.30	08.285.30

TC-Schneiden  
TC cutting edges  
Tranchant TC  
Filos de corte TC  
Taglio TC



METZENBAUM

11,5 cm/4½"	07.280.11	08.281.11
14,5 cm/5¾"	07.280.15	08.281.15
18 cm/7"	07.280.18	08.281.18
20 cm/8"	07.280.20	08.281.20
23 cm/9"	07.280.23	08.281.23
25 cm/10"	07.280.25	08.281.25
28 cm/11"	07.280.28	08.281.28
30 cm/12"	07.280.30	08.281.30



METZENBAUM

11,5 cm/4½"	07.284.11	07.285.11
14,5 cm/5¾"	07.284.15	07.285.15
18 cm/7"	07.284.18	07.285.18
20 cm/8"	07.284.20	07.285.20
23 cm/9"	07.284.23	07.285.23
25 cm/10"	07.284.25	07.285.25
28 cm/11"	07.284.28	07.285.28
30 cm/12"	07.284.30	07.285.30

**SUPERCUT**

TC-Schneiden  
TC cutting edges  
Tranchant TC  
Filos de corte TC  
Taglio TC



METZENBAUM FINO

14,5 cm/5¾"	08.282.15	08.283.15
18 cm/7"	08.282.18	08.283.18
20 cm/8"	08.282.20	08.283.20
23 cm/9"	08.282.23	08.283.23
25 cm/10"	08.282.25	08.283.25
28 cm/11"	08.282.28	08.283.28



METZENBAUM FINO

14,5 cm/5¾"	08.286.15	08.287.15
18 cm/7"	08.286.18	08.287.18
20 cm/8"	08.286.20	08.287.20
23 cm/9"	08.286.23	08.287.23
25 cm/10"	08.286.25	08.287.25
28 cm/11"	08.286.28	08.287.28

TC-Schneiden  
 TC cutting edges  
 Tranchant TC  
 Filos de corte TC  
 Taglio TC



**Präparierscheren**  
 Dissecting scissors  
 Ciseaux à dissection  
 Tijeras de disección  
 Forbici per dissezione



**METZENBAUM FINO**

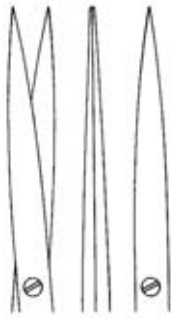

**08.292.14**  
14 cm/5½"

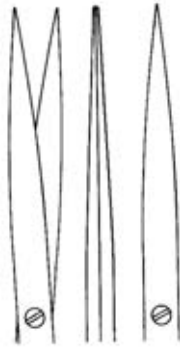

**08.292.18**  
18 cm/7"

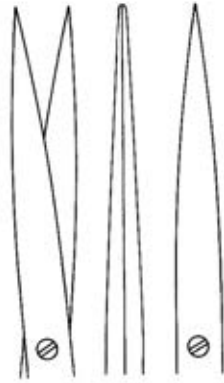

**08.292.20**  
20 cm/8"

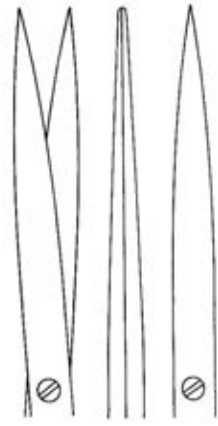

**08.292.23**  
23 cm/9"

spitz/spitz  
sharp/sharp  
pointue/pointue  
aguda/aguda  
acuta/acuta



**METZENBAUM FINO**



**08.293.14**  
14 cm/5½"

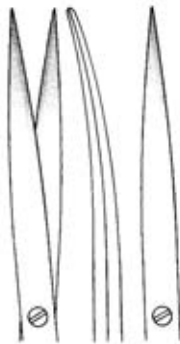

**08.293.18**  
18 cm/7"



**08.293.20**  
20 cm/8"

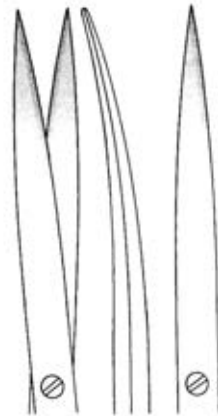

**08.293.23**  
23 cm/9"

spitz/spitz  
sharp/sharp  
pointue/pointue  
aguda/aguda  
acuta/acuta





METZENBAUM FINO

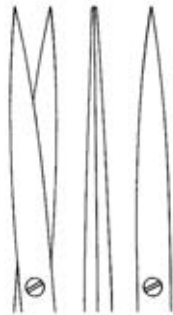

**08.296.14**  
 14,5 cm/5¾"

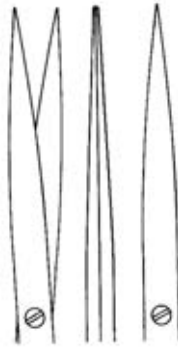

**08.296.18**  
 18 cm/7"

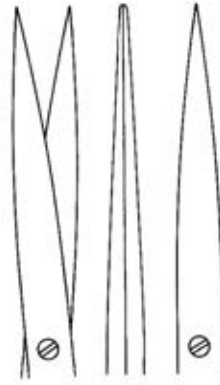

**08.296.20**  
 20 cm/8"

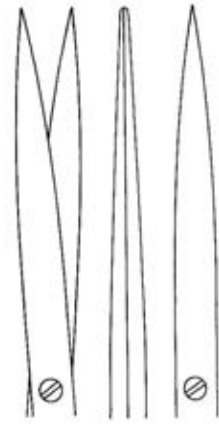

**08.296.23**  
 23 cm/9"

spitz/spitz  
 sharp/sharp  
 pointue/pointue  
 aguda/aguda  
 acuta/acuta

TC-Schneiden  
 TC cutting edges  
 Tranchant TC  
 Filos de corte TC  
 Taglio TC



METZENBAUM FINO



**08.297.14**  
 14,5 cm/5¾"

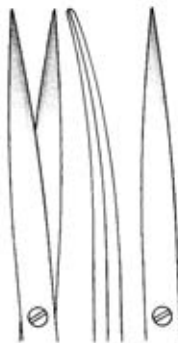

**08.297.18**  
 18 cm/7"



**08.297.20**  
 20 cm/8"

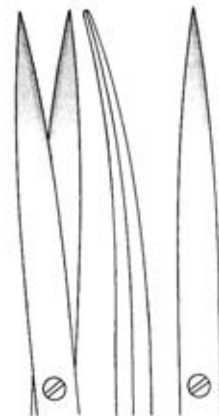

**08.297.23**  
 23 cm/9"

spitz/spitz  
 sharp/sharp  
 pointue/pointue  
 aguda/aguda  
 acuta/acuta



### Chirurgische Scheren

Operating scissors  
Ciseaux à chirurgie  
Tijeras para cirugía  
Forbici per chirurgia

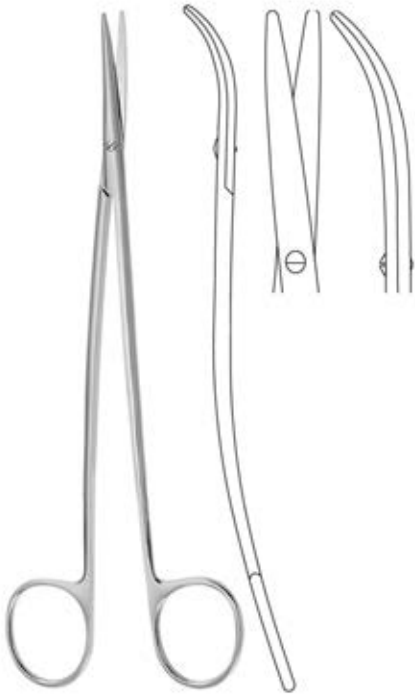

**METZENBAUM FINO "S"**  
08.291.18  
18 cm/7"



**METZENBAUM FINO "S"**  
08.295.18  
18 cm/7"

TC-Schneiden  
TC cutting edges  
Tranchant TC  
Filos de corte TC  
Taglio TC



**METZENBAUM-NELSON**  
18 cm/7"      08.288.18  
20 cm/8"      08.288.20

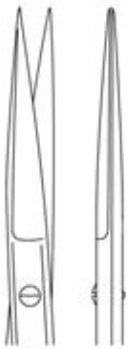

08.302.14  
14 cm/5½"



08.303.14  
14 cm/5½"



08.304.14  
14 cm/5½"



08.305.14  
14 cm/5½"



**SANVENERO**



**JOSEPH**



KILNER

12 cm/4¾"    **08.310.12**  
 15 cm/6"    **08.310.15**



KILNER

12 cm/4¾"    **08.314.12**  
 15 cm/6"    **08.314.15**

TC-Schneiden  
 TC cutting edges  
 Tranchant TC  
 Filos de corte TC  
 Taglio TC



REYNOLDS  
**08.320.15**  
 15 cm/6"



REYNOLDS  
 15 cm/6"    **08.321.15**  
 18 cm/7"    **08.321.18**



REYNOLDS  
**08.324.15**  
 15 cm/6"



REYNOLDS  
**08.325.15**  
 15 cm/6"

TC-Schneiden  
 TC cutting edges  
 Tranchant TC  
 Filos de corte TC  
 Taglio TC



## Chirurgische Scheren

Operating scissors  
Ciseaux à chirurgie  
Tijeras para cirugía  
Forbici per chirurgia

TC-Schneiden  
TC cutting edges  
Tranchant TC  
Filos de corte TC  
Taglio TC



IRIS

9 cm/3½"	<b>08.340.09</b>
10,5 cm/4¼"	<b>08.340.10</b>
11,5 cm/4½"	<b>08.340.11</b>
12,5 cm/5"	<b>08.340.12</b>



IRIS

9 cm/3½"	<b>08.341.09</b>
10,5 cm/4¼"	<b>08.341.10</b>
11,5 cm/4½"	<b>08.341.11</b>
12,5 cm/5"	<b>08.341.12</b>



IRIS

**08.344.11**  
11,5 cm/4½"



IRIS

**08.345.11**  
11,5 cm/4½"



IRIS

**08.351.11**  
11,5 cm/4½"



IRIS

**08.354.11**  
11,5 cm/4½"



IRIS

**08.353.11**  
11,5 cm/4½"



PERWITZCHKY

**08.470.11**  
11,5 cm/4½"



PERWITZCHKY

**08.471.10**  
10 cm/4"



TC-Schneiden  
 TC cutting edges  
 Tranchant TC  
 Filos de corte TC  
 Taglio TC



DEBAKEY

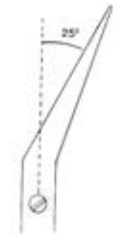

**08.317.25**  
 19 cm/7½"  
 25°

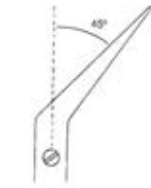

**08.317.45**  
 18,5 cm/7¼"  
 45°



**08.317.60**  
 18 cm/7"  
 60°



**08.319.25**  
 23 cm/9"  
 25°

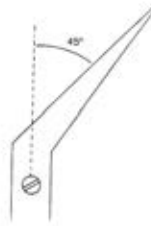

**08.319.45**  
 22,5 cm/9"  
 45°

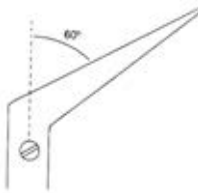

**08.319.60**  
 22 cm/8¾"  
 60°

**08.943.25**  
 28 cm/11"  
 25°

**08.943.45**  
 27,5 cm/11"  
 45°

**08.943.60**  
 27 cm/10¾"  
 60°

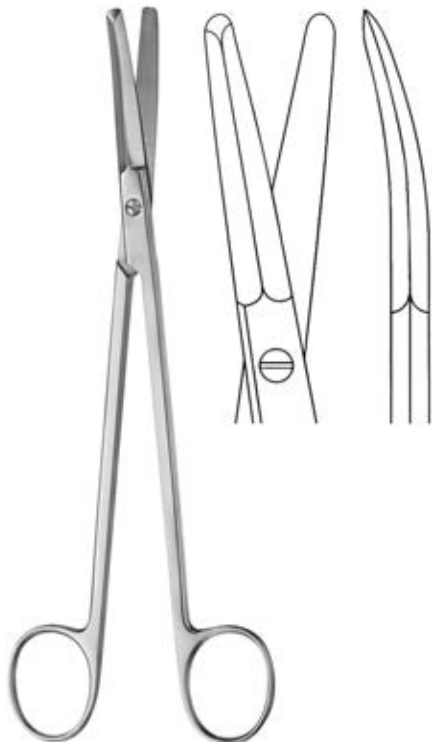

**POTTS SMITH**  
**08.467.19**  
 19 cm/7½"

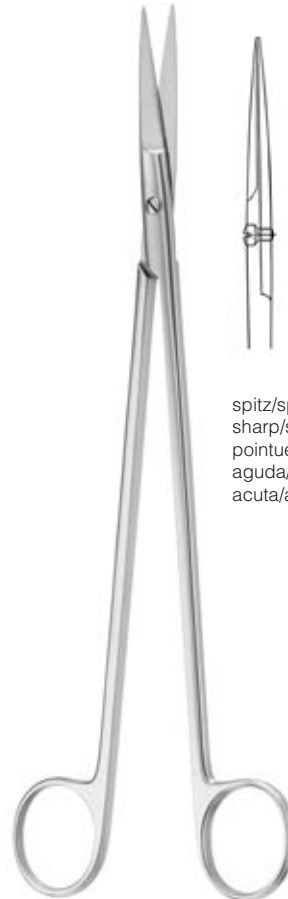

spitz/spitz  
 sharp/sharp  
 pointue/pointue  
 aguda/aguda  
 acuta/acuta



**08.472.22**  
 22,5 cm/9"



### Gefäßscheren

Vascular scissors  
Ciseaux vasculaires  
Tijeras vasculares  
Forbici vascolari

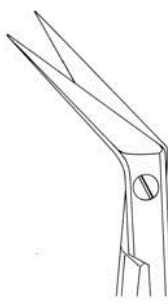
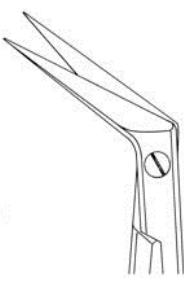

			
25°	40°	60°	60°
19 cm/7½"	08.480.25	08.480.40	08.480.60

		
25°	40°	60°
19 cm/7½"	08.484.25	08.484.40

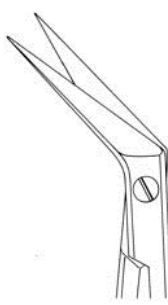
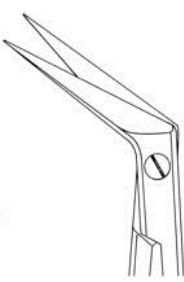
TC-Schneiden  
TC cutting edges  
Tranchant TC  
Filos de corte TC  
Taglio TC



POTTS-SMITH

### SUPERCUT

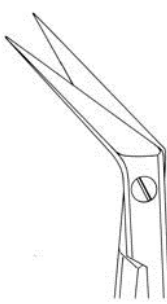
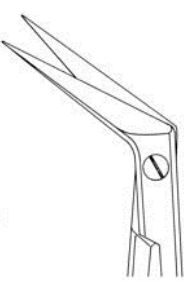

		
25°	40°	60°
19 cm/7½"	07.480.25	07.480.40

		
25°	40°	60°
19 cm/7½"	07.484.25	07.484.40

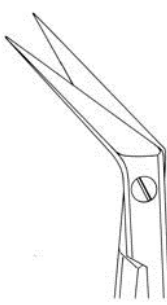
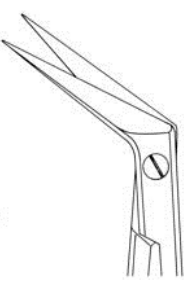
TC-Schneiden  
TC cutting edges  
Tranchant TC  
Filos de corte TC  
Taglio TC



POTTS-SMITH



**DIETHRICH**

	16 cm/6¼"	<b>08.485.25</b>
14 mm	18 cm/7"	<b>08.486.25</b>
10 mm	18 cm/7"	<b>08.486.26</b>
7 mm	18 cm/7"	<b>08.486.27</b>



**DIETHRICH**

	16 cm/6¼"	<b>08.485.45</b>
14 mm	18 cm/7"	<b>08.486.45</b>
10 mm	18 cm/7"	<b>08.486.46</b>
7 mm	18 cm/7"	<b>08.486.47</b>



**DIETHRICH**

	16 cm/6¼"	<b>08.485.60</b>
14 mm	18 cm/7"	<b>08.486.60</b>
10 mm	18 cm/7"	<b>08.486.61</b>
7 mm	18 cm/7"	<b>08.486.62</b>



**DIETHRICH**

	16 cm/6¼"	<b>08.485.90</b>
14 mm	18 cm/7"	<b>08.486.90</b>
10 mm	18 cm/7"	<b>08.486.91</b>
7 mm	18 cm/7"	<b>08.486.92</b>



**DIETHRICH**

	16 cm/6¼"	<b>08.485.92</b>
14 mm	18 cm/7"	<b>08.487.25</b>
10 mm	18 cm/7"	<b>08.487.26</b>
7 mm	18 cm/7"	<b>08.487.27</b>



**DIETHRICH**  
**08.488.25**  
 18 cm/7"





### Gefäßscheren

Vascular scissors  
Ciseaux vasculaires  
Tijeras vasculares  
Forbici vascolari



DE BAKEY

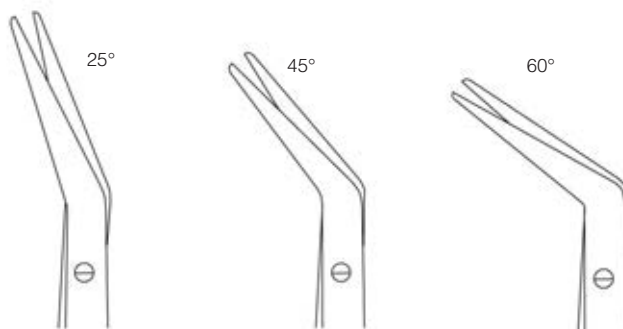

	25°	45°	60°
16 cm/6¼"	<b>08.490.16</b>	<b>08.491.16</b>	<b>08.492.16</b>
18 cm/7"	<b>08.490.18</b>	<b>08.491.18</b>	<b>08.492.18</b>
23 cm/9"	<b>08.490.23</b>	<b>08.491.23</b>	<b>08.492.23</b>
28 cm/11"	<b>08.490.28</b>	<b>08.491.28</b>	<b>08.492.28</b>

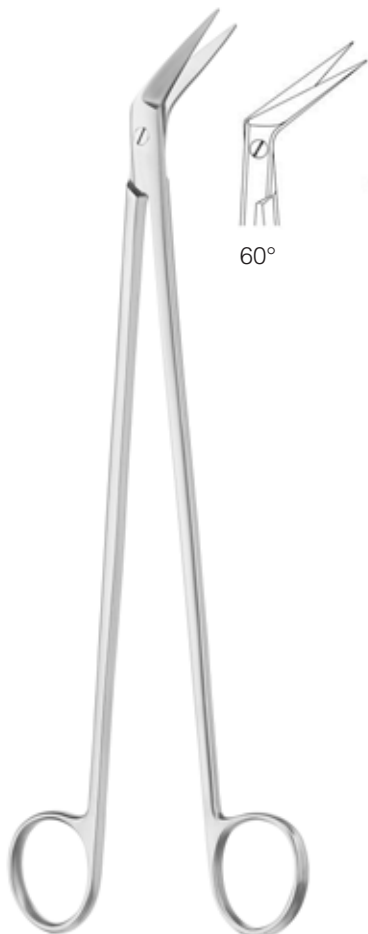

POTTS-DE MARTEL

21 cm/8¼" **08.473.21**  
24 cm/9½" **08.473.24**



MILLS  
**08.475.22**  
22 cm/8¾"



POTTS-SMITH  
**08.480.18**  
18 cm/7"





Coronararterien-Schere  
 Coronary artery scissors  
 Ciseaux artère coronaire  
 Tijeras de arteria coronaria  
 Forbici per arterie coronarica



**DE BAKEY**  
**08.495.15**  
 15,5 cm/6"

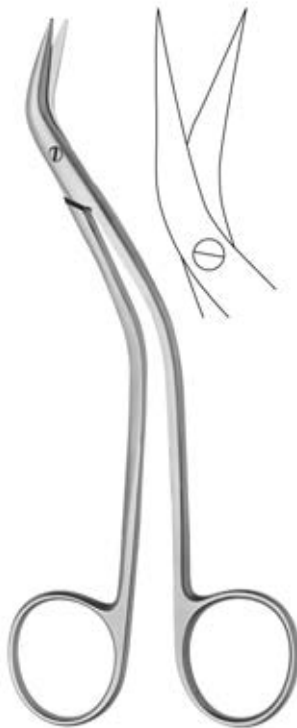

**DE BAKEY**  
**08.497.15**  
 15,5 cm/6"

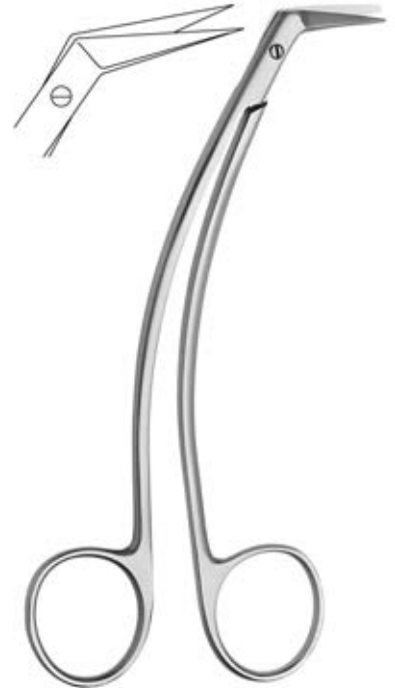

**FAVALORO**  
**08.500.14**  
 15,5 cm/6"



**HOHENFELLNER**



**08.477.18**  
 18 cm/7"



**08.477.21**  
 21 cm/8¼"



**08.477.24**  
 24 cm/9½"

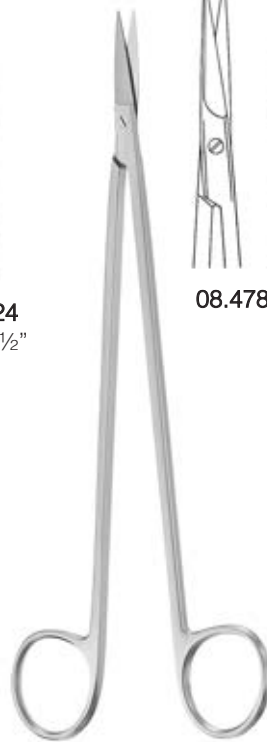

19 cm/7½"



**08.478.19**



**08.479.19**



**POTTS-SMITH**  
**08.498.19**  
 18 cm/7"



**Scheren**  
Scissors  
Ciseaux  
Tijeras  
Forbici

Nerv-Präparierschere  
Nerve dissecting scissors  
Ciseaux à préparation de nerfs  
Tijeras para preparación del nervio  
Forbici per preparazione di nervi



**08.582.15**  
15 cm/6"



**08.583.15**  
15 cm/6"

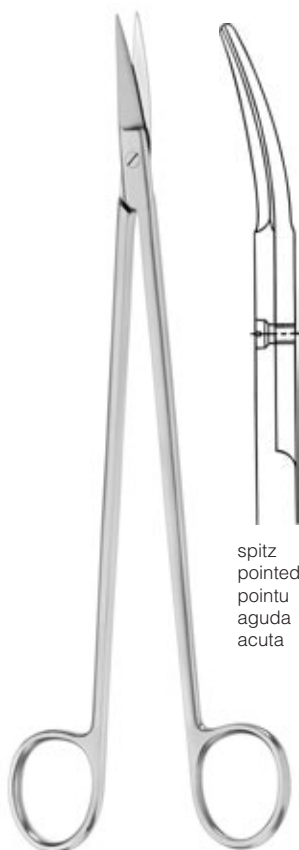

spitz  
pointed  
pointu  
aguda  
acuta

**STRULLY**  
**08.600.22**  
22 cm/8¾"

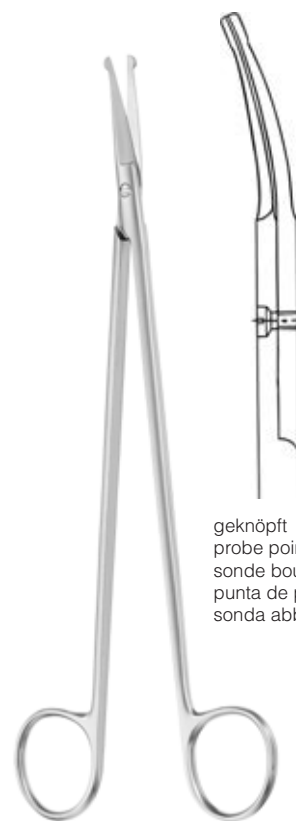

geknöpft  
probe pointed  
sonde boutonnée  
punta de prueba abotonada  
sonda abbottonata

**STRULLY**  
**08.601.22**  
22 cm/8¾"



**BRAUN-STADLER**  
**08.560.20**  
20 cm/8"



TC-Schneiden  
TC cutting edges  
Tranchant TC  
Filos de corte TC  
Taglio TC

**TOENNIS-ADSON**  
**08.613.17**  
17 cm/6¾"



**McINDOE**  
**08.614.19**  
19 cm/7½"

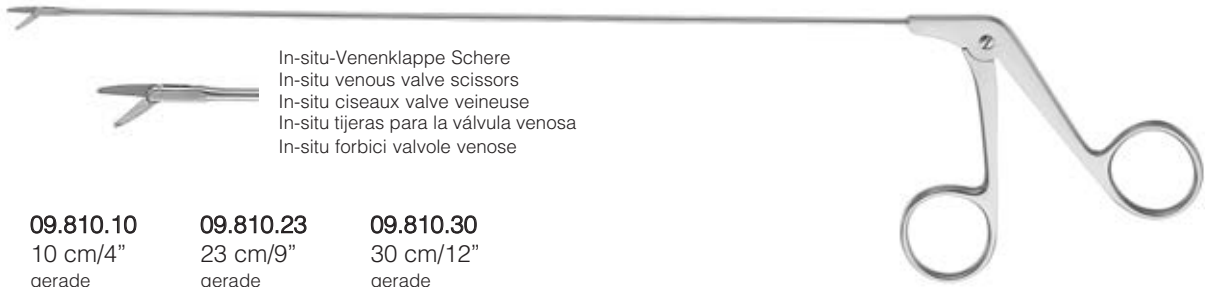

In-situ-Venenklappe Schere  
 In-situ venous valve scissors  
 In-situ ciseaux valve veineuse  
 In-situ tijeras para la válvula venosa  
 In-situ forbici valvole venose

**09.810.10**  
 10 cm/4"  
 gerade  
 straight  
 droit  
 recta  
 diritto

**09.810.23**  
 23 cm/9"  
 gerade  
 straight  
 droit  
 recta  
 diritta

**09.810.30**  
 30 cm/12"  
 gerade  
 straight  
 droit  
 recta  
 diritta

**09.811.30**  
 30 cm/12"  
 für den linken Oberschenkel  
 for left thigh  
 pour la cuisse gauche  
 para el muslo izquierdo  
 per coscia sinistra

**09.813.30**  
 30 cm/12"  
 für den rechten Oberschenkel  
 for right thigh  
 pour la cuisse droite  
 para el muslo derecho  
 per coscia destra



**SATINSKY**  
**08.649.18**  
 18 cm/7"



**SATINSKY**  
**08.650.21**  
 21 cm/8¼"



für die Vena cava  
 for vena cava  
 pour la veine cave  
 para la vena cava  
 per la vena cava

**SATINSKY**  
**08.651.24**  
 24,5 cm/9¼"



## Thorax-Scheren

Thoracic scissors  
Ciseaux thoraciques  
Tijeras torácica  
Toraciche forbici

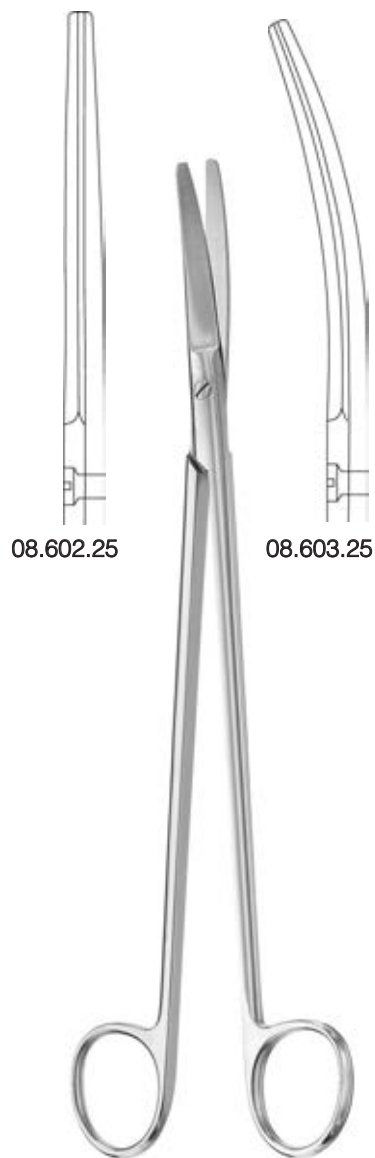

08.602.25

08.603.25

**WILLAUER**  
25,5 cm/10"



**CRAFOORD**  
08.641.30  
30 cm/12"

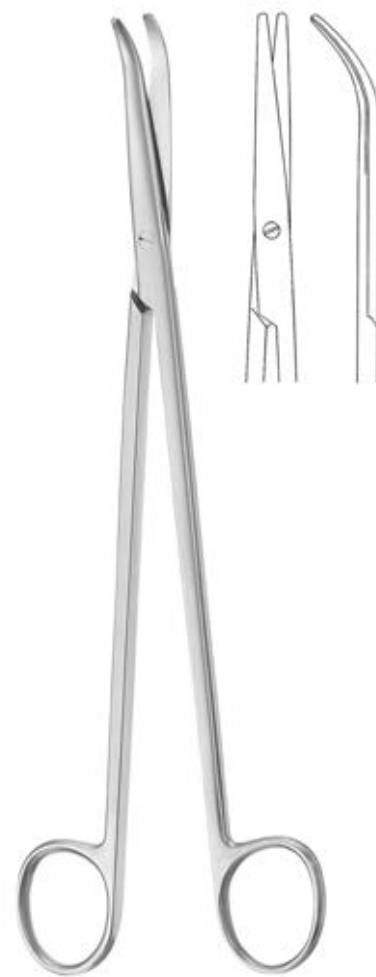

**THOREK**  
19 cm/7½"      08.643.18  
25 cm/10"      08.643.25



SPENCER



08.802.09  
9 cm/3½"



08.802.11  
11 cm/4¼"



08.802.12  
12 cm/4¾"



LITTAUER  
08.804.14  
14 cm/5½"



JORGENSON  
22 cm/8¾"    08.652.22  
28 cm/11"    08.652.28

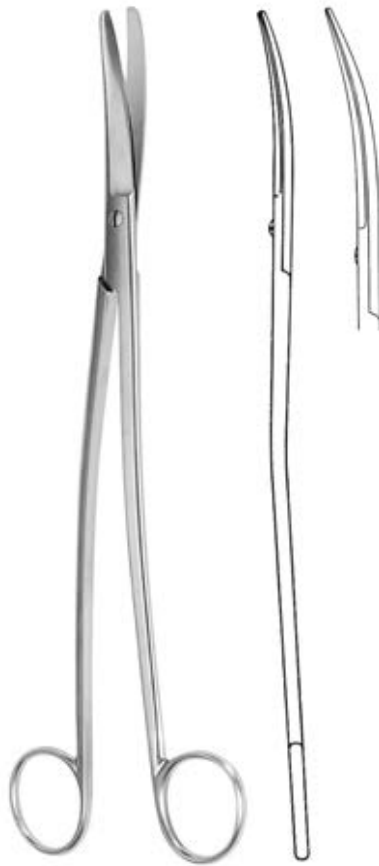

KLINKENBERGH LOTH  
08.661.23  
23 cm/9"



Lungenlappenschere  
Lobectomy scissors  
Ciseaux à lobectomie  
Tijeras para lobectomía  
Forbici per lobo polmonare

FINOCHIETTO  
08.663.27  
27 cm/10¾"



### Mikrogefäßscheren

Micro vascular scissors  
 Micro-ciseaux vasculaires  
 Tijeras microquirúrgicas vasculares  
 Forbici micro-chirurgici vascolari



18 cm/7"

spitz  
 sharp  
 pointu  
 agudo  
 acuto

Schneideblatt  
 Cutting edge  
 Lame  
 Filo cortante  
 Filo di lama



25°



45°



60°



90°



125°

<b>FINE</b>	14 mm	<b>09.224.25</b>	<b>09.224.45</b>	<b>09.224.60</b>	<b>09.224.90</b>	<b>09.225.00</b>
-------------	-------	------------------	------------------	------------------	------------------	------------------

1 Blatt geknöpft  
 1 probe-pointed blade  
 1 lame boutonnée  
 1 hoja botonada  
 1 lama abbottonata

Schneideblatt  
 Cutting edge  
 Lame  
 Filo cortante  
 Filo di lama



25°



45°



60°



90°



125°

<b>FINE</b>	14 mm	<b>09.225.25</b>	<b>09.225.45</b>	<b>09.225.60</b>	<b>09.225.90</b>	<b>09.226.00</b>
-------------	-------	------------------	------------------	------------------	------------------	------------------

Flachgriff  
 Flat handle  
 Manche plat  
 Mango plano  
 Manico piatto



**TOLEDO**  
 16,5 cm/6½"

spitz  
 sharp  
 pointu  
 agudo  
 acuto

Schneideblatt  
 Cutting edge  
 Lame  
 Filo cortante  
 Filo di lama



25° 45° 60° 90° 125°

<b>NANO</b>	7 mm	09.236.25	09.236.45	09.236.60	09.236.90	09.237.25
<b>MICRO</b>	10 mm	09.234.25	09.234.45	09.234.60	09.234.90	09.235.25
<b>FINE</b>	14 mm	09.230.25	09.230.45	09.230.60	09.230.90	09.231.25

1 Blatt geknöpft  
 1 probe-pointed blade  
 1 lame boutonnée  
 1 hoja botonada  
 1 lama abbottonata

Schneideblatt  
 Cutting edge  
 Lame  
 Filo cortante  
 Filo di lama



25° 45° 60° 90° 125°

<b>FINE</b>	14 mm	09.232.25	09.232.45	09.232.60	09.232.90	09.233.25
-------------	-------	-----------	-----------	-----------	-----------	-----------

Schneideblatt  
 Cutting edge  
 Lame  
 Filo cortante  
 Filo di lama



<b>NANO</b>	7 mm	09.356.07	09.357.07
<b>MICRO</b>	10 mm	09.356.10	09.357.10
<b>FINE</b>	14 mm	09.356.14	09.357.14



### Mikrogefäßscheren

Micro vascular scissors  
Micro-ciseaux vasculaires  
Tijeras microquirúrgicas vasculares  
Forbici micro-chirurgici vascolari



YASARGIL

YASARGIL

12 cm/4¾"

09.260.12

09.261.12

16 cm/6¼"

09.260.16

09.261.16

18,5 cm/7¼"

09.260.18

09.261.18



VANNAS

VANNAS

VANNAS

12 cm/4¾"

09.262.12

09.263.12

09.265.12

16 cm/6¼"

09.262.16

09.263.16



gezahnt  
toothed  
dentelés  
dentadas  
dentate



gezahnt  
toothed  
dentelés  
dentadas  
dentate

MILLES

MILLES

09.270.16

09.271.16

16 cm/6¼"

16 cm/6¼"



Venenschere  
Vein scissors  
Ciseaux pour veines  
Tijeras para venas  
Forbici per vene

BIEMER

09.264.13

13 cm/5"



45°

seitwärts abgewinkelt  
angled to side  
coudés latéralement  
acodadas hacia el lado  
angolata lateralmente

POTTS-YASARGIL

09.261.19

18,5 cm/7¼"





Leichtmetall Rundgriffe, gut ausbalanciert  
 Light-weight round handles, well balanced  
 Manches ronds en métal léger, bien équilibrés  
 Mangos redondos de metal ligero, bien equilibrados  
 Manici rotondi metallo leggero, equilibrio perfetto



15 cm/5"	09.300.15	09.301.15
18 cm/7"	09.300.18	09.301.18

**SUPERCUT**



18 cm/7"	09.302.18	09.303.18
----------	-----------	-----------

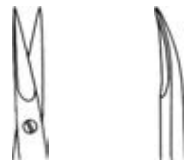

gezahnt  
 toothed  
 dentelés  
 dentadas  
 dentate

15 cm/5"	09.304.15	09.305.15
18 cm/7"	09.304.18	09.305.18



15 cm/5"	09.307.15
18 cm/7"	09.307.18



runde Schneideblätter  
 round cutting blades  
 lames rondes  
 hojas redondas  
 lame rotonde

15 cm/5"	09.309.15
18 cm/7"	09.309.18

- ergonomischer Griff
- ansprechendes Design
- sichere und feinfühlig Handhabung
- leichtes Reinigen
- keine schmutzanfälligen Riefelungen

- ergonomic handle
- sophisticated design
- safe and sensitive in hand, well balanced
- easy to clean
- no dirt catching knurlings

- manche ergonomique
- aspect attrayant
- une manipulation délicate et en sécurité
- la précision du geste opératoire
- un nettoyage facile
- siure pas sensible à la saleté

- mango ergonómico
- diseño concebido
- manipulación segura y delicada
- limpieza fácil
- las estriadas no son susceptible a la suciedad

- manico ergonomico
- design appariscente
- maneggio sicuro e delicato
- purificazione facile
- non incline de la sporcizia



### Mikrogefäßscheren

Micro vascular scissors  
Micro-ciseaux vasculaires  
Tijeras microquirúrgicas vasculares  
Forbici micro-chirurgici vascolari

Schneide 10mm  
Cutting edge 10 mm  
Lame 10 mm  
Filo cortante 10 mm  
Filo di lama 10 mm

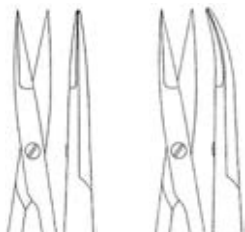

15 cm/6"	09.710.15	09.711.15
18 cm/7"	09.710.18	09.711.18
21 cm/8¼"	09.710.21	09.711.21
23 cm/9"	09.710.23	09.711.23

15 cm/6"	09.720.15	09.721.15
18 cm/7"	09.720.18	09.721.18
21 cm/8¼"	09.720.21	09.721.21



Titan  
Titanium  
Titane  
Titanio  
Titanio

*Streamlined*

Schneide 10mm  
Cutting edge 10 mm  
Lame 10 mm  
Filo cortante 10 mm  
Filo di lama 10 mm

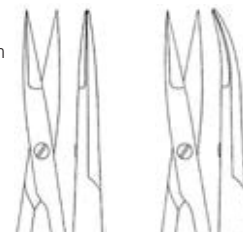

15 cm/6"	09.712.15	09.713.15
18 cm/7"	09.712.18	09.713.18
21 cm/8¼"	09.712.21	09.713.21
23 cm/9"	09.712.23	09.713.23

15 cm/6"	09.722.15	09.723.15
18 cm/7"	09.722.18	09.723.18
21 cm/8¼"	09.722.21	09.723.21



Titan  
Titanium  
Titane  
Titanio  
Titanio

*Streamlined*



Rundgriff  
Round handle  
Manche rond  
Mango redondo  
Manico rotondo



Flachgriff  
Flat handle  
Manche plat  
Mango plano  
Manico piatto

# 04

◆ **PINZETTEN & KLEMMEN**

FORCEPS AND CLAMPS

PINCES ET CLAMPS

PINZAS Y CLAMPS

PINZE E CLAMPS

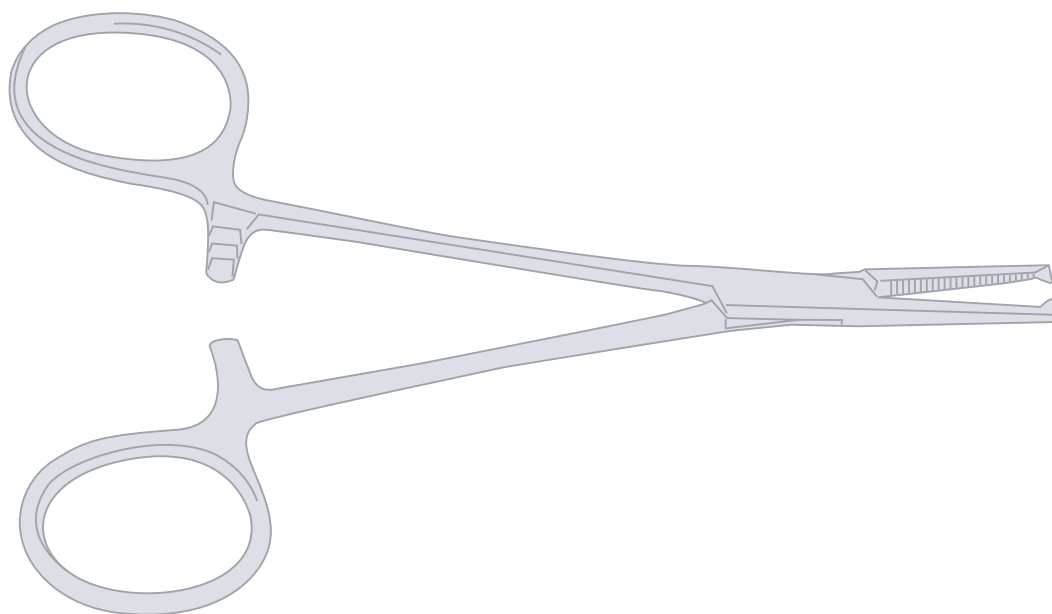



## Pinzetten

Thumb and tissue forceps  
Pincès à dissection  
Pinzas de disección  
Pinze per dissezione



schmal  
narrow  
étroite  
estrecha  
stretta

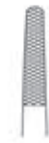

mit TC-Einsätzen  
with TC inserts  
avec mors TC  
con bocas TC  
con morso TC



mit TC-Einsätzen  
with TC inserts  
avec mors TC  
con bocas TC  
con morso TC

### POTTS-SMITH

11,5 cm/4½"	10.102.11	10.110.11
13 cm/5"	10.102.13	10.110.13
14,5 cm/5¾"	10.102.14	10.110.14
16 cm/6¼"	10.102.16	10.110.16
18 cm/7"	10.102.18	10.110.18
20 cm/8"	10.102.20	10.110.20
25 cm/10"	10.102.25	10.110.25
30 cm/12"	10.102.30	10.110.30

14,5 cm/5¾"	10.114.14
16 cm/6¼"	10.114.16

15,5 cm/6"		10.116.15
18 cm/7"	10.112.18	10.116.18
20 cm/8"		10.116.20
21 cm/8¼"	10.112.21	10.116.21
23 cm/9"		10.116.23
25 cm/10"	10.112.25	10.116.25
30 cm/12"	10.112.30	



1:2



1:2

schmal  
narrow  
étroite  
estrecha  
stretta



1:2

mittel  
medium  
milieu  
medio  
mezzo



2:3



1:2

11,5 cm/4½"	10.120.11	10.130.11
13 cm/5"	10.120.13	10.130.13
14,5 cm/5¾"	10.120.14	10.130.14
16 cm/6¼"	10.120.16	10.130.16
18 cm/7"	10.120.18	10.130.18
20 cm/8"	10.120.20	10.130.20
23 cm/9"	10.120.23	
25 cm/10"	10.120.25	10.130.25
30 cm/12"	10.120.30	10.130.30

13 cm/5"	10.131.13
14,5 cm/5¾"	10.131.14

11,5 cm/4½"	10.140.11
13 cm/5"	10.140.13
14,5 cm/5¾"	10.140.14
16 cm/6¼"	10.140.16
18 cm/7"	10.140.18
20 cm/8"	10.140.20
25 cm/10"	10.140.25

### POTTS-SMITH

18 cm/7"	10.126.18
21 cm/8¼"	10.126.21
25 cm/10"	10.126.25
40 cm/16"	10.126.40

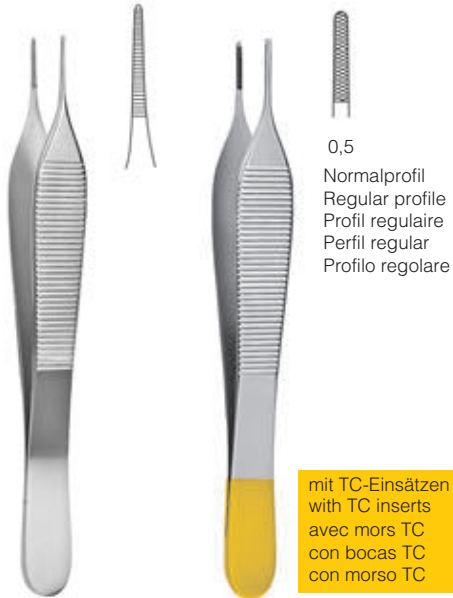

0,5  
 Normalprofil  
 Regular profile  
 Profil regulaire  
 Perfil regular  
 Profilo regolare

mit TC-Einsätzen  
 with TC inserts  
 avec mors TC  
 con bocas TC  
 con morso TC

**ADSON**

12 cm/4¾"	10.170.12	10.174.12
15 cm/6"	10.170.15	10.174.15
18 cm/7"	10.170.18	



**ADSON micro**

12 cm/4¾"	10.176.12
15 cm/6"	10.176.15

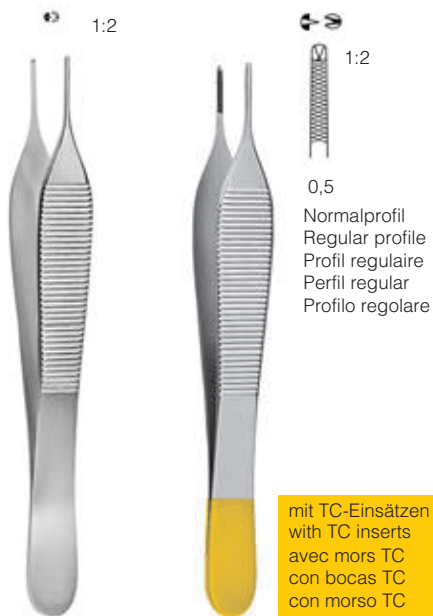

0,5  
 Normalprofil  
 Regular profile  
 Profil regulaire  
 Perfil regular  
 Profilo regolare

mit TC-Einsätzen  
 with TC inserts  
 avec mors TC  
 con bocas TC  
 con morso TC

**ADSON**

12 cm/4¾"	10.180.12	10.184.12
15 cm/6"	10.180.15	10.184.15
18 cm/7"	10.180.18	

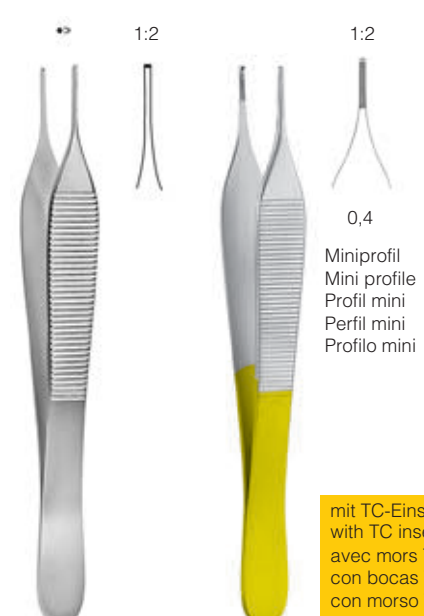

0,4  
 Mini profil  
 Mini profile  
 Profil mini  
 Perfil mini  
 Profilo mini

mit TC-Einsätzen  
 with TC inserts  
 avec mors TC  
 con bocas TC  
 con morso TC

**ADSON micro**

12 cm/4¾"	10.186.12	10.173.12
15 cm/6"	10.186.15	10.173.15
18 cm/7"	10.186.18	



### Pinzetten

Thumb and tissue forceps  
Pincés à dissection  
Pinzas de disección  
Pinze per dissezione

1:2



**CUSHING**  
**10.220.17**  
17 cm/6¾"



**CUSHING**  
**10.230.17**  
17 cm/6¾"



**CUSHING**  
17 cm/6¾"



**10.224.17**



**10.225.17**

mit TC-Einsätzen  
with TC inserts  
avec mors TC  
con bocas TC  
con morso TC



mit TC-Einsätzen  
with TC inserts  
avec mors TC  
con bocas TC  
con morso TC

**CUSHING-TAYLOR**  
**10.226.18**  
18 cm/7"



**LUCAE**  
**44.206.14**  
14 cm/5½"



**JANSEN**  
**44.206.16**  
16 cm/6¼"



**ADSON**  
**44.206.18**  
17,5 cm/7"



**WAUGH**

15 cm/5" **10.262.15**  
20 cm/8" **10.262.20**



**SELMAN**

15 cm/5" **10.204.15**  
20 cm/8" **10.204.20**  
25 cm/10" **10.204.25**

**Pinzetten**

Thumb and tissue forceps  
 Pinces à dissection  
 Pinzas de disección  
 Pinze per dissezione



**SEMKEN**

12,5 cm/5" **10.260.12**  
 15,5 cm/6" **10.260.15**



**SEMKEN**

12,5 cm/5" **10.270.12**  
 15,5 cm/6" **10.270.15**



**GILLIES**

**10.272.15**  
 15,5 cm/6"



**GILLIES**

**10.272.16**  
 15,5 cm/6"

mit TC-Einsätzen  
 with TC inserts  
 avec mors TC  
 con bocas TC  
 con morso TC



**GERALD**

**10.302.18**  
 18 cm/7"



**10.303.18**  
 18 cm/7"



**10.302.23**  
 23 cm/9"



**GERALD**

fein  
 délicate  
 délicat  
 fino  
 fina

**10.310.18**  
 18 cm/7"



**10.311.18**  
 18 cm/7"



**10.310.23**  
 23 cm/9"



**GERALD**

**10.304.17**  
 17,5 cm/7"



mit TC-Einsätzen  
 with TC inserts  
 avec mors TC  
 con bocas TC  
 con morso TC

0,3  
 Mikroprofil  
 Micro profile  
 Profil micro  
 Perfil micro  
 Profilo micro



**GERALD**

**10.306.17**  
 17,5 cm/7"



0,4  
 Miniprofil  
 Mini profile  
 Profil mini  
 Perfil mini  
 Profilo mini





### Pinzetten

Thumb and tissue forceps  
Pincés à dissection  
Pinzas de disección  
Pinze per dissezione

mit TC-Einsätzen  
with TC inserts  
avec mors TC  
con bocas TC  
con morso TC



0,4  
Miniprofil  
Mini profile  
Profil mini  
Perfil mini  
Profilo mini

McINDOE  
**10.257.15**  
15 cm/6"



McINDOE  
15 cm/6"



10.258.15

fein  
delicate  
délicat  
fino  
fina

kreuzgerieft  
cross serrated  
striure en croix  
estrias cruzadas  
striature trasversali

10.259.15



SINGLEY

18 cm/7"      **10.320.18**  
23 cm/9"      **10.320.23**



NELSON

15,5 cm/6"      **10.322.15**  
18 cm/7"      **10.322.18**  
23 cm/9"      **10.322.23**  
30 cm/12"      **10.322.30**



WANGENSTEEN

15,5 cm/6"      **10.326.15**  
23 cm/9"      **10.326.23**  
25 cm/10"      **10.326.25**

mit TC-Einsätzen  
with TC inserts  
avec mors TC  
con bocas TC  
con morso TC



Russ. Mod.



10.256.15  
15 cm/6"



10.256.20  
20 cm/8"



10.256.25  
25 cm/10"



DURANTE



10.316.14  
14 cm/5 3/4"



10.316.16  
16 cm/6 1/4"



10.316.20  
20 cm/8"





**10.332.01**  
 12 cm/4¾"  
 Fig. 1



**10.330.12**  
 12 cm/4¾"  
 Fig. 3



**10.330.31**  
 11 cm/4¼"  
 Fig. 3 C

fein  
 delicate  
 délicat  
 fino  
 fina



**10.332.04**  
 11 cm/4¼"  
 Fig. 4



**10.332.05**  
 11 cm/4¼"  
 Fig. 5



**10.332.45**  
 11 cm/4¼"  
 Fig. 5



**10.333.05**  
 11 cm/4¼"  
 Fig. 5a



**10.332.15**  
 11 cm/4¼"  
 Fig. 6



**10.331.12**  
 12 cm/4¾"  
 Fig. 7



**10.333.11**  
 11,5 cm/4½"



### Mikro-Knüpfpinzetten

Micro suture tying forceps  
Micro pinces pour nouer les fils  
Micro pinzas para enlazar  
Micro pinze per annodare fili

Gefäß-Dilatation Pinzetten  
Vessel dilating forceps  
Pinces vasculaires à dilatation  
Pinzas de dilatación vascular  
Pinze-vascolare dilatante



	Ø 0,3 mm	Ø 0,2 mm
13,5 cm/5¼"	<b>10.366.30</b>	<b>10.366.20</b>
18 cm/7"	<b>10.368.30</b>	<b>10.368.20</b>



FINO	Ø 0,2 mm
13,5 cm/5¼"	<b>10.364.20</b>



	Ø 0,3 mm	Ø 0,2 mm
11 cm/4¼"	<b>10.361.30</b>	<b>10.361.20</b>



	Ø 0,3 mm
13,5 cm/5¼"	<b>10.367.30</b>



**11.102.12**  
12 cm/4¾"



**11.103.12**  
12 cm/4¾"



**11.104.15**  
15 cm/6"



**11.105.15**  
15 cm/6"



**11.108.18**  
18 cm/7"



**11.109.18**  
18 cm/7"

0,6 mm



**11.108.23**  
23 cm/9"

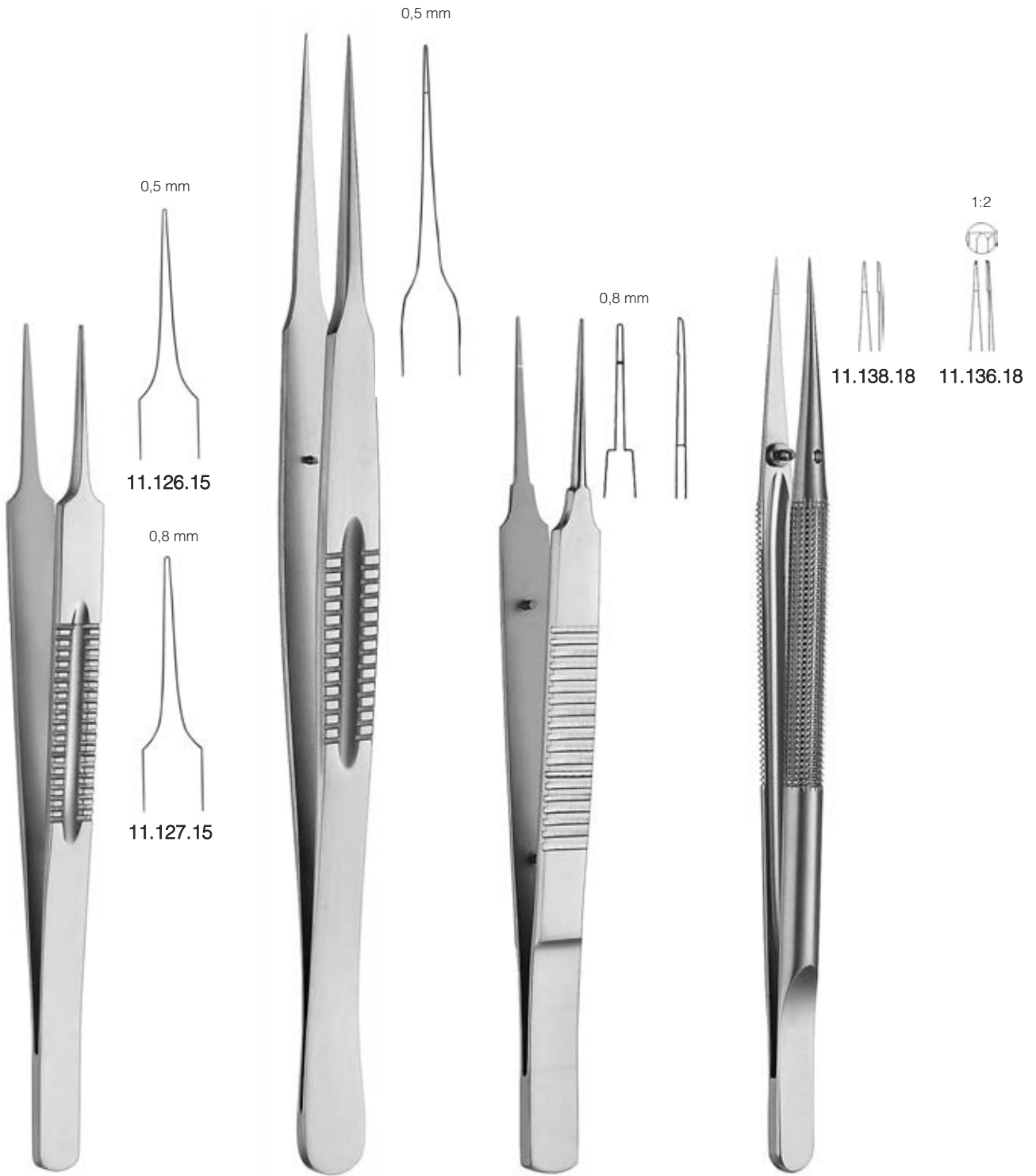

**LAZAR**  
 15,5 cm/6"

**11.128.18**  
 18,5 cm/7¼"

**AUSTIN**  
**11.134.14**  
 14 cm/5½"

**GOMEL**  
 18 cm/7"



## Mikro-Pinzetten

Micro forceps  
Micro pincers  
Micro pinzas  
Micro pinze

Leichtmetall Rundgriffe, gut ausbalanciert  
Light-weight round handles, well balanced  
Manches ronds en métal léger, bien équilibrés  
Mangos redondos de metal ligero, bien equilibrados  
Manici rotondi metallo leggero, equilibrio perfetto



0,3 mm



**11.110.15**  
15 cm/6"

0,3 mm



**11.111.15**  
15 cm/6"

0,6 mm



**11.110.18**  
18 cm/7"

0,6 mm



**11.111.18**  
18 cm/7"

0,2 mm



**11.218.15**  
15 cm/6"

spitz  
sharp  
pointue  
aguda  
acuta

0,3 mm



**11.220.15**  
15 cm/6"

stumpf  
blunt  
mousse  
roma  
smussa

0,2 mm



**11.219.15**  
15 cm/6"

spitz  
sharp  
pointue  
aguda  
acuta

0,3 mm



**11.221.15**  
15 cm/6"

stumpf  
blunt  
mousse  
roma  
smussa

0,2 mm



**11.218.18**  
18 cm/7"

spitz  
sharp  
pointue  
aguda  
acuta

0,3 mm



**11.220.18**  
18 cm/7"

stumpf  
blunt  
mousse  
roma  
smussa

0,2 mm



**11.219.18**  
18 cm/7"

spitz  
sharp  
pointue  
aguda  
acuta

0,3 mm



**11.221.18**  
18 cm/7"

stumpf  
blunt  
mousse  
roma  
smussa



- ergonomischer Griff
- ansprechendes Design
- sichere und feinfühlig Handhabung
- leichtes Reinigen
- keine schmutzanfälligen Riefelungen

- ergonomic handle
- sophisticated design
- safe and sensitive in hand, well balanced
- easy to clean
- no dirt catching knurlings

- manche ergonomique
- aspect attrayant
- une manipulation délicate et en sécurité
- la précision du geste opératoire
- un nettoyage facile
- striure pas sensible à la saleté

- mango ergonómico
- diseño concebido
- manipulación segura y delicada
- limpieza fácil
- las estriadas no son susceptible a la suciedad

- manico ergonomico
- design appariscente
- maneggio sicuro e delicato
- purificazione facile
- non incline de la sporcizia



TOLEDO



**ATRAUMA**



DE BAKEY

18 cm/7"	11.230.18	11.231.18
21 cm/8¼"	11.230.21	11.231.21

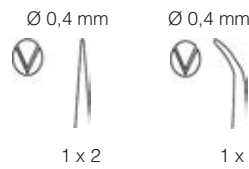

18 cm/7"	11.232.18	11.233.18
21 cm/8¼"	11.232.21	11.233.21

diamantiertes Maul  
 diamond coated jaws  
 mors diamanté  
 boca diamantada  
 morso diamantato

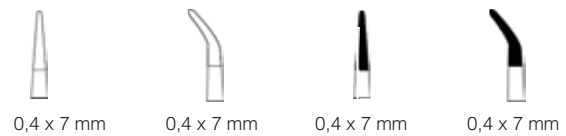

18 cm/7"	11.234.18	11.235.18	11.244.18	11.245.18
21 cm/8¼"	11.234.21	11.235.21	11.244.21	11.245.21

diamantiertes Maul  
 diamond coated jaws  
 mors diamanté  
 boca diamantada  
 morso diamantato

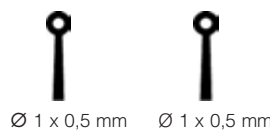

18 cm/7"	11.238.18	11.248.18
21 cm/8¼"	11.238.21	11.248.21



**Atraumatische Pinzetten**  
 Atraumatic tissue forceps  
 Pinces atraumatiques  
 Pinzas atraumáticas  
 Pinze atraumatiche

**ATRAUMA**



DE BAKEY



DE BAKEY

1,0 mm

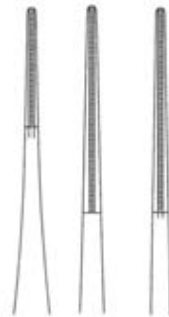

1,5 mm

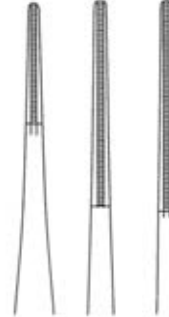

1,8 mm

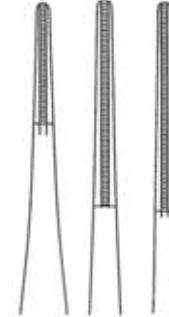

15 cm/6"	11.290.15	11.300.16	11.302.16
20 cm/8"	11.290.20	11.300.20	11.302.20
24 cm/9½"	11.290.24	11.300.24	11.302.24

Titan  
 Titanium  
 Titane  
 Titanio  
 Titanio

2,0 mm

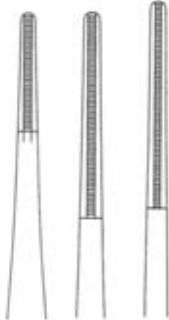

2,5 mm

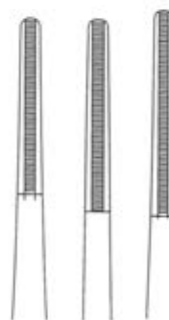

2,8 mm

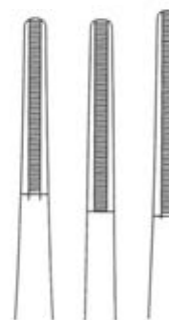

15 cm/6"	11.292.15	11.296.15	11.298.15
20 cm/8"	11.292.20	11.296.20	11.298.20
24 cm/9½"	11.292.24	11.296.24	11.298.24
30 cm/12"	11.292.30	11.296.30	11.298.30

Titan  
 Titanium  
 Titane  
 Titanio  
 Titanio

3,5 mm



2,0 mm



15 cm/6"	11.294.15	11.293.15
20 cm/8"	11.294.20	11.293.20
24 cm/9½"	11.294.24	11.293.24
30 cm/12"	11.294.30	11.293.30

Titan  
 Titanium  
 Titane  
 Titanio  
 Titanio



**ATRAUMA**



DE BAKEY



DE BAKEY



1,5 mm

schlankes Modell  
 delicate pattern  
 modèle délicat  
 modelo delgado  
 modello fino

1,5 mm

2,5 mm

2,0 mm

schlankes Modell  
 delicate pattern  
 modèle délicat  
 modelo delgado  
 modello fino

15 cm/6"	11.322.16		11.324.15
16 cm/6¼"		11.306.16	
19,5 cm/7¾"	11.322.20		11.324.20
20 cm/8"		11.306.20	
24 cm/9½"	11.322.24	11.306.24	11.324.24
30 cm/12"	11.322.30	11.306.30	11.324.30

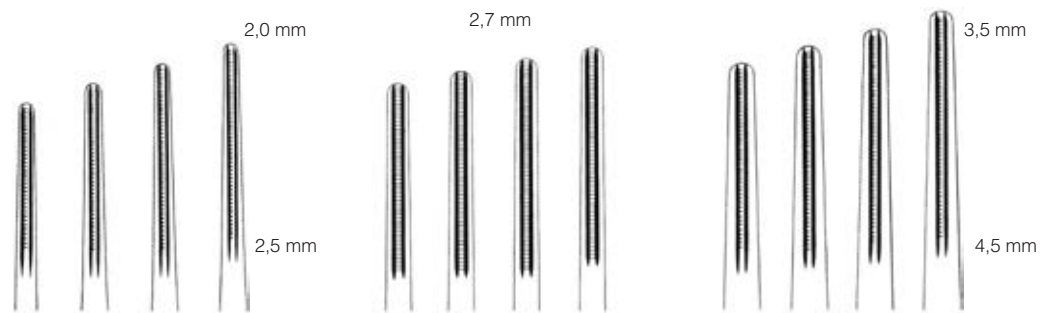

2,0 mm

2,7 mm

3,5 mm

2,5 mm

4,5 mm

16 cm/6¼"	11.308.16	11.304.16	11.310.16
20 cm/8"	11.308.20	11.304.20	11.310.20
24 cm/9½"	11.308.24	11.304.24	11.310.24
30 cm/12"	11.308.30	11.304.30	11.310.30
35 cm/14"			11.310.35
40 cm/16"			11.310.40

2,7 mm

3,5 mm



15 cm/6"	11.332.15	11.334.15
19,5 cm/7¾"	11.332.20	11.334.20
24 cm/9½"	11.332.24	11.334.24
30 cm/12"	11.332.30	11.334.30
35 cm/14"		11.334.35





**Atraumatische Pinzetten**  
 Atraumatic tissue forceps  
 Pincés atraumáticas  
 Pinzas atraumáticas  
 Pinze atraumatiche

**ATRAUMA**



DE BAKEY

2,0 mm



2,5 mm

16 cm/6¼"	11.309.16
20 cm/8"	11.309.20
24 cm/9½"	11.309.24
30 cm/12"	11.309.30

2,7 mm



15 cm/6"	11.333.15
19,5 cm/7¾"	11.333.20
24 cm/9½"	11.333.24
30 cm/12"	11.333.30



DE BAKEY

**ATRAUMA**



COOLEY

2,0 mm



COOLEY

16 cm/6¼"	11.314.16
20 cm/8"	11.314.20
24 cm/9½"	11.314.24

**ATRAUMA**



DE BAKEY

1,0 mm



DE BAKEY

15 cm/6"	11.315.15
19,5 cm/7¾"	11.315.19
24 cm/9½"	11.315.24

**ATRAUMA**



DE BAKEY

1,5 mm



DE BAKEY-DIETHRICH

15 cm/6"	11.316.16
19,5 cm/7¾"	11.316.20
24 cm/9½"	11.316.24





**ATRAUMA**



DE BAKEY 1,5 mm



DE BAKEY-ADSON

12 cm/4¾"	11.318.12
15 cm/6"	11.318.15

**ATRAUMA**



DE BAKEY 1,0 mm



DE BAKEY-GERALD

18 cm/7"	11.430.18
20 cm/8"	11.430.20



11.462.15  
 15 cm/6"  
 4 mm



11.462.24  
 24 cm/9½"  
 8 mm

**ATRAUMA**



COOLEY

GLASSMAN



### Atraumatische Pinzetten

Atraumatic tissue forceps  
Pincés atraumáticos  
Pinzas atraumáticas  
Pinze atraumatiche



extrem leicht  
extremely light  
extrêmement légère  
extremo ligero  
estremo leggero

ULTRA-LIGHT

1,2 mm

1,5 mm



11.428.15  
15 cm/6"

11.428.20  
20 cm/8"

1,5 mm

1,5 mm



11.428.24  
24 cm/9½"

11.428.30  
30 cm/12"

**ATRAUMA**



DE BAKEY

mit TC-Einsätzen  
with TC inserts  
avec mors TC  
con bocas TC  
con morso TC

Nadel ziehende chirurgische Pinzetten  
Needle pulling tissue forceps  
Pince aiguille-tirant  
Pinzas tira-agujas  
Pinze tira-ago



CHITWOOD-DE BAKEY

1,5 mm

2,0 mm

2,7 mm

3,5 mm

6 x 12

6 x 12

6 x 12

6 x 12



15 cm/6"  
19,5 cm/7¾"  
24 cm/9½"

11.404.15  
11.404.19  
11.404.24

11.412.15  
11.412.19  
11.412.24

11.414.15  
11.414.19  
11.414.24

11.416.15  
11.416.19  
11.416.24

1,5 mm

2,0 mm

2,7 mm

3,5 mm

2 x 4

2 x 4

2 x 4

2 x 4



15 cm/6"  
19,5 cm/7¾"  
24 cm/9½"

11.402.15  
11.402.20  
11.402.24

11.422.15  
11.422.19  
11.422.24

11.424.15  
11.424.19  
11.424.24

11.426.15  
11.426.19  
11.426.24



diamantiertes Maul  
 diamond coated jaws  
 mors diamanté  
 boca diamantada  
 morso diamantato



15 cm/6"	11.654.15	11.655.15
18 cm/7"	11.654.18	11.655.18
21 cm/8¼"	11.654.21	11.655.21
25 cm/10"	11.654.25	11.655.25

diamantiertes Maul  
 diamond coated jaws  
 mors diamanté  
 boca diamantada  
 morso diamantato



15 cm/6"	11.650.15	11.651.15		
18 cm/7"	11.650.18	11.651.18	11.652.18	11.653.18
21 cm/8¼"	11.650.21	11.651.21		
23 cm/9"	11.650.23	11.651.23		
25 cm/10"	11.650.25	11.651.25		

**ATRAUMA**



DE BAKEY



15 cm/6"	11.656.15	11.657.15
18 cm/7"	11.656.18	11.657.18
21 cm/8¼"	11.656.21	11.657.21

mit Gewicht  
 with weight  
 avec poids  
 con peso  
 con peso



### Mikrochirurgie-Pinzetten

Microsurgery forceps  
Pincas à microchirurgie  
Pinzas para microcirugia  
Pinze per microchirurgia

diamantiertes Maul  
diamond coated jaws  
mors diamanté  
boca diamantada  
morso diamantato

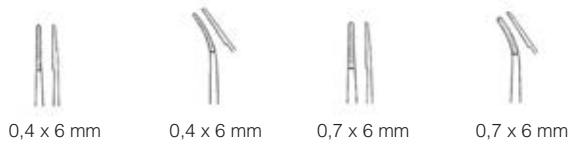

15 cm/6"	10.564.15	10.565.15	10.566.15	10.567.15
18 cm/7"	10.564.18	10.565.18	10.566.18	10.567.18
21 cm/8¼"			10.566.21	10.567.21
23 cm/9"			10.566.23	10.567.23

15 cm/6"	11.578.15	11.579.15	11.580.15	11.581.15
18 cm/7"	11.578.18	11.579.18	11.580.18	11.581.18
21 cm/8¼"			11.580.21	11.581.21

Titan  
Titanium  
Titane  
Titanio  
Titanio

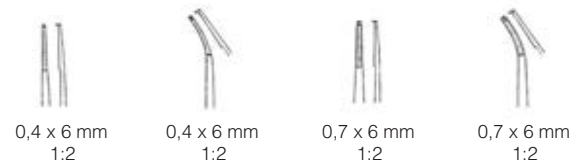

15 cm/6"	10.568.15	10.569.15	10.570.15	10.571.15
18 cm/7"	10.568.18	10.569.18	10.570.18	10.571.18
21 cm/8¼"			10.570.21	10.571.21
23 cm/9"			10.570.23	10.571.23

15 cm/6"	11.582.15	11.583.15	11.584.15	11.585.15
18 cm/7"	11.582.18	11.583.18	11.584.18	11.585.18
21 cm/8¼"			11.584.21	11.585.21

Titan  
Titanium  
Titane  
Titanio  
Titanio

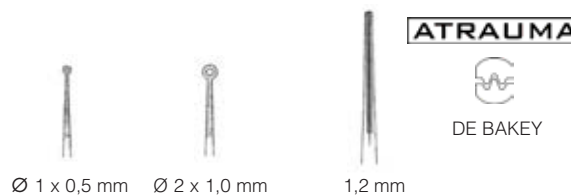

15 cm/6"	10.574.15	10.576.15	10.589.15
18 cm/7"	10.574.18	10.576.18	10.589.18
21 cm/8¼"	10.574.21	10.576.21	10.589.21
23 cm/9"	10.574.23	10.576.23	

15 cm/6"	11.586.15	11.588.15	11.590.15
18 cm/7"	11.586.18	11.588.18	11.590.18
21 cm/8¼"	11.586.21	11.588.21	11.590.21

Titan  
Titanium  
Titane  
Titanio  
Titanio



<b>BIEMER</b>	Maulöffnung Opening of jaw Ouverture des mors Apertura de boca Apertura di morsi	Maullänge Length of jaw Longueur des mors Longitud de boca Lunhg. di morsi	Schließkraft Closing force Force d' occlusion Fuerza de oclusión Forza di occlusiva	Gefäß Ø Vessel Ø Vaisseau Ø Vaso Ø Vaso Ø
	4,0 mm	6,0 mm	30 - 40 gms 0,29 - 0,39 Newton	0,5 - 2,0 mm
	5,0 mm	9,0 mm	30 - 40 gms 0,29 - 0,39 Newton	0,5 - 2,0 mm
	5,0 mm	9,0 mm	20 - 25 gms 0,19 - 0,24 Newton	0,5 - 2,0 mm



Anlegepinzette ohne Schloss  
 Applying forceps without lock  
 Pince à appliquer sans blocage  
 Pinza sin cierre  
 Applicatore senza serratura

**BIEMER**  
**12.046.14**  
 14,5 cm/5¾"







Anlegepinzette mit Schloss  
 Applying forceps with lock  
 Pince à appliquer avec blocage  
 Pinza con cierre  
 Applicatore con serratura

**BIEMER**  
**12.048.14**  
 14,5 cm/5¾"



### Gefäßclips - für temporären Gebrauch

Vessel clips - for temporary occlusion  
 Clips vasculaires - pour usage temporaire  
 Clips vasculares - para oclusión temporal  
 Clips vascolari - per occlusioni temporari

MEHDORN	Maullänge Length of jaw Longueur des mors Longitud de boca Lunghg. di morsi	Schließkraft Closing force Force d' occlusion Fuerza de oclusión Forza di occlusiva	Gefäß Ø Vessel Ø Vaisseau Ø Vaso Ø
 12.043.01	4 x 1,0 mm	10 - 15 gms 0,10 - 0,15 Newton	0,5 - 1,5 mm
 12.043.02	4 x 1,4 mm	15 - 20 gms 0,15 - 0,20 Newton	0,5 - 1,5 mm
 12.043.03	6 x 1,0 mm	10 - 15 gms 0,10 - 0,15 Newton	0,5 - 1,5 mm
 12.043.04	6 x 1,4 mm	15 - 20 gms 0,15 - 0,20 Newton	0,5 - 1,5 mm

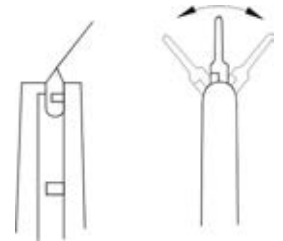



Anlegepinzette ohne Schloss  
 Applying forceps without lock  
 Pince à appliquer sans blocage  
 Pinza sin cierre  
 Applicatore senza serratura



MEHDORN  
 12.050.15  
 15 cm/6"

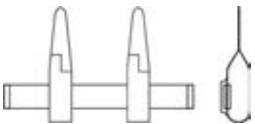

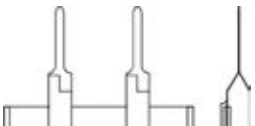
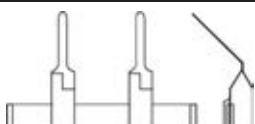
<b>BIEMER - MÜLLER</b>	Maulöffnung Opening of jaw Ouverture des mors Apertura de boca Apertura di morsi	Maullänge Length of jaw Longueur des mors Longitud de boca Lunhg. di morsi	Schließkraft Closing force Force d' occlusion Fuerza de oclusión Forza di occlusiva	Gefäß Ø Vessel Ø Vaisseau Ø Vaso Ø Vaso Ø
 <b>12.014.00</b>	4,0 mm	6,0 mm	30 - 40 gms 0,29 - 0,39 Newton	0,5 - 2,0 mm
 <b>12.010.00</b>	5,0 mm	9,0 mm	30 - 40 gms 0,29 - 0,39 Newton	0,5 - 2,0 mm
 <b>12.011.00</b>	5,0 mm	9,0 mm	30 - 40 gms 0,29 - 0,39 Newton	0,5 - 2,0 mm
 <b>12.012.00</b>	5,0 mm	9,0 mm	30 - 40 gms 0,29 - 0,39 Newton	0,5 - 2,0 mm
 <b>12.013.00</b>	5,0 mm	9,0 mm	30 - 40 gms 0,29 - 0,39 Newton	0,5 - 2,0 mm



**BIEMER**  
**12.046.14**  
 14,5 cm/5¾"

Anlegepinzette ohne Schloss  
 Applying forceps without lock  
 Pince à appliquer sans blocage  
 Pinza sin cierre  
 Applicatore senza serratura



**BIEMER**  
**12.048.14**  
 14,5 cm/5¾"

Anlegepinzette mit Schloss  
 Applying forceps with lock  
 Pince à appliquer avec blocage  
 Pinza con cierre  
 Applicatore con serratura



### Approximatoren

Approximators  
Approximateurs  
Aproximadores  
Approssimatori

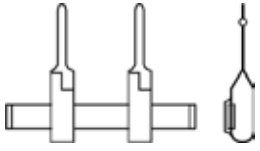
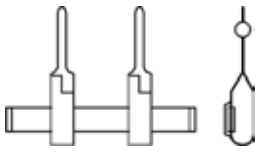
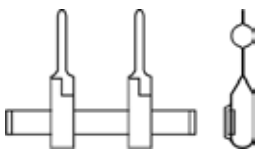
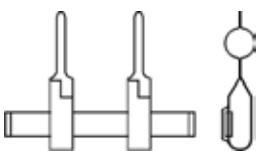
MÜLLER	Ø	Schließkraft Closing force Force d' occlusion Fuerza de oclusión Forza di occlusiva	Gefäß Ø Vessel Ø Vaisseau Ø Vaso Ø Vaso Ø
 12.028.01	1 mm	25 - 30 gms 0,25 - 0,29 Newton	0,5 - 2,0 mm
 12.028.02	2 mm	25 - 30 gms 0,25 - 0,29 Newton	0,5 - 2,0 mm
 12.028.03	3 mm	25 - 30 gms 0,25 - 0,29 Newton	0,5 - 2,0 mm
 12.028.04	4 mm	25 - 30 gms 0,25 - 0,29 Newton	0,5 - 2,0 mm

Anlegepinzette ohne Schloss  
Applying forceps without lock  
Pince à appliquer sans blocage  
Pinza sin cierre  
Applicatore senza serratura

Anlegepinzette mit Schloss  
Applying forceps with lock  
Pince à appliquer avec blocage  
Pinza con cierre  
Applicatore con serratura



**BIEMER**  
12.046.14  
14,5 cm/5¾"



**BIEMER**  
12.048.14  
14,5 cm/5¾"

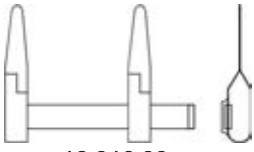

BIEMER	Maulöffnung Opening of jaw Ouverture des mors Apertura de boca Apertura di morsi	Maullänge Length of jaw Longueur des mors Longitud de boca Lunhg. di morsi	Schließkraft Closing force Force d'occlusion Fuerza de oclusión Forza di occlusiva
 12.016.00	5,0 mm	9,0 mm	30 - 40 gms 0,29 - 0,39 Newton



12.016.00

**12.050.14**

BIEMER Approximator Set aus Artikel **12.016.00** & **12.044.14**  
BIEMER Approximator set consisting of **12.016.00** & **12.044.14**  
BIEMER Approximateurs set **12.016.00** & **12.044.14**  
BIEMER Aproximadores set **12.016.00** & **12.044.14**  
BIEMER Approssimatori set **12.016.00** & **12.044.14**

Anlegepinzette ohne Schloss  
Applying forceps without lock  
Pince à appliquer sans blocage  
Pinza sin cierre  
Applicatore senza serratura



**12.024.00**

BIEMER Approximator mit Schlüssel **12.041.01**  
BIEMER Approximator with key **12.041.01**  
BIEMER Approximateurs avec clé **12.041.01**  
BIEMER Aproximadores con llave **12.041.01**  
BIEMER Approssimatori con chiave **12.041.01**



**12.041.00**

BIEMER Approximator mit Schlüssel **12.041.01** und Nadeln **12.041.02**  
BIEMER Approximator with key **12.041.01** and needles **12.041.02**  
BIEMER Approximateurs avec clef **12.041.01** et d'aiguilles **12.041.02**  
BIEMER Aproximadores con llave **12.041.01** y agujas **12.041.02**  
BIEMER Approssimatori con chiave **12.041.01** e aghi **12.041.02**



**12.041.01**

Schlüssel allein  
Key only  
Clé seule  
Llave suelta  
Chiave sola

**12.041.02**







1 Paar Ersatznadeln  
1 Pair of spare needles  
1 Paire d'aiguilles de rechange  
1 Par de agujas de recambio  
1 Paio di aghi di ricambio

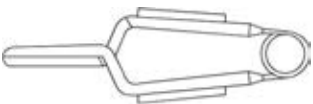

BIEMER  
**12.044.14**  
14,5 cm/5¾"

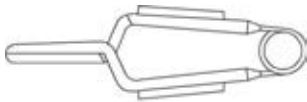
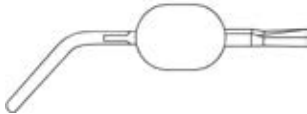
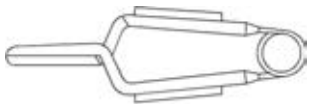
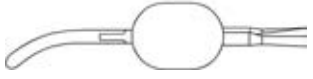
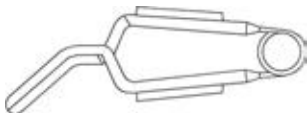

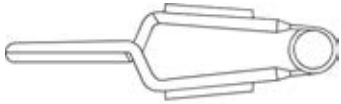
**Gefäßclips - für temporären Gebrauch**  
 Vessel clips - for temporary occlusion  
 Clips vasculaires - pour usage temporaire  
 Clips vasculares - para oclusión temporal  
 Clips vascolari - per occlusione temporari

<b>MÜLLER</b>		Schließkraft Closing force Force d' occlusion Fuerza de oclusión Forza di occlusiva	<b>MÜLLER</b>		Schließkraft Closing force Force d' occlusion Fuerza de oclusión Forza di occlusiva
 	<b>12.030.50</b>	50 gms 0,49 Newton	 	<b>12.035.50</b>	50 gms 0,49 Newton
	<b>12.030.80</b>	80 gms 0,79 Newton		<b>12.035.80</b>	80 gms 0,79 Newton
 	<b>12.031.50</b>	50 gms 0,49 Newton	 	<b>12.037.50</b>	50 gms 0,49 Newton
	<b>12.031.80</b>	80 gms 0,79 Newton		<b>12.037.80</b>	80 gms 0,79 Newton
 	<b>12.033.50</b>	50 gms 0,49 Newton			
	<b>12.033.80</b>	80 gms 0,79 Newton			



<b>BULLDOG STANDARD</b>	Schließkraft Closing force Force d' occlusion Fuerza de oclusión Forza di occlusiva
 40.567.40	120-150 gms.
 40.567.50	120-150 gms.

<b>BULLDOG STANDARD</b>	Schließkraft Closing force Force d' occlusion Fuerza de oclusión Forza di occlusiva
 40.567.52	120-150 gms.
 40.567.54	120-150 gms.





<b>BULLDOG STANDARD</b>	Schließkraft Closing force Force d' occlusion Fuerza de oclusión Forza di occlusiva
 40.567.46	120-150 gms.



<b>BULLDOG MINI</b>	Schließkraft Closing force Force d' occlusion Fuerza de oclusión Forza di occlusiva
 40.567.10	70-100 gms.
 40.567.12	70-100 gms.

<b>BULLDOG MINI</b>	Schließkraft Closing force Force d' occlusion Fuerza de oclusión Forza di occlusiva
 40.567.20	70-100 gms.
 40.567.22	70-100 gms.

**ACLAND Mikro-Gefäßclips**  
 ACLAND Micro vessel clips  
 ACLAND Micro clips vasculaires  
 ACLAND Micro clips vasculares  
 ACLAND Micro clips vascolari

Länge / Length / Longueur Longitud / Lunghezza		8 mm	11 mm	16 mm	24 mm	35 mm
Gefäß / Vessel / Vaisseaux Vaso / Vaso	∅	0,3 - 1,0 mm	0,6 - 1,4 mm	1,0 - 2,2 mm	1,5 - 3,3 mm	2,0 - 5,0 mm

Vene / Vein / Veine Vena / Vena	V	12.052.11	12.052.12	12.052.13	12.052.14	12.052.15
		12.052.11B	12.052.12B	12.052.13B	12.052.14B	12.052.15B
Arterie / Artery / Artère Arteria/ Arteria	A	12.052.01	12.052.02	12.052.03	12.052.04	12.052.05
		12.052.01B	12.052.02B	12.052.03B	12.052.04B	12.052.05B
Einzel Clips Single Clips Clips simples Clip singular Clips singoli  Verpackungseinheit 2 Stück Packing unit 2 pieces Boîtes de 2 pièces Cajas con 2 piezas Unità di 2 pezzi						

Vene / Vein / Veine Vena / Vena	V	12.052.31	12.052.32	12.052.33
		12.052.31B	12.052.32B	12.052.33B
Arterie / Artery / Artère Arteria/ Arteria	A	12.052.21	12.052.22	12.052.23
		12.052.21B	12.052.22B	12.052.23B
Einzel Clips Single Clips Clips simples Clip singular Clips singoli  Verpackungseinheit 2 Stück Packing unit 2 pieces Boîtes de 2 pièces Cajas con 2 piezas Unità di 2 pezzi				

**B =**  
 Schwarz beschichtet  
 Black coated  
 Noir enduit  
 Negro recubierto  
 Nero politenato



Länge / Length / Longueur Longitud / Lunghezza		8 mm	11 mm	16 mm	24 mm	35 mm
Gefäß / Vessel / Vaisseaux Vaso / Vaso	Ø	0,3 - 1,0 mm	0,6 - 1,4 mm	1,0 - 2,2 mm	1,5 - 3,3 mm	2,0 - 5,0 mm

Vene / Vein / Veine Vena / Vena	V	12.052.51	12.052.52	12.052.53	12.052.54	12.052.55
		12.052.51B	12.052.52B	12.052.53B	12.052.54B	12.052.55B
Arterie / Artery / Artère Arteria/ Arteria	A	12.052.41	12.052.42	12.052.43	12.052.44	12.052.45
		12.052.41B	12.052.42B	12.052.43B	12.052.44B	12.052.45B
Approximatoren Approximators Approximateurs Aproximadores Aprossimatori						

Vene / Vein / Veine Vena / Vena	V	12.052.71	12.052.72	12.052.73
		12.052.71B	12.052.72B	12.052.73B
Arterie / Artery / Artère Arteria/ Arteria	A	12.052.61	12.052.62	12.052.63
		12.052.61B	12.052.62B	12.052.63B
Approximatoren Approximators Approximateurs Aproximadores Aprossimatori				

**B =**  
 Schwarz beschichtet  
 Black coated  
 Noir enduit  
 Negro recubierto  
 Nero politenato

Vene / Vein / Veine Vena / Vena	V	12.052.91	12.052.92	12.052.93
		12.052.91B	12.052.92B	12.052.93B
Arterie / Artery / Artère Arteria/ Arteria	A	12.052.81	12.052.82	12.052.83
		12.052.81B	12.052.82B	12.052.83B
Approximatoren Approximators Approximateurs Aproximadores Aprossimatori				



### ACLAND Clip-Anlegepinzetten

ACLAND Clip applying forceps  
ACLAND Pincés pour appliquer des clips  
ACLAND Pinzas para aplicar clips  
ACLAND Pinze per applicare clips

für Clips 8 - 11 mm  
for clips 8 - 11 mm  
pour clips 8 - 11 mm  
para clips 8 - 11 mm  
per clips 8 - 11 mm

ohne Schloss  
without lock  
sans fermeture  
sin cierre  
senza serratura

mit Schloss  
with lock  
avec fermeture  
con cierre  
con serratura



ACLAND  
12.053.00  
14 cm/5½"



ACLAND  
12.053.10  
14 cm/5½"

für Clips 16 - 35 mm  
for clips 16 - 35 mm  
pour clips 16 - 35 mm  
para clips 16 - 35 mm  
per clips 16 - 35 mm

ohne Schloss  
without lock  
sans fermeture  
sin cierre  
senza serratura

mit Schloss  
with lock  
avec fermeture  
con cierre  
con serratura



ACLAND  
12.053.02  
14 cm/5½"



ACLAND  
12.053.12  
14 cm/5½"

für Clips 8 - 11 mm  
for clips 8 - 11 mm  
pour clips 8 - 11 mm  
para clips 8 - 11 mm  
per clips 8 - 11 mm

ohne Schloss  
without lock  
sans fermeture  
sin cierre  
senza serratura

mit Schloss  
with lock  
avec fermeture  
con cierre  
con serratura



30°

ACLAND  
12.053.01  
14 cm/5½"



30°

ACLAND  
12.053.11  
14 cm/5½"

### Titan Ligaturclips, Anlegezangen

Titanium ligature clips, appliers  
Clips titane à ligature, pinces à appliquer des clips  
Clips titanio para ligadura, pinzas para aplicar clips  
Clips titanio per legatura, pinza per applicare clip



SLS Standard		Anlegezange Applying forceps Pinces pour appliquer des clips Pinzas para aplicación Pinza per applicare clip	
mikro <b>MICRO</b> micro micro micro	weiß	15 cm/6"	40.000.15
	white	19 cm/7½"	40.000.19
	blanc	28 cm/11"	40.000.28
	blanco		
klein <b>SMALL</b> petit pequeño piccolo	gelb	15 cm/6"	40.001.15
	yellow	19 cm/7½"	40.001.19
	jaune	28 cm/11"	40.001.28
	amarillo		
klein- mittel <b>SMALL-MEDIUM</b> petit-moyen pequeño-mediano piccolo-medio	lila	15 cm/6"	40.002.15
	purple	19 cm/7½"	40.002.19
	violet	28 cm/11"	40.002.28
	morado		
mittel <b>MEDIUM</b> moyen mediano medio	blau	15 cm/6"	40.003.15
	blue	19 cm/7½"	40.003.19
	bleu	28 cm/11"	40.003.28
	azul		
mittel groß <b>MEDIUM-LARGE</b> moyen large medio grande medio grande	grün	19 cm/7½"	40.004.19
	green	28 cm/11"	40.004.28
	vert		
	verde		
groß <b>LARGE</b> large grande grande	orange	19 cm/7½"	40.005.19
	orange	28 cm/11"	40.005.28
	orange		
	naranja		



ETHICON®		Anlegezange Applying forceps Pinces pour appliquer des clips Pinzas para aplicación Pinza per applicare clip		Titan-Clips, Packungsgröße Titanium clips, Packing unit Clips en titane, Unité d'emballage Clips de titanio, Contenido de caja Clip in titanio, Unita di confezione	
klein <b>SMALL</b> petit pequeño piccolo	blau	15 cm/6"	40.006.15	92.909.31	36 à 6 Clips
	blue	19 cm/7½"	40.006.19		
	bleu				
mittel <b>MEDIUM</b> moyen mediano medio	weiß	15 cm/6"	40.007.15	92.909.32	36 à 6 Clips
	white	19 cm/7½"	40.007.19		
	blanc	28 cm/11"	40.007.28		
mittel groß <b>MEDIUM-LARGE</b> moyen large medio grande medio grande	grün	19 cm/6"	40.008.19	92.909.30	18 à 6 Clips
	green	28 cm/7½"	40.008.28		
	vert				
groß <b>LARGE</b> large grande grande	gelb	19 cm/6"	40.009.19	92.909.34	18 à 6 Clips
	yellow	28 cm/7½"	40.009.28		
	jaune				



Titan-Clips  
Titanium clips  
Clips en titane  
Clips de titanio  
Clips di titanio



für permanenten Verschluß  
 for permanent closure  
 pour la fermeture permanente  
 para el cierre permanente  
 per la chiusura permanente

Titan / Titanium	40.920.63	40.920.71	40.920.79	40.920.93	40.760.93	40.770.91
PHYNOX	40.920.62	40.920.70	40.920.78	40.920.92	40.760.92	40.770.90
Öffnung/max. opening	6,2 mm	7,0 mm	7,8 mm	9,2 mm	10,6 mm	11,4 mm
Druck / Force	150 gms	180 gms	180 gms	200 gms	200 gms	200 gms

40.780.41	40.922.61	40.922.69	40.922.76	40.920.88	40.920.11	40.924.56
40.780.40	40.922.60	40.922.68	40.742.98	40.920.87	40.920.10	40.924.55
13,3 mm	6,0 mm	6,8 mm	7,5 mm	8,7 mm	11,0 mm	5,5 mm
200 gms	150 gms	180 gms	180 gms	200 gms	200 gms	150 gms







40.924.62	40.924.66	40.920.74	40.920.00	40.924.57	40.924.59	40.924.64
40.924.61	40.924.65	40.920.73	40.920.99	40.924.54	40.924.58	40.924.63
6,1 mm	6,5 mm	7,4 mm	9,9 mm	5,4 mm	5,8 mm	6,2 mm
180 gms	180 gms	200 gms	200 gms	180 gms	180 gms	180 gms





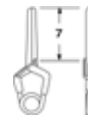





# MINI

YASARGIL Aneurysmen Clips  
 YASARGIL Aneurysm clips  
 YASARGIL Clips d'anévrisme  
 YASARGIL Clips de aneurisma  
 YASARGIL Clips per aneurisma

für permanenten Verschuß  
 for permanent closure  
 pour la fermeture permanente  
 para el cierre permanente  
 per la chiusura permanente

40.690.31	40.692.36	40.710.41	40.690.31	40.694.37	40.694.41	40.712.39
40.690.30	40.692.35	40.710.40	40.690.30	40.694.36	40.694.40	40.712.38
						
3,3 mm	4,0 mm	4,6 mm	3,3 mm	3,6 mm	4,0 mm	4,4 mm
110 gms	110 gms	110 gms	110 gms	110 gms	110 gms	110 gms

	nicht drehbar / non rotating / non orientable / non rotante / no giratorio	drehbar / rotating / orientable / rotante / giratorio
		
	180 mm 7"	180 mm 7"
<b>MINI</b>	40.776.18	40.776.20
<b>STANDARD</b>	40.778.18	

	nicht drehbar / non rotating / non orientable / non rotante / no giratorio			drehbar / rotating / orientable / rotante / giratorio		
						
	170 mm 6¾"	210 mm 8¼"	230 mm 9"	170 mm 6¾"	210 mm 8¼"	230 mm 9"
<b>MINI</b>	40.772.17	40.772.21	40.772.23	40.772.18	40.772.31	40.772.24
<b>STANDARD</b>	40.774.17	40.774.21	40.774.23	40.774.19	40.774.22	





**Trays für Aneurysmen- & Mikro-Clips**  
 Trays for Aneurysm & micro clips  
 Plateaux pour micro clips d'anévrisme  
 Contenedores para micro clips de aneurisma  
 Cassetta per micro clips per aneurisma

Edelstahl  
 Stainless steel  
 Acier inoxydable  
 Acero inoxidable  
 Acciaio inox



**88.118.50**  
 50 x 25 x 4,5 mm

**88.118.65**  
 65 x 42 x 8 mm

**88.118.75**  
 75 x 25 x 4,5 mm

**88.118.80**  
 80 x 42 x 8 mm



**88.765.02**  
 18 Clips  
 150 x 95 x 13 mm



**88.765.03**  
 42 Clips  
 210 x 125 x 17 mm



**ATRAUMA**



DE BAKEY



**12.059.07**  
70 mm/2¾"



**CAROTID**  
**12.061.09**  
90 mm/3½"



**12.063.10**  
100 mm/4"



DE BAKEY-SATINSKY

**GLOVER**

**12.065.06**  
55 mm/2¼"  
27 mm



**12.070.35**

**12.073.35**



**12.071.35**



**12.075.35**



**12.070.45**

**GLOVER-mini (WELDON)**

45 mm/1¾"  
17 mm



**12.071.45**



**DE BAKEY-GLOVER**

**12.070.50**  
50 mm/2"



**DE BAKEY-GLOVER**

**12.071.50**  
50 mm/2"

**GLOVER-mini (WELDON)**

35 mm/1½"  
14 mm



### Atraumatische Bulldogklemmen

Atraumatic Bulldog clamps  
Clamps Bulldog atraumatiques  
Clamps Bulldog atraumáticas  
Clamps Bulldog atraumatiche



**12.086.09**  
90 mm/3½"  
27 mm



**12.086.11**  
110 mm/4¼"  
44 mm



**12.087.09**  
90 mm/3½"  
41 mm



**12.087.10**  
105 mm/4¼"  
55 mm



**12.087.11**  
110 mm/4¼"  
60 mm



GREGORY-"Soft"



**12.088.01**  
110 mm/4¼"  
60 mm

links  
left  
à gauche  
izquierda  
sinistra



**12.088.02**  
110 mm/4¼"  
60 mm

rechts  
right  
à droite  
derecha  
destra



SANTULLI  
**12.089.07**  
70 mm/2¾"  
30 mm



**ATRAUMA**



DE BAKEY

DE BAKEY-  
DIETRICH

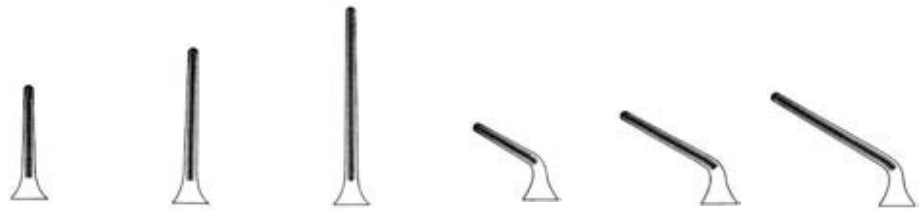

12.078.10      12.078.14      12.078.20      12.079.10      12.079.14      12.079.20

Länge Length Longueur Longitud Lunghezza	47 mm/2"	51 mm/2"	57 mm/2¼"	44 mm/1¾"	46 mm/1¾"	49 mm/2"
Maullänge Length of jaw Longueur des mors Longitud de la boca Lunghezza del morso	10 mm	14 mm	20 mm	10 mm	14 mm	20 mm
Gewicht Weight Poids Peso Peso	3 gr.	3 gr.	3 gr.	3 gr.	3 gr.	3 gr.
Schließdruck Closing pressure Pression d'occlusion Presión de oclusión Pressione di occlusiva	180 gr.	180 gr.	180 gr.	180 gr.	180 gr.	180 gr.



DIETRICH

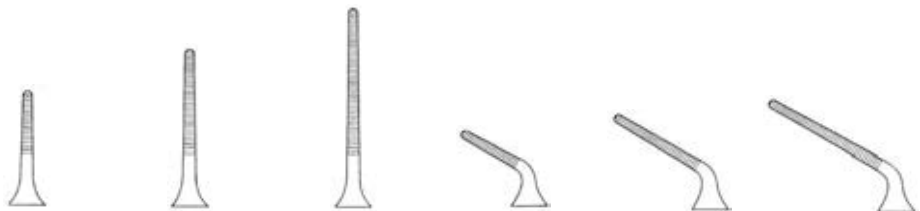

12.082.08      12.082.12      12.082.16      12.083.08      12.083.12      12.083.16

Länge Length Longueur Longitud Lunghezza	49 mm/2"	53 mm/2"	59 mm/2¼"	43 mm/1½"	45 mm/1¾"	50 mm/2"
Maullänge Length of jaw Longueur des mors Longitud de la boca Lunghezza del morso	8 mm	12 mm	20 mm	8 mm	12 mm	20 mm
Gewicht Weight Poids Peso Peso	3 gr.	3 gr.	3 gr.	3 gr.	3 gr.	3 gr.
Schließdruck Closing pressure Pression d'occlusion Presión de oclusión Pressione di occlusiva	50 gr.	50 gr.	50 gr.	50 gr.	50 gr.	50 gr.





### Atraumatische Bulldogklemmen

Atraumatic Bulldog clamps  
Clamps Bulldog atraumatiques  
Clamps Bulldog atraumáticas  
Clamps Bulldog atraumatiche

**ATRAUMA**



DE BAKEY



DE BAKEY



**12.092.07**  
80 mm/3"  
20 mm



**12.092.08**  
90 mm/3½"  
30 mm



**12.092.10**  
105 mm/4¼"  
45 mm



**12.092.12**  
125 mm/4¾"  
68 mm



DE BAKEY



**12.093.07**  
75 mm/2¾"  
20 mm



**12.093.08**  
85 mm/3¼"  
30 mm



**12.093.10**  
95 mm/3½"  
45 mm



**12.093.12**  
115 mm/4½"  
68 mm



**ATRAUMA**



DE BAKEY



GLOVER



**12.096.06**  
70 mm/2¾"  
20 mm



**12.096.07**  
80 mm/3"  
30 mm



**12.096.09**  
95 mm/3½"  
43 mm



**12.096.11**  
115 mm/4½"  
56 mm



GLOVER



**12.097.06**  
55 mm/2¼"  
20 mm



**12.097.07**  
75 mm/2¾"  
30 mm



**12.097.09**  
85 mm/3½"  
43 mm



**12.097.11**  
105 mm/4½"  
56 mm



## Atraumatische Bulldogklemmen

Atraumatic Bulldog clamps  
Clamps Bulldog atraumatiques  
Clamps Bulldog atraumáticas  
Clamps Bulldog atraumatiche

**ATRAUMA**



COOLEY



COOLEY

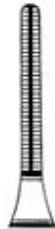

**12.084.08**  
80 mm/3"  
20 mm

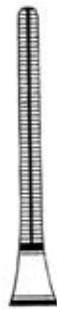

**12.084.09**  
90 mm/3½"  
30 mm

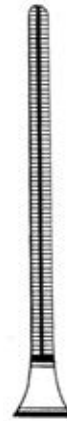

**12.084.10**  
105 mm/4¼"  
45 mm

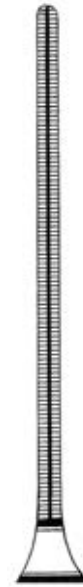

**12.084.12**  
125 mm/4¾"  
68 mm



**12.085.08**  
75 mm/2¾"  
20 mm



**12.085.09**  
85 mm/3¼"  
30 mm

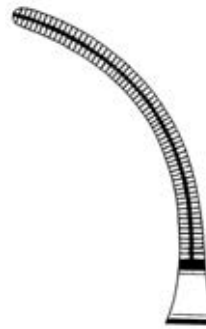

**12.085.10**  
95 mm/3¾"  
45 mm



**12.085.12**  
115 mm/4½"  
68 mm



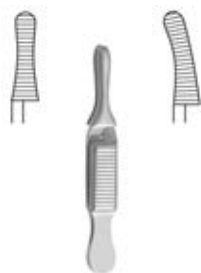

**DIEFFENBACH**

35 mm/1½"	12.102.04	12.103.04
50 mm/2"	12.102.05	12.103.05



**DE BAKEY-HESS**

Maullänge  
Length of jaw  
Longueur des mors  
Longitud de la boca  
Lunghezza del morso

<b>12.112.20</b>	<b>12.112.30</b>
20 mm	30 mm



**DIEFFENBACH**

58 mm/2¼"	12.104.06	12.105.06
-----------	-----------	-----------



Anlege- und Entfernungszange für Bulldogklemmen  
Applying and removing forceps for Bulldog clamps  
Pince pour appliquer et retirer les clamps Bulldog  
Pinza para poner y quitar clamps Bulldog  
Pinza per applicare e rimuovere Bulldog clamps



**12.091.23**  
23 cm/9"



**JOHN-HOPKINS**

50 mm/2"	12.110.50	12.111.50
55mm/2¼"	12.110.55	12.111.55
65 mm/2½"	12.110.65	12.111.65
70 mm/2¾"	12.110.70	12.111.70
75 mm/3"	12.110.75	12.111.75
90 mm/3½"	12.110.90	12.111.90



## Atraumatische Bulldogklemmen

Atraumatic Bulldog Clamps  
Clamps Bulldog atraumatiques  
Clamps Bulldog atraumáticas  
Clamps Bulldog atraumatiche

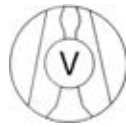

schwache Schließkraft (110 +/- 10 gr.), für Venen  
soft closing pressure (110 +/- 10 gr.), for veins  
force de fermeture faible (110 +/- 10 gr.), pour veines  
fuerza de cierre débil (110 +/- 10 gr.), para venas  
forza di chiusura debole (110 +/- 10 gr.), per vene

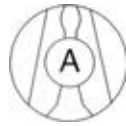

starke Schließkraft (220 +/- 10 gr.), für Arterien  
strong closing pressure (220 +/- 10 gr.), for arteries  
force de fermeture forte (220 +/- 10 gr.), pour artères  
fuerza de cierre fuerte (220 +/- 10 gr.), para arterias  
forza di chiusura forte (220 +/- 10 gr.), per arterie

	30 mm/1¼"	35 mm/1¼"	40 mm/1½"	50 mm/2"	
Vena	<b>12.132.30</b>	<b>12.132.35</b>	<b>12.132.40</b>	<b>12.132.50</b>	Titan Titanium Titane Titanio Titanio
Arteria	<b>12.142.30</b>	<b>12.142.35</b>	<b>12.142.40</b>	<b>12.142.50</b>	



	30 mm/1¼"	35 mm/1¼"	40 mm/1½"	50 mm/2"	
Vena	<b>12.133.30</b>	<b>12.133.35</b>	<b>12.133.40</b>	<b>12.133.50</b>	Titan Titanium Titane Titanio Titanio
Arteria	<b>12.143.30</b>	<b>12.143.35</b>	<b>12.143.40</b>	<b>12.143.50</b>	

	30 mm/1¼"	35 mm/1¼"	40 mm/1½"	50 mm/2"	
Vena	<b>12.135.30</b>	<b>12.135.35</b>	<b>12.135.40</b>	<b>12.135.50</b>	Titan Titanium Titane Titanio Titanio
Arteria	<b>12.145.30</b>	<b>12.145.35</b>	<b>12.145.40</b>	<b>12.145.50</b>	



**HARTMANN (Baby-Mosquito)**  
 9 cm/3½"

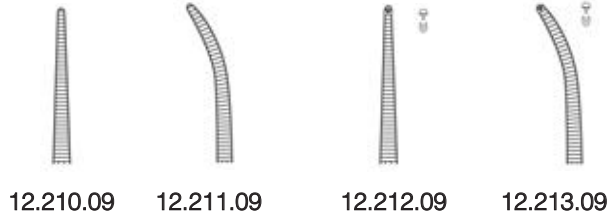

Fadenklemme  
 Ligature forceps  
 Pince à ligature  
 Pinza para ligadura  
 Pinza per legature



Maul kreuzgerieft  
 Cross-serrated jaws  
 Mors à striure en croix  
 Bocas con estrias cruzadas  
 Morso con striature trasversali

**12.215.12**  
 12 cm/4¾"

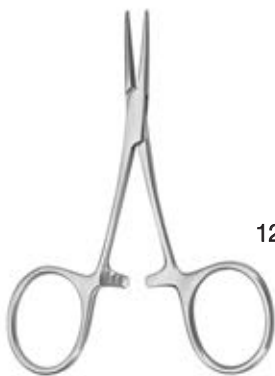

**HARTMANN**  
 10 cm/4"

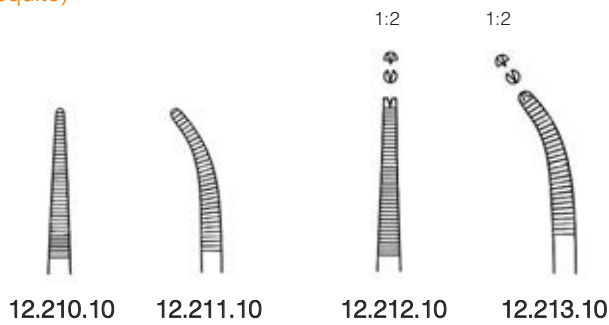

**HALSTED-MOSQUITO micro**

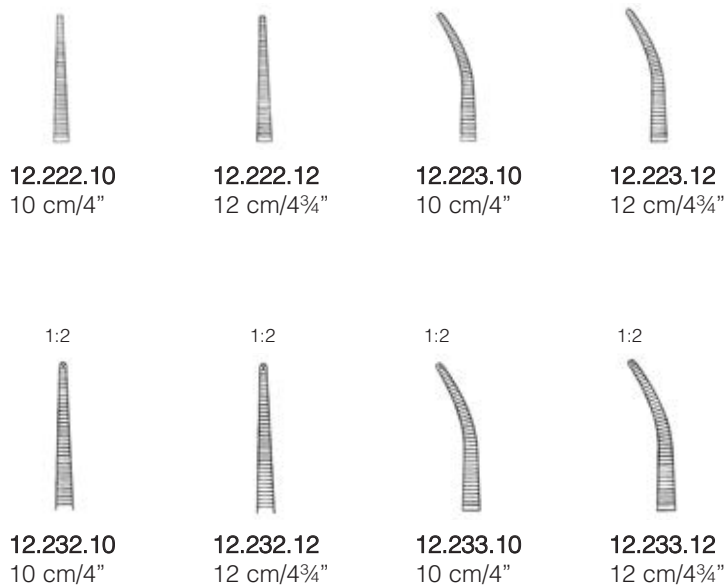



### Arterienklemmen

Hemostatic forceps  
Pinces hémostatiques  
Pinzas hemostáticas  
Pinze emostatiche



HALSTED-MOSQUITO



12.220.12  
**12.224.12**  
12,5 cm/5"



12.220.14  
14,5 cm/5¾"



12.221.12  
**12.225.12**  
12,5 cm/5"



12.221.14  
14,5 cm/5½"

Titan  
Titanium  
Titane  
Titanio  
Titanio



12.230.12  
**12.234.12**  
12,5 cm/5"



12.230.14  
14,5 cm/5¾"



12.231.12  
**12.235.12**  
12,5 cm/5"



12.231.14  
14,5 cm/5½"



HALSTED-MOSQUITO



12.220.18  
18 cm/7"



12.220.21  
21 cm/8¼"



12.221.18  
18 cm/7"



12.221.21  
21 cm/8¼"



12.230.18  
18 cm/7"



12.230.21  
21 cm/8¼"



12.231.18  
18 cm/7"



12.231.21  
21 cm/8¼"

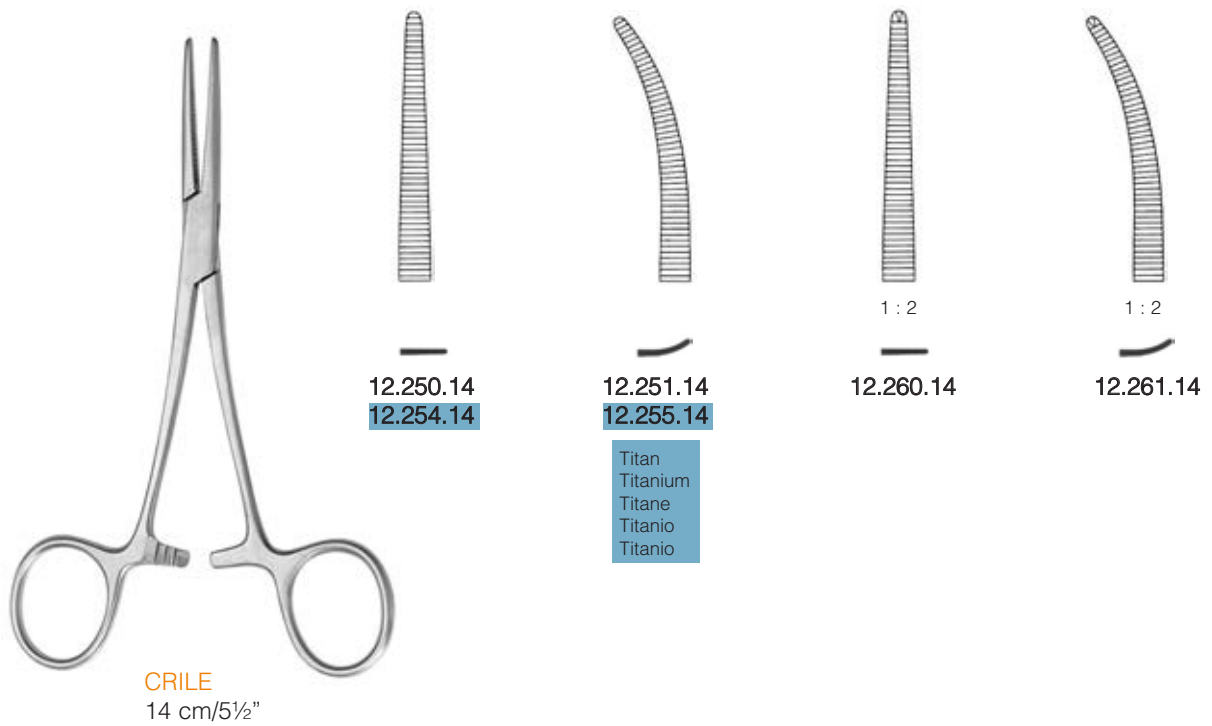
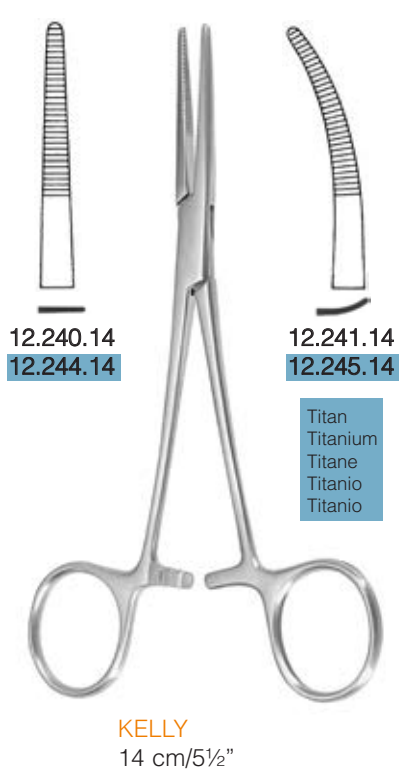



### Arterienklemmen

Hemostatic forceps  
Pinces hémostatiques  
Pinzas hemostáticas  
Pinze emostatiche



**CRILE-RANKIN**  
16 cm/6¼"

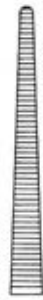

12.262.16



12.263.16



1 : 2  
12.264.16



1 : 2  
12.265.16



**DUNHILL**



12.277.13  
12,5 cm/5"



12.277.19  
19 cm/7½"



12.270.14

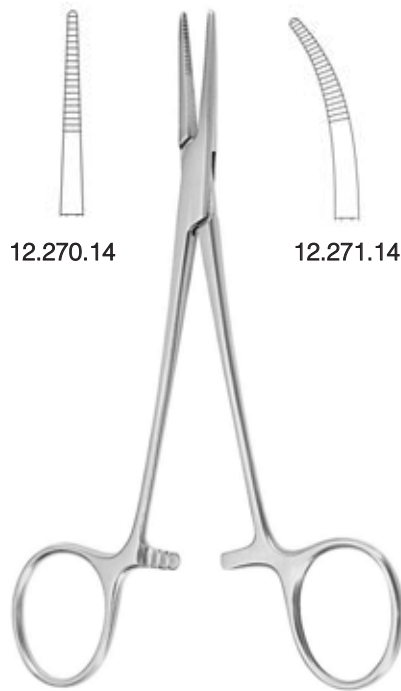

**PROVIDENCE-HOSPITAL**  
14 cm/5½"



12.271.14



ROCHESTER-PEAN

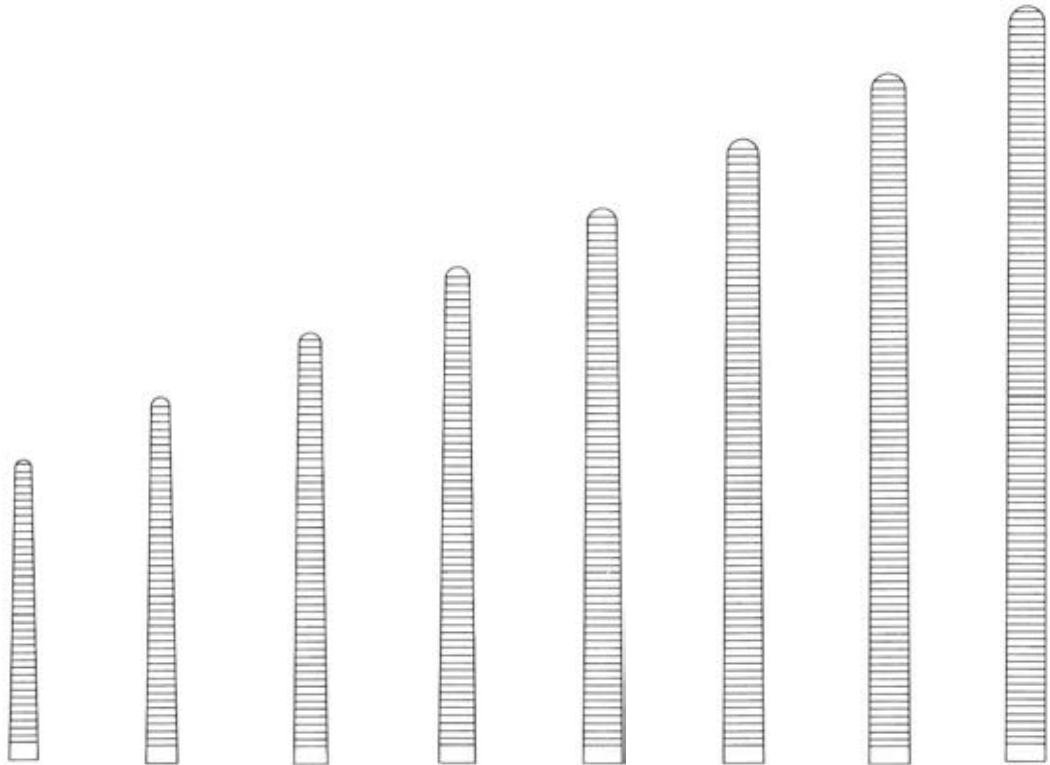

<b>12.310.14</b> 14 cm/5½"	<b>12.310.16</b> 16 cm/6¼"	<b>12.310.18</b> 18 cm/7"	<b>12.310.20</b> 20 cm/8"	<b>12.310.22</b> 22 cm/8¾"	<b>12.310.24</b> 24 cm/9½"	<b>12.310.26</b> 26 cm/10¼"	<b>12.310.30</b> 30 cm/12"
-------------------------------	-------------------------------	------------------------------	------------------------------	-------------------------------	-------------------------------	--------------------------------	-------------------------------

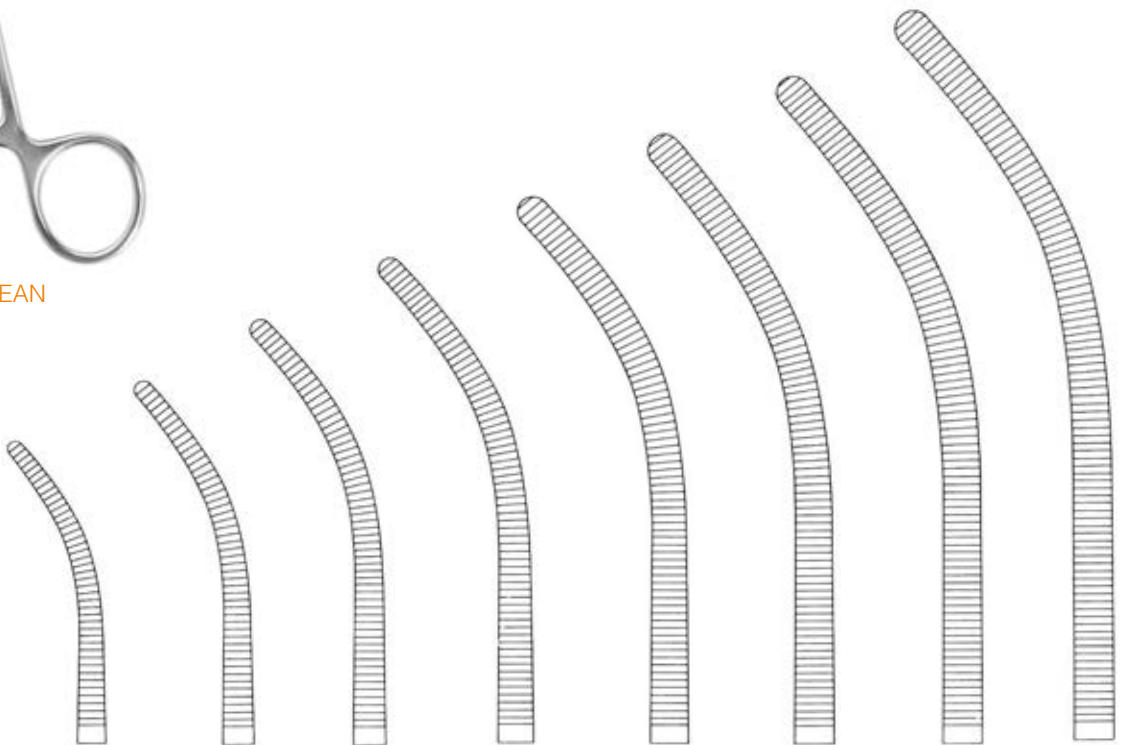

<b>12.311.14</b> 14 cm/5½"	<b>12.311.16</b> 16 cm/6¼"	<b>12.311.18</b> 18 cm/7"	<b>12.311.20</b> 20 cm/8"	<b>12.311.22</b> 22 cm/8¾"	<b>12.311.24</b> 24 cm/9½"	<b>12.311.26</b> 26 cm/10¼"	<b>12.311.30</b> 30 cm/12"
-------------------------------	-------------------------------	------------------------------	------------------------------	-------------------------------	-------------------------------	--------------------------------	-------------------------------



### Arterienklemmen

Hemostatic forceps  
Pincés hémostatiques  
Pinzas hemostáticas  
Pinze emostatiche



ROCHESTER-OGHSNER

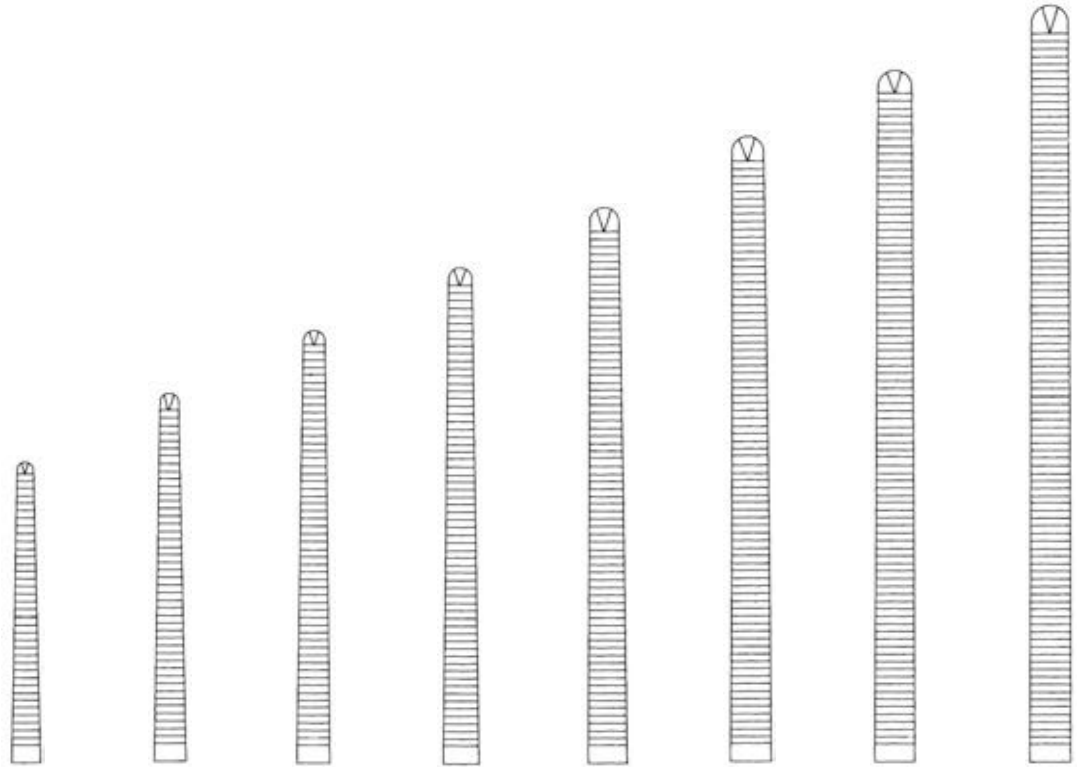

- |                               |                               |                              |                              |                               |                               |                                |                               |
|-------------------------------|-------------------------------|------------------------------|------------------------------|-------------------------------|-------------------------------|--------------------------------|-------------------------------|
| <b>12.320.14</b><br>14 cm/5½" | <b>12.320.16</b><br>16 cm/6¼" | <b>12.320.18</b><br>18 cm/7" | <b>12.320.20</b><br>20 cm/8" | <b>12.320.22</b><br>22 cm/8¾" | <b>12.320.24</b><br>24 cm/9½" | <b>12.320.26</b><br>26 cm/10¼" | <b>12.320.30</b><br>30 cm/12" |
|-------------------------------|-------------------------------|------------------------------|------------------------------|-------------------------------|-------------------------------|--------------------------------|-------------------------------|

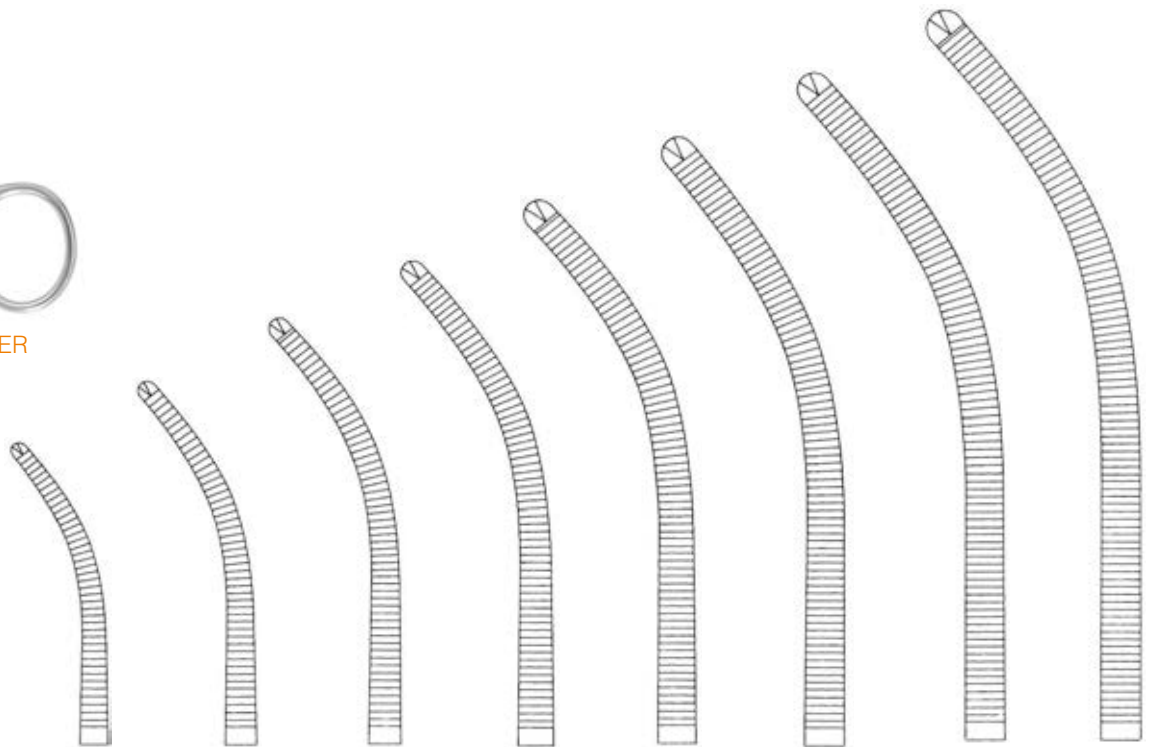

- |                               |                               |                              |                              |                               |                               |                                |                               |
|-------------------------------|-------------------------------|------------------------------|------------------------------|-------------------------------|-------------------------------|--------------------------------|-------------------------------|
| <b>12.321.14</b><br>14 cm/5½" | <b>12.321.16</b><br>16 cm/6¼" | <b>12.321.18</b><br>18 cm/7" | <b>12.321.20</b><br>20 cm/8" | <b>12.321.22</b><br>22 cm/8¾" | <b>12.321.24</b><br>24 cm/9½" | <b>12.321.26</b><br>26 cm/10¼" | <b>12.321.30</b><br>30 cm/12" |
|-------------------------------|-------------------------------|------------------------------|------------------------------|-------------------------------|-------------------------------|--------------------------------|-------------------------------|





Graziles Modell  
 Delicate pattern  
 Modèle délicat  
 Modelo grácil  
 Modello gracile



PEAN

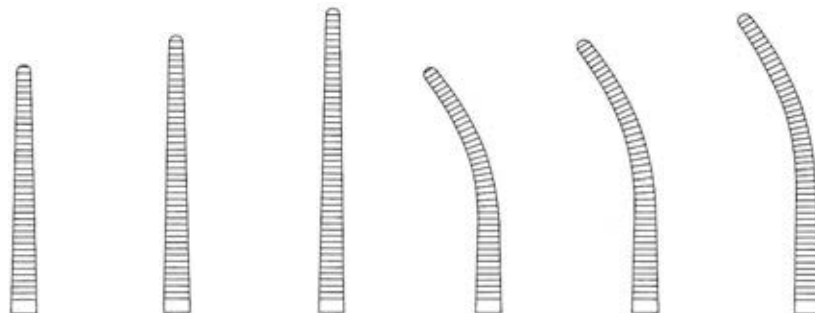

12.312.13  
 13 cm/5"

12.312.14  
 14 cm/5½"

12.312.16  
 16 cm/6¼"

12.313.13  
 13 cm/5"

12.313.14  
 14 cm/5½"

12.313.16  
 16 cm/6¼"

Graziles Modell  
 Delicate pattern  
 Modèle délicat  
 Modelo grácil  
 Modello gracile



KOCHER  
 1 : 2

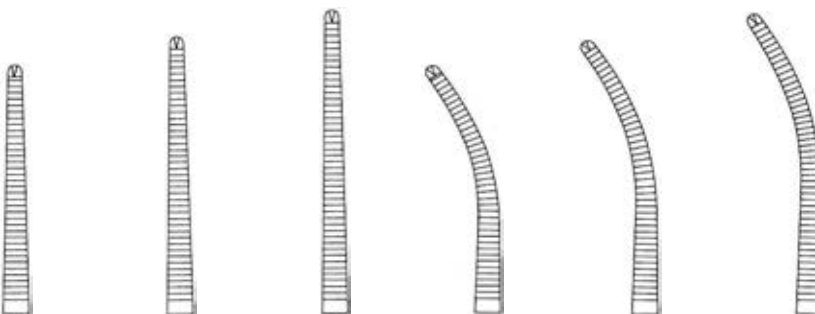

12.322.13  
 13 cm/5"

12.322.14  
 14 cm/5½"

12.322.16  
 16 cm/6¼"

12.323.13  
 13 cm/5"

12.323.14  
 14 cm/5½"

12.323.16  
 16 cm/6¼"



### Arterienklemmen

Hemostatic forceps  
Pinces hémostatiques  
Pinzas hemostáticas  
Pinze emostatiche



PEAN-NIPPON



12.316.14  
14 cm/5½"



12.316.16  
16 cm/6¼"



12.316.18  
18 cm/7"



12.317.14  
14 cm/5½"



12.317.16  
16 cm/6¼"



12.317.18  
18 cm/7"



KOCHER-NIPPON

1 : 2



12.326.14  
14 cm/5½"



12.326.16  
16 cm/6¼"



12.326.18  
18 cm/7"



12.327.14  
14 cm/5½"



12.327.16  
16 cm/6¼"



12.327.18  
18 cm/7"



SPENCER-WELLS

<b>12.330.13</b> 13 cm/5"	<b>12.330.14</b> 14 cm/5½"	<b>12.330.15</b> 15 cm/6"	<b>12.330.18</b> 18 cm/7"	<b>12.330.20</b> 20 cm/8"
<b>12.331.13</b> 13 cm/5"	<b>12.331.14</b> 14 cm/5½"	<b>12.331.15</b> 15 cm/6"	<b>12.331.18</b> 18 cm/7"	<b>12.331.20</b> 20 cm/8"



ROCHESTER-CARMALT

<b>12.340.16</b> 16 cm/6¼"	<b>12.340.20</b> 20 cm/8"	<b>12.341.16</b> 16 cm/6¼"	<b>12.341.20</b> 20 cm/8"



### Arterienklemmen

Hemostatic forceps  
Pinces hémostatiques  
Pinzas hemostáticas  
Pinze emostatiche

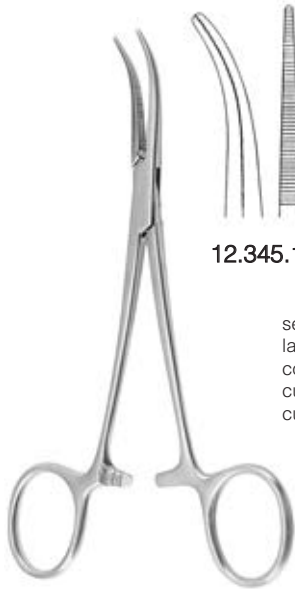

12.345.14

12.347.14

seitlich gebogen  
laterally curved  
courbée latéralement  
curva lateralmente  
curva laterale

**DANDY**  
14,5 cm/5¾"

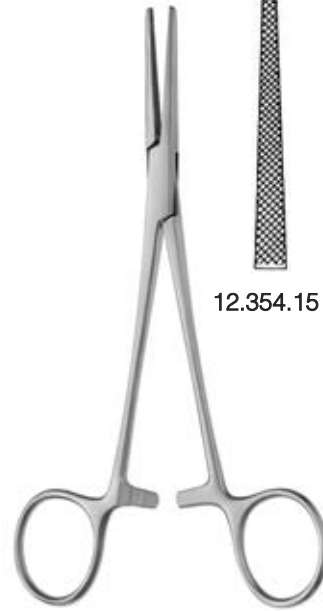

12.354.15

12.356.15

1:2

**LOVELACE**  
15,5 cm/6"

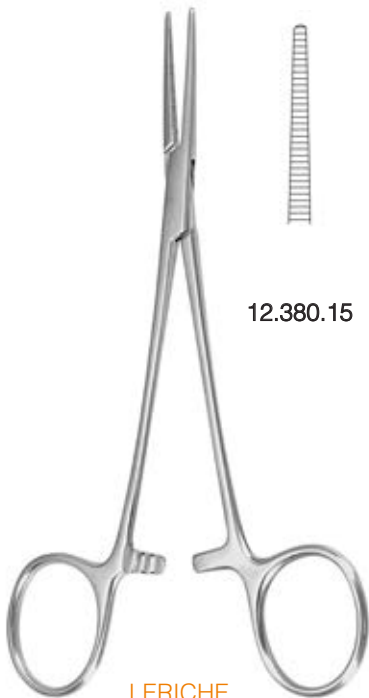

12.380.15

12.381.15

12.382.15

12.383.15

1:2

1:2

**LERICHE**  
15 cm/6"

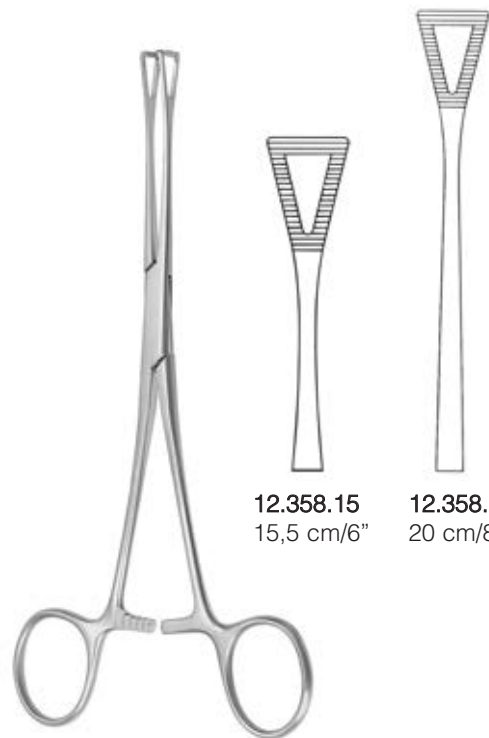

12.358.15  
15,5 cm/6"

12.358.20  
20 cm/8"

**PENNINGTON**



BENGOLEA

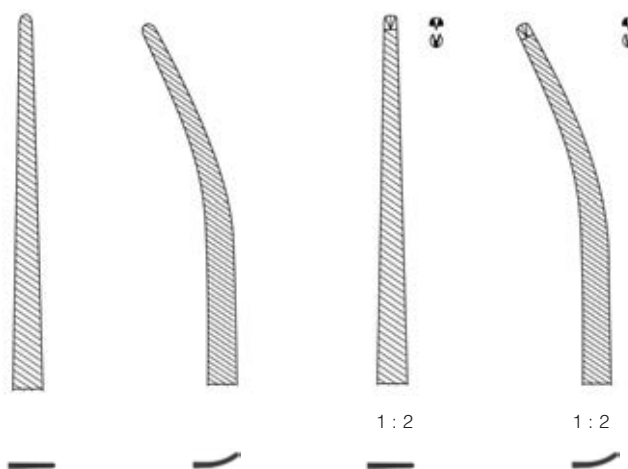

20 cm/8"	12.384.20	12.385.20	12.386.20	12.387.20
26 cm/10¼"	12.384.26	12.385.26	12.386.26	12.387.26

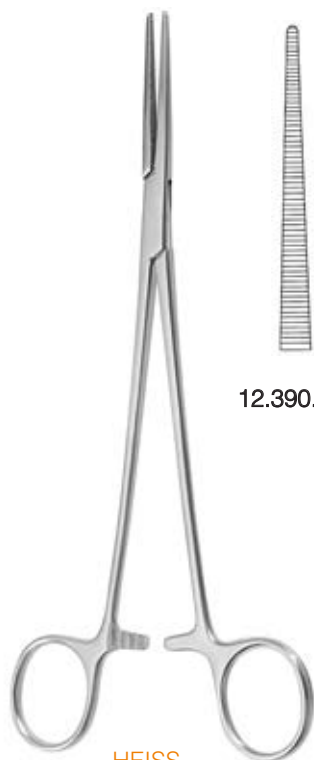

HEISS  
 20 cm/8"

12.390.20

12.391.20

12.393.20



FUCHSIG  
 12.396.19  
 19 cm/7½"



**Arterienklemmen**

Hemostatic forceps  
Pinces hémostatiques  
Pinzas hemostáticas  
Pinze emostatiche



**ADSON Baby**

**12.415.14**  
14 cm/5½"



**12.415.18**  
18 cm/7"



**ADSON**  
18,5 cm/7¼"

**12.410.18**



**12.411.18**



**12.412.18**

1:2



**12.413.18**

1:2



**JACOBSON-MOSQUITO**  
12,5 cm/5"

**12.416.12**

grazil  
delicate  
délicat  
fino  
delicate



**12.417.12**



**JACOBSON**  
18 cm/7"

**12.416.18**



**12.417.18**



**12.419.18**

grazil  
delicate  
délicat  
fino  
delicate



**GEMINI**



**12.431.13**  
13 cm/5"



**12.431.16**  
16 cm/6¼"

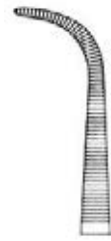

**12.431.18**  
18 cm/7"

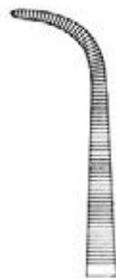

**12.431.20**  
20 cm/8"



**12.431.23**  
23 cm/9"



**12.431.25**  
25 cm/10"

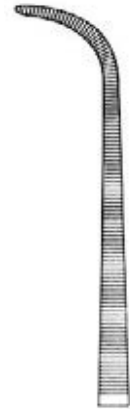

**12.431.28**  
28 cm/11"



**GEMINI mini**

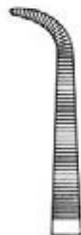

**12.433.18**  
18 cm/7"



**12.433.22**  
22 cm/8¾"



**12.433.25**  
25 cm/10"

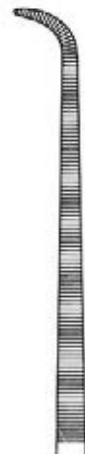

**12.433.28**  
28 cm/11"



## Arterienklemmen

Hemostatic forceps  
Pincés hémostatiques  
Pinzas hemostáticas  
Pinze emostatiche

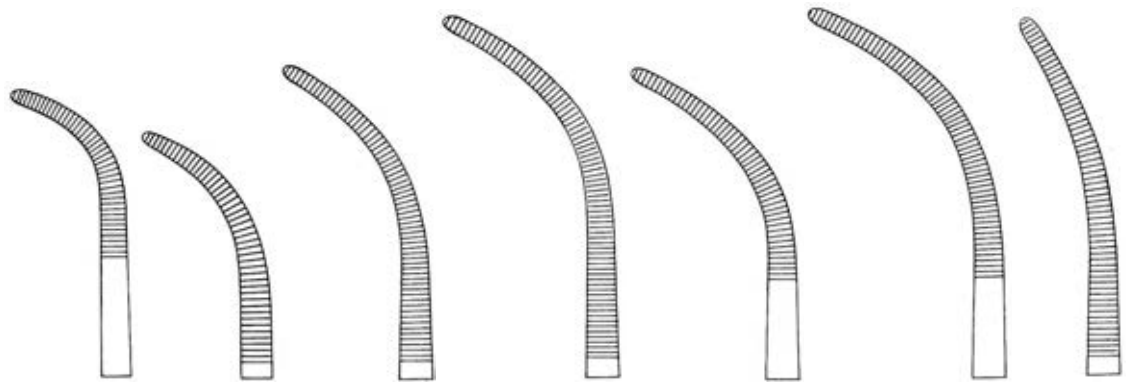

**12.421.01**  
21 cm/8¼"

**12.421.02**  
21 cm/8¼"

**12.421.03**  
21 cm/8¼"

**12.421.04**  
21 cm/8¼"

**12.421.05**  
21 cm/8¼"

**12.421.06**  
21 cm/8¼"

**12.421.07**  
21 cm/8¼"

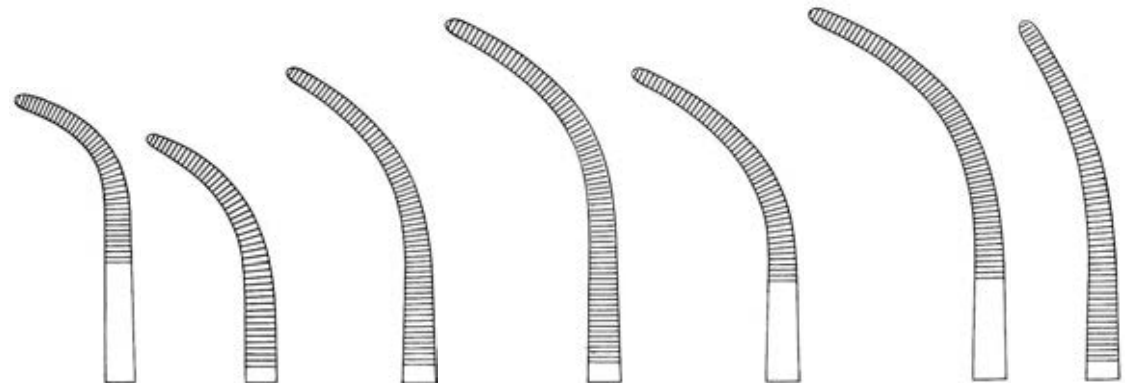

**12.427.01**  
27 cm/10¾"

**12.427.02**  
27 cm/10¾"

**12.427.03**  
27 cm/10¾"

**12.427.04**  
27 cm/10¾"

**12.427.05**  
27 cm/10¾"

**12.427.06**  
27 cm/10¾"

**12.427.07**  
27 cm/10¾"



OVERHOLT-GEISSENDOERFER





**OVERHOLT-BABY**  
**12.284.14**  
 13,5 cm/5¼"



**OVERHOLT**

**12.428.00**  
 29,5 cm/12"

**12.428.01**  
 29,5 cm/12"

**12.428.06**  
 30 cm/12"



**OVERHOLT fino**

graziles Modell  
 delicate pattern  
 modèle délicat  
 modelo delicado  
 modello delicato

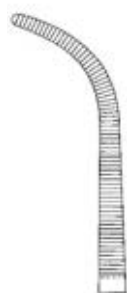

**12.428.10**  
 21,5 cm/8½"



**12.428.11**  
 21 cm/8¼"

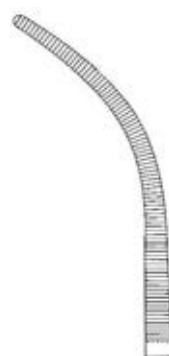

**12.428.12**  
 22 cm/8¾"



**12.428.13**  
 22,5 cm/9"



**12.428.16**  
 22,5 cm/9"



### Arterienklemmen

Hemostatic forceps  
Pincés hémostatiques  
Pinzas hemostáticas  
Pinze emostatiche



OVERHOLT

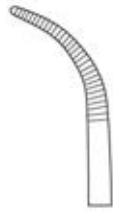

12.429.01  
18,5 cm/7¼"

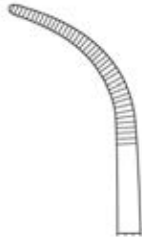

12.429.02  
20,5 cm/8"

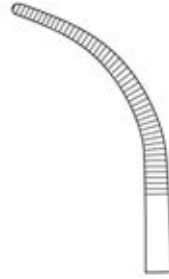

12.429.03  
21,0 cm/8¼"

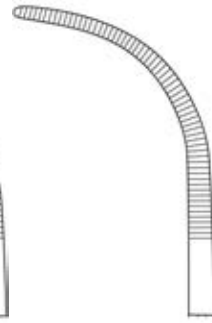

12.429.04  
21,5 cm/8½"

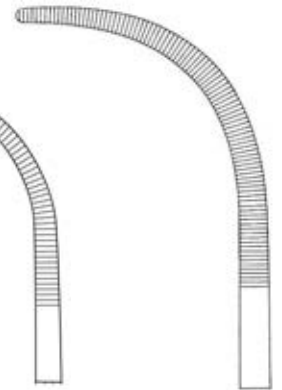

12.429.05  
24 cm/9½"

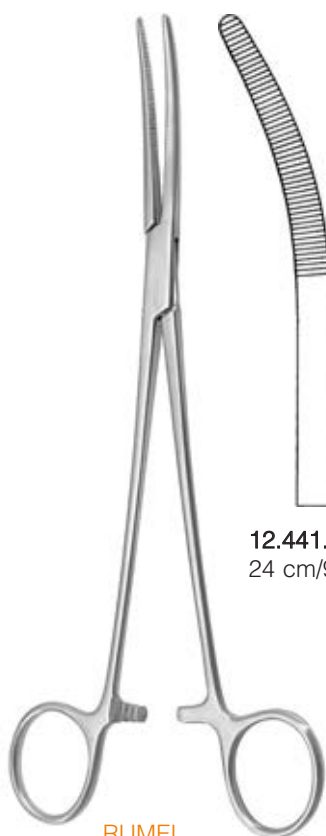

RUMEL

12.441.00  
24 cm/9½"

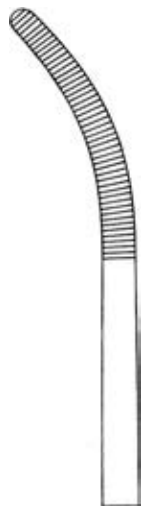

12.441.01  
24 cm/9½"



12.441.02  
23,5 cm/9¼"



12.441.03  
24 cm/9½"

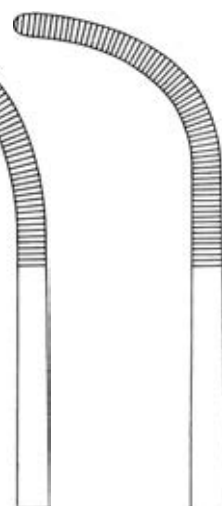

12.441.04  
24 cm/9½"



VANDERBILT  
12.447.21  
21,5 cm/8½"



12.448.22  
 22 cm/8¾"

12.449.22  
 22 cm/8¾"

ROBERTS



12.452.22

12.452.23

12.452.24

CRAFOORD SELLORS  
 24 cm/9½"



12.450.24

12.451.24

SAROT  
 24 cm/9½"

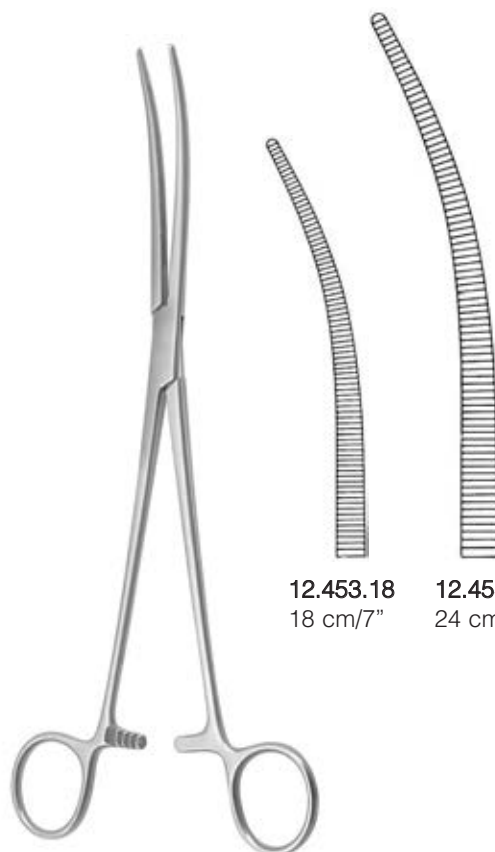

12.453.18  
 18 cm/7"

12.453.24  
 24 cm/9½"

CRAFOORD



### Arterienklemmen

Hemostatic forceps  
Pinces hémostatiques  
Pinzas hemostáticas  
Pinze emostatiche



12.455.01

12.455.02



**ZENKER**  
29,5 cm/12"



**MEEKER**

18 cm/7"	12.459.18
23 cm/9"	12.459.23
28 cm/11"	12.459.28

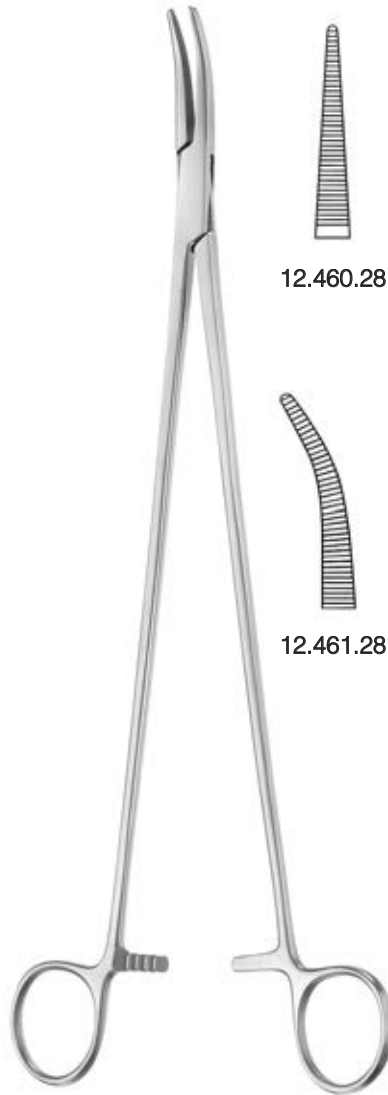

12.460.28

12.461.28

**BRIDGE**  
28 cm/11"



**LAWRENCE**  
12.457.28  
28 cm/11"



**KANTROWITZ**

19 cm/7½"	<b>12.461.19</b>
24 cm/9½"	<b>12.461.24</b>
26 cm/10¼"	<b>12.461.26</b>



**KELLY**



**12.463.19**  
 19,5 cm/7¾"  
 Fig. 1



**12.463.22**  
 22,5 cm/8¾"  
 Fig. 1



**12.463.24**  
 24,5 cm/9¾"  
 Fig. 1



**12.465.19**  
 19 cm/7½"  
 Fig. 2



**12.465.22**  
 22 cm/8¾"  
 Fig. 2

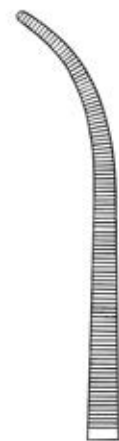

**12.465.24**  
 24 cm/9½"  
 Fig. 2



**12.467.19**  
 18,5 cm/7¼"  
 Fig. 3



**12.467.22**  
 21,5 cm/8½"  
 Fig. 3



**12.467.24**  
 23,5 cm/9¼"  
 Fig. 3



### Arterienklemmen

Hemostatic forceps  
Pincas hémostatiques  
Pinzas hemostáticas  
Pinze emostatiche



#### MIXTER

14 cm/5½"	12.471.14
16 cm/6¼"	12.471.16
18 cm/7"	12.471.18
23 cm/9"	12.471.23



MIXTER  
12.473.22  
22 cm/8¾"



MIXTER  
12.473.23  
23 cm/9"

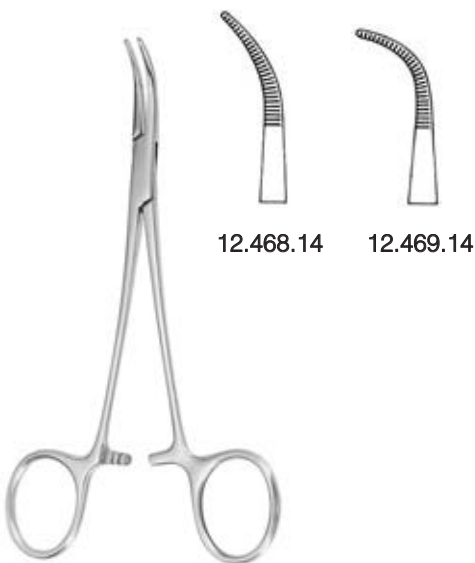

Baby MIXTER  
14 cm/5½"

12.468.14

12.469.14



MIXTER Baby  
12.475.14  
14 cm/5½"



MIXTER Baby  
12.475.18  
18 cm/7"



**MIXTER-O'SHAUGHNESSY**  
 15,5 cm/6"    12.477.15  
 19,0 cm/7½"    12.477.19



**MIXTER**

**12.479.18**  
 18 cm/7"

**12.479.22**  
 22 cm/8¾"

**12.479.25**  
 25 cm/9¾"

**12.479.28**  
 28 cm/11"



**OVERHOLT-MIXTER**  
 12.476.21  
 21 cm/8¼"



**12.478.21**  
 21 cm/8¼"

**12.478.24**  
 24 cm/9½"



**McQUIGG-MIXTER**  
 12.489.22  
 22 cm/8¾"



**Peritoneumklemmen**  
 Peritoneal clamp forceps  
 Pincés à peritoine  
 Pinzas para peritoneo  
 Pinze per peritoneo

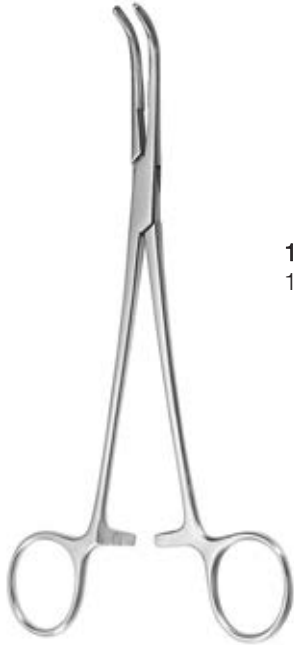

LAHEY



**12.491.19**  
19 cm/7½"

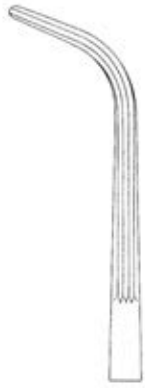

**12.493.23**  
23 cm/9"

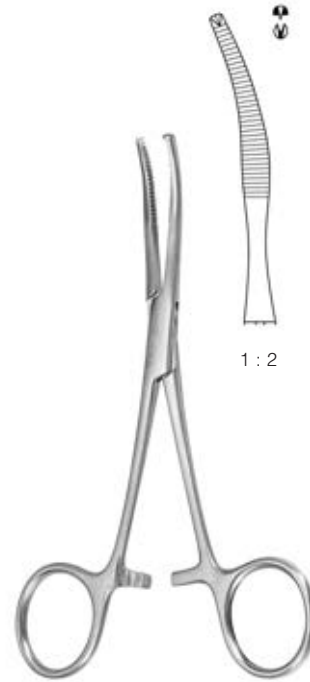

MIKULICZ-Baby  
**12.550.14**  
14 cm/5½"



1 : 2



MIKULICZ



1 : 2

**12.550.20**  
20 cm/8"



1 : 2

**12.550.21**  
20,5 cm/8"



1 : 2

**12.553.18**  
18 cm/7"



1 : 2

**12.553.20**  
20 cm/8"



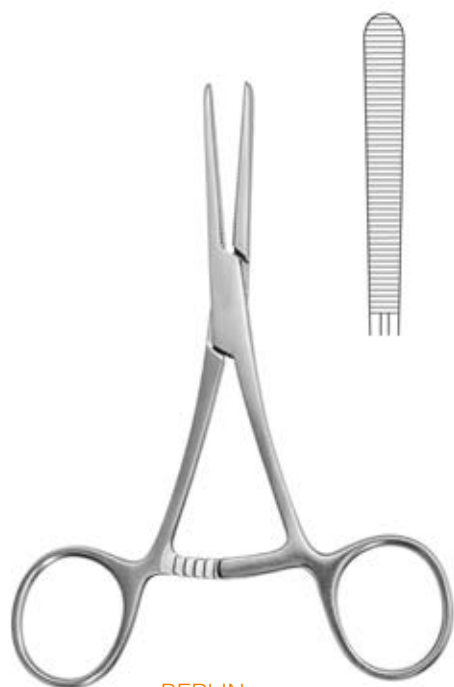

**BERLIN**  
 12.702.14  
 14,5 cm/5¾"

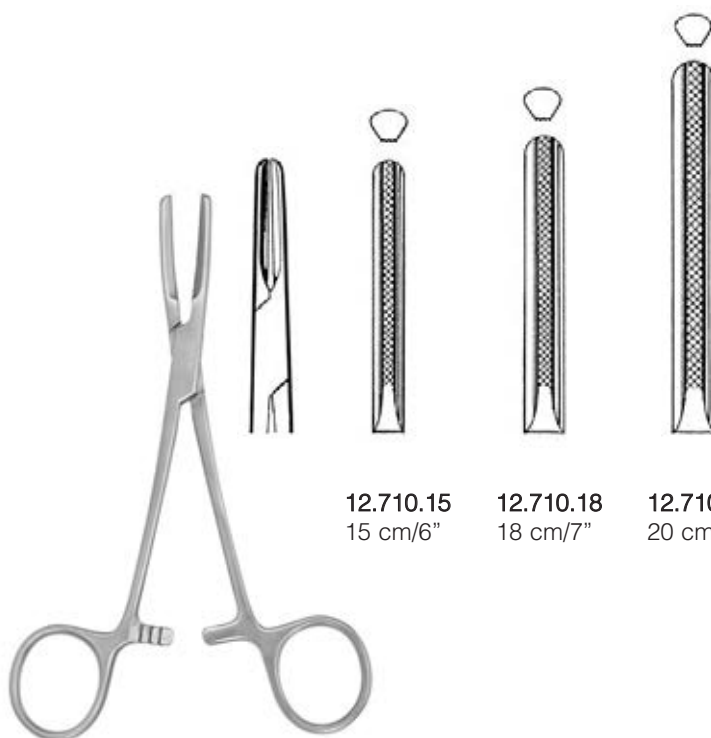

12.710.15  
 15 cm/6"

12.710.18  
 18 cm/7"

12.710.20  
 20 cm/8"



**PRESBYTERIAN HOSPITAL**  
 16 cm/6¼"    12.704.16  
 18 cm/7"    12.704.18

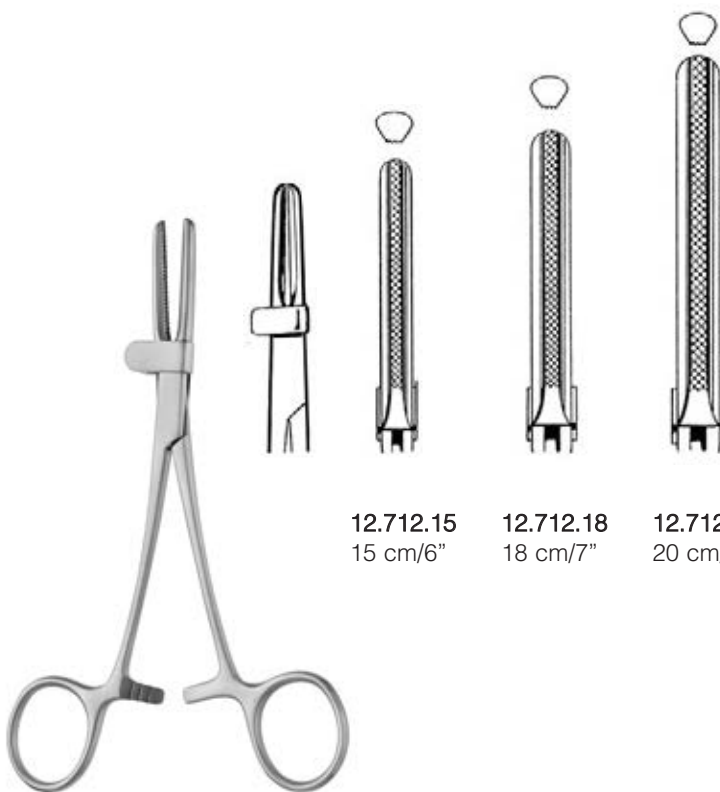

12.712.15  
 15 cm/6"

12.712.18  
 18 cm/7"

12.712.20  
 20 cm/8"



**Rollenklemmen**  
Tube milking rollers  
Pince à rouleaux  
Pinzas con rodillo  
Pinze con rotoli



**GUNNER-HEY**  
**12.722.18**  
18,5 cm/7¼"



**BROMPTON**  
**12.724.15**  
15 cm/6"



**ATRAUMA**



DE BAKEY



HALSTED-MOSQUITO



13.080.12  
12 cm/4¾"



13.081.12  
12 cm/4¾"



13.080.15  
15 cm/6"



13.081.15  
15 cm/6"



PEAN



13.082.14  
14 cm/5½"



13.082.16  
16 cm/6¼"



13.082.18  
18 cm/7"



13.082.20  
20 cm/8"



13.083.14  
14 cm/5½"



13.083.16  
16 cm/6¼"



13.083.18  
18 cm/7"



13.083.20  
20 cm/8"



**Atraumatische Gefäßklemmen**  
 Atraumatic vascular clamps  
 Pincés vasculaires atraumatiques  
 Pinzas vasculares atraumáticas  
 Pinze vascolari atraumatiche

**ATRAUMA**



DE BAKEY



13.084.16



13.085.16

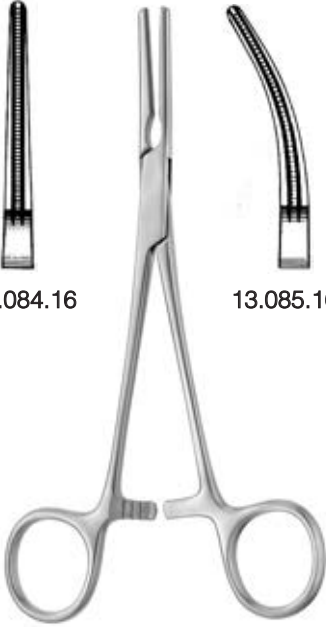

**RANKIN**  
 16 cm/6¼"



13.101.40  
 23 cm/9"

40 mm



13.101.50  
 23,5 cm/9¼"

50 mm



**HOPT**



13.101.60  
 24,5 cm/9¾"

60 mm



**ATRAUMA**



DE BAKEY

Bulldogklemmen mit Ringgriff  
 Ring Bulldog clamps  
 Clamps Bulldog, manche à anneau  
 Clamps Bulldog con mango de anillo  
 Pinze Bulldog con manico di anello

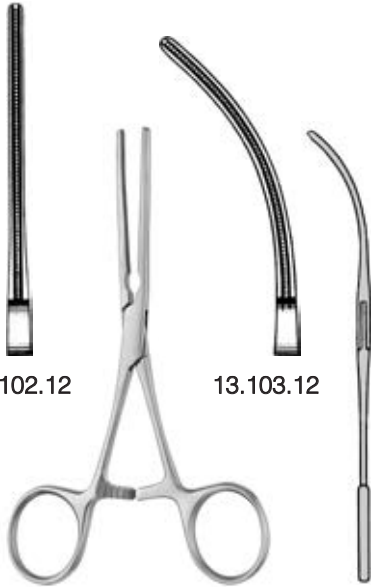

13.102.12

13.103.12

DE BAKEY  
 12 cm/4¾"



DE BAKEY  
 13.111.12  
 12 cm/4¾"



DE BAKEY  
 13.113.12  
 10 cm/4"



DE BAKEY  
 13.121.12  
 12 cm/4¾"



**Atraumatische Gefäßklemmen**  
Atraumatic vascular clamps  
Pincés vasculaires atraumatiques  
Pinzas vasculares atraumáticas  
Pinze vascolari atraumatiche

**ATRAUMA**



DE BAKEY

Bronchusklemmen  
Bronchus forceps  
Pincés pour bronches  
Pinzas bronquiales  
Pinze per bronchi



LEES



13.131.23  
23 cm/9"

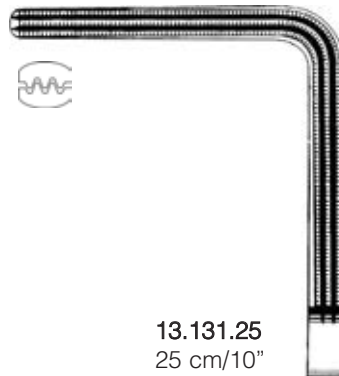

13.131.25  
25 cm/10"



13.133.25  
25 cm/10"



Coarctationsklemmen  
 Coarctation clamps  
 Pinces pour coarctation  
 Pinzas para coarctación  
 Pinze per coartazione

**ATRAUMA**



DE BAKEY



POTTS

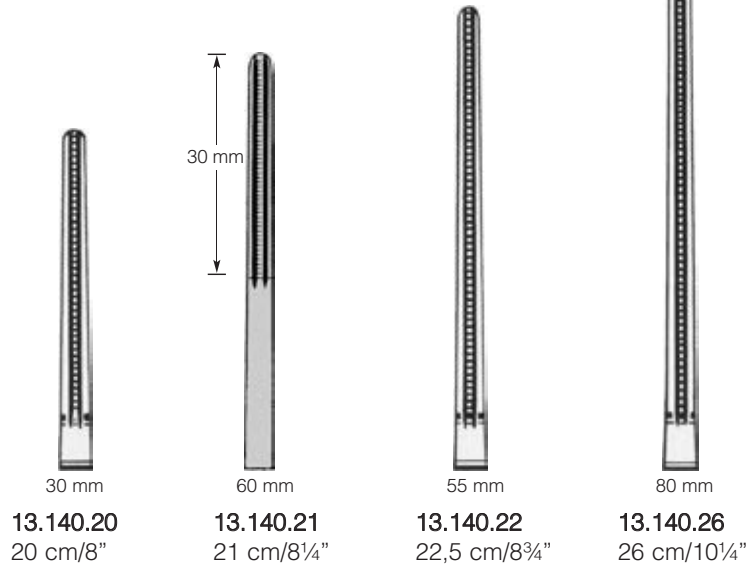

POTTS

15°





**Atraumatische Gefäßklemmen**  
 Atraumatic vascular clamps  
 Pincés vasculaires atraumatiques  
 Pinzas vasculares atraumáticas  
 Pinze vascolari atraumatiche

**ATRAUMA**



DE BAKEY



POTTS

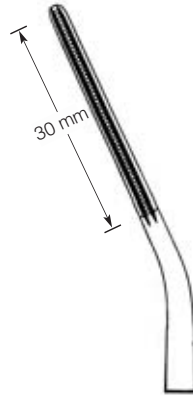

60 mm  
**13.142.21**  
 21 cm/8<sup>1</sup>/<sub>4</sub>"



60 mm  
**13.142.22**  
 22 cm/8<sup>3</sup>/<sub>4</sub>"



Coarctationsklemmen  
 Coarctation clamps  
 Pincés pour coarctation  
 Pinzas para coarctación  
 Pinze per coartazione



POTTS

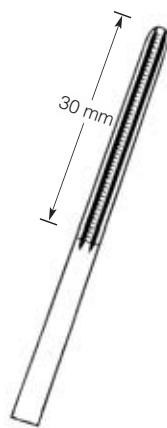

60 mm  
**13.143.21**  
 21 cm/8<sup>1</sup>/<sub>4</sub>"



60 mm  
**13.143.22**  
 22 cm/8<sup>3</sup>/<sub>4</sub>"







**ATRAUMA**



DE BAKEY

Anastomoseklemmen  
Anastomosis clamps  
Pinces à anastomose  
Pinzas para anastomosis  
Pinze per anastomosi



GLOVER



**13.151.21**  
21 cm/8¼"



**13.151.24**  
24 cm/9½"



GLOVER



**13.153.18**  
18 cm/7"

**13.153.22**  
22 cm/8¾"



**Atraumatische Gefäßklemmen**  
Atraumatic vascular clamps  
Pincés vasculaires atraumatiques  
Pinzas vasculares atraumáticas  
Pinze vascolari atraumatiche

**ATRAUMA**



DE BAKEY

Anastomoseklemmen  
Anastomosis clamps  
Pincés à anastomose  
Pinzas para anastomosis  
Pinze per anastomosi



**GLOVER**  
**13.161.21**  
21 cm/8¼"



**GLOVER**  
**13.161.26**  
26 cm/10¼"



Peripheral-Gefäßklemmen  
 Peripheral vascular clamps  
 Pincès vasculaires périphériques  
 Pinzas para vasos periféricos  
 Pinze vascolari per vasi periferici

**ATRAUMA**



DE BAKEY



DE BAKEY



**13.170.19**  
 19,5 cm/7½"



**13.170.22**  
 22 cm/8¾"



DE BAKEY



**13.171.19**  
 19,5 cm/7½"



**13.171.22**  
 22 cm/8¾"



**Atraumatische Gefäßklemmen**  
 Atraumatic vascular clamps  
 Pincés vasculaires atraumatiques  
 Pinzas vasculares atraumáticas  
 Pinze vascolari atraumatiche

**ATRAUMA**



DE BAKEY

Atraumatische Mehrzweckklemmen  
 Atraumatic multi-purpose clamps  
 Pincés polyvalentes  
 Pinzas clamps para multiuso  
 Pinze atraumatiche per multiuso



**DARDIK**

30 mm	30 mm	30 mm	30 mm	30 mm
0°	15°	30°	45°	90°
<b>13.172.00</b>	<b>13.172.15</b>	<b>13.172.30</b>	<b>13.172.45</b>	<b>13.172.90</b>
16 cm/6¼"	15,5 cm/6"	15 cm/6"	14,5 cm/5¾"	13 cm/5"

50 mm	50 mm	50 mm	50 mm	50 mm
0°	15°	30°	45°	90°
<b>13.174.00</b>	<b>13.174.15</b>	<b>13.174.30</b>	<b>13.174.45</b>	<b>13.174.90</b>
17 cm/6¾"	16,5 cm/6½"	16 cm/6¼"	16 cm/6¼"	13,5 cm/5¼"



Peripheral-Gefäßklemmen  
 Peripheral vascular clamps  
 Pincès vasculaires périphériques  
 Pinzas para vasos periféricos  
 Pinze vascolari per vasi periferici

**ATRAUMA**



DE BAKEY



**LELAND-JONES**  
**13.181.19**  
 19 cm/7½"



**DE BAKEY**  
**13.181.26**  
 26,5 cm/10½"



**DE BAKEY**



**13.183.19**  
 19 cm/7½"



**13.183.20**  
 20 cm/8"



**13.191.16**  
 16 cm/6¼"



**Atraumatische Gefäßklemmen**  
 Atraumatic vascular clamps  
 Pincès vasculaires atraumatiques  
 Pinzas vasculares atraumáticas  
 Pinze vascolari atraumatiche

**ATRAUMA**



DE BAKEY



BAINBRIDGE

13.196.15  
15 cm/6"



13.196.18  
18,5 cm/7¼"



13.197.15  
15 cm/6"



13.197.18  
18,5 cm/7¼"



Atraumatische Mehrzweckklemmen  
 Atraumatic multi-purpose Clamps  
 Pincès polyvalentes  
 Pinzas clamps para multiuso  
 Pinze atraumatiche per multiuso



LELAND-JONES

13.202.19  
19,5 cm/7¾"

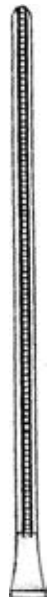

13.203.19  
19 cm/7½"

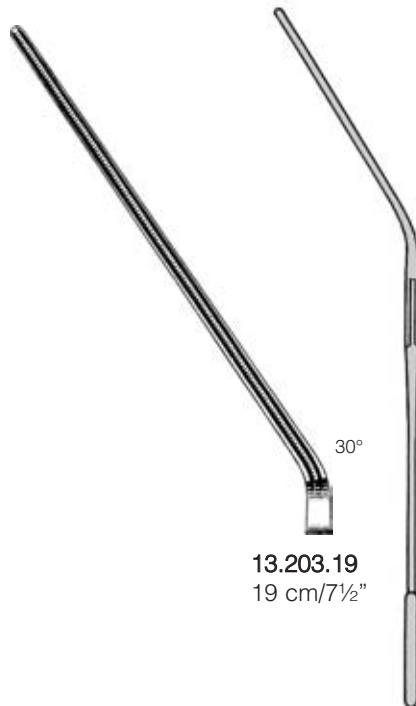

30°

13.205.19  
19 cm/7½"



15°



**LIDDLE**  
 13.209.27  
 27 cm/10½"

Aortaklemmen  
 Aortic clamp  
 Pince pour l'aorte  
 Pinza clamp para aorta  
 Pinza per aorta

**ATRAUMA**



DE BAKEY



**LAMBERT-KAY**  
 20 cm/8"

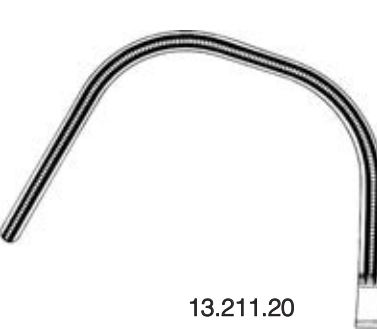

13.211.20



13.213.20

Aorta-Anastomoseklemmen  
 Aorta-Anastomosis clamps  
 Pinces à anastomoses d'aorte  
 Pinzas para anastomosis de aorta  
 Pinze aortiche



**Atraumatische Gefäßklemmen**  
Atraumatic vascular clamps  
Pincés vasculaires atraumatiques  
Pinzas vasculares atraumáticas  
Pinze vascolari atraumatiche

**ATRAUMA**



DE BAKEY

Iliaca-Klemme  
Iliac clamp  
Pince pour veine iliaque  
Pinza para iliaca  
Pinza per iliaca



**DE BAKEY**  
**13.215.20**  
20 cm/8"





**ATRAUMA**



DE BAKEY



links gebogen  
curved to left  
courbe à gauche  
curvada a la izquierda  
curva a sinistra



rechts gebogen  
curved to right  
courbe à droite  
curvada a la derecha  
curva a destra

Aortaklemmen  
Aortic clamp  
Pince-clamp à aorte  
Pinza para aorta  
Pinza per aorta



**WEBER**  
**13.217.26**  
26 cm/10¼"



**WEBER**  
**13.219.26**  
26 cm/10¼"



**Atraumatische Gefäßklemmen**  
 Atraumatic vascular clamps  
 Pinces vasculaires atraumatiques  
 Pinzas vasculares atraumáticas  
 Pinze vascolari atraumatiche

**ATRAUMA**



DE BAKEY

Aorta-Aneurysma-Klemmen  
 Aorta-Aneurysm clamps  
 Pinces pour anévrisme de l'aorte  
 Pinzas para aneurisma de aorta  
 Pinze per aneurisma di aorta

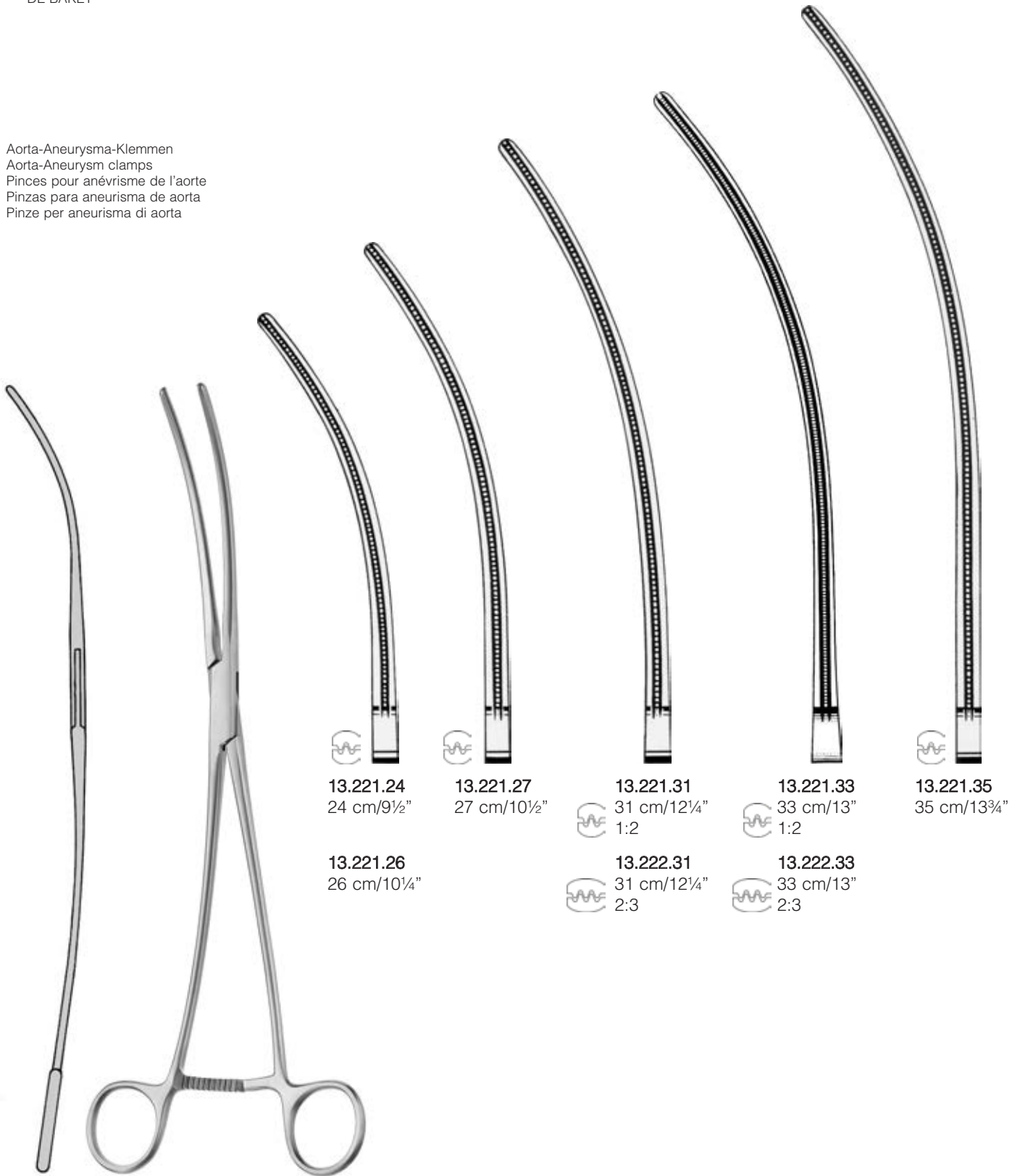

**13.221.24**  
 24 cm/9½"



**13.221.27**  
 27 cm/10½"



**13.221.31**  
 31 cm/12¼"  
 1:2



**13.221.33**  
 33 cm/13"  
 1:2



**13.221.35**  
 35 cm/13¾"



**13.221.26**  
 26 cm/10¼"



**13.222.31**  
 31 cm/12¼"  
 2:3



**13.222.33**  
 33 cm/13"  
 2:3

DE BAKEY



**ATRAUMA**



DE BAKEY

Aorta-Aneurysma-Klemmen  
Aorta-Aneurysm clamps  
Pinces pour anévrisme de l'aorte  
Pinzas para aneurisma de aorta  
Pinze per aneurisma di aorta

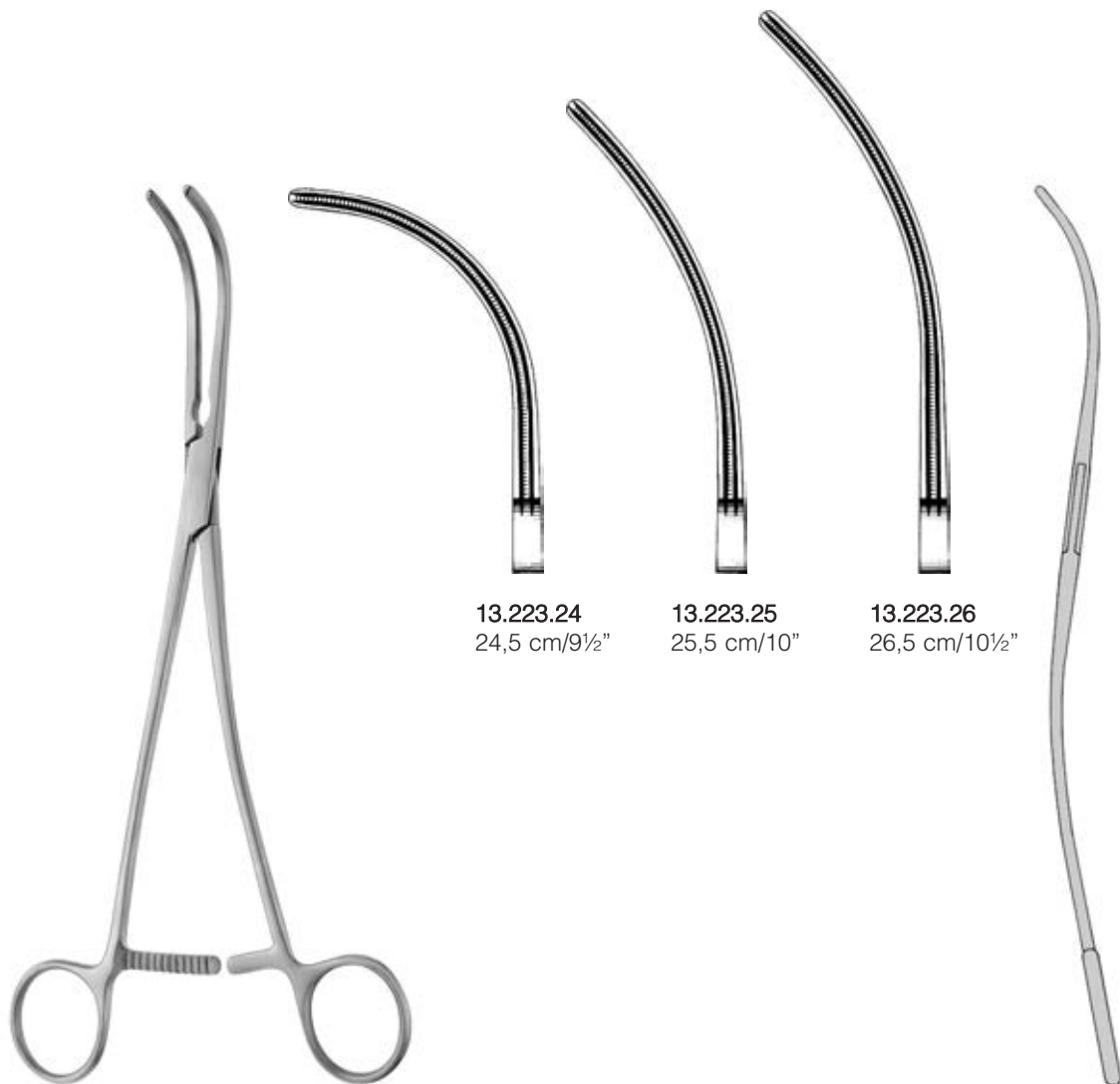

**13.223.24**  
24,5 cm/9½"

**13.223.25**  
25,5 cm/10"

**13.223.26**  
26,5 cm/10½"

DE BAKEY-BAHNSON



**Atraumatische Gefäßklemmen**  
Atraumatic vascular clamps  
Pincés vasculaires atraumatiques  
Pinzas vasculares atraumáticas  
Pinze vascolari atraumatiche

**ATRAUMA**



DE BAKEY

Aorta-Aneurysma-Klemmen  
Aorta-Aneurysm clamps  
Pincés pour anévrisme de l'aorte  
Pinzas para aneurisma de aorta  
Pinze per aneurisma di aorta



**DE BAKEY**  
**13.225.28**  
28 cm/11"

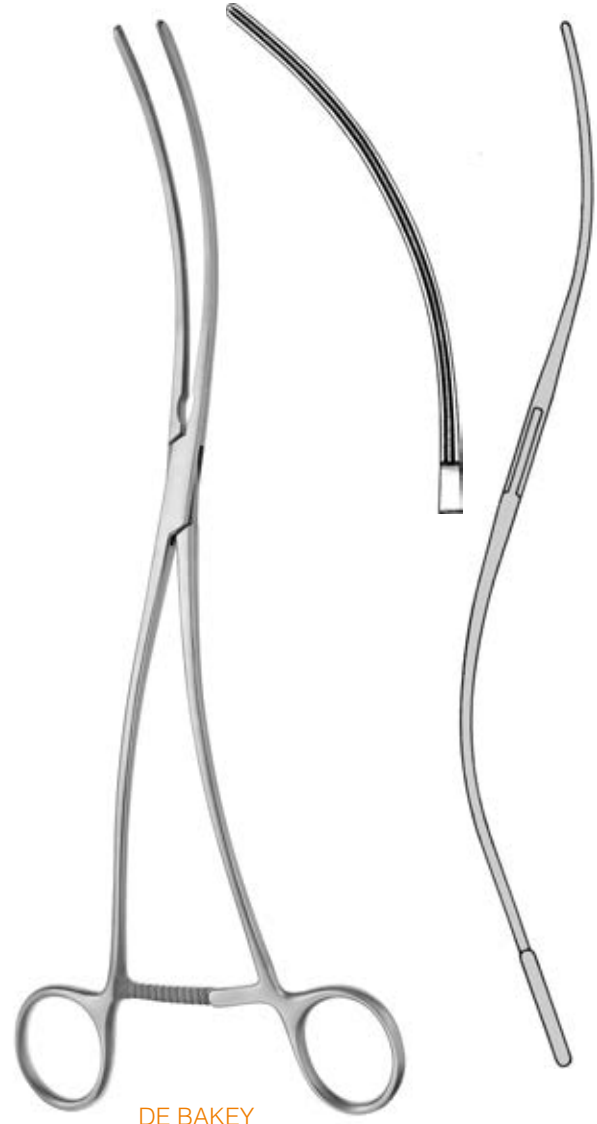

**DE BAKEY**  
**13.227.28**  
30 cm/12"



Aorta-Aneurysma-Klemmen  
Aorta-Aneurysm clamps  
Pinces pour anévrisme de l'aorte  
Pinzas para aneurisma de aorta  
Pinze per aneurisma di aorta

**ATRAUMA**



DE BAKEY

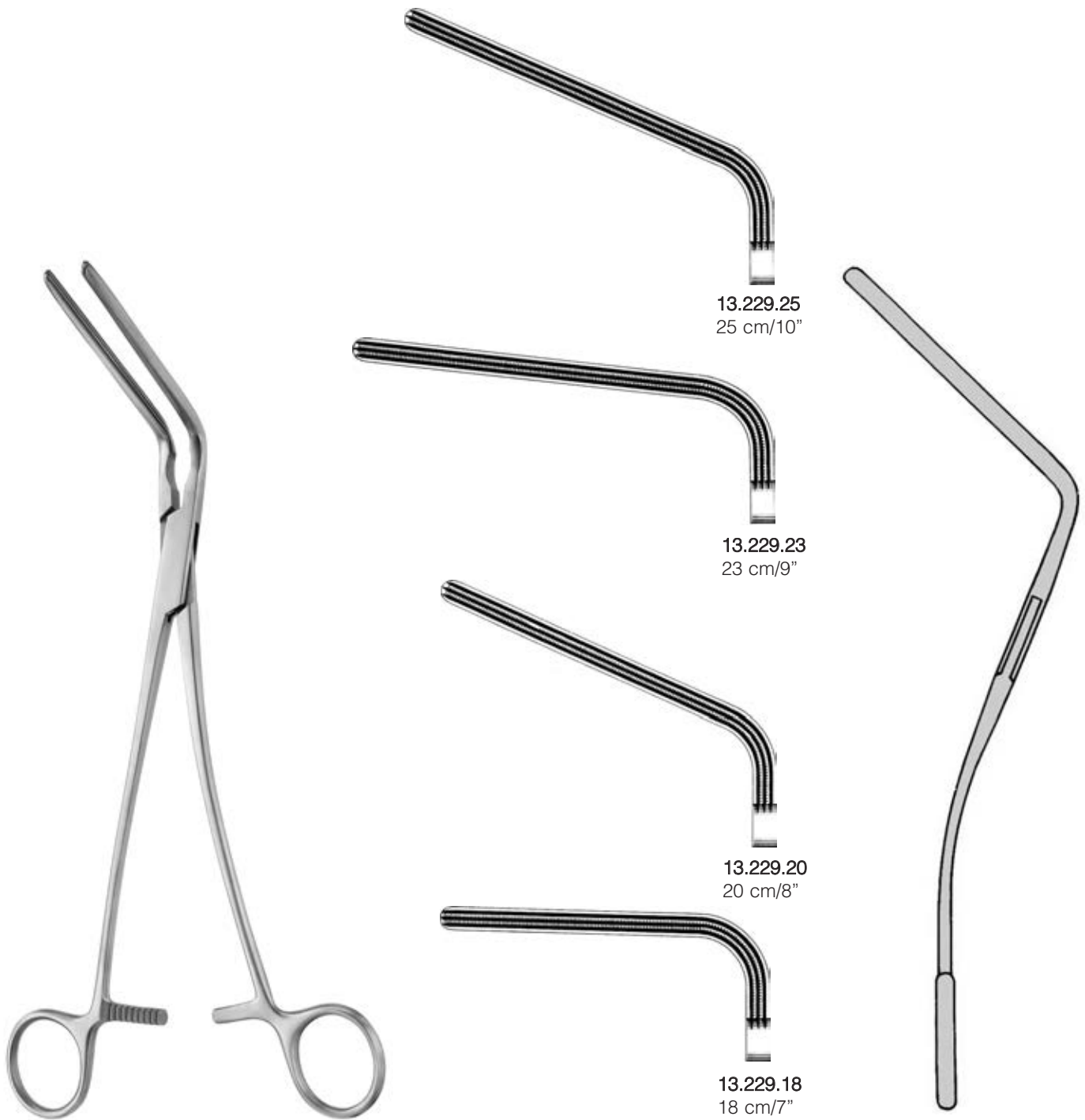

DE BAKEY-MORRIS



**Atraumatische Gefäßklemmen**  
Atraumatic vascular clamps  
Pincès vasculaires atraumatiques  
Pinzas vasculares atraumáticas  
Pinze vascolari atraumatiche

**ATRAUMA**



DE BAKEY

Atraumatische Mehrzweckklemmen  
Atraumatic multi-purpose clamps  
Pincès polyvalents  
Pinzas para multiuso  
Pinze atraumatiche per multiuso



DE BAKEY



90°

**13.231.18**  
19 cm/7½"



**13.231.21**  
21,5 cm/8½"



**13.231.23**  
23 cm/9"

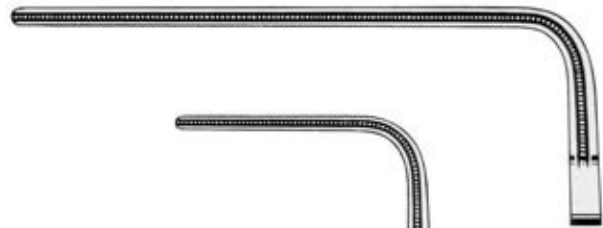

**13.231.27**  
27 cm/10¾"



Aorta-Aneurysma-Klemmen  
Aorta-Aneurysm clamps  
Pinces pour anévrisme de l'aorte  
Pinzas para aneurisma de aorta  
Pinze per aneurisma di aorta

**ATRAUMA**



DE BAKEY

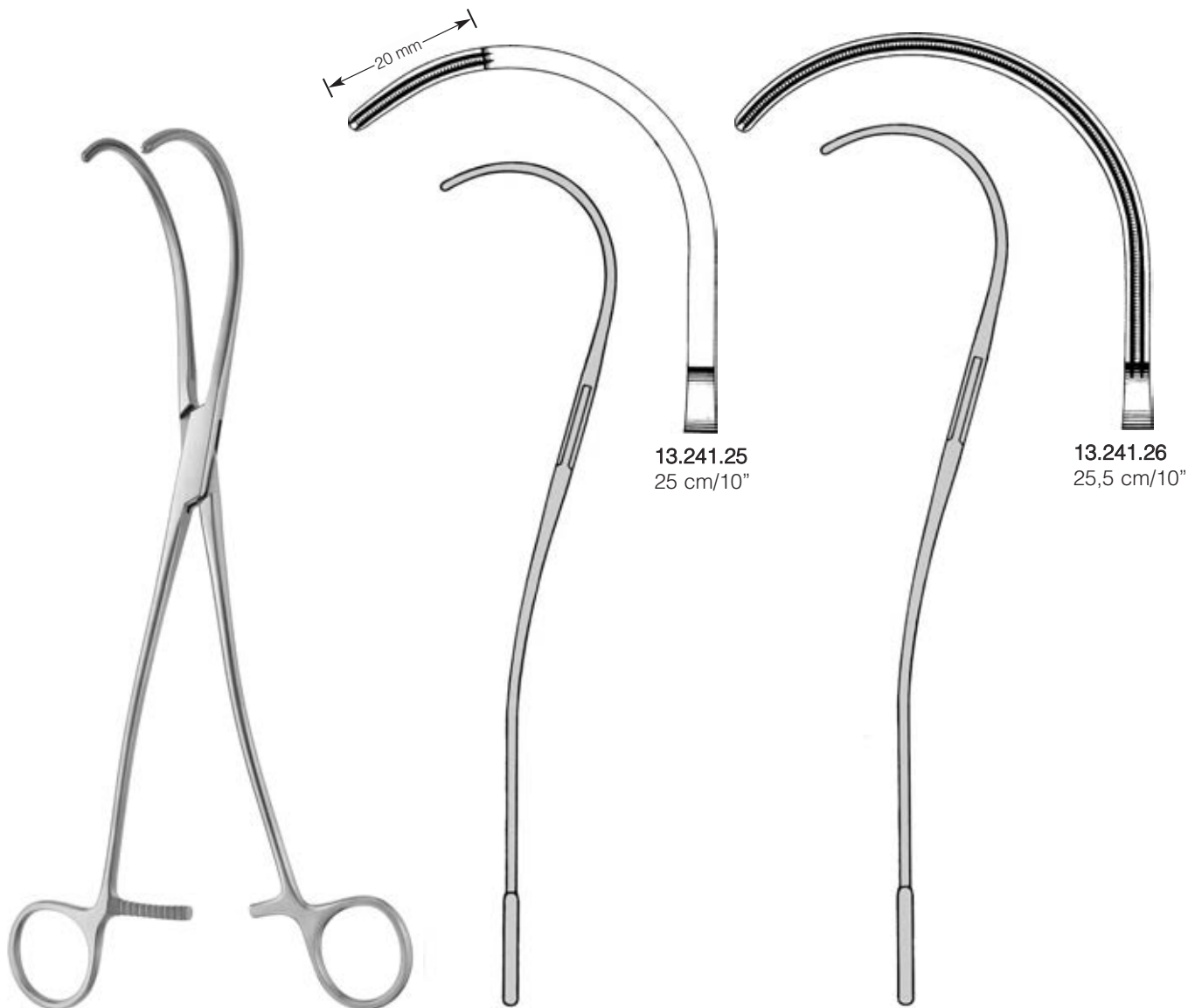

DE BAKEY-SEMB



**Atraumatische Gefäßklemmen**  
Atraumatic vascular clamps  
Pincés vasculaires atraumatiques  
Pinzas vasculares atraumáticas  
Pinze vascolari atraumatiche

**ATRAUMA**



DE BAKEY

Aorta-Aneurysma-Klemmen  
Aorta-Aneurysm clamps  
Pincés pour anévrisme de l'aorte  
Pinzas para aneurisma de aorta  
Pinze per aneurisma di aorta



DE BAKEY  
13.247.27  
27 cm/10½"





Atraumatische Mehrzweckklemmen  
 Atraumatic multi-purpose clamps  
 Pinces polyvalentes  
 Pinzas para multiuso  
 Pinze atraumatiche per multiuso

**ATRAUMA**



DE BAKEY

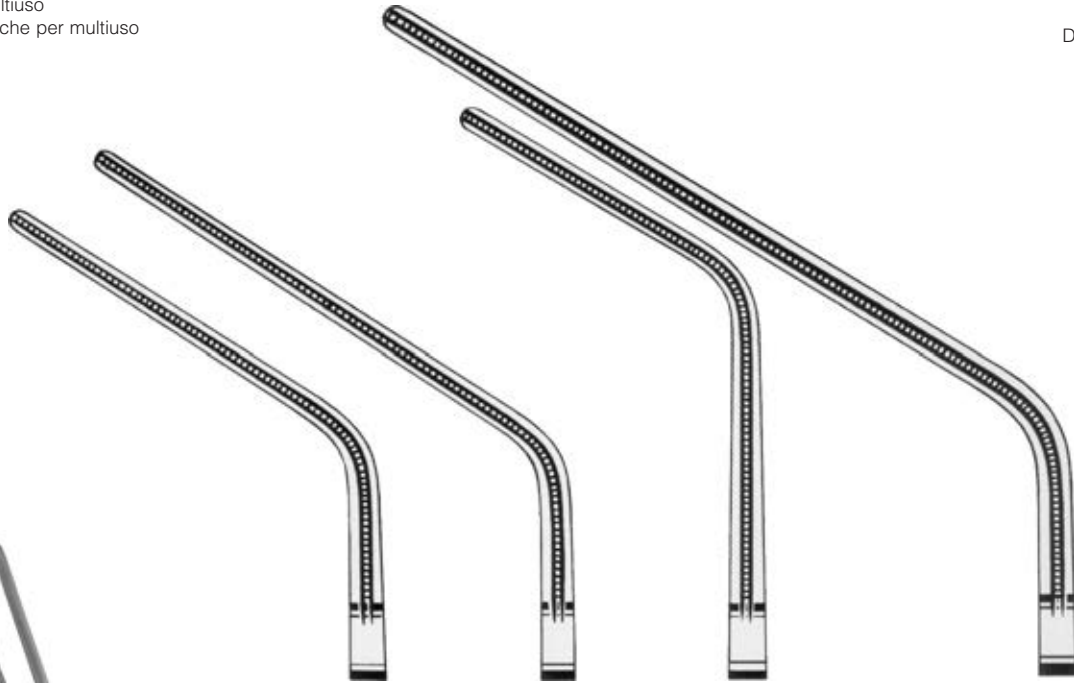

**13.251.20**  
20,5 cm/8"

**13.251.24**  
24 cm/9½"

**13.251.25**  
25 cm/10"

**13.251.30**  
30 cm/12"



DE BAKEY



60°



**Atraumatische Gefäßklemmen**  
 Atraumatic vascular clamps  
 Pincés vasculaires atraumatiques  
 Pinzas vasculares atraumáticas  
 Pinze vascolari atraumatiche

**ATRAUMA**



DE BAKEY

Tangentialklemmen  
 Tangential occlusion clamps  
 Pincés pour occlusion tangentielle  
 Pinzas para oclusión tangencial  
 Pinze per occlusione tangenziale



SATINSKY

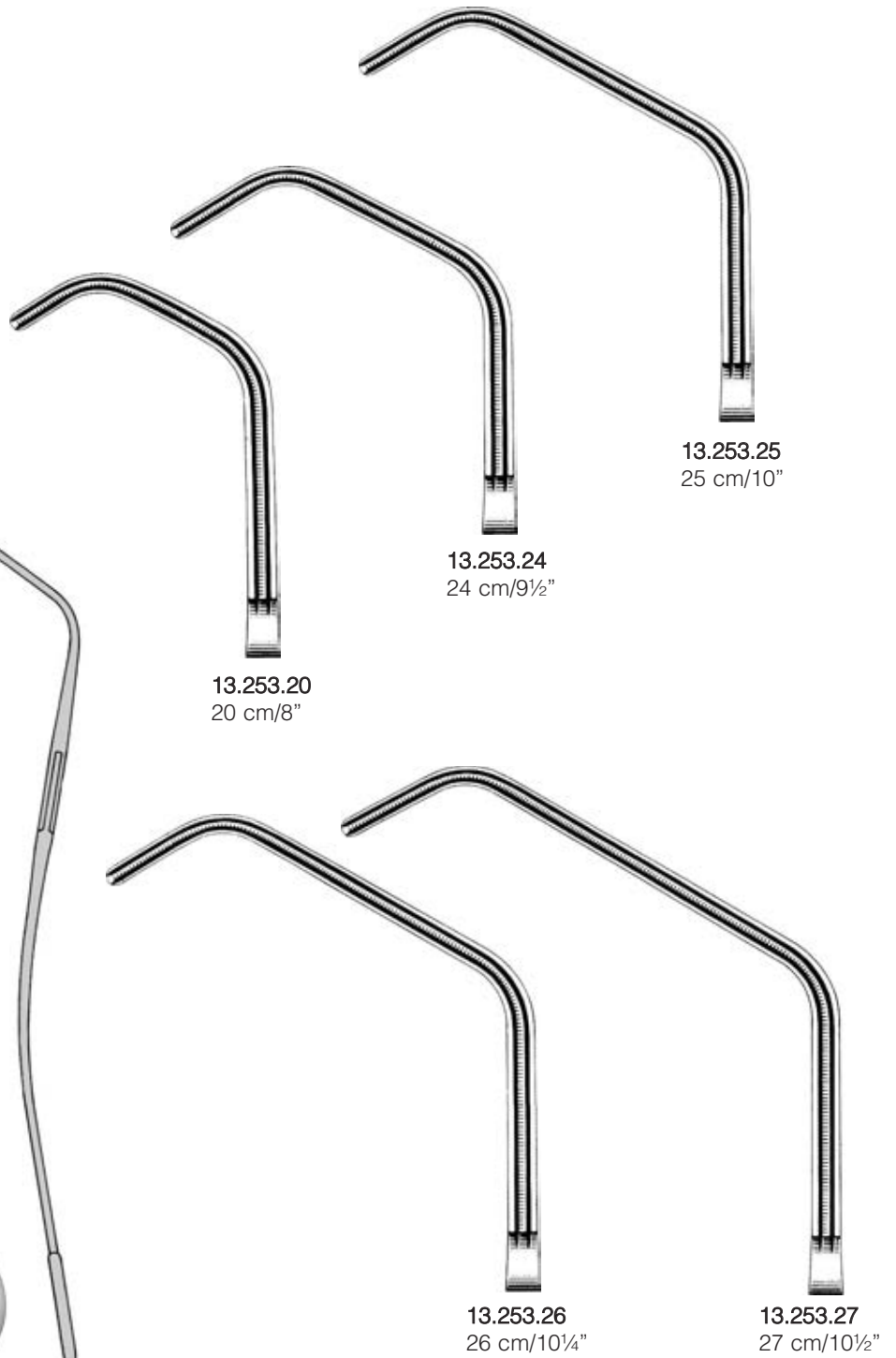



**ATRAUMA**



DE BAKEY

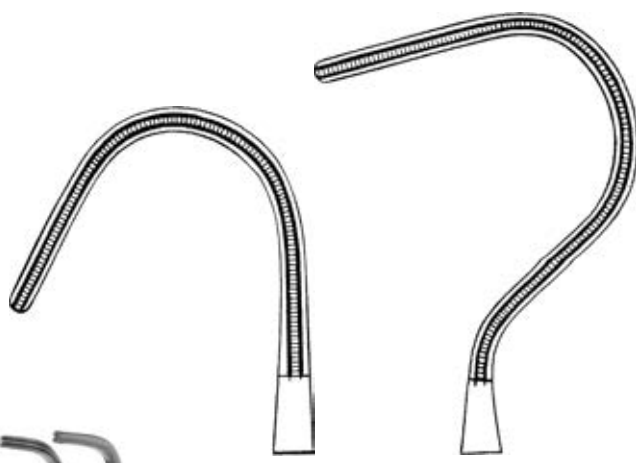

**13.259.01**  
21 cm/8¼"

**13.259.02**  
22 cm/8¾"



**WYLIE**

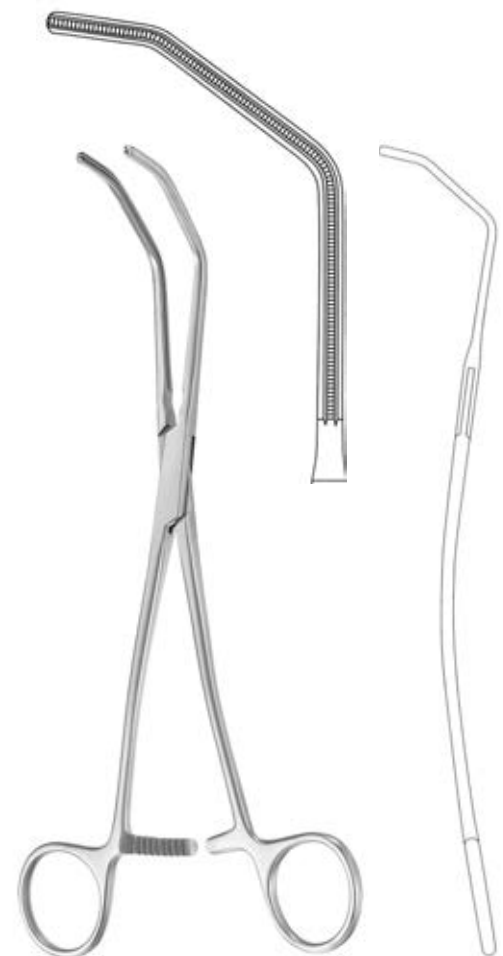

**GLOVER-DE BAKEY**  
**13.260.23**  
23 cm/9"



**Gefäßklemmen für auswechselbare Mauleinsätze**

Vessel clamps for interchangeable jaw inserts  
Pincas vasculaires pour mors interchangeables  
Pinzas vasculares para bocas intercambiables  
Pinze vascolari atraumatiche con placche intercambiabili

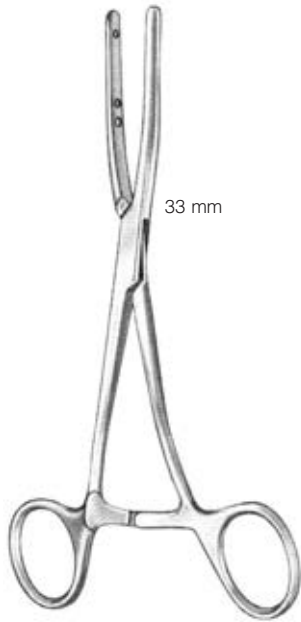

33 mm

**FOGARTY**  
**13.257.01**  
16,5 cm/6½"



61 mm

**FOGARTY**  
**13.257.04**  
29 cm/11½"



61 mm

**FOGARTY**  
**13.257.05**  
22 cm/8¾"

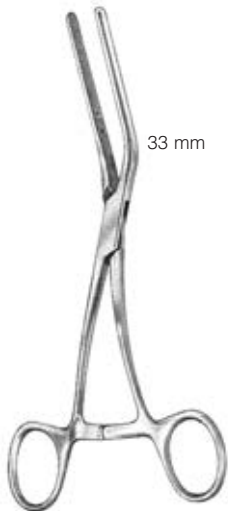

33 mm

**FOGARTY**  
**13.257.02**  
12 cm/4¾"



61 mm

**FOGARTY**  
**13.257.06**  
21,5 cm/8½"



86 mm

**FOGARTY**  
**13.257.07**  
23,5 cm/9¼"

## Einsätze für Gefäßklemmen

Interchangeable jaw inserts for vessel clamps  
Mors interchangeables pour pinces vasculaires  
Bocas intercambiables para pinzas vasculares  
Placche di ricambio per pinze vascolari atraumatiche



Anlegezange für Clips  
Applying forceps for clips  
Applicateur pour clips  
Pinza para aplicar clips  
Applicatore per clips



**EDWARDS**  
13.258.00  
18,5 cm/7¼"



**EDWARDS Clips**  
6 mm 13.258.06  
12 mm 13.258.12



**Atraumatische Gefäßklemmen**  
Atraumatic vascular clamps  
Pinces vasculaires atraumatiques  
Pinzas vasculares atraumáticas  
Pinze vascolari atraumatiche

**ATRAUMA**



DE BAKEY

Tangentialklemmen  
Tangential occlusion clamps  
Pinces pour occlusion tangentielle  
Pinzas para oclusión tangencial  
Pinze per occlusione tangenziale

für die Vena cava  
for vena cava  
pour vena cava  
para la vena cava  
per la vena cava



DE BAKEY-SATINSKY



13.261.23  
23 cm/9"

13.261.24  
24 cm/9½"

13.261.25  
25 cm/10"



**ATRAUMA**



DE BAKEY



13.263.25



13.265.24

Aurikelklemmen  
 Auricle clamps  
 Pincès oreilletta  
 Pinzas para aurícula  
 Pinze ventricolari



**HARKEN**  
 24 cm/9½"



13.267.24



13.269.24



**Atraumatische Gefäßklemmen**  
 Atraumatic vascular clamps  
 Pincés vasculaires atraumatiques  
 Pinzas vasculares atraumáticas  
 Pinze vascolari atraumatiche

**ATRAUMA**



DE BAKEY

Organfasszange  
 Organ grasping forceps  
 Pincés pour saisir les organes  
 Pinzas para sacar órganos  
 Pinze per afferrare organi



**13.270.25**  
 25 cm/10"



**13.270.26**  
 26 cm/10¼"

Peripheral-Gefäßklemmen  
 Peripheral vascular clamps  
 Pincés vasculaires périphériques  
 Pinzas para vasos periféricos  
 Pinze vascolari per vasi periferici



**DALE**  
**13.271.18**  
 18 cm/7"

Peripheral-Gefäßklemmen  
 Peripheral vascular clamps  
 Pincés vasculaires périphériques  
 Pinzas para vasos periféricos  
 Pinze vascolari per vasi periferici



**DALE**



**13.273.17**  
 17 cm/6½"



**13.273.18**  
 18 cm/7"



**13.273.19**  
 19 cm/7¼"





Aorta-Anastomoseklemmen  
 Aorta-Anastomosis clamps  
 Pincès à anastomoses d'aorte  
 Pinzas para anastomosis de aorta  
 Pinze aortiche

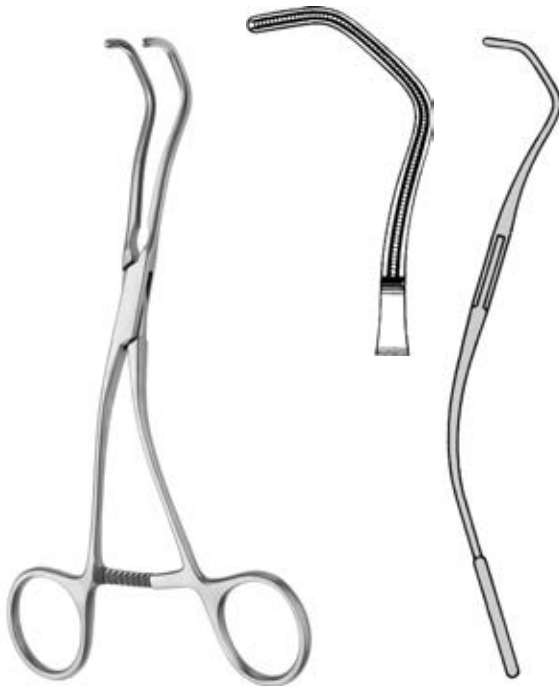

**DE BAKEY**  
**13.281.17**  
 17 cm/6¾"

Atraumatische Mehrzweckklemmen  
 Atraumatic multi-purpose clamps  
 Pincès polyvalentes  
 Pinzas para multiuso  
 Pinze atraumatiche per multiuso

**ATRAUMA**



DE BAKEY



**BECK**  
**13.283.17**  
 17 cm/6¾"

Atraumatische Mehrzweckklemmen  
 Atraumatic multi-purpose clamps  
 Pincès polyvalentes  
 Pinzas para multiuso  
 Pinze atraumatiche per multiuso



**DE BAKEY-BECK**

für die Vena cava  
 for vena cava  
 pour vena cava  
 para la vena cava  
 per la vena cava



**13.284.21**  
 21 cm/8¼"

**13.284.20**  
 20,5 cm/8"



**Atraumatische Gefäßklemmen**  
Atraumatic vascular clamps  
Pincés vasculaires atraumatiques  
Pinzas vasculares atraumáticas  
Pinze vascolari atraumatiche

**ATRAUMA**



DE BAKEY

Präparier- und Ligaturklemmen  
Dissecting and ligature clamps  
Pincés à dissection et à ligature  
Pinzas de disección y para ligaduras  
Pinze per dissezione e per legature

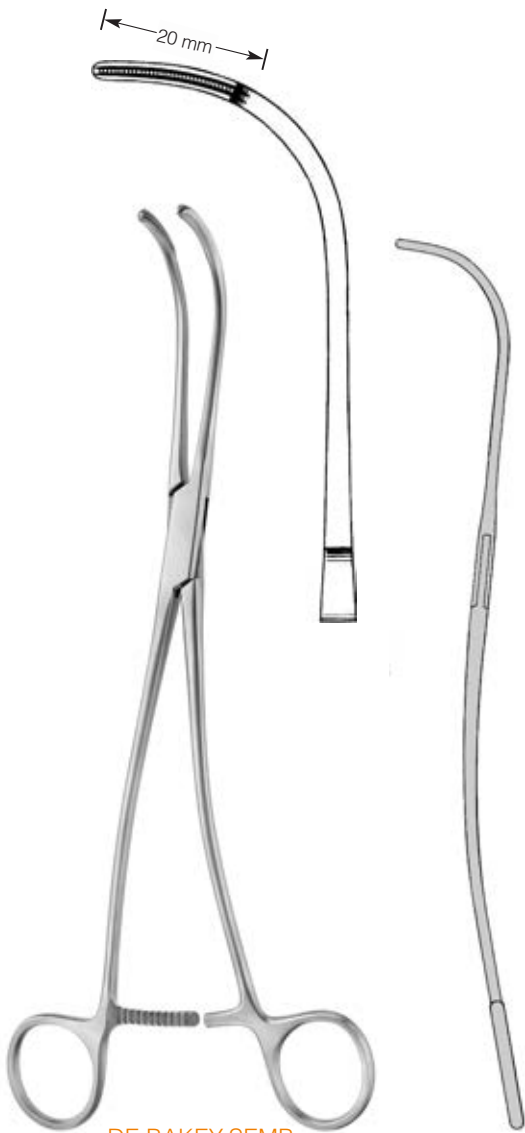

DE BAKEY-SEMB  
13.285.24  
24 cm/9½"



DE BAKEY-SEMB  
13.287.24  
24 cm/9½"



Coarctationsklemmen  
 Coarctation clamps  
 Pinces pour coarctation  
 Pinzas para coarctación  
 Pinze per coartazione

POTTS

**ATRAUMA**



DE BAKEY



13.288.21  
 21 cm/8¼"



13.288.23  
 23 cm/9"



13.288.27  
 27 cm/10½"



13.288.31  
 31 cm/12¼"



Coarctationsklemmen  
 Coarctation clamps  
 Pinces pour coarctation  
 Pinzas para coarctación  
 Pinze per coartazione

POTTS



13.289.21  
 21 cm/8¼"



13.289.23  
 23 cm/9"



13.289.27  
 27 cm/10½"



13.289.31  
 31 cm/12¼"



**Atraumatische Gefäßklemmen**  
 Atraumatic vascular clamps  
 Pincès vasculaires atraumatiques  
 Pinzas vasculares atraumáticas  
 Pinze vascolari atraumatiche

**ATRAUMA**



DE BAKEY

Anastomoseklemmen, Kindergrößen  
 Anastomosis clamps, pediatric  
 Pincès à anastomose, pédiatrique  
 Pinzas para anastomosis, pediátricas  
 Pinze per anastomosi, pediatriche



DERRA



13.291.16  
16 cm/6¼"



13.291.17  
17 cm/6¾"



13.291.18  
18 cm/7"

Anastomoseklemmen  
 Anastomosis clamps  
 Pincès à anastomose  
 Pinzas para anastomosis  
 Pinze per anastomosi

Coarctationsklemmen  
 Coarctation clamps  
 Pincès pour coarctation  
 Pinzas para coarctación  
 Pinze per coarctazione



DE BAKEY

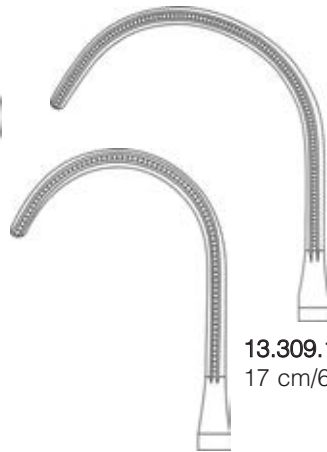

13.309.16  
16 cm/6¼"

13.309.17  
17 cm/6¾"



DE BAKEY  
13.305.15  
15 cm/6"



Coarctationsklemmen  
 Coarctation clamps  
 Pinces pour coarctation  
 Pinzas para coarctación  
 Pinze per coartazione

**ATRAUMA**



DE BAKEY



**DE BAKEY**  
**13.302.16**  
 16 cm/6¼"



**DE BAKEY**  
**13.302.17**  
 17 cm/6½"



**DE BAKEY**  
**13.303.15**  
 15 cm/6"



**DE BAKEY**  
**13.307.17**  
 17 cm/6½"



**Atraumatische Gefäßklemmen**  
 Atraumatic vascular clamps  
 Pincas vasculaires atraumatiques  
 Pinzas vasculares atraumáticas  
 Pinze vascolari atraumatiche

**ATRAUMA**



DE BAKEY

Coarctationsklemmen  
 Coarctation clamps  
 Pincas pour coarctation  
 Pinzas para coarctación  
 Pinze per coartazione



DE BAKEY



90°

**13.311.14**  
14,5 cm/5½"

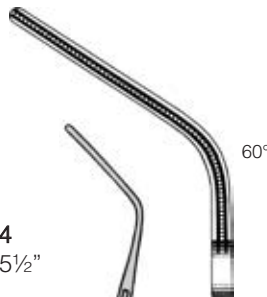

60°

**13.311.15**  
15,5 cm/6"



30°

**13.311.16**  
16 cm/6¼"



**GLOVER**  
**13.321.17**  
17 cm/6¾"



**13.323.17**  
17 cm/6¾"



Anastomoseklemmen  
 Anastomosis clamps  
 Pinces à anastomose  
 Pinzas para anastomosis  
 Pinze per anastomosi

**ATRAUMA**



DE BAKEY



DE BAKEY REYNOLDS



**13.329.01**  
 18 cm/7"

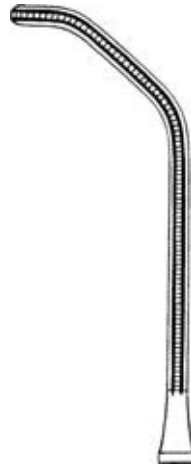

**13.329.02**  
 18 cm/7"

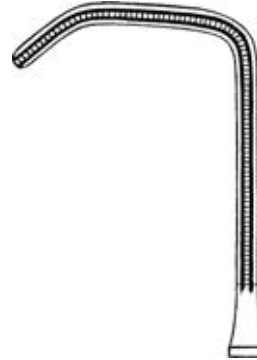

**13.329.03**  
 16,5 cm/6½"



**13.329.04**  
 16,5 cm/6½"

Aortaklemmen  
 Aortic clamp  
 Pince pour l'aorte  
 Pinza clamp para aorta  
 Pinza per aorta



SUBRAMANIAN-MINIATURE  
**13.331.15**  
 15,5 cm/6"

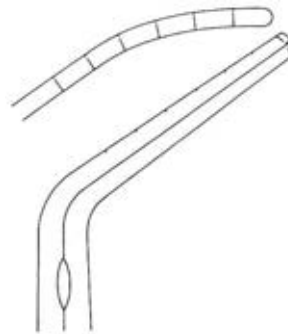

**13.333.16**  
 16 cm/6¼"

rechts gebogen  
 curved to right  
 courbe à droite  
 curva a la derecha  
 curva a destra

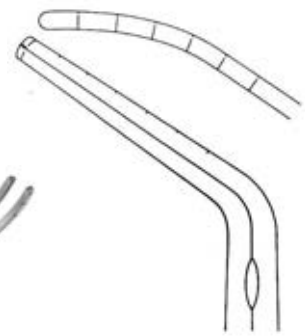

**13.335.16**  
 16 cm/6¼"

links gebogen  
 curved to left  
 courbe à gauche  
 curva a la izquierda  
 curva a sinistra



SUBRAMANIAN



**Atraumatische Gefäßklemmen**  
Atraumatic vascular clamps  
Pincés vasculaires atraumatiques  
Pinzas vasculares atraumáticas  
Pinze vascolari atraumatiche

**ATRAUMA**



DE BAKEY

Aortaklemmen  
Aortic clamp  
Pincés pour l'aorte  
Pinzas clamp para aorta  
Pinzas per aorta



OCHSNER



13.337.23  
23 cm/9"



13.337.26  
26 cm/10¼"



DIETRICH  
13.339.21  
21 cm/8¼"







Ligaturklemmen  
 Ligature clamps  
 Pinces à ligature  
 Pinzas para ligaduras  
 Pinze per legature



DE BAKEY



13.341.19  
 19 cm/7½"



13.341.23  
 23 cm/9"



Anastomoseklemmen  
 Anastomosis clamps  
 Pinces à anastomose  
 Pinzas para anastomosis  
 Pinze per anastomosi

**ATRAUMA**



DE BAKEY



DE BAKEY  
 13.341.20  
 20 cm/8"



Carotis-Shuntklemmen  
 Carotid shunt clamps  
 Pinces pour carotide  
 Pinzas para carótido  
 Pinze carotis



JAVID



13.343.18  
 18 cm/7"



13.343.19  
 19 cm/7½"



**Atraumatische Gefäßklemmen**  
Atraumatic vascular clamps  
Pincés vasculaires atraumatiques  
Pinzas vasculares atraumáticas  
Pinze vascolari atraumatiche

**ATRAUMA**



DE BAKEY

Peripheral-Gefäßklemmen  
Peripheral vascular clamps  
Pincés vasculaires périphériques  
Pinzas para vasos periféricos  
Pinze vascolari per vasi periferici



MARTIN-WYLIE

**13.344.16**  
16 cm/6¼"

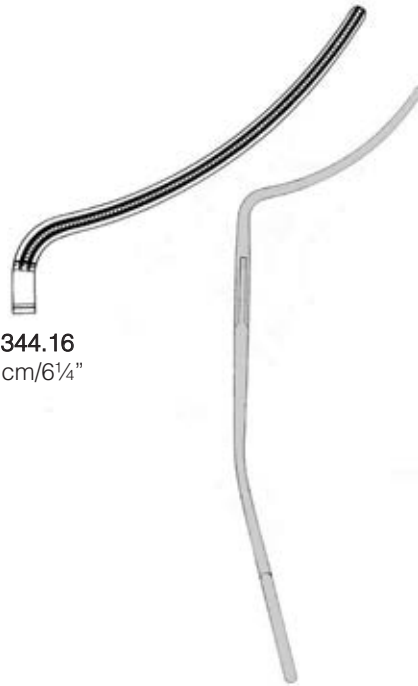

**13.344.17**  
17 cm/6½"



**13.344.18**  
18 cm/7"



**13.344.20**  
20 cm/8"

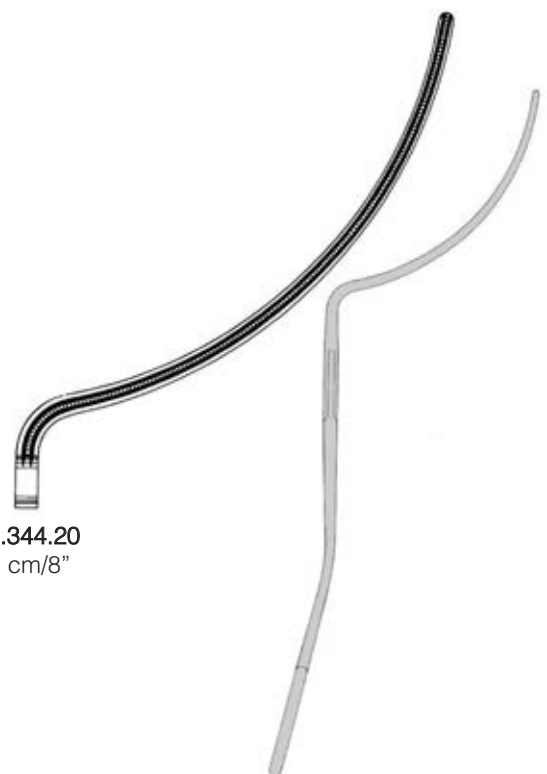



Präparier- und Ligaturklemmen  
Dissecting and ligature clamps  
Pincès à dissection et à ligature  
Pinzas de disección y para ligaduras  
Pinze per dissezione e per legature

**ATRAUMA**



DE BAKEY



**DE BAKEY-RUMEL**  
25 cm/10"



81 mm  
**13.345.01**



81 mm  
**13.345.02**



**DE BAKEY-MC QUIGG-MIXTER**  
**13.345.21**  
21 cm/8¼"

70 mm



**Atraumatische Gefäßklemmen**  
 Atraumatic vascular clamps  
 Pincas vasculaires atraumatiques  
 Pinzas vasculares atraumáticas  
 Pinze vascolari atraumatiche

**ATRAUMA**



DE BAKEY

Präparier- und Ligaturklemmen  
 Dissecting and ligature clamps  
 Pincas à dissection et à ligature  
 Pinzas de disección y para ligaduras  
 Pinze per dissezione e per legature



80 mm

**DE BAKEY-MIXTER**  
**13.345.28**  
 28,5 cm/11¼"

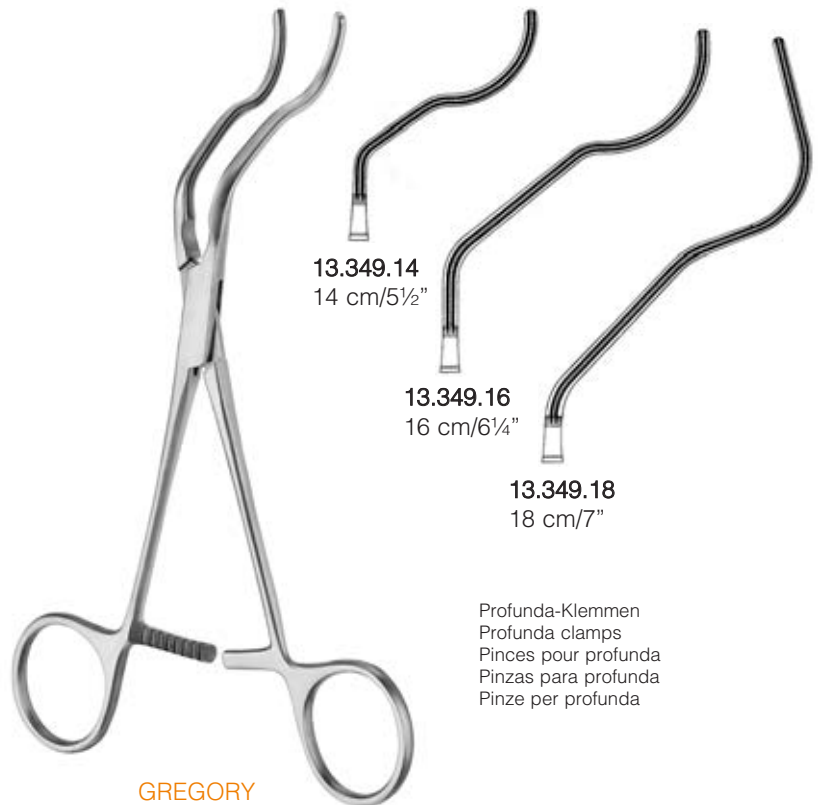

**13.349.14**  
 14 cm/5½"

**13.349.16**  
 16 cm/6¼"

**13.349.18**  
 18 cm/7"

Profunda-Klemmen  
 Profunda clamps  
 Pincas pour profunda  
 Pinzas para profunda  
 Pinze per profunda

**GREGORY**



**ATRAUMA**



COOLEY

Bulldogklemmen mit Ringgriff  
 Ring Bulldog clamps  
 Clamps Bulldog, manche à anneau  
 Clamps Bulldog con mango de anillo  
 Pinze Bulldog con manico di anello



COOLEY

**13.350.13**  
 12,5 cm/5"

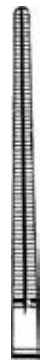

**13.351.13**  
 12,5 cm/5"

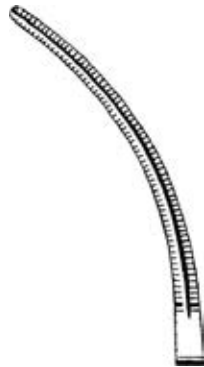

COOLEY  
**13.353.13**  
 13,5 cm/5¼"

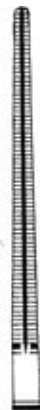

15°



COOLEY  
**13.359.10**  
 10,5 cm/4¼"





**Atraumatische Gefäßklemmen**  
 Atraumatic vascular clamps  
 Pincés vasculaires atraumatiques  
 Pinzas vasculares atraumáticas  
 Pinze vascolari atraumatiche

**ATRAUMA**



COOLEY

Bulldogklemmen mit Ringgriff  
 Ring Bulldog clamps  
 Clamps Bulldog, manche à anneau  
 Clamps Bulldog con mango de anillo  
 Pinze Bulldog con manico di anello



**COOLEY**  
**13.355.13**  
 13,0 cm/5"

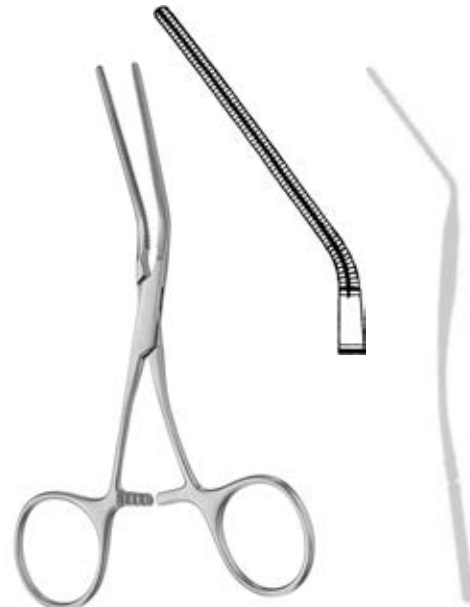

**COOLEY**  
**13.357.12**  
 12,5 cm/5"



**COOLEY**  
**13.361.12**  
 12,0 cm/4¾"



**COOLEY**  
**13.363.13**  
 13,5 cm/5¼"



**ATRAUMA**



COOLEY

Katheterklemmen  
 Catheter clamps  
 Pinces pour cathéters  
 Pinzas para catéteres  
 Pinze per cateteri

für die Vena cava  
 for vena cava  
 pour vena cava  
 para la vena cava  
 per la vena cava



COOLEY



**13.371.24**  
 16 cm/6¼"  
 24 Charr.



**13.371.26**  
 16 cm/6¼"  
 26 Charr.



**13.371.28**  
 20 cm/8"  
 28 Charr.



**13.373.30**  
 20 cm/8"  
 30 Charr.



**13.373.32**  
 20 cm/8"  
 32 Charr.



**13.373.36**  
 20 cm/8"  
 36 Charr.



**Atraumatische Gefäßklemmen**  
 Atraumatic vascular clamps  
 Pinces vasculaires atraumatiques  
 Pinzas vasculares atraumáticas  
 Pinze vascolari atraumatiche

**ATRAUMA**



COOLEY

Neonatal- und Pädiatrieklemmen, extra feine Modelle  
 Neonatal and pediatric clamps, extra delicate patterns  
 Pinces pour des nouveaux-nés et des enfants, modèles très fins  
 Pinzas para recién nacidos y niños, modelos muy finos  
 Pinze pediatriche per neonato e bambini, modelli molto fini



**13.376.14**  
 14 cm/5½"

COOLEY



**13.377.14**  
 14 cm/5½"



**COOLEY**  
**13.379.14**  
 14 cm/5½"



**COOLEY**  
**13.380.14**  
 14 cm/5½"



**COOLEY**  
**13.381.14**  
 14 cm/5½"





**ATRAUMA**



COOLEY

Coarctationsklemmen  
 Coarctation clamps  
 Pinces pour coarctation  
 Pinzas para coarctación  
 Pinze per coartazione



**COOLEY**  
**13.376.16**  
 16 cm/6¼"



**COOLEY**  
**13.377.16**  
 16 cm/6¼"

Atraumatische Mehrzweckklemmen  
 Atraumatic multi-purpose clamps  
 Pinces polyvalentes  
 Pinzas para multiuso  
 Pinze atraumatiche per multiuso

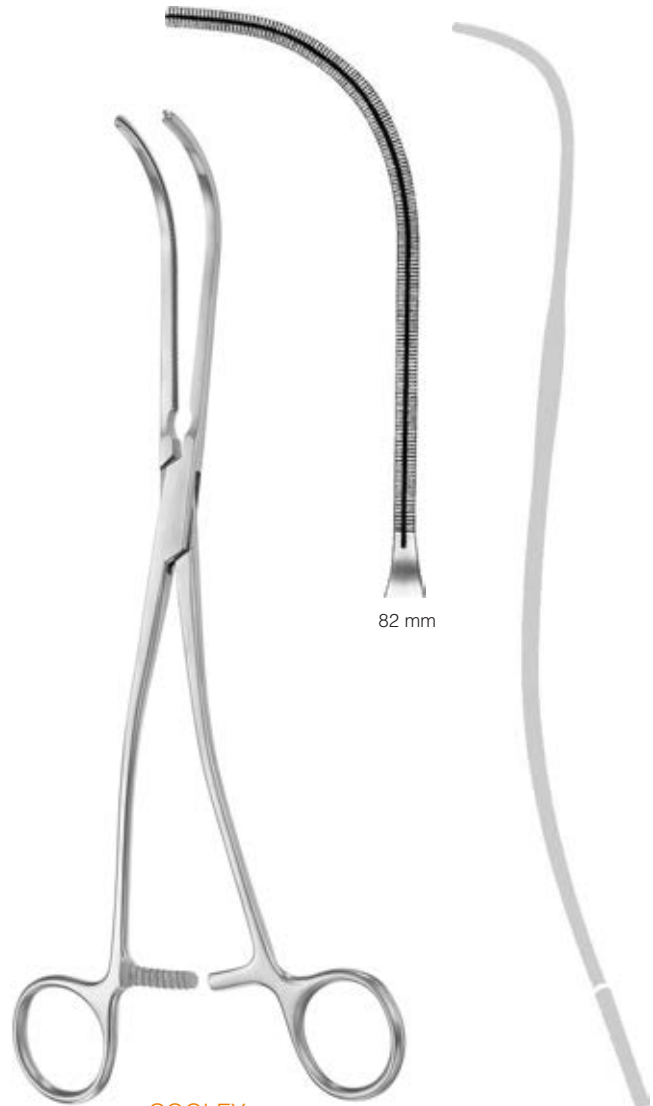

82 mm

**COOLEY**  
**13.405.27**  
 27 cm/10¾"



**Atraumatische Gefäßklemmen**  
 Atraumatic vascular clamps  
 Pinces vasculaires atraumatiques  
 Pinzas vasculares atraumáticas  
 Pinze vascolari atraumatiche

**ATRAUMA**



COOLEY

Coarctationsklemmen  
 Coarctation clamps  
 Pinces pour coarctation  
 Pinzas para coarctación  
 Pinze per coarctazione



**13.410.17**  
 17 cm/6¾"

COOLEY

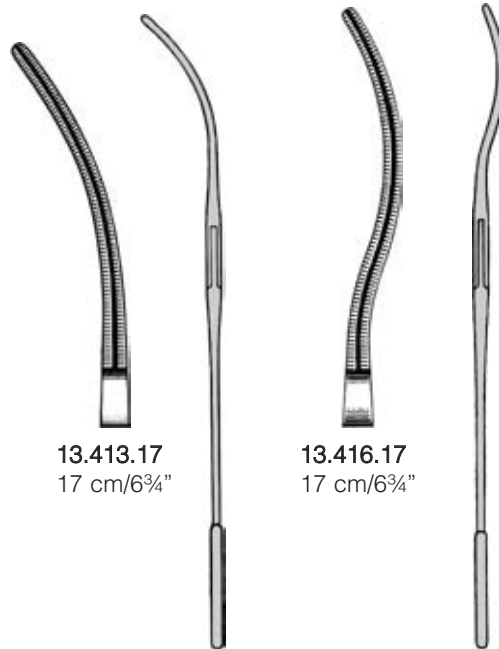

**13.413.17**  
 17 cm/6¾"

**13.416.17**  
 17 cm/6¾"

Coarctationsklemmen  
 Coarctation clamps  
 Pinces pour coarctation  
 Pinzas para coarctación  
 Pinze per coarctazione



**COOLEY**  
**13.411.17**  
 17 cm/6¾"

Iliaca-Klemmen  
 Iliac clamps  
 Pinces pour veine iliaque  
 Pinzas para iliaca  
 Pinze per iliaca

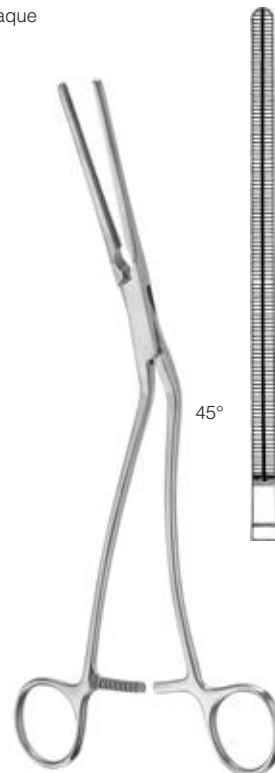

**COOLEY**  
 21,5 cm/8½" **13.417.21**  
 25 cm/10" **13.417.25**



**ATRAUMA**



COOLEY

Anastomoseklemmen  
 Anastomosis clamps  
 Pinces à anastomose  
 Pinzas para anastomosis  
 Pinze per anastomosi



**COOLEY-BECK**  
**13.419.17**  
 17 cm/6¾"

Neonatal- und Pädiatrieklemmen  
 Neonatal and pediatric clamps  
 Pinces pour des nouveaux-nés et des enfants  
 Pinzas para recién nacidos y niños  
 Pinze pediatriche per neonato e bambini



**13.420.14**  
 14 cm/5½"

**13.421.14**  
 14 cm/5½"

**13.425.14**  
 14 cm/5½"

**COOLEY**



**COOLEY**  
**13.423.14**  
 14 cm/5½"



**Atraumatische Gefäßklemmen**  
 Atraumatic vascular clamps  
 Pinces vasculaires atraumatiques  
 Pinzas vasculares atraumáticas  
 Pinze vascolari atraumatiche

**ATRAUMA**



COOLEY

Anastomoseklemmen  
 Anastomosis clamps  
 Pinces à anastomose  
 Pinzas para anastomosis  
 Pinze per anastomosi



COOLEY-BECK



13.426.15  
 15 cm/6"

13.426.16  
 15,5 cm/6"



COOLEY



13.427.15  
 17 cm/6¾"

13.427.16  
 17 cm/6¾"

13.427.14  
 17 cm/6¾"



Tangentialklemmen  
Tangential occlusion clamps  
Pinces pour occlusion tangentielle  
Pinzas para oclusión tangencial  
Pinze per occlusione tangenziale

**ATRAUMA**



COOLEY



COOLEY



**13.430.31**  
20,5 cm/8"

**13.430.44**  
26 cm/10¼"

**13.430.50**  
26 cm/10½"

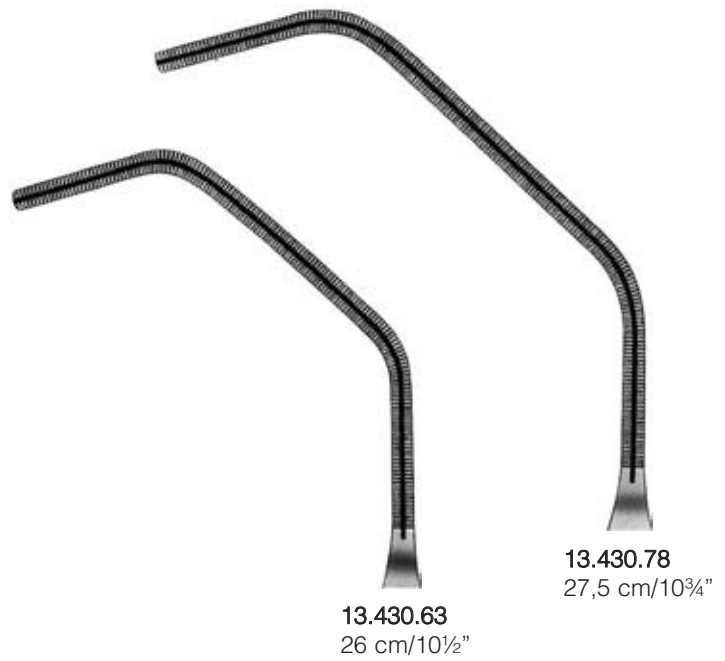

**13.430.63**  
26 cm/10½"

**13.430.78**  
27,5 cm/10¾"



**Atraumatische Gefäßklemmen**  
 Atraumatic vascular clamps  
 Pincés vasculaires atraumatiques  
 Pinzas vasculares atraumáticas  
 Pinze vascolari atraumatiche

**ATRAUMA**



COOLEY

Atraumatische Mehrzweckklemmen  
 Atraumatic multi-purpose clamps  
 Pincés polyvalentes  
 Pinzas clamps para multiuso  
 Pinze atraumatiche per multiuso



13.431.25  
17 cm/6¾"

13.431.45  
15,5 cm/6¼"

13.431.90  
15 cm/6"

COOLEY

Neonatal- und Pädiatrieklemmen  
 Neonatal and pediatric clamps  
 Pincés pour des nouveaux-nés et des enfants  
 Pinzas para recién nacidos y niños  
 Pinze pediatriche per neonato e bambini

Anastomoseklemmen  
 Anastomosis clamps  
 Pincés à anastomose  
 Pinzas para anastomosis  
 Pinze per anastomosi

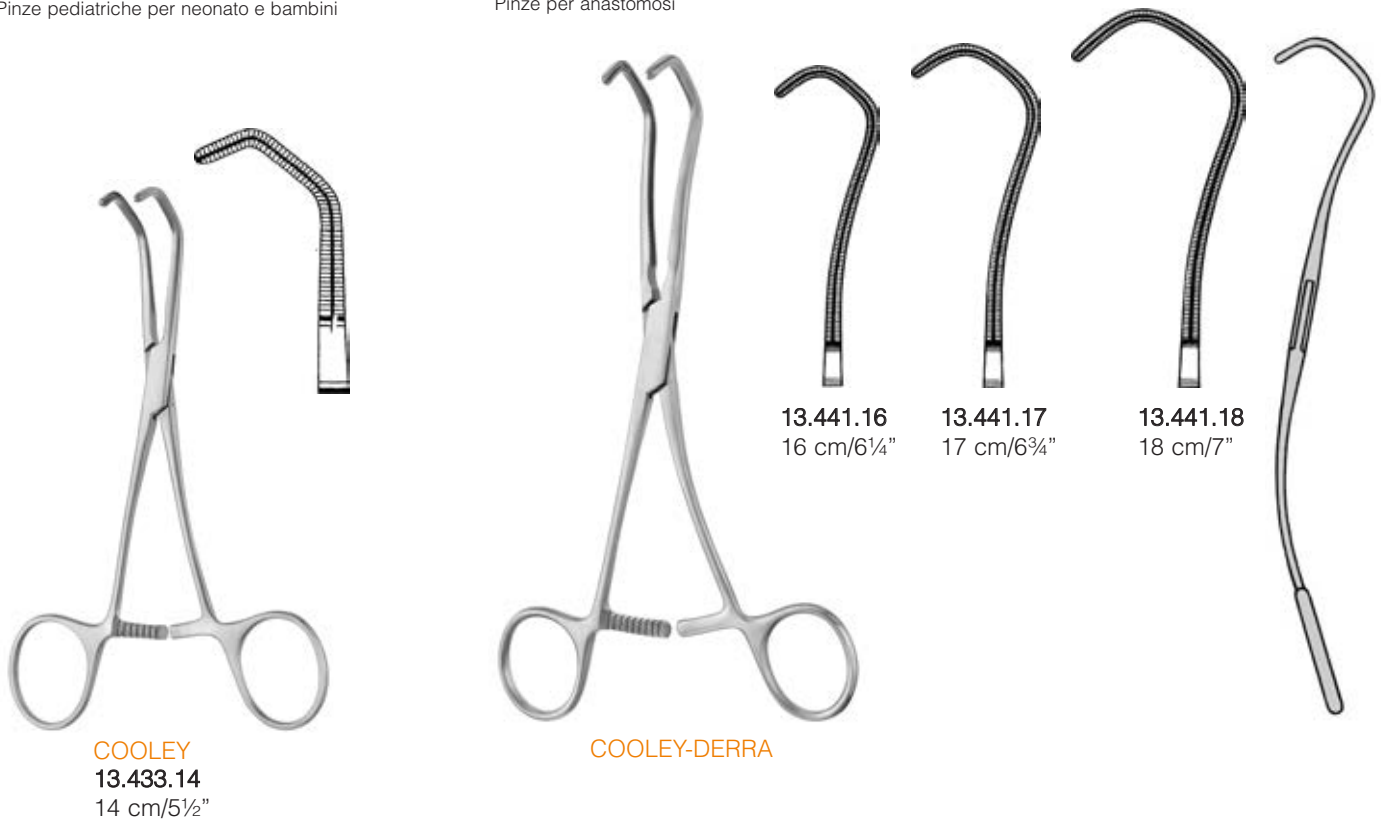

COOLEY  
13.433.14  
14 cm/5½"

COOLEY-DERRA

13.441.16  
16 cm/6¼"

13.441.17  
17 cm/6¾"

13.441.18  
18 cm/7"



Anastomoseklemmen  
 Anastomosis clamps  
 Pinces à anastomose  
 Pinzas para anastomosis  
 Pinze per anastomosi

**ATRAUMA**



COOLEY

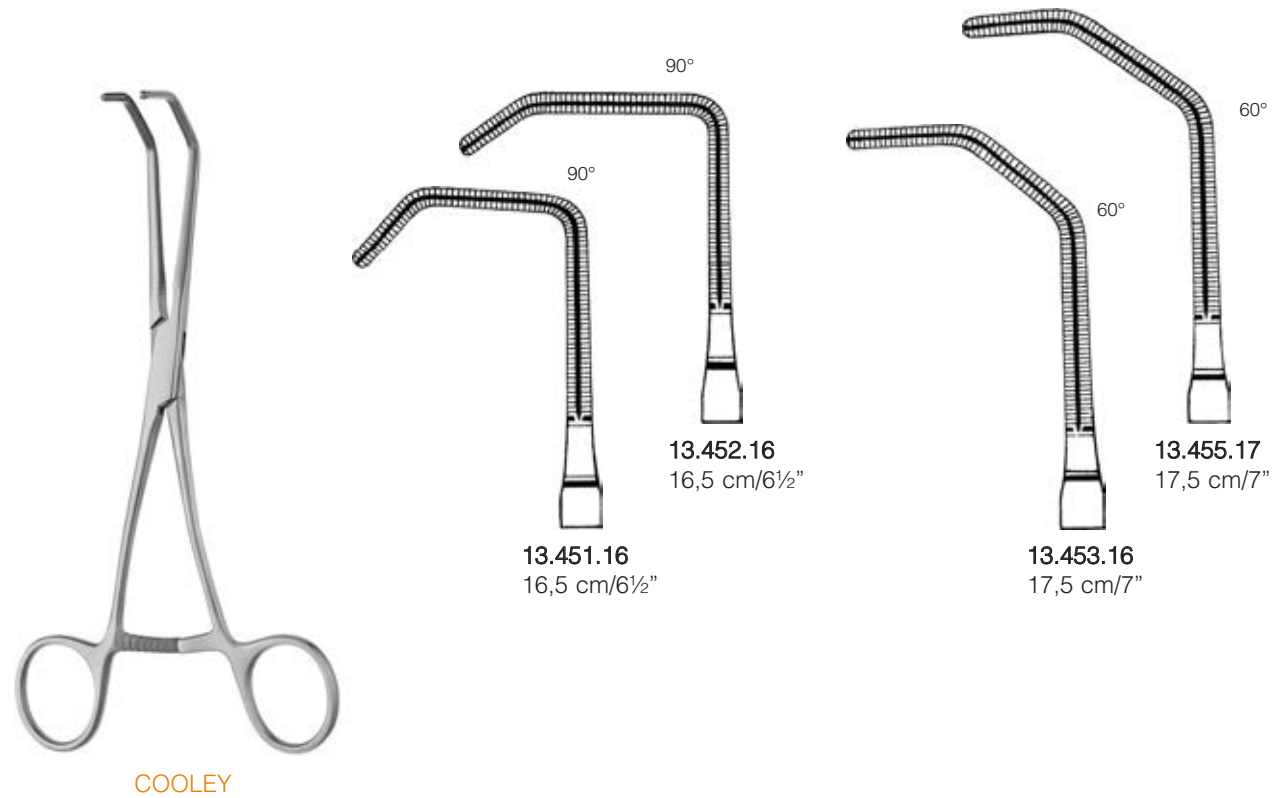



**Atraumatische Gefäßklemmen**  
 Atraumatic vascular clamps  
 Pincés vasculaires atraumatiques  
 Pinzas vasculares atraumáticas  
 Pinze vascolari atraumatiche

**ATRAUMA**



COOLEY

Atraumatische Mehrzweckklemmen  
 Atraumatic multi-purpose clamps  
 Pincés polyvalentes  
 Pinzas para multiuso  
 Pinze atraumatiche per multiuso



**COOLEY**  
**13.457.17**  
 17 cm/6¾"

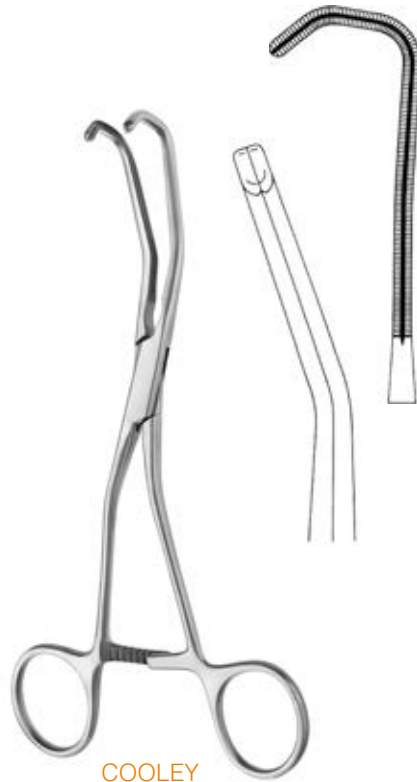

**COOLEY**  
**13.461.17**  
 17 cm/6¾"

Carotis-Shuntklemmen  
 Carotid shunt clamps  
 Pincés pour carotide  
 Pinzas para carótido  
 Pinze carotis



**COOLEY**



**13.465.18**  
 18,5 cm/7¼"



**13.465.19**  
 19,5 cm/7¾"







**ATRAUMA**



COOLEY

Carotis-Shuntklemmen  
Carotid shunt clamps  
Pincas pour carotide  
Pinzas para carótido  
Pinze carotis



**COOLEY**  
**13.467.27**  
27,5 cm/10¾"

Atraumatische Mehrzweckklemmen  
Atraumatic multi-purpose clamps  
Pincas polyvalentes  
Pinzas para multiuso  
Pinze atraumatiche per multiuso



**COOLEY**  
**13.465.26**  
26 cm/10¼"



### Gefäßklemmen

Vascular clamps  
Pincès vasculaires  
Pinzas vasculares  
Pinze vascolari

Neonatal- und Pädiatrieklemmen, extra feine Modelle  
Neonatal and pediatric clamps, extra delicate patterns  
Pincès pour des nouveaux-nés et des enfants, modèles très fins  
Pinzas para recién nacidos y niños, modelos muy finos  
Pinze pediatriche per neonato e bambini, modelli molto fini



**13.481.13**  
13 cm/5"



**13.483.13**  
12,5 cm/5"



**13.485.13**  
12 cm/4¾"

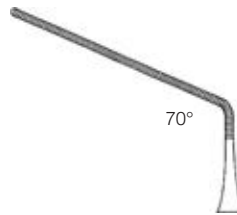

**13.487.13**  
11,5 cm/4½"



**13.489.13**  
11 cm/4¼"



**CASTAÑEDA**



**13.491.15**  
12 cm/4¾"



**13.493.15**  
12 cm/4¾"



**13.495.12**  
12 cm/4¾"



**13.495.15**  
12 cm/4¾"



Neonatal- und Pädiatrieklemmen, extra feine Modelle  
 Neonatal and pediatric clamps, extra delicate patterns  
 Pinces pour des nouveaux-nés et des enfants, modèles très fins  
 Pinzas para recién nacidos y niños, modelos muy finos  
 Pinze pediatriche per neonato e bambini, modelli molto fini

**ATRAUMA**



COOLEY



COOLEY

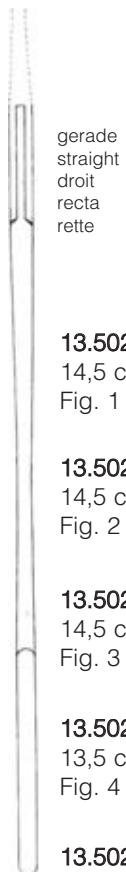
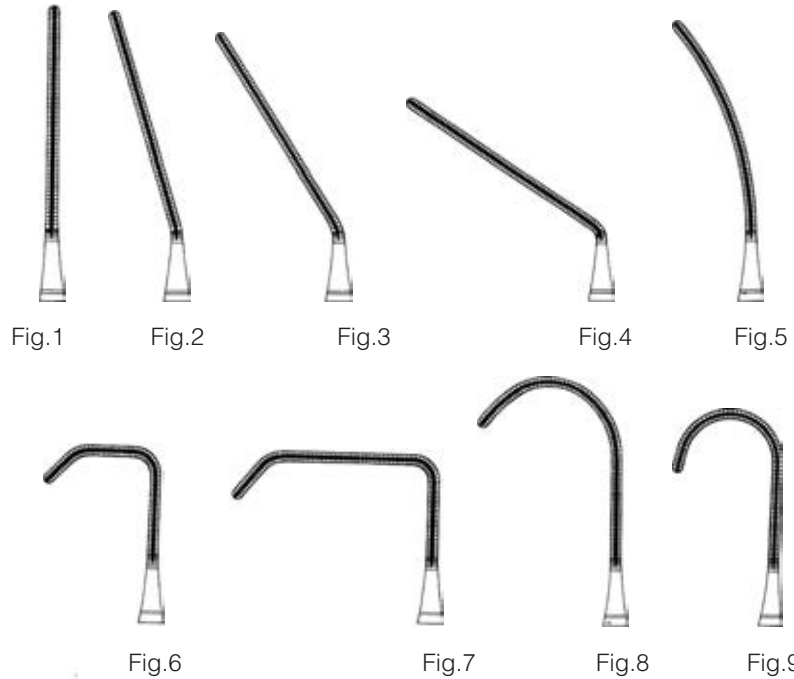

gerade  
straight  
droit  
recta  
rette

**13.502.01**  
14,5 cm/5¾"  
Fig. 1

**13.502.02**  
14,5 cm/5¾"  
Fig. 2

**13.502.03**  
14,5 cm/5½"  
Fig. 3

**13.502.04**  
13,5 cm/5¼"  
Fig. 4

**13.502.05**  
14,5 cm/5½"  
Fig. 5



abgewinkelt  
angled  
coudé  
acodado  
angolari

**13.503.01**  
14,5 cm/5¾"  
Fig. 1

**13.503.02**  
14,5 cm/5¾"  
Fig. 2

**13.503.03**  
14,5 cm/5½"  
Fig. 3

**13.503.04**  
13,5 cm/5¼"  
Fig. 4

**13.503.05**  
14 cm/5½"  
Fig. 5



stark abgewinkelt  
strongly angled  
fortement coudé  
fuertemente acodado  
fortemente angolari

**13.503.06**  
13,5 cm/5¼"  
Fig. 6

**13.503.07**  
13,5 cm/5¼"  
Fig. 7

**13.503.08**  
14 cm/5½"  
Fig. 8

**13.503.09**  
13,5 cm/5¼"  
Fig. 9

**13.505.01**  
14 cm/5½"  
Fig. 1

**13.505.02**  
14 cm/5½"  
Fig. 2

**13.505.03**  
14 cm/5½"  
Fig. 3

**13.505.04**  
13 cm/5"  
Fig. 4

**13.505.05**  
14,5 cm/5½"  
Fig. 5

**13.505.06**  
13 cm/5"  
Fig. 6

**13.505.07**  
13 cm/5"  
Fig. 7

**13.505.08**  
14 cm/5½"  
Fig. 8

**13.505.09**  
13,5 cm/5¼"  
Fig. 9



**Atraumatische Gefäßklemmen**  
 Atraumatic vascular clamps  
 Pincés vasculaires atraumatiques  
 Pinzas vasculares atraumáticas  
 Pinze vascolari atraumatiche

**ATRAUMA**



COOLEY

Neonatal- und Pädiatrieklemmen, extra feine Modelle  
 Neonatal and pediatric clamps, extra delicate patterns  
 Pincés pour des nouveaux-nés et des enfants, modèles très fins  
 Pinzas para recién nacidos y niños, modelos muy finos  
 Pinze pediatriche per neonato e bambini, modelli molto fini



**COOLEY**  
**13.508.16**  
 16,5 cm/6½"

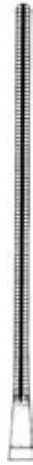

COOLEY



**13.509.16**  
 16,5 cm/6½"



**13.510.16**  
 15,5 cm/6"



**13.511.15**  
 15,5 cm/6"



**13.512.16**  
 16 cm/6¼"



Neonatal- und Pädiatrieklemmen, extra feine Modelle  
Neonatal and pediatric clamps, extra delicate patterns  
Pincas pour des nouveaux-nés et des enfants, modèles très fins  
Pinzas para recién nacidos y niños, modelos muy finos  
Pinze pediatriche per neonato e bambini, modelli molto fini

**ATRAUMA**



DE BAKEY



**CASTAÑEDA**  
12 cm/4¾"

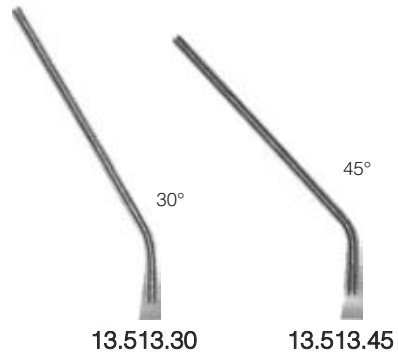

**CASTAÑEDA**  
15,5 cm/6"





**Atraumatische Gefäßklemmen**  
 Atraumatic vascular clamps  
 Pincas vasculaires atraumatiques  
 Pinzas vasculares atraumáticas  
 Pinze vascolari atraumatiche

glattes Maul  
 plain jaw  
 mors lisse  
 boca lisa  
 morso liscio



**13.609.12**  
12 mm

**13.609.20**  
20 mm

**13.609.30**  
30 mm

atraumatisches Maul  
 atraumatic jaw  
 mors atraumatique  
 bocas atraumáticas  
 morso atraumatiche

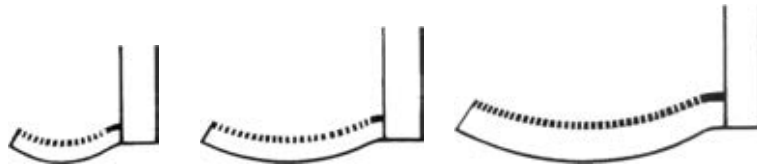

**13.611.12**  
12 mm

**13.611.20**  
20 mm

**13.611.30**  
30 mm

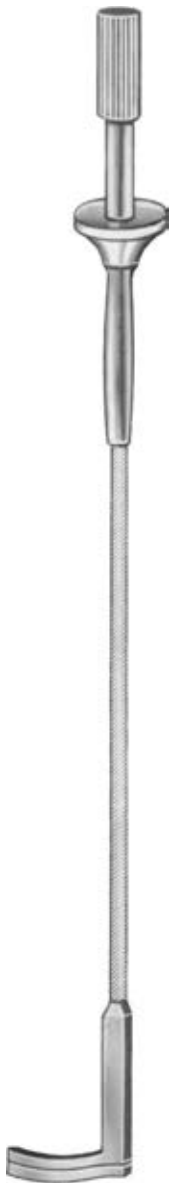

20 cm/8"

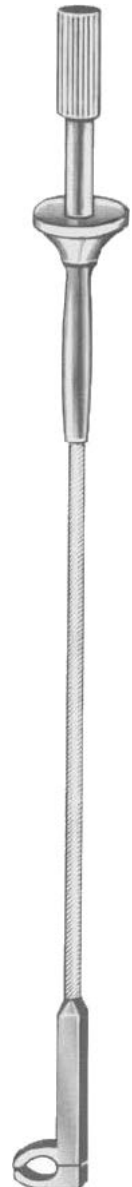

20 cm/8"



**13.615.03**  
Ø 3 mm



**13.615.05**  
Ø 5 mm



**13.615.07**  
Ø 7 mm

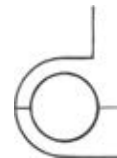

**13.615.09**  
Ø 9 mm



scharf  
sharp  
tranchante  
aguda  
acute

**SCHAEDEL**  
**14.101.09**  
9 cm/3½"



scharf  
sharp  
tranchante  
aguda  
acute

**JONES**  
5,5 cm/2¼" **14.103.05**  
9 cm/3½" **14.103.09**



scharf  
sharp  
tranchante  
aguda  
acute

mit Schlauchhalter  
with tube holder  
avec porte-tuyau  
con porta-tubo

**JONES**  
**14.105.09**  
8,5 cm/3¼"



**BACKHAUS**

9 cm/3½" **14.111.09**  
11 cm/4¼" **14.111.11**  
13 cm/5" **14.111.13**  
15 cm/6" **14.111.15**

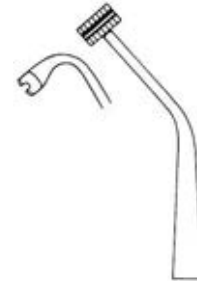

weites Maul zur Schlauchfixierung  
wide jaw for tube fixation  
mors large pour la fixation du tuyau  
boca ancha para fijación de tubos  
morso spalancato per fissare il tubo

**PEERS BERTRAM**  
**14.118.14**  
14,5 cm/5¾"



## Tuchklemmen

Towel clamps  
Pincès à champs  
Pinzas para campos  
Pinze fissateli

für Papierabdeckung  
for paper clothes  
pour la couverture du papier  
para paños de papel  
per copertura di carta



### BALL AND SOCKET

9 cm/3½"	14.123.09
10 cm/4"	14.123.10
11 cm/4¼"	14.123.11
13 cm/5"	14.123.13
14 cm/5½"	14.123.14
16 cm/6¼"	14.123.16

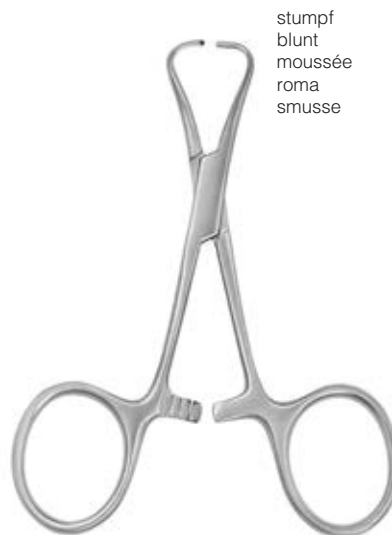

stumpf  
blunt  
moussée  
roma  
smusse

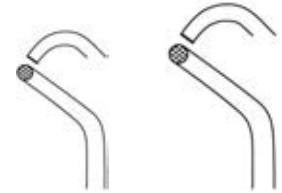

14.127.10  
10 cm/4"

14.127.13  
13 cm/5"

### TOHOKU



fein gezahnt, breites Maul  
fine serrated, wide jaw  
dents fins, mors large  
boca ancha, delicadamente dentada  
marso largo, con denti fini

### LORNA

9 cm/3½"	14.121.09
10 cm/4"	14.121.11
13 cm/5"	14.121.13



### LANE

13 cm/5"	14.164.13
15,5 cm/6"	14.164.15
19,5 cm/7¾"	14.164.20



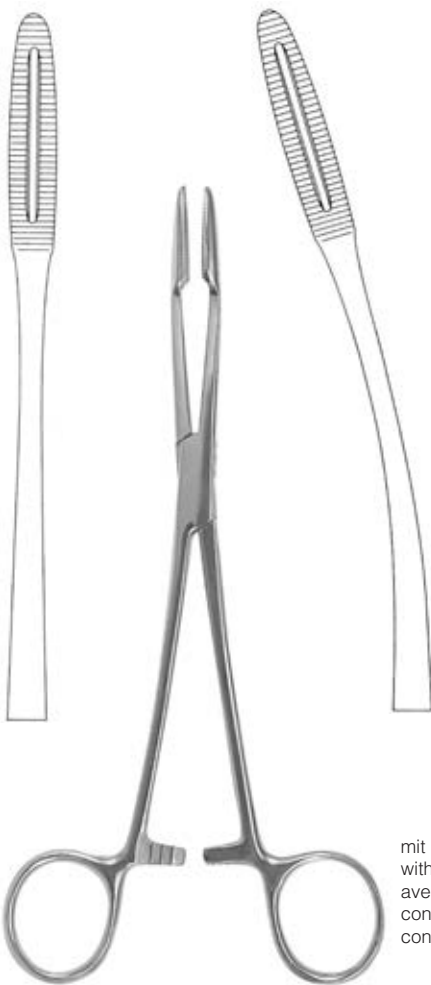

mit Sperre  
with ratchet  
avec crémaillère  
con cierre  
con serratura

**GROSS-MAIER**

14 cm/5½"	16.110.14	16.111.14
18 cm/7"	16.110.18	16.111.18
20 cm/8"	16.110.20	16.111.20
22 cm/8¾"	16.110.22	16.111.22
25 cm/10"	16.110.25	16.111.25
27 cm/10½"	16.110.27	16.111.27
36 cm/14¼"	16.110.36	16.111.36
40 cm/16"	16.110.40	16.111.40

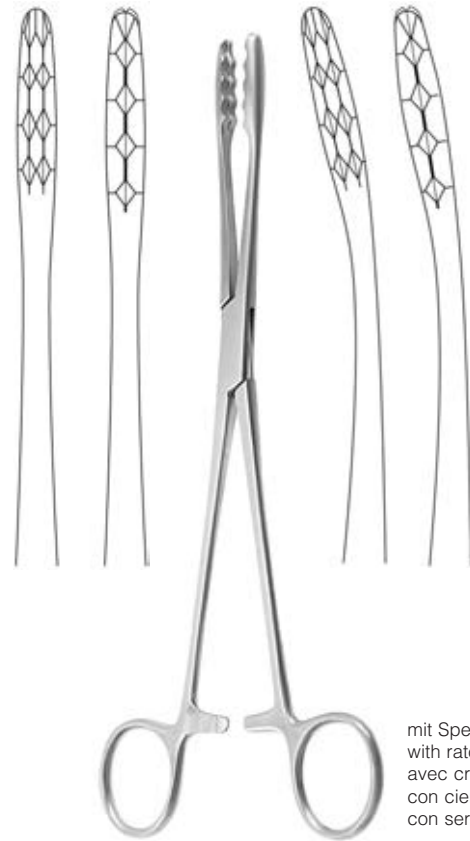

mit Sperre  
with ratchet  
avec crémaillère  
con cierre  
con serratura

**ULRICH**

22 cm/8¾"	16.160.22	16.161.22
25 cm/10"	16.160.25	16.161.25
27 cm/10½"	16.160.27	16.161.27



**Tuchklemmen**

Towel clamps  
Pincas à champs  
Pinzas para campos  
Pinze fissateli

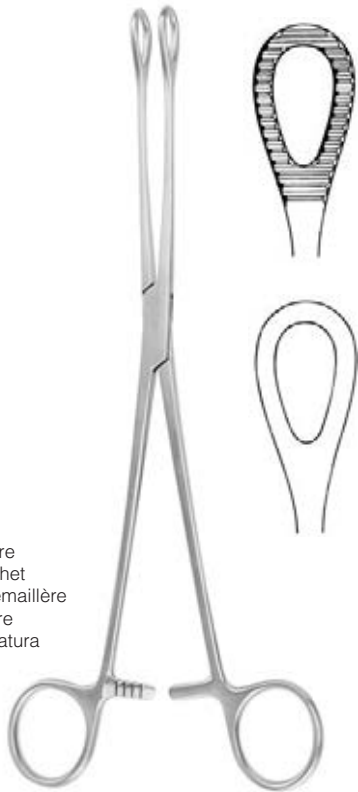

mit Sperre  
with ratchet  
avec crémaillère  
con cierre  
con serratura

**FOERSTER**

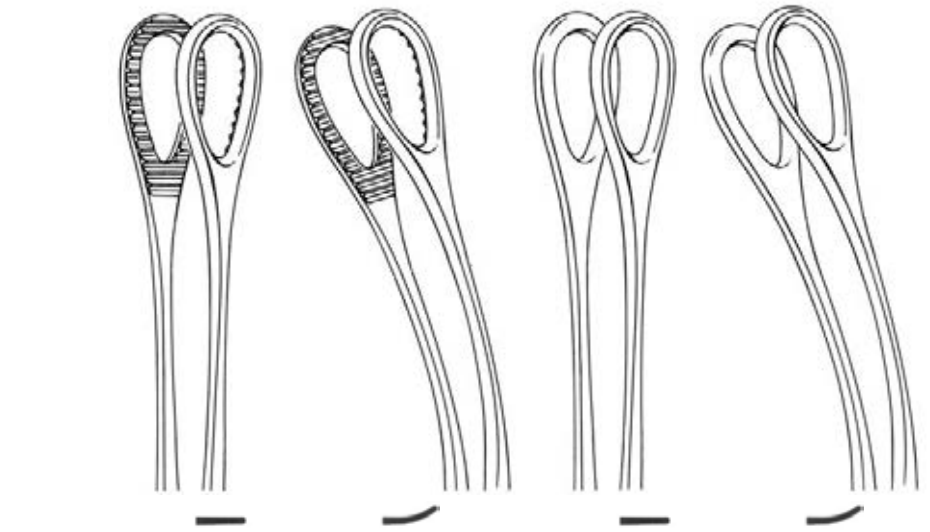

18 cm/7"	16.170.18	16.171.18	16.172.18	16.173.18
20 cm/8"	16.170.20	16.171.20	16.172.20	16.173.20
25 cm/10"	16.170.25	16.171.25	16.172.25	16.173.25
30 cm/12"	16.170.30	16.171.30	16.172.30	16.173.30



16.178.18  
18 cm/7"

16.178.25  
25 cm/10"

mit Sperre  
with ratchet  
avec crémaillère  
con cierre  
con serratura

**RAMPLEY**



16.244.17

16.245.17

mit Sperre  
with ratchet  
avec crémaillère  
con cierre  
con serratura

**MARTIN**  
17 cm/6<sup>3</sup>/<sub>4</sub>"



Sinusklemme  
 Sinus forceps  
 Pincès à sinus  
 Pinzas para seno  
 Pinze sinus



Lungenfasszangen  
 Lung grasping forceps  
 Pincès à saisir le poumon  
 Pinzas para coger el pulmón  
 Pinze per afferrare il polmone





**Bronchusklemmen**  
Bronchus forceps  
Pinces pour bronches  
Pinzas bronquiales  
Pinze per bronchi



**HARRINGTON**  
**56.301.30**  
30,5 cm/12½"



**HARRINGTON**  
29 cm/11¾"    56.303.29  
31 cm/12½"    56.303.31

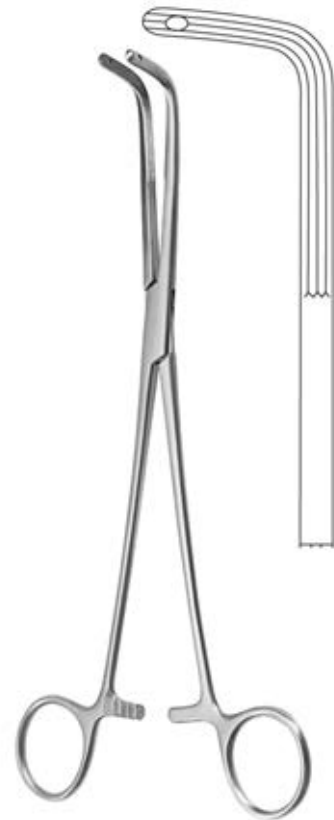

**FINOCHIETTO**  
**56.307.24**  
24 cm/9½"



PRICE-THOMAS  
56.309.22  
22 cm/8 $\frac{3}{4}$ "

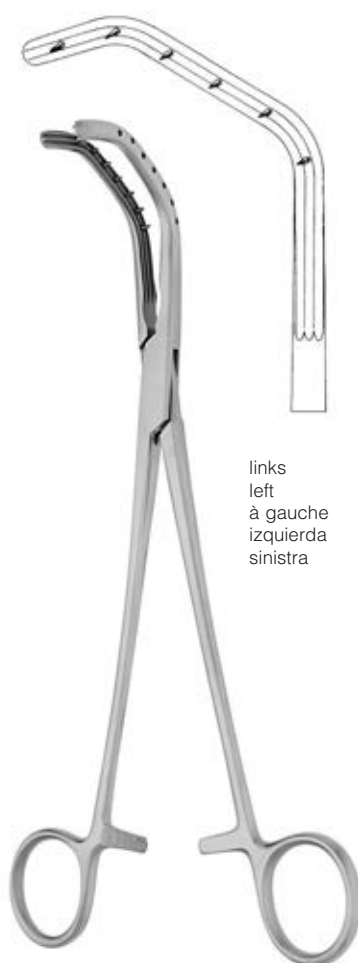

PRICE-THOMAS  
56.311.22  
22 cm/8 $\frac{3}{4}$ "



PRICE-THOMAS  
56.313.22  
22 cm/8 $\frac{3}{4}$ "



**Bronchusklemmen**  
 Bronchus forceps  
 Pincas pour bronches  
 Pinzas bronquiales  
 Pinze per bronchi

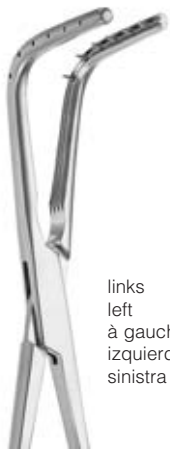

links  
 left  
 à gauche  
 izquierda  
 sinistra

56.317.23



rechts  
 right  
 à droite  
 derecha  
 destra



**SAROT**  
**56.319.23**  
 23 cm/9"



**SEMB**  
 23 cm/9"

Präparier- und Ligaturklemmen  
 Dissecting and ligature forceps  
 Pincas à dissection et à ligature  
 Pinzas para disección y ligaduras  
 Pinze per dissezione e per legature (passafili)



56.321.23



56.323.23



für die Vena cava  
 for vena cava  
 pour vena cava  
 para la vena cava  
 per la vena cava

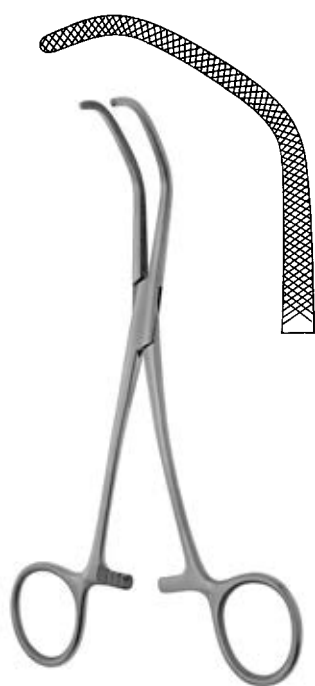

SATINSKY  
 56.325.15  
 15 cm/6"



56.327.26  
 Fig. 1

56.329.26  
 Fig. 2

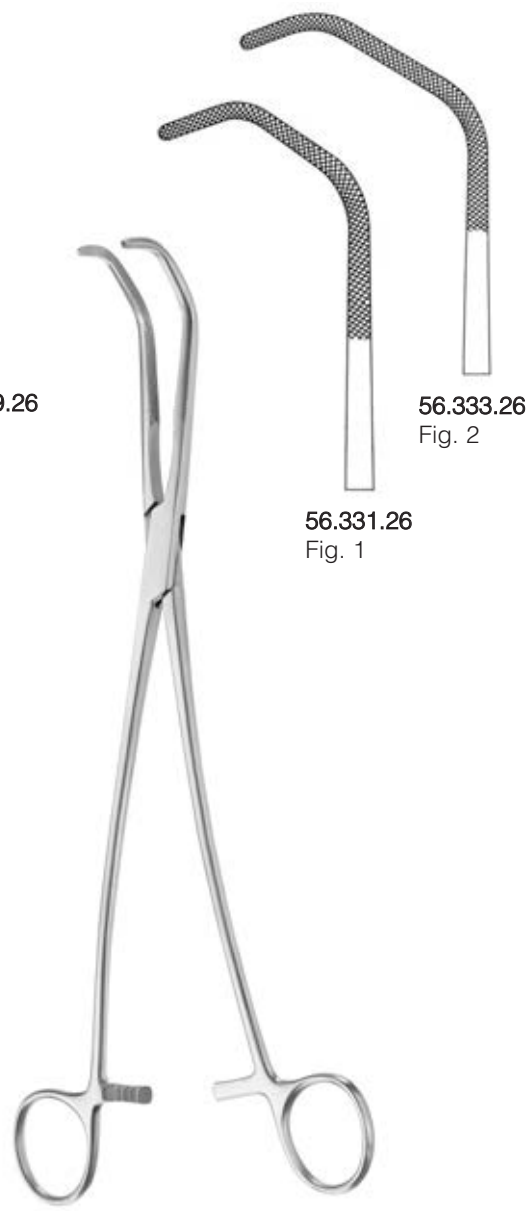

56.331.26  
 Fig. 1

56.333.26  
 Fig. 2



## Aurikelklemmen

Auricle clamps  
Pinces pour oreillette  
Pinzas para aurícula  
Pinze ventricolari



**HARKEN**  
24 cm/9½"

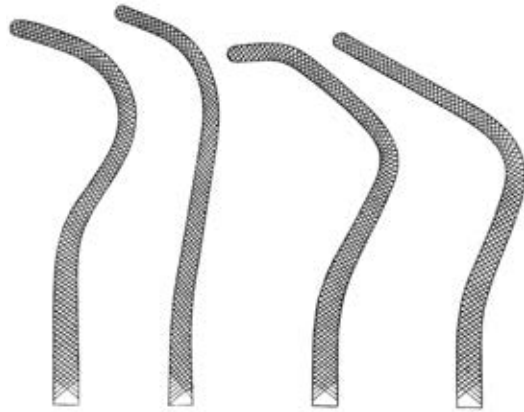

**56.345.24** Fig. 1   **56.343.24** Fig. 2   **56.347.24** Fig. 3   **56.349.24** Fig. 4

Embolusfasszange  
Embolus grasping forceps  
Pince à saisir l'embolus  
Pinzas para coger émbolo  
Pinza afferrare embolo



**BLAKE**  
**62.106.20**  
21 cm/8¼"





**ALLIS-BABY**  
 13 cm/5" **64.102.13**  
 14 cm/5½" **64.102.14**



**ALLIS**

15 cm/6"	<b>64.110.15</b>
19 cm/7½"	<b>64.110.19</b>
25 cm/10"	<b>64.110.25</b>



15 cm/6"	<b>64.120.15</b>
19 cm/7½"	<b>64.120.19</b>
22 cm/8¾"	<b>64.120.22</b>
24 cm/9½"	<b>64.120.24</b>
30 cm/12"	<b>64.120.30</b>

**ATRAUMA**



DE BAKEY



**ALLIS-Atrauma**

**64.124.16**  
 16 cm/6¼"

**64.124.20**  
 20 cm/8"

**64.124.25**  
 25 cm/10"

**64.124.30**  
 30 cm/12"



**JUDD-ALLIS**

15 cm/6"	<b>64.140.15</b>
14 cm/5½"	<b>64.140.19</b>



**THOMS-ALLIS**

<b>64.150.20</b>
20 cm/8"



### Darm- und Gewebefäßzangen

Intestinal and tissue grasping forceps  
Pincès à saisir les intestins et les tissus  
Pinzas para coger intestinos y tejidos  
Pinze per afferrare intestini e tessuti



BABCOCK



64.160.16  
16 cm/6¼"



64.160.18  
18 cm/7"



64.160.20  
20 cm/8"

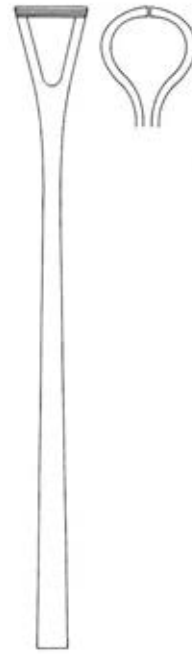

64.160.24  
24 cm/9½"



64.164.16  
16 cm/6¼"



64.164.20  
20 cm/8"

### ATRAUMA



DE BAKEY



64.168.20  
20 cm/8"



64.168.16  
16 cm/6¼"

mit TC-Einsätzen  
with TC inserts  
avec mors TC  
con bocas TC  
con morso TC



BABCOCK

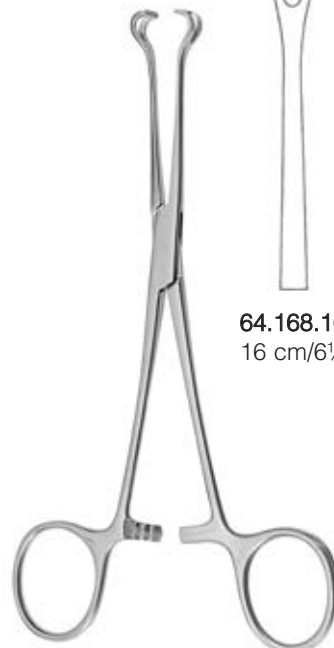

BABCOCK-Atrauma

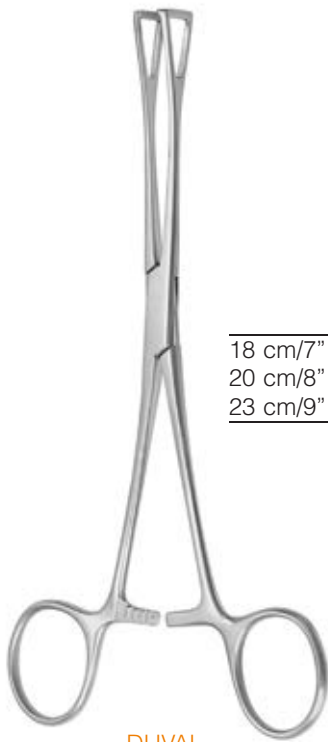

DUVAL



18 cm/7"	<b>64.170.18</b>	
20 cm/8"	<b>64.170.20</b>	<b>64.172.20</b>
23 cm/9"		<b>64.172.23</b>

**ATRAUMA**



DE BAKEY

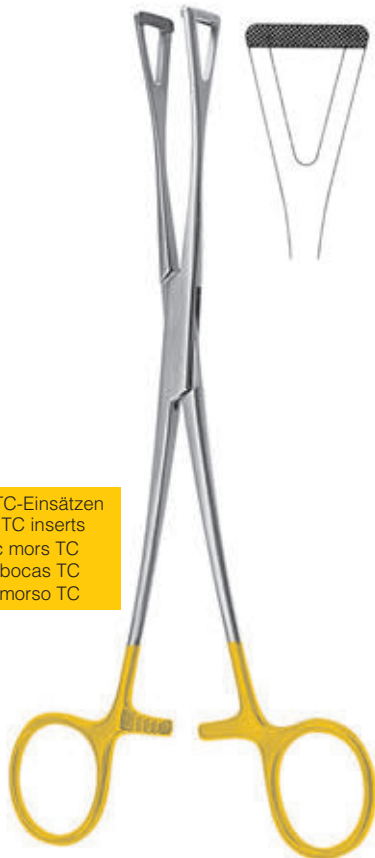

mit TC-Einsätzen  
 with TC inserts  
 avec mors TC  
 con bocas TC  
 con morso TC

DUVAL  
**64.174.20**  
 20 cm/8"



SCHEIBE

<b>64.178.18</b>	<b>64.178.20</b>	<b>64.178.23</b>
18 cm/7"	20 cm/8"	23 cm/9"



## Darm- und Gewebefäßzangen

Intestinal and tissue grasping forceps  
Pinces à saisir les intestins et les tissus  
Pinzas para coger intestinos y tejidos  
Pinze per afferrare intestini e tessuti

Herzklappen-Fasszange  
Cardiac valve grasping forceps  
Pinces à saisir la valvule cardiaque  
Pinzas de corazón-válvula  
Pinze per afferrare il cuore-valvola

2 : 3



**LITTLEWOOD**  
**64.144.19**  
19 cm/7½"



**WILLIAMS**  
**64.180.16**  
16,5 cm/6½"



**TEALE**  
**70.531.23**  
23 cm/9"



3 : 4

# 05

◆ WUNDHAKEN  
RETRACTORS  
ECARTEURS  
SEPARADORES  
DIVARICATORI





**Wundhaken**  
Retractors  
Ecarteurs  
Separadores  
Divaricatori



Fig. 2 = 30 x 10 mm  
Fig. 1 = 26 x 10 mm

Fig. 1 = 30 x 13 mm  
Fig. 2 = 34 x 13 mm

**FARABEU F**  
**18.102.12**  
12 cm/4¾"  
Fig. 1 + 2

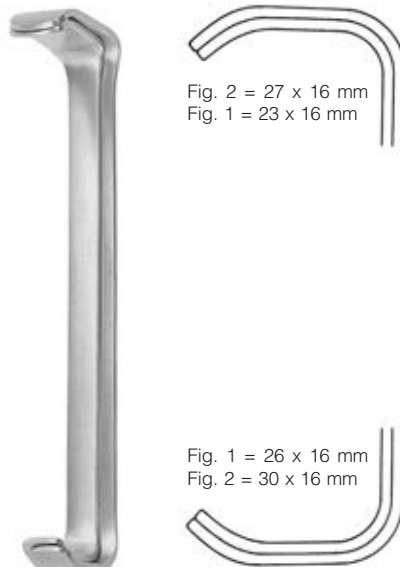
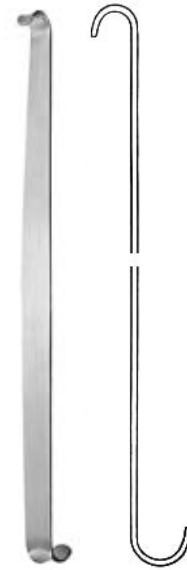

Fig. 2 = 27 x 16 mm  
Fig. 1 = 23 x 16 mm

Fig. 1 = 26 x 16 mm  
Fig. 2 = 30 x 16 mm

**FARABEU F**  
**18.102.15**  
15 cm/6"  
Fig. 1 + 2



**ROUX-Mini**  
**18.124.15**  
15 cm/6"  
8 x 6 mm

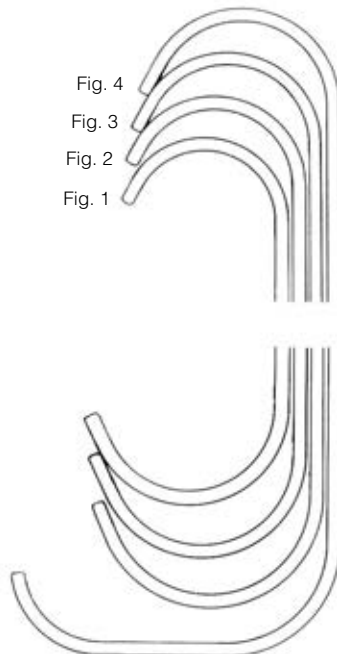
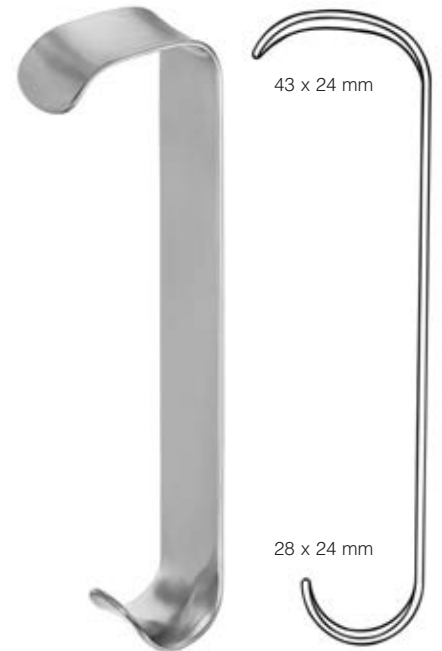

Fig. 4  
Fig. 3  
Fig. 2  
Fig. 1



43 x 24 mm

28 x 24 mm

**ROUX**  
**18.120.00**

Satz komplett, Fig. 1 - 3  
Set complete, Fig. 1 - 3  
Jeu complet, Fig. 1 - 3  
Juego completo, Fig. 1 - 3  
Serie completa, Fig. 1 - 3

Fig. 1	14 cm/5½"	<b>18.120.14</b>	24 x 20 / 30 x 28 mm
Fig. 2	15 cm/6"	<b>18.120.15</b>	29 x 26 / 36 x 36 mm
Fig. 3	17 cm/6¾"	<b>18.120.17</b>	33 x 29 / 38 x 43 mm
Fig. 4	18 cm/7"	<b>18.120.18</b>	29 x 24 / 45 x 28 mm

**ROUX**  
**18.120.28**  
17 cm/6¾"

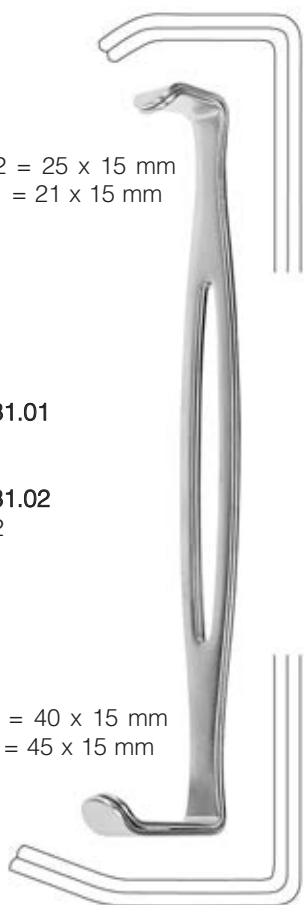

Fig. 2 = 25 x 15 mm  
Fig. 1 = 21 x 15 mm

**18.131.01**  
Fig. 1

**18.131.02**  
Fig. 2

Fig. 1 = 40 x 15 mm  
Fig. 2 = 45 x 15 mm



US Army (PARKER-LANGENBECK)

**18.131.21**  
21 cm/8¼"  
Fig. 1 + 2

Fig. 2 = 49 x 38 mm  
Fig. 1 = 28 x 20 mm

**RICHARDSON**  
**18.140.01**  
26 cm/10¼"  
Fig. 1

**18.140.02**  
27 cm/10¾"  
Fig. 2

Fig. 1 = 36 x 28 mm  
Fig. 2 = 63 x 49 mm

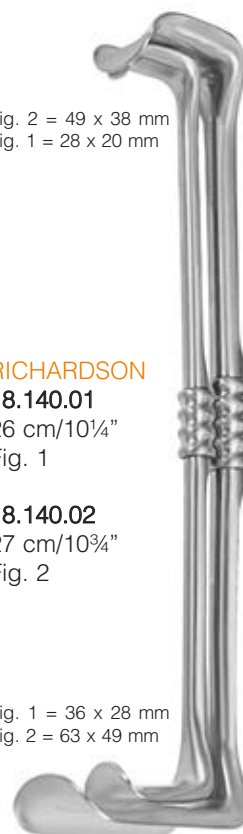

**RICHARDSON-EASTMAN**

**18.140.00**  
Fig. 1 + 2



**MIDDELDORPF**

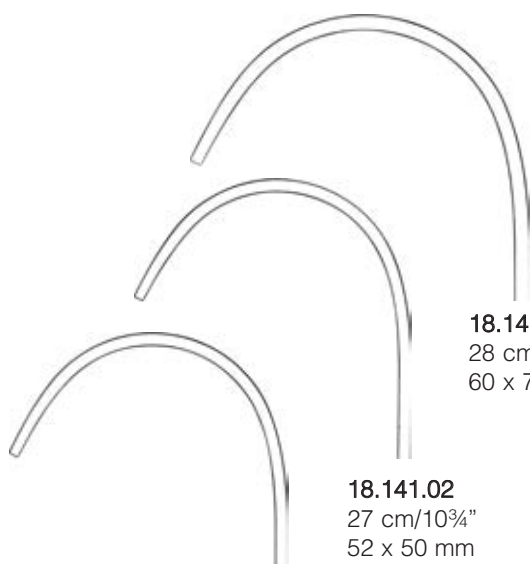

**18.141.01**  
27 cm/10¾"  
48 x 45 mm

**18.141.02**  
27 cm/10¾"  
52 x 50 mm

**18.141.03**  
28 cm/11"  
60 x 70 mm



**Wundhaken**  
Retractors  
Ecarteurs  
Separadores  
Divaricatori



FRITSCH



**18.142.00**  
23,5 cm/9¼"  
37 x 31 mm



**18.142.01**  
24 cm/9½"  
38 x 40 mm



**18.142.02**  
25 cm/10"  
43 x 51 mm



**18.142.03**  
25 cm/10"  
49 x 61 mm

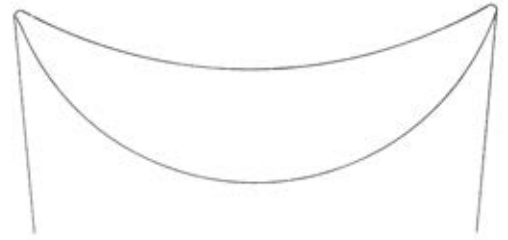

**18.142.04**  
25,5 cm/10"  
48 x 75 mm

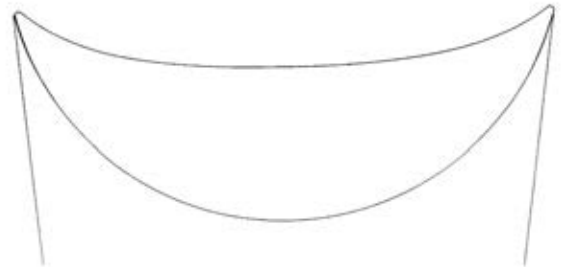

**18.142.05**  
26,5 cm/10½"  
65 x 85 mm





**RICHARDSON**  
24 cm/9½"



**18.150.01**  
28 x 20 mm



**18.150.03**  
44 x 38 mm



**18.150.02**  
36 x 28 mm



**18.150.04**  
52 x 22 mm



**KELLY**  
26 cm/10¼"

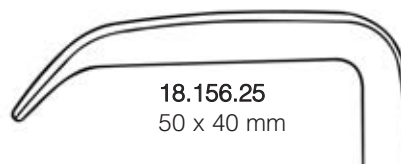

**18.156.25**  
50 x 40 mm

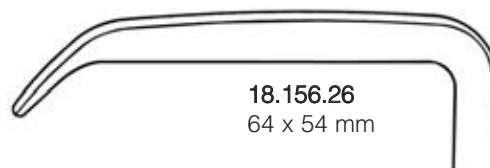

**18.156.26**  
64 x 54 mm

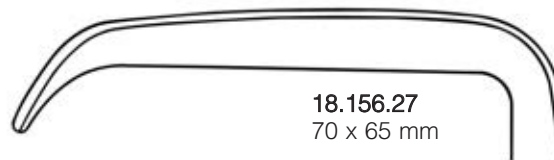

**18.156.27**  
70 x 65 mm

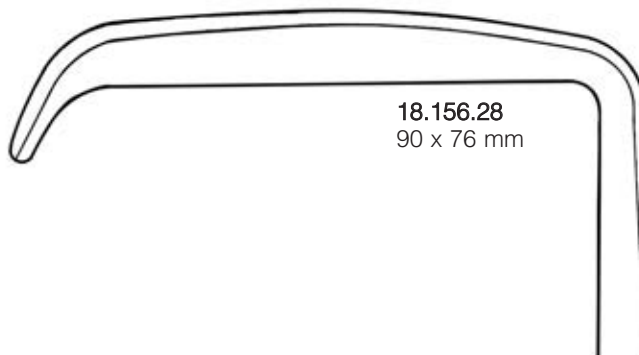

**18.156.28**  
90 x 76 mm



**Wundhaken**  
 Retractors  
 Ecarteurs  
 Separadores  
 Divaricatori

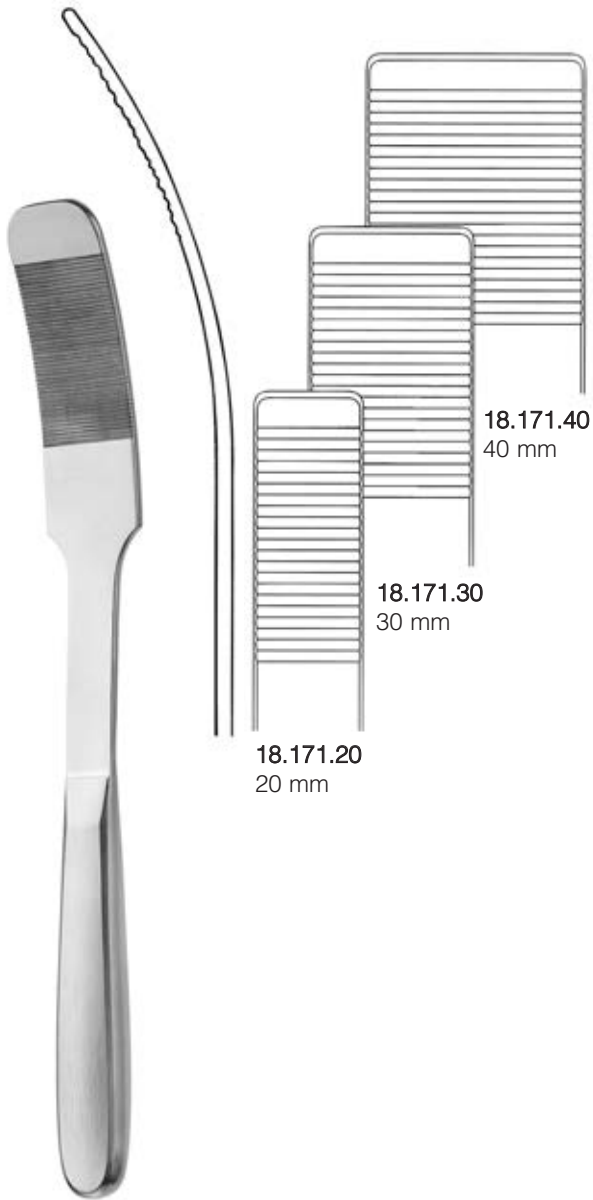

**KADER**  
28 cm/11"

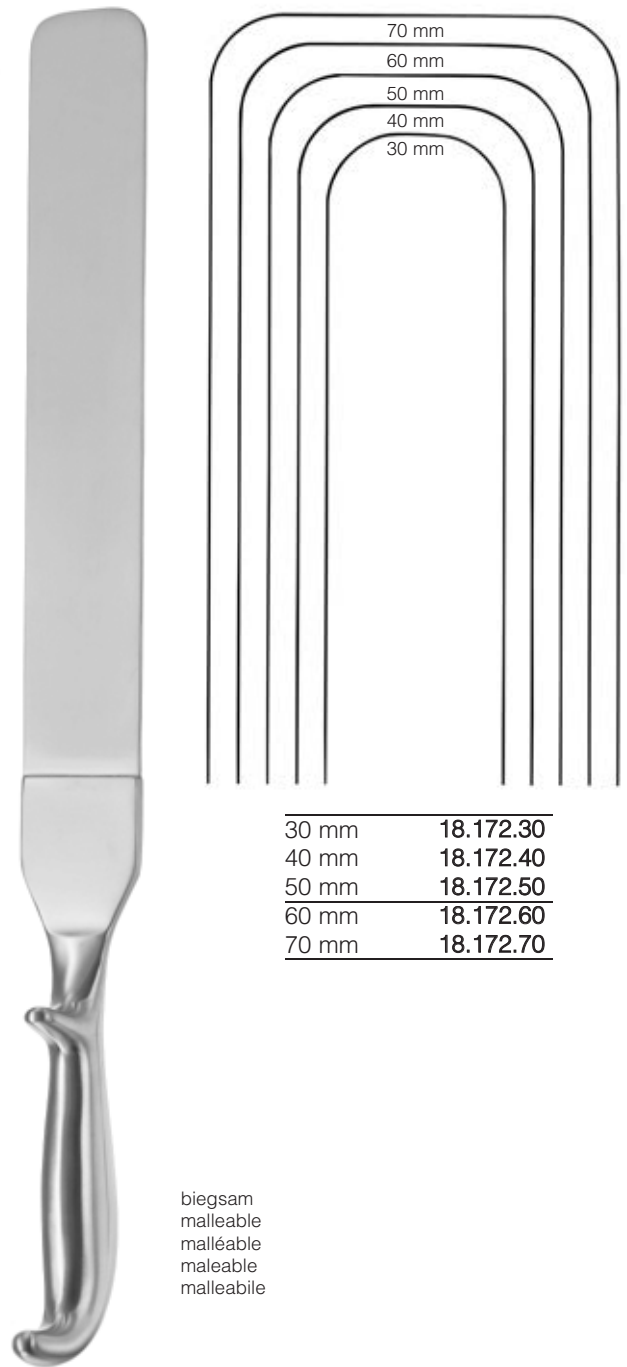

41 cm/16"

biegsam  
malleable  
malléable  
maleable  
malleabile

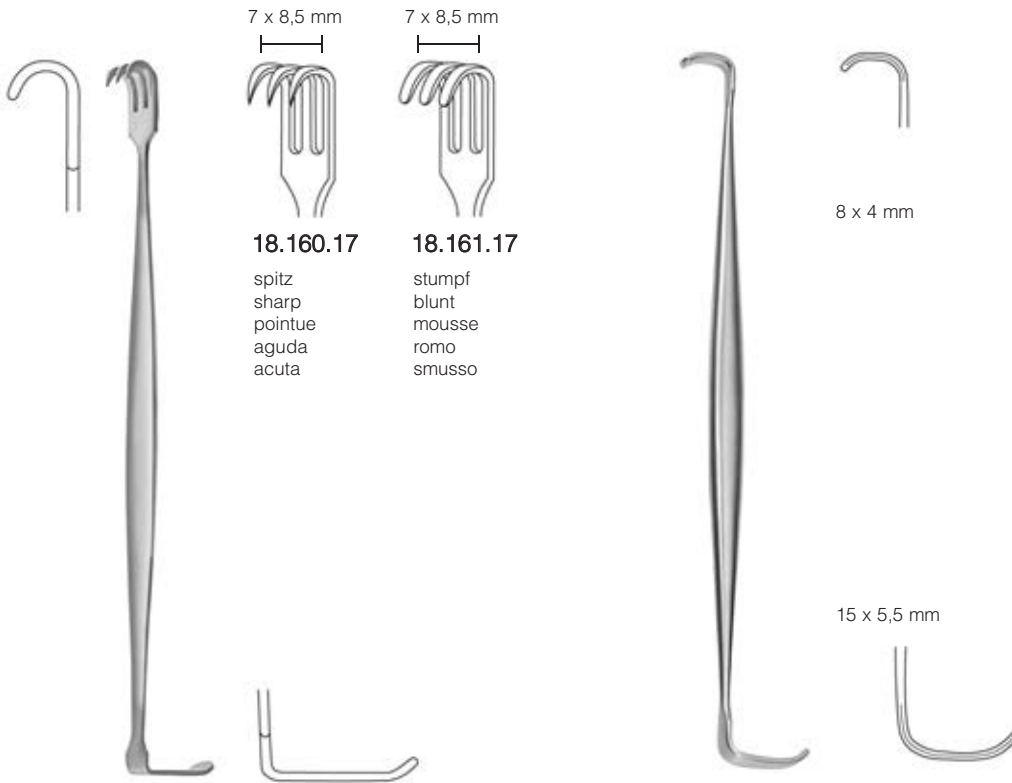

7 x 8,5 mm

7 x 8,5 mm

8 x 4 mm

15 x 5,5 mm

**18.160.17**

spitz  
sharp  
pointue  
aguda  
acuta

**18.161.17**

stumpf  
blunt  
mousse  
romo  
smusso

**SENN**  
17 cm/6¾"

**RAGNELL-DAVIS**  
**18.242.14**  
14 cm/5½"



**18.170.25**  
25 mm

**18.170.32**  
32 mm

**18.170.40**  
40 mm

**18.170.50**  
50 mm

biegsam  
malleable  
malléable  
maleable  
malleabile



**18.173.06**  
6.5 mm

**18.173.09**  
9.5 mm

**18.173.13**  
13 mm

**18.173.16**  
16 mm

**18.173.19**  
19 mm

**18.173.25**  
25 mm

biegsam  
malleable  
malléable  
maleable  
malleabile

**MARTIN**  
20 cm/8"



**18.174.17**  
20 cm/8"  
17/25 mm

**18.174.25**  
28 cm/11"  
25/30 mm

**18.174.37**  
30 cm/12"  
37/45 mm

biegsam  
malleable  
malléable  
maleable  
malleabile

**HABERER**



**Wundhaken**  
Retractors  
Ecarteurs  
Separadores  
Divaricatori

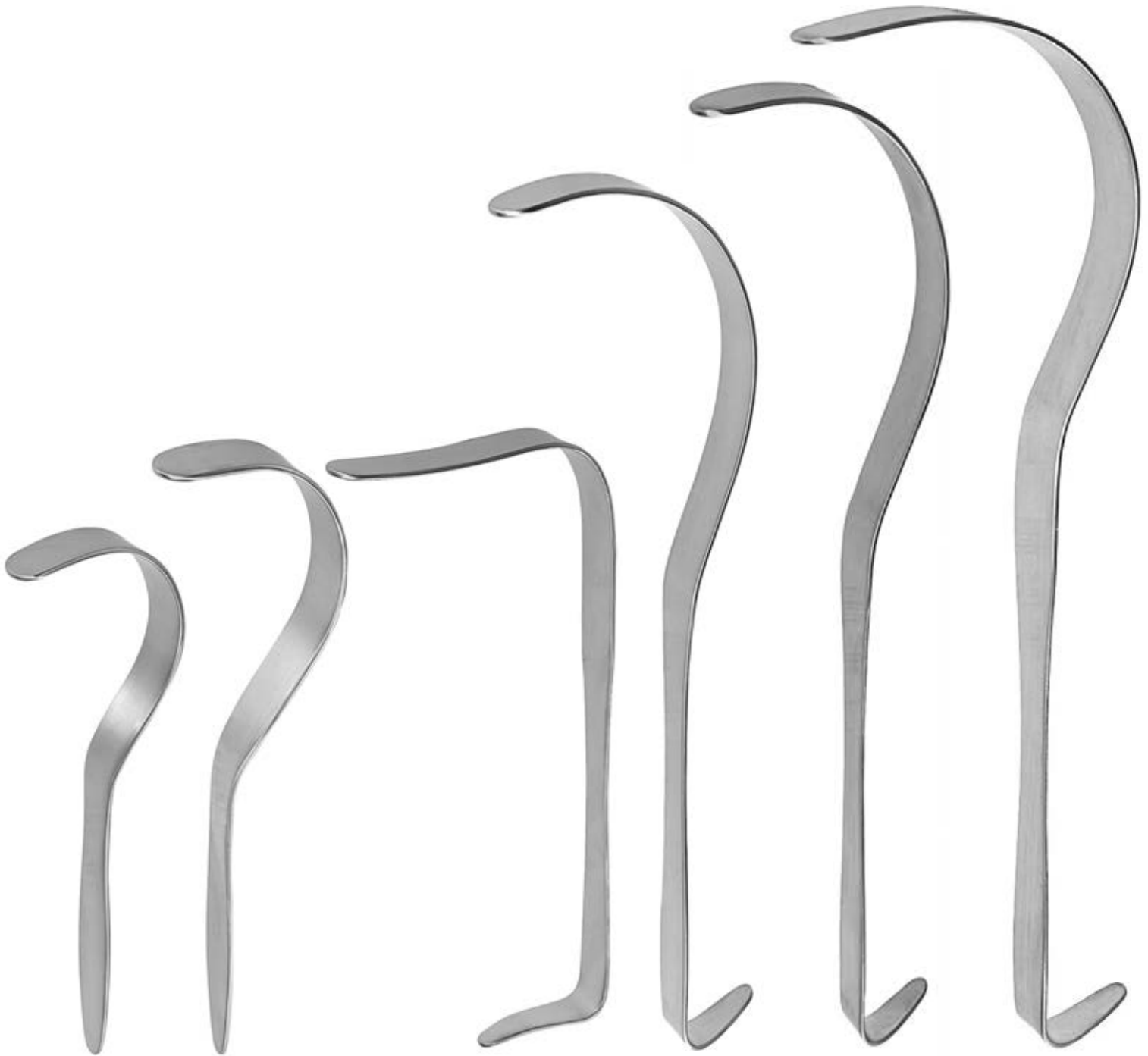

**DEAVER**  
**18.180.19**  
18 cm/7"  
19 mm

**DEAVER**  
**18.181.22**  
21,5 cm/8½"  
22 mm

**DEAVER**  
**18.181.25**  
23 cm/9"  
25 mm

**DEAVER**  
**18.183.25**  
30 cm/12"  
25 mm

**DEAVER**  
**18.185.25**  
33 cm/13"  
25 mm

**DEAVER**  
**18.187.25**  
36 cm/14"  
25 mm



DEAVER  
18.187.50  
30 cm/12"  
50 mm

DEAVER  
18.187.38  
30 cm/12"  
38 mm

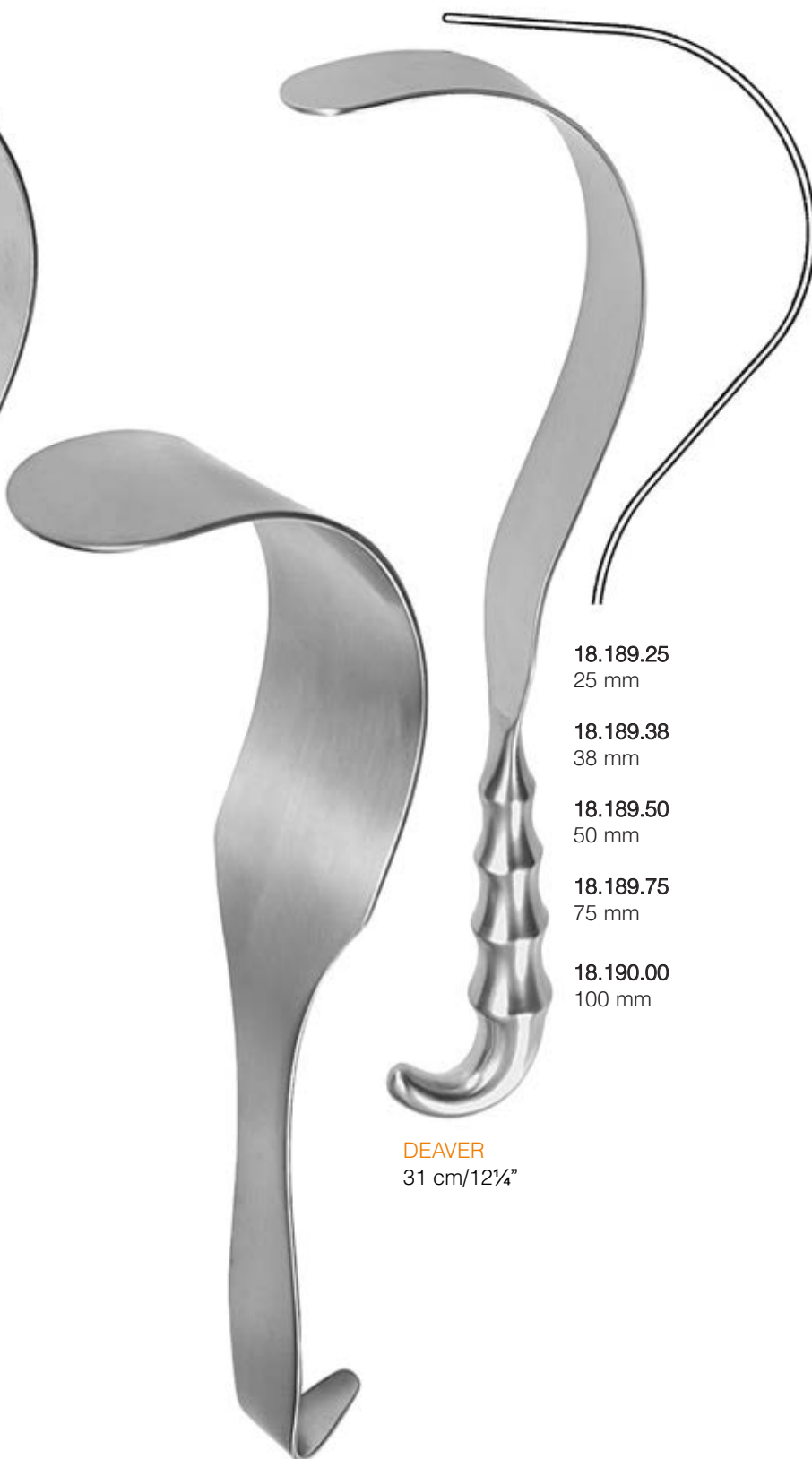

DEAVER  
31 cm/12¼"

18.189.25  
25 mm

18.189.38  
38 mm

18.189.50  
50 mm

18.189.75  
75 mm

18.190.00  
100 mm

DEAVER  
18.187.75  
30 cm/12"  
75 mm

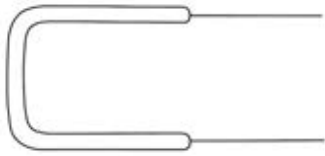

**HARRINGTON-BABY**  
**18.191.25**  
25 cm/10"  
24 x 70 mm



**HARRINGTON**  
29,5 cm/11½"

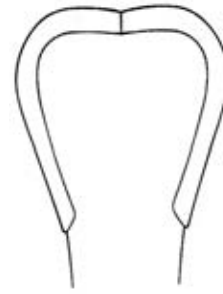

**18.191.40**  
123 x 45 mm

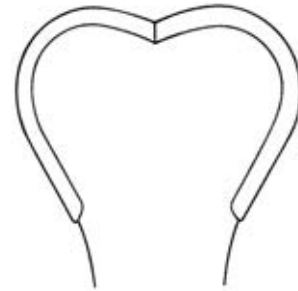

**18.191.62**  
123 x 64 mm

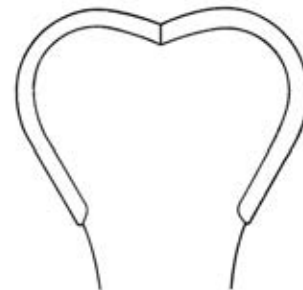

**18.191.64**  
175 x 64 mm



Hilären Haken  
Hilar hooks  
Crochets hilaires  
Ganchos hilares  
Ilari ganci

biegsamer Schaft  
flexible shaft  
tige malléable  
vástago flexible  
asta flessibile



18.224.04  
4 mm



18.224.08  
8 mm



18.224.11  
11 mm



18.224.13  
13 mm



18.224.15  
15 mm



18.224.17  
17 mm



18.224.20  
20 mm



18.224.23  
23 mm

GIL VERNET  
24 cm/9½"



CUSHING  
25 cm/10"



18.234.00  
11 x 14 mm



18.234.01  
13 x 18 mm



18.234.02  
15 x 22 mm



SCHOENBORN  
54.511.21  
21 cm/8¼"

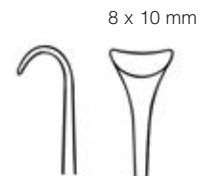

8 x 10 mm



CUSHING  
18.234.21  
21,5 cm/8½"

Venenhaken  
Vein retractor  
Écarteur à veines  
Gancho para venas  
Divaricatore per vene



**Wundhaken**  
Retractors  
Écarteurs  
Separadores  
Divaricatori



**18.230.08**  
8 mm



**18.230.12**  
12 mm



**18.230.16**  
16 mm



**18.230.10**  
10 mm



**18.230.14**  
14 mm



**18.230.18**  
18 mm



**DESMARRES**  
16,5 cm/6½"



**18.232.08**  
8 mm



**18.232.14**  
14 mm



**18.232.10**  
10 mm



**18.232.16**  
16 mm



**18.232.12**  
12 mm



**18.232.18**  
18 mm



**CUSHING**  
20 cm/8"



**18.233.08**  
8 mm



**18.233.14**  
14 mm



**18.233.10**  
10 mm



**18.233.16**  
16 mm



**18.233.12**  
12 mm



**18.233.18**  
18 mm























**CUSHING**  
24 cm/9½"





**VOLKMANN**  
21,5 cm/8½"

								spitz sharp pointue aguda acuta
18.280.01	18.280.02	18.280.03	18.280.04	18.280.06	18.280.08			
								stumpf blunt mousse romo smusso
18.281.01	18.281.02	18.281.03	18.281.04	18.281.06	18.281.08			
								halbscharf semi-sharp semi-pointue semi agudo semi acuto
18.279.01	18.279.02	18.279.03	18.279.04	18.279.06	18.279.08			



**Wundhaken**  
 Retractors  
 Écarteurs  
 Separadores  
 Divaricatori



**VOLKMANN**  
**18.282.01**  
 21,5 cm/8½"



**VOLKMANN**  
**18.283.01**  
 21,5 cm/8½"



**VOLKMANN**  
**18.283.03**  
 21,5 cm/8½"



**MURPHY**  
 19,5 cm/7¾"

9 mm



**18.284.02**

13 mm



**18.284.03**

18 mm



**18.284.04**

28 mm

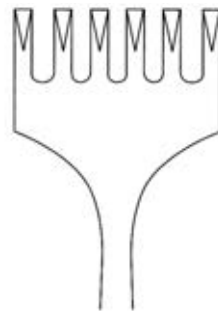

**18.284.06**

9 mm



spitz  
 sharp  
 pointue  
 agudo  
 acuto

9 mm



**18.285.02**

13 mm

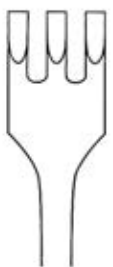

**18.285.03**

18 mm

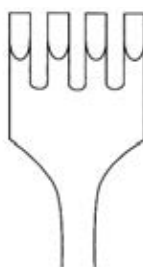

**18.285.04**

28 mm

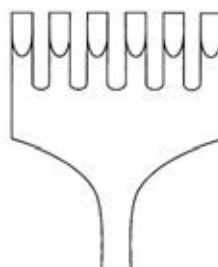

**18.285.06**

9 mm

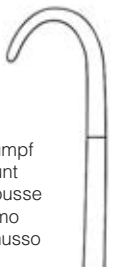

stumpf  
 blunt  
 mousse  
 romo  
 smusso



LANGENBECK  
22 cm/8¾"



18.312.01  
30 x 11 mm



18.312.02  
30 x 14 mm

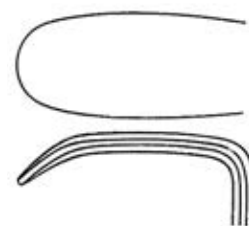

18.312.03  
30 x 16 mm

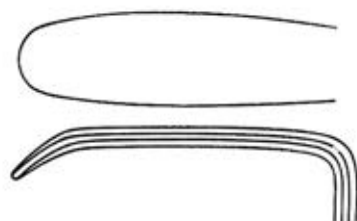

18.312.04  
40 x 11 mm

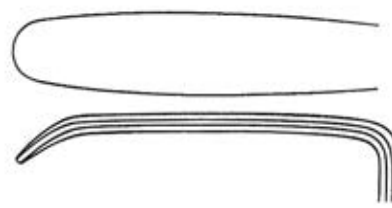

18.312.05  
50 x 11 mm



LANGENBECK  
18.317.21  
21 cm/8¼"  
85 x 15 mm

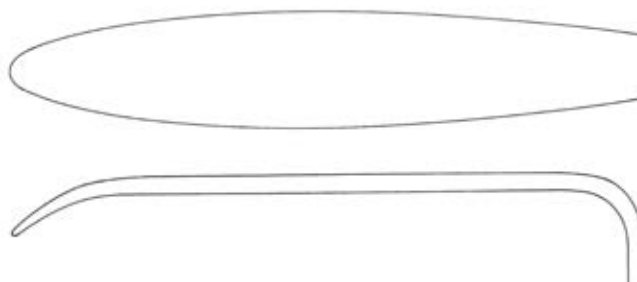



**Wundhaken**  
Retractors  
Écarteurs  
Separadores  
Divaricatori



**KOCHER**  
23 cm/9"

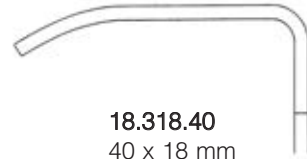

**18.318.40**  
40 x 18 mm

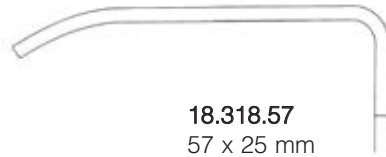

**18.318.57**  
57 x 25 mm

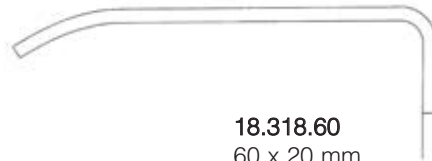

**18.318.60**  
60 x 20 mm

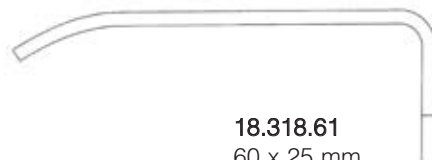

**18.318.61**  
60 x 25 mm



**18.318.75**  
75 x 30 mm

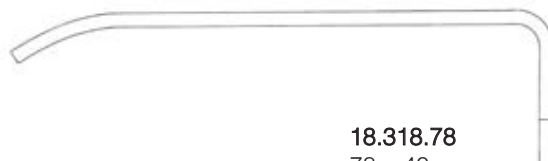

**18.318.78**  
78 x 40 mm



LANGENBECK

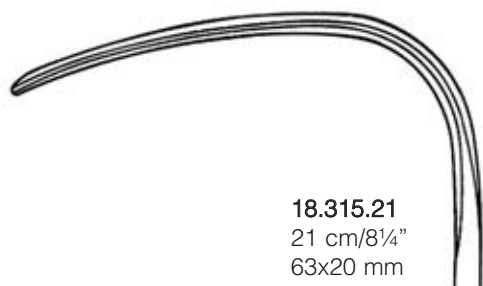

18.315.21  
21 cm/8¼"  
63x20 mm

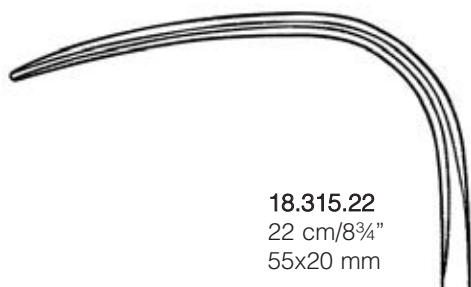

18.315.22  
22 cm/8¾"  
55x20 mm



KOENIG  
18 cm/7"



18.318.82  
13x13 mm



18.318.83  
13x16 mm



KOCHER  
19 cm/7½"



18.332.19  
19x12 mm



18.332.21  
21x14 mm



CUSHING-KOCHER  
18.341.18  
17,5 cm/7"  
10x10 mm



**KOCHER-LANGENBECK**  
22 cm/8½"



**18.342.01**  
25x6 mm



**18.342.02**  
35x8 mm



**18.342.03**  
35x11 mm



**18.342.04**  
35x15 mm



**18.342.05**  
40x11 mm

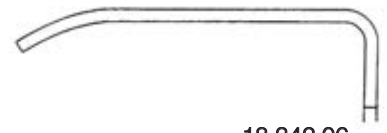

**18.342.06**  
55x11 mm

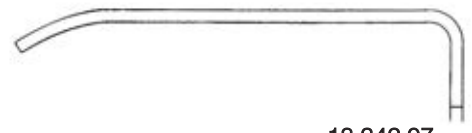

**18.342.07**  
70x14 mm



**18.342.08**  
80x12 mm



**18.342.09**  
80x16 mm



ZENKER

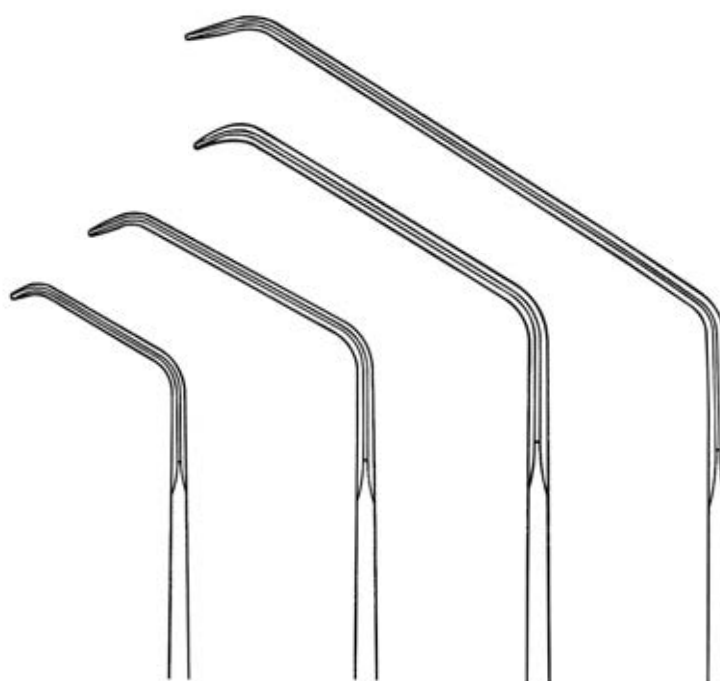

**18.343.35**  
24 cm/9½"  
36x8 mm

**18.343.60**  
25,5 cm/10½"  
60x12 mm

**18.343.75**  
27,5 cm/10¾"  
75x12 mm

**18.343.12**  
29 cm/11½"  
120x12 mm



**Wundhaken**  
 Retractors  
 Écarteurs  
 Separadores  
 Divaricatori



**KOCHER**  
 22 cm/8¾"

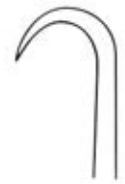
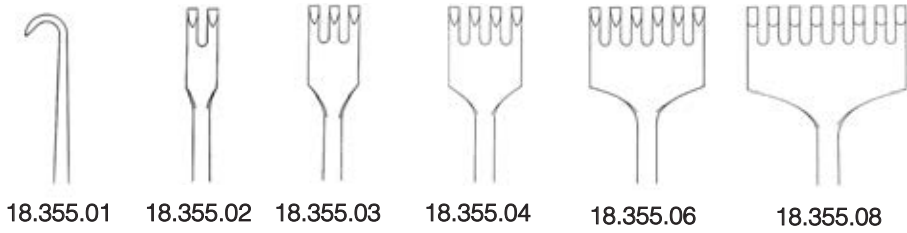

spitz  
 sharp  
 pointue  
 aguda  
 acuta

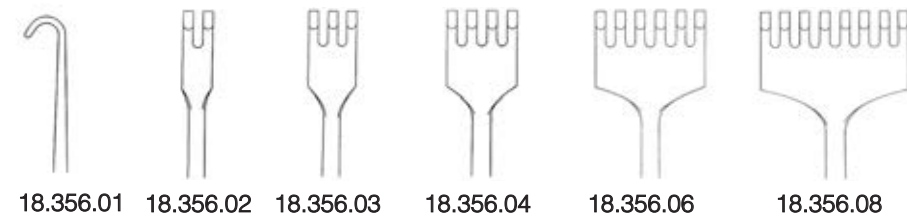

stumpf  
 blunt  
 mousse  
 romo  
 smusso

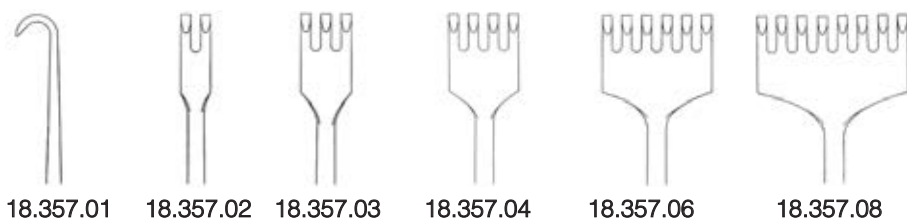

halbscharf  
 semi-sharp  
 semi-pointue  
 semi agudo  
 semi acuto





**18.364.40**  
40 x 40 mm



**18.364.50**  
45 x 50 mm



**18.364.60**  
50 x 60 mm



**18.364.70**  
70 x 70 mm



**ISRAEL**  
25 cm/10"

stumpf  
blunt  
mousse  
romo  
smusso

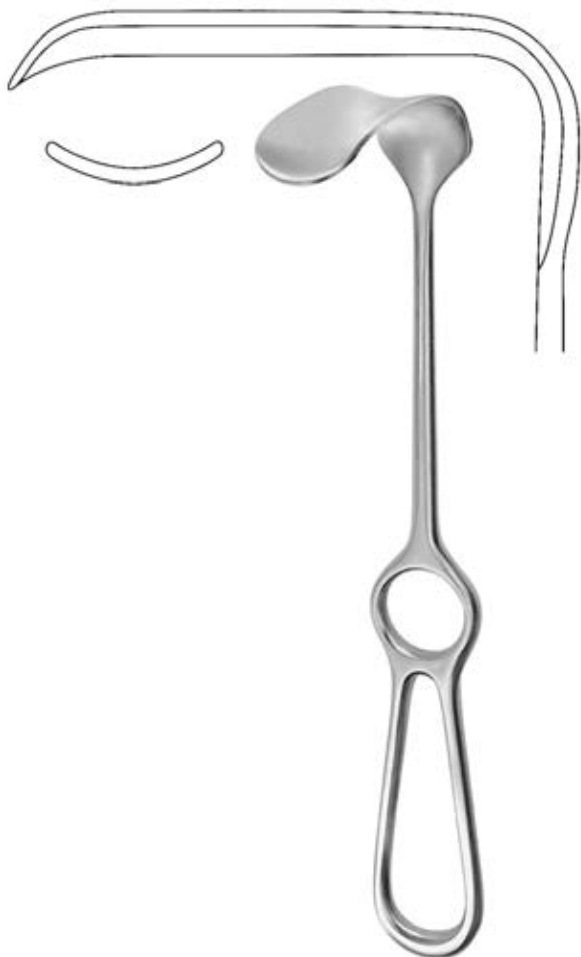

**KOCHER**  
**18.372.22**  
22,5 cm/8¾"  
70 x 25 mm

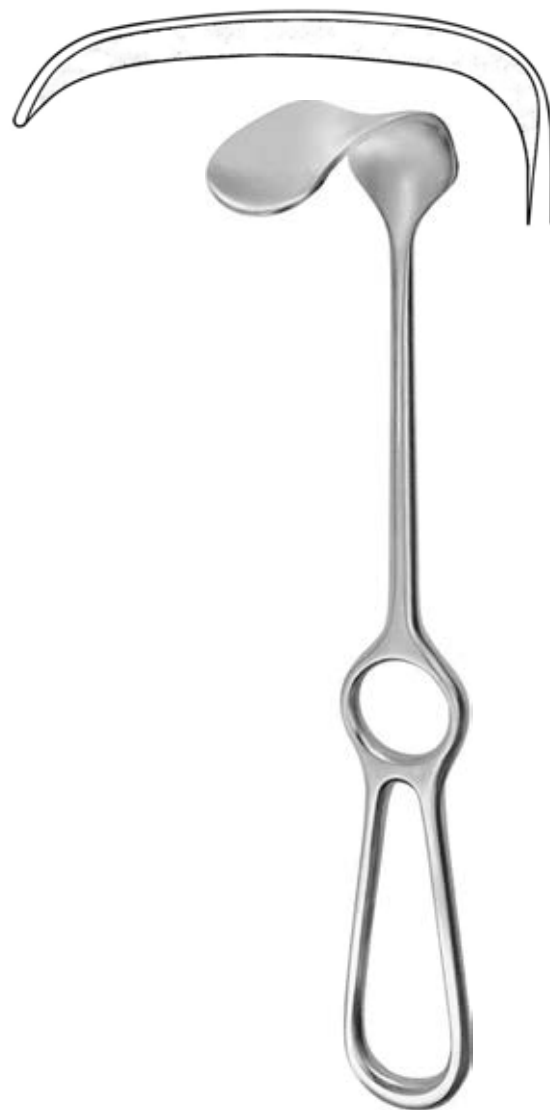

**KOCHER**  
25 cm/10"  
**18.374.45** 80 x 45 mm  
**18.374.55** 80 x 55 mm  
**18.374.65** 80 x 65 mm  
**18.374.99** 110 x 45 mm

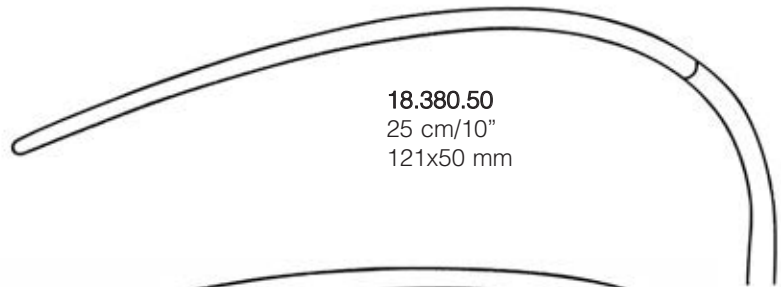

**18.380.50**  
25 cm/10"  
121x50 mm

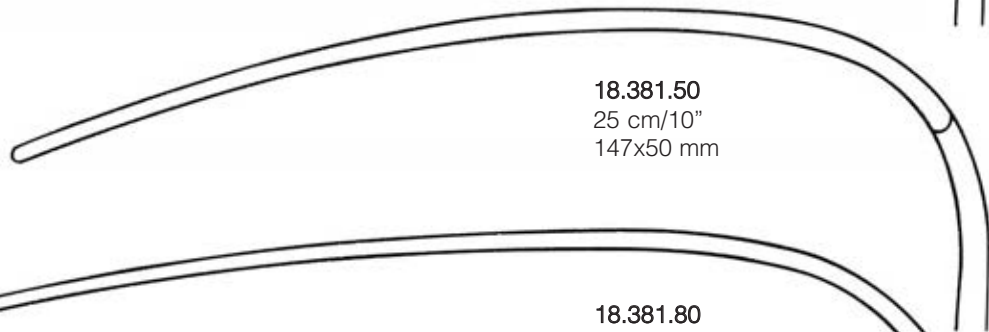

**18.381.50**  
25 cm/10"  
147x50 mm



**18.381.80**  
26 cm/10¼"  
180x50 mm

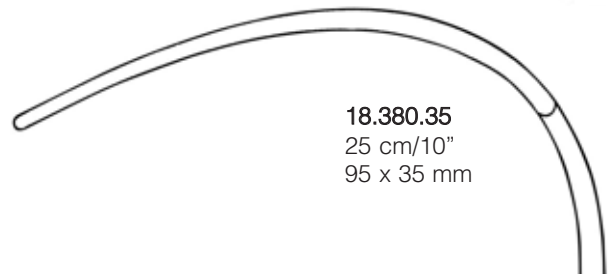
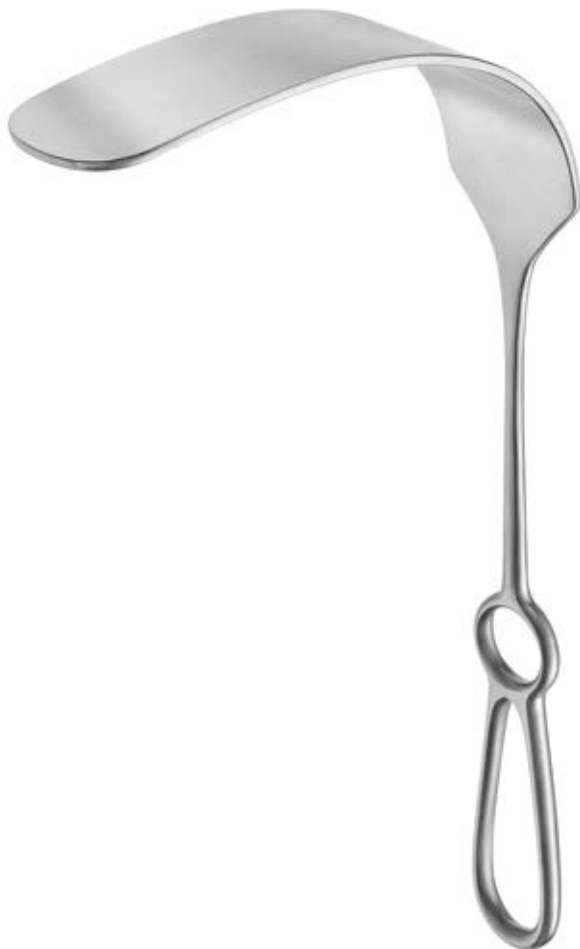

**18.380.35**  
25 cm/10"  
95 x 35 mm

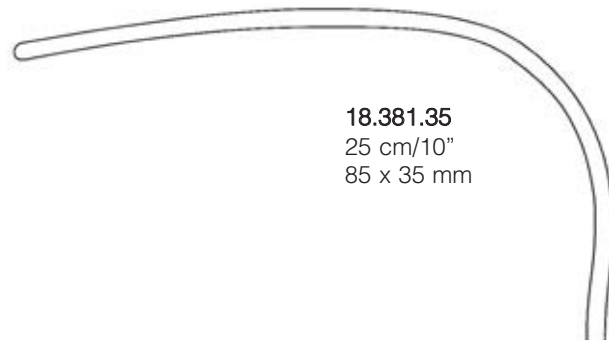

**18.381.35**  
25 cm/10"  
85 x 35 mm

MIKULICZ



**KOCHER WAGNER**  
28 cm/11"



**18.383.15**  
22 x 15 mm

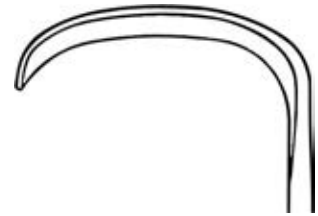

**18.383.20**  
38 x 20 mm

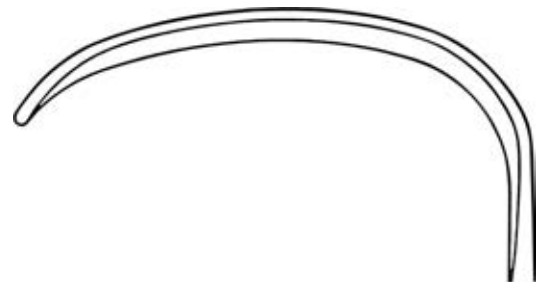

**18.383.25**  
67 x 25 mm

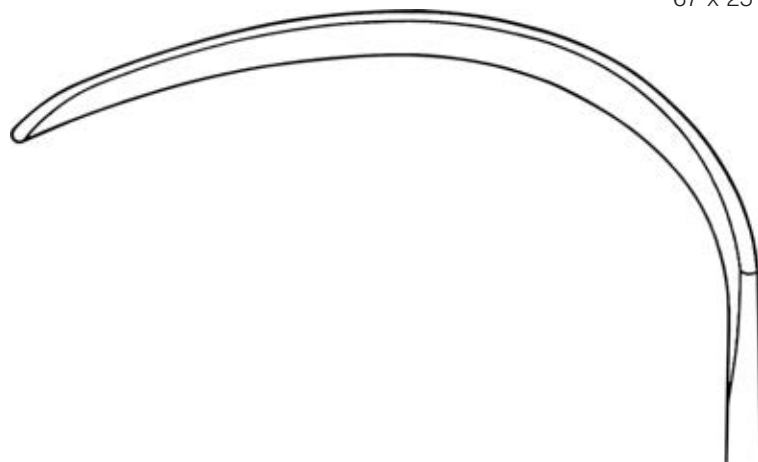

**18.383.35**  
100 x 35 mm

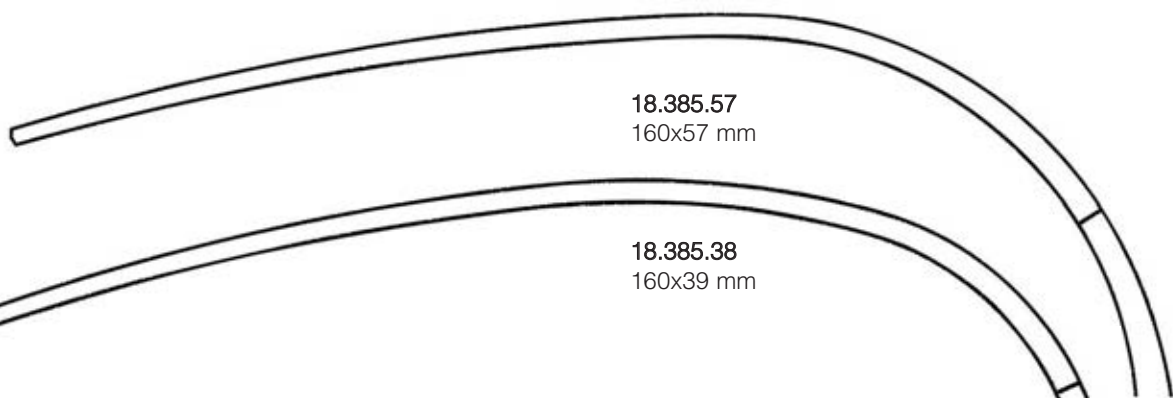

**18.385.57**  
160x57 mm

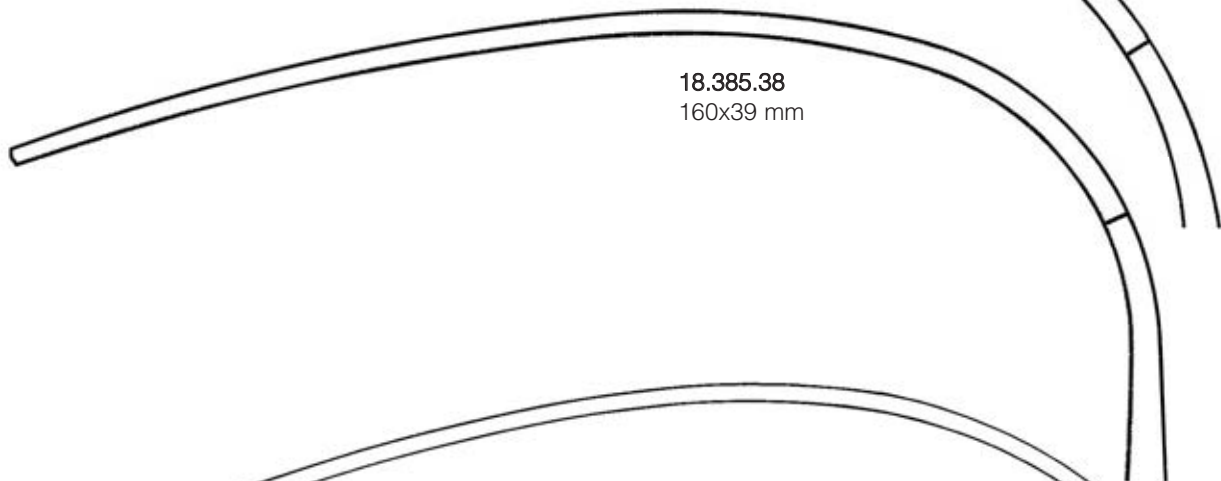

**18.385.38**  
160x39 mm



**18.386.57**  
190x57 mm

**18.386.38**  
190x39 mm



**KELLY**  
26 cm/10¼"



LERICHE



KOERTE  
18.393.28  
28 cm/11"  
120 x 47 mm



18.480.27  
115x26 mm

18.480.22  
115x22 mm

SIMON  
28 cm/11"

MARTIN  
18.398.25  
25 cm/10"  
105x27 mm



**Wundhaken**  
Retractors  
Écarteurs  
Separadores  
Divaricatori



**18.488.23**  
25 x 80 mm

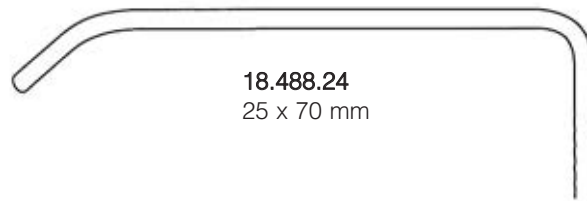

**18.488.24**  
25 x 70 mm

**HIBBS**  
**18.488.25**  
24 cm/9½"  
**18.488.23 + 18.488.24**





**18.490.22**  
82 x 22 mm

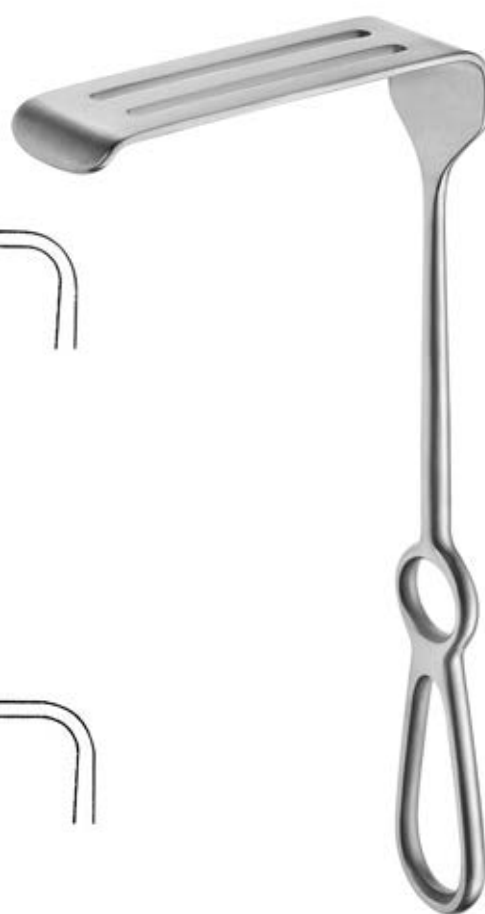

**CORYLLOS**  
24 cm/9½"



**18.490.43**  
108 x 43 mm



**18.490.65**  
115 x 65 mm



**Wundhaken**  
Retractors  
Écarteurs  
Separadores  
Divaricatori



**18.496.50**  
75 x 50 mm

**18.496.90**  
75 x 90 mm



**DAVIDSON (Scapula)**  
19,5 cm/7<sup>3</sup>/<sub>4</sub>"



**SAUERBRUCH**  
**18.492.25**  
26 cm/10<sup>1</sup>/<sub>4</sub>"  
130x38 mm



IMA Epikardialspreizer  
 IMA Epicardial retractor  
 IMA Écarteur épicaldial  
 IMA Separador epicardiaco  
 IMA Divaricatore epicardiaco

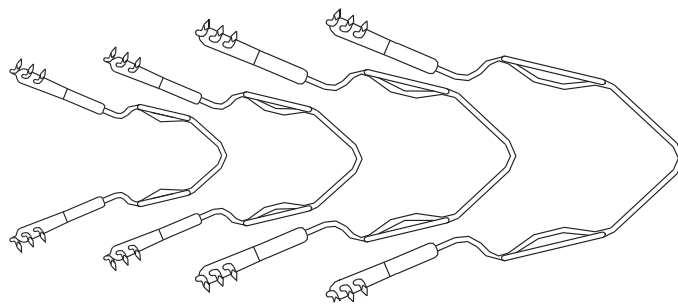

spitz  
 sharp  
 pointue  
 aguda  
 acuta

**18.601.25**  
 25 mm

mini  
 mini  
 mini  
 mini  
 mini

**18.601.28**  
 28 mm

klein  
 small  
 petit  
 pequeño  
 piccolo

**18.601.38**  
 38 mm

mittel  
 medium  
 moyen  
 mediano  
 medio

**18.601.54**  
 54 mm

groß  
 large  
 grand  
 grande  
 grande



**FINSEN**

2 x 3



**18.610.05**  
 5 cm/2"

spitz  
 sharp  
 pointu  
 aguda  
 acuta

2 x 3



**18.611.05**  
 5 cm/2"

stumpf  
 blunt  
 mousse  
 romo  
 smusso

3 x 4



**18.610.07**  
 7 cm/2¾"

spitz  
 sharp  
 pointu  
 aguda  
 acuta

3 x 4



**18.611.07**  
 7 cm/2¾"

stumpf  
 blunt  
 mousse  
 romo  
 smusso



### Wundspreizer

Wound spreaders, self-retaining

Écarteurs autostatiques

Separadores autostáticos

Divaricatori autostatici



ALM



**18.620.07**  
7 cm/2¾"

scharf  
sharp  
pointu  
agudo  
acuto



**18.620.10**  
10 cm/4"

scharf  
sharp  
pointu  
agudo  
acuto



**18.621.07**  
7 cm/2¾"

stumpf  
blunt  
mousse  
romo  
smusso



**18.621.10**  
10 cm/4"

stumpf  
blunt  
mousse  
romo  
smusso



ALLPORT  
**18.624.10**  
9,5 cm/3¾"



WEITLANER

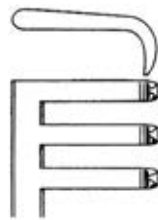

**18.650.10**  
11,5 cm/4½"  
2 : 3

scharf  
sharp  
pointu  
agudo  
acuto

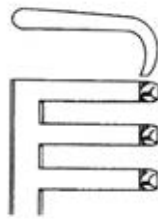

**18.651.10**  
11,5 cm/4½"  
2 : 3

stumpf  
blunt  
mousse  
romo  
smusso



**HENLEY**  
 16,5 cm/6½"

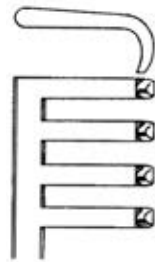

**18.660.16**  
 3 : 4

stumpf  
 blunt  
 mousse  
 romo  
 smusso

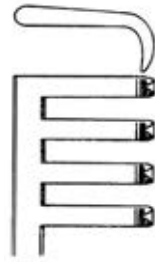

**18.661.16**  
 3 : 4

scharf  
 sharp  
 pointu  
 agudo  
 acuto

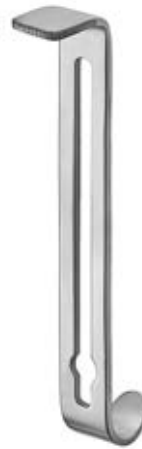

**18.661.17**  
 16x19 mm  
 5/8"x3/4"



**18.661.18**  
 16x25 mm  
 5/8"x1"



**18.661.19**  
 16x32 mm  
 5/8"x1¼"

mit Mittelvalven  
 18.661.17 - 18.661.19

with central blades  
 18.661.17 - 18.661.19

avec lames centrales  
 18.661.17 - 18.661.19

con valvas centrales  
 18.661.17 - 18.661.19

con lamierine centrali  
 18.661.17 - 18.661.19



**WEITLANER**

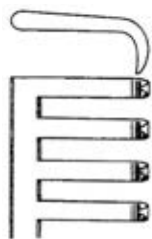

**18.670.14**  
 14 cm/5½"  
 3 : 4

scharf  
 sharp  
 pointu  
 agudo  
 acuto

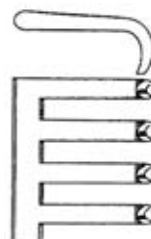

**18.671.14**  
 14 cm/5½"  
 3 : 4

stumpf  
 blunt  
 mousse  
 romo  
 smusso

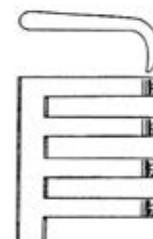

**18.670.16**  
 16,5 cm/6½"  
 3 : 4

scharf  
 sharp  
 pointu  
 agudo  
 acuto

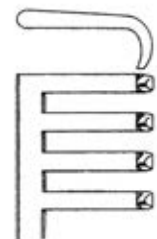

**18.671.16**  
 16,5 cm/6½"  
 3 : 4

stumpf  
 blunt  
 mousse  
 romo  
 smusso



### Wundspreizer

Wound spreaders, self-retaining

Écarteurs autostatiques

Separadores autostáticos

Divaricatori autostatici

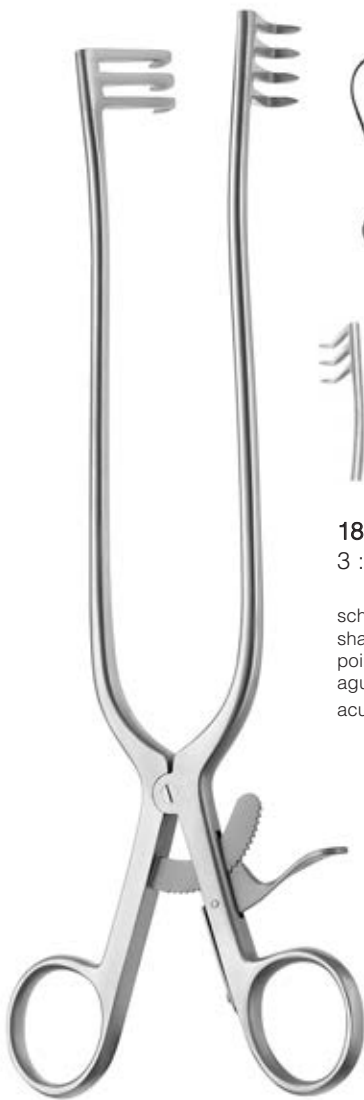

**WEITLANER**  
24 cm/9½"

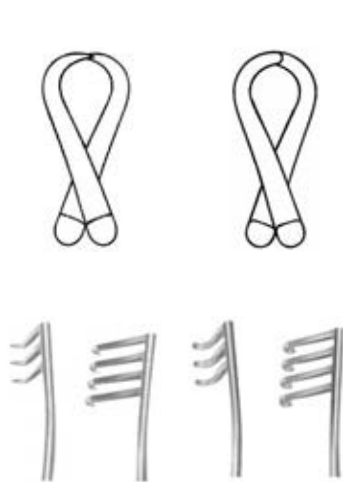

**18.670.25**  
3 : 4

scharf  
sharp  
pointu  
agudo  
acuto

**18.671.25**  
3 : 4

stumpf  
blunt  
mousse  
romo  
smusso



**WEITLANER**  
25,5 cm/10"

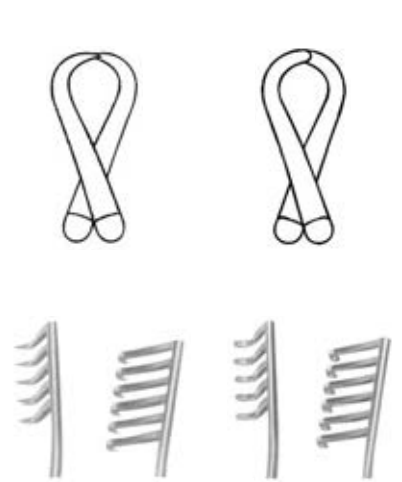

**18.670.26**  
5 : 6

scharf  
sharp  
pointu  
agudo  
acuto

**18.671.26**  
5 : 6

stumpf  
blunt  
mousse  
romo  
smusso



**WEITLANER**  
 20 cm/8"

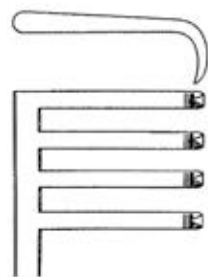

**18.670.20**  
 3 : 4

scharf  
 sharp  
 pointu  
 agudo  
 acuto

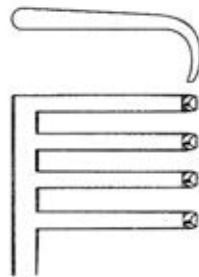

**18.671.20**  
 3 : 4

stumpf  
 blunt  
 mousse  
 romo  
 smusso



**ADSON-BABY**  
 16,5 cm/6½"

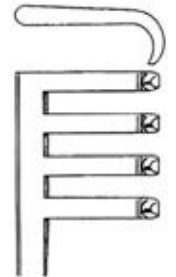

**18.684.16**  
 3 : 4

scharf  
 sharp  
 pointu  
 agudo  
 acuto



## Wundspreizer

Wound spreaders, self-retaining

Écarteurs autostatiques

Separadores autostáticos

Divaricatori autostatici

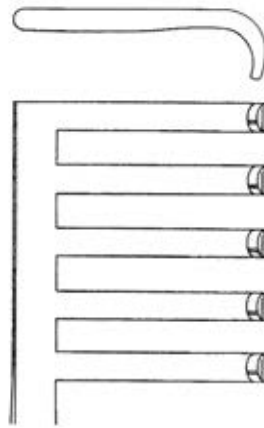
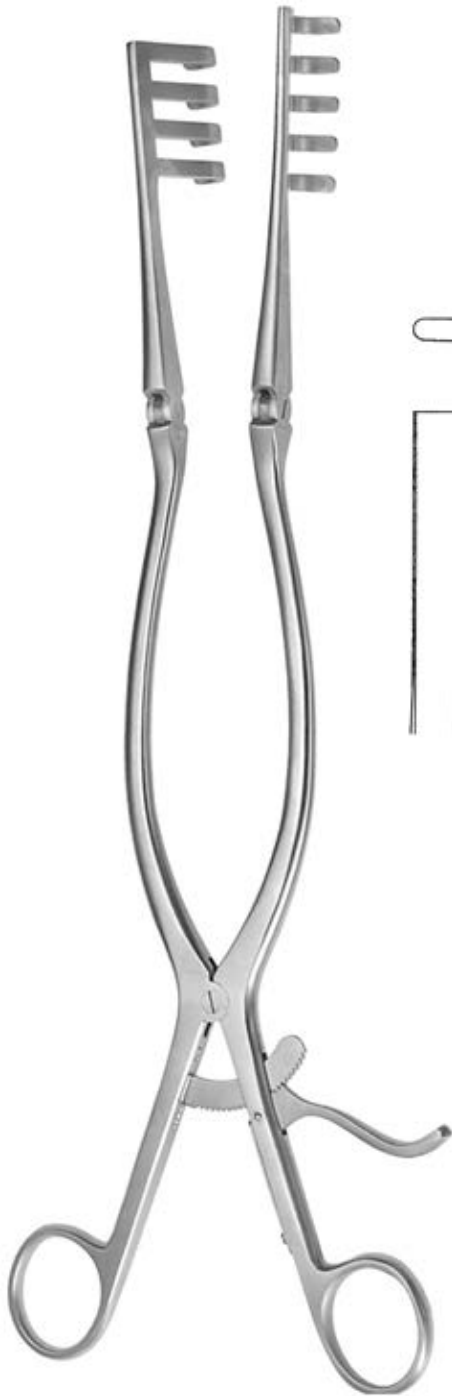

4 : 5

halbscharf  
semi-sharp  
semi-pointue  
semi agudo  
semi acuto

**BECKMANN-ADSON**  
**18.686.32**  
32 cm/12¾"

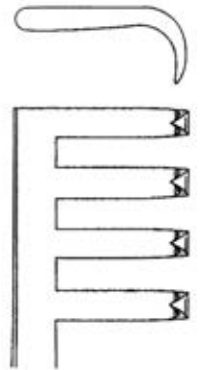

4 : 4

scharf  
sharp  
pointu  
agudo  
acuto

**BECKMANN**  
**18.690.31**  
31 cm/30½"





13 cm/5"	<b>18.694.13</b>	<b>18.695.13</b>
16,5 cm/6½"	<b>18.694.16</b>	<b>18.695.16</b>
20 cm/8"	<b>18.694.20</b>	<b>18.695.20</b>
26,5 cm/10½"	<b>18.694.25</b>	

scharf	stumpf
sharp	blunt
pointu	mousse
agudo	romo
acuto	smusso

**CONE**



**DARLING**  
**18.696.18**  
 18 cm/7"



**DARLING**  
**18.698.18**  
 18 cm/7"



## Wundspreizer

Wound spreaders, self-retaining

Écarteurs autostatiques

Separadores autostáticos

Divaricatori autostatici

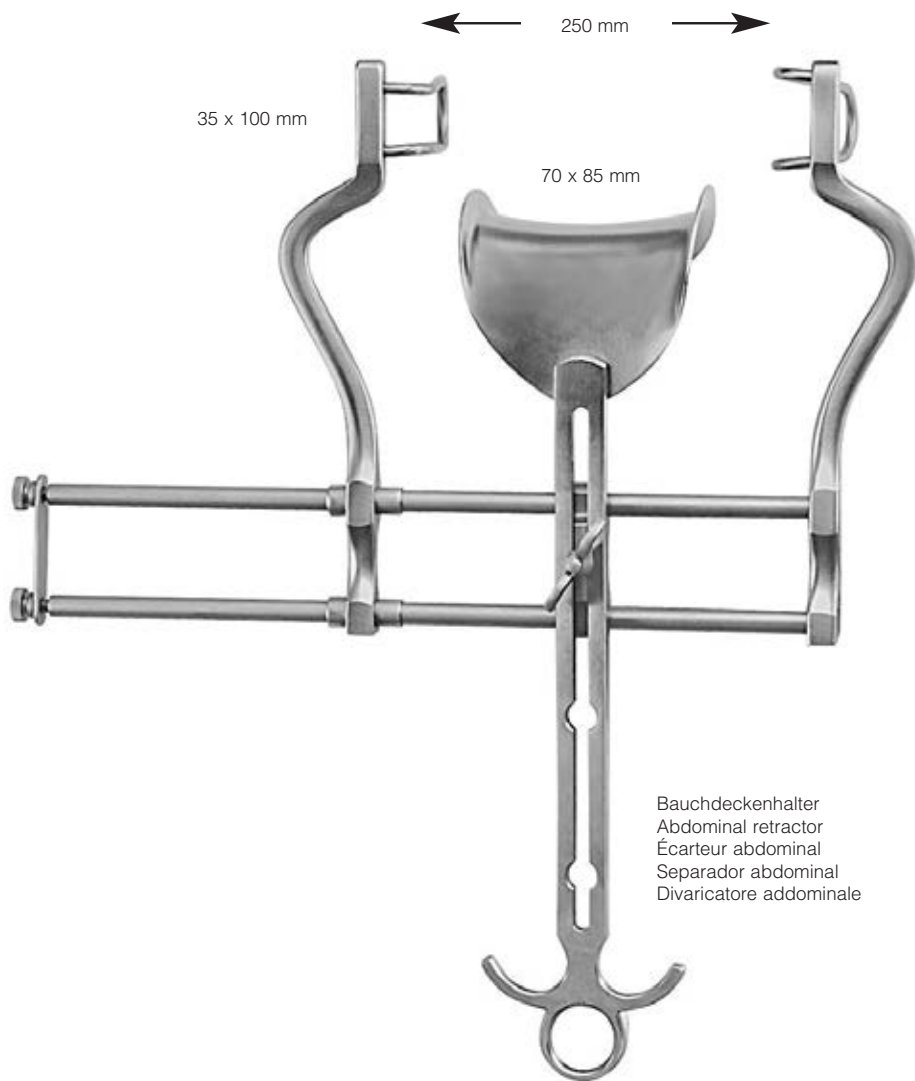

Bauchdeckenhalter  
Abdominal retractor  
Écarteur abdominal  
Separador abdominal  
Divaricatore addominale

**BALFOUR**  
**18.764.25**  
25 cm/10"

**18.765.25**

Rahmen, allein  
Frame, only  
Cadre, seul  
Cuadro, suelto  
Telaio, solo



**SELLORS**  
**56.280.19**  
 20 cm/8"

Rippensperrer und -kontraktor mit drehbaren Klauen

Rib spreader and contractor with swivel blades

Écarteur et rapprocheur pour costaux avec valves rotatives

Separador y contractor costal con garras girables

Divaricatore ed approssimatore costale con valve orientabili



**BAILEY-BABY**  
**56.282.14**  
 15,5 cm/6"

für Kinder  
 for children  
 pour enfants  
 para niños  
 per bambini



**BAILEY**  
**56.284.20**  
 20 cm/8"

für Erwachsene  
 for adults  
 pour adultes  
 para adultos  
 per adulti



**BAILEY-GIBBON**  
**56.286.20**  
 20 cm/8"

für Erwachsene  
 for adults  
 pour adultes  
 para adultos  
 per adulti



**LEMMON**  
**56.288.18**  
 18 cm/7"

für Erwachsene  
 for adults  
 pour adultes  
 para adultos  
 per adulti

**56.288.14**  
 14 cm/5½"

für Kinder  
 for children  
 pour enfants  
 para niños  
 per bambini



### Lungenspatel

Lung spatulas  
Spatules pulmonaires  
Espátulas pulmonares  
Spatole per pulmone

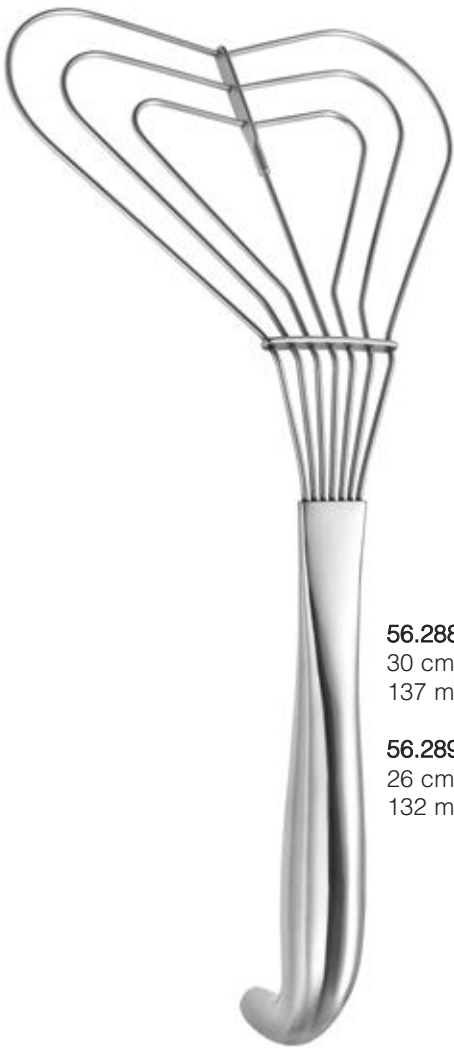

**56.288.30**  
30 cm/12"  
137 mm

**56.289.26**  
26 cm/10¼"  
132 mm



**56.289.28**  
28 cm/11"  
30 mm

**56.289.30**  
30 cm/12"  
40 mm

**56.289.31**  
32 cm/12¾"  
54 mm

**56.289.32**  
32 cm/12¾"  
65 mm

ALLISON

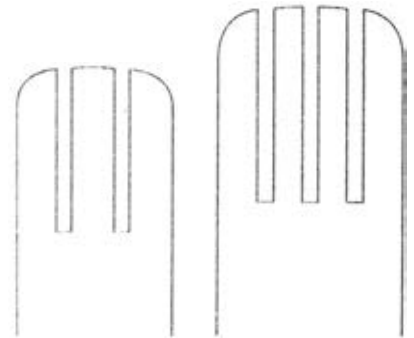

**56.297.01**  
20 mm  
Fig. 1

**56.297.02**  
24 mm  
Fig. 2



SEMB  
25 cm/10"



**COOLEY**  
**56.293.01**  
25 cm/9¾"  
48x48 mm

rechts  
right  
à droite  
derecho  
destro



**COOLEY**  
**56.293.02**  
25 cm/9¾"  
48x48 mm

rechts, gerieft  
right, serrated  
à droite, cannelé  
derecho, estriado  
destro, seghettato



**COOLEY**  
**56.293.03**  
27,5 cm/10¾"  
30x48 mm

links  
left  
à gauche  
izquierdo  
sinistro



## Atriumhaken

Atrium retractors  
Écarteurs pour oreillette  
Separadores atrium  
Divaricatori per atrio



COOLEY modif. STRUCK

**56.293.04**  
25 cm/9<sup>3</sup>/<sub>4</sub>"  
45x35 mm

gerieft  
serrated  
cannelé  
estriado  
seghettato



COOLEY modif. STRUCK

**56.293.05**  
25 cm/9<sup>3</sup>/<sub>4</sub>"  
45x30 mm

gerieft  
serrated  
cannelé  
estriado  
seghettato



**ROSS**  
25,5 cm/10"

flexibler Schaft  
flexible shaft  
tige malléable  
vástago flexible  
asta flessibile



**18.236.01**  
16 x 15 mm  
Fig. 1



**18.236.02**  
23 x 13 mm  
Fig. 2



**18.236.03**  
25 x 18 mm  
Fig. 3



**18.236.04**  
29 x 13 mm  
Fig. 4



**18.236.05**  
29 x 29 mm  
Fig. 5



**18.236.06**  
21 x 35 mm  
Fig. 6



## Aortahaken

Aorta retractors

Écarteurs pour l'aorte

Separadores para aorta

Divaricatori per aorta



flexibler Schaft  
flexible shaft  
tige malléable  
vástago flexible  
asta flessibile

**BOROWSKI**  
27 cm/10<sup>3</sup>/<sub>4</sub>"



**56.295.01**  
17x21 mm



**56.295.04**  
24x27 mm



**56.295.02**  
16x23 mm



**56.295.05**  
28x20 mm



**56.295.03**  
20x25 mm



**56.295.06**  
28x29 mm



# 06

◆ NADELHALTER

NEEDLE HOLDERS

PORTE-AIGUILLES

PORTA-AGUJAS

PORT'AGHI

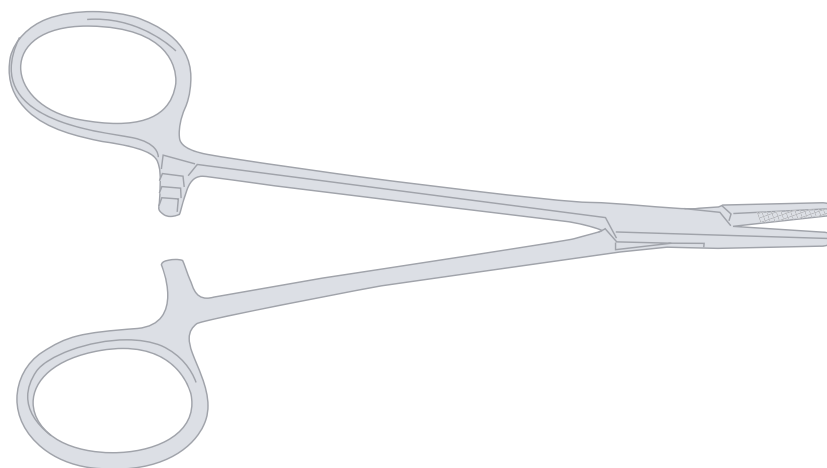



### Nadelhalter mit Hartmetalleinlagen

Needle holders with tungsten carbide inserts  
 Porte-aiguilles avec inserts en carbure tungstène  
 Porta-agujas con plaquitas de carburo tungsteno  
 Portaghi con morsi in carburo tungsteno

mit TC-Einsätzen  
 with TC inserts  
 avec mors TC  
 con bocas TC  
 con morso TC





Folgende Hartmetalleinlagen werden für **DIMEDA TC/diamantiertes Maul** Nadelhalter verwendet:

The **DIMEDA TC/diamond dusted** needle holders are equipped with the following tungsten carbide inserts:

Les inserts suivants en metal dur sont utilisés pour les porte-aiguilles **DIMEDA TC/diamantée**:

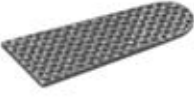
Las porta-agujas **DIMEDA TC/diamantada** están equipadas con las siguientes plaquitas de carburo de tungsteno:

I portaghi **DIMEDA TC/diamantato** dispongono delle seguenti placche in carburo di tungsteno:

		Teilung Structure Structure Estradura Struttura	empfohlen für Nahtmaterial recommended for suture material recommandé pour matériel de suture recomendado para suturas raccomodato per materiale di suture
	normal regular régulière regular regolare	0,5 mm	> 3/0
	mini mini mini mini mini	0,4 mm	4/0 - 6/0
	mikro micro micro micro micro	0,3 mm	5/0 - 8/0
	diamantiert diamond dusted diamanté diamantada diamantato	--	7/0 - 10/0
	glatt smooth lisse lisa piatta	--	7/0 - 10/0



mit TC-Einsätzen  
with TC inserts  
avec mors TC  
con bocas TC  
con morso TC



**24.110.12**  
12 cm/4<sup>3</sup>/<sub>4</sub>"

mit Rille  
with groove  
avec un sillon  
con ranura  
con scanalatura



DERF



**24.120.12**  
12,5 cm/5"

längsgerieftes Maul  
jaw with longitudinal serrations  
mors avec rainures longitudinales  
boca con estrías longitudinales  
morso con strie longitudinali



DERF  
**24.114.12**  
12 cm/4<sup>3</sup>/<sub>4</sub>"



0,4  
Miniprofil  
Mini profile  
Profil mini  
Perfil mini  
Profilo mini



glattes Maul  
smooth jaw  
mors lisse  
boca lisa  
morso piatto



WEBSTER

11,5 cm/4<sup>1</sup>/<sub>2</sub>" **24.128.11**  
13 cm/5<sup>1</sup>/<sub>8</sub>" **24.128.13**



glattes Maul  
smooth jaw  
mors lisse  
boca lisa  
morso piatto



WEBSTER

12 cm/4<sup>3</sup>/<sub>4</sub>" **24.129.12**  
13 cm/5<sup>1</sup>/<sub>8</sub>" **24.129.13**



**Nadelhalter**  
Needle holders  
Porte-aiguilles  
Porta-agujas  
Port'aghi

mit TC-Einsätzen  
with TC inserts  
avec mors TC  
con bocas TC  
con morso TC



**24.134.13**

glattes Maul  
smooth jaw  
mors lisse  
boca lisa  
morso piatto

**HALSEY**  
13 cm/5 $\frac{1}{8}$ "



**24.144.13**

0,4  
Miniprofil  
Mini profile  
Profil mini  
Perfil mini  
Profilo mini

mit aufgebogenem Daumenring  
with offset ring  
avec anneau courbe  
con anillo acodado  
con anelli sfalsati



**24.147.13**

0,4  
Miniprofil  
Mini profile  
Profil mini  
Perfil mini  
Profilo mini

**NEIVERT**  
13 cm/5 $\frac{1}{8}$ "



**24.147.13L**

für Linkshänder  
for left-handers  
pour des gauchers  
para zurdos  
per mancino

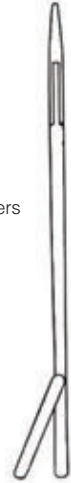

0,5  
Normalprofil  
Regular profile  
Profil regulaire  
Perfil regular  
Profilo regolare

**BAUMGARTNER**  
12,5 cm/5" **24.154.12**  
14 cm/5 $\frac{1}{2}$ " **24.154.14**



**24.164.15**  
15 cm/6"



**24.164.15L**  
15 cm/6"



**24.164.18**  
18 cm/7"



**24.164.20**  
20 cm/7 $\frac{3}{4}$ "

**CRILE WOOD**

für Linkshänder  
for left-handers  
pour des gauchers  
para zurdos  
per mancino



mit TC-Einsätzen  
with TC inserts  
avec mors TC  
con bocas TC  
con morso TC



BABY CRILE WOOD  
**24.168.15**  
15 cm/6"



0,4

Miniprofil  
Mini profile  
Profil mini  
Perfil mini  
Profilo mini



MAYO HEGAR



**24.184.14**  
14 cm/5½"



**24.184.16**  
16 cm/6¼"



**24.184.18**  
18 cm/7"



**24.184.20**  
20 cm/8"



**24.184.24**  
24 cm/9½"



**24.184.26**  
26 cm/10¼"



**24.184.30**  
30 cm/12"

0,5

Normalprofil  
Regular profile  
Profil regulare  
Perfil regular  
Profilo regolare



**24.186.16**  
16 cm/6¼"



**24.186.18**  
18 cm/7"

glattes Maul  
smooth jaw  
mors lisse  
boca lisa  
morso piatto



**24.214.15**  
15 cm/6"



**24.214.18**  
18 cm/7"



**24.214.20**  
20 cm/8"



**24.214.23**  
24 cm/9"



**24.214.26**  
26 cm/10¼"



**24.214.31**  
31 cm/12½"



**24.214.37**  
37 cm/14¾"

0,4

Miniprofil  
Mini profile  
Profil mini  
Perfil mini  
Profilo mini



DE BAKEY  
**24.212.16**  
16,5 cm/6½"



DE BAKEY



**Nadelhalter**  
Needle holders  
Porte-aiguilles  
Porta-agujas  
Port'aghi

mit TC-Einsätzen  
with TC inserts  
avec mors TC  
con bocas TC  
con morso TC

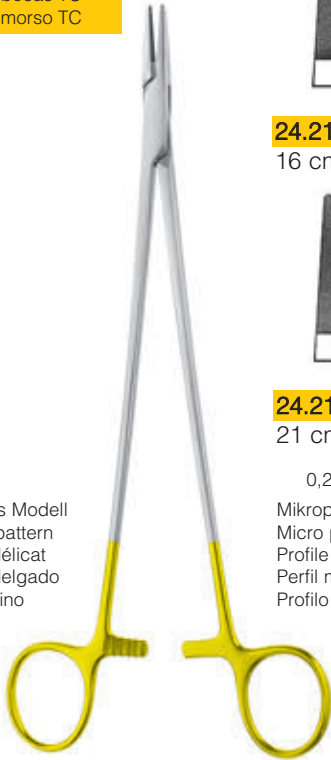

DE BAKEY

schlankes Modell  
delicate pattern  
modèle délicat  
modelo delgado  
modello fino

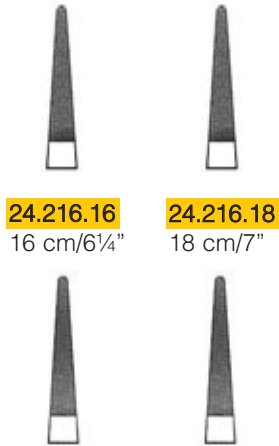

**24.216.16**  
16 cm/6¼"

**24.216.18**  
18 cm/7"

**24.216.21**  
21 cm/8¼"

**24.216.23**  
23 cm/9"

0,2  
Mikroprofil  
Micro profile  
Profilo micro  
Perfil micro  
Profilo micro

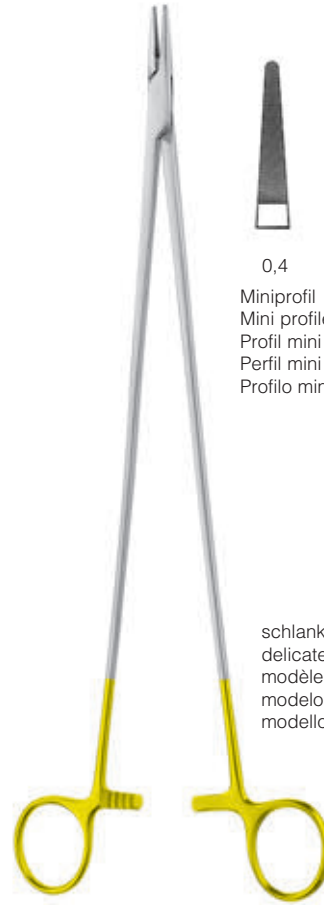

DE BAKEY  
**24.216.31**  
31 cm/12½"



0,4  
Miniprofil  
Mini profile  
Profil mini  
Perfil mini  
Profilo mini

schlankes Modell  
delicate pattern  
modèle délicat  
modelo delgado  
modello fino



RYDER

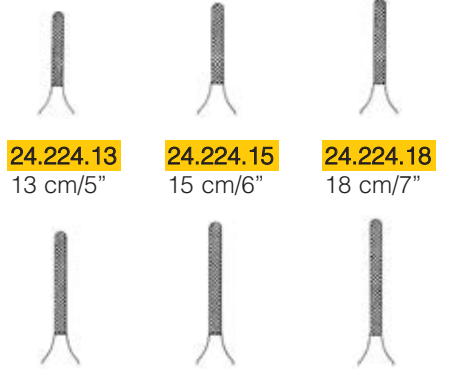

**24.224.13**  
13 cm/5"

**24.224.15**  
15 cm/6"

**24.224.18**  
18 cm/7"

**24.224.20**  
20 cm/8"

**24.224.23**  
23 cm/9"

**24.224.26**  
26 cm/10¼"

0,4  
Miniprofil  
Mini profile  
Profil mini  
Perfil mini  
Profilo mini



RYDER



**24.222.15**  
15 cm/6"

**24.222.18**  
18cm/7"



**24.222.20**  
20 cm/8"

**24.222.23**  
23 cm/9"

glattes Maul  
smooth jaw  
mors lisse  
boca lisa  
morso piatto

schlankes Modell  
slender pattern  
modèle délicat  
modelo delgado  
modello fino



mit TC-Einsätzen  
with TC inserts  
avec mors TC  
con bocas TC  
con morso TC

schlankes Modell  
slender pattern  
modèle délicat  
modelo delgado  
modello fino

0,3  
Mikroprofil  
Micro profile  
Profil micro  
Perfil micro  
Profilo micro

**24.276.14**  
14 cm/5½"

**24.276.18**  
18 cm/7"

**24.276.20**  
20 cm/7¾"

**24.276.23**  
23 cm/9"

**HEGAR-VASCULAR**

schlankes Modell  
slender pattern  
modèle délicat  
modelo delgado  
modello fino

0,3  
Mikroprofil  
Micro profile  
Profil micro  
Perfil micro  
Profilo micro

**24.280.14**  
14 cm/5½"

**24.280.18**  
17,5 cm/7"

**24.280.20**  
20 cm/7¾"

**24.280.23**  
23 cm/9"

**Microvascular**

schlankes Modell  
slender pattern  
modèle délicat  
modelo delgado  
modello fino

0,3  
Mikroprofil  
Micro profile  
Profil micro  
Perfil micro  
Profilo micro

**24.226.13**  
12,5 cm/5"

**24.226.15**  
15,5 cm/6"

**24.226.18**  
17,5 cm/7"

**24.226.20**  
20 cm/8"

**24.226.23**  
22,5 cm/9"

**24.226.26**  
26 cm/10¼"

**RYDER Vascular**



**Nadelhalter**  
 Needle holders  
 Porte-aiguilles  
 Porta-agujas  
 Port'aghi

mit TC-Einsätzen  
 with TC inserts  
 avec mors TC  
 con bocas TC  
 con morso TC



HEANEY



**24.245.21**  
 20 cm/8"



**24.245.26**  
 26 cm/10¼"

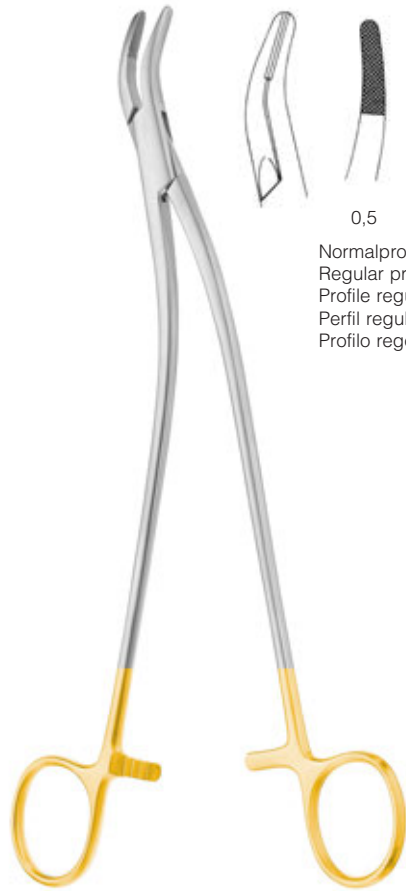

STRATTE  
**24.334.23**  
 23 cm/9"

0,5

Normalprofil  
 Regular profile  
 Profile regulare  
 Perfil regular  
 Profilo regolare

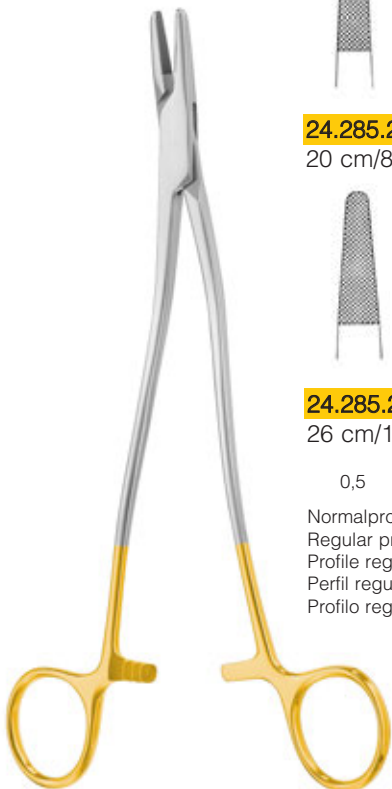

BOZEMANN



**24.285.20**  
 20 cm/8"



**24.285.24**  
 24 cm/9½"



**24.285.26**  
 26 cm/10¼"



**24.285.30**  
 30 cm/12"

0,5

Normalprofil  
 Regular profile  
 Profile regulare  
 Perfil regular  
 Profilo regolare



WANGENSTEEN  
**24.264.27**  
 27,5 cm/10¾"





**FINOCHIETTO**  
**24.315.27**  
26,5 cm/10½"



**SAROT**

**24.324.18**  
17,5 cm/7"

**24.324.26**  
26 cm/10¼"



**TOENNIS**  
**24.364.18**  
18 cm/7"

mit TC-Einsätzen  
with TC inserts  
avec mors TC  
con bocas TC  
con morso TC

0,5

Normalprofil  
Regular profile  
Profilo regolare  
Profile regulare  
Perfil regular



**MATHIEU**

**24.374.14**  
14 cm/5½"

**24.374.17**  
17 cm/6¾"

**24.374.20**  
20 cm/8"

**24.374.24**  
24 cm/9½"

0,5

Normalprofil  
Regular profile  
Profilo regolare  
Profile regulare  
Perfil regular



**MATHIEU**

**24.394.14**  
14 cm/5½"

**24.394.17**  
17 cm/6¾"

**24.394.20**  
20 cm/7¾"

schlankes Modell  
slender pattern  
modèle délicat  
modelo delgado  
modello fino

0,5

Normalprofil  
Regular profile  
Profilo regolare  
Profile regulare  
Perfil regular



**24.486.20**  
19,5 cm/7¾"



**Nadelhalter**  
Needle holders  
Porte-aiguilles  
Porta-agujas  
Port'aghi

mit TC-Einsätzen  
with TC inserts  
avec mors TC  
con bocas TC  
con morso TC



**OLSEN HEGAR-mini**  
12 cm/4¾"



**24.408.12**

glattes Maul  
smooth jaw  
mors lisse  
boca lisa  
morso piatto



**24.410.12**



**24.416.12**

glattes Maul  
smooth jaw  
mors lisse  
boca lisa  
morso piatto



**24.418.12**

0,3  
Mikroprofil  
Micro profile  
Profil micro  
Perfil micro  
Profilo micro



**24.414.12**

0,3  
Mikroprofil  
Micro profile  
Profil micro  
Perfil micro  
Profilo micro

schlankes Modell  
delicate pattern  
modèle délicat  
modelo delgado  
modello fino



**OLSEN HEGAR**  
12 cm/4¾"

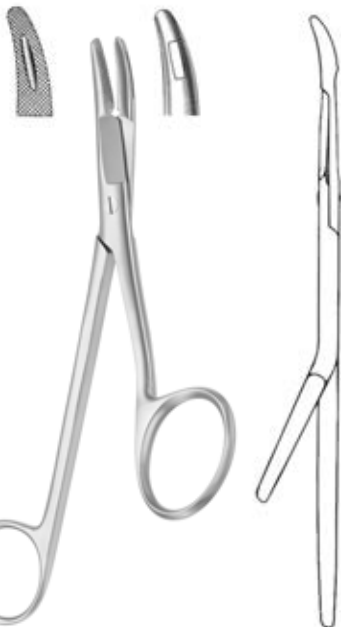

**GILLIES**  
**24.430.16**  
16 cm/6¼"

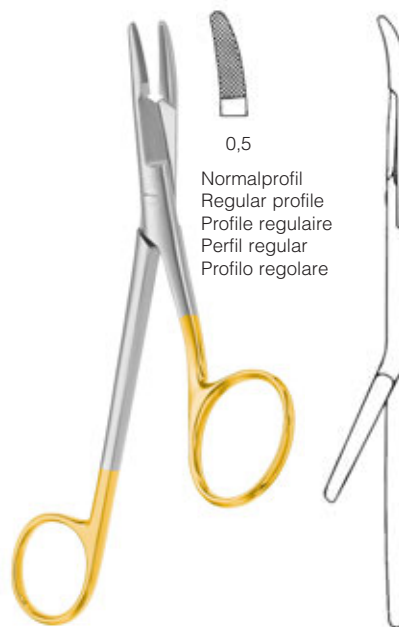

**GILLIES**  
**24.434.16**  
16 cm/6¼"



0,5

Normalprofil  
Regular profile  
Profilo regolare  
Perfil regular  
Profilo regolare





ohne Sperre  
 without catch  
 sans crémaillère  
 sin cierre  
 senza serratura



12 cm/4¾"	<b>24.652.12</b>	<b>24.655.12</b>	<b>24.661.12</b>
15 cm/6"	<b>24.654.15</b>	<b>24.655.15</b>	
18,5 cm/7¼"	<b>24.656.18</b>	<b>24.653.18</b>	



mit Sperre  
 with catch  
 avec crémaillère  
 con cierre  
 con serratura



12 cm/4¾"	<b>24.662.12</b>	<b>24.667.12</b>	<b>24.663.12</b>
15 cm/6"	<b>24.664.15</b>	<b>24.667.15</b>	
18,5 cm/7¼"	<b>24.666.18</b>	<b>24.667.18</b>	
23 cm/9"		<b>24.667.23</b>	



**Mikro-Nadelhalter**

Micro needle holders

Micro porte-aiguilles

Micro porta-agujas

Micro port'aghi



24.650.10

24.651.10



ohne Sperre  
without catch  
sans crémaillère  
sin cierre  
senza serratura

**BARRAQUER**  
10 cm/4"



24.636.10

24.637.10



mit Sperre  
with catch  
avec crémaillère  
con cierre  
con serratura

**BARRAQUER-TROUTMAN**  
10 cm/4"



24.672.09

24.673.09



ohne Sperre  
without catch  
sans crémaillère  
sin cierre  
senza serratura

**CASTROVIEJO**  
9 cm/3½"



24.674.09

24.675.09



mit Sperre  
with catch  
avec crémaillère  
con cierre  
con serratura

**CASTROVIEJO**  
9 cm/3½"



24.670.14 24.671.14

mit Sperre  
with catch  
avec crémaillère  
con cierre  
con serratura

**CASTROVIEJO**  
14 cm/5½"



24.676.14 24.677.14

ohne Sperre  
without catch  
sans crémaillère  
sin cierre  
senza serratura

**CASTROVIEJO**  
14 cm/5½"



**Mikro-Nadelhalter**  
 Micro needle holders  
 Micro porte-aiguilles  
 Micro porta-agujas  
 Micro port'aghi

mit TC-Einsätzen  
 with TC inserts  
 avec mors TC  
 con bocas TC  
 con morso TC



	glattes Maul smooth jaw mors lisse boca lisa morso piatto		Mikroprofil Micro profile Profil micro Perfil micro Profilo micro		diamantiertes Maul diamond-coated jaw mors diamanté boca diamantada morso diamantato	
mit Sperre with catch avec crémaillère con cierre con serratura						
			0,3	0,3		
14,5 cm/5 <sup>3</sup> / <sub>4</sub> "	24.674.14	24.675.14	24.678.14	24.679.14	24.682.14	24.683.14
18 cm/7"	24.674.18	24.675.18	24.678.18	24.679.18	24.682.18	24.683.18
21 cm/8 <sup>1</sup> / <sub>4</sub> "	24.674.21	24.675.21	24.678.21	24.679.21	24.682.21	24.683.21
23 cm/9"	24.674.23	24.675.23	24.678.23	24.679.23		

	glattes Maul smooth jaw mors lisse boca lisa morso piatto		Mikroprofil Micro profile Profil micro Perfil micro Profilo micro		diamantiertes Maul diamond-coated jaw mors diamanté boca diamantada morso diamantato	
ohne Sperre without catch sans crémaillère sin cierre senza serratura						
			0,3	0,3		
14,5 cm/5 <sup>3</sup> / <sub>4</sub> "	24.694.14	24.695.14	24.698.14	24.699.14	24.696.14	24.697.14
18 cm/7"	24.694.18	24.695.18	24.698.18	24.699.18	24.696.18	24.697.18
21 cm/8 <sup>1</sup> / <sub>4</sub> "	24.694.21	24.695.21	24.698.21	24.699.21	24.696.21	24.697.21
23 cm/9"	24.694.23	24.695.23	24.698.23	24.699.23		

CASTROVIEJO-  
 JACOBSON



mit TC-Einsätzen  
 with TC inserts  
 avec mors TC  
 con bocas TC  
 con morso TC



TOLEDO

	glattes Maul smooth jaw mors lisse boca lisa morso piatto		Mikroprofil Micro profile Profil micro Perfil micro Profilo micro		diamantiertes Maul diamond-coated jaw mors diamanté boca diamantada morso diamantato	
mit Sperre with catch avec crémaillère con cierre con serratura						
			0,3	0,3		
14,5 cm/5 <sup>3</sup> / <sub>4</sub> "	24.774.14	24.775.14	24.778.14	24.779.14	24.782.14	24.783.14
18 cm/7"	24.774.18	24.775.18	24.778.18	24.779.18	24.782.18	24.783.18
21 cm/8 <sup>1</sup> / <sub>4</sub> "	24.774.21	24.775.21	24.778.21	24.779.21	24.782.21	24.783.21
23 cm/9"	24.774.23	24.775.23	24.778.23	24.779.23	24.782.23	24.783.23

	glattes Maul smooth jaw mors lisse boca lisa morso piatto		Mikroprofil Micro profile Profil micro Perfil micro Profilo micro		diamantiertes Maul diamond-coated jaw mors diamanté boca diamantada morso diamantato	
ohne Sperre without catch sans crémaillère sin cierre senza serratura						
			0,3	0,3		
14,5 cm/5 <sup>3</sup> / <sub>4</sub> "	24.794.14	24.795.14	24.798.14	24.799.14	24.796.14	24.797.14
18 cm/7"	24.794.18	24.795.18	24.798.18	24.799.18	24.796.18	24.797.18
21 cm/8 <sup>1</sup> / <sub>4</sub> "	24.794.21	24.795.21	24.798.21	24.799.21	24.796.21	24.797.21
23 cm/9"	24.794.23	24.795.23	24.798.23	24.799.23	24.796.23	24.797.23

- ergonomischer Griff
- ansprechendes Design
- sichere und feinfühlige Handhabung
- leichtes Reinigen
- keine schmutzanfälligen Riefelungen
- ergonomic handle
- sophisticated design
- safe and sensitive in hand, well balanced
- easy to clean
- no dirt catching knurlings
- manche ergonomique
- aspect attrayant
- une manipulation délicate et en sécurité
- la précision du geste opératoire
- un nettoyage facile
- striure pas sensible à la saleté





- mango ergonómico
- diseño concebido
- manipulación segura y delicada
- limpieza fácil
- las estriadas no son susceptible a la suciedad
- manico ergonomico
- design appariscente
- maneggio sicuro e delicato
- purificazione facile
- non incline de la sporcizia



### Mikro-Nadelhalter





Micro needle holders  
Micro porte-aiguilles  
Micro porta-agujas  
Micro port'aghi



-  **24.690.16**  
16 cm/6¼"
-  **24.691.16**  
16 cm/6¼"
-  **24.690.18**  
18,5 cm/7¼"
-  **24.691.18**  
18,5 cm/7¼"
-  **24.693.16**  
16 cm/6¼"  
mit Diamantbeschichtung  
with diamond coating  
avec couche diamantée  
con recubrimiento de diamante  
con rivestimento di diamante

ohne Sperre  
without catch  
sans crémaillère  
sin cierre  
senza serratura



-  **24.444.16**  
16 cm/6¼"
-  **24.444.18**  
18 cm/7"
-  **24.444.20**  
20 cm/8"
-  **24.444.23**  
23 cm/9"
-  **24.444.26**  
26 cm/10¼"

Mikroprofil  
Micro profile  
Profil micro  
Perfil micro  
Profilo micro

DIETRICH





**JACOBSON**  
 18 cm/7"



**24.720.18**  
 ohne Sperre  
 without catch  
 sans crémaillère  
 sin cierre  
 senza serratura



**24.722.18**  
 mit Sperre  
 with catch  
 avec crémaillère  
 con cierre  
 con serratura

Leichtmetall Rundgriffe, gut ausbalanciert  
 Light-weight round handles, well balanced  
 Manches ronds en métal léger, bien équilibrés  
 Mangos redondos de metal ligero, bien equilibrados  
 Manici rotondi metallo leggero, equilibrio perfetto



18,5 cm/7¼"

ohne Sperre  
 without catch  
 sans crémaillère  
 sin cierre  
 senza serratura



15 cm/6"	<b>24.870.15</b>	<b>24.871.15</b>
18 cm/7"	<b>24.870.18</b>	<b>24.871.18</b>

mit Sperre  
 with catch  
 avec crémaillère  
 con cierre  
 con serratura



15 cm/6"	<b>24.872.15</b>	<b>24.873.15</b>
18 cm/7"	<b>24.872.18</b>	<b>24.873.18</b>



### Mikro-Nadelhalter

Micro needle holders  
Micro porte-aiguilles  
Micro porta-agujas  
Micro port'aghi

diamantiertes Maul  
diamond-coated jaw  
mors diamanté  
boca diamantada  
morso diamantato



Streamlined

mit Sperre  
with catch  
avec crémaillère  
con cierre  
con serratura

ohne Sperre  
without catch  
sans crémaillère  
sin cierre  
senza serratura



11 x 0,8 mm

11 x 0,8 mm

11 x 0,8 mm

11 x 0,8 mm

15 cm/6"	24.920.15	24.921.15	24.922.15	24.923.15
18 cm/7"	24.920.18	24.921.18	24.922.18	24.923.18
21 cm/8¼"	24.920.21	24.921.21	24.922.21	24.923.21

Titan  
Titanium  
Titane  
Titanio  
Titanio

11 x 1,2 mm

11 x 1,2 mm

11 x 1,2 mm

11 x 1,2 mm

21 cm/8¼"	24.924.21	24.925.21	24.926.21	24.927.21
-----------	-----------	-----------	-----------	-----------

# 07

◆ ORTHOPÄDIE

ORTHOPAEDICS

CHIRURGIE OSSEUSE

CIRUGÍA ÓSEA

CHIRURGIA OSSEA

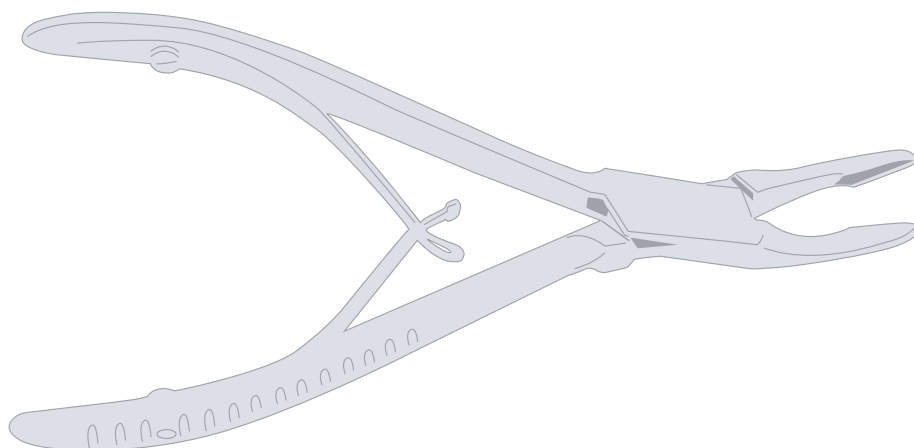



### Hohlmeißelzangen

Bone rongeurs  
Pincas-gouges  
Pinzas-gubias  
Pinze sgorbie



**BEYER**  
**32.201.18**  
18 cm/7"



**ZAUFAL JANSEN**  
**32.205.18**  
18 cm/7"



**BOEHLER**  
15 cm/5¾"



**32.209.15**  
1,7 mm



**32.210.15**  
2 mm



**32.211.15**  
2 mm



**32.212.15**  
3 mm



**32.213.15**  
3 mm



**MARQUARDT**  
**32.215.20**  
20 cm/8"



**RUSKIN**  
**32.218.23**  
23 cm/9"



**RUSKIN**  
**32.219.23**  
23 cm/9"



STILLE LUER



**32.228.23**  
23 cm/9"



**32.229.23**  
23 cm/9"

**32.228.27**  
27 cm/10½"

**32.229.27**  
27 cm/10½"



STILLE LUER



**32.230.22**  
22 cm/8¾"



**32.231.22**  
22 cm/8¾"



## Hohlmeißelzangen

Bone rongeurs  
Pincas-gouges  
Pinzas-gubias  
Pinze sgorbie



**STILLE LUER**  
32.235.23  
23 cm/9"



**SAUERBRUCH**  
31 cm/12¼"



**LEKSELL-STILLE**  
 24,5 cm/9¾"



**32.245.23**  
 8 mm



**32.247.23**  
 4 mm



**LEKSELL**  
 23 cm/9"



**32.249.05**  
 5 mm



**32.249.08**  
 8 mm



**FRYKHOLM**  
**32.255.24**  
 24 cm/9½"





### Hohlmeißelzangen, Knochensplitterzangen

Bone rongeurs, bone cutting forceps  
Pincès-gouges, pincès coupantes à os  
Pinzas-gubias, pinzas cortantes para huesos  
Pinze sgorbie, cesoio per ossa



**ECHLIN**  
23 cm/9"



**32.259.02**  
2 mm



**32.259.03**  
3 mm



**32.259.23**  
4 mm

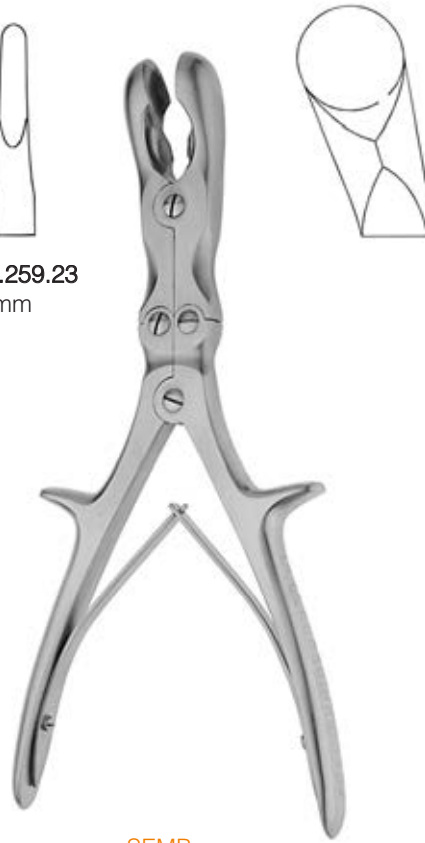

**SEMB**  
**32.261.22**  
22,5 cm/9"



**CLEVELAND**  
**32.106.15**  
15 cm/5¾"



**CLEVELAND**  
**32.270.17**  
17 cm/6¾"



**SMITH PETERSEN**  
24 cm/9½"



**32.265.24**  
3 mm



**32.263.24**  
3 mm



**32.262.24**  
3 mm





**32.274.14**  
14 cm/5½"

**32.274.17**  
17 cm/6¾"

**32.274.19**  
20 cm/8"

**32.274.22**  
22 cm/8¾"

LISTON

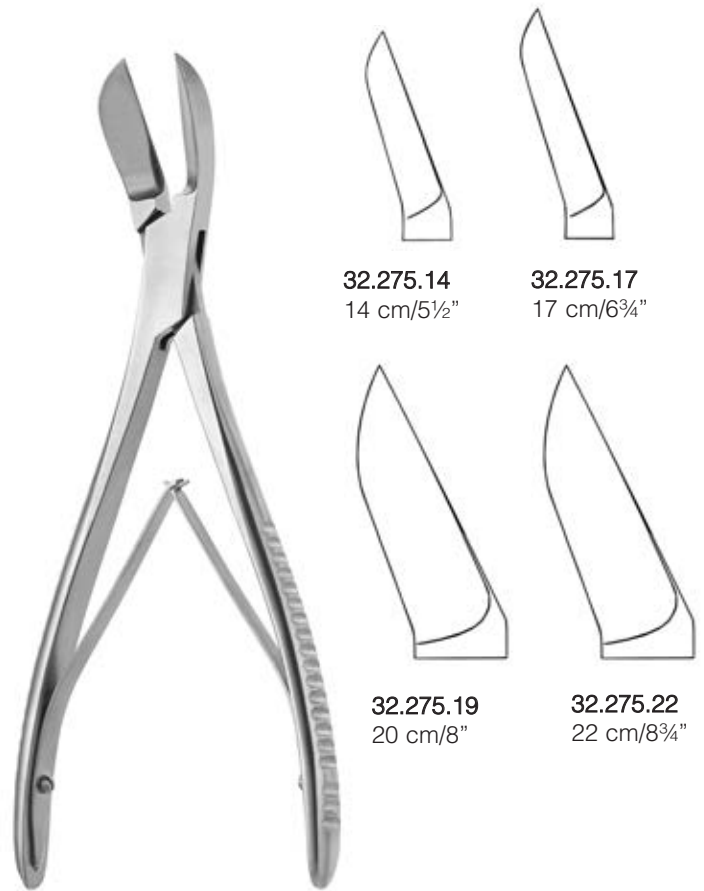

**32.275.14**  
14 cm/5½"

**32.275.17**  
17 cm/6¾"

**32.275.19**  
20 cm/8"

**32.275.22**  
22 cm/8¾"

LISTON



**BOEHLER**  
**32.280.15**  
15 cm/5¾"



**BOEHLER**  
**32.281.15**  
15 cm/5¾"



**Knochensplitterzangen**  
Bone cutting forceps  
Pincès coupantes à os  
Pinzas cortantes para hueso  
Cesoie per ossa



**MCINDOE**  
32.284.17  
17,5 cm/7"



**RUSKIN LISTON**  
18 cm/7"



32.286.18



32.289.18



**STILLE LISTON**  
**32.290.26**  
26,5 cm/10<sup>1</sup>/<sub>4</sub>"



**STILLE LISTON**  
**32.290.27**  
27,5 cm/10<sup>3</sup>/<sub>4</sub>"



**Knochensplitterzangen**  
Bone cutting forceps  
Pinces coupantes à os  
Pinzas cortantes para hueso  
Cesoie per ossa

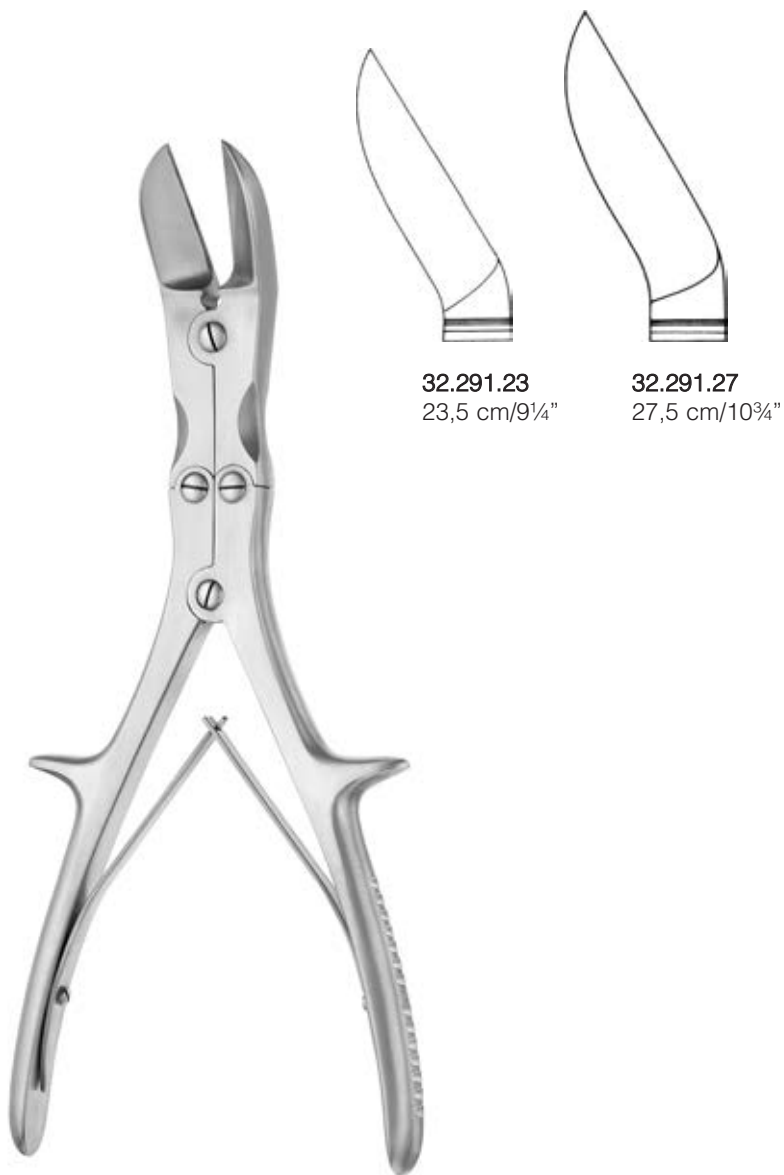

**32.291.23**  
23,5 cm/9¼"

**32.291.27**  
27,5 cm/10¾"

STILLE LISTON



**LISTON-KEY-HORSLEY**  
**32.293.27**  
24,5 cm/9¾"



**SEMB**  
**32.295.24**  
24 cm/9½"



## Knochenhaltezangen

Bone holding forceps

Daviers à os

Pinzas para huesos

Tenaglie per ossa



kräftiges Modell  
heavy pattern  
modèle fort  
modelo fuerte  
modello forte

**FERGUSSON**  
**32.360.21**  
21 cm/8¼"



**LANGENBECK**  
**32.362.21**  
21 cm/8¼"



**SEMB**  
**32.364.19**  
19 cm/7½"

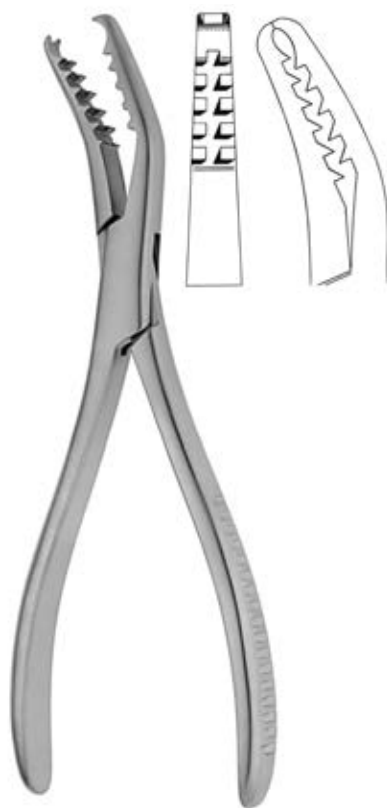

**SEMB**  
**32.365.19**  
19 cm/7½"



**32.386.20**  
20 cm/8"



### Scharfe Löffel

Bone curettes  
Curettes tranchantes  
Cucharillas cortantes  
Curette taglianti



32.467.97  
Fig. 000



32.469.96  
Fig. 0000



32.470.02  
Fig. 2



32.471.96  
Fig. 0000



32.472.02  
Fig. 2



32.467.98  
Fig. 00



32.469.97  
Fig. 000



32.470.03  
Fig. 3



32.471.97  
Fig. 000



32.472.03  
Fig. 3



32.468.00  
Fig. 0



32.469.98  
Fig. 00



32.470.04  
Fig. 4



32.471.98  
Fig. 00



32.472.04  
Fig. 4



32.468.01  
Fig. 1



32.468.03  
Fig. 3



32.468.02  
Fig. 2



32.468.04  
Fig. 4



32.469.98  
Fig. 00



32.470.05  
Fig. 5



32.470.00  
Fig. 0



32.470.06  
Fig. 6



32.470.01  
Fig. 1



32.471.98  
Fig. 00



32.472.05  
Fig. 5



32.472.00  
Fig. 0



32.472.01  
Fig. 1



32.472.06  
Fig. 6

#### SCHEIDE 17 cm/6¾"

oval, mit Hohlheft  
oval, with hollow handle  
ovale, avec manche creux  
ovalada, con mango hueco  
ovala, con manico vuoto

#### VOLKMANN 17 cm/6¾"

oval, mit Hohlheft  
oval, with hollow handle  
ovale, avec manche creux  
ovalada, con mango hueco  
ovala, con manico vuoto

#### BRUNS 17 cm/6¾"

rund, mit Hohlheft  
round, with hollow handle  
rond, avec manche creux  
redonda, con mango hueco  
rotonda, con manico vuoto





**32.690.45**

Kopf  
Head  
Tête  
Cabeza  
Testa  
**ø 35 mm**

Gewicht  
Weight  
Poids  
Peso  
Peso  
**450 g**

26,5 cm/10½"



**32.690.13**

Kopf  
Head  
Tête  
Cabeza  
Testa  
**ø 55 mm**

Gewicht  
Weight  
Poids  
Peso  
Peso  
**1300 g**

**32.691.14**  
18,5 cm/7¼"

**32.691.99**

Ersatzbacken zu **32.691.14**, Paar  
Spare facings to **32.691.14**, pair  
Joues de rechange pour **32.691.14**, paire  
Frentes de repuesto para **32.691.14**, par  
Guancie di ricambio per **32.691.14**, paio

Kopf  
Head  
Tête  
Cabeza  
Testa  
**ø 25 mm**

Gewicht  
Weight  
Poids  
Peso  
Peso  
**135 g**

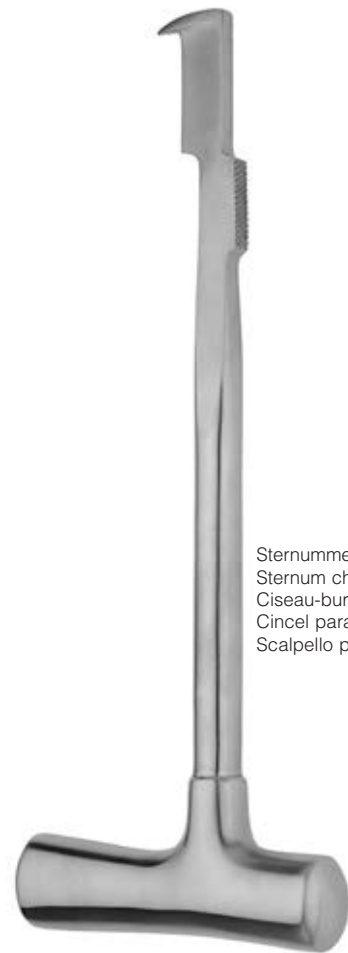

Sternummeißel  
Sternum chisel  
Ciseau-burin à sternum  
Cinzel para esternum  
Scalpello per sternum

**LEBSCHÉ**  
**32.678.24**  
24,5 cm/9¾"



### Raspatorien

Periosteal elevators  
Rugines  
Periostótomos  
Periostotomi



**FARABEU**  
**32.702.15**  
15 cm/6"



**FARABEU**  
**32.703.15**  
15 cm/6"

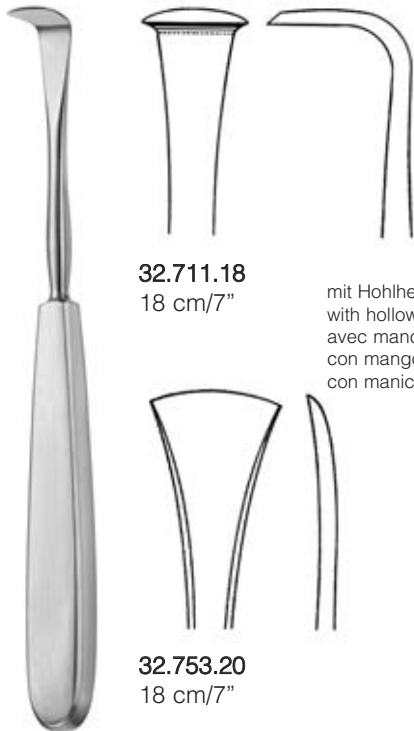

**32.711.18**  
18 cm/7"

mit Hohlheft  
with hollow handle  
avec manche creux  
con mango hueco  
con manico vuoto

**32.753.20**  
18 cm/7"

**LANGENBECK**

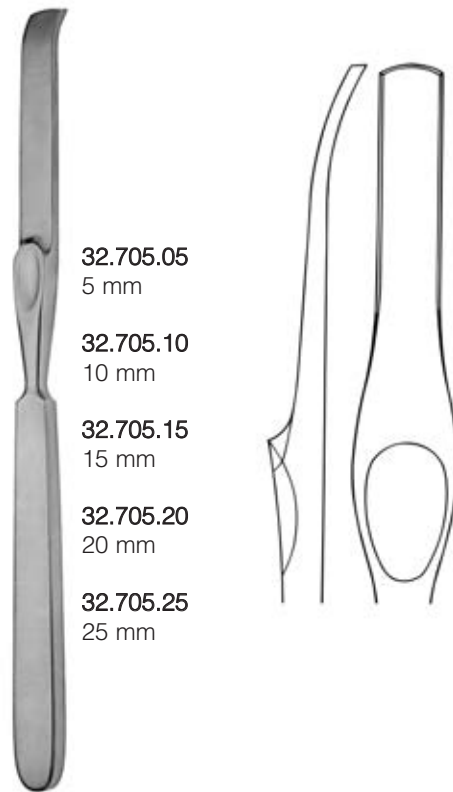

**32.705.05**  
5 mm

**32.705.10**  
10 mm

**32.705.15**  
15 mm

**32.705.20**  
20 mm

**32.705.25**  
25 mm

**LAMBOTTE**  
21 cm/8¼"

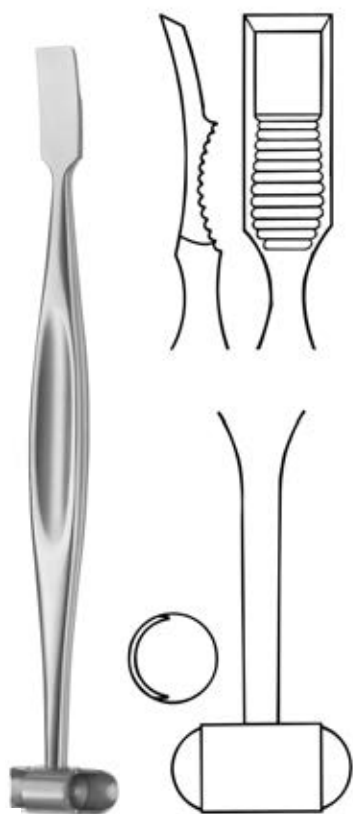

**ALEXANDER**

16 cm/6¼"	<b>32.715.16</b>
20 cm/7¾"	<b>32.715.20</b>



**MATSON ALEXANDER**

**32.731.22**  
 22 cm/8¾"

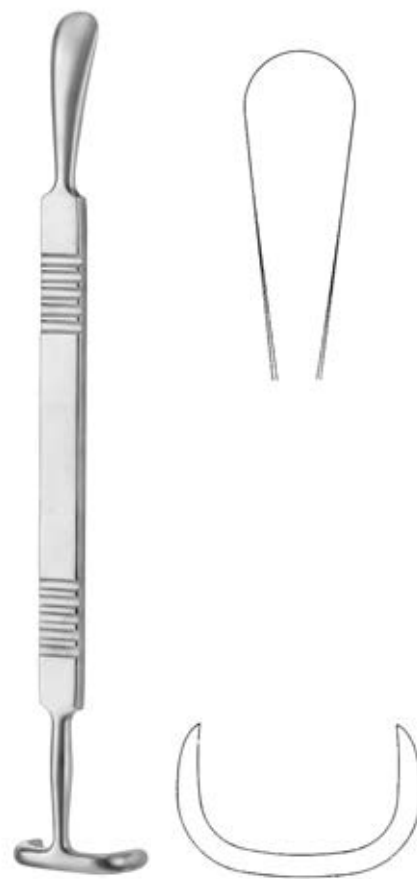

**MATSON**

**32.733.22**  
 22 cm/8¾"



## Raspatorien

Periosteal elevators

Rugines

Periostótomos

Periostotomi



**OVERHOLT**  
**32.735.29**  
29,5 cm/11<sup>3</sup>/<sub>4</sub>"



**OVERHOLT**  
**32.737.29**  
29,5 cm/11<sup>3</sup>/<sub>4</sub>"

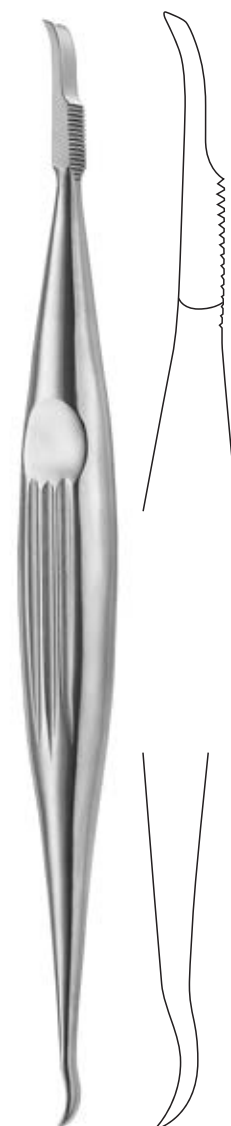

**OVERHOLT**  
**32.739.28**  
28,5 cm/11<sup>1</sup>/<sub>4</sub>"



DOYEN  
 32.721.17  
 17 cm/6¾"



DOYEN  
 32.723.17  
 17 cm/6¾"



DOYEN  
 32.725.17  
 17 cm/6¾"



DOYEN  
 32.727.17  
 17 cm/6¾"



32.721.24  
 links  
 left  
 à gauche  
 izquierda  
 sinistro

32.723.24  
 rechts  
 right  
 à droite  
 derecha  
 destro

DOYEN  
 24 cm/9½"



## Raspatorien

Periosteal elevators

Rugines

Periostótomos

Periostotomi



**SEMB**  
**32.729.01**  
18,5 cm/7¼"  
12 mm

**SEMB**  
**32.729.02**  
21,5 cm/8½"  
12 mm

**SEMB**  
**32.729.03**  
18,5 cm/7¼"  
13 mm

**SEMB**  
**32.729.04**  
21,5 cm/8½"  
13 mm

**SEMB**  
**32.729.05**  
21 cm/8¼"  
15 mm



mit Kunststoffgriff  
 with plastic handle  
 avec manche en plastique  
 con mango de plástico  
 con manico in plastica

**32.717.20**  
 20 cm/8"



mit Kunststoffgriff  
 with plastic handle  
 avec manche en plastique  
 con mango de plástico  
 con manico in plastica

**32.774.14**  
 20 cm/8"  
 14 mm



mit Kunststoffgriff  
 with plastic handle  
 avec manche en plastique  
 con mango de plástico  
 con manico in plastica

**32.775.14**  
 20 cm/8"  
 14 mm



Schmal, mit Kunststoffgriff  
 narrow, with plastic handle  
 étroit, avec manche en plastique  
 estrecho, con mango de plástico  
 stretto, con manico in plastica

**32.779.06**  
 18 cm/7"  
 6 mm



mit Kunststoffgriff  
 with plastic handle  
 avec manche en plastique  
 con mango de plástico  
 con manico in plastica

**32.781.06**  
 18 cm/7"  
 6 mm



extra schmal, mit Kunststoffgriff  
 extra narrow, with plastic handle  
 très étroit, avec manche en plastique  
 muy estrecho, con mango de plástico  
 molto stretto, con manico in plastica

**32.783.03**  
 18 cm/7"  
 3 mm



### Knochendraht, Flachzangen

Bone wire, flat nose pliers  
 Fils d'acier à os, pinces plates  
 Hilo para huesos, alicates de pico plano  
 Filo per ossa, tenaglie piatte



weich, Rolle mit 10 m  
 soft, coil of 10 m  
 malléable, en rouleau de 10 m  
 blando, rollo de 10 m  
 molle, rotolo di 10 m

- |                              |                              |
|------------------------------|------------------------------|
| <b>33.530.02</b><br>ø 0,2 mm | <b>33.530.08</b><br>ø 0,8 mm |
| <b>33.530.03</b><br>ø 0,3 mm | <b>33.530.09</b><br>ø 0,9 mm |
| <b>33.530.04</b><br>ø 0,4 mm | <b>33.530.10</b><br>ø 1,0 mm |
| <b>33.530.05</b><br>ø 0,5 mm | <b>33.530.12</b><br>ø 1,2 mm |
| <b>33.530.06</b><br>ø 0,6 mm | <b>33.530.15</b><br>ø 1,5 mm |
| <b>33.530.07</b><br>ø 0,7 mm |                              |



- |                  |                  |                  |
|------------------|------------------|------------------|
|                  |                  |                  |
| <b>33.532.01</b> | <b>33.532.02</b> | <b>33.532.03</b> |

parallel fassend  
 parallel grip  
 action parallèle  
 acción paralela  
 afferramento parallelo

18 cm/7"



- |                              |                                 |
|------------------------------|---------------------------------|
|                              |                                 |
| <b>33.537.01</b><br>18 cm/7" | <b>33.537.02</b><br>18 cm/7"    |
|                              |                                 |
| <b>33.537.03</b><br>18 cm/7" | <b>33.537.04</b><br>14,5 cm/5¾" |



- |                  |                  |                  |
|------------------|------------------|------------------|
|                  |                  |                  |
| <b>33.533.01</b> | <b>33.533.02</b> | <b>33.533.03</b> |

parallel fassend  
 parallel grip  
 action parallèle  
 acción paralela  
 afferramento parallelo

mit TC-Einsätzen  
 with TC inserts  
 avec mors TC  
 con bocas TC  
 con morso TC

18 cm/7"





**33.538.01**  
 17,5 cm/7"



**33.538.02**  
 17 cm/6¾"

mit Kreuzrille  
 with crosswise groove  
 avec rainures croisées  
 con ranura en forma de cruz  
 con scannelatura a croce



Spitz- und Flachzange  
 Flat nose plier, pointed  
 Pincas plates/pointues  
 Alicates planos/agudos  
 Tenaglie piate/appuntate

**33.538.19**  
 19,5 cm/7¾"



**33.568.14**  
 14 cm/5½"



**GOSLEE**  
**33.569.14**  
 14 cm/5½"



**33.528.01**  
 15 cm/6"

**33.528.02**  
 15 cm/6"

**33.528.03**  
 16 cm/6¼"

**33.528.04**  
 18 cm/7"

mit TC-Einsätzen  
 with TC inserts  
 avec mors TC  
 con bocas TC  
 con morso TC

Automatic



## Drahtwirbelzangen

Wire twisting forceps  
Pinces à torsader le fil  
Pinzas para torcer alambre  
Pinze per ritorcere fili

mit TC-Einsätzen  
with TC inserts  
avec mors TC  
con bocas TC  
con morso TC



**33.552.17**  
17 cm/6¾"



**BAUMGARTNER**  
**33.599.20**  
20 cm/8"



**33.600.15**  
15,5 cm/6"



**33.601.15**  
15 cm/6"



**BERRY**  
**33.601.19**  
19 cm/7½"

kräftiges Modell  
heavy pattern  
modèle fort  
modelo pesado  
modello pesante



eine Schneide gezahnt  
one toothed cutting edge  
une lame dentelée  
una hoja dentada  
una lama dentata

**08.831.12**  
12 cm/4¾"



eine Schneide gezahnt  
one toothed cutting edge  
une lame dentelée  
una hoja dentada  
una lama dentata

**08.835.12**  
12 cm/4¾"



**HARVEY**  
**08.838.12**  
12,5 cm/5"

mit TC-Einsätzen  
with TC inserts  
avec mors TC  
con bocas TC  
con morso TC



**33.545.16**  
16 cm/6¼"



**33.545.18**  
18 cm/7"



**33.545.22**  
22,5 cm/8¾"



## Seitenschneider, Drahtkneifzangen

Wire cutting pliers

Pince coupantes de côte, pinces à couper le fil

Tenazas de corte lateral, alicates para cortar alambre

Tenaglie tagliafilati laterali, tenaglie tagliafilati

mit TC-Einsätzen  
with TC inserts  
avec mors TC  
con bocas TC  
con morso TC



**33.546.18**  
17,5 cm/7"



REILL  
**33.547.17**  
17,5 cm/7"



**87.574.15**  
14 cm/5½"



für weiche Drähte bis  
for soft wires up to  
pour fils mous jusqu'à  
para alambres blandos hasta  
per fili molli fino a  
Ø 2,2 mm

für harte Drähte bis  
for hard wires up to  
pour fils durs jusqu'à  
para alambres duros hasta  
per fili metallici duri fino a  
Ø 2,0 mm

Kopfschneider  
Wire cutter, front action  
Pinces coupantes frontales  
Alicates frontal para cortar alambre  
Tenaglie tagliafilati frontali

**33.540.16**  
16 cm/6¼"



für weiche Drähte bis  
for soft wires up to  
pour fils mous jusqu'à  
para alambres blandos hasta  
per fili molli fino a  
Ø 2,5 mm

für harte Drähte bis  
for hard wires up to  
pour fils durs jusqu'à  
para alambres duros hasta  
per fili metallici duri fino a  
Ø 1,5 mm

**33.544.18**  
18,5 cm/7¼"



**HARVEY**  
**33.547.23**  
23,5 cm/9¼"



## Rippenscheren

Rib shears  
Costotomes  
Costótomos  
Costotomi



**56.102.19**  
19 cm/7½"



**56.102.23**  
23 cm/9¼"



**56.105.22**  
22 cm/8¾"

Sternumschere  
Sternum scissors  
Ciseaux à sternum  
Tijeras de esternón  
Forbici per sterno



**SCHUMACHER**  
**56.148.21**  
21 cm/8¼"



Rippenschere mit ziehendem Schnitt  
Rib shears with drawing cut  
Costotome avec lame excentrée  
Costótomo con hoja de retroacción  
Costotomo con lama eccentrica a scorrimento



**GLUCK**  
56.107.22  
22 cm/8 $\frac{3}{4}$ "



**COLLIN**  
56.108.19  
19,5 cm/7 $\frac{3}{4}$ "



**STILLE**  
56.111.21  
21 cm/8 $\frac{1}{4}$ "



## Rippenscheren

Rib shears  
Costotomes  
Costótomos  
Costotomi



links  
left  
à gauche  
izquierda  
sinistro

**CORYLLOS**  
**56.123.35**  
35 cm/14"



rechts  
right  
à droite  
derecha  
destro

**CORYLLOS**  
**56.125.35**  
35 cm/14"





**BETHUNE**  
**56.126.34**  
34 cm/13½"



**COOLEY**  
**56.128.35**  
35 cm/14"



## Rippenscheren

Rib shears  
Costotomes  
Costótomos  
Costotomi



LEBSCHÉ  
56.145.25  
25 cm/10"



SAUERBRUCH  
56.131.26  
26 cm/10¼"



GIERTZ-STILLE  
56.137.27  
27 cm/10½"



**56.147.28**  
32 cm/12½"

für die rechte Hand  
for right hand  
pour la main droite  
para la mano derecha  
per la mano destra

**56.149.28**  
32 cm/12½"

für die linke Hand  
for left hand  
pour la main gauche  
para la mano izquierda  
per la mano sinistra



BRUNNER



### Sternumsäge System

Sternum saw system  
Système de scie sternum  
Sistema de sierra de esternón  
Sistema di sega di sterno

# diMAGNI5<sup>®</sup>

#### 33.301.06

diMAGNI5-SW Sternumsäge  
diMAGNI5-SW sternum saw  
diMAGNI5-SW scie sternum  
diMAGNI5-SW sierra de esternón  
diMAGNI5-SW sega di sterno

#### 33.319.01

Oszillierendes Sägeblatt Stryker  
Oscillating saw blade Stryker  
Lame de scie oscillante Stryker  
Hoja de sierra oscilante Stryker  
Lama da taglio oscillante Stryker

#### 33.301.10

Akku  
Battery  
Batterie  
Batería  
Batteria

#### 33.301.52

Sterilisations-Trichter für Akku  
Sterilization funnel for battery  
Entonnoir de stérilisation pour la batterie  
Embudo de esterilización para la batería  
Sterilizzazione-imbuto per batteria

#### 33.301.11

Ladegerät  
Charging Unit  
Chargeur  
Cargador  
Ricarica

#### 33.301.70

Sprühadapter  
Spray adapter  
Adaptateur de vaporisation  
Adaptador de spray  
Adattatore spray

#### 28.316.00

Reinigungsbürsten-Set aus 6 Stück  
Set of cleaning brushes  
Set de brosses de nettoyage  
Juego de cepillos de limpieza  
Set di spazzole per la pulizia



33.319.01

33.301.06



33.301.11



33.301.10



33.301.52



33.301.70



28.316.00

# 08

◆ RIPPENSPERRER

RIB SPREADERS

ÉCARTEURS POUR COSTAUX

SEPARADORES COSTALES

DIVARICATORI COSTALI

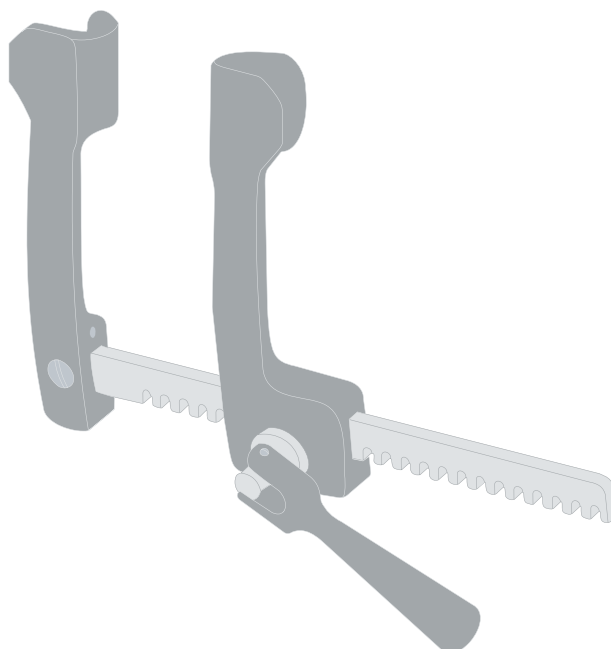



## Rippensperrer

Rib spreaders  
Écarteurs pour costaux  
Separadores costales  
Divaricatori costali

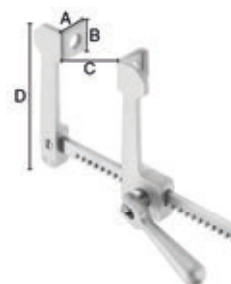

	A	B	C	D
<b>56.210.16</b>	40 mm	40 mm	165 mm	110 mm
<b>56.210.20</b>	45 mm	65 mm	200 mm	140 mm
<b>56.210.25</b>	70 mm	65 mm	250 mm	140 mm
<b>56.210.30</b>	70 mm	65 mm	300 mm	140 mm

für Erwachsene · for adults · pour adultes · para adultos · per adulti

FINOCHIETTO



	A	B	C	D
<b>56.212.12</b>	14 mm	20 mm	120 mm	105 mm

für Säuglinge · for babies · pour bébés · para bebés · per neonati

FINOCHIETTO (modif.)

ALUMINIUM

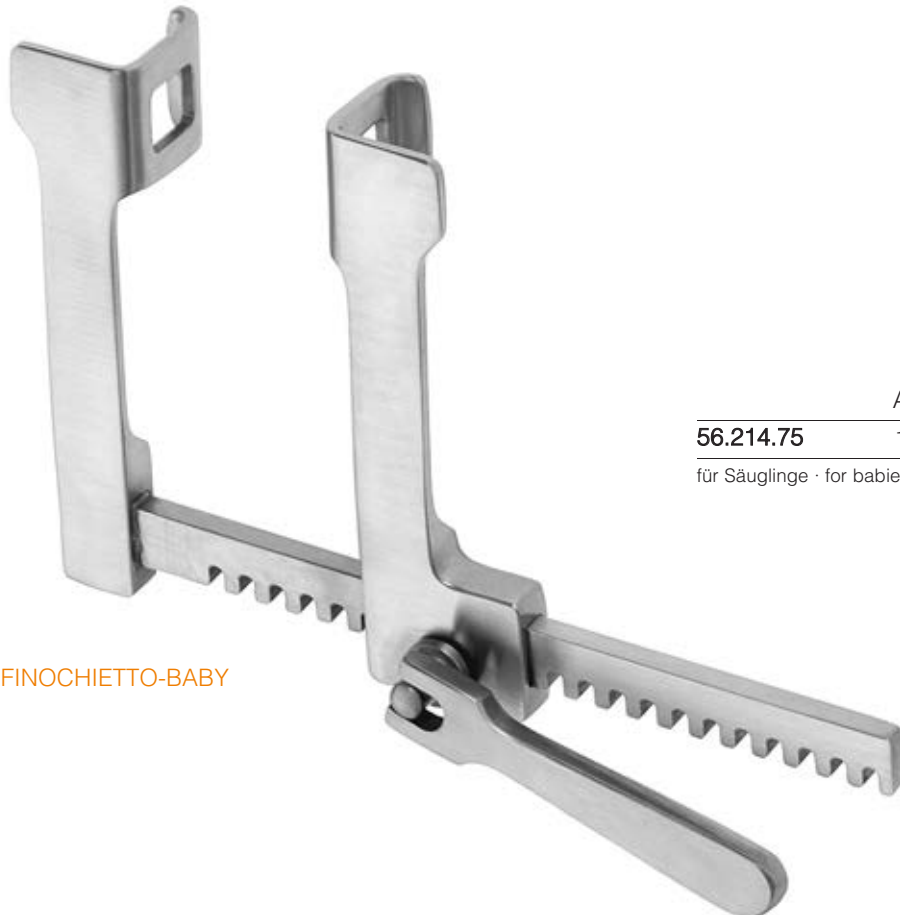
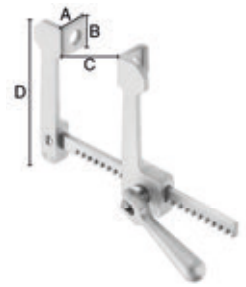

FINOCHIETTO-BABY

	A	B	C	D
<b>56.214.75</b>	14 mm	15 mm	75 mm	55 mm

für Säuglinge · for babies · pour bébés · para bebés · per neonati



COOLEY  
 ALUMINIUM

	A	B	C	D
<b>56.220.01</b>	12 mm	17 mm	95 mm	55 mm

für Säuglinge · for babies · pour bébés · para bebés · per neonati

	A	B	C	D
<b>56.220.02</b>	15 mm	30 mm	140 mm	80 mm

<b>56.220.07</b>	29 mm	34 mm	140 mm	110 mm
------------------	-------	-------	--------	--------

für Kinder · for children · pour enfants · para niños · per bambini



## Rippensperrer

Rib spreaders  
Écarteurs pour costaux  
Separadores costales  
Divaricatori costali

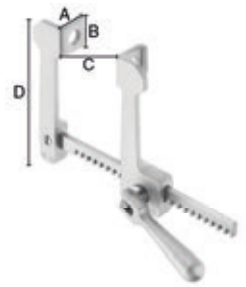

	A	B	C	D
<b>56.220.03</b>	22 mm	45 mm	150 mm	110 mm

für Kinder · for children · pour enfants · para niños · per bambini

	A	B	C	D
<b>56.220.04</b>	34 mm	51 mm	200 mm	145 mm
<b>56.220.08</b>	34 mm	100 mm	180 mm	180 mm

für Erwachsene · for adults · pour adultes · para adultos · per adulti

	A	B	C	D
<b>56.220.09</b>	34 mm	100 mm	180 mm	180 mm

für Erwachsene mit Fadenfänger · for adults with suture separator · pour adultes avec chasseur de suture · para adultos con separador de sutura · per adulti con il seperatore del suture

	A	B	C	D
<b>56.220.10</b>	34 mm	115 mm	230 mm	205 mm

für Erwachsene, extra groß · for adults, extra large · pour adultes, extra-grand · para adultos, extra grande · per adulti, extra grande

COOLEY  
ALUMINIUM



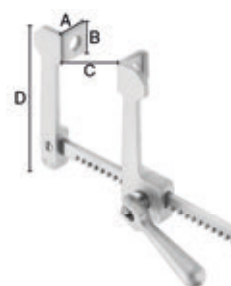

	A	B	C	D
<b>56.220.05</b>	10 mm	15,5 mm	75 mm	55 mm

für Neugeborene · neonatal · néonatal · recién nacidos · neonatale

COOLEY  
 ALUMINIUM



	A	B	C	D
<b>56.220.06</b>	20 mm	24 mm	100 mm	80 mm

für Säuglinge · for babies · pour bébés · para bebés · per neonati

COOLEY  
 ALUMINIUM

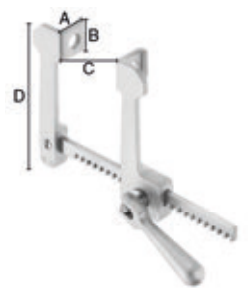

I.M.A	C	D
<b>56.220.60</b>	215 mm	140 mm

Mammaria Sperrer, komplett · mammaria retractor, complete · Ecarteur à mammaria, complet · Separador mammaria, completo · Divaricatore per mammaria, completo

I.M.A	C	D
<b>56.220.61</b>	215 mm	140 mm

Sperrer allein · retractor only · écarteur seul · separador suelto · divaricatore solo

I.M.A	A	B
<b>56.220.62</b>	30 mm	50 mm

Mammariablatt komplett, mit Aufnahmeblatt links und rechts ·  
 Mammaria blade complete, with holding blades left and right ·  
 Mammaria valves complètes, avec valves à droite et à gauche ·  
 Mammaria valvas completas, con valvas izquierda y derecha ·  
 Mammaria valve completo, con valve sinistra e destra

I.M.A	A	B
<b>56.220.63</b>	30 mm	100 mm
<b>56.220.64</b>	40 mm	100 mm

Sternumblätter, Paar · sternum blades, pair · valves à sternum, paire · sternum valvas, par · sternum valve, coppia



56.220.62



56.220.63



56.220.64

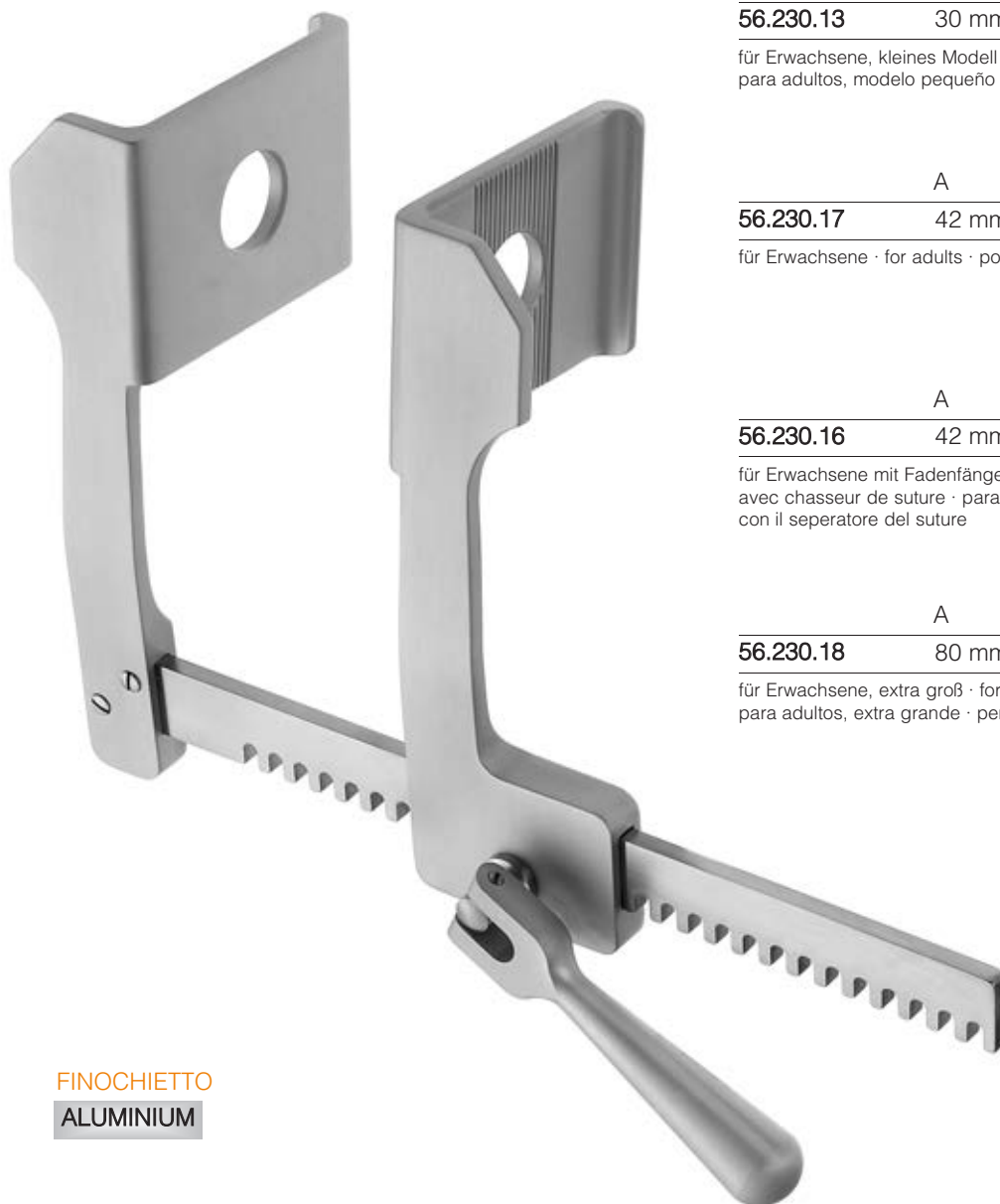

	A	B	C	D
<b>56.230.13</b>	30 mm	45 mm	145 mm	110 mm

für Erwachsene, kleines Modell · for adults, small model · pour adultes, petit · para adultos, modelo pequeño · per adulti, modello piccolo

	A	B	C	D
<b>56.230.17</b>	42 mm	62 mm	180 mm	145 mm

für Erwachsene · for adults · pour adultes · para adultos · per adulti

	A	B	C	D
<b>56.230.16</b>	42 mm	62 mm	180 mm	145 mm

für Erwachsene mit Fadenfänger · for adults with suture separator · pour adultes avec chasseur de suture · para adultos con separador de sutura · per adulti con il seperatore del suture

	A	B	C	D
<b>56.230.18</b>	80 mm	65 mm	180 mm	145 mm

für Erwachsene, extra groß · for adults, extra large · pour adultes, extra-grand · para adultos, extra grande · per adulti, extra grande

**FINOCHIETTO**  
**ALUMINIUM**



### Rippensperrer

Rib spreaders  
Écarteurs pour costaux  
Separadores costales  
Divaricatori costali

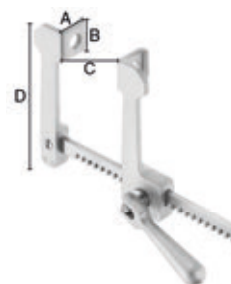

FINOCHIETTO BABY-HAIGHT

ALUMINIUM

	A	B	C	D
<b>56.232.10</b>	27 mm	31 mm	100 mm	80 mm

für Kinder · for children · pour enfants · para niños · per bambini



FINOCHIETTO

ALUMINIUM

	A	B	C	D
<b>56.234.40</b>	12 mm	15 mm	100 mm	55 mm

für Säuglinge · for babies · pour bébés · para bebés · per neonati

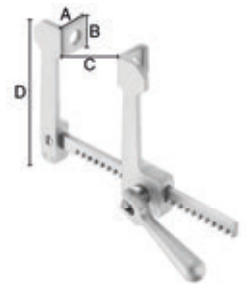

**FINOCHIETTO**  
**ALUMINIUM**

	A	B	C	D
<b>56.234.41</b>	28 mm	30 mm	143 mm	80 mm
<b>56.234.42</b>	31 mm	45 mm	210 mm	110 mm

für Kinder · for children · pour enfants · para niños · per bambini

	A	B	C	D
<b>56.234.43</b>	42 mm	62 mm	245 mm	145 mm
<b>56.234.44</b>	74 mm	64 mm	250 mm	145 mm

für Erwachsene · for adults · pour adultes · para adultos · per adulti

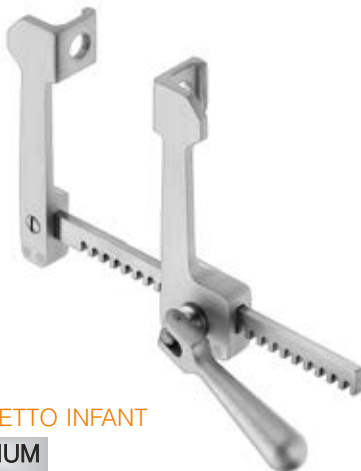

**FINOCHIETTO INFANT**  
**ALUMINIUM**

	A	B	C	D
<b>56.234.75</b>	12 mm	15 mm	75 mm	55 mm

für Säuglinge · for babies · pour bébés · para bebés · per neonati



## Rippensperrer

Rib spreaders  
Écarteurs pour costaux  
Separadores costales  
Divaricatori costali

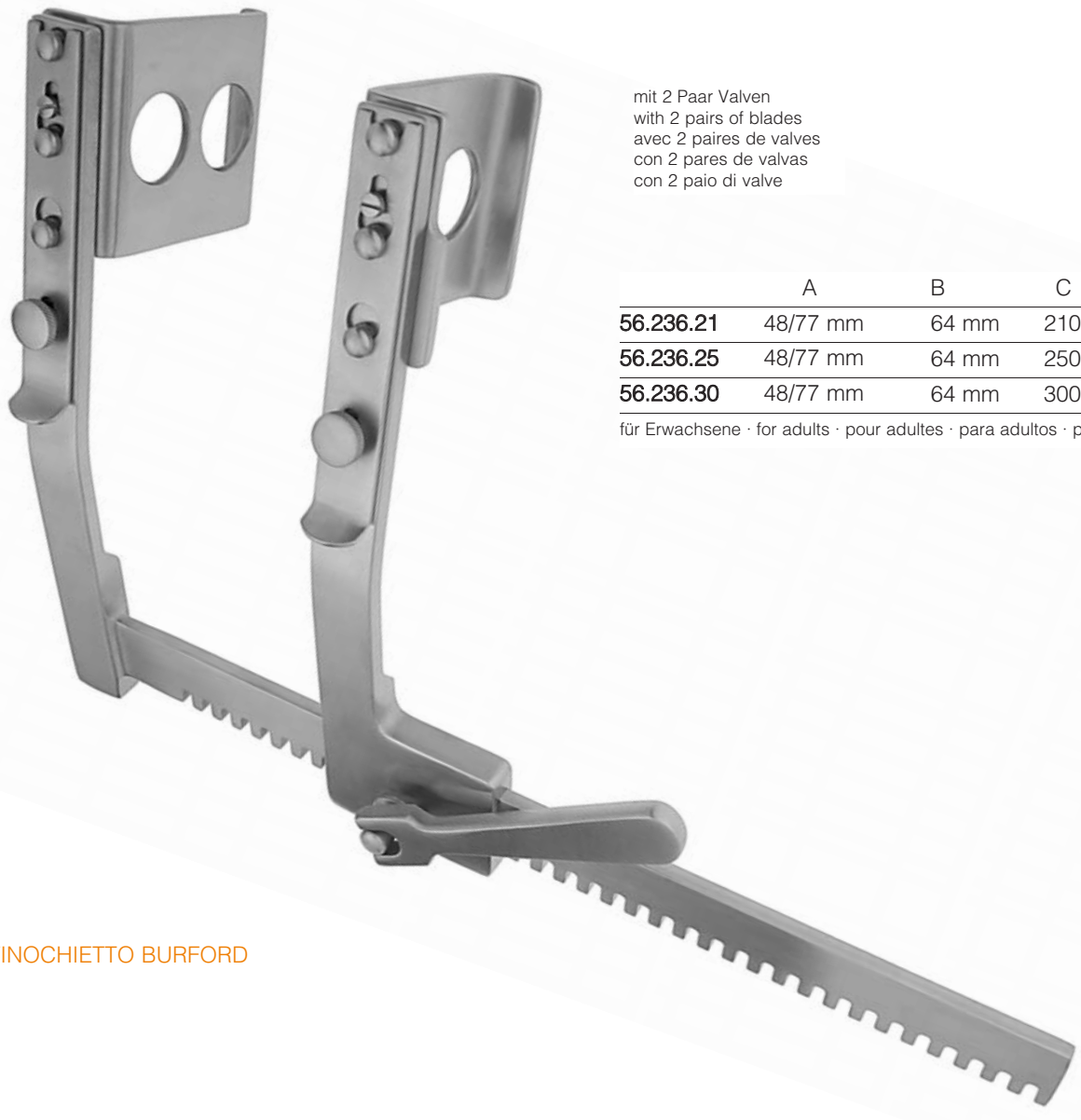
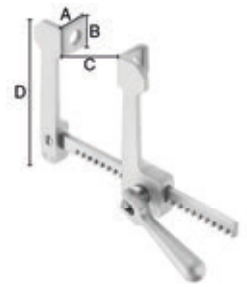

mit 2 Paar Valven  
with 2 pairs of blades  
avec 2 paires de valves  
con 2 pares de valvas  
con 2 paio di valve

	A	B	C	D
<b>56.236.21</b>	48/77 mm	64 mm	210 mm	195 mm
<b>56.236.25</b>	48/77 mm	64 mm	250 mm	195 mm
<b>56.236.30</b>	48/77 mm	64 mm	300 mm	195 mm

für Erwachsene · for adults · pour adultes · para adultos · per adulti

FINOCHIETTO BURFORD

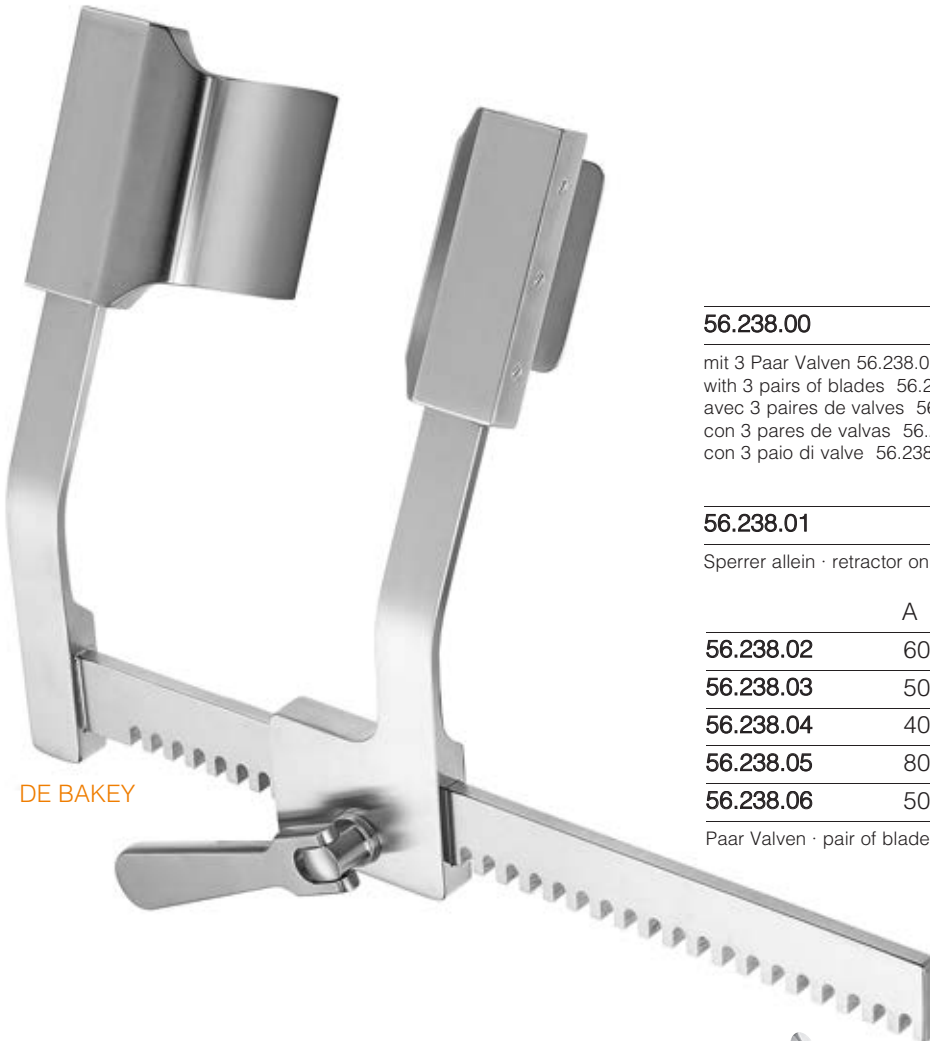

DE BAKEY

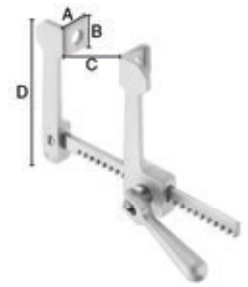

	C	D
<b>56.238.00</b>	150 mm	120 mm

mit 3 Paar Valven 56.238.02 - 56.238.04 ·  
 with 3 pairs of blades 56.238.02 - 56.238.04 ·  
 avec 3 paires de valves 56.238.02 - 56.238.04 ·  
 con 3 pares de valvas 56.238.02 - 56.238.04 ·  
 con 3 paio di valve 56.238.02 - 56.238.04

	C	D
<b>56.238.01</b>	150 mm	120 mm

Sperrer allein · retractor only · écarteur seul · separador suelto · divaricatore solo

	A	B
<b>56.238.02</b>	60 mm	60 mm
<b>56.238.03</b>	50 mm	80 mm
<b>56.238.04</b>	40 mm	100 mm
<b>56.238.05</b>	80 mm	60 mm
<b>56.238.06</b>	50 mm	66 mm

Paar Valven · pair of blades · paire de valves · par de valvas · paio di valve



56.238.02



56.238.03



56.238.04



56.238.05



56.238.06



### Rippensperrer

Rib spreaders  
Écarteurs pour costaux  
Separadores costales  
Divaricatori costali

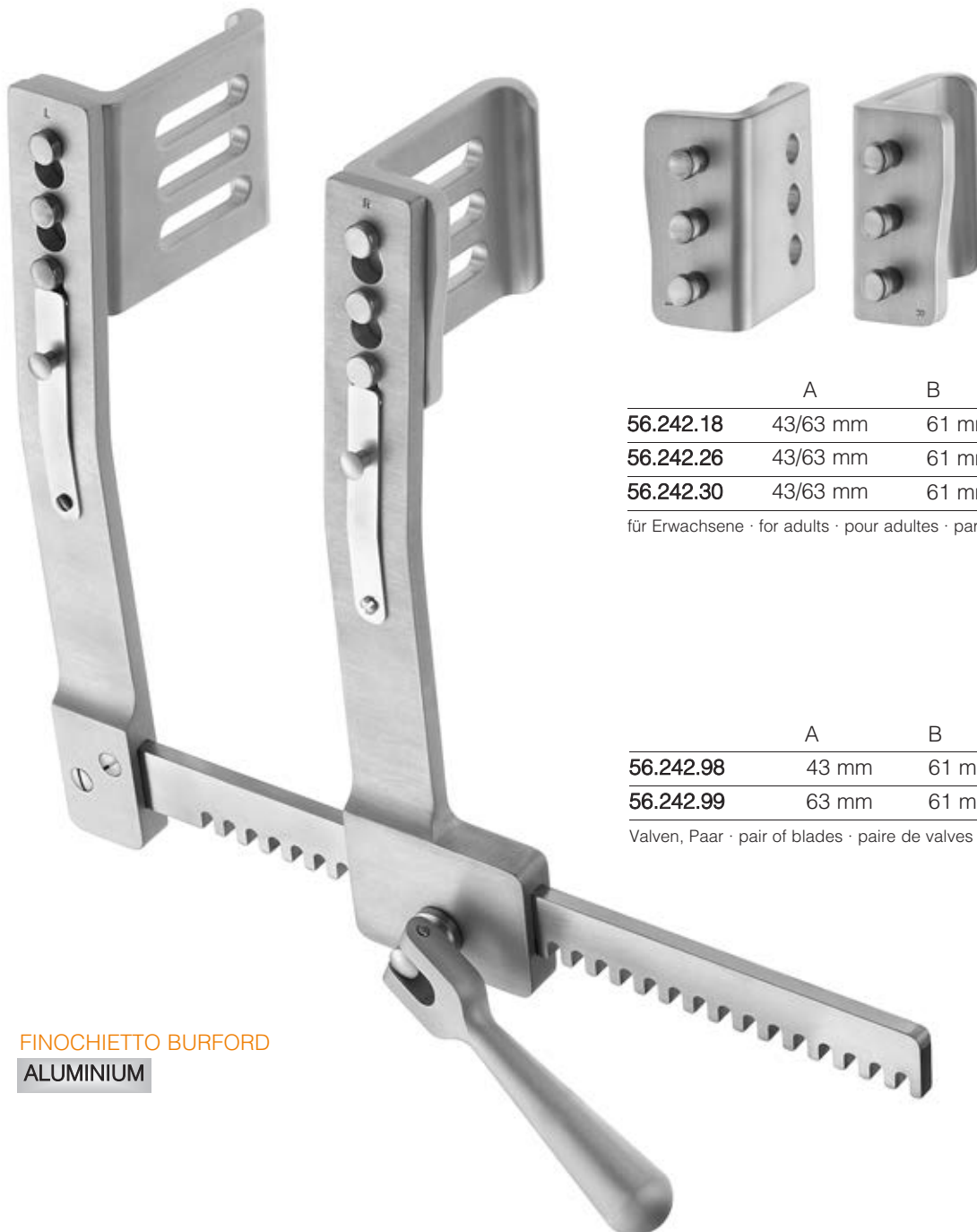
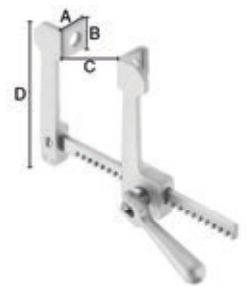

mit 2 Paar Valven  
with 2 pairs of blades  
avec 2 paires de valves  
con 2 pares de valvas  
con 2 paia di valve

	A	B	C	D
<b>56.242.18</b>	43/63 mm	61 mm	200 mm	200 mm
<b>56.242.26</b>	43/63 mm	61 mm	260 mm	200 mm
<b>56.242.30</b>	43/63 mm	61 mm	300 mm	200 mm

für Erwachsene · for adults · pour adultes · para adultos · per adulti

	A	B	C	D
<b>56.242.98</b>	43 mm	61 mm		
<b>56.242.99</b>	63 mm	61 mm		

Valven, Paar · pair of blades · paire de valves · par de valvas · paio di valve

**FINOCHIETTO BURFORD**  
**ALUMINIUM**



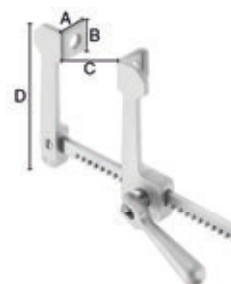

mit 2 Paar Valven  
 with 2 pairs of blades  
 avec 2 paires de valves  
 con 2 pares de valvas  
 con 2 paia di valve

	A	B	C	D
<b>56.244.13</b>	33/43 mm	43 mm	135 mm	118 mm

für Kinder · for children · pour enfants · para niños · per bambini

	A	B	C	D
<b>56.244.98</b>	33 mm	43 mm		
<b>56.244.99</b>	43 mm	43 mm		

Valven, Paar · pair of blades · paire de valves · par de valvas · paio di valve

**FINOCHIETTO BURFORD**  
**ALUMINIUM**



## Rippensperrer

Rib spreaders  
Écarteurs pour costaux  
Separadores costales  
Divaricatori costali

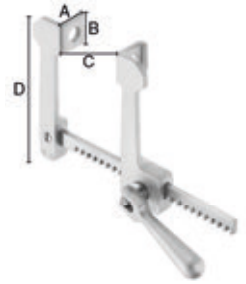
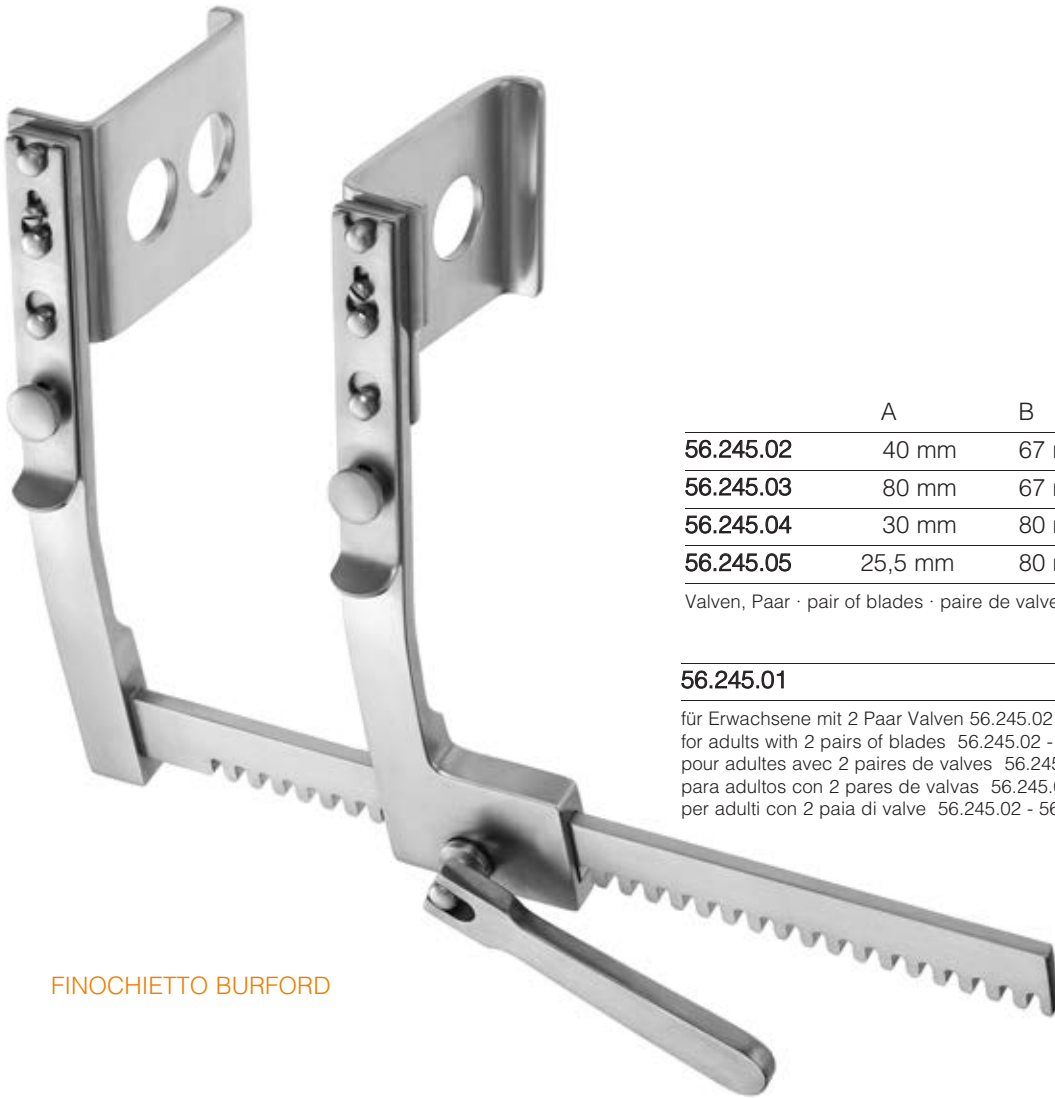

	A	B
<b>56.245.02</b>	40 mm	67 mm
<b>56.245.03</b>	80 mm	67 mm
<b>56.245.04</b>	30 mm	80 mm
<b>56.245.05</b>	25,5 mm	80 mm

Valven, Paar · pair of blades · paire de valves · par de valvas · paio di valve

	C	D
<b>56.245.01</b>	220 mm	300 mm

für Erwachsene mit 2 Paar Valven 56.245.02 - 56.245.03 ·  
for adults with 2 pairs of blades 56.245.02 - 56.245.03 ·  
pour adultes avec 2 paires de valves 56.245.02 - 56.245.03 ·  
para adultos con 2 pares de valvas 56.245.02 - 56.245.03 ·  
per adulti con 2 paia di valve 56.245.02 - 56.245.03

FINOCHIETTO BURFORD



56.245.02



56.245.03



56.245.04



56.245.05

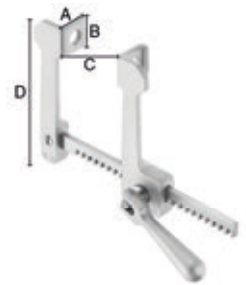

**CASTAÑEDA**  
**ALUMINIUM**

	A	B	C	D
<b>56.250.06</b>	9 mm	34 mm	70 mm	55 mm
für Neugeborene · neonatal · néonatal · recién nacidos · neonatale				

	A	B	C	D
<b>56.250.07</b>	11 mm	45 mm	80 mm	80 mm
für Säuglinge · for babies · pour bébés · para bebés · per neonati				

	A	B	C	D
<b>56.250.12</b>	15 mm	60 mm	120 mm	125 mm
für Kinder · for children · pour enfants · para niños · per bambini				



**WEINBERG**  
**ALUMINIUM**

	A	B	C	D
<b>56.251.01</b>	12 mm	20 mm	95 mm	75 mm
für Kinder · for children · pour enfants · para niños · per bambini				



**Rippensperrer**  
 Rib spreaders  
 Écarteurs pour costaux  
 Separadores costales  
 Divaricatori costali

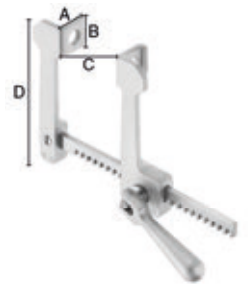
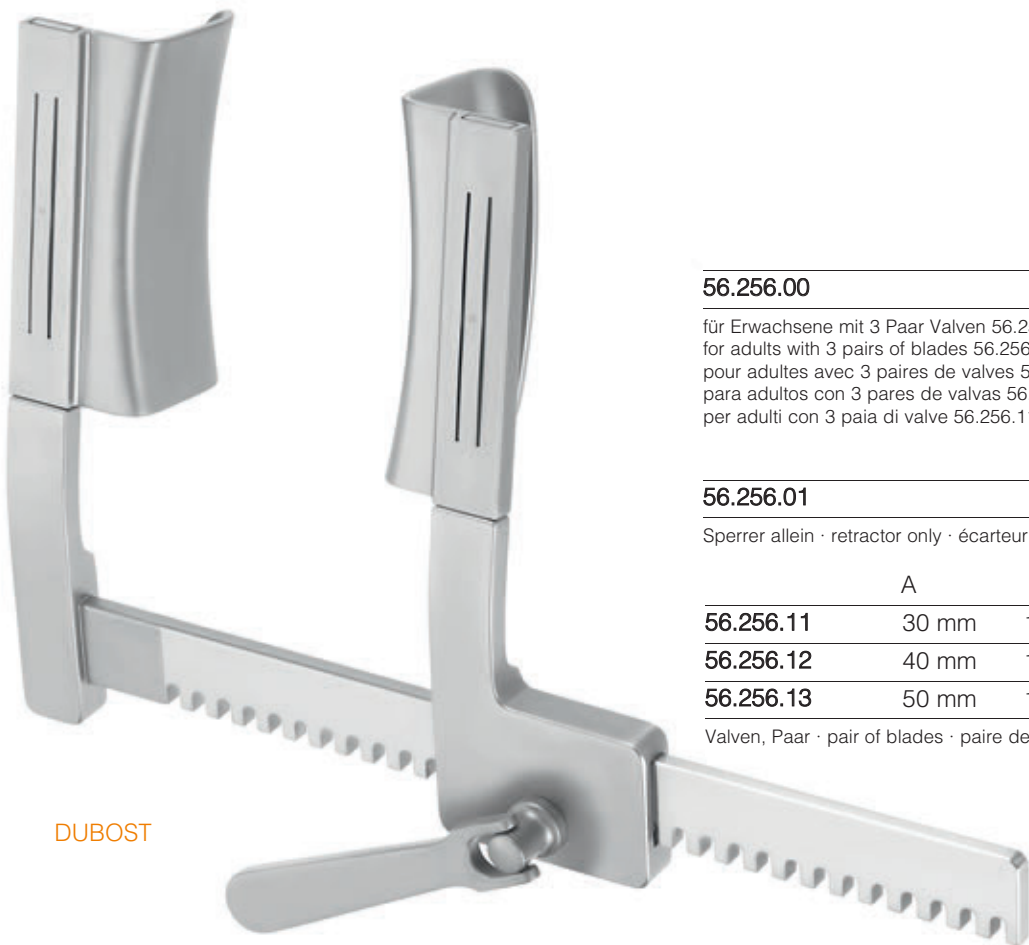

	C	D
<b>56.256.00</b>	160 mm	140 mm

für Erwachsene mit 3 Paar Valven 56.256.11 - 56.256.13 ·  
 for adults with 3 pairs of blades 56.256.11 - 56.256.13 ·  
 pour adultes avec 3 paires de valves 56.256.11 - 56.256.13 ·  
 para adultos con 3 pares de valvas 56.256.11 - 56.256.13 ·  
 per adulti con 3 paia di valve 56.256.11 - 56.256.13

	C	D
<b>56.256.01</b>	160 mm	140 mm

Sperrer allein · retractor only · écarteur seul · separador suelto · divaricatore solo

	A	B
<b>56.256.11</b>	30 mm	100 mm
<b>56.256.12</b>	40 mm	100 mm
<b>56.256.13</b>	50 mm	100 mm

Valven, Paar · pair of blades · paire de valves · par de valvas · paio di valve

DUBOST



56.256.11



56.256.12



56.256.13





	C	D
<b>56.258.00</b>	70 mm	64 mm

für Kleinkinder mit 2 Paar Valven 56.258.14 - 56.258.15 ·  
 for infants with 2 pairs of blades 56.258.14 - 56.258.15 ·  
 pour enfants avec 2 paires de valves 56.258.14 - 56.258.15 ·  
 para niños con 2 pares de valvas 56.258.14 - 56.258.15 ·  
 per bambini con 2 paia di valve 56.258.14 - 56.258.15

	C	D
<b>56.258.01</b>	70 mm	64 mm

Sperrer allein · retractor only · écarteur seul · separador suelto · divaricatore solo

	A	B
<b>56.258.11</b>	10 mm	10 mm
<b>56.258.12</b>	10 mm	15 mm
<b>56.258.13</b>	10 mm	20 mm
<b>56.258.14</b>	15 mm	20 mm
<b>56.258.15</b>	20 mm	20 mm

Valven, Paar · pair of blades · paire de valves · par de valvas · paio di valve



56.258.11



56.258.12



56.258.13



56.258.14



56.258.15



### Rippensperrer

Rib spreaders  
Écarteurs pour costaux  
Separadores costales  
Divaricatori costali

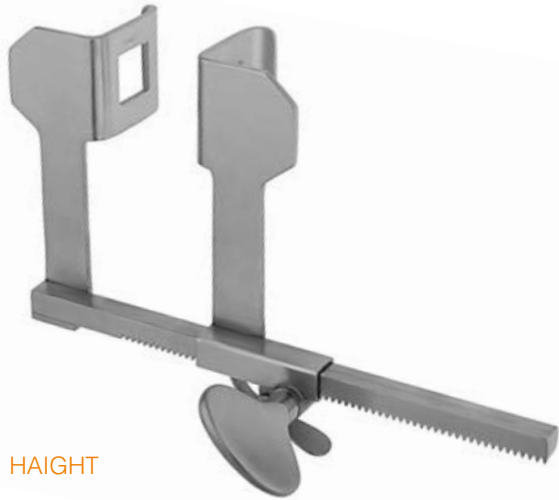
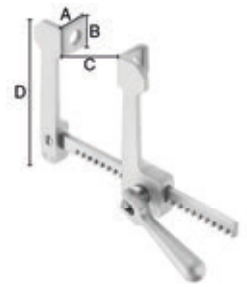

HAIGHT

	A	B	C	D
<b>56.260.09</b>	30 mm	30 mm	90 mm	70 mm

für Kinder · for children · pour enfants · para niños · per bambini



HAIGHT

	A	B	C	D
<b>56.260.15</b>	30 mm	30 mm	115 mm	90 mm

für Kinder · for children · pour enfants · para niños · per bambini

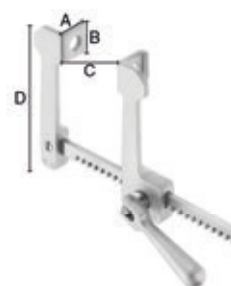

	A	B	C	D
<b>56.262.12</b>	28 mm	32 mm	120 mm	140 mm



	A	B	C	D
<b>56.262.16</b>	48 mm	45 mm	170 mm	110 mm

Laminektomie-Spreizer · Laminectomy spreader · Ecarteur pour laminectomie ·  
 Separador para laminectomia · Divaricatore per laminectomia

BADGLEY



### Rippensperrer

Rib spreaders  
Écarteurs pour costaux  
Separadores costales  
Divaricatori costali

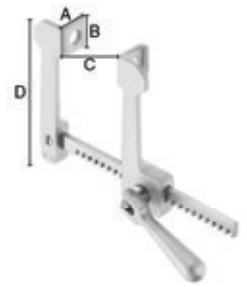

	A	B	C	D
<b>56.264.14</b>	32 mm	19 mm	145 mm	90 mm

für Kinder · for children · pour enfants · para niños · per bambini

TUFFIER



	A	B	C	D
<b>56.264.16</b>	50 mm	45 mm	165 mm	110 mm

für Kinder · for children · pour enfants · para niños · per bambini

TUFFIER



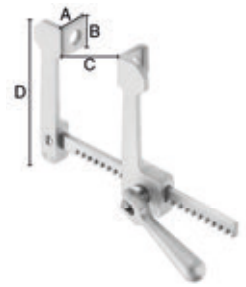

	C	D
<b>56.266.00</b>	150 mm	180 mm

für Erwachsene mit 3 Paar Valven 56.266.30, 56.266.40 & 56.266.50 ·  
 for adults with 3 pairs of blades 56.266.30, 56.266.40 & 56.266.50 ·  
 pour adultes avec 3 paires de valves 56.266.30, 56.266.40 & 56.266.50 ·  
 para adultos con 3 pares de valvas 56.266.30, 56.266.40 & 56.266.50 ·  
 per adulti con 3 paia di valve 56.266.30, 56.266.40 & 56.266.50

	C	D
<b>56.266.09</b>	150 mm	180 mm

Sperrer allein · retractor only · écarteur seul · separador suelto · divaricatore solo

	A	B
<b>56.266.30</b>	30 mm	30 mm
<b>56.266.40</b>	40 mm	40 mm
<b>56.266.50</b>	50 mm	50 mm
<b>56.266.66</b>	66 mm	66 mm

Valven, Paar · pair of blades · paire de valves · par de valvas · paio di valve

DE BAKEY



56.266.30



56.266.50



56.266.40



56.266.66



## Rippensperrer

Rib spreaders  
Écarteurs pour costaux  
Separadores costales  
Divaricatori costali

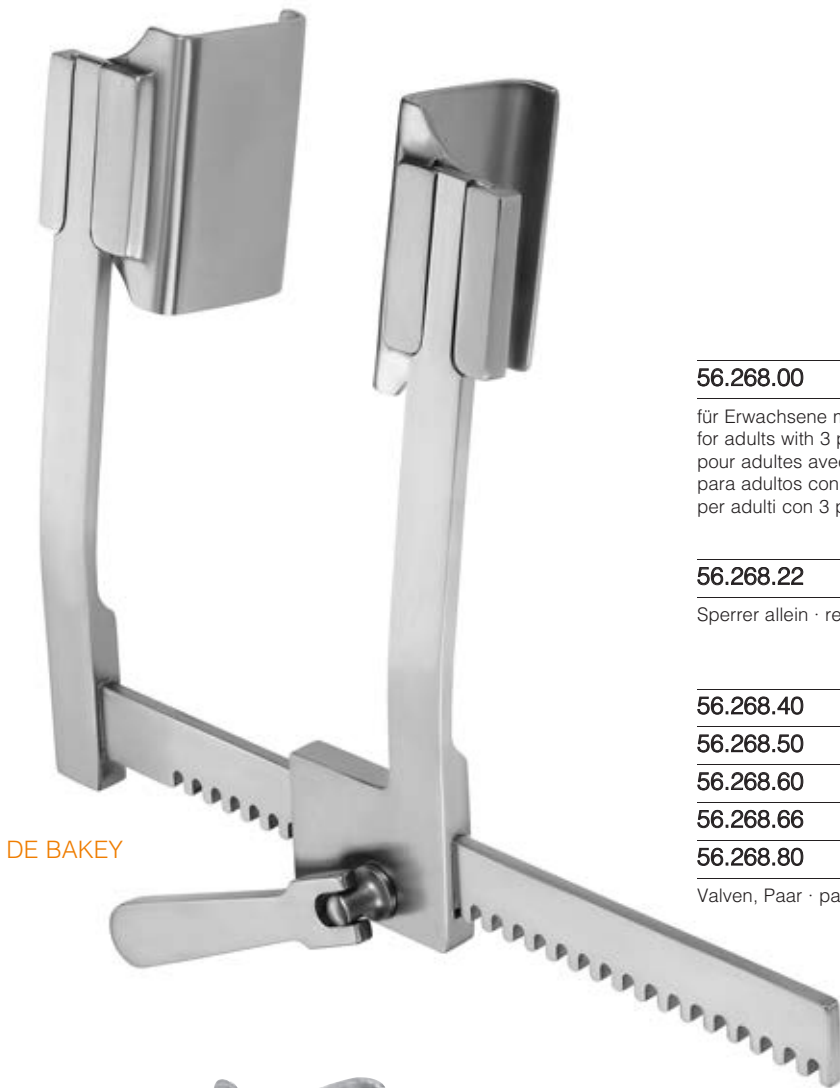

DE BAKEY

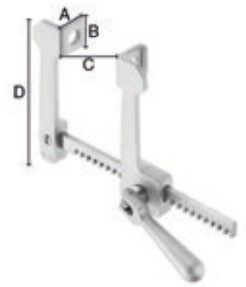

	C	D
<b>56.268.00</b>	200 mm	225 mm

für Erwachsene mit 3 Paar Valven 56.268.40, 56.268.50 & 56.268.60 ·  
for adults with 3 pairs of blades 56.268.40, 56.268.50 & 56.268.60 ·  
pour adultes avec 3 paires de valves 56.268.40, 56.268.50 & 56.268.60 ·  
para adultos con 3 pares de valvas 56.268.40, 56.268.50 & 56.268.60 ·  
per adulti con 3 paia di valve 56.268.40, 56.268.50 & 56.268.60

	C	D
<b>56.268.22</b>	200 mm	225 mm

Sperrer allein · retractor only · écarteur seul · separador suelto · divaricatore solo

	A	B
<b>56.268.40</b>	40 mm	100 mm
<b>56.268.50</b>	50 mm	80 mm
<b>56.268.60</b>	60 mm	60 mm
<b>56.268.66</b>	66 mm	66 mm
<b>56.268.80</b>	80 mm	60 mm

Valven, Paar · pair of blades · paire de valves · par de valvas · paio di valve



56.268.40



56.268.66



56.268.50



56.268.60



56.268.80

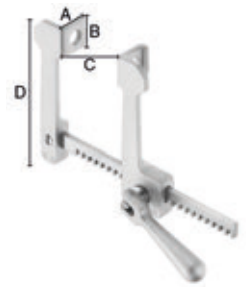

56.270.48



56.270.70

**56.270.00**

mit 2 Paar Valven 56.270.48 & 56.270.70 ·  
 with 2 pairs of blades 56.270.48 & 56.270.70 ·  
 avec 2 paires de valves 56.270.48 & 56.270.70 ·  
 con 2 pares de valvas 56.270.48 & 56.270.70 ·  
 con 2 paia di valve 56.270.48 & 56.270.70

**56.270.10**

Sperrer allein · retractor only · écarteur seul · separador suelto · divaricatore solo

	A	B
<b>56.270.48</b>	48 mm	68 mm
<b>56.270.70</b>	70 mm	75 mm

Valven, Paar · pair of blades · paire de valves · par de valvas · paio di valve

MERCEDES



### Sternumspreizer

Sternal retractors

Écarteurs pour sternum

Separadores para esternón

Divaricatori sternali

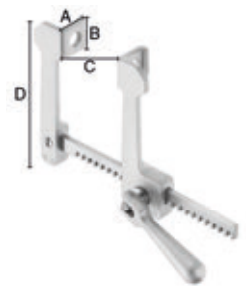

MORSE

	A	B	C	D	E
<b>56.272.15</b>	20 mm	20 mm	160 mm	120 mm	50 mm

für Kinder, mit 2 beweglichen Valven, Abstand der Valven 50 mm ·

for children, with 2 swivel blades 50 mm apart ·

pour enfants, avec 2 lames volantes, 50 mm distance entre les valves ·

para niños, con 2 valvas ágiles, distancia de las valvas 50 mm ·

per bambini, con 2 valve movente, distanza di la valve 50 mm

	A	B	C	D	E
<b>56.272.20</b>	20 mm	28 mm	200 mm	150 mm	72 mm

für Erwachsene, mit 2 beweglichen, Abstand der Valven 72 mm ·

for adults, with 2 swivel blades 72 mm apart ·

pour adultes, avec 2 lames volantes, 72 mm distance entre les valves ·

para adultos, con 2 valvas ágiles, distancia de las valvas 72 mm ·

per adulti, con 2 valve movente, distanza di la valve 72 mm

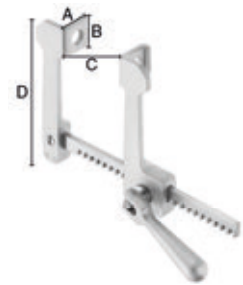

**MORSE-FAVALORO**

	A	B	C	D	E
<b>56.273.16</b>	17 mm	22 mm	160 mm	120 mm	50 mm

für Kinder, mit 2 beweglichen Valven, Abstand der Valven 50 mm ·  
 for children, with 2 swivel blades 50 mm apart ·  
 pour enfants, avec 2 lames volantes, 50 mm distance entre les valves ·  
 para niños, con 2 valvas ágiles, distancia de las valvas 50 mm ·  
 per bambini, con 2 valve movente, distanza di la valve 50 mm

**MORSE-FAVALORO**

	A	B	C	D	E
<b>56.273.15</b>	40 mm	20 mm	155 mm	175 mm	65 mm

für Erwachsene, mit 2 beweglichen Valven, Abstand der Valven 65 mm ·  
 for adults, with 2 swivel blades 65 mm apart ·  
 pour adultes, avec 2 lames volantes, 65 mm distance entre les valves ·  
 para adultos, con 2 valvas ágiles, distancia de las valvas 65 mm ·  
 per adulti, con 2 valve movente, distanza di la valve 65 mm

**MORSE**

	A	B	C	D	E
<b>56.273.20</b>	20 mm	20 mm	155 mm	120 mm	50 mm

für Kinder, mit 2 beweglichen Valven, Abstand der Valven 50 mm ·  
 for children, with 2 swivel blades 50 mm apart ·  
 pour enfants, avec 2 lames volantes, 50 mm distance entre les valves ·  
 para niños, con 2 valvas ágiles, distancia de las valvas 50 mm ·  
 per bambini, con 2 valve movente, distanza di la valvae 50 mm

**MORSE**

	A	B	C	D	E
<b>56.273.19</b>	20 mm	28 mm	210 mm	155 mm	155 mm

für Erwachsene, mit 2 beweglichen Valven, Abstand der Valven 72 mm ·  
 for adults, with 2 swivel blades 72 mm apart ·  
 pour adultes, avec 2 lames volantes, 72 mm distance entre les valves ·  
 para adultos, con 2 valvas ágiles, distancia de las valvas 72 mm ·  
 per adulti, con 2 valve movente, distanza di la valve 72 mm

**MORSE**

	A	B	C	D	E
<b>56.273.30</b>	30 mm	35 mm	200 mm	195 mm	42 mm

für Erwachsene, mit 3 beweglichen Valven, Abstand der Valven 42 mm ·  
 for adults, with 3 swivel blades 42 mm apart ·  
 pour adultes, avec 3 lames volantes, 42 mm distance entre les valves ·  
 para adultos, con 3 valvas ágiles, distancia de las valvas 42 mm ·  
 per adulti, con 3 valve movente, distanza di la valve 42 mm



**ALUMINIUM**



## Sternumspreizer

Sternal retractors  
Écarteurs pour sternum  
Separadores para esternón  
Divaricatori sternali

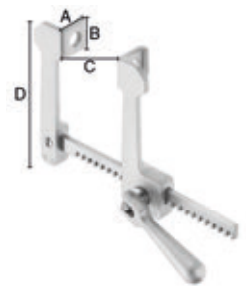

ANKENEY  
ALUMINIUM

	A	B	C	D
<b>56.276.00</b>	25 mm	19 mm	127 mm	114 mm

für Kinder, mit 2 beweglichen Valven ·  
for children, with 2 swivel blades ·  
pour enfants, avec 2 lames volantes ·  
para niños, con 2 valvas ágiles ·  
per bambini, con 2 valve movente

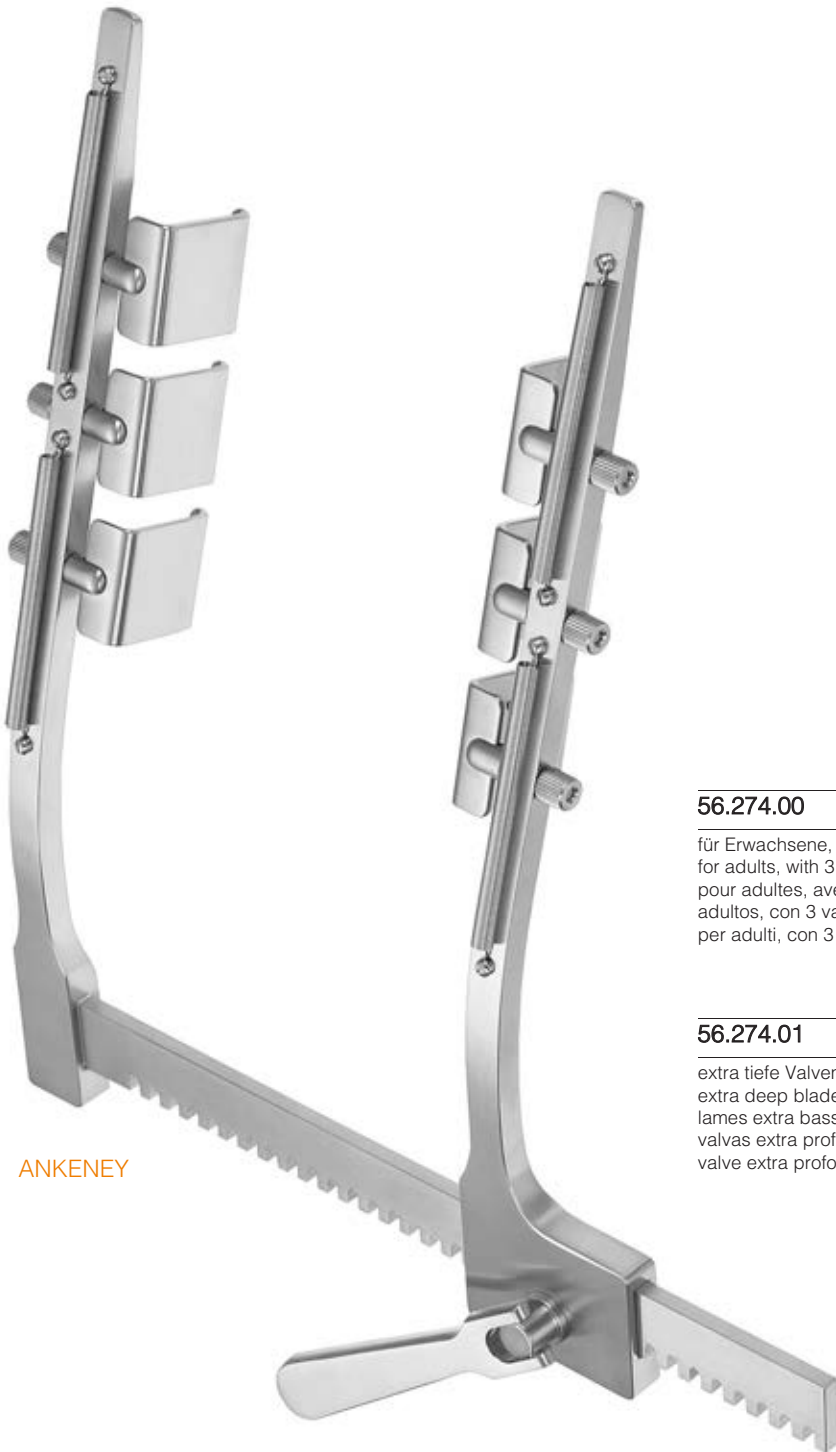
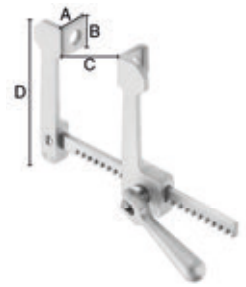

ANKENEY

	A	B	C	D
<b>56.274.00</b>	32 mm	35 mm	178 mm	292 mm

für Erwachsene, mit 3 beweglichen Valven ·  
 for adults, with 3 swivel blades ·  
 pour adultes, avec 3 lames volantes · para  
 adultos, con 3 valvas ágiles ·  
 per adulti, con 3 valve movente

	A	B
<b>56.274.01</b>	52 mm	35 mm

extra tiefe Valven (6 Stück) ·  
 extra deep blades (6 pieces) ·  
 lames extra basses (6 pièces) ·  
 valvas extra profundas (6 piezas) ·  
 valve extra profonde (6 pezzi)



**IMA-Spreizer**

I.M.A. Retractors  
 I.M.A. Écarteurs  
 I.M.A. Separadores  
 I.M.A. Divaricatori

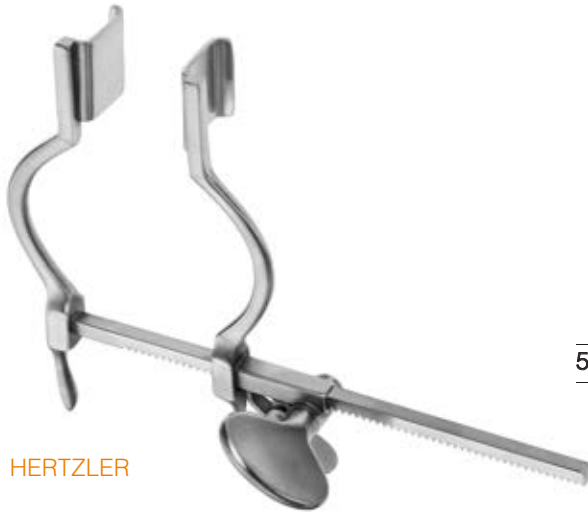

HERTZLER

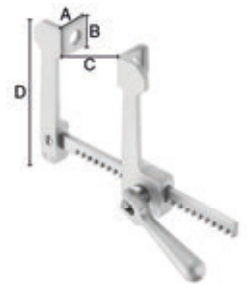

	A	B	C	D
56.278.00	20 mm	25 mm	105 mm	90 mm



	A	B	C
56.269.10	40 mm	100 mm	110 mm

Mammaria Sperrer, komplett · mammaria retractor, complete · Écarteur à mammaria, complet · Seperador mammaria, completo · Divaricatore per mammaria, completo



# 09

◆ SONDEN, DILATATOREN  
PROBES, DILATORS  
SONDES, DILATATEURS  
SONDAS, DILATADORES  
SONDA, DILATATORI



## Venenstripper

Vein strippers  
Stripper à varices  
Sondas para várices  
Sonde per vein

### NABATOFF

#### 20.150.00

Krampfader-Besteck, komplett, bestehend aus:

20.150.02	1 Kunststoff-Sondenspitze
20.150.03	1 Metall-Sondenspitze, ø 3 mm
20.150.06	1 Metallolive, ø 6 mm
20.150.09	1 Metallolive, ø 9 mm
20.150.12	1 Metallolive, ø 12 mm
20.150.80	1 Handgriff
20.150.90	1 Zugseil, 90 cm lang
20.150.99	1 ovales Metalletui

Varicose vein probe set, complete, consisting of:

20.150.02	1 plastic probe tip
20.150.03	1 metal probe tip, ø 3 mm
20.150.06	1 metal olive, ø 6 mm
20.150.09	1 metal olive, ø 9 mm
20.150.12	1 metal olive, ø 12 mm
20.150.80	1 handle
20.150.90	1 flexible cable, 90 cm 1
20.150.99	1 oval metal case

Trousse à varices, complète, composée de:

20.150.02	1 pointe plastique
20.150.03	1 pointe métallique, ø 3 mm
20.150.06	1 olive métallique, ø 6 mm
20.150.09	1 olive métallique, ø 9 mm
20.150.12	1 olive métallique, ø 12 mm
20.150.80	1 manche
20.150.90	1 câble tracteur, flexible, 90 cm
20.150.99	1 boîte métal, ovale

Juego para várices, completo, compuesto de:

20.150.02	1 punta de sonda de plástico
20.150.03	1 punta de sonda de metal, ø 3 mm
20.150.06	1 oliva de metal, ø 6 mm
20.150.09	1 oliva de metal, ø 9 mm
20.150.12	1 oliva de metal, ø 12 mm
20.150.80	1 mango
20.150.90	1 cable tracción, 90 cm
20.150.99	1 caja metálica oval

Astuccio per varici, completo, composto da:

20.150.02	1 punta in materia plastica
20.150.03	1 punta in materia metallo, ø 3 mm
20.150.06	1 oliva in materia metallo, ø 6 mm
20.150.09	1 oliva in materia metallo, ø 9 mm
20.150.12	1 oliva in materia metallo, ø 12 mm
20.150.80	1 manica
20.150.90	1 cavo di trazione, flessibile, 90 cm
20.150.99	1 scatola metallica ovale



### NABATOFF

#### 20.150.00

135 x 100 x 25 mm



20.150.90  
90 cm/36"



20.150.02



20.150.03  
ø 3 mm



20.150.06  
ø 6 mm



20.150.09  
ø 9 mm



20.150.12  
ø 12 mm



20.150.80

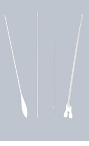

**VARADY**  
**20.151.00**

Krampfader-Besteck, komplett, bestehend aus:

- 20.151.03** 1 Metallolive, ø 3 mm
- 20.151.04** 1 Metallolive, ø 4 mm
- 20.151.05** 1 Metallolive, ø 5 mm
- 20.151.90** 1 Zugseil, 45 cm lang, kunststoffummantelt
- 20.151.99** 1 ovales Metalletui

Varicose vein probe set, complete, consisting of:

- 20.151.03** 1 metal olive, ø 3 mm
- 20.151.04** 1 metal olive, ø 4 mm
- 20.151.05** 1 metal olive, ø 5 mm
- 20.151.90** 1 flexible cable, 45 cm/17½" long, polyethylene coating
- 20.151.99** 1 oval metal case

Trousse à varices, complète, composée de:

- 20.151.03** 1 olive métallique, ø 3 mm
- 20.151.04** 1 olive métallique, ø 4 mm
- 20.151.05** 1 olive métallique, ø 5 mm
- 20.151.90** 1 cable tracteur, flexible, 45 cm, plastifié
- 20.151.99** 1 boîte métal, ovale

Juego para várices, completo, compuesto de:

- 20.151.03** 1 oliva de metal, ø 3 mm
- 20.151.04** 1 oliva de metal, ø 4 mm
- 20.151.05** 1 oliva de metal, ø 5 mm
- 20.151.90** 1 cable traccion, 45 cm, recubierto de plástico
- 20.151.99** 1 caja metálica oval

Astuccio per varici, completo, composto da:

- 20.151.03** 1 oliva in materia metallo, ø 3 mm
- 20.151.04** 1 oliva in materia metallo, ø 4 mm
- 20.151.05** 1 oliva in materia metallo, ø 5 mm
- 20.151.90** 1 cavo di trazione, flessibile, 45 cm, con rivestimento in plastica
- 20.151.99** 1 scatola metallica ovale



**VARADY**  
**20.151.00**



**20.151.03**  
 Ø 3 mm



**20.151.04**  
 Ø 4 mm



**20.151.05**  
 Ø 5 mm

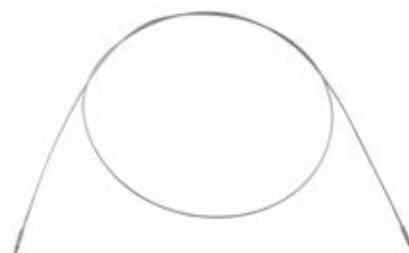

**20.151.90**  
 45 cm/17½"

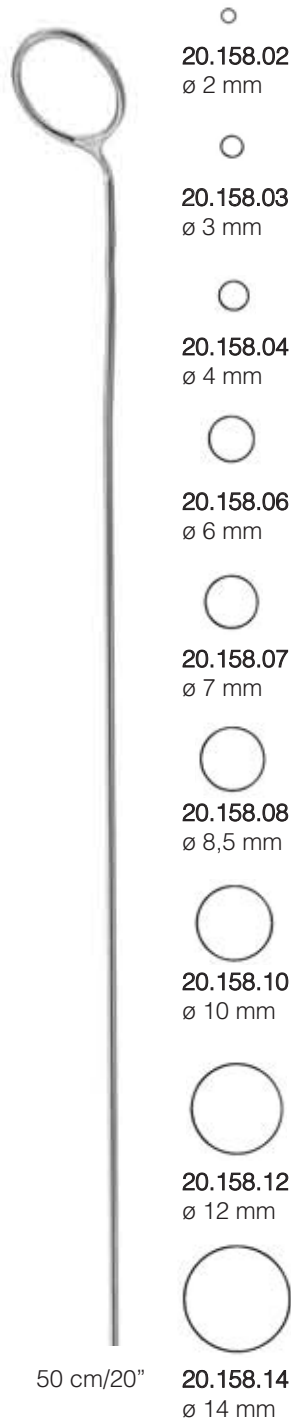
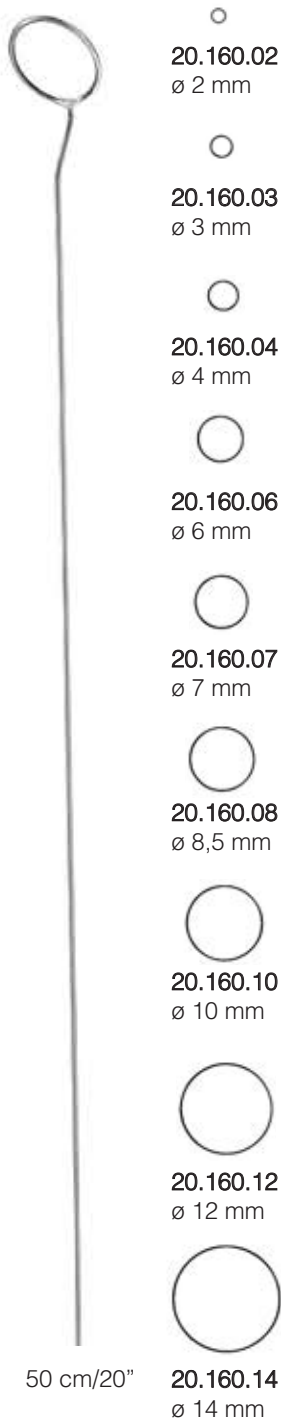

**20.162.12**  
12 cm/4 1/4"

Griff für Enderterektomie-Stripper  
 Handle for endarterectomy strippers  
 Manche pour désoblitérateurs pour endartérectomie  
 Mango para disectores para endarterectomía  
 Manico per disobliteratori per endarterectomia

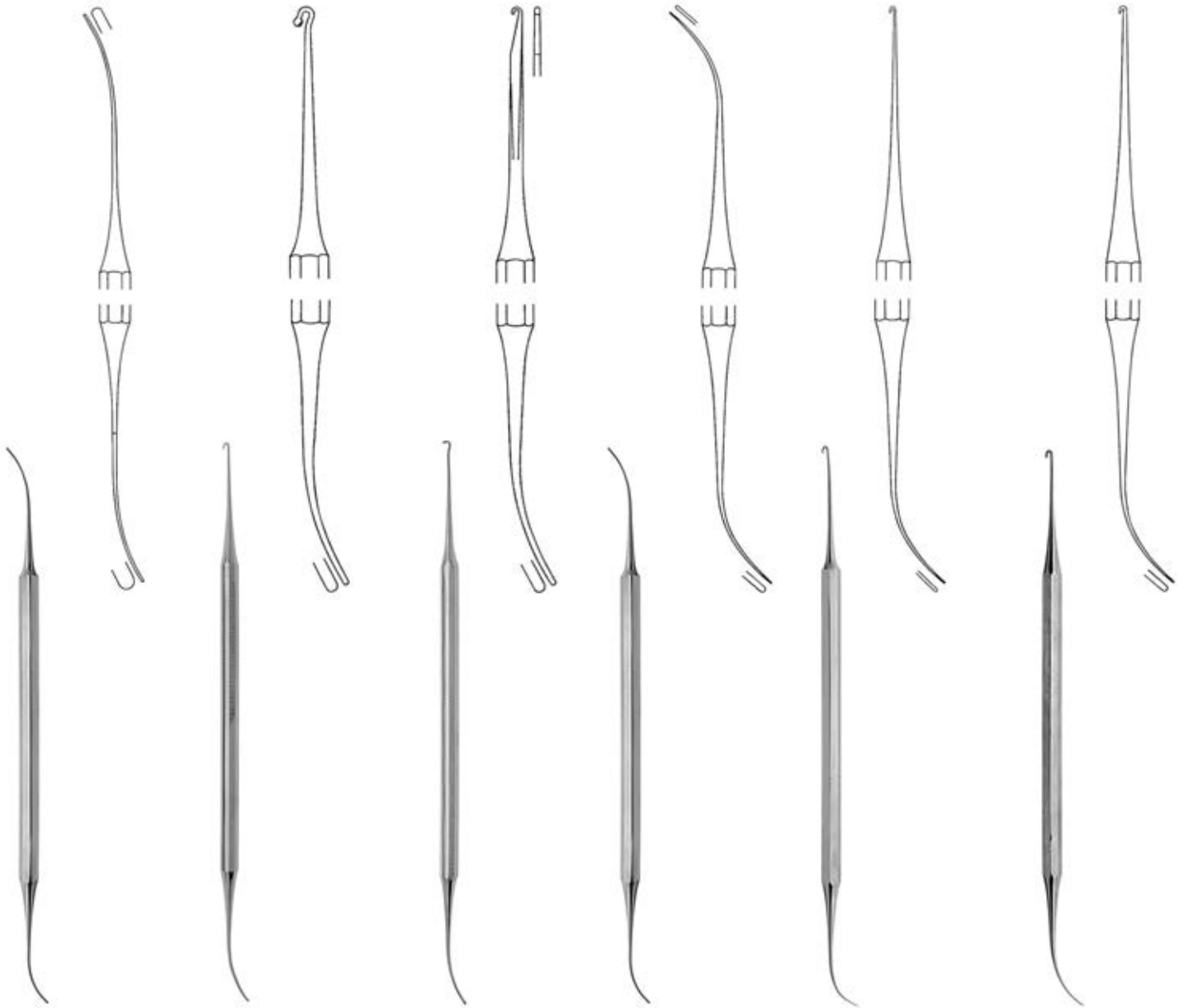

**VARADY**  
**20.167.01**  
 18 cm/7"

Phlebodissektor  
 Phlebodissector  
 Phlebodissecteur  
 Flebodisector  
 Flebodissettore

**VARADY**  
**20.167.02**  
 18 cm/7"

Phleboextraktor  
 Phleboextractor  
 Phleboextracteur  
 Fleboextractor  
 Fleboestrattore

**VARADY**  
**20.167.03**  
 18 cm/7"

Phleboextraktor  
 Phleboextractor  
 Phleboextracteur  
 Fleboextractor  
 Fleboestrattore

**VARADY**  
**20.167.04**  
 18 cm/7"

Mikro-Dissektor  
 Micro Dissector  
 Micro dissector  
 Micro disector  
 Micro-dissettore

**VARADY**  
**20.167.05**  
 18 cm/7"

Mikro-Phleboextraktor  
 Micro-Phleboextractor  
 Micro-Phleboextracteur  
 Micro-Fleboextractor  
 Micro-Fleboestrattore

**VARADY**  
**20.167.06**  
 18 cm/7"

Mini-Phleboextraktor  
 Mini-Phleboextractor  
 Mini-Phleboextracteur  
 Mini-Fleboextractor  
 Mini-Fleboestrattore

**Nerv- und Gefäßhäkchen, Septumelevatorium**

Nerve and vessel hooks, septum elevators  
 Crochets pour nerfs et vaisseaux, éleveurs pour septum  
 Ganchos para nervios y vasos, elevadores para septo  
 Uncini per nervi e vasi, elevatori per setto



18.224.01

18.224.02

**BROM**  
 19 cm/7½"



**CRILE**  
 40.054.20  
 20 cm/8"



**46.560.18**  
 Fig. 1

kleine Biegung  
 small curve  
 courbure petite  
 curva pequeña  
 curva piccola



**46.562.18**  
 Fig. 2

große Biegung  
 large curve  
 courbure grande  
 curva larga  
 curva grande

**GILLIES**  
 18 cm/7"

Septumelevatorium  
 Septum elevators  
 Éleveurs pour septum  
 Elevadores para septo  
 Elevatori per setto

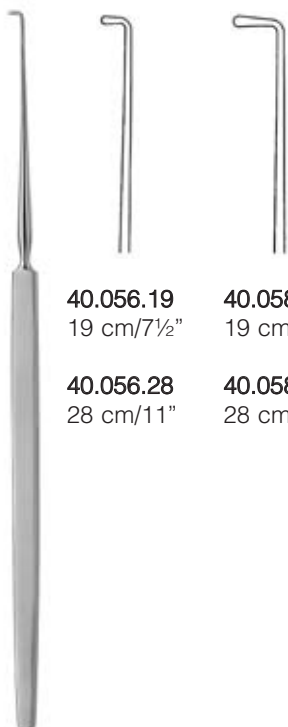

40.056.19  
 19 cm/7½"

40.058.19  
 19 cm/7½"

40.056.28  
 28 cm/11"

40.058.28  
 28 cm/11"

**CUSHING**



**HALLE**  
 40.139.16  
 16 cm/6¼"  
 3,5 mm



scharf  
 sharp  
 pointu  
 agudo  
 acuto

**KILNER**  
 74.103.15  
 14,5 cm/5¾"



Gefäßspreizer  
 Vessel spreader  
 Ecarteur pour vaisseaux  
 Separador para vasos  
 Divaricatore per vasi



**BIEMER**  
**40.066.10**  
 16 cm/6¼"

Gefäßdilatoren  
 Vessel dilators  
 Dilatateurs vasculaires  
 Dilatadores para vasos  
 Diltatori per vasi

Ø 0,5 mm

Ø 1,0 mm

Ø 1,5 mm



**40.066.16**  
 12,5 cm/5"

**40.066.17**  
 12,5 cm/5"

**40.066.18**  
 12,5 cm/5"

Knopfsonde  
 Buttoned probes  
 Sondes boutonnées  
 Sondas abotonadas  
 Sonde bottonute



**JACOBSON**  
**40.066.19**  
 18,5 cm/7¼"

**JACOBSON**  
**40.066.20**  
 18,5 cm/7¼"



**KRAYENBÜHL**  
 19 cm/7½"

**40.065.01**  
 Fig. 1

**40.065.02**  
 Fig. 2

**40.065.03**  
 Fig. 3

**40.065.04**  
 Fig. 4



**40.191.01**  
 19 cm/7½"



**FISCH**  
**40.191.02**  
 19 cm/7½"



**40.868.23**  
 23 cm/9"

**Irisspatel, Elevatorium**

Iris Spatula, elevators  
 Spatule pour l'iris, éleveurs  
 Espátula para iris, elevadores  
 Spatola per iride, elevatori



**TOENNIS**  
 25 cm/10"

**40.141.25**  
 Fig. 1

Dissektoren  
 Dissectors  
 Dissecteurs  
 Disecadores  
 Dissettori



**40.142.25**  
 Fig. 2



**DAVIS**  
**40.151.24**  
 24 cm/9½"

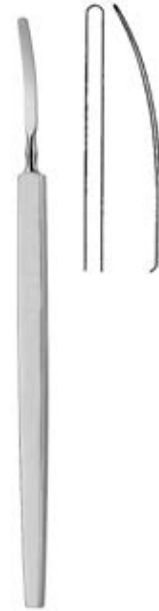

**WECKER**  
**42.461.13**  
 12,5 cm/5"



**WECKER**  
**42.462.13**  
 12,5 cm/5"



**FREER**  
**46.415.18**  
 18,5 cm/7¼"

scharf / stumpf  
 sharp / blunt  
 pointu / mousse  
 agudo / romo  
 acuto / smusso

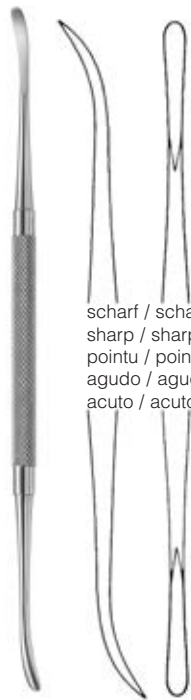

**FREER**  
**46.416.18**  
 18,5 cm/7¼"

scharf / scharf  
 sharp / sharp  
 pointu / pointu  
 agudo / agudo  
 acuto / acuto



**FREER**  
**46.417.19**  
 19 cm/7½"

5 mm

stumpf  
 blunt  
 mousse  
 romo  
 smusso



**FREER**  
**46.419.19**  
 19 cm/7½"

6 mm

scharf  
 sharp  
 pointu  
 agudo  
 acuto





**TUBBS**  
**56.418.42**  
8 - 42 mm

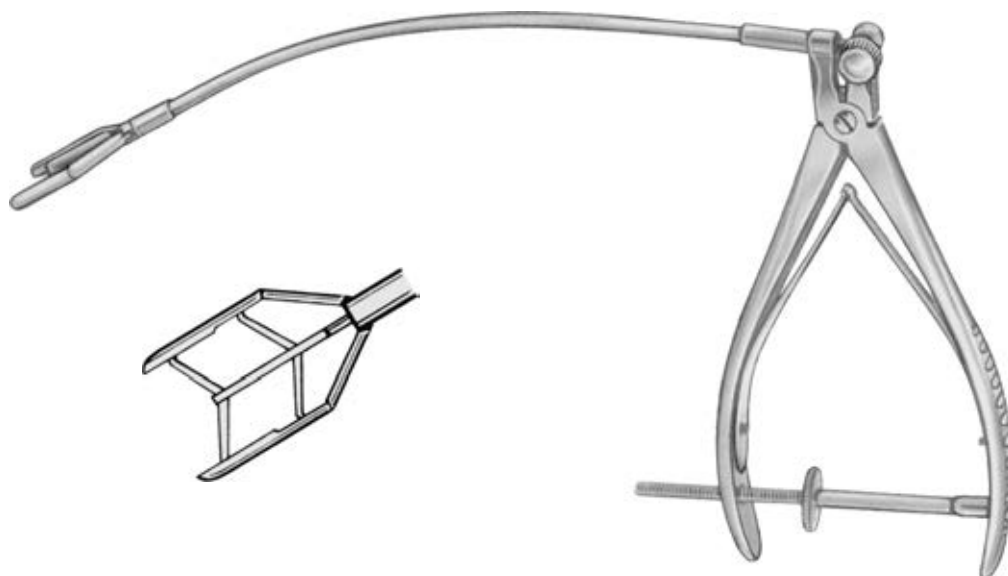

**COOLEY**  
**56.420.15**  
8 - 15 mm

**Tourniquets, Fadenfänger**  
 Tourniquets, ligature catchers  
 Tourniquets, portes-ligatures  
 Torniquetes, porta ligaduras  
 Tornichetti, porta-legature



**56.430.32**  
 ø 3,2 mm

**56.430.64**  
 ø 6,4 mm

flexibel  
 flexible  
 flexible  
 flexibles  
 flessibili

**RUMEL-BELMONT**  
 33 cm/13"



26 cm/10½"



**56.431.15**  
 1,5 mm



**56.431.20**  
 2,0 mm





**56.431.25**  
 2,5 mm

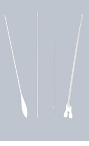

**56.431.30**  
 3,0 mm















biegsam  
 malleable  
 malléable  
 maleables  
 maleabili

			
<b>56.470.05</b> ø 0,5 mm	<b>56.470.10</b> ø 1,0 mm	<b>56.470.15</b> ø 1,5 mm	<b>56.470.20</b> ø 2,0 mm
			
<b>56.470.25</b> ø 2,5 mm	<b>56.470.30</b> ø 3,0 mm	<b>56.470.40</b> ø 4,0 mm	<b>56.470.50</b> ø 5,0 mm

**COOLEY**  
 13 cm/5"



biegsam  
 malleable  
 malléable  
 maleables  
 maleabili

						
	ø 0,5 mm	ø 1,0 mm	ø 1,5 mm	ø 2,0 mm	ø 2,5 mm	ø 3,0 mm
19 cm/7½"	<b>56.472.05</b>	<b>56.472.10</b>	<b>56.472.15</b>	<b>56.472.20</b>	<b>56.472.25</b>	<b>56.472.30</b>
35 cm/14"	<b>56.474.05</b>	<b>56.474.10</b>	<b>56.474.15</b>	<b>56.474.20</b>	<b>56.474.25</b>	<b>56.474.30</b>
						
	ø 3,5 mm	ø 4,0 mm	ø 4,5 mm	ø 5,0 mm	ø 7,0 mm	ø 9,0 mm
19 cm/7½"	<b>56.472.35</b>	<b>56.472.40</b>	<b>56.472.45</b>	<b>56.472.50</b>	<b>56.472.70</b>	<b>56.472.90</b>
35 cm/14"	<b>56.474.35</b>	<b>56.474.50</b>	<b>56.474.45</b>	<b>56.474.50</b>	<b>56.474.70</b>	<b>56.474.90</b>

**DE BAKEY**

## Gefäßdilatoren

Vascular dilators  
Dilatateurs vasculaires  
Dilatadores vasculares  
Dilatatori vascolari



biegsam  
malleable  
malléable  
maleables  
maleabili

**GARRETT**

14 cm/5½"  
21 cm/8¼"

ø 1,0 mm

**56.475.10**  
**56.476.10**

ø 1,5 mm

**56.475.15**  
**56.476.15**

ø 2,0 mm

**56.475.20**  
**56.476.20**

ø 2,5 mm

**56.475.25**  
**56.476.25**



ø 3,0 mm

14 cm/5½"  
21 cm/8¼"

**56.475.30**  
**56.476.30**



ø 3,5 mm

**56.475.35**  
**56.476.35**



ø 4,0 mm

**56.475.40**  
**56.476.50**



ø 4,5 mm

**56.475.45**  
**56.476.45**



ø 5,0 mm

**56.475.50**  
**56.476.50**

Satz mit 9 Stück von 1,0 - 5,0 mm  
Set of 9 pieces from 1,0 - 5,0 mm  
Jeu de 9 pièces de 1,0 - 5,0 mm  
Juego de 9 piezas de 1,0 - 5,0 mm  
Serie di 9 pezzi da 1,0 - 5,0 mm

14 cm/5½"  
21 cm/8¼"

**56.475.00**  
**56.476.00**



Standgefäße  
Dilator & instrument jars  
Réceptier métallique  
Recipientes metálicos  
Recipienti metallici

Ø x H

<b>88.142.02</b>	50 x 100 mm
<b>88.142.03</b>	50 x 130 mm
<b>88.142.04</b>	50 x 175 mm

ø 15 mm

biegsam  
malleable  
malléable  
maleables  
maleabili



**DE BAKEY**  
**56.500.00**  
50 cm/20"



**HEGAR**  
**70.404.14**

Satz mit 14 Stück (ganze Größen)  
 von 4,0 - 17,0 mm ohne Etui

Set of 14 pieces (full sizes)  
 from 4,0 - 17,0 mm without case

Jeu de 14 pièces (tailles entières)  
 de 4,0 - 17,0 mm sans boîte

Juego de 14 piezas (tamaños enteros)  
 de 4,0 - 17,0 mm sin caja

Serie di 14 pezzi (grandezza intera)  
 da 4,0 - 17,0 mm senza scatola



**HEGAR**  
**70.404.26**

Satz mit 26 Stück (ganze Größen)  
 von 1,0 - 26,0 mm ohne Etui

Set of 26 pieces (full sizes)  
 from 1,0 - 26,0 mm without case

Jeu de 26 pièces (tailles entières)  
 de 1,0 - 26,0 mm sans boîte

Juego de 26 piezas (tamaños enteros)  
 de 1,0 - 26,0 mm sin caja

Serie di 26 pezzi (grandezza intera)  
 da 1,0 - 26,0 mm senza scatola

**HEGAR**  
**70.424.08**

Satz mit 8 Stück von  
 3,0 / 4,0 - 17,0 / 18,0 mm ohne Etui

Set of 8 pieces from  
 3,0 / 4,0 - 17,0 / 18,0 mm without case

Jeu de 8 pièces de  
 3,0 / 4,0 - 17,0 / 18,0 mm sans boîte

Juego de 8 piezas de  
 3,0 / 4,0 - 17,0 / 18,0 mm sin caja

Serie di 8 pezzi da  
 3,0 / 4,0 - 17,0 / 18,0 mm senza scatola



**HEGAR**  
**70.424.13**

Satz mit 13 Stück von  
 1,0 / 2,0 - 25,0 / 26,0 mm ohne Etui

Set of 13 pieces from  
 1,0 / 2,0 - 25,0 / 26,0 mm without case

Jeu de 13 pièces de  
 1,0 / 2,0 - 25,0 / 26,0 mm sans boîte

Juego de 13 piezas de  
 1,0 / 2,0 - 25,0 / 26,0 mm sin caja

Serie di 13 pezzi da  
 1,0 / 2,0 - 25,0 / 26,0 mm senza scatola

HEGAR	mm	HEGAR	mm
70.410.01	1	70.415.01	1,5
70.410.02	2	70.415.02	2,5
70.410.03	3	70.415.03	3,5
70.410.04	4	70.415.04	4,5
70.410.05	5	70.415.05	5,5
70.410.06	6	70.415.06	6,5
70.410.07	7	70.415.07	7,5
70.410.08	8	70.415.08	8,5
70.410.09	9	70.415.09	9,5
70.410.10	10	70.415.10	10,5
70.410.11	11	70.415.11	11,5
70.410.12	12	70.415.12	12,5
70.410.13	13	70.415.13	13,5
70.410.14	14	70.415.14	14,5
70.410.15	15	70.415.15	15,5
70.410.16	16	70.415.16	16,5
70.410.17	17	70.415.17	17,5
70.410.18	18	70.415.18	18,5
70.410.19	19	70.415.19	19,5
70.410.20	20		
70.410.21	21		
70.410.22	22		
70.410.23	23		
70.410.24	24		
70.410.25	25		
70.410.26	26		
70.410.27	27		
70.410.28	28		
70.410.29	29		
70.410.30	30		

HEGAR	mm
70.420.01	1/ 2
70.420.03	3/ 4
70.420.05	5/ 6
70.420.07	7/ 8
70.420.09	9/10
70.420.11	11/12
70.420.13	13/14
70.420.15	15/16
70.420.17	17/18
70.420.19	19/20
70.420.21	21/22
70.420.23	23/24
70.420.25	25/26

## Tunnelierbesteck

Tunneling set  
Jeu pour tunnelisation  
Juego de tunelización  
Set per tunnelizzazione



### 56.502.00

Satz komplett mit

- |                      |                       |
|----------------------|-----------------------|
| 2 x <b>56.502.01</b> | Griff Universal 125mm |
| 1 x <b>56.502.05</b> | Schaft gebogen 225 mm |
| 1 x <b>56.502.06</b> | Schaft gerade 225 mm  |
| 1 x <b>56.502.11</b> | Schaft gebogen 540 mm |
| 2 x <b>56.502.55</b> | Schraubolive Ø 5 mm   |
| 2 x <b>56.502.56</b> | Schraubolive Ø 6 mm   |
| 2 x <b>56.502.57</b> | Schraubolive Ø 7 mm   |
| 2 x <b>56.502.58</b> | Schraubolive Ø 8 mm   |
| 2 x <b>56.502.60</b> | Schraubolive Ø 10 mm  |
| 2 x <b>56.502.62</b> | Schraubolive Ø 12 mm  |
| 1 x <b>56.502.65</b> | Venen-Aufsatz         |
| 1 x <b>56.502.70</b> | Luer Adapter          |

Set complete with

- |                      |                        |
|----------------------|------------------------|
| 2 x <b>56.502.01</b> | universal handle 125mm |
| 1 x <b>56.502.05</b> | shaft curved 225 mm    |
| 1 x <b>56.502.06</b> | shaft straight 225 mm  |
| 1 x <b>56.502.11</b> | shaft curved 540 mm    |
| 2 x <b>56.502.55</b> | screw olive Ø 5 mm     |
| 2 x <b>56.502.56</b> | screw olive Ø 6 mm     |
| 2 x <b>56.502.57</b> | screw olive Ø 7 mm     |
| 2 x <b>56.502.58</b> | screw olive Ø 8 mm     |
| 2 x <b>56.502.60</b> | screw olive Ø 10 mm    |
| 2 x <b>56.502.62</b> | screw olive Ø 12 mm    |
| 1 x <b>56.502.65</b> | vein tip               |
| 1 x <b>56.502.70</b> | Luer adaptor           |

Jeu complet avec

- |                      |                        |
|----------------------|------------------------|
| 2 x <b>56.502.01</b> | manche universel 125mm |
| 1 x <b>56.502.05</b> | tige courbe 225 mm     |
| 1 x <b>56.502.06</b> | tige droit 225 mm      |
| 1 x <b>56.502.11</b> | tige courbe 540 mm     |
| 2 x <b>56.502.55</b> | olive Ø 5 mm           |
| 2 x <b>56.502.56</b> | olive Ø 6 mm           |
| 2 x <b>56.502.57</b> | olive Ø 7 mm           |
| 2 x <b>56.502.58</b> | olive Ø 8 mm           |
| 2 x <b>56.502.60</b> | olive Ø 10 mm          |
| 2 x <b>56.502.62</b> | olive Ø 12 mm          |
| 1 x <b>56.502.65</b> | pointe à veines        |
| 1 x <b>56.502.70</b> | raccord Luer           |

Juego completo con

- |                      |                       |
|----------------------|-----------------------|
| 2 x <b>56.502.01</b> | mango universal 125mm |
| 1 x <b>56.502.05</b> | vastago curvo 225 mm  |
| 1 x <b>56.502.06</b> | vastago recto 225 mm  |
| 1 x <b>56.502.11</b> | vastago curvo 540 mm  |
| 2 x <b>56.502.55</b> | oliva Ø 5 mm          |
| 2 x <b>56.502.56</b> | oliva Ø 6 mm          |
| 2 x <b>56.502.57</b> | oliva Ø 7 mm          |
| 2 x <b>56.502.58</b> | oliva Ø 8 mm          |
| 2 x <b>56.502.60</b> | oliva Ø 10 mm         |
| 2 x <b>56.502.62</b> | oliva Ø 12 mm         |
| 1 x <b>56.502.65</b> | cono para venas       |
| 1 x <b>56.502.70</b> | cabeza adaptador Luer |

Serie completo con

- |                      |                         |
|----------------------|-------------------------|
| 2 x <b>56.502.01</b> | manico universale 125mm |
| 1 x <b>56.502.05</b> | aste curvo 225 mm       |
| 1 x <b>56.502.06</b> | aste diritto 225 mm     |
| 1 x <b>56.502.11</b> | aste curvo 540 mm       |
| 2 x <b>56.502.55</b> | olive Ø 5 mm            |
| 2 x <b>56.502.56</b> | olive Ø 6 mm            |
| 2 x <b>56.502.57</b> | olive Ø 7 mm            |
| 2 x <b>56.502.58</b> | olive Ø 8 mm            |
| 2 x <b>56.502.60</b> | olive Ø 10 mm           |
| 2 x <b>56.502.62</b> | olive Ø 12 mm           |
| 1 x <b>56.502.65</b> | testa adattatore veni   |
| 1 x <b>56.502.70</b> | Luer adattatore         |

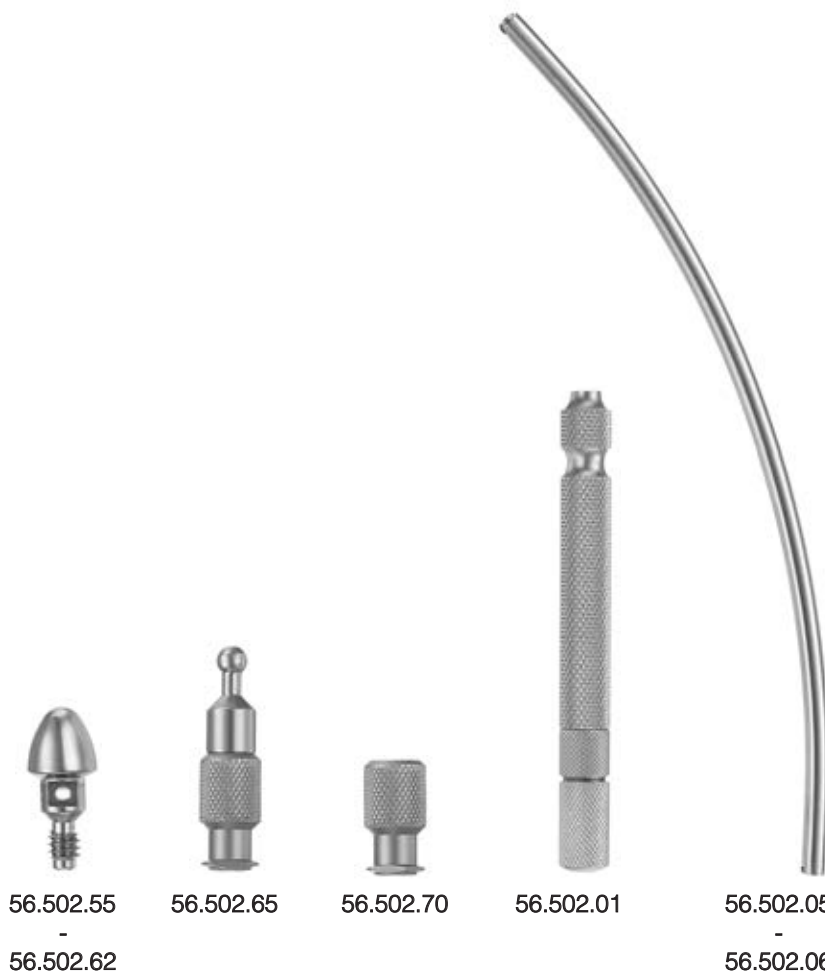

56.502.55

56.502.65

56.502.70

56.502.01

56.502.05

-  
56.502.62

-  
56.502.06



**ROBB**  
 24 cm/10"

5,0 mm



4,0 mm



3,0 mm



2,0 mm

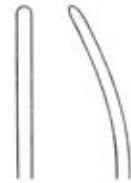

2,5 mm

**56.509.01**

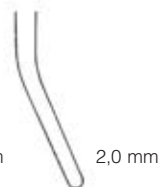

2,0 mm

**56.509.02**

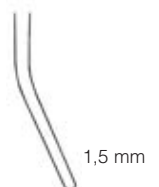

1,5 mm

**56.509.03**

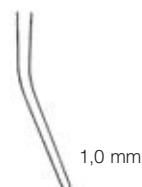

1,0 mm

**56.509.04**



stumpf  
 blunt  
 mousse  
 romo  
 smusso

**56.505.18**  
 18,5 cm/7"

**56.505.21**  
 21,5 cm/8½"



**56.507.14**  
 14 cm/5½"

stumpf  
 blunt  
 mousse  
 romo  
 smusso



**56.507.24**  
 23,5 cm/9"

stumpf  
 blunt  
 mousse  
 romo  
 smusso

**Sonden**

Probes  
Sondes  
Sondas  
Sonde



11,5 cm/4½"	20.110.11	
13 cm/5"	20.110.13	20.112.13
14cm/5½"	20.111.14	20.112.14
14,5 cm/5¾"	20.110.14	
16 cm/6¼"	20.110.16	
18 cm/7"	20.110.18	20.112.18
30 cm/12"	20.110.20	



**LOCKHART- MUMMERY**  
**68.250.01**  
16 cm/6¼"  
Fig. 1



**LOCKHART- MUMMERY**  
**68.250.02**  
16 cm/6¼"  
Fig. 2



**LOCKHART- MUMMERY**  
**68.250.03**  
16 cm/6¼"  
Fig. 3



**LOCKHART- MUMMERY**  
**68.250.04**  
16 cm/6¼"  
Fig. 4



# 10

◆ THORAKOSKOPIE

THORACOSCOPY

THORACOSCOPIE

TORACOSCOPIA

TORACOSCOPIA



## Optikhalter

Endoscope holder  
Crochet pour endoscopes  
Soporte para endoscopio  
Supporto per endoscopio



**18.965.04**

Tischklammer  
Table clamp  
Pince pour la table  
Grapa de mesa  
Grappa di tavola

**18.965.20**

Halter (ohne Tischklammer)  
Holder (without table clamp)  
Crochet (sans pince pour la table)  
Soporte (sin grapa de mesa)  
Grappa (senza grappa di tavola)

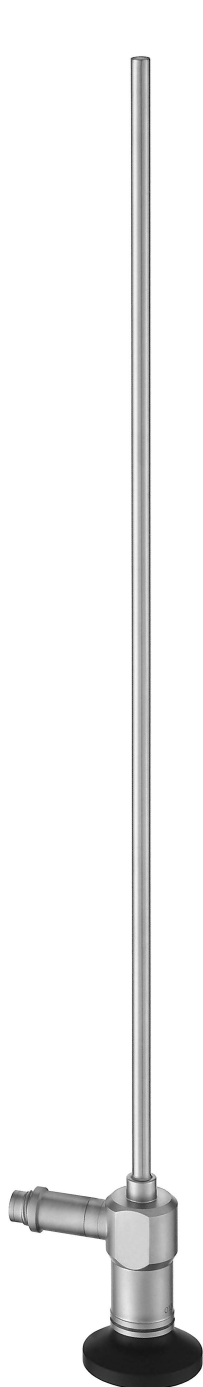
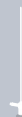

<b>91.205.00</b>	310 mm	0°	Ø 5 mm
<b>91.205.30</b>	310 mm	30°	Ø 5 mm
<b>91.205.45</b>	310 mm	45°	Ø 5 mm

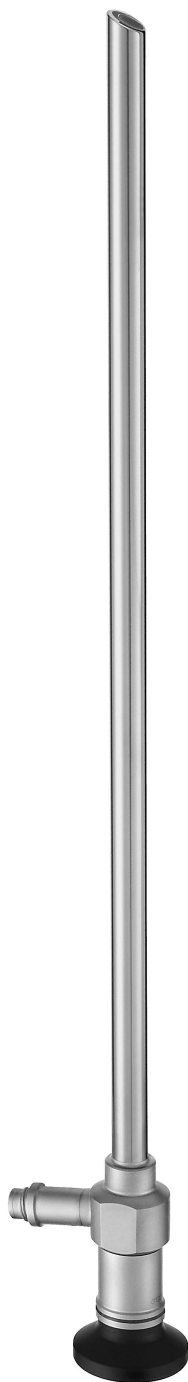

<b>91.210.00</b>	320 mm	0°	Ø 10 mm
<b>91.210.30</b>	320 mm	30°	Ø 10 mm
<b>91.210.45</b>	320 mm	45°	Ø 10 mm

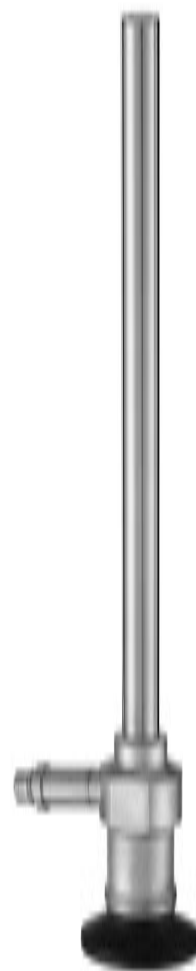

<b>91.215.00</b>	190 mm	0°	Ø 10 mm
<b>91.215.30</b>	190 mm	30°	Ø 10 mm



<b>56.701.06</b>	50 mm	Ø 6 mm
<b>56.701.11</b>	50 mm	Ø 11 mm



<b>56.702.06</b>	70 mm	Ø 6 mm
<b>56.702.11</b>	70 mm	Ø 11 mm
<b>56.703.06</b>	100 mm	Ø 6 mm
<b>56.703.11</b>	100 mm	Ø 11 mm



<b>92.404.01</b>	95 mm	Ø 5,5 mm
<b>92.404.03</b>	101 mm	Ø 11 mm



<b>92.409.41</b>	170 mm	Ø 5,5 mm
<b>92.409.43</b>	189 mm	Ø 11 mm



Insufflationskanüle  
Insufflation cannula  
Canule pour l'insufflation  
Cánula para insuflación  
Cannula per insufflazione

**VERESS**

<b>92.413.01</b>	80 mm	Ø 2 mm
<b>92.413.02</b>	100 mm	Ø 2 mm
<b>92.413.03</b>	120 mm	Ø 2 mm
<b>92.413.04</b>	150 mm	Ø 2 mm

Länge  
 Total length  
 Longueur  
 Largo  
 Lunghezza

Nutzlänge  
 Working length  
 Longueur utile  
 Largo útil  
 Lunghezza utile



**D'AMICO**



45 cm/17 <sup>3</sup> / <sub>4</sub> "	32 cm/12 <sup>1</sup> / <sub>2</sub> "	04.182.01	04.182.02
----------------------------------------	----------------------------------------	-----------	-----------

**WOLF**



31 cm/12 <sup>1</sup> / <sub>4</sub> "	17 cm/6 <sup>3</sup> / <sub>4</sub> "	04.184.02	04.184.03
36 cm/14 <sup>1</sup> / <sub>4</sub> "	22 cm/8 <sup>3</sup> / <sub>4</sub> "	04.184.00	04.184.01

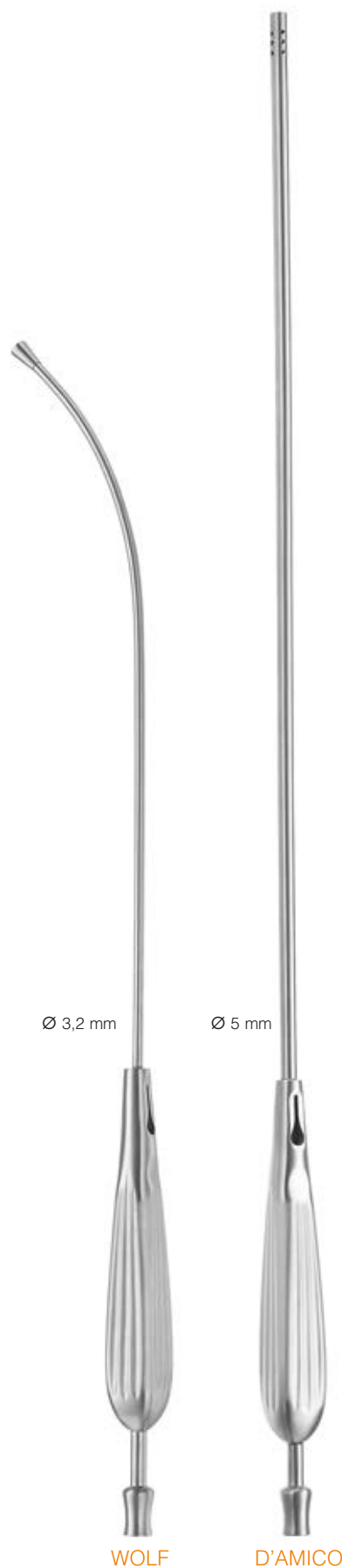

WOLF

D'AMICO



### Fächer-Retractor, schwenkbar

Fan retractor (liver elevator), swivelling

Rétracteur pour le foie, pivotant

Retractor de abanico para hígado, giratorio

Divaricatore a ventaglio per fegato, orientabile



92.909.00 330 mm Ø 10 mm

# 11

◆ INHALTSVERZEICHNIS

INDEX

INDEX

ÍNDICE ALFABÉTICO

INDICE ALPHABETICO

## A

ABRAMS Pleurabiopsie-Nadel.....	8
ACLAND Anlegepinzette für Gefäß-Clips .....	74
ACLAND Approximatoren .....	73
ACLAND Gefäß-Clips.....	72-73
ADSON Arterienklemmen.....	98
ADSON Pinzetten.....	49-50
ADSON Wundspreizer .....	219
ADSON-BABY Arterienklemmen .....	98
ADSON-DE BAKEY Atraumatische Pinzetten .....	61
ADSON-micro Pinzetten .....	49
Akku .....	280
ALEXANDER Raspatorien.....	263
ALLIS Gewebefäßzangen .....	181
ALLIS-BABY Gewebefäßzangen .....	181
ALLISON Lungenspatel .....	224
ALLPORT Wundspreizer .....	216
ALM Wundspreizer.....	216
Anastomoseklemmen.....	117-118, 147, 159-160, 162-163
ANDREWS-PYNCHON Saugrohr .....	5
ANKENEY Sternumspreizer.....	306-307
Anlege- und Entfernungszange für Bulldogklemmen .....	85
Anlegepinzette für Gefäß-Clips.....	65-70, 74
Anlegezange für Clips .....	137
Anlegezange für Ligaturclips .....	75
Anlegezangen für Aneurysmen-Clips .....	76-77
Aorta-Aneurysma-Klemmen.....	123
Aorta-Aneurysma-Klemmen.....	126-129, 131
Aortahaken .....	227-228
Aortaklemmen 123, 125, 147-148	
Aortastanzen .....	17
Approximatoren.....	67-70
Arterienklemmen .....	87-108
Arterienklemmen aus Titan .....	88-89
Atraumatische Gefäßklemmen .....	111-170
Atraumatische Mehrzweckklemmen.....	120, 122, 141, 157, 162, 164-165
Atraumatische Pinzetten .....	57-64
Atraumatische-Bulldogklemmen .....	79-84
Atriumhaken .....	225-226
Aurikelklemmen .....	139
AUSTIN Knüpfpinzetten .....	55
Automatic Drahtzwirbelzange .....	269

## B

BABCOCK Gewebefäßzangen .....	182
BABY-HAIGHT Rippensperrler .....	288
Baby-MIXTER Arterienklemmen .....	106
BABY-POOLE Saugrohr .....	2
BACKHAUS Tuchklemmen .....	171
BADGLEY Rippensperrler.....	299
BAILEY Aortastanze .....	17
BAILEY Rippenkontraktoren .....	223
BAILEY-BABY Rippenkontraktoren .....	223
BAILEY-GIBBON Rippenkontraktoren .....	223
BAINBRIDGE Atraumatische Mehrzweckklemmen .....	122
BALFOUR Bauchdeckenhalter .....	222
BALL AND SOCKET Tuchklemmen .....	172
BANGOLEA Arterienklemmen .....	97
BARRAQUER Mikro-Nadelhalter .....	240
BARRAQUER-TROUTMAN Mikro-Nadelhalter .....	240
Bauchdeckenhalter.....	222
Bauchspatel .....	190-193
BAUMGARTNER Drahtzwirbelzange.....	270
BAUMGARTNER Nadelhalter.....	232
BECK Atraumatische Mehrzweckklemmen.....	141
BECKMANN Wundspreizer .....	220
BECKMANN-ADSON Wundspreizer .....	220
BERLIN Schlauchklemmen .....	109
BERRY Drahtzwirbelzange .....	270
BETHUNE Rippenschere .....	277
BEYER Hohlmeißelzange .....	248
BIEMER Anlegepinzette für Gefäß-Clips .....	65, 67-68
BIEMER Approximatoren .....	69
BIEMER Gefäß-Clips.....	65
BIEMER Gefäßspreizer .....	315
BIEMER Venenschere.....	44
BIEMER-MÜLLER Approximatoren.....	67
BLAKE Embolusfasszange .....	180

BOEHLER Hohlmeißelzange .....	248
BOEHLER Knochensplitterzangen .....	253
BOROWSKI Aortahaken .....	228
BOZEMANN Nadelhalter .....	236
BRAUN-RALPH Saugrohr .....	5
BRAUN-STADLER Schere.....	38
BRIDGE Arterienklemmen.....	104
BROM Gefäßhäkchen .....	314
BROMPTON Rollenklemmen .....	110
Bronchusklemmen .....	114, 176-178
BRUNNER Rippenschere.....	279
BRUNS Scharferlöffel .....	260
Brustfell-Trokare .....	8, 328
BULLDOG Gefäß-Clips .....	71
Bulldogklemmen.....	79-86, 113, 153-154
Bulldogklemmen aus Titam .....	86
Bulldogklemmen mit Ringgriff .....	113

## C

CAROTID Bulldogklemmen.....	79
Carotis-Shuntklemmen.....	149, 164-165
CASTAÑEDA Neonatalund Kinderklemmen .....	166, 169
CASTAÑEDA Rippensperrler .....	295
CASTROVIEJO Mikro-Nadelhalter .....	240-242
CASTROVIEJO-JACOBSON Mikro-Nadelhalter .....	242
Chirurgische Pinzetten .....	48-64
Chirurgische Scheren .....	20-22, 30-32
CHITWOOD-DE BAKEY Atraumatische Pinzetten .....	62
CHITWOOD-DE BAKEY "Needlepulling" Pinzetten .....	62
CLEVELAND Knochensplitterzangen.....	252
Coarctationsklemmen .....	115-116, 143-146, 157-158
COLLIN Rippenschere .....	275
CONE Wundspreizer.....	221
Container für Aneurysmen- & Mikro-Clips .....	78
COOLEY Anastomoseklemmen .....	159-160, 162-163
COOLEY Atraumatische Mehrzweckklemmen .....	157, 162, 164-165
COOLEY Atraumatische Pinzetten.....	60
COOLEY Atriumhaken .....	225-226
COOLEY Bulldogklemmen.....	84, 153-154
COOLEY Carotis-Shuntklemmen .....	164-165
COOLEY Coarctationsklemmen.....	157-158
COOLEY Gefäßdilatoren .....	319
COOLEY Herz-Dilatoren .....	317
COOLEY iliaca-Klemme .....	158
COOLEY Katheterklemmen .....	155
COOLEY Neonatalund Kinderklemmen .....	156, 159, 162, 167-168
COOLEY Rippenschere .....	277
COOLEY Rippensperrler .....	283-285
COOLEY Saugrohr .....	3
COOLEY Tangentialklemmen .....	161
COOLEY-BECK Anastomoseklemmen .....	160
COOLEY-DERRA Anastomoseklemmen .....	162
COPE Pleurabiopsie-Nadel .....	8
Coronararterien-Schere .....	37
CORYLLOS Rippenschere.....	276
CORYLLOS Thoraxhaken .....	213
CRAFOORD Arterienklemmen .....	103
CRAFOORD Thorax-Schere .....	40
CRAFOORD-SELLORS Arterienklemmen .....	103
CRILE Arterienklemmen.....	89
CRILE Gefäßhäkchen.....	314
CRILE-RANKIN Arterienklemmen .....	90
CRILE-WOOD Nadelhalter .....	232
CRILE-WOOD-BABY Nadelhalter .....	233
CUSHING Gefäßhäkchen.....	314
CUSHING Hilären Haken .....	196
CUSHING Pinzetten.....	50
CUSHING Venenhaken .....	195
CUSHING Wundhaken .....	195
CUSHING-KOCHER Wundhaken .....	201
CUSHING-TAYLOR Pinzetten .....	50

## D

D'AMICO Saugrohr.....	2, 329
DALE Peripherale-Gefäßklemmen.....	140
DANDY Arterienklemmen .....	96
DARDIK Atraumatische Mehrzweckklemmen .....	120

DARLING Wundspreizer .....	221
DAVIDSON (Scapula) Wundhaken .....	214
DAVIS Elevatorien .....	316
DE BAKEY Anastomoseklemmen .....	149
DE BAKEY Aorta-Aneurysma- Klemmen .....	126, 128, 132, 141
DE BAKEY Atraumatische Mehrzweckklemmen .....	130, 133
DE BAKEY Atraumatische Pinzetten .....	57-64
DE BAKEY Coarctationsklemmen.....	144-146
DE BAKEY Gefäßdilatoren.....	319-320
DE BAKEY Gefäßschere .....	33, 36, 37
DE BAKEY Heparinnadel .....	7
DE BAKEY iliaca-Klemme .....	124
DE BAKEY Ligaturklemmen .....	149
DE BAKEY Nadelhalter .....	233-234
DE BAKEY Offsetschere .....	37
DE BAKEY Peripherale-Gefäßklemmen .....	119, 121
DE BAKEY Rippensperrler .....	291, 301-302
DE BAKEY Saugrohr .....	5
DE BAKEY-ADSON Atraumatische Pinzetten.....	61
DE BAKEY-BAHNSON Aorta-Aneurysma-Klemmen.....	127
DE BAKEY-BECK Atraumatische Mehrzweckklemmen .....	141
DE BAKEY-DIETHRICH Atraumatische Pinzetten .....	60
DE BAKEY-GERALD Atraumatische Pinzetten.....	61
DE BAKEY-MC QUIGG MIXTER Präparier- und Ligaturklemmen.....	151
DE BAKEY-MIXTER Präparierund Ligaturklemmen.....	152
DE BAKEY-MORRIS Aorta-Aneurysma-Klemmen.....	129
DE BAKEY-REYNOLDS Anastomoseklemmen .....	147
DE BAKEY-RUMMEL Präparier- und Ligaturklemmen.....	151
DE BAKEY-SATINSKY Tangentialklemmen.....	138
DE BAKEY-SEMB Aorta-Aneurysma-Klemmen.....	131
DE BAKEY-SEMB Präparier- und Ligaturklemmen.....	142
DEAVER Wundhaken.....	192-193
DEBAKEY Bulldogklemmen .....	82, 113
DEBAKEY-DIETHRICH Bulldogklemmen .....	81
DERF Nadelhalter .....	231
DERRA Coarctationsklemmen .....	144
DESMARRES Hilären Haken .....	196
DIEFFENBACH Bulldogklemmen .....	85
DIETHRICH Bulldogklemmen .....	81
DIETHRICH Gefäßschere .....	35
DIETRICH Aortaklemmen .....	148
DIETRICH Mikro-Nadelhalter .....	244
Dilatation Pinzetten .....	54
Dissektoren.....	316
Dissektor, mikro .....	313
DOYEN Rippenraspatorien .....	265
Draht, weich .....	268
Drahtkneifzangen .....	271-273
Drahtzwirbelzangen .....	269-270
DUBOST Rippensperrler .....	296
DURANTE Pinzetten .....	52
DUVAL Gewebefäßzangen .....	183

## E

ECHLN Hohlmeißelzange .....	252
EDWARDS Anlegezange für Clips .....	137
EDWARDS Clips.....	137
Elevatoren .....	262-267
Elevatoren .....	314-316
Embolusfasszange .....	180
Endoskope .....	327
Epikardialspreizer.....	215
ETHICON® Ligaturclips aus Titan .....	75

## F

Fächer-Retractor.....	330
Fadenfänger .....	318
Fadenklemme .....	87
Fadenscheren .....	41
FARABEUF Raspatorien.....	262
FARABEUF Wundhaken .....	186
FAVALORO Coronararterien-Schere.....	37
FAVALORO Sternumspreizer .....	305
FERGUSON Knochenhaltezange .....	258



FERGUSSON Saug- und Spülkanüle .....6  
FINOCHIETTO (modif.) Rippensperrer 282  
FINOCHIETTO BABY-HAIGHT  
Rippensperrer ..... 288  
FINOCHIETTO Bronchusklemmen ..... 176  
FINOCHIETTO Lungenlappen-Schere ..... 41  
FINOCHIETTO Nadelhalter ..... 237  
FINOCHIETTO Rippensperrer ..... 282, 287-289  
FINOCHIETTO-BABY Rippensperrer ..... 283  
FINOCHIETTO-BURFORD  
Rippensperrer ..... 290, 292-294  
FINOCHIETTO-INFANT Rippensperrer..... 289  
FINSEN Wundspreizer ..... 215  
FINSTERER Saug- und Spülkanüle ..... 5  
FISCH Gefäßhäkchen..... 315  
Flachzangen..... 268-269  
Flexible Gefäßklemmen ..... 170  
FOERSTER Tupferzange ..... 174  
FOGARTY Gefäßklemmen  
für auswechselbare Mauleinsätze..... 136  
FRAZIER Saugrohr ..... 6  
FREER Elevatorien ..... 316  
FRITSCH Wundhaken..... 188  
FRYKHOLM Hohlmeißelzange ..... 251  
FUCHSIG Arterienklemmen ..... 97

**G**

GARRETT Gefäßdilatoren ..... 320  
GARRETT Heparininjektor ..... 7  
Gefäß-Dilatation Pinzetten ..... 54  
Gefäßdilatoren ..... 315, 319-321  
Gefäßdissektoren..... 323  
Gefäßhäkchen ..... 314-315  
Gefäßklemmen für auswechselbare  
Mauleinsätze ..... 136  
Gefäßklemmen, flexible..... 170  
Gefäßscheren ..... 33-39  
Gefäßscheren, mikro ..... 42-46  
Gefäßspreizer ..... 315  
Gefäßspülkanülen..... 7  
GEMINI Präparier- und Ligaturklemmen..... 99  
GEMINI-mini Präparier- und Ligaturklemmen ... 99  
GERALD Pinzetten..... 51  
GERALD-DEBAKEY Atraumatische Pinzetten ... 61  
Gewebeßzangen ..... 172 - 184  
GIERTZ-STILLE Rippenschere ..... 278  
GIL VERNET Hilus Haken ..... 195  
GILLIES Gefäßhäkchen ..... 314  
GILLIES Nadelhalter ..... 238  
GILLIES Pinzetten ..... 51  
GLASSMAN Atraumatische Pinzetten ..... 61  
GLOVER Anastomoseklemmen ..... 117-118  
GLOVER Bulldogklemmen ..... 79, 83  
GLOVER Coarctationsklemmen ..... 146  
GLOVER-DE BAKEY Atraumatische  
Gefäßklemmen ..... 135  
GLOVER-mini Bulldogklemmen ..... 79  
GLUCK Rippenschere ..... 275  
GOMEL Knüpfpinzetten ..... 55  
GOSLEE Flachzange ..... 269  
GREGORY Profunda-Klemmen..... 152  
GREGORY-“Soft“ Bulldogklemmen ..... 80  
GROSS-MAIER Tupferzange ..... 173  
GUNNER-HEY Rollenklemmen ..... 110

**H**

HABERER Bauchspatel..... 191  
HAIGHT Rippensperrer ..... 298  
HALLE Septumlevatorium ..... 314  
HALSEY Nadelhalter ..... 232  
HALSTED-MOSQUITO Arterienklemmen ..... 88  
HALSTED-MOSQUITO Atraumatische  
Gefäßklemmen ..... 111  
HALSTED-MOSQUITO-micro  
Arterienklemmen ..... 87  
Halter für Optiken ..... 326  
Hämmer ..... 261  
Handgriff für Ringstripper ..... 312  
HARKEN Aurikelklemmen ..... 139, 180  
HARRINGTON Bronchusklemmen..... 176  
HARRINGTON Wundhaken..... 194  
HARRINGTON-BABY Wundhaken ..... 194

HARTMANN Arterienklemmen ..... 87  
HARTMANN-micro Arterienklemmen..... 87  
HARVEY Drahtkneifschere ..... 271  
HARVEY Drahtkneifzange ..... 273  
HEANEY Nadelhalter ..... 236  
HEGAR Dilatoren ..... 321  
HEGAR-Vascular Nadelhalter ..... 235  
HEISS Arterienklemmen ..... 97  
HENLEY Wundspreizer ..... 217  
Heparininjektor ..... 7  
Heparinnadel ..... 7  
HERTZLER Rippensperrer ..... 308  
Herz-Dilatoren ..... 317  
Herzklappen-Fasszange ..... 184  
HESS (DEBAKEY) Bulldogklemmen ..... 85  
HIBBS Wundhaken ..... 212  
Hilus Haken ..... 195-196  
HOHENFELLNER Gefäßschere ..... 37  
Hohlmeißelzange ..... 248  
Hohlmeißelzangen ..... 248-252  
HOPT Atraumatische Gefäßklemmen ..... 112

**I**

Iliaca-Klemme..... 124, 158  
IMA Epikardialspreizer ..... 215  
IMA-Spreizer..... 286, 308  
In-situ-Venenklappe Schere ..... 39  
Insufflationskanüle..... 328  
Intima-Spatel ..... 323  
IRIS Scheren ..... 32  
Irisspatel ..... 316  
ISRAEL Wundhaken ..... 205

**J**

JACOBSON Arterienklemmen ..... 98  
JACOBSON Knopfsonde ..... 315  
JACOBSON Mikro-Nadelhalter..... 242, 245  
JACOBSON-MOSQUITO Arterienklemmen..... 98  
JANSEN Pinzetten ..... 50  
JAVID Carotis-Shuntklemmen ..... 149  
JOHNS HOPKINS Bulldogklemmen ..... 85  
JONES Tuchklemmen ..... 171  
JONES-Clip Tuchklemmen ..... 171  
JORGENSEN Thorax-Schere ..... 41  
JOSEPH Scheren..... 30  
JUDD-ALLIS Gewebeßzangen ..... 181

**K**

KADER Wundhaken ..... 190  
KANTROWITZ Arterienklemmen..... 105  
Kanüle für Insufflation..... 328  
Katheterklemmen ..... 155  
KELLY Arterienklemmen ..... 89  
KELLY Präparier- und Ligaturklemmen ..... 105  
KELLY Wundhaken ..... 189, 209  
KELLY-RANKIN Arterienklemmen ..... 89  
KILNER Gefäßhäkchen ..... 314  
KILNER Scheren..... 31  
Klemmen, arterian..... 87-108  
KLINKENBERGH LOTH Thorax-Schere ..... 41  
Knochendraht..... 268  
Knochenhalte-zangen ..... 258-259  
Knochensplitterzangen ..... 252-257  
Knopfsonde ..... 315  
Knüpfpinzetten ..... 54-56, 63-64  
KOCHER Arterienklemmen ..... 92-93  
KOCHER Wundhaken ..... 200-201, 204, 206  
KOCHER-LANGENBECK Wundhaken ..... 202  
KOCHER-NIPPON Arterienklemmen ..... 94  
KOCHER-WAGNER Wundhaken ..... 208  
KOENIG Wundhaken ..... 201  
KOERTE Wundhaken ..... 210  
Kopfschneider ..... 273  
KRAYENBÜHL Gefäßhäkchen ..... 315

**L**

Ladegerät ..... 280  
LAHEY Arterienklemmen ..... 108  
LAMBER-KAY Aorta-Anastomoseklemmen ..... 123  
LAMBOTTE Raspatorien ..... 262  
LANE Gewebeßzangen ..... 172  
LANGENBECK Knochenhalte-zange ..... 258  
LANGENBECK Raspatorien ..... 262  
LANGENBECK Wundhaken..... 199, 201  
LAWRENCE Arterienklemmen..... 104  
LAZAR Knüpfpinzetten..... 55

LEBSCHKE Rippenschere ..... 278  
LEBSCHKE Sternummeißel ..... 261  
LEES Bronchusklemmen ..... 114  
LEKSELL Hohlmeißelzange ..... 251  
LEKSELL-STILLE Hohlmeißelzange ..... 251  
LELAND-JONES Atraumatische  
Mehrzweckklemmen ..... 122  
LELAND-JONES Peripheral-Gefäßklemmen ... 121  
LEMMON Rippenkontraktoren ..... 223  
LERICHE Arterienklemmen ..... 96  
LERICHE Wundhaken ..... 210  
LEXER Präparierscheren ..... 25  
LEXER-FINO Präparierscheren ..... 24  
LIDDLE Aortaklemmen ..... 123  
Ligaturclips aus Titan ..... 75  
Ligaturklemmen..... 149  
LISTER Präparier- und Ligaturklemmen ..... 175  
LISTON Knochensplitterzangen ..... 253  
LITTAUER Fadenscheren ..... 41  
LITTLEWOOD Gewebeßzangen ..... 184  
LOCKHART-MUMMERY Sonde ..... 324  
LORNA Tuchklemmen..... 172  
LOVE-GRUENWALD Aortastanze ..... 17  
LOVELACE Arterienklemmen ..... 96  
LOVELACE Lungenfasszangen ..... 175  
LUCAE Pinzetten..... 50  
Lungenfasszangen ..... 175  
Lungenlappen-Schere ..... 41  
Lungenspatel ..... 224

**M**

Mammaria-Sperrer ..... 286, 308  
MARQUARDT Hohlmeißelzange..... 248  
MARTIN Bauchspatel ..... 191  
MARTIN Tupferzange..... 174  
MARTIN Wundhaken ..... 211  
MARTIN-WYLIE Peripheral-Gefäßklemmen ..... 150  
MATHIEU Nadelhalter ..... 237  
MATSON Raspatorien ..... 263  
MATSON-ALEXANDER Raspatorien ..... 263  
MAYO Präparierscheren ..... 23  
MAYO-HEGAR Nadelhalter ..... 233  
MAYO-STILLE Präparierscheren..... 24  
McINDOE Gefäßschere ..... 38  
MCINDOE Knochensplitterzangen..... 254  
McINDOE Pinzetten ..... 52  
McQUIGG-MIXTER Arterienklemmen..... 107  
MEEKER Arterienklemmen ..... 104  
MEHDORN Anlegepinzette für Gefäß-Clips ..... 66  
MEHDORN Gefäß-Clips ..... 66  
MERCEDES Thoraxretraktor..... 303  
METZENBAUM FINO Präparierscheren ..... 27-30  
METZENBAUM Präparierscheren ..... 26  
METZENBAUM-NELSON Präparierscheren ..... 30  
Microvascular Nadelhalter ..... 235  
MIDDELDORPF Wundhaken ..... 187  
Mikro-Bulldogklemmen ..... 79, 86  
Mikro-Gefäßscheren ..... 42-46  
Mikro-Nadelhalter ..... 239-246  
Mikro-Pinzetten ..... 54-64  
MIKULICZ Peritoneumklemmen ..... 108  
MIKULICZ Wundhaken ..... 207  
MIKULICZ-Baby Peritoneumklemmen ..... 108  
MILLESI Mikroscheren ..... 44  
MILLS Gefäßschere ..... 36  
MINI (YASARGIL) Aneurysmen-Clips..... 76-77  
MIXTER Arterienklemmen ..... 106-107  
MIXTER-BABY Arterienklemmen ..... 106  
MIXTER-O'SHAUGNESSY Arterienklemmen ... 107  
MOCK-DEBAKEY Heparinnadel ..... 7  
MORSE Sternumspreizer ..... 304-305  
MORSE-FAVALORO Sternumspreizer ..... 305  
MÜLLER Approximatoren ..... 68  
MÜLLER Gefäß-Clips ..... 71  
MURPHY Wundhaken ..... 198

**N**

NABATOFF Venenstripper ..... 310  
Nadelhalter ..... 229-246  
Nadelhalter aus Titan..... 246  
Nadelhalter, diamantiertes Maul .....  
..... 242-244, 246  
Nadelhalter, mikro ..... 239-246  
“Needlepulling“ chirurgische Pinzetten..... 62

NEIVERT Nadelhalter .....	232	RYDER Nadelhalter .....	234	Thorakoskopie .....	325-330
NELSON Brustfell-Trokar .....	8	RYDER-Vascular Nadelhalter .....	235	Thoraxhaken .....	212-213
NELSON Pinzetten .....	52			Thoraxretractor .....	303
Neonatal- und Kinderklemmen .....	156, 159, 162, 166-169	<b>S</b>		Thorax-Scheren .....	40-41
Nerv-Präparierschere .....	38	Säge, Sternal .....	280	THOREK Thorax-Schere .....	40
<b>O</b>		SANTULLI Bulldogklemmen .....	80	TOENNIS Dissektoren .....	316
OCHSNER Aortaklemmen .....	148	SANVENERO Scheren .....	30	TOENNIS Nadelhalter .....	237
Offsetschere .....	37	SAROT Arterienklemmen .....	103	TOENNIS-ADSON Gefäßschere .....	38
OLSEN HEGAR Nadelhalter .....	238	SAROT Bronchusklemmen .....	178	TOHOKU Tuchklemmen .....	172
Optiken .....	327	SAROT Nadelhalter .....	237	TOLEDO Mikro-Gefäßscheren .....	43
Optikenhalter .....	326	SATINSKY Anastomoseklemmen .....	179	TOLEDO Mikro-Nadelhalter .....	243
Organfasszange .....	140	SATINSKY Bulldogklemmen .....	79	TOLEDO Pinzetten, mikro .....	56
Orthopädie .....	247-280	SATINSKY Gefäßschere .....	39	Tourniquets .....	318
OVERHOLT Arterienklemmen .....	101-102	SATINSKY Tangentialklemmen .....	134	Trays für Aneurysmen- & Mikro-Clips .....	78
OVERHOLT Raspatorien .....	264	SAUERBRUCH Hohlmeißelzange .....	250	Trokare für Brustfell .....	8, 328
OVERHOLT-BABY Arterienklemmen .....	101	SAUERBRUCH Rippenschere .....	278	TUBBS Herz-Dilatatoren .....	317
OVERHOLT-fino Arterienklemmen .....	101	SAUERBRUCH Wundhaken .....	214	Tuchklemmen .....	171-172
OVERHOLT-GEISSENDOERFER		Saugrohre .....	2-7, 329	TUFFIER Rippensperrer .....	300
Arterienklemmen .....	100	Scapula Wundhaken .....	214	Tunnelier .....	322
OVERHOLT-MIXTER Arterienklemmen .....	107	SCHAEDEL Tuchklemmen .....	171	Tupferzangen .....	173-174
<b>P</b>		Scharferlöffel .....	260		
PARKER-LANGENBECK Wundhaken .....	187	SCHAEDEL Scharferlöffel .....	260	<b>U</b>	
PEAN Arterienklemmen .....	91, 93	SCHAEDEL Gewebefasszangen .....	183	Uhrmacher-Pinzetten .....	53
PEAN Atraumatische Gefäßklemmen .....	111	Schere, Coronararterien .....	37	ULRICH Tupferzange .....	173
PEAN-NIPPON Arterienklemmen .....	94	Schere, In-situ Venenklappe .....	39	ULTRA-LIGHT Atraumatische Pinzetten .....	62
PEERS-BERTRAM Tuchklemmen .....	171	Schere, Lungenlappen .....	41	US-Army (PARKER-LANGENBECK)	
PENNINGTON Arterienklemmen .....	96	Schere, Nerv-präparier .....	38	<b>V</b>	
Peripherale-Gefäßklemmen .....	119, 121, 140, 150	Schere, Offset .....	37	VANDERBILT Arterienklemmen .....	102
Peritoneumklemmen .....	108	Schere, Sternal .....	274	VANNAS Mikroscheren .....	44
PERWITZCHKY Scheren .....	32	Scheren .....	20-46	VARADY Dissektor, mikro .....	313
Phlebodissektor .....	313	Scheren aus Titan .....	46	VARADY Phlebodissektor .....	313
Phleboextraktor .....	313	Scheren, SuperCut .....	20-23, 25-26, 34	VARADY Phleboextraktor .....	313
Pinzetten .....	48-64	Schlauchklemmen .....	109	VARADY Varizeninstrumente .....	313
Pinzetten aus Titan .....	58, 64	SCHMID Gefäßspülkanüle .....	7	VARADY Venenstripper .....	311
Pinzetten mit Gewicht .....	63	SCHNIDT Präparier- und Ligaturklemmen .....	175	Varizeninstrumente .....	313
Pinzetten, Atraumatische .....	57-64	SCHOENBORN Wundhaken .....	195	Vena Cava-Klemmen .....	138, 141, 155, 179
Pinzetten, diamantiertes Maul .....	57, 63-64	SCHUMACHER Sternumschere .....	274	Venenhaken .....	195
Pinzetten, mikro .....	54-64	Seitenschneider .....	271-273	Venenkanülen .....	7
Pleurabiopsie-Nadel .....	8	SELLORS Rippenkonraktoren .....	223	Venenklappeschere .....	39
POOLE Saugrohr .....	2	SELMAN Pinzetten .....	50	Venenschere .....	44
POPPEL Saugrohr .....	6	SEMB Hohlmeißelzange .....	252	Venenstripper .....	310-312
POTTS Coarctationsklemmen .....	115-116, 143	SEMB Knochenhalte zange .....	259	VOLKMANN Scharferlöffel .....	260
POTTS-DE MARTEL Gefäßschere .....	36	SEMB Knochensplitterzangen .....	257	VOLKMANN Wundhaken .....	197-198
POTTS-SMITH Gefäßschere .....	33-34, 36	SEMB Lungenspatel .....	224	VOLLMAR Handgriff für Ringstripper .....	312
POTTS-SMITH Pinzetten .....	48	SEMB Präparier- und Ligaturklemmen .....	178	VOLLMAR Ringstripper .....	312
POTTS-YASARGIL Mikroscheren .....	44	SEMB Raspatorien .....	266		
Präparier- und Ligaturklemmen .....	99, 105, 142, 151-152, 175	SEMB Sternumschere .....	274	<b>W</b>	
Präparierscheren .....	23-29	SEMKEN Pinzetten .....	51	WALTON-YANKAUER Saugrohr .....	4
PRESBYTERIAN HOSPITAL Schlauchklemmen .....	109	SENN Wundhaken .....	191	WANGENSTEEN Nadelhalter .....	236
PRICE-THOMAS Bronchusklemmen .....	177	Septumlevatorium .....	314	WANGENSTEEN Pinzetten .....	52
Profunda-Klemmen .....	152	Shunt .....	170	WAUGH Pinzetten .....	50
PROVIDENCE-HOSPITAL Arterienklemmen .....	90	SIMON Wundhaken .....	211	WEBER Aortaklemmen .....	125
<b>R</b>		SINGLEY Pinzetten .....	52	WEBSTER Nadelhalter .....	231
RAGNELL-DAVIS Wundhaken .....	191	Skalpellgriffe .....	10-13, 16	WECKER Irisspatel .....	316
RAMPLEY Tupferzange .....	174	Skalpellgriffe, mikro .....	16	WEINBERG Rippensperrer .....	295
RANKIN Atraumatische Gefäßklemmen .....	112	Skalpellklingen, steril .....	14, 16	WEITLANER Wundspreizer .....	216-219
Raspatorien .....	262-267	Skalpellklingen, steril, mikro .....	16	WHEELER-GREGORY Atraumatische	
REILL Drahtkniefzange .....	272	Skalpellklingen-Entferner .....	15	Pinzetten .....	61
REYNOLDS Scheren .....	31	SLS Ligaturclips aus Titan .....	75	WICKSTROEM Arterienklemmen .....	107
RICHARDSON Wundhaken .....	187, 189	SMITH-PETERSEN Hohlmeißelzange .....	252	WILLAUER Thorax-Schere .....	40
Ringpinzetten .....	57, 63-64	Sonde .....	324	WILLIAMS Gewebefasszangen .....	184
Ringstripper .....	312	SPENCER Fadenscheren .....	41	WOLF Saugrohr .....	2, 329
Rippenkonraktoren .....	223	SPENCER-WELLS Arterienklemmen .....	95	Wundhaken .....	186-228
Rippenraspatorien .....	265	STANDARD (YASARGIL)		Wundspreizer .....	215-222
Rippenscheren .....	274-279	Aneurysmen-Clips .....	76-77	WYLIE Atraumatische Gefäßklemmen .....	135
Rippensperrer .....	281-308	Standgefäße .....	320	<b>Y</b>	
ROBB Gefäßdissektoren .....	323	Sterilisation-Trichter für Akku .....	280	YANKAUER Saugrohr .....	4
ROBERTS Arterienklemmen .....	103	Sternummeißel .....	261	YANKAUER-BABY Saugrohr .....	4
ROCHESTER-CARMALT Arterienklemmen .....	95	Sternumsäge .....	280	YASARGIL Aneurysmen-Clips .....	76-77
ROCHESTER-OCHSNER Arterienklemmen .....	92	Sternumschere .....	38, 274	YASARGIL Clips für permanenten Verschluss .....	76-77
ROCHESTER-PEAN Arterienklemmen .....	91	Sternumspreizer .....	304-307	YASARGIL Mikroscheren .....	44
Rollenklemmen .....	110	STILLE Rippenschere .....	275	<b>Z</b>	
ROSS Aortahaken .....	227	LISTON-KEY-HORSLEY		ZAUFEL-JANSEN Hohlmeißelzange .....	248
ROUX Wundhaken .....	186	Knochensplitterzangen .....	257	ZENKER Arterienklemmen .....	104
ROUX-mini Wundhaken .....	186	STILLE-LISTON Knochensplitterzangen .....	255-256	ZENKER Wundhaken .....	203
RUMEL-BELMONT Tourniquets .....	318	STILLE-LUER Hohlmeißelzange .....	249-250		
RUMMEL Arterienklemmen .....	102	STRATE Nadelhalter .....	236		
RUSKIN Hohlmeißelzange .....	248	STRULLY Gefäßschere .....	38		
RUSKIN-LISTON Knochensplitterzangen .....	254	SUBRAMINIAN Aortaklemmen .....	147		
Russ. Mod. Pinzetten .....	52	SUBRAMINIAN-MINIATURE Aortaklemmen .....	147		
		<b>T</b>			
		Tangentialklemmen .....	134, 138, 161		
		TEALE Herzklappen-Fasszange .....	184		
		THOMS-ALLIS Gewebefasszangen .....	181		

**A**

Abdominal retractors..... 222  
Abdominal spatulas..... 190-193  
ABRAMS pleural biopsy needle.....8  
ACLAND applying forceps vessel clips..... 74  
ACLAND approximators.....73  
ACLAND vessel clips..... 72-73  
ADSON forceps ..... 49-50  
ADSON hemostatic forceps ..... 98  
ADSON retractor, self-retaining ..... 219  
ADSON-BABY hemostatic forceps..... 98  
ADSON-DE BAKEY atraumatic forceps..... 61  
ADSON-micro forceps..... 49  
ALEXANDER periosteal elevator ..... 263  
ALLIS tissue grasping forceps ..... 181  
ALLIS-BABY tissue grasping forceps..... 181  
ALLISON lung spatula ..... 224  
ALLPORT retractor, self-retaining ..... 216  
ALM retractor, self-retaining ..... 216  
Anastomosis clamps..... 117-118, 147, 159-160, 162-163  
ANDREWS-PYNCHON suction tube ..... 5  
Aneurysm clip applying forceps..... 76-77  
ANKENEY sternal retractor ..... 306-307  
Aorta retractors ..... 227-228  
Aorta-anastomosis clamps..... 123  
Aorta-aneurysm clamps ..... 126-129, 131  
Aortic clamps ..... 123, 125, 147-148  
Aortic valve rongeurs ..... 17-18  
Applying and removing forceps for Bulldog clamps ..... 85  
Applying forceps for Clips ..... 137  
Applying forceps for ligature clips ..... 75  
Applying forceps vessel clips..... 65-70, 74  
Approximators..... 67-70  
Atraumatic Bulldog Clamps ..... 79-84  
Atraumatic multi-purpose clamps ..... 120, 122, 141, 157, 162, 164-165  
Atraumatic tissue forceps ..... 57-64  
Atraumatic vascular clamps..... 111-170  
Atrium retractors ..... 225-226  
Auricle clamps ..... 139  
AUSTIN suture tying forceps ..... 55  
Automatic wire twisting forceps ..... 269

**B**

BABCOCK tissue grasping forceps ..... 182  
BABY-HAIGHT rib spreaders ..... 288  
Baby-MIXTER hemostatic forceps..... 106  
BABY-POOLE suction tube ..... 2  
BACKHAUS towel clamps..... 171  
BADGLEY rib spreaders ..... 299  
BAILEY aortic valve rongeurs ..... 17  
BAILEY rib contractors ..... 223  
BAILEY-BABY rib contractors ..... 223  
BAILEY-GIBBON rib contractors ..... 223  
BAINBRIDGE atraumatic multi-purpose clamps ..... 122  
BALFOUR abdominal retractors ..... 222  
BALL AND SOCKET towel clamps..... 172  
BANGOLEA hemostatic forceps ..... 97  
BARRAQUER micro needle holders ..... 240  
BARRAQUER-TROUTMAN micro needle holders ..... 240  
Battery ..... 280  
BAUMGARTNER needle holders..... 232  
BAUMGARTNER wire twisting forceps ..... 270  
BECK atraumatic multi-purpose clamps ..... 141  
BECKMANN retractor, self-retaining ..... 220  
BECKMANN-ADSON retractor, self-retaining ..... 220  
BERLIN tubing clamps ..... 109  
BERRY wire twisting forceps ..... 270  
BETHUNE rib shears ..... 277  
BEYER bone rongeurs..... 248  
BIEMER applying forceps vessel clips ..... 65, 67-68  
BIEMER approximators ..... 69  
BIEMER vein scissors ..... 44  
BIEMER vessel clips..... 65  
BIEMER vessel spreader ..... 315  
BIEMER-MÜLLER approximators ..... 67  
BLAKE embolus grasping forceps..... 180  
BOEHLER bone cutting forceps ..... 253  
BOEHLER bone rongeurs ..... 248  
Bone curettes ..... 260

Bone cutting forceps..... 252-257  
Bone holding forceps ..... 258-259  
Bone rongeurs ..... 248-252  
bone rongeurs..... 248  
Bone surgery ..... 247-280  
Bone wire ..... 268  
BOROWSKI aorta retractor ..... 228  
BOZEMANN needle holders ..... 236  
BRAUN-RALPH suction tube ..... 5  
BRAUN-STADLER scissors ..... 38  
BRIDGE hemostatic forceps ..... 104  
BROM vessel hooks ..... 314  
BROMPTON tube milking rollers ..... 110  
Bronchus forceps ..... 114, 176-178  
BRUNNER rib shears..... 279  
BRUNS bone curettes ..... 260  
Bulldog clamps ..... 79-86, 113, 153-154  
Bulldog clamps, titanium..... 86  
BULLDOG vessel clips ..... 71  
Buttoned probes ..... 315

**C**

Cannula for insufflation ..... 328  
Cannulas, vascular irrigation ..... 7  
Cannulas, vein ..... 7  
CAROTID bulldog clamps ..... 79  
Carotid shunt clamps..... 149, 164-165  
CASTAÑEDA neonatal and children clamps ..... 166, 169  
CASTAÑEDA rib spreaders ..... 295  
CASTROVIEJO micro needle holders ..... 240-242  
CASTROVIEJO-JACOBSON micro needle holders ..... 242  
Catheter clamps ..... 155  
Charging unit..... 280  
CHITWOOD-DE BAKEY atraumatic forceps ..... 62  
CHITWOOD-DE BAKEY needle pulling forceps ..... 62  
CLEVELAND bone cutting forceps ..... 252  
Coarctation clamps..... 115-116, 143-146, 157-158  
COLLIN rib shears ..... 275  
CONE retractor, self-retaining ..... 221  
Containers for aneurysm & micro Clips ..... 78  
COOLEY anastomosis clamps..... 159-160, 162-163  
COOLEY atraumatic forceps ..... 60  
COOLEY atraumatic multi-purpose clamps ..... 157, 162, 164-165  
COOLEY atrium hooks..... 225-226  
COOLEY bulldog clamps ..... 84, 153-154  
COOLEY carotid shunt clamps..... 164-165  
COOLEY catheter clamps ..... 155  
COOLEY coarctation clamps ..... 157-158  
COOLEY iliac clamp..... 158  
COOLEY mitral valve dilators..... 317  
COOLEY neonatal and children clamps ..... 156, 159, 162, 167-168  
COOLEY rib shears ..... 277  
COOLEY rib spreaders ..... 283-285  
COOLEY suction tube..... 3  
COOLEY tangential occlusion clamps ..... 161  
COOLEY vascular dilators ..... 319  
COOLEY-BECK anastomosis clamps ..... 160  
COOLEY-DERRA anastomosis clamps ..... 162  
COPE pleural biopsy needle ..... 8  
Coronary artery scissors ..... 37  
CORYLLOS rib shears ..... 276  
CORYLLOS thorax retractors ..... 213  
Counter balanced forceps ..... 63  
CRAFOORD hemostatic forceps ..... 103  
CRAFOORD thoracic scissors ..... 40  
CRAFOORD-SELLORS hemostatic forceps ..... 103  
CRILE hemostatic forceps ..... 89  
CRILE vessel hooks..... 314  
CRILE-RANKIN hemostatic forceps ..... 90  
CRILE-WOOD needle holders..... 232  
CRILE-WOOD-BABY needle holders ..... 233  
CUSHING forceps ..... 50  
CUSHING hilar hook ..... 196  
CUSHING retractor..... 195  
CUSHING vein retractor..... 195  
CUSHING vessel hooks ..... 314  
CUSHING-KOCHER retractor ..... 201  
CUSHING-TAYLOR forceps ..... 50

**D**

D'AMICO suction tube ..... 2, 329  
DALE Peripheral vascular clamps..... 140  
DANDY hemostatic forceps ..... 96  
DARDIK atraumatic multi-purpose clamps..... 120  
DARLING retractor, self-retaining ..... 221  
DAVIDSON (Scapula) retractor..... 214  
DAVIS Elevators..... 316  
DE BAKEY anastomosis clamps ..... 149  
DE BAKEY aorta-aneurysm clamps..... 126, 128, 132, 141  
DE BAKEY atraumatic forceps..... 57-64  
DE BAKEY atraumatic multi-purpose clamps ..... 130, 133  
DE BAKEY coarctation clamps ..... 144-146  
DE BAKEY heparin flushing needle ..... 7  
DE BAKEY iliac clamp..... 124  
DE BAKEY ligature clamps ..... 149  
DE BAKEY needle holders ..... 233-234  
DE BAKEY offset scissors ..... 37  
DE BAKEY Peripheral vascular clamps ..... 119, 121  
DE BAKEY rib spreaders ..... 291, 301-302  
DE BAKEY suction tube..... 5  
DE BAKEY vascular dilators ..... 319-320  
DE BAKEY vascular scissors ..... 33, 36, 37  
DE BAKEY-ADSON atraumatic forceps ..... 61  
DE BAKEY-BAHNSON aorta-aneurysm clamps..... 127  
DE BAKEY-BECK atraumatic multi-purpose clamps ..... 141  
DE BAKEY-DIETRICH atraumatic forceps ..... 60  
DE BAKEY-GERALD atraumatic forceps ..... 61  
DE BAKEY-MC QUIGG MIXTER dissecting and ligature clamps..... 151  
DE BAKEY-MIXTER dissecting and ligature clamps..... 152  
DE BAKEY-MORRIS aorta-aneurysm clamps ..... 129  
DE BAKEY-REYNOLDS anastomosis clamps..... 147  
DE BAKEY-RUMMEL dissecting and ligature clamps..... 151  
DE BAKEY-SATINSKY tangential occlusion clamps..... 138  
DE BAKEY-SEMB aorta-aneurysm clamps ..... 131  
DE BAKEY-SEMB dissecting-ligature clamps..... 142  
DEAVER retractor ..... 192-193  
DEBAKEY bulldog clamps..... 82, 113  
DEBAKEY-DIETRICH bulldog clamps..... 81  
DERF needle holders ..... 231  
DERRA coarctation clamps..... 144  
DESMARRES hilar hook ..... 196  
DIEFFENBACH bulldog clamps..... 85  
DIETRICH bulldog clamps ..... 81  
DIETRICH vascular scissors ..... 35  
DIETRICH aortic clamp ..... 148  
DIETRICH micro needle holders ..... 244  
Dilating forceps, vascular ..... 54  
Dilator Jars ..... 320  
Dissectors..... 316  
Dissecting and ligature forceps..... 99, 105, 142, 151-152, 175  
Dissecting scissors..... 23-29  
Dissector, micro ..... 313  
DOYEN rib raspatories ..... 265  
Dressing and sponge forceps ..... 173-174  
DUBOST rib spreaders ..... 296  
DURANTE forceps ..... 52  
DUVAL tissue grasping forceps ..... 183

**E**

ECHLN bone rongeurs ..... 252  
EDWARDS applying forceps for Clips ..... 137  
EDWARDS clips..... 137  
Elevators ..... 314-316  
Elevators, periosteal ..... 262-267  
Embolus grasping forceps..... 180  
Endoscope holder ..... 326  
Endoscopes ..... 327  
Epicardial retractor ..... 215  
ETHICON® ligature clips, titanium ..... 75

**F**

Fan retractor ..... 330  
FARABEU periosteal elevator ..... 262  
FARABEU retractor ..... 186  
FAVALORO coronary artery scissors..... 37



FAVALORO sternal retractor .....	305
FERGUSON bone holding forceps .....	258
FERGUSON Suction and Irrigation cannula .....	6
FICHSIG hemostatic forceps .....	97
FINOCHIETTO (modif.) rib spreaders .....	282
FINOCHIETTO BABY-HAIGHT rib spreaders .....	288
FINOCHIETTO bronchus forceps .....	176
FINOCHIETTO lobectomy scissors .....	41
FINOCHIETTO needle holders .....	237
FINOCHIETTO rib spreaders .....	282, 287-289
FINOCHIETTO-BABY rib spreaders .....	283
FINOCHIETTO-BURFORD rib spreaders .....	290, 292-294
FINOCHIETTO-INFANT rib spreaders .....	289
FINSSEN retractor, self-retaining .....	215
FINSTERER suction and irrigation cannula .....	5
FISCH vessel hooks .....	315
Flat nose pliers .....	268-269
Flexible Vascular Clamps .....	170
FOERSTER dressing and sponge forceps .....	174
FOGARTY vessel clamps for interchangeable jaw inserts .....	136
Forceps .....	48-64
Forceps, atraumatic .....	57-64
Forceps, counter balanced .....	63
Forceps, diamond dusted .....	57, 63-64
Forceps, micro .....	54-64
Forceps, Suture tying .....	54-56, 63-64
Forceps, titanium .....	58, 64
FRAZIER suction tube .....	6
FREER Elevators .....	316
FRITSCH retractor .....	188
Froceps, hemostatic .....	87-108
FRYKHOLM bone rongeurs .....	251
<b>G</b>	
GARRETT heparin injector .....	7
GARRETT vascular dilators .....	320
GEMINI dissecting and ligature forceps .....	99
GEMINI-mini dissecting and ligature forceps .....	99
GERALD forceps .....	51
GERALD-DEBAKEY atraumatic forceps .....	61
GIERTZ-STILLE rib shears .....	278
GIL VERNET hilar hook .....	195
GILLIES forceps .....	51
GILLIES needle holders .....	238
GILLIES vessel hooks .....	314
GLASSMAN atraumatic forceps .....	61
GLOVER anastomosis clamps .....	117-118
GLOVER bulldog clamps .....	79, 83
GLOVER coarctation clamps .....	146
GLOVER-DE BAKEY atraumatic vascular clamps .....	135
GLOVER-mini bulldog clamps .....	79
GLUCK rib shears .....	275
GOMEL suture tying forceps .....	55
GOSLEE flat nose plier .....	269
GREGORY Profunda clamps .....	152
GREGORY-"Soft" bulldog clamps .....	80
GROSS-MAIER dressing and sponge forceps .....	173
GUNNER-HEY tube milking rollers .....	110
<b>H</b>	
HABERER abdominal spatula .....	191
HAIGHT rib spreaders .....	298
HALLE septum elevator .....	314
HALSEY needle holders .....	232
HALSTED-MOSQUITO atraumatic vascular clamps .....	111
HALSTED-MOSQUITO hemostatic forceps .....	88
HALSTED-MOSQUITO-micro hemostatic forceps .....	87
Handle for ring stripper .....	312
HARKEN auricle clamps .....	139, 180
HARRINGTON bronchus forceps .....	176
HARRINGTON retractor .....	194
HARRINGTON-BABY retractor .....	194
HARTMANN hemostatic forceps .....	87
HARTMANN-micro hemostatic forceps .....	87
HARVEY wire cutting pliers .....	273
HARVEY wire cutting scissors .....	271
HEANEY needle holders .....	236
HEGAR dilators .....	321
HEGAR-Vascular needle holders .....	235
HEISS hemostatic forceps .....	97
Hemostatic forceps .....	87-108
Hemostatic forceps, titanium .....	88-89
HENLEY retractor, self-retaining .....	217
Heparin flushing needle .....	7
Heparin injector .....	7
HERTZLER rib spreaders .....	308
HESS (DEBAKEY) bulldog clamps .....	85
HIBBS retractor .....	212
Hilar hooks .....	195-196
HOHENFELLNER vascular scissors .....	37
Holder for endoscope .....	326
HOPT atraumatic vascular clamps .....	112
<b>I</b>	
I.M.A. Retractors .....	286, 308
Iliac clamp .....	124, 158
IMA Epicardial retractor .....	215
In-situ venous valve scissors .....	39
Insufflation cannula .....	328
Intima spatula .....	323
IRIS scissors .....	32
Iris spatula .....	316
ISRAEL retractor .....	205
<b>J</b>	
JACOBSON buttoned probes .....	315
JACOBSON hemostatic forceps .....	98
JACOBSON micro needle holders .....	242, 245
JACOBSON-MOSQUITO hemostatic forceps .....	98
JANSEN forceps .....	50
Jars for dilators .....	320
JAVID carotid shunt clamps .....	149
Jeweller forceps .....	53
JOHNS HOPKINS bulldog clamps .....	85
JONES towel clamps .....	171
JONES-Clip towel clamps .....	171
JORGENSEN thoracic scissors .....	41
JOSEPH scissors .....	30
JUDD-ALLIS tissue grasping forceps .....	181
<b>K</b>	
KADER retractor .....	190
KANTROWITZ hemostatic forceps .....	105
KELLY dissecting-ligature forceps .....	105
KELLY hemostatic forceps .....	89
KELLY retractor .....	189, 209
KELLY-RANKIN hemostatic forceps .....	89
KILNER scissors .....	31
KILNER vessel hooks .....	314
KLINKENBERGH LOTH thoracic scissors .....	41
KOCHER hemostatic forceps .....	92-93
KOCHER retractor .....	200-201, 204, 206
KOCHER-LANGENBECK retractor .....	202
KOCHER-NIPPON hemostatic forceps .....	94
KOCHER-WAGNER retractor .....	208
KOENIG retractor .....	201
KOERTE retractor .....	210
KRAYENBUHL vessel hooks .....	315
<b>L</b>	
LAHEY hemostatic forceps .....	108
LAMBER-KAY aorta-anastomosis clamps .....	123
LAMBOTTE periosteal elevator .....	262
LANE tissue grasping forceps .....	172
LANGENBECK bone holding forceps .....	258
LANGENBECK periosteal elevator .....	262
LANGENBECK retractor .....	199, 201
LAWRENCE hemostatic forceps .....	104
LAZAR suture tying forceps .....	55
LEBSCHKE rib shears .....	278
LEBSCHKE sternum chisel .....	261
LEES bronchus forceps .....	114
LEKSELL bone rongeurs .....	251
LEKSELL-STILLE bone rongeurs .....	251
LELAND-JONES atraumatic multi-purpose clamps .....	122
LELAND-JONES peripheral vascular clamps .....	121
LEMMON rib contractors .....	223
LERICHE hemostatic forceps .....	96
LERICHE retractor .....	210
LEXER dissecting scissors .....	25
LEXER-FINO dissecting scissors .....	24
LIDDLE aortic clamp .....	123
Ligature catchers .....	318
Ligature clamps .....	149
Ligature clips, titanium .....	75
Ligature Forceps .....	87
LISTER dissecting and ligature forceps .....	175
LISTON bone cutting forceps .....	253
LITTAUER stitich scissors .....	41
LITTLEWOOD tissue grasping forceps .....	184
Liver elevator .....	330
Lobectomy scissors .....	41
LOCKHART-MUMMERY probe .....	324
LORNA towel clamps .....	172
LOVE-GRUENWALD aortic valve rongeurs .....	17
LOVELACE hemostatic forceps .....	96
LOVELACE lung grasping forceps .....	175
LUCAE forceps .....	50
Lung grasping forceps .....	175
Lung spatulas .....	224
<b>M</b>	
Mallets .....	261
Mammaria retractors .....	286, 308
MARQUARDT bone rongeurs .....	248
MARTIN abdominal spatula .....	191
MARTIN dressing and sponge forceps .....	174
MARTIN retractor .....	211
MARTIN-WYLIE peripheral vascular clamps .....	150
MATHIEU needle holders .....	237
MATSON periosteal elevator .....	263
MATSON-ALEXANDER periosteal elevator .....	263
MAYO dissecting scissors .....	23
MAYO-HEGAR needle holders .....	233
MAYO-STILLE dissecting scissors .....	24
MCINDOE bone cutting forceps .....	254
McINDOE forceps .....	52
McINDOE vascular scissors .....	38
McQUIGG-MIXTER hemostatic forceps .....	107
MEEKER hemostatic forceps .....	104
MEHDORN applying forceps vessel clips .....	66
MEHDORN vessel clips .....	66
MERCEDES thoracic retractor .....	303
METZENBAUM dissecting scissors .....	26
METZENBAUM FINO dissecting scissors .....	27-30
METZENBAUM-NELSON dissecting scissors .....	30
Micro bulldog clamps .....	79, 86
Micro needle holders .....	239-246
Micro vascular scissors .....	42-46
Micro-Forceps .....	54-64
Microvascular needle holders .....	235
MIDDELDPORPF retractor .....	187
MIKULICZ peritoneal clamps .....	108
MIKULICZ retractor .....	207
MIKULICZ-Baby peritoneal clamps .....	108
MILLES micro scissors .....	44
MILLS vascular scissors .....	36
MINI (YASARGIL) aneurysm clips .....	76-77
Mitral valve dilators .....	317
MIXTER hemostatic forceps .....	106-107
MIXTER-BABY hemostatic forceps .....	106
MIXTER-O'SHAUGNESSY hemostatic forceps .....	107
MOCK-DEBAKEY heparin flushing needle .....	7
MORSE sternal retractor .....	304-305
MORSE-FAVALORO sternal retractor .....	305
MÜLLER approximators .....	68
MÜLLER vessel clips .....	71
MURPHY retractor .....	198
<b>N</b>	
NABATOFF vein strippers .....	310
Needle holders .....	229-246
Needle holders, diamond dusted .....	242-244, 246
Needle holders, micro .....	239-246
Needle holders, titanium .....	246
Needle pulling tissue forceps .....	62
NEIVERT needle holders .....	232
NELSON forceps .....	52
NELSON thoracic trocar .....	8
Neonatal and children clamps .....	156, 159, 162, 166-169
Never dissecting scissors .....	38

**O**

OCHSNER aortic clamp .....148  
Offset scissors ..... 37  
OLSEN HEGAR needle holders ..... 238  
Operating scissors...20-22, 30-32  
Organ grasping forceps .....140  
OVERHOLT hemostatic forceps ..... 101-102  
OVERHOLT-BABY hemostatic forceps.....101  
OVERHOLT-fino hemostatic forceps ..... 101  
OVERHOLT-GEISSENDOERFER hemostatic forceps ..... 100  
OVERHOLT-MIXTER hemostatic forceps ..... 107

**P**

PARKER-LANGENBECK retractor..... 187  
PEAN atraumatic vascular clamps ..... 111  
PEAN hemostatic forceps .....91, 93  
PEAN-NIPPON hemostatic forceps..... 94  
PEERS-BERTRAM towel clamps ..... 171  
PENNINGTON hemostatic forceps ..... 96  
Periosteal elevators.....262-267  
Peripheral vascular clamps .....119, 121, 140, 150  
Peritoneal clamps ..... 108  
PERWITZCHKY scissors .....32  
Phlebotomizer ..... 313  
Phleboextractor ..... 313  
Pleural biopsy needle ..... 8  
POOLE suction tube ..... 2  
POPPEN suction tube ..... 6  
POTTS coarctation clamps ..... 115-116, 143  
POTTS-DE MARTEL vascular scissors..... 36  
POTTS-SMITH forceps .....48  
POTTS-SMITH vascular scissors..... 33-34, 36  
POTTS-YASARGIL micro scissors ..... 44  
PRESBYTERIAN HOSPITAL tubing clamps..... 109  
PRICE-THOMAS bronchus forceps..... 177  
Probe .....324  
Profunda Clamps .....152  
PROVIDENCE-HOSPITAL hemostatic forceps .....90  
RAGNELL-DAVIS retractor .....191

**R**

RAMPLEY dressing and sponge forceps..... 174  
RANKIN atraumatic vascular clamps ..... 112  
REILL wire cutting pliers .....272  
Retractors ..... 186-228  
Retractors, self-retaining ..... 215-222  
REYNOLDS scissors ..... 31  
Rib contractors ..... 223  
Rib raspatories .....265  
Rib shears ..... 274-279  
Rib spreaders ..... 281-308  
RICHARDSON retractor ..... 187, 189  
Ring Bulldog clamps ..... 113  
Ring forceps ..... 57, 63-64  
Ring strippers .....312  
ROBB vascular dissectors .....323  
ROBERTS hemostatic forceps .....103  
ROCHESTER-CARMALT hemostatic forceps .....95  
ROCHESTER-OCHSNER hemostatic forceps .....92  
ROCHESTER-PEAN hemostatic forceps ..... 91  
ROSS aorta retractor.....227  
ROUX retractor.....186  
ROUX-mini retractor ..... 186  
RUMEL-BELMONT tourniquets ..... 318  
RUMMEL hemostatic forceps .....102  
RUSKIN bone rongeurs .....248  
RUSKIN-LISTON bone cutting forceps..... 254  
Russ. Mod. forceps ..... 52  
RYDER needle holders .....234  
RYDER-Vascular needle holders ..... 235

**S**

SANTULLI bulldog clamps.....80  
SANVENERO scissors .....30  
SAROT bronchus forceps .....178  
SAROT hemostatic forceps .....103  
SAROT needle holders .....237  
SATINSKY anastomosis clamps .....179  
SATINSKY bulldog clamps .....79  
SATINSKY tangential occlusion clamps..... 134  
SATINSKY vascular scissors ..... 39  
SAUERBRUCH bone rongeurs .....250  
SAUERBRUCH retractor .....214

SAUERBRUCH rib shears .....278  
Saw, Sternal .....280  
Scalpel blade remover ..... 15  
Scalpel blades, sterile .....14, 16  
Scalpel blades, sterile, micro ..... 16  
Scalpel handles ..... 10-13, 16  
Scalpel handles, micro .....16  
Scapula retractor ..... 214  
SCHAEDEL towel clamps .....171  
SCHEDE bone curettes .....260  
SCHEIBE tissue grasping forceps ..... 183  
SCHMID vascular irrigation cannula ..... 7  
SCHNIDT dissecting and ligature forceps ..... 175  
SCHOENBORN retractor.....195  
SCHUMACHER sternum scissors.....274  
Scissors .....20-46  
Scissors for veins ..... 44  
Scissors, coronary artery .....37  
Scissors, in-situ venous valve ..... 39  
Scissors, lobectomy.....41  
Scissors, micro vascular .....42-46  
Scissors, never dissecting .....38  
Scissors, offset ..... 37  
Scissors, sternum .....274  
Scissors, SuperCut..... 20-23, 25-26, 34  
Scissors, titanium ..... 46  
SELLORS rib contractors ..... 223  
SELMAN forceps ..... 50  
SEMB bone cutting forceps .....257  
SEMB bone holding forceps .....259  
SEMB bone rongeurs .....252  
SEMB dissecting and ligature forceps..... 178  
SEMB lung spatula .....224  
SEMB periosteal elevator .....266  
SEMKEN forceps ..... 51  
SENN retractor ..... 191  
Septum elevators ..... 314  
Shunt .....170  
SIMON retractor .....211  
SINGLEY forceps ..... 52  
SLS ligature clips, titanium .....75  
SMITH-PETERSEN bone rongeurs ..... 252  
SPENCER stitch scissors .....41  
SPENCER-WELLS hemostatic forceps .....95  
STANDARD (YASARGIL) aneurysm clips..... 76-77  
Sterilization funnel for battery ..... 280  
Sternal retractors ..... 304-307  
Sternal Saws .....280  
Sternum chisel .....261  
Sternum scissors ..... 38  
Sternum scissors .....274  
STILLE rib shears .....275  
LISTON-KEY-HORSLEY bone cutting forceps .....257  
STILLE-LISTON bone cutting forceps .....255-256  
STILLE-LUER bone rongeurs ..... 249-250  
Stitch scissors ..... 41  
STRATE needle holders .....236  
STRUCK rib spreaders.....297  
STRULLY vascular scissors .....38  
SUBRAMINIAN aortic clamp .....147  
SUBRAMINIAN-MINIATURE aortic clamp ..... 147  
Suction Tubes ..... 2-7, 329  
Suture tying forceps ..... 54-56, 63-64

**T**

Tangential occlusion clamps..... 134, 138, 161  
TEALE valve grasping forceps ..... 184  
Telescopes .....327  
THOMS-ALLIS tissue grasping forceps ..... 181  
Thoracic retractor ..... 303  
Thoracic scissors .....40-41  
Thoracic trocars..... 8, 328  
Thoracoscopy .....325-330  
Thorax retractors .....212-213  
THOREK thoracic scissors ..... 40  
Tissue forceps ..... 48-64  
Tissue grasping forceps ..... 172 - 184  
TOENNIS dissectors .....316  
TOENNIS needle holders ..... 237  
TOENNIS-ADSON vascular scissors ..... 38  
TOHOKU towel clamps .....172  
TOLEDO forceps, micro .....56  
TOLEDO micro needle holders ..... 243  
TOLEDO vascular micro scissors ..... 43

Tourniquets.....318  
Towel Clamps ..... 171-172  
Trays for aneurysm & micro Clips ..... 78  
trocars, thoracic ..... 8, 328  
TUBBS mitral valve dilators ..... 317  
Tube milking rollers ..... 110  
Tubing clamps ..... 109  
TUFFIER rib spreaders .....300  
Tunneling set ..... 322

**U**

ULRICH dressing and sponge forceps..... 173  
ULTRA-LIGHT atraumatic forceps ..... 62  
US-Army (PARKER-LANGENBECK) retractor ..187

**V**

Valve grasping forceps.....184  
VANDERBILT hemostatic forceps ..... 102  
VANNAS micro scissors ..... 44  
VARADY dissector ..... 313  
VARADY phlebotomizer .....313  
VARADY phleboextractor .....313  
VARADY Varix instruments ..... 313  
VARADY vein strippers ..... 311  
Varix instruments..... 313  
Vascular clamps, flexible ..... 170  
Vascular dilator forceps .....54  
Vascular dilators .....315, 319-321  
Vascular dissectors.....323  
Vascular irrigation Cannulas.....7  
Vascular scissors .....33-39  
Vein cannulas .....7  
Vein Retractor.....195  
Vein scissors ..... 44  
Vein strippers ..... 310-312  
Vena cava clamps ..... 138, 141, 155, 179  
Venous valve scissors .....39  
Vessel clamps for interchangeable jaw inserts 136  
Vessel dilators ..... 315, 319-321  
Vessel dilating forceps.....54  
Vessel hooks ..... 314-315  
Vessel spreader ..... 315  
VOLKMANN bone curettes .....260  
VOLKMANN retractor ..... 197-198  
VOLLMAR Handle for ring stripper.....312  
VOLLMAR ring strippers .....312

**W**

WALTON-YANKAUER suction tube..... 4  
WANGENSTEEN forceps .....52  
WANGENSTEEN needle holders.....236  
WAUGH forceps ..... 50  
WEBER aortic clamp.....125  
WEBSTER needle holders ..... 231  
WECKER iris spatula.....316  
WEINBERG rib spreaders .....295  
WEITLANER retractor, self-retaining.....216-219  
WICKSTROEM hemostatic forceps..... 107  
WILLAUER thoracic scissors .....40  
WILLIAMS tissue grasping forceps ..... 184  
Wire cutter, front action.....273  
Wire cutting pliers .....271-273  
Wire cutting scissors.....271-273  
Wire twisting forceps .....269-270  
Wire, soft .....268  
WOLF suction tube ..... 2, 329  
WYLIE atraumatic vascular clamps ..... 135

**Y**

YANKAUER suction tube .....4  
YANKAUER-BABY suction tube .....4  
YASARGIL aneurysm clips .....76-77  
YASARGIL clips for permanent closure.....76-77  
YASARGIL micro scissors ..... 44

**Z**

ZAUFEL-JANSEN bone rongeurs.....248  
ZENKER hemostatic forceps .....104  
ZENKER retractor.....203

**A**

ABRAMS aiguille de biopsie pleurale..... 8  
 ACLAND approximateurs .....73  
 ACLAND clips vasculaires .....72-73  
 ACLAND pinces à appliquer  
 les clips vasculaires ..... 74  
 ADSON écarteurs autostatiques ..... 219  
 ADSON pinces à dissection .....49-50  
 ADSON pinces hémostatiques ..... 98  
 ADSON-BABY pinces hémostatiques ..... 98  
 ADSON-DE BAKEY pinces atraumatiques ..... 61  
 ADSON-micro pinces à dissection ..... 49  
 Aiguilles de biopsie pleurale.....8  
 Aiguilles pour héparine .....7  
 Aiguilles vasculaires pour irrigation .....7  
 ALEXANDER rugines .....263  
 ALLIS pinces à saisir les tissus .....181  
 ALLIS-BABY pinces à saisir les tissus .....181  
 ALLISON spatules pulmonaires .....224  
 ALLPORT écarteurs autostatiques.....216  
 ALM écarteurs autostatiques .....216  
 ANDREWS-PYNCHON tube d'aspiration .....5  
 ANKENY écarteurs pour sternum .....306-307  
 Applicateur pour clips .....137  
 Approximateurs .....67-70  
 Atrauma Clamps Bulldog .....79-84  
 AUSTIN pinces pour nouer les fils.....55  
 Automatic pince à torsader le fil.....269

**B**

BABCOCK pinces à saisir les tissus ..... 182  
 BABY-HAIGHT écarteurs pour costaux ..... 288  
 Baby-MIXTER pinces hémostatiques.....106  
 BABY-POOLE tube d'aspiration.....2  
 BACKHAUS pinces à champs .....171  
 BADGLEY écarteurs pour costaux .....299  
 BAILEY rapprocheurs pour costaux .....223  
 BAILEY rongeur pour aorte .....17  
 BAILEY-BABY rapprocheurs pour costaux .....223  
 BAILEY-GIBBON rapprocheurs pour costaux .....223  
 BAINBRIDGE pinces polyvalentes .....122  
 BALFOUR écarteurs abdominaux .....222  
 BALL AND SOCKET pinces à champs .....172  
 BANGOLEA pinces hémostatiques .....97  
 BARRAQUER micro porte-aiguilles .....240  
 BARRAQUER-TROUTMAN  
 micro porte-aiguilles .....240  
 Batterie .....280  
 BAUMGARTNER pince à torsader le fil .....270  
 BAUMGARTNER porte-aiguilles .....232  
 BECK pinces polyvalentes.....141  
 BECKMANN écarteurs autostatiques.....220  
 BECKMANN-ADSON écarteur  
 autostatique .....220  
 BERLIN pinces serre-tubes .....109  
 BERRY pince à torsader le fil .....270  
 BETHUNE costotomes.....277  
 BEYER pinces-gouges .....248  
 BIEMER approximateurs .....69  
 BIEMER ciseaux pour veines .....44  
 BIEMER clips vasculaires .....65  
 BIEMER écarteur pour vaisseaux.....315  
 BIEMER pinces à appliquer  
 les clips vasculaires... 65, 67-68  
 BIEMER-MÜLLER approximateurs .....67  
 BLAKE pince à saisir l'ambolusembolie .....180  
 BOEHLER pinces-gouges.....248  
 BOEHLER pinces coupantes à os .....253  
 BOROWSKI écarteurs pour l'aorte .....228  
 BOZEMANN porte-aiguilles .....236  
 BRAUN-RALPH tube d'aspiration .....5  
 BRAUN-STADLER ciseaux .....38  
 BRIDGE pinces hémostatiques .....104  
 BROM crochet à vaisseau .....314  
 BROMPTON pince à rouleaux .....110  
 BRUNNER costotomes .....279  
 BRUNS curettes tranchantes .....260  
 BULLDOG clips vasculaires .....71

**C**

Canule pour insufflation .....328  
 Canules veineuses .....7  
 CAROTID clamps bulldog .....79  
 CASTAÑEDA écarteurs pour costaux .....295  
 CASTAÑEDA pinces pour des

nouveaux-nés et des enfants .....166, 169  
 CASTROVIEJO micro porte-aiguilles .....240-242  
 CASTROVIEJO-JACOBSON  
 micro porte-aiguilles .....242  
 Chargeur .....280  
 Chirurgie osseuse.....247-280  
 CHITWOOD-DE BAKEY pince aiguille-tirant.....62  
 CHITWOOD-DE BAKEY pinces  
 atraumatiques .....62  
 Ciseau-burin à sternum .....261  
 Ciseaux .....20-46  
 Ciseaux à chirurgie .....20-22, 30-32  
 Ciseaux à dissection .....23-29  
 Ciseaux à ligature .....41  
 Ciseaux à lobectomie.....41  
 Ciseaux à préparation de nerfs .....38  
 Ciseaux à sternum .....38, 274  
 Ciseaux artère coronaire .....37  
 Ciseaux compensé .....37  
 Ciseaux micro-vasculaires .....42-46  
 Ciseaux pour veines.....44  
 Ciseaux thoraciques .....40-41  
 Ciseaux valve veineuse .....39  
 Ciseaux vasculaires.....33-39  
 Ciseaux, offset .....37  
 Ciseaux, SuperCut .....20-23, 25-26, 34  
 Ciseaux, titane .....46  
 Clamps bulldog .....79-86, 113, 153-154  
 Clamps bulldog, micro .....79, 86  
 Clamps bulldog, tinane .....86  
 CLEVELAND pinces coupantes à os .....252  
 Clips titane à ligature.....75  
 COLLIN costotomes.....275  
 CONE écarteurs autostatiques .....221  
 COOLEY clamps bulldog .....84, 153-154  
 COOLEY costotomes .....277  
 COOLEY dilateurs pour valve mitrale .....317  
 COOLEY dilateurs vasculaires .....319  
 COOLEY écarteurs pour oreillette .....225-226  
 COOLEY écarteurs pour costaux .....283-285  
 COOLEY pinces pour veine iliaque.....158  
 COOLEY pinces à anastomose .....159-160, 162-163  
 COOLEY pinces à coarctation .....157-158  
 COOLEY pinces atraumatiques .....60  
 COOLEY pinces pour carotide .....164-165  
 COOLEY pinces pour sondes .....155  
 COOLEY pinces  
 polyvalentes .....157, 162, 164-165  
 COOLEY pinces pour des nouveaux-nés  
 et des enfants .....156, 159, 162, 167-168  
 COOLEY pinces  
 pour occlusion tangentielle .....161  
 COOLEY tube d'aspiration .....3  
 COOLEY-BECK pinces à anastomose .....160  
 COOLEY-DERRA pinces à anastomose .....162  
 COPE aiguille de biopsie pleurale .....8  
 CORYLLOS costotomes .....276  
 CORYLLOS écarteurs thoraciques .....213  
 Costotomes .....274-279  
 CRAFOORD ciseaux thoraciques .....40  
 CRAFOORD pinces hémostatiques.....103  
 CRAFOORD-SELLORS pinces hémostatiques.....103  
 CRILE crochet à vaisseau .....314  
 CRILE pinces hémostatiques .....89  
 CRILE-RANKIN pinces hémostatiques.....90  
 CRILE-WOOD porte-aiguilles .....232  
 CRILE-WOOD-BABY porte-aiguilles .....233  
 Crochets à vaisseaux.....314-315  
 Crochet pour endoscopes .....326  
 Curettes tranchantes .....260  
 CUSHING crochet à vaisseaux .....314  
 CUSHING écarteurs.....195  
 CUSHING écarteur à veines .....195  
 CUSHING crochets hilaires.....196  
 CUSHING pinces à dissection .....50  
 CUSHING-KOCHER écarteurs .....201  
 CUSHING-TAYLOR pinces à dissection .....50

**D**

D'AMICO tubes d'aspiration.....2, 329  
 DALE pinces, vasculaires périphériques .....140  
 DANDY pinces hémostatiques .....96  
 DARDIK pinces polyvalentes .....120  
 DARLING écarteurs autostatiques .....221

DAVIDSON (Scapula) écarteurs.....214  
 Daviers à os .....258-259  
 DAVIS Élévateurs .....316  
 DE BAKEY aiguilles pour héparine.....7  
 DE BAKEY ciseaux compensé .....37  
 DE BAKEY ciseaux vasculaires .....33, 36, 37  
 DE BAKEY dilateurs vasculaires.....319-320  
 DE BAKEY écarteurs pour costaux...291, 301-302  
 DE BAKEY pinces à anastomose.....149  
 DE BAKEY pinces à ligature .....149  
 DE BAKEY pinces atraumatiques.....57-64  
 DE BAKEY pinces polyvalentes.....130, 133  
 DE BAKEY pinces pour  
 anévrisme de l'aorte .....126, 128, 132, 141  
 DE BAKEY pinces pour coarctation.....144-146  
 DE BAKEY pinces pour veine iliaque.....124  
 DE BAKEY pinces,  
 vasculaires périphériques.....119, 121  
 DE BAKEY porte-aiguilles .....233-234  
 DE BAKEY tube d'aspiration .....6  
 DE BAKEY-ADSON pinces atraumatiques .....5  
 DE BAKEY-BAHNSON pinces pour anévrisme de  
 l'aorte.....127  
 DE BAKEY-BECK pinces polyvalentes.....141  
 DE BAKEY-DIETHRICH pinces atraumatiques ..60  
 DE BAKEY-GERALD pinces atraumatiques .....61  
 DE BAKEY-MC QUIGG MIXTER pinces  
 à dissection et à ligature .....151  
 DE BAKEY-MIXTER pinces à dissection  
 et à ligature .....152  
 DE BAKEY-MORRIS pinces  
 pour anévrisme de l'aorte .....129  
 DE BAKEY-REYNOLDS pinces à anastomose .147  
 DE BAKEY-RUMMEL pinces à dissection  
 et à ligature .....151  
 DE BAKEY-SATINSKY pinces  
 pour occlusion tangentielle .....138  
 DE BAKEY-SEMB pinces à dissection  
 et à ligature .....142  
 DE BAKEY-SEMB pinces  
 pour anévrisme de l'aorte .....131  
 DEEVER écarteurs .....192-193  
 DEBAKEY clamps bulldog .....82, 113  
 DEBAKEY-DIETHRICH clamps bulldog.....81  
 DERF porte-aiguilles .....231  
 DERRA pinces pour coarctation .....144  
 DESMARRÉS crochets hilaires .....196  
 DIEFFENBACH clamps bulldog.....85  
 DIETHRICH ciseaux vasculaires .....35  
 DIETHRICH clamps bulldog .....81  
 DIETRICH micro porte-aiguilles .....244  
 DIETRICH pinces pour l'aorte .....148  
 Dilatation, pinces vasculaires .....54  
 Dilateurs pour valve mitrale .....317  
 Dilateurs vasculaires .....315, 319-321  
 Dissecteurs, micro .....313  
 Dissecteurs .....316  
 Dissecteurs vasculaires .....323  
 DOYEN rugines pour costaux .....265  
 DUBOST écarteurs pour costaux.....296  
 DURANTE pinces à dissection .....52  
 DUVAL pinces à saisir les tissus .....183

**E**

Écarteur à veines .....195  
 Écarteur épicaldial .....215  
 Écarteur pour vaisseaux .....315  
 Écarteurs .....186-228  
 Écarteurs à mammaia .....286, 308  
 Écarteurs abdominaux .....222  
 Écarteurs pour oreillette .....225-226  
 Écarteurs autostatiques .....215-222  
 Écarteurs pour costaux .....281-308  
 Écarteurs pour l'aorte .....227-228  
 Écarteurs pour sternum .....304-307  
 Écarteurs thoraciques .....212-213  
 ECHLN pinces-gouges .....252  
 EDWARDS applicateur pour clips .....137  
 EDWARDS clips.....137  
 Élévateurs pour septum.....314  
 Élévateurs .....314-316  
 Endoscopes .....327  
 Enlève-lame.....15  
 Entonnoir de stérilisation pour la batterie.....280  
 ETHICON® clips titane à ligature.....75



**F**

FARABEUF écarteurs ..... 186  
 FARABEUF rugines ..... 262  
 FAVALORO ciseaux artère coronaire ..... 37  
 FAVALORO écarteurs pour sternum ..... 305  
 FERGUSSON Canules d'aspiration et d'irrigation ..... 6  
 FERGUSSON davier à os ..... 258  
 FICHSIG pinces hémostatiques ..... 97  
 Fil d'acier à os ..... 268  
 FINOCHIETTO (modif.) écarteurs pour costaux ..... 282  
 FINOCHIETTO BABY-HAIGHT écarteurs pour costaux ..... 288  
 FINOCHIETTO ciseaux à lobectomie ..... 41  
 FINOCHIETTO écarteurs pour costaux ..... 282, 287-289  
 FINOCHIETTO pinces à bronches ..... 176  
 FINOCHIETTO porte-aiguilles ..... 237  
 FINOCHIETTO-BABY écarteurs pour costaux ..... 283  
 FINOCHIETTO-BURFORD écarteurs pour costaux ..... 290, 292-294  
 FINOCHIETTO-INFANT écarteurs pour costaux ..... 289  
 FINSSEN écarteurs autostatiques ..... 215  
 FINSTERER canule d'aspiration et d'irrigation ..... 5  
 FISCH crochet à vaisseaux ..... 315  
 FOERSTER pinces à pansements ..... 174  
 FOGARTY pinces vasculaires pour mors interchangeables ..... 136  
 Foie rétracteur ..... 330  
 FRAZIER tube d'aspiration ..... 6  
 FREER Elévateurs ..... 316  
 FRITSCH écarteurs ..... 188  
 FRYKHOLM pinces-gouges ..... 251

**G**

GARRETT dilateurs vasculaires ..... 320  
 GARRETT injecteur pour héparine ..... 7  
 GEMINI pinces à dissection et à ligature ..... 99  
 GEMINI-mini pinces à dissection et à ligature ..... 99  
 GERALD pinces à dissection ..... 51  
 GERALD-DEBAKEY pinces atraumatiques ..... 61  
 GIERTZ-STILLE costotomes ..... 278  
 GIL VERNET crochets hilaires ..... 195  
 GILLIES crochets à vaisseaux ..... 314  
 GILLIES pinces à dissection ..... 51  
 GILLIES porte-aiguilles ..... 238  
 GLASSMAN pinces atraumatiques ..... 61  
 GLOVER clamps bulldog ..... 79, 83  
 GLOVER pinces à anastomose ..... 117-118  
 GLOVER pinces pour coarctation ..... 146  
 GLOVER-DE BAKEY pinces vasculaires atraumatiques ..... 135  
 GLOVER-mini clamps bulldog ..... 79  
 GLUCK costotomes ..... 275  
 GOMEL pinces pour nouer les fils ..... 55  
 GOSLEE pince plates ..... 269  
 GREGORY pinces pour profunda ..... 152  
 GREGORY-"Soft" clamps bulldog ..... 80  
 GROSS-MAIER pinces à pansements ..... 173  
 GUNNER-HEY pince à rouleaux ..... 110

**H**

HABERER spatules abdominales ..... 191  
 HAIGHT écarteurs pour costaux ..... 298  
 HALLE élévateurs pour septum ..... 314  
 HALSEY porte-aiguilles ..... 232  
 HALSTED-MOSQUITO pinces hémostatiques ..... 88  
 HALSTED-MOSQUITO pinces vasculaires atraumatiques ..... 111  
 HALSTED-MOSQUITO-micro pinces hémostatiques ..... 87  
 HARKEN pinces pour oreillette ..... 139, 180  
 HARRINGTON écarteurs ..... 194  
 HARRINGTON pinces à bronches ..... 176  
 HARRINGTON-BABY écarteurs ..... 194  
 HARTMANN pinces hémostatiques ..... 87  
 HARTMANN-micro pinces hémostatiques ..... 87  
 HARVEY pinces à couper le fil ..... 271  
 HARVEY pinces à couper le fil ..... 273

HEANEY porte-aiguilles ..... 236  
 HEGAR dilateurs ..... 321  
 HEGAR-Vascular porte-aiguilles ..... 235  
 HEISS pinces hémostatiques ..... 97  
 HENLEY écarteurs autostatiques ..... 217  
 HERTZLER écarteurs pour costaux ..... 308  
 HESS (DEBAKEY) clamps bulldog ..... 85  
 HIBBS écarteurs ..... 212  
 Hilaire crochets ..... 195-196  
 HOHENFELLNER ciseaux vasculaires ..... 37  
 HOPT pinces vasculaires atraumatiques ..... 112

**I**

IMA écarteurs ..... 286, 308  
 IMA Écarteur épicaudal ..... 215  
 Injecteur para héparine ..... 7  
 In-situ ciseaux valve veineuse ..... 39  
 Instruments pour varices ..... 313  
 IRIS ciseaux ..... 32  
 ISRAEL écarteurs ..... 205

**J**

JACOBSON micro porte-aiguilles ..... 242, 245  
 JACOBSON pinces hémostatiques ..... 98  
 JACOBSON sondes boutonnées ..... 315  
 JACOBSON-MOSQUITO pinces hémostatiques ..... 98  
 JANSEN pinces à dissection ..... 50  
 JAVID pinces pour carotide ..... 149  
 JOHNS HOPKINS clamps bulldog ..... 85  
 JONES pinces à champs ..... 171  
 JONES-Clip pinces à champs ..... 171  
 JORGENSEN ciseaux thoraciques ..... 41  
 JOSEPH ciseaux ..... 30  
 JUDD-ALLIS pinces à saisir les tissus ..... 181

**K**

KADER écarteurs ..... 190  
 KANTROWITZ pinces hémostatiques ..... 105  
 KELLY écarteurs ..... 189, 209  
 KELLY pinces à dissection et à ligature ..... 105  
 KELLY pinces hémostatiques ..... 89  
 KELLY-RANKIN pinces hémostatiques ..... 89  
 KILNER ciseaux ..... 31  
 KILNER crochet à vaisseaux ..... 314  
 KLINKENBERGH LOTH ciseaux thoraciques ..... 41  
 KOCHER écarteurs ..... 200-201, 204, 206  
 KOCHER pinces hémostatiques ..... 92-93  
 KOCHER-LANGENBECK écarteurs ..... 202  
 KOCHER-NIPPON pinces hémostatiques ..... 94  
 KOCHER-WAGNER écarteurs ..... 208  
 KOENIG écarteurs ..... 201  
 KOERTE écarteurs ..... 210  
 KRAYENBÜHL crochet à vaisseaux ..... 315

**L**

LAHEY pinces hémostatiques ..... 108  
 LAMBER-KAY pinces pour anastomoses d'aorte ..... 123  
 LAMBOTTE rugines ..... 262  
 Lames des bistouris, stériles ..... 14, 16  
 Lames des bistouris, micro ..... 16  
 LANE pinces à saisir les tissus ..... 172  
 LANGENBECK davier à os ..... 258  
 LANGENBECK écarteurs ..... 199, 201  
 LANGENBECK rugines ..... 262  
 LAWRENCE pinces hémostatiques ..... 104  
 LAZAR pinces pour nouer les fils ..... 55  
 LEBSCHÉ ciseau-burin à sternum ..... 261  
 LEBSCHÉ costotomes ..... 278  
 LEES pinces pour bronches ..... 114  
 LEKSELL pinces-gouges ..... 251  
 LEKSELL-STILLE pinces-gouges ..... 251  
 LELAND-JONES pinces polyvalentes ..... 122  
 LELAND-JONES pinces vasculaires périphériques ..... 121  
 LEMMON rapprocheurs pour costaux ..... 223  
 LERICHE écarteurs ..... 210  
 LERICHE pinces hémostatiques ..... 96  
 LEXER ciseaux à dissection ..... 25  
 LEXER-FINO ciseaux à dissection ..... 24  
 LIDDLE pinces pour l'aorte ..... 123  
 LISTER pinces à dissection et à ligature ..... 175  
 LISTON pinces coupantes à os ..... 253  
 LITTAUER ciseaux à ligature ..... 41

LITTLEWOOD pinces à saisir les tissus ..... 184  
 LOCKHART-MUMMERY sonde ..... 324  
 LORNA pinces à champs ..... 172  
 LOVE-GRUENWALD perforateur pour l'aorte ..... 17  
 LOVELACE pinces à saisir le poumon ..... 175  
 LOVELACE pinces hémostatiques ..... 96  
 LUCAE pinces à dissection ..... 50

**M**

Maillets ..... 261  
 Manche pour stripper à anneau ..... 312  
 Manches de bistouris ..... 10-13, 16  
 Manches de bistouris, micro ..... 16  
 MARQUARDT pinces-gouges ..... 248  
 MARTIN écarteurs ..... 211  
 MARTIN pinces à pansements ..... 174  
 MARTIN spatules abdominales ..... 191  
 MARTIN-WYLIE pinces, vasculaires périphériques ..... 150  
 MATHIEU porte-aiguilles ..... 237  
 MATSON rugines ..... 263  
 MATSON-ALEXANDER rugines ..... 263  
 MAYO ciseaux à dissection ..... 23  
 MAYO-HEGAR porte-aiguilles ..... 233  
 MAYO-STILLE ciseaux à dissection ..... 24  
 McINDOE ciseaux vasculaires ..... 38  
 McINDOE pinces à dissection ..... 52  
 MCINDOE pinces coupantes à os ..... 254  
 McQUIGG-MIXTER pinces hémostatiques ..... 107  
 MEEKER pinces hémostatiques ..... 104  
 MEHDORN clips vasculaires ..... 66  
 MEHDORN pinces à appliquer les clips vasculaires ..... 66  
 MERCEDES écarteurs thoraciques ..... 303  
 METZENBAUM ciseaux à dissection ..... 26  
 METZENBAUM FINO ciseaux à dissection ..... 27-30  
 METZENBAUM-NELSON ciseaux à dissection ..... 30  
 Micro porte-aiguilles ..... 239-246  
 Micro-Pinces ..... 54-64  
 Microvasculaire porte-aiguilles ..... 235  
 MIDDELDORPF écarteurs ..... 187  
 MIKULICZ écarteurs ..... 207  
 MIKULICZ pinces à peritoine ..... 108  
 MIKULICZ-Baby pinces à peritoine ..... 108  
 MILLESI ciseaux micro ..... 44  
 MILLS ciseaux vasculaires ..... 36  
 MINI (YASARGIL) clips d'anévrisme ..... 76-77  
 MIXTER pinces hémostatiques ..... 106-107  
 MIXTER-BABY pinces hémostatiques ..... 106  
 MIXTER-O'SHAUGNESSY pinces hémostatiques ..... 107  
 MOCK-DEBAKEY aiguilles pour héparine ..... 7  
 MORSE écarteurs pour sternum ..... 304-305  
 MORSE-FAVALORO écarteurs pour sternum ..... 305  
 MÜLLER approximateurs ..... 68  
 MÜLLER clips vasculaires ..... 71  
 MURPHY écarteurs ..... 198

**N**

NABATOFF stripper à varices ..... 310  
 NEIVERT porte-aiguilles ..... 232  
 NELSON pinces à dissection ..... 52  
 NELSON trocarts ..... 8

**O**

OCHSNER pinces à aorte ..... 148  
 OLSEN HEGAR porte-aiguilles ..... 238  
 OVERHOLT pinces hémostatiques ..... 101-102  
 OVERHOLT rugines ..... 264  
 OVERHOLT-BABY pinces hémostatiques ..... 101  
 OVERHOLT-fino pinces hémostatiques ..... 101  
 OVERHOLT-GEISSENDOERFER pinces hémostatiques ..... 100  
 OVERHOLT-MIXTER pinces hémostatiques ..... 107

**P**

PARKER-LANGENBECK écarteurs ..... 187  
 PEAN pinces hémostatiques ..... 91, 93  
 PEAN pinces vasculaires atraumatiques ..... 111  
 PEAN-NIPPON pinces hémostatiques ..... 94  
 PEERS-BERTRAM pinces à champs ..... 171  
 PENNINGTON pinces hémostatiques ..... 96  
 Perforateurs pour l'aorte ..... 17

**Inhaltsverzeichnis**

Index  
Index  
Índice alfabético  
Indice alfabetico

PERWITZCHKY ciseaux .....32  
Phlebodissecteur ..... 313  
Phleboextracteur ..... 313  
Pincés à couper le fil.....272  
Pince à ligature ..... 87  
Pince à rouleaux..... 110  
Pince à saisir la valvule cardiaque..... 184  
Pince à saisir l'embolus .....180  
Pince aiguille-tirant..... 62  
Pince coupantes de cote .....271-273  
Pince pour poser et retirer  
les clamps Bulldog ..... 85  
Pincés pour l'aorte ..... 123, 125, 147-148  
Pincés pour veine iliaque..... 124, 158  
Pincés-gouges..... 248  
Pincés à anastomose..... 117-118, 147,  
159-160, 162-163  
Pincés à appliquer les clips d'anévrisme ... 76-77  
Pincés à appliquer  
les clips vasculaires... 65-70, 74  
Pincés à champs ..... 171-172  
Pincés pour coarctation .....  
115-116, 143-146, 157-158  
Pincés à couper le fil .....271-273  
Pincés à dissection ..... 48-64  
Pincés à dissection et à ligatures .....  
99, 105, 142, 151-152, 175  
Pincés à pansements ..... 173-174  
Pincés à ligature..... 149  
Pincés à peritoine ..... 108  
Pincés à saisir les tissus .....172 - 184  
Pincés à saisir le poumon .....175  
Pincés à torsader le fil .....269-270  
Pincés anneau .....57, 63-64  
Pincés atraumatiques .....57-64  
Pincés avec poids ..... 63  
Pincés coupantes à os .....252-257  
Pincés d'horloger .....53  
Pincés hémostatiques .....87-108  
Pincés hémostatiques, titane ..... 88-89  
Pincés plates .....268-269  
Pincés pour carotide..... 149, 164-165  
Pincés pour nouer les fils.....54-56, 63-64  
Pincés pour oreillette ..... 139  
Pincés pour saisir des organes ..... 140  
Pincés pour sondes ..... 155  
Pincés pout appliquer les clips .....75  
Pincés serre-tubes..... 109  
Pincés vasculaires atraumatiques ..... 111-170  
Pincés vasculaires flexibles ..... 170  
Pincés vasculaires pour  
mors interchangeables ..... 136  
Pincés vena cava ..... 138, 141, 155, 179  
Pincés, micro .....54-64  
Pincés, mors diamanté.....57, 63-64  
Pincés, titane..... 58, 64  
Pincés pour bronches .....114, 176-178  
Pincés polyvalentes ..... 120, 122, 141, 157  
.....162, 164-165  
Pincés pour anastomoses d'aorte..... 123  
Pincés pour anévrisme  
d'aorte .....126-129, 131  
Pincés pour des nouveaux-nés  
et des enfants .....156, 159, 162, 166-169  
Pincés pour occlusion  
tangentielle ..... 134, 138, 161  
Pincés pour profunda ..... 152  
Pincés vasculaires à dilatation.....54  
Pincés, vasculaires  
périphériques ..... 119, 121, 140, 150  
Pincés-gouges ..... 248-252  
Plateaux pour micro clips d'anévrisme..... 78  
POOLE tube d'aspiration .....2  
POPPEN tube d'aspiration .....6  
Porte-aiguilles .....229-246  
Porte-aiguilles, micro .....239-246  
Porte-aiguilles,  
mors diamanté ..... 242-244, 246  
Porte-aiguilles, titane ..... 246  
Porte-ligatures.....318  
POTTS pincés pour coarctation..... 115-116, 143  
POTTS-DE MARTEL ciseaux vasculaires..... 36  
POTTS-SMITH ciseaux vasculaires ..... 33-34, 36  
POTTS-SMITH pincés à dissection ..... 48  
POTTS-YASARGIL ciseaux micro .....44

PRESBYTERIAN HOSPITAL pincés serre-tubes.109  
PRICE-THOMAS pincés pour bronches ..... 177  
PROVIDENCE-HOSPITAL pincés hémostatiques  
..... 90

**R**

RAGNELL-DAVIS écarteurs ..... 191  
RAMPLEY pincés à pansements ..... 174  
RANKIN pincés vasculaires atraumatiques..... 112  
Rapprocheurs pour costaux ..... 223  
Récipients métalliques ..... 320  
REILL pincés à couper le fil.....272  
REYNOLDS ciseaux ..... 31  
RICHARDSON écarteurs..... 187, 189  
ROBB dissecteurs vasculaires .....323  
ROBERTS pincés hémostatiques ..... 103  
ROCHESTER-CARMALT pincés  
hémostatiques.....95  
ROCHESTER-OCHSNER pincés  
hémostatiques..... 92  
ROCHESTER-PEAN pincés hémostatiques .....91  
ROSS écarteurs pour l'aorte .....227  
ROUX écarteurs.....186  
ROUX-mini écarteurs ..... 186  
Rugines .....262-267  
Rugines pour costaux .....265  
RUMEL-BELMONT tourniquets .....318  
RUMMEL pincés hémostatiques ..... 102  
RUSKIN pincés-gouges .....248  
RUSKIN-LISTON pincés coupantes à os.....254  
Russ. Mod. pincés à dissection.....52  
RYDER porte-aiguilles .....234  
RYDER-Vascular porte-aiguilles.....235

**S**

SANTULLI clamps bulldog.....80  
SANVENERO ciseaux ..... 30  
SAROT pincés hémostatiques ..... 103  
SAROT pincés pour bronches .....178  
SAROT porte-aiguilles .....237  
SATINSKY ciseaux vasculaires ..... 39  
SATINSKY clamps bulldog .....79  
SATINSKY pincés à anastomose.....179  
SATINSKY pincés pour occlusion tangentielle. 134  
SAUERBRUCH costotomes .....278  
SAUERBRUCH écarteurs .....214  
SAUERBRUCH pincés-gouges .....250  
Scapula, écarteurs .....214  
SCHAEDEL pincés à champs.....171  
SCHEDE curettes tranchantes .....260  
SCHEIBE pincés à saisir les tissus ..... 183  
SCHMID aiguilles vasculaires pour irrigation .....7  
SCHNIDT pincés à dissection et à ligature ..... 175  
SCHOENBORN écarteurs .....195  
SCHUMACHER ciseaux à sternum.....274  
Scie sternale.....280  
SELLORS rapprocheurs pour costaux .....223  
SELMAN pincés à dissection..... 50  
SEMB davier à os.....259  
SEMB pincés-gouges .....252  
SEMB pincés à dissection et à ligature.....178  
SEMB pincés coupantes à os .....257  
SEMB rugines.....266  
SEMB spatules pulmonaires .....224  
SEMKEN pincés à dissection .....51  
SENN écarteurs ..... 191  
Shunt .....170  
SIMON écarteurs ..... 211  
SINGLEY pincés à dissection .....52  
SLS clips titane à ligature .....75  
SMITH-PETERSEN pincés-gouges.....252  
Sondes .....324  
Sondes boutonnières.....315  
Spatules pour intima .....323  
Spatule pour l'iris ..... 316  
Spatules abdominales.....190-193  
Spatules pulmonaires ..... 224  
SPENCER ciseaux à ligature ..... 41  
SPENCER-WELLS pincés hémostatiques .....95  
STANDARD (YASARGIL) clips  
d'anévrisme .....76-77  
STILLE costotomes .....275  
LISTON-KEY-HORSLEY pincés coupantes  
à os .....257  
STILLE-LISTON pincés coupantes à os .....255-256

STILLE-LUER pincés-gouges .....249-250  
STRATE porte-aiguilles .....236  
Stripper à varices .....310-312  
Stripper à anneau.....312  
STRUCK écarteurs pour costaux .....297  
STRULLY ciseaux vasculaires ..... 38  
SUBRAMINIAN pincés à l'aorte ..... 147  
SUBRAMINIAN-MINIATURE  
pincés à l'aorte ..... 147

**T**

TEALE pince à saisir la valvule cardiaque..... 184  
THOMS-ALLIS pincés à saisir les tissus ..... 181  
Thoraciques, écarteurs .....303  
Thoracoscopie .....325-330  
THOREK ciseaux thoraciques .....40  
TOENNIS dissecteurs ..... 316  
TOENNIS porte-aiguilles .....237  
TOENNIS-ADSON ciseaux vasculaires..... 38  
TOHOKU pincés à champs ..... 172  
TOLEDO ciseaux micro-vasculaires ..... 43  
TOLEDO micro porte-aiguilles ..... 243  
TOLEDO pincés, micro .....56  
Tourniquets.....318  
Trocarts .....8, 328  
TUBBS dilataateurs pour valve mitrale.....317  
Tubes d'aspiration .....2-7, 329  
TUFFIER écarteurs pour costaux ..... 300  
Tunnelisation, jeu ..... 322

**U**

ULRICH pincés à pansements .....173  
ULTRA-LIGHT pincés atraumatiques ..... 62  
US-Army (PARKER-LANGENBECK) écarteurs .187

**V**

VANDERBILT pincés hémostatiques..... 102  
VANNAS ciseaux micro .....44  
VARADY dissecteurs, micro ..... 313  
VARADY Instruments pour varices ..... 313  
VARADY phlebodissecteur .....313  
VARADY phleboextracteur .....313  
VARADY stripper à varices .....311  
VOLKMANN curettes tranchantes.....260  
VOLKMANN écarteurs .....197-198  
VOLLMAR Manche pour stripper à anneau...312  
VOLLMAR strippers à anneau ..... 312

**W**

WALTON-YANKAUER tube d'aspiration ..... 4  
WANGENSTEEN pincés à dissection..... 52  
WANGENSTEEN porte-aiguilles.....236  
WAUGH pincés à dissection ..... 50  
WEBER pincés à l'aorte .....125  
WEBSTER porte-aiguilles .....231  
WECKER spatules pour l'iris .....316  
WEINBERG écarteurs pour costaux .....295  
WEITLANER écarteurs autostatiques .....216-219  
WICKSTROEM pincés hémostatiques ..... 107  
WILLAUER ciseaux thoraciques ..... 40  
WILLIAMS pincés à saisir les tissus ..... 184  
WOLF tubes d'aspiration.....2, 329  
WYLIE pincés vasculaires atraumatiques..... 135

**Y**

YANKAUER tubes d'aspiration .....4  
YANKAUER-BABY tubes d'aspiration.....4  
YASARGIL ciseaux micro .....44  
YASARGIL clips d'anévrisme .....76-77  
YASARGIL clips pour la fermeture  
permanente .....76-77

**Z**

ZAUFEL-JANSEN pincés-gouges ..... 248  
ZENKER écarteurs.....203  
ZENKER pincés hémostatiques ..... 104



**A**

ABRAMS aguja de la biopsia pleural ..... 8  
 ACLAND aproximadores.....73  
 ACLAND clips vasculares .....72-73  
 ACLAND pinza aplicadora  
 para clips vasculares ..... 74  
 ADSON pinzas de disección .....49-50  
 ADSON pinzas hemostáticas .....98  
 ADSON separadore autostáticos.....219  
 ADSON-BABY pinzas hemostáticas ..... 98  
 ADSON-DE BAKEY pinzas atraumáticas ..... 61  
 ADSON-micro pinzas de disección ..... 49  
 Aguja de la biopsia pleural .....8  
 Aguja para heparina.....7  
 ALEXANDER periostótomos .....263  
 Alicates de pico plano .....268-269  
 Alicates para cortar alambre .....271-273  
 ALLIS pinzas para coger tejidos ..... 181  
 ALLIS-BABY pinzas para coger tejidos.....181  
 ALLISON espátula pulmonares .....224  
 ALLPORT separadore autostáticos .....216  
 ALM separadore autostáticos .....216  
 ANDREWS-PYNCHON tubo de aspiración ..... 5  
 ANKENY separadores para esternón .....306-307  
 Aproximadores .....67-70  
 Aproximadores para costillas .....223  
 Atrauma Clamps Bulldog .....79-84  
 AUSTIN pinzas para enlazar .....55  
 Automatic pinza para torcer alambre .....269

**B**

BABCOCK pinzas para coger tejidos .....182  
 BABY-HAIGHT separadore costales.....288  
 Baby-MIXTER pinzas hemostáticas .....106  
 BABY-POOLE tubo de aspiración .....2  
 BACKHAUS pinzas para campos .....171  
 BADGLEY separadores costales.....299  
 BAILEY aproximadores para costillas .....223  
 BAILEY perforadores aórticos .....17  
 BAILEY-BABY aproximadores para costillas ..223  
 BAILEY-GIBBON aproximadores  
 para costillas .....223  
 BAINBRIDGE pinzas clamps  
 para multiuso .....122  
 BALFOUR separadores abdominales.....222  
 BALL AND SOCKET pinzas para campos .....172  
 BANGOLEA pinzas hemostáticas .....97  
 BARRAQUER micro porta-agujas .....240  
 BARRAQUER-TROUTMAN  
 micro porta-agujas .....240  
 Batería .....280  
 BAUMGARTNER pinza para torcer alambre ..270  
 BAUMGARTNER porta-agujas .....232  
 BECK pinzas clamps para multiuso .....141  
 BECKMANN separadores autostáticos.....220  
 BECKMANN-ADSON separadore  
 autostáticos .....220  
 BERLIN pinze serretubi .....109  
 BERRY pinza para torcer alambre.....270  
 BETHUNE costótomo.....277  
 BEYER pinza-gubias .....248  
 BIEMER aproximadores .....69  
 BIEMER clips vasculares .....65  
 BIEMER pinza aplicadora  
 para clips vasculares .....65, 67-68  
 BIEMER separador para vasos .....315  
 BIEMER tijeras para venas .....44  
 BIEMER-MÜLLER aproximadores .....67  
 BLAKE pinzas para coser émbolo .....180  
 BOEHLER pinza-gubias.....248  
 BOEHLER pinzas cortantes para hueso.....253  
 BOROWSKI separadores para aorta .....228  
 BOZEMANN porta-agujas .....236  
 BRAUN-RALPH tubo de aspiración.....5  
 BRAUN-STADLER tijeras.....38  
 BRIDGE pinzas hemostáticas.....104  
 BROM gancho para vasos .....314  
 BROMPTON pinzas con rodillo.....110  
 BRUNNER costótomo .....279  
 BRUNS cucharillas cortantes .....260  
 BULLDOG clips vasculares .....71

**C**

Cánula para insuflación .....328  
 Cánulas para venas.....7

Cánulas vasculares para irrigación.....7  
 Cargador .....280  
 CAROTID clamps bulldog .....79  
 CASTAÑEDA pinzas clamps  
 para recién nacidos y niños .....166, 169  
 CASTAÑEDA separadore costales .....295  
 CASTROVIEJO micro porta-agujas .....240-242  
 CASTROVIEJO-JACOBSON  
 micro porta-agujas .....242  
 CHITWOOD-DE BAKEY tira-agujas.....62  
 CHITWOOD-DE BAKEY pinzas atraumáticas ...62  
 Cinceles .....261  
 Cirugía ósea .....247-280  
 Clamps bulldog .....79-86, 113, 153-154  
 Clamps bulldog, micro .....79, 86  
 Clamps bulldog, titanio .....86  
 CLEVELAND pinzas cortantes para hueso.....252  
 Clips titanio para ligadura.....75  
 COLLIN costótomo .....275  
 CONE separadore autostáticos .....221  
 Contenedores para micro clips  
 de aneurisma .....78  
 COOLEY clamps bulldog .....84, 153-154  
 COOLEY costótomo .....277  
 COOLEY dilatadores para válvula mitral.....317  
 COOLEY dilatadores vasculares .....319  
 COOLEY pinzas para carótido .....164-165  
 COOLEY pinza clamp para iliaca .....158  
 COOLEY pinzas atraumáticas .....60  
 COOLEY pinzas clamps para recién  
 nacidos y niños .....156, 159, 162, 167-168  
 COOLEY pinzas clamps para  
 multiuso .....157, 162, 164-165  
 COOLEY pinzas para  
 anastomosis .....159-160, 162-163  
 COOLEY pinzas para catéteres.....155  
 COOLEY pinzas para coarctación .....157-158  
 COOLEY pinzas para oclusión tangencial ....161  
 COOLEY separadores atrium .....225-226  
 COOLEY separadores costales .....283-285  
 COOLEY tubo de aspiración .....3  
 COOLEY-BECK pinzas para anastomosis.....160  
 COOLEY-DERRA pinzas para anastomosis ....162  
 COPE aguja de la biopsia pleural.....8  
 CORYLLOS costótomo .....276  
 CORYLLOS separadores torácico .....213  
 Costótomos .....274-279  
 CRAFOORD pinzas hemostáticas .....103  
 CRAFOORD tijeras torácica.....40  
 CRAFOORD-SELLORS pinzas hemostáticas ...103  
 CRILE gancho para vasos .....314  
 CRILE pinzas hemostáticas .....89  
 CRILE-RANKIN pinzas hemostáticas .....90  
 CRILE-WOOD porta-agujas .....232  
 CRILE-WOOD-BABY porta-agujas .....233  
 Cucharillas cortantes .....260  
 CUSHING gancho para vasos .....314  
 CUSHING gancho para venas.....195  
 CUSHING hiliares gancho .....196  
 CUSHING pinzas de disección .....50  
 CUSHING separadores.....195  
 CUSHING-KOCHER separadores .....201  
 CUSHING-TAYLOR pinzas de disección .....50

**D**

D'AMICO tubo de aspiración .....2, 329  
 DALE pinzas para vasos periféricos .....140  
 DANDY pinzas hemostáticas .....96  
 DARDIK pinzas clamps para multiuso .....120  
 DARLING separadores autostáticos.....221  
 DAVIDSON (Scapula) separadores.....214  
 DAVIS Elevadores .....316  
 DE BAKEY aguja para heparina .....7  
 DE BAKEY dilatadores vasculares .....319-320  
 DE BAKEY pinza clamp para iliaca .....124  
 DE BAKEY pinzas atraumáticas .....57-64  
 DE BAKEY pinzas clamps para aneurisma  
 de aorta .....126, 128, 132, 141  
 DE BAKEY pinzas clamps  
 para multiuso .....130, 133  
 DE BAKEY pinzas para anastomosis .....149  
 DE BAKEY pinzas para coarctación .....144-146  
 DE BAKEY pinzas para ligaduras .....149  
 DE BAKEY pinzas para  
 vasos periféricos .....119, 121

DE BAKEY porta-agujas .....233-234  
 DE BAKEY separadores costales .....291, 301-302  
 DE BAKEY tijeras vasculares .....33, 36, 37  
 DE BAKEY tijeras compensar .....37  
 DE BAKEY tubo de aspiración.....5  
 DE BAKEY-ADSON pinzas atraumáticas.....61  
 DE BAKEY-BAHNSON pinzas clamps para  
 aneurisma de aorta .....127  
 DE BAKEY-BECK pinzas clamps  
 para multiuso .....141  
 DE BAKEY-DIETHRICH pinzas atraumáticas.....60  
 DE BAKEY-GERALD pinzas atraumáticas.....61  
 DE BAKEY-MC QUIGG MIXTER pinzas  
 para disección y ligaduras.....151  
 DE BAKEY-MIXTER pinzas para disección  
 y ligaduras.....152  
 DE BAKEY-MORRIS pinzas clamps  
 para aneurisma de aorta .....129  
 DE BAKEY-REYNOLDS pinzas  
 para anastomosis .....147  
 DE BAKEY-RUMMEL pinzas para disección y  
 ligaduras .....151  
 DE BAKEY-SATINSKY pinzas para oclusión  
 tangencial .....138  
 DE BAKEY-SEMB pinzas clamps  
 para aneurisma de aorta .....131  
 DE BAKEY-SEMB pinzas para disección y  
 ligaduras .....142  
 DEEVER separadore .....192-193  
 DEBAKEY clamps bulldog .....82, 113  
 DEBAKEY-DIETHRICH clamps bulldog.....81  
 DERF porta-agujas .....231  
 Derivación .....170  
 DERRA pinzas para coarctación.....144  
 DESMARRES hiliares gancho .....196  
 DIEFFENBACH clamps bulldog .....85  
 DIETHRICH clamps bulldog .....81  
 DIETHRICH tijeras vasculares .....35  
 DIETRICH micro porta-agujas .....244  
 DIETRICH pinza clamp para aorta.....148  
 Dilatación vascular, pinzas .....54  
 Dilatadores para válvula mitral .....317  
 Dilatadores vasculares.....315, 319-321  
 Disecador, micro .....313  
 Disecadores .....316  
 Disecadores vasculares .....323  
 DOYEN legras costales .....265  
 DUBOST separadore costales .....296  
 DURANTE pinzas de disección .....52  
 DUVAL pinzas para coger tejidos .....183

**E**

ECHLN pinza-gubias.....252  
 EDWARDS clips.....137  
 EDWARDS pinza para aplicar clips.....137  
 Elevadores .....314-316  
 Elevadores para septo .....314  
 Endoscopio .....327  
 Espátula íntima.....323  
 Espátula para iris .....316  
 Espátulas abdominales .....190-193  
 Espátulas pulmonares .....224  
 Esterilización embudo para la batería.....274  
 ETHICON® clips titanio para ligadura .....75

**F**

FARABEUF periostótomos .....262  
 FARABEUF separadores .....186  
 FAVALORO tijeras de arteria coronaria.....37  
 FAVALORO separadores para esternón .....305  
 FERGUSSON Cánulas para aspiración e  
 irrigación .....6  
 FERGUSSON pinza para huesos.....258  
 FICHSIG pinzas hemostáticas .....97  
 FINOCHIETTO (modif.) separadores  
 costales .....282  
 FINOCHIETTO BABY-HAIGHT  
 separadores costales .....288  
 FINOCHIETTO pinzas clamps bronquiales ....176  
 FINOCHIETTO porta-agujas .....237  
 FINOCHIETTO separadores  
 costales .....282, 287-289  
 FINOCHIETTO tijeras para lobotomía .....41  
 FINOCHIETTO-BABY separadores costales ..283

FINOCHIETTO-BURFORD	
separadores costales	290, 292-294
FINOCHIETTO-INFANT	
separadores costales	289
FINSSEN separadores autostáticos	215
FINSTERER cánulas	
para aspiración e irrigación	5
FISCH gancho para vasos	315
Fleboextractor	313
Fleboextractor	313
Fleboextractores	312
FOERSTER pinzas para tapones	174
FOGARTY pinzas vasculares atraumáticas	136
FRAZIER tubo de aspiración	6
FREER elevadores	316
FRITSCH separador	188
FRYKHOLM pinza-gubias	251

**G**

Gancho para venas	195
Ganchos para vasos	314-315
GARRETT dilatadores vasculares	320
GARRETT injecteur para heparina	7
GEMINI pinzas para disección y ligaduras	99
GEMINI-mini pinzas para disección y ligaduras	99
GERALD pinzas de disección	51
GERALD-DEBAKEY pinzas atraumáticas	61
GIERTZ-STILLE costótomo	278
GIL VERNET hiliares gancho	195
GILLIES gancho para vasos	314
GILLIES pinzas de disección	51
GILLIES porta-agujas	238
GLASSMAN pinzas atraumáticas	61
GLOVER clamps bulldog	79, 83
GLOVER pinzas para anastomosis	117-118
GLOVER pinzas para coarctación	146
GLOVER-DE BAKEY pinzas vasculares atraumáticas	135
GLOVER-mini clamps bulldog	79
GLUCK costótomo	275
GOMEL pinzas para enlazar	55
GOSLEE alicata de pico plano	269
GREGORY pinzas clamps para profunda	152
GREGORY-"Soft" clamps bulldog	80
GROSS-MAIER pinzas para tapones	173
GUNNER-HEY pinzas con rodillo	110

**H**

HABERER espátula abdominales	191
HAIGHT separadores costales	298
HALLE elevadores para septo	314
HALSEY porta-agujas	232
HALSTED-MOSQUITO pinzas hemostáticas	88
HALSTED-MOSQUITO pinzas vasculares atraumáticas	111
HALSTED-MOSQUITO-micro pinzas hemostáticas	87
HARKEN pinzas para aurícula	139, 180
HARRINGTON pinzas clamps bronquiales	176
HARRINGTON separadores	194
HARRINGTON-BABY separadores	194
HARTMANN pinzas hemostáticas	87
HARTMANN-micro pinzas hemostáticas	87
HARVEY alicates para cortar alambre	271
HARVEY alicates para cortar alambre	273
HEANEY porta-agujas	236
HEGAR dilatadores	321
HEGAR-Vascular porta-agujas	235
HEISS pinzas hemostáticas	97
HENLEY separadores autostáticos	217
HERTZLER separadores costales	308
HESS (DEBAKEY) clamps bulldog	85
HIBBS separadores	212
Hiliares ganchos	195-196
Hilo para huesos	268
HOHENFELLNER tijeras vasculares	37
Hojas de bisturís estériles	14, 16
Hojas de bisturís estériles, micro	16
HOPT pinzas vasculares atraumáticas	112

**I**

IMA separadores	286, 308
IMA separador epicardiaco	215

In-situ tijeras para la válvula venosa	39
Instrumentos para varices	313
Injecteur para heparina	7
IRIS tijeras	32
ISRAEL separadore	205

**J**

JACOBSON micro porta-agujas	242, 245
JACOBSON pinzas hemostáticas	98
JACOBSON sondas abotonadas	315
JACOBSON-MOSQUITO pinzas hemostáticas	98
JANSEN pinzas de disección	50
JAVID pinzas para carótido	149
JOHNS HOPKINS clamps bulldog	85
JONES pinzas para campos	171
JONES-Clip pinzas para campos	171
JORGENSEN tijeras torácica	41
JOSEPH tijeras	30
JUDD-ALLIS pinzas para coger tejidos	181

**K**

KADER separadores	190
KANTROWITZ pinzas hemostáticas	105
KELLY pinzas hemostáticas	89
KELLY pinzas para disección y ligaduras	105
KELLY separadores	189, 209
KELLY-RANKIN pinzas hemostáticas	89
KILNER gancho para vasos	314
KILNER tijeras	31
KLINKENBERGH LOTH tijeras torácica	41
KOCHER pinzas hemostáticas	92-93
KOCHER separadores	200-201, 204, 206
KOCHER-LANGENBECK separadores	202
KOCHER-NIPPON pinzas hemostáticas	94
KOCHER-WAGNER separadores	208
KOENIG separadores	201
KOERTE separadores	210
KRAYENBÜHL gancho para vasos	315

**L**

LAHEY pinzas hemostáticas	108
LAMBER-KAY pinzas clamps para anastomosis de aorta	123
LAMBOTTE periostótomo	262
LANE pinzas para coger tejidos	172
LANGENBECK periostótomo	262
LANGENBECK pinza para huesos	258
LANGENBECK separadores	199, 201
LAWRENCE pinzas hemostáticas	104
LAZAR pinzas para enlazar	55
LEBSCHÉ cinceles	261
LEBSCHÉ costótomo	278
LEES pinzas clamps bronquiales	114
Legras costales	265
LEKSELL pinza-gubias	251
LEKSELL-STILLE pinza-gubias	251
LELAND-JONES pinzas clamps para multiuso	122
LELAND-JONES pinzas para vasos periféricos	121
LEMMON aproximadores para costillas	223
LERICHE pinzas hemostáticas	96
LERICHE separadores	210
LEXER tijeras de disección	25
LEXER-FINO tijeras de disección	24
LIDDLE pinza clamp para aorta	123
LISTER pinzas para disección y ligaduras	175
LISTON pinzas cortantes para hueso	253
LITTAUER tijeras para hilos	41
LITTLEWOOD pinzas para coger tejidos	184
LOCKHART-MUMMERY sondas	324
LORNA pinzas para campos	172
LOVE-GRUENWALD perforadores aórticos	17
LOVELACE pinzas hemostáticas	96
LOVELACE pinzas para coger el pulmón	175
LUCAE pinzas de disección	50

**M**

Mango para disectores para endarterectomía	312
Mangos de bisturís	10-13, 16
Mangos de bisturís, micro	16
MARQUARDT pinza-gubias	248
Martillos	261
MARTIN espátula abdominales	191

MARTIN pinzas para tapones	174
MARTIN separadores	211
MARTIN-WYLIE pinzas para vasos periféricos	150
MATHIEU porta-agujas	237
MATSON periostótomo	263
MATSON-ALEXANDER periostótomo	263
MAYO tijeras de disección	23
MAYO-HEGAR porta-agujas	233
MAYO-STILLE tijeras de disección	24
MCINDOE pinzas cortantes para hueso	254
McINDOE pinzas de disección	52
McINDOE tijeras vasculares	38
McQUIGG-MIXTER pinzas hemostáticas	107
MEEKER pinzas hemostáticas	104
MEHDORN clips vasculares	66
MEHDORN pinzas aplicadoras para clips vasculares	66
MERCEDES retractor torácico	303
METZENBAUM FINO tijeras de disección	27-30
METZENBAUM tijeras de disección	26
METZENBAUM-NELSON tijeras de disección	30
Micro porta-agujas	239-246
Micro-Pinzas	54-64
Microvascular porta-agujas	235
MIDDELDORPF separadores	187
MIKULIC pinzas para peritoneo	108
MIKULIC separadores	207
MIKULIC-Baby pinzas para peritoneo	108
MILLESÍ tijeras microquirúrgicas	44
MILLS tijeras vasculares	36
MINI (YASARGIL) clips de aneurisma	76-77
MIXTER pinzas hemostáticas	106-107
MIXTER-BABY pinzas hemostáticas	106
MIXTER-O'SHAUGNESSY pinzas hemostáticas	107
MOCK-DEBAKEY agija para heparina	7
MORSE separadores para esternón	304-305
MORSE-FAVALORO separadores para esternón	305
MÜLLER aproximadores	68
MÜLLER clips vasculares	71
MURPHY separadores	198

**N**

NABATOFF sondas para várices	310
NEIVERT porta-agujas	232
NELSON pinzas de disección	52
NELSON trócares	8

**O**

OCHSNER pinza clamp para aorta	148
OLSEN HEGAR porta-agujas	238
OVERHOLT periostótomos	264
OVERHOLT pinzas hemostáticas	101-102
OVERHOLT-BABY pinzas hemostáticas	101
OVERHOLT-fino pinzas hemostáticas	101
OVERHOLT-GEISSENDOERFER pinzas hemostáticas	100
OVERHOLT-MIXTER pinzas hemostáticas	107

**P**

PARKER-LANGENBECK separadores	187
PEAN pinzas hemostáticas	91, 93
PEAN pinzas vasculares atraumáticas	111
PEAN-NIPPON pinzas hemostáticas	94
PEERS-BERTRAM pinzas para campos	171
PENNINGTON pinzas hemostáticas	96
Perforadores aórticos	17
Periostótomos	262-267
Periostótomos	262-267
PERWITZCHKY tijeras	32
Pinza aplicadora para clips de aneurisma	76-77
Pinza aplicadora para clips vasculares	65-70, 74
Pinza clamp para aorta	123, 125, 147-148
Pinza clamp para iliaca	124, 158
Pinza para la vena cava	138, 141, 155, 179
Pinza para aplicar clips	137
Pinza para hilos	87
Pinza para poner y quitar clamps bulldog	85
pinza-gubias	248
Pinzas tira-agujas	62
Pinzas anillo	57, 63-64

Pinzas atraumáticas .....	57-64
Pinzas cierra-tubos.....	109
Pinzas clamps bronquiales .....	114, 176-178
Pinzas clamps para anastomosis	
de aorta.....	123
Pinzas clamps para aneurisma	
de aorta.....	126-129, 131
Pinaas clamps para carótido.....	149, 164-165
Pinzas clamps para profunda.....	152
Pinzas clamps para recién nacidos	
y niños.....	156, 159, 162, 166-169
Pinzas clamps para multiuso .....	120, 122,
.....	141, 157, 162, 164-165
Pinzas con peso .....	63
Pinzas con rodillo .....	110
Pinzas cortantes para hueso.....	252-257
Pinzas de corazón-válvula .....	184
Pinzas de dilatación vascular .....	54
Pinzas de disección.....	48-64
Pinzas de relojero.....	53
Pinzas émbolo.....	180
Pinzas hemostáticas .....	87-108
Pinzas hemostáticas, titanio.....	88-89
Pinzas para anastomosis .....	117-118,
.....	147, 159-160, 162-163
Pinzas para aplicar clips .....	75
Pinzas para auricular .....	139
Pinzas para campos .....	171-172
Pinzas para catéteres.....	155
Pinzas para coarctación .....	115-116,
.....	143-146, 157-158
Pinzas para coger el pulmón .....	175
Pinzas para coger tejidos .....	172 - 184
Pinzas para disección y ligaduras	
.....	99, 105, 142, 151-152, 175
Pinzas para enlazar .....	54-56, 63-64
Pinzas para huesos .....	258-259
Pinzas para ligaduras .....	149
Pinzas para oclusión tangencial.....	134, 138, 161
Pinzas para peritoneo .....	108
Pinzas para sacar órganos .....	140
Pinzas para tapones.....	173-174
Pinzas para torcer alambre.....	269-270
Pinzas para vasos	
periféricos.....	119, 121, 140, 150
Pinzas vasculares atraumáticas.....	111-170
Pinzas vasculares atraumáticas .....	136
Pinzas vasculares flexibles .....	170
Pinzas, boca diamantada .....	57, 63-64
Pinzas, micro.....	54-64
Pinzas, titanio .....	58, 64
Pinzas gubias .....	248-252
POOLE tubo de aspiración .....	2
POPPE tubo de aspiración .....	6
Porta-agujas .....	229-246
Porta-agujas,	
boca diamantada .....	242-244, 246
Porta-agujas, micro .....	239-246
Porta-agujas, titanio .....	246
Porta ligaduras.....	318
POTTS pinzas para coarctación .....	115-116, 143
POTTS-DE MARTEL tijeras vasculares .....	36
POTTS-SMITH pinzas de disección.....	48
POTTS-SMITH tijeras vasculares .....	33-34, 36
POTTS-YASARGIL tijeras microquirúrgicas.....	44
PRESBYTERIAN HOSPITAL	
pinzas cierra-tubos .....	109
PRICE-THOMAS pinzas clamps	
bronquiales .....	177
PROVIDENCE-HOSPITAL pinzas	
hemostáticas.....	90

## Q

Quita hojas .....

..... 15

## R

RAGNELL-DAVIS separadores .....	191
RAMPLEY pinzas para tapones .....	174
RANKIN pinzas vasculares atraumáticas .....	112
Recipientes metálicos .....	320
REILL alicates para cortar alambre .....	272
Retractor de abonico.....	330
Retractor torácico .....	303
REYNOLDS tijeras.....	31
RICHARDSON separadores.....	187, 189

ROBB disectores vasculares.....	323
ROBERTS pinzas hemostáticas .....	103
ROCHESTER-CARMALT pinzas hemostáticas .....	95
ROCHESTER-OCHSNER pinzas hemostáticas..	92
ROCHESTER-PEAN pinzas hemostáticas .....	91
ROSS separadores para aorta .....	227
ROUX separadores .....	186
ROUX-mini separadores .....	186
RUMEL-BELMONT torniquetes .....	318
RUMMEL pinzas hemostáticas .....	102
RUSKIN pinza-gubias.....	248
RUSKIN-LISTON pinzas cortantes	
para hueso .....	254
Russ. Mod. pinzas de disección .....	52
RYDER porta-agujas .....	234
RYDER-Vascular porta-agujas .....	235

## S

SANTULLI clamps bulldog.....	80
SANVENERO tijeras .....	30
SAROT pinzas clamps bronquiales .....	178
SAROT pinzas hemostáticas.....	103
SAROT porta-agujas .....	237
SATINSKY clamps bulldog .....	79
SATINSKY pinzas para anastomosis .....	179
SATINSKY pinzas para oclusión tangencial .....	134
SATINSKY tijeras vasculares .....	39
SAUERBRUCH costótomo .....	278
SAUERBRUCH pinza-gubias .....	250
SAUERBRUCH separadores .....	214
Scapula separadores .....	214
SCHAEDEL pinzas para campos .....	171
SCHAEDE cucharillas cortantes .....	260
SCHEIBE pinzas para coger tejidos .....	183
SCHMID cánulas vasculares para irrigación .....	7
SCHNIDT pinzas para disección	
y ligaduras.....	175
SCHOENBORN separadores.....	195
SCHUMACHER tijeras de esternón .....	274
SELLORS aproximadores para costillas.....	223
SELMAN pinzas de disección .....	50
SEMB espátula pulmonares.....	224
SEMB periostótomos .....	266
SEMB pinza para huesos .....	259
SEMB pinza-gubias.....	252
SEMB pinzas cortantes para hueso.....	257
SEMB pinzas para disección y ligaduras .....	178
SEMKEN pinzas de disección .....	51
SENN separadores.....	191
Separador epicardiaco .....	215
Separador para vasos.....	315
Separadores .....	186-228
Separadores abdominales .....	222
Separadores atrium .....	225-226
Separadores autostáticos .....	215-222
Separadores costales .....	281-308
Separadores para aorta .....	227-228
Separadores para esternón.....	304-307
Separadores torácico .....	212-213
Seperadores mammaria .....	286, 308
Sierra de esternón.....	280
SIMON separadores.....	211
SINGLEY pinzas de disección .....	52
SLS clips titanio para ligadura .....	75
SMITH-PETERSEN pinza-gubias .....	252
Sondas .....	324
Sondas abotonadas .....	315
Sondas para várices .....	310-312
SPENCER tijeras para hilos .....	41
SPENCER-WELLS pinzas hemostáticas.....	95
STANDARD (YASARGIL) clips	
de aneurisma .....	76-77
STILLE costótomo.....	275
LISTON-KEY-HORSLEY pinzas cortantes	
para hueso .....	257
STILLE-LISTON pinzas cortantes	
para hueso .....	255-256
STILLE-LUER pinza-gubias .....	249-250
STRATE porta-agujas .....	236
STRUCK separadores costales .....	297
STRULLY tijeras vasculares .....	38
SUBRAMINIAN pinza clamp para aorta .....	147
SUBRAMINIAN-MINIATURE pinza clamp	
para aorta .....	147

## T

TEALE pinzas de corazón-válvula .....	184
Tenazas de corte lateral .....	271-273
THOMS-ALLIS pinzas para coger tejidos .....	181
THOREK tijeras torácica .....	40
Tijeras para preparación del nervio.....	38
Tijeras de esternón .....	274
Tijeras para venas .....	44
Tijeras .....	20-46
Tijeras compensar.....	37
Tijeras de disección.....	23-29
Tijeras de esternón.....	38
Tijeras de arteria coronaria .....	37
Tijeras de válvula venosa .....	39
Tijeras microquirúrgicas vasculares .....	42-46
Tijeras para cirugía .....	20-22, 30-32
Tijeras para hilos.....	41
Tijeras para lobotomía .....	41
Tijeras torácica .....	40-41
Tijeras vasculares .....	33-39
Tijeras, compensar.....	37
Tijeras, SuperCut.....	20-23, 25-26, 34
Tijeras, titanio .....	46
Soporte para endoscopio .....	326
TOENNIS disecadores.....	316
TOENNIS porta-agujas .....	237
TOENNIS-ADSON tijeras vasculares.....	38
TOHOKU pinzas para campos .....	172
TOLEDO micro porta-agujas .....	243
TOLEDO pinzas, micro .....	56
TOLEDO tijeras microquirúrgicas vasculares.....	43
Toracoscopia .....	325-330
Torniquetes.....	318
Trócares .....	8, 328
TUBBS dilatadores para válvula mitral .....	317
Tubos de aspiración .....	2-7, 329
TUFFIER separadores costales .....	300
Tunelización, juego.....	322

## U

ULRICH pinzas para tapones .....	173
ULTRA-LIGHT pinzas atraumáticas.....	62
US-Army (PARKER-LANGENBECK)	
separadores .....	187

## V

VANDERBILT pinzas hemostáticas .....	102
VANNAS tijeras microquirúrgicas.....	44
VARADY disecador, micro .....	313
VARADY flebodisecador .....	313
VARADY fleboextractor .....	313
VARADY Instrumentos para várices .....	313
VARADY sondas para várices .....	311
VOLKMANN cucharillas cortantes.....	260
VOLKMANN separadores .....	197-198
VOLLMAR fleboextractores .....	312
VOLLMAR mango para fleboextractor .....	312

## W

WALTON-YANKAUER tubo de aspiración.....	4
WANGENSTEEN pinzas de disección .....	52
WANGENSTEEN porta-agujas .....	236
WAUGH pinzas de disección .....	50
WEBER pinza clamp para aorta .....	125
WEBSTER porta-agujas .....	231
WECKER espátulas para iris .....	316
WEINBERG separadores costales.....	295
WEITLANER separadores autostáticos .....	216-219
WICKSTROEM pinzas hemostáticas.....	107
WILLAUER tijeras torácica .....	40
WILLIAMS pinzas para coger tejidos .....	184
WOLF tubo de aspiración .....	2, 329
WYLIE pinzas vasculares atraumáticas .....	135

## Y

YANKAUER tubo de aspiración.....	4
YANKAUER-BABY tubo de aspiración .....	4
YASARGIL clips de aneurisma .....	76-77
YASARGIL clips para el cierre permanente .....	76-77
YASARGIL tijeras microquirúrgicas.....	44

## Z

ZAUFEL-JANSEN pinza-gubias .....	248
ZENKER pinzas hemostáticas .....	104
ZENKER separadores.....	203

**Inhaltsverzeichnis**

Index  
Index  
Índice alfabético  
Indice alfabetico



**A**

ABRAMS ago per biopsia pleurica ..... 8  
 ACLAND approssimatori .....73  
 ACLAND clips vascolari .....72-73  
 ACLAND pinza per applicare  
 i clips vascolari..... 74  
 ADSON divaricatori autostatici ..... 219  
 ADSON pinze emostatiche .....98  
 ADSON pinze per dissezione .....49-50  
 ADSON-BABY pinze emostatiche ..... 98  
 ADSON-DE BAKEY pinze atraumatiche..... 61  
 ADSON-micro pinze per dissezione .....49  
 Aghi vascolari per irrigazione .....7  
 Ago per biopsia pleurica .....8  
 Ago per eparina .....7  
 ALEXANDER periostotomo .....263  
 ALLIS pinze per afferrare tessuti..... 181  
 ALLIS-BABY pinze per afferrare tessuti ..... 181  
 ALLISON spatole per polmone .....224  
 ALLPORT divaricatori autostatici..... 216  
 ALM divaricatori autostatici .....216  
 ANDREWS-PYNCHON tubo d'aspirazione .....5  
 ANKENY divaricatori sternali .....306-307  
 Applicatore per clips..... 137  
 Approssimatori .....67-70  
 Approssimatori costali .....223  
 Atrama Pinze Bulldog .....79-84  
 AUSTIN pinze per annodare fili .....55  
 Automatic pinze per ritorcere fili .....269

**B**

BABCOCK pinze per afferrare tessuti ..... 182  
 BABY-HAIGHT divaricatori costali .....288  
 Baby-MIXTER pinze emostatiche ..... 106  
 BABY-POOLE tubo d'aspirazione .....2  
 BACKHAUS pinze fissateli .....171  
 BADGLEY divaricatori costali .....299  
 BAILEY approssimatori costali .....223  
 BAILEY pinza taglienti per aorta.....17  
 BAILEY-BABY approssimatori costali .....223  
 BAILEY-GIBBON approssimatori costali .....223  
 BAINBRIDGE pinze atraumatiche  
 per multiuso..... 122  
 BALFOUR divaricatori addominali .....222  
 BALL AND SOCKET pinze fissateli.....172  
 BANGOLEA pinze emostatiche .....97  
 BARRAQUER micro port'aghi .....240  
 BARRAQUER-TROUTMAN micro port'aghi .....240  
 Batteria .....280  
 BAUMGARTNER pinze per ritorcere fili.....270  
 BAUMGARTNER port'aghi.....232  
 BECK pinze atraumatiche per multiuso ..... 141  
 BECKMANN divaricatori autostatici .....220  
 BECKMANN-ADSON divaricatori  
 autostatici .....220  
 BERLIN pinze serretubi .....109  
 BERRY pinze per ritorcere fili .....270  
 BETHUNE costotomo .....277  
 BEYER pinze sgorbie.....248  
 BIEMER approssimatori .....69  
 BIEMER clips vascolari .....65  
 BIEMER divaricatore per vasi .....315  
 BIEMER forbici per vene .....44  
 BIEMER pinza per applicare  
 i clips vascolari .....65, 67-68  
 BIEMER-MÜLLER approssimatori .....67  
 BLAKE pinza afferrare embolo .....180  
 BOEHLER cesoie per ossa .....253  
 BOEHLER pinze sgorbie .....248  
 BOROWSKI divaricatori per aorta .....228  
 BOZEMANN port'aghi .....236  
 BRAUN-RALPH tubo d'aspirazione.....5  
 BRAUN-STADLER forbici .....38  
 BRIDGE pinze emostatiche.....104  
 BROM uncino per vasi .....314  
 BROMPTON pinze con rotolip .....110  
 BRUNNER costotomo .....279  
 BRUNS curette taglienti .....260  
 BULLDOG clips vascolari .....71

**C**

Cannula per insufflazione.....328  
 Cannule per vene .....7  
 CAROTID pinze bulldog .....79  
 Cassetta per micro clips per aneurisma .....78

CASTAÑEDA divaricatori costali .....295  
 CASTAÑEDA pinze pediatriche .....166, 169  
 CASTROVIEJO micro port'aghi.....240-242  
 CASTROVIEJO-JACOBSON  
 micro port'aghi .....242  
 Cesoie per ossa .....252-257  
 Chirurgia ossea .....247-280  
 CHITWOOD-DE BAKEY pinze tira-ago .....62  
 CHITWOOD-DE BAKEY pinze atraumatiche .....62  
 CLEVELAND cesoie per ossa.....252  
 Clip titanio per legatura .....75  
 COLLIN costotomo .....275  
 CONE divaricatori autostatici .....221  
 COOLEY costotomo .....277  
 COOLEY dilatatori per valvole mitrali .....317  
 COOLEY dilatatori vascolari .....319  
 COOLEY divaricatori costali.....283-285  
 COOLEY divaricatori per atrio .....225-226  
 COOLEY pinza per iliaca .....158  
 COOLEY pinze atraumatiche .....60  
 COOLEY pinze atraumatiche per  
 multiuso .....157, 162, 164-165  
 COOLEY pinze bulldog .....84, 153-154  
 COOLEY pinze carotis .....164-165  
 COOLEY pinze  
 pediatriche.....156, 159, 162, 167-168  
 COOLEY pinze per anastomosi ..159-160, 162-163  
 COOLEY pinze per cateteri .....155  
 COOLEY pinze per coartazione .....157-158  
 COOLEY pinze per occlusione tangenziale ...161  
 COOLEY tubo d'aspirazione.....3  
 COOLEY-BECK pinze per anastomosi.....160  
 COOLEY-DERRA pinze per anastomosi.....162  
 COPE ago per biopsia pleurica .....8  
 CORYLLOS costotomo .....276  
 CORYLLOS divaricatori per torace.....213  
 Costotomi .....274-279  
 CRAFOORD forbici toraciche .....40  
 CRAFOORD pinze emostatiche .....103  
 CRAFOORD-SELLORS pinze emostatiche .....103  
 CRILE pinze emostatiche .....89  
 CRILE uncino per vasi.....314  
 CRILE-RANKIN pinze emostatiche .....90  
 CRILE-WOOD port'aghi .....232  
 CRILE-WOOD-BABY port'aghi.....233  
 Curette taglienti .....260  
 CUSHING divaricatore per vene .....195  
 CUSHING divaricatori .....195  
 CUSHING ilari ganci .....196  
 CUSHING pinze per dissezione .....50  
 CUSHING uncino per vasi .....314  
 CUSHING-KOCHER divaricatori.....201  
 CUSHING-TAYLOR pinze per dissezione .....50

**D**

D'AMICO tubo d'aspirazione .....2, 329  
 DALE pinze vascolari periferali .....140  
 DANDY pinze emostatiche .....96  
 DARDIK pinze atraumatiche per multiuso.....120  
 DARLING divaricatori autostatici .....221  
 DAVIDSON (Scapula) divaricatori .....214  
 DAVIS Elevatori .....316  
 DE BAKEY ago per eparina .....7  
 DE BAKEY dilatatori vascolari .....319-320  
 DE BAKEY divaricatori costali.....291, 301-302  
 DE BAKEY forbici vascolari .....33, 36, 37  
 DE BAKEY forbici compensare .....37  
 DE BAKEY pinza per iliaca .....124  
 DE BAKEY pinze atraumatiche .....57-64  
 DE BAKEY pinze atraumatiche  
 per multiuso.....130, 133  
 DE BAKEY pinze per anastomosi.....149  
 DE BAKEY pinze per aneurisma  
 di aorta .....126, 128, 132, 141  
 DE BAKEY pinze per coartazione .....144-146  
 DE BAKEY pinze per legature .....149  
 DE BAKEY pinze vascolari periferali .....119, 121  
 DE BAKEY port'aghi.....233-234  
 DE BAKEY tubo d'aspirazione .....5  
 DE BAKEY-ADSON pinze atraumatiche .....61  
 DE BAKEY-BAHNSON pinze  
 per aneurisma di aorta .....127  
 DE BAKEY-BECK pinze atraumatiche  
 per multiuso.....141  
 DE BAKEY-DIETHRICH pinze atraumatiche .....60

DE BAKEY-GERALD pinze atraumatiche .....61  
 DE BAKEY-MC QUIGG MIXTER passafili .....151  
 DE BAKEY-MIXTER passafili .....152  
 DE BAKEY-MORRIS pinze  
 per aneurisma di aorta .....129  
 DE BAKEY-REYNOLDS pinze  
 per anastomosi .....147  
 DE BAKEY-RUMMEL passafili .....151  
 DE BAKEY-SATINSKY pinze per occlusione  
 tangenziale .....138  
 DE BAKEY-SEMB passafili .....142  
 DE BAKEY-SEMB pinze  
 per aneurisma di aorta .....131  
 DEEVER divaricatori ...192-193  
 DEBAKEY pinze bulldog .....82, 113  
 DEBAKEY-DIETHRICH pinze bulldog.....81  
 DERF port'aghi .....231  
 DERRA pinze per coartazione .....144  
 DESMARRS ilari ganci .....196  
 DIEFFENBACH pinze bulldog.....85  
 DIETHRICH forbici vascolari .....35  
 DIETHRICH pinze bulldog .....81  
 DIETRICH micro port'aghi .....244  
 DIETRICH pinza per aorta .....148  
 Dilatatori vascolari, pinza .....54  
 Dilatatori per valvole mitrali .....317  
 Dilatatori vascolari .....315, 319-321  
 Dissetore, micro .....313  
 Dissettori .....316  
 Dissettori vascolari .....323  
 Distributore lame .....15  
 Divaricatore epicardiaco .....215  
 Divaricatore per vasi .....315  
 Divaricatore per vene.....195  
 Divaricatori .....186-228  
 Divaricatore a ventaglio .....330  
 Divaricatori addominali .....222  
 Divaricatori autostatici .....215-222  
 Divaricatori costali .....281-308  
 Divaricatori per aorta .....227-228  
 Divaricatori per cavità .....225-226  
 Divaricatori per mammaria .....286, 308  
 Divaricatori per torace .....212-213  
 Divaricatori sternali .....304-307  
 Divaricatori toraciche .....303  
 DOYEN periostotomi costali.....265  
 DUBOST divaricatori costali.....296  
 DURANTE pinze per dissezione .....52  
 DUVAL pinze per afferrare tessuti .....183

**E**

ECHLN pinze sgorbie .....252  
 EDWARDS applicatore per clips.....137  
 EDWARDS clips.....137  
 Elevatori .....314-316  
 Elevatori per setto .....314  
 Endoscopia .....327  
 ETHICON® clip titanio per legatura .....75

**F**

FARABEUF divaricatori .....186  
 FARABEUF periostotomo .....262  
 FAVALORO forbici coronarica .....37  
 FAVALORO divaricatori sternali .....305  
 FERGUSSON cannule per aspirazione  
 e irrigazione .....6  
 FERGUSSON tenaglie per ossa.....258  
 FICHSIG pinze emostatiche .....97  
 Filo per ossa .....268  
 FINOCHIETTO (modif.) divaricatori costali .....282  
 FINOCHIETTO BABY-HAIGHT  
 divaricatori costali .....288  
 FINOCHIETTO divaricatori  
 costali .....282, 287-289  
 FINOCHIETTO forbici per lobo polmonare .....41  
 FINOCHIETTO Pinze per bronchi .....176  
 FINOCHIETTO port'aghi .....237  
 FINOCHIETTO-BABY divaricatori costali.....283  
 FINOCHIETTO-BURFORD  
 divaricatori costali.....290, 292-294  
 FINOCHIETTO-INFANT divaricatori costali .....289  
 FINSEN divaricatori autostatici .....215  
 FINSTERER cannule per aspirazione  
 e irrigazione .....5

FISCH uncino per vasi.....	315
Flebodissettore .....	313
Fleboestrattore.....	313
FOERSTER pinze per medicatura .....	174
FOGARTY pinze vascolari atraumatiche.....	136
Forbici .....	20-46
Forbici compensare .....	37
Forbici coronarica .....	37
Forbici micro-chirurgici vascolari.....	42-46
Forbici per chirurgia.....	20-22, 30-32
Forbici per dissezione .....	23-29
Forbici per legature .....	41
Forbici per lobo polmonare .....	41
Forbici per preparazione di nervi.....	38
Forbici per sterno .....	38
Forbici per sterno .....	274
Forbici per vene .....	44
Forbici toraciche .....	40-41
Forbici valvole venose.....	39
Forbici vascolari .....	33-39
Forbici, SuperCut .....	20-23, 25-26, 34
Forbici, titanio.....	46
FRAZIER tubo d'aspirazione.....	6
FREEER Elevatori .....	316
FRITSCH divaricatori .....	188
FRYKHOLM pinze sgorbie .....	251
<b>G</b>	
GARRETT dilatatori vascolari .....	320
GARRETT iniettore per eparina.....	7
GEMINI passafili .....	99
GEMINI-mini passafili .....	99
GERALD pinze per dissezione .....	51
GERALD-DEBAKEY pinze atraumatiche.....	61
GIERTZ-STILLE costotomo .....	278
GIL VERNET ilari ganci .....	195
GILLIES pinze per dissezione .....	51
GILLIES port'aghi .....	238
GILLIES uncino per vasi .....	314
GLASSMAN pinze atraumatiche .....	61
GLOVER pinze bulldog .....	79, 83
GLOVER pinze per anastomosi.....	117-118
GLOVER pinze per coartazione .....	146
GLOVER-DE BAKEY pinze vascolari atraumatiche .....	135
GLOVER-mini pinze bulldog .....	79
GLUCK costotomo.....	275
GOMEL pinze per annodare fili .....	55
GOSLEE tenaglie piatte .....	269
GREGORY pinze per profonda .....	152
GREGORY-"Soft" pinze bulldog.....	80
GROSS-MAIER pinze per medicatura.....	173
GUNNER-HEY pinze con rotoli .....	110
<b>H</b>	
HABERER spatole addominali .....	191
HAIGHT divaricatori costali .....	298
HALLE elevatori per setto .....	314
HALSEY port'aghi .....	232
HALSTED-MOSQUITO pinze emostatiche .....	88
HALSTED-MOSQUITO pinze vascolari atraumatiche .....	111
HALSTED-MOSQUITO-micro pinze emostatiche .....	87
HARKEN pinze ventricolari.....	139, 180
HARRINGTON divaricatori .....	194
HARRINGTON Pinze per bronchi.....	176
HARRINGTON-BABY divaricatori .....	194
HARTMANN pinze emostatiche .....	87
HARTMANN-micro pinze emostatiche.....	87
HARVEY tenaglie tagliafili .....	271
HARVEY tenaglie tagliafili .....	273
HEANEY port'aghi.....	236
HEGAR dilatatori.....	321
HEGAR-Vascular port'aghi .....	235
HEISS pinze emostatiche .....	97
HENLEY divaricatori autostatici .....	217
HERTZLER divaricatori costali .....	308
HESS (DEBAKEY) pinze bulldog .....	85
HIBBS divaricatori .....	212
HOHENFELLNER forbici vascolari.....	37
HOPT pinze vascolari atraumatiche .....	112
<b>I</b>	
Ilari ganci .....	195-196
IMA Divaricatori.....	286, 308
IMA Divaricatore epicardiaco .....	215
Iniettore per eparina .....	7
In-situ forbici valvole venose.....	39
IRIS forbici .....	32
ISRAEL divaricatori.....	205
<b>J</b>	
JACOBSON micro port'aghi.....	242, 245
JACOBSON pinze emostatiche .....	98
JACOBSON sonde bottonute .....	315
JACOBSON-MOSQUITO pinze emostatiche.....	98
JANSEN pinze per dissezione .....	50
JAVID pinze carotis .....	149
JOHNS HOPKINS pinze bulldog.....	85
JONES pinze fissateli .....	171
JONES-Clip pinze fissateli .....	171
JORGENSEN forbici toraciche .....	41
JOSEPH forbici .....	30
JUDD-ALLIS pinze per afferrare tessuti .....	181
<b>K</b>	
KADER divaricatori .....	190
KANTROWITZ pinze emostatiche .....	105
KELLY divaricatori .....	189, 209
KELLY passafili.....	105
KELLY pinze emostatiche .....	89
KELLY-RANKIN pinze emostatiche .....	89
KILNER forbici .....	31
KILNER uncino per vasi .....	314
KLINKENBERGH LOTH forbici toraciche .....	41
KOCHER divaricatori .....	200-201, 204, 206
KOCHER pinze emostatiche .....	92-93
KOCHER-LANGENBECK divaricatori .....	202
KOCHER-NIPPON pinze emostatiche.....	94
KOCHER-WAGNER divaricatori .....	208
KOENIG divaricatori .....	201
KOERTE divaricatori.....	210
KRAYENBÜHL uncino per vasi .....	315
<b>L</b>	
LAHEY pinze emostatiche .....	108
LAMBER-KAY pinze aortiche .....	123
LAMBOTTE periostotomo .....	262
Lame da bisturi, steril .....	14, 16
Lame da bisturi, steril, micro .....	16
LANE pinze per afferrare tessuti .....	172
LANGENBECK divaricatori.....	199, 201
LANGENBECK periostotomo .....	262
LANGENBECK tenaglie per ossa.....	258
LAWRENCE pinze emostatiche .....	104
LAZAR pinze per annodare fili .....	55
LEBSCHÉ costotomo .....	278
LEBSCHÉ scapello per sterno .....	261
LEES Pinze per bronchi .....	114
LEKSELL pinze sgorbie .....	251
LEKSELL-STILLE pinze sgorbie.....	251
LELAND-JONES pinze atraumatiche per multiuso.....	122
LELAND-JONES pinze vascolari periferali.....	121
LEMMON approssimatori costali .....	223
LERICHE divaricatori .....	210
LERICHE pinze emostatiche .....	96
LEXER forbici per dissezione .....	25
LEXER-FINO forbici per dissezione.....	24
LIDDLE pinza per aorta .....	123
LISTER passafili.....	175
LISTON cesoie per ossa .....	253
LITTAUER forbici per legature .....	41
LITTLEWOOD pinze per afferrare tessuti.....	184
LOCKHART-MUMMERY sonda .....	324
LORNA pinze fissateli .....	172
LOVE-GRUENWALD pinza taglienti per aorta ..	17
LOVELACE pinze emostatiche .....	96
LOVELACE pinze per afferrare il polmone .....	175
LUCAE pinze per dissezione .....	50
<b>M</b>	
Manici per bisturi .....	10-13, 16
Manici per bisturi, micro .....	16
Manico per disobliteratori per endarterectomia .....	312
MARQUARDT pinze sgorbie .....	248
Martelli .....	261
MARTIN divaricatori .....	211
MARTIN pinze per medicatura .....	174
MARTIN spatole addominali .....	191
MARTIN-WYLIE pinze vascolari periferali .....	150
MATHIEU port'aghi.....	237
MATSON periostotomo .....	263
MATSON-ALEXANDER periostotomo.....	263
MAYO forbici per dissezione .....	23
MAYO-HEGAR port'aghi .....	233
MAYO-STILLE forbici per dissezione .....	24
MCINDOE cesoie per ossa.....	254
McINDOE forbici vascolari.....	38
McINDOE pinze per dissezione .....	52
McQUIGG-MIXTER pinze emostatiche .....	107
MEEKER pinze emostatiche.....	104
MEHDORN clips vascolari .....	66
MEHDORN pinza per applicare i clips vascolari.....	66
MERCEDES divaricatori toraciche .....	303
METZENBAUM FINO forbici per dissezione..	27-30
METZENBAUM forbici per dissezione.....	26
METZENBAUM-NELSON forbici per dissezione	30
Micro port'aghi .....	239-246
Micro-Pinze .....	54-64
Microvascular port'aghi .....	235
MIDDELORPF divaricatori .....	187
MIKULICZ divaricatori .....	207
MIKULICZ pinze per peritoneo .....	108
MIKULICZ-Baby pinze per peritoneo .....	108
MILLESI forbici micro-chirurgici .....	44
MILLS forbici vascolari.....	36
MINI (YASARGIL) clips per aneurisma .....	76-77
MIXTER pinze emostatiche .....	106-107
MIXTER-BABY pinze emostatiche.....	106
MIXTER-O'SHAUGNESSY pinze emostatiche .	107
MOCK-DEBAKEY ago per eparina .....	7
MORSE divaricatori sternali .....	304-305
MORSE-FAVALORO divaricatori sternali.....	305
MÜLLER approssimatori .....	68
MÜLLER clips vascolari .....	71
MURPHY divaricatori .....	198
<b>N</b>	
NABATOFF sonda per varici.....	310
NEIVERT port'aghi .....	232
NELSON pinza per dissezione .....	52
NELSON trequarto .....	8
<b>O</b>	
OCHSNER pinza per aorta .....	148
OLSEN HEGAR port'aghi .....	238
OVERHOLT periostotomo .....	264
OVERHOLT pinze emostatiche .....	101-102
OVERHOLT-BABY pinze emostatiche .....	101
OVERHOLT-fino pinze emostatiche .....	101
OVERHOLT-GEISSENDOERFER pinze emostatiche .....	100
OVERHOLT-MIXTER pinze emostatiche.....	107
<b>P</b>	
PARKER-LANGENBECK divaricatori .....	187
Passafili.....	99, 105, 142, 151-152, 175
PEAN pinze emostatiche .....	91, 93
PEAN pinze vascolari atraumatiche .....	111
PEAN-NIPPON pinze emostatiche .....	94
PEERS-BERTRAM pinze fissateli .....	171
PENNINGTON pinze emostatiche.....	96
Periostotomi .....	262-267
Periostotomi .....	262-267
Periostotomi costali .....	265
PERWITZCHKY forbici .....	32
Pinza afferrare embolo .....	180
Pinza anello .....	57, 63-64
Pinza per aorta .....	123, 125, 147-148
Pinza per applicare clip .....	75
Pinza per applicare e rimuovere clamps.....	85
Pinza per applicare i clips per aneurisma.....	76-77
Pinza per applicare i clips vascolari .....	65-70, 74
Pinza per iliaca.....	124, 158
Pinza per legature .....	87
Pinze aortiche .....	123
Pinze atraumatiche.....	57-64
Pinze atraumatiche per multiuso .....	120, 122, 141, 157, 162, 164-165

Pinze bulldog .....	79-86, 113, 153-154
Pinze bulldog, micro .....	79, 86
Pinze bulldog, titanio .....	86
Pinze carotis.....	149, 164-165
Pinze con peso.....	63
Pinze con rotoli .....	110
Pinze da orologio .....	53
Pinze emostatiche .....	87-108
Pinze emostatiche, titanio .....	88-89
Pinze fissateli.....	171-172
Pinze pediatriche.....	156, 159, 162, 166-169
Pinze per afferrare il cuore-valvola .....	184
Pinze per afferrare il polmone.....	175
Pinze per afferrare organi .....	140
Pinze per afferrare tessuti .....	172 - 184
Pinze per anastomosi .....	117-118, 147, 159-160, 162-163
Pinze per aneurisma di aort .....	126-129, 131
Pinze per annodare fili .....	54-56, 63-64
Pinze per bronchi .....	114, 176-178
Pinze per cateteri.....	155
Pinze per coartazione .....	115-116, 143-146, 157-158
Pinze per dissezione .....	48-64
Pinze per la vena cava .....	138, 141, 155, 179
Pinze per legature .....	149
Pinze per medicatura .....	173-174
Pinze per occlusione tangenziale ....	134, 138, 161
Pinze per peritoneo .....	108
Pinze per profunda .....	152
Pinze per ritorcere fili .....	269-270
Pinze serretubi.....	109
Pinze sgorbie .....	248-252
pinze sgorbie.....	248
Pinze taglienti per aorta .....	17
Pinze tira-ago .....	62
Pinze vascolari atraumatiche .....	111-170
Pinze vascolari atraumatiche .....	136
Pinze vascolari flessibili .....	170
Pinze vascolari periferali .....	119, 121, 140, 150
Pinze ventricolari .....	139
Pinze, micro .....	54-64
Pinze, morso diamantato .....	57, 63-64
Pinze, titanio .....	58, 64
Pneumatica manipolo.....	273
POOLE tubo d'aspirazione .....	2
POPPEL tubo d'aspirazione .....	6
Port'aghi .....	229-246
Port'aghi, micro .....	239-246
Port'aghi, morso diamantato .....	242-244, 246
Port'aghi, titanio.....	246
POTTS pinze per coartazione.....	115-116, 143
POTTS-DE MARTEL forbici vascolari .....	36
POTTS-SMITH forbici vascolari .....	33-34, 36
POTTS-SMITH pinze per dissezione .....	48
POTTS-YASARGIL forbici micro-chirurgici .....	44
PRESBYTERIAN HOSPITAL pinze serretubi.....	109
PRICE-THOMAS Pinze per bronchi.....	177
PROVIDENCE-HOSPITAL pinze emostatiche .....	90

## R

RAGNELL-DAVIS divaricatori .....	191
RAMPLEY pinze per medicatura .....	174
RANKIN pinze vascolari atraumatiche .....	112
Recipienti metallici .....	320
REILL tenaglie tagliafili.....	272
REYNOLDS forbici .....	31
Ricarica .....	280
RICHARDSON divaricatori .....	187, 189
ROBB dissestori vascolari .....	323
ROBERTS pinze emostatiche .....	103
ROCHESTER-CARMALT pinze emostatiche .....	95
ROCHESTER-OCHSNER pinze emostatiche.....	92
ROCHESTER-PEAN pinze emostatiche .....	91
ROSS divaricatori per aorta .....	227
ROUX divaricatori .....	186
ROUX-mini divaricatori .....	186
RUMEL-BELMONT tornichetti .....	318
RUMMEL pinze emostatiche .....	102
RUSKIN pinze sgorbie .....	248
RUSKIN-LISTON cesoie per ossa .....	254
Russ. Mod. pinze per dissezione .....	52
RYDER port'aghi .....	234
RYDER-Vascular port'aghi .....	235

## S

SANTULLI pinze bulldog .....	80
SANVENERO forbici .....	30
SAROT pinze emostatiche .....	103
SAROT Pinze per bronchi .....	178
SAROT port'aghi .....	237
SATINSKY forbici vascolari .....	39
SATINSKY pinze bulldog .....	79
SATINSKY pinze per anastomosi .....	179
SATINSKY pinze per occlusione tangenziale.....	134
SAUERBRUCH costotomo .....	278
SAUERBRUCH divaricatori .....	214
SAUERBRUCH pinze sgorbie .....	250
Scalpello per sterno .....	261
Scapula divaricatori.....	214
SCHAEDEL pinze fissateli .....	171
SCHEDE curette taglienti .....	260
SCHEIBE pinze per afferrare tessuti .....	183
SCHMID aghi vascolari per irrigazione.....	7
SCHNIDT passafili .....	175
SCHOENBORN divaricatori .....	195
SCHUMACHER forbici per sterno .....	274
SELLORS approssimatori costali .....	223
SELMAN pinze per dissezione .....	50
SEMB cesoie per ossa .....	257
SEMB passafili .....	178
SEMB periototomo.....	266
SEMB pinze sgorbie .....	252
SEMB spatole per polmone .....	224
SEMB tenaglie per ossa .....	259
SEMKEN pinze per dissezione .....	51
SENN divaricatori .....	191
Shunt .....	170
SIMON divaricatori .....	211
SINGLEY pinze per dissezione .....	52
SLS clip titanio per legatura .....	75
SMITH-PETERSEN pinze sgorbie .....	252
Sonde .....	324
Sonde bottonute .....	315
Sonde per varici .....	310-312
Spatola per intima .....	323
Spatola per iride .....	316
Spatole addominali .....	190-193
Spatole per polmone.....	224
SPENCER forbici per legature .....	41
SPENCER-WELLS pinze emostatiche.....	95
STANDARD (YASARGIL) clips per aneurisma .....	76-77
Sterilizzazione-imbuto per batteria.....	280
STILLE costotomo.....	275
LISTON-KEY-HORSLEY cesoie per ossa.....	257
STILLE-LISTON cesoie per ossa.....	255-256
STILLE-LUER pinze sgorbie .....	249-250
STRATE port'aghi.....	236
Stripper anello .....	312
STRUCK divaricatori costali .....	297
STRULLY forbici vascolari .....	38
Strumenti per varici.....	313
SUBRAMINIAN pinza per aorta.....	147
SUBRAMINIAN-MINIATURE pinza per aorta .....	147
Supporto per endoscopio .....	326

## T

TEALE pinze per afferrare il cuore-valvola ....	184
Tenaglie per ossa .....	258-259
Tenaglie piatte .....	268-269
Tenaglie tagliafili .....	271-273
Tenaglie tagliafili frontali .....	273
Tenaglie tagliafili laterali.....	271-273
THOMS-ALLIS pinze per afferrare tessuti.....	181
THOREK forbici toraciche .....	40
TOENNIS dissestori .....	316
TOENNIS port'aghi .....	237
TOENNIS-ADSON forbici vascolari .....	38

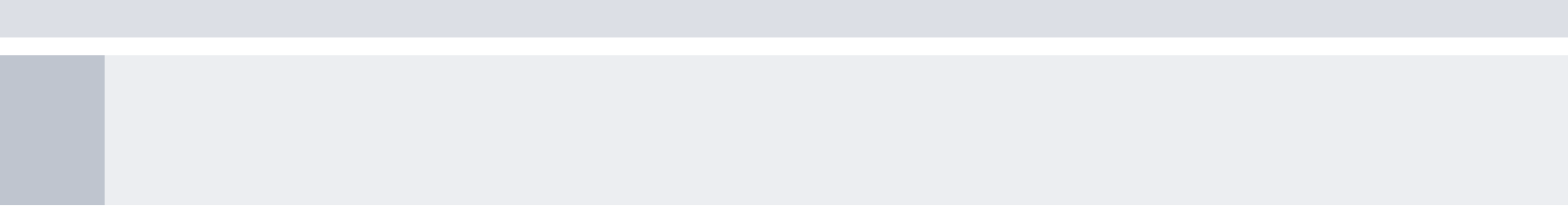



# 12



◆ **NUMMERNVERZEICHNIS**

NUMERICAL INDEX

INDEX NUMÉRIQUE

ÍNDICE NUMÉRICO

INDICE NUMERICO

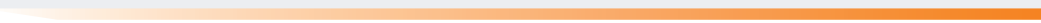

## Nummernverzeichnis

Numerical index  
Index numérique  
Índice numérico  
Indice numerico

## 04

04.130.10.....	2
04.140.06.....	2
04.140.08.....	2
04.141.35.....	3
04.143.31.....	3
04.145.30.....	3
04.147.33.....	3
04.147.90.....	3
04.149.27.....	4
04.150.22.....	4
04.150.27.....	4
04.150.98.....	4
04.150.99.....	4
04.152.33.....	4
04.153.24.....	5
04.154.16.....	5
04.154.26.....	5
04.154.27.....	5
04.158.00.....	5
04.181.31.....	5
04.182.01.....	2, 329
04.182.02.....	2, 329
04.184.00.....	2, 329
04.184.01.....	2, 329
04.184.02.....	2, 329
04.184.03.....	2, 329

## 06

06.103.00.....	10
06.103.01.....	10
06.103.02.....	10
06.103.03.....	10
06.103.06.....	10
06.103.33.....	10
06.104.00.....	13
06.104.01.....	13
06.104.02.....	13
06.104.06.....	13
06.105.00.....	11
06.106.00.....	11
06.106.01.....	11
06.107.00.....	12
06.107.01.....	12
06.107.02.....	12
06.109.00.....	12
06.110.00.....	14
06.111.00.....	14
06.112.00.....	14
06.115.00.....	14
06.120.00.....	15
06.121.00.....	15
06.122.00.....	15
06.123.00.....	15
06.124.00.....	15
06.199.00.....	15
06.302.13.....	16
06.304.15.....	16

## 07

07.102.10.....	20
07.102.11.....	20
07.102.13.....	20
07.102.14.....	20
07.102.15.....	20
07.102.16.....	20
07.102.18.....	20
07.102.20.....	20
07.103.10.....	20
07.103.11.....	20
07.103.13.....	20
07.103.14.....	20
07.103.15.....	20
07.103.16.....	20
07.103.18.....	20
07.103.20.....	20
07.104.14.....	20
07.104.16.....	20
07.105.14.....	20
07.105.16.....	20
07.110.11.....	21
07.110.13.....	21
07.110.14.....	21
07.110.15.....	21
07.110.16.....	21

07.110.18.....	21
07.110.20.....	21
07.111.11.....	21
07.111.13.....	21
07.111.14.....	21
07.111.15.....	21
07.111.16.....	21
07.111.18.....	21
07.111.20.....	21
07.114.14.....	21
07.114.16.....	21
07.115.14.....	21
07.115.16.....	21
07.120.10.....	22
07.120.11.....	22
07.120.13.....	22
07.120.14.....	22
07.120.15.....	22
07.120.16.....	22
07.120.18.....	22
07.120.20.....	22
07.121.10.....	22
07.121.11.....	22
07.121.13.....	22
07.121.14.....	22
07.121.15.....	22
07.121.16.....	22
07.121.18.....	22
07.121.20.....	22
07.124.14.....	22
07.124.16.....	22
07.125.14.....	22
07.125.16.....	22
07.160.14.....	23
07.160.17.....	23
07.160.23.....	23
07.161.14.....	23
07.161.17.....	23
07.161.23.....	23
07.164.14.....	23
07.164.17.....	23
07.164.23.....	23
07.165.14.....	23
07.165.17.....	23
07.165.23.....	23
07.190.16.....	25
07.190.21.....	25
07.191.16.....	25
07.191.21.....	25
07.194.16.....	25
07.194.21.....	25
07.195.16.....	25
07.195.21.....	25
07.280.11.....	26
07.280.15.....	26
07.280.18.....	26
07.280.20.....	26
07.280.23.....	26
07.280.25.....	26
07.280.28.....	26
07.280.30.....	26
07.281.11.....	26
07.281.15.....	26
07.281.18.....	26
07.281.20.....	26
07.281.23.....	26
07.281.25.....	26
07.281.28.....	26
07.281.30.....	26
07.284.11.....	26
07.284.15.....	26
07.284.18.....	26
07.284.20.....	26
07.284.23.....	26
07.284.25.....	26
07.284.28.....	26
07.284.30.....	26
07.285.11.....	26
07.285.15.....	26
07.285.18.....	26
07.285.20.....	26
07.285.23.....	26
07.285.25.....	26
07.285.28.....	26
07.285.30.....	26

07.480.25.....	34
07.480.40.....	34
07.480.60.....	34
07.484.25.....	34
07.484.40.....	34
07.484.60.....	34

## 08

08.102.10.....	20
08.102.11.....	20
08.102.13.....	20
08.102.14.....	20
08.102.15.....	20
08.102.16.....	20
08.102.18.....	20
08.102.20.....	20
08.103.10.....	20
08.103.11.....	20
08.103.13.....	20
08.103.14.....	20
08.103.15.....	20
08.103.16.....	20
08.103.18.....	20
08.103.20.....	20
08.104.14.....	20
08.104.16.....	20
08.104.18.....	20
08.105.14.....	20
08.105.16.....	20
08.105.18.....	20
08.110.10.....	21
08.110.11.....	21
08.110.13.....	21
08.110.14.....	21
08.110.15.....	21
08.110.16.....	21
08.110.18.....	21
08.110.20.....	21
08.111.10.....	21
08.111.11.....	21
08.111.13.....	21
08.111.14.....	21
08.111.15.....	21
08.111.16.....	21
08.111.18.....	21
08.111.20.....	21
08.114.14.....	21
08.114.16.....	21
08.114.18.....	21
08.115.14.....	21
08.115.16.....	21
08.115.18.....	21
08.120.10.....	22
08.120.11.....	22
08.120.13.....	22
08.120.14.....	22
08.120.15.....	22
08.120.16.....	22
08.120.18.....	22
08.120.20.....	22
08.121.10.....	22
08.121.11.....	22
08.121.13.....	22
08.121.14.....	22
08.121.15.....	22
08.121.16.....	22
08.121.18.....	22
08.121.20.....	22
08.124.14.....	22
08.124.16.....	22
08.124.18.....	22
08.125.14.....	22
08.125.16.....	22
08.125.18.....	22
08.160.14.....	23
08.160.17.....	23
08.160.19.....	23
08.160.23.....	23
08.160.28.....	23
08.161.14.....	23
08.161.17.....	23
08.161.19.....	23
08.161.23.....	23
08.161.28.....	23
08.164.14.....	23

08.164.17.....	23
08.164.23.....	23
08.165.14.....	23
08.165.17.....	23
08.165.23.....	23
08.170.15.....	24
08.170.17.....	24
08.171.15.....	24
08.171.17.....	24
08.174.15.....	24
08.174.17.....	24
08.175.15.....	24
08.175.17.....	24
08.190.16.....	25
08.190.21.....	25
08.191.16.....	25
08.191.21.....	25
08.194.16.....	25
08.194.21.....	25
08.195.16.....	25
08.195.21.....	25
08.196.16.....	24
08.197.16.....	24
08.280.15.....	26
08.280.18.....	26
08.280.20.....	26
08.280.23.....	26
08.280.25.....	26
08.280.28.....	26
08.280.30.....	26
08.281.15.....	26
08.281.18.....	26
08.281.20.....	26
08.281.23.....	26
08.281.25.....	26
08.281.28.....	26
08.281.30.....	26
08.282.15.....	27
08.282.18.....	27
08.282.20.....	27
08.282.23.....	27
08.282.25.....	27
08.282.28.....	27
08.283.15.....	27
08.283.18.....	27
08.283.20.....	27
08.283.23.....	27
08.283.25.....	27
08.283.28.....	27
08.284.15.....	26
08.284.18.....	26
08.284.20.....	26
08.284.23.....	26
08.284.25.....	26
08.284.28.....	26
08.284.30.....	26
08.285.15.....	26
08.285.18.....	26
08.285.20.....	26
08.285.23.....	27
08.285.25.....	26
08.285.28.....	26
08.286.15.....	27
08.286.18.....	27
08.286.20.....	27
08.286.23.....	27
08.286.25.....	27
08.286.28.....	27
08.287.15.....	27
08.287.18.....	27
08.287.20.....	27
08.287.23.....	27

08.287.25.....	27
08.287.28.....	27
08.288.18.....	30
08.288.20.....	30
08.291.18.....	30
08.292.14.....	28
08.292.18.....	28
08.292.20.....	28
08.292.23.....	28
08.293.14.....	28
08.293.18.....	28
08.293.20.....	28
08.293.23.....	28
08.295.18.....	30
08.296.14.....	29
08.296.18.....	29
08.296.20.....	29
08.296.23.....	29
08.297.14.....	29
08.297.18.....	29
08.297.20.....	29
08.297.23.....	29
08.302.14.....	30
08.303.14.....	30
08.304.14.....	30
08.305.14.....	30
08.310.12.....	31
08.310.15.....	31
08.314.12.....	31
08.314.15.....	31
08.317.25.....	33
08.317.45.....	33
08.317.60.....	33
08.319.25.....	33
08.319.45.....	33
08.319.60.....	33
08.320.15.....	31
08.321.15.....	31
08.321.18.....	31
08.324.15.....	31
08.325.15.....	31
08.340.09.....	32
08.340.10.....	32
08.340.11.....	32
08.340.12.....	32
08.341.09.....	32
08.341.10.....	32
08.341.11.....	32
08.341.12.....	32
08.344.11.....	32
08.345.11.....	32
08.351.11.....	32
08.353.11.....	32
08.354.11.....	32
08.467.19.....	33
08.470.11.....	32
08.471.10.....	32
08.472.22.....	33
08.473.21.....	36
08.473.24.....	36
08.475.22.....	36
08.477.18.....	37
08.477.21.....	37
08.477.24.....	37
08.478.19.....	37
08.479.19.....	37
08.480.18.....	36
08.480.25.....	34
08.480.40.....	34
08.480.60.....	34
08.480.61.....	34
08.484.25.....	34
08.484.40.....	34
08.484.60.....	34
08.485.25.....	35
08.485.45.....	35
08.485.60.....	35
08.485.90.....	35
08.485.92.....	35
08.486.25.....	35
08.486.26.....	35
08.486.27.....	35
08.486.45.....	35
08.486.46.....	35
08.486.47.....	35



**Nummernverzeichnis**

Numerical index  
 Index numérique  
 Índice numérico  
 Indice numerico

11.314.24.....	60	11.588.15.....	64	12.052.12.....	72	12.079.10.....	81	12.210.09.....	87
11.315.15.....	60	11.588.18.....	64	12.052.12B.....	72	12.079.14.....	81	12.211.09.....	87
11.315.19.....	60	11.588.21.....	64	12.052.13.....	72	12.079.20.....	81	12.211.10.....	87
11.315.24.....	60	11.590.15.....	64	12.052.13B.....	72	12.082.08.....	81	12.212.09.....	87
11.316.16.....	60	11.590.18.....	64	12.052.14.....	72	12.082.12.....	81	12.212.10.....	87
11.316.20.....	60	11.590.21.....	64	12.052.14B.....	72	12.082.16.....	81	12.213.09.....	87
11.316.24.....	60	11.650.15.....	63	12.052.15.....	72	12.083.08.....	81	12.213.10.....	87
11.318.12.....	61	11.650.18.....	63	12.052.15B.....	72	12.083.12.....	81	12.220.12.....	88
11.318.15.....	61	11.650.21.....	63	12.052.21.....	72	12.083.16.....	81	12.220.14.....	88
11.322.16.....	59	11.650.23.....	63	12.052.21B.....	72	12.084.08.....	84	12.220.18.....	88
11.322.20.....	59	11.650.25.....	63	12.052.22.....	72	12.084.09.....	84	12.220.21.....	88
11.322.24.....	59	11.651.15.....	63	12.052.22B.....	72	12.084.10.....	84	12.221.12.....	88
11.322.30.....	59	11.651.18.....	63	12.052.23.....	72	12.084.12.....	84	12.221.14.....	88
11.324.15.....	59	11.651.21.....	63	12.052.23B.....	72	12.084.12.....	84	12.221.18.....	88
11.324.20.....	59	11.651.23.....	63	12.052.31.....	72	12.085.08.....	84	12.221.21.....	88
11.324.24.....	59	11.651.25.....	63	12.052.31B.....	72	12.085.10.....	84	12.222.10.....	87
11.324.30.....	59	11.652.18.....	63	12.052.32.....	72	12.085.12.....	84	12.222.12.....	87
11.332.15.....	59	11.653.18.....	63	12.052.32B.....	72	12.086.09.....	80	12.223.10.....	87
11.332.20.....	59	11.654.15.....	63	12.052.33.....	72	12.086.11.....	80	12.223.12.....	87
11.332.24.....	59	11.654.18.....	63	12.052.33B.....	72	12.087.09.....	80	12.224.12.....	88
11.332.30.....	59	11.654.21.....	63	12.052.41.....	73	12.087.10.....	80	12.225.12.....	88
11.333.15.....	60	11.654.25.....	63	12.052.41B.....	73	12.087.11.....	80	12.230.12.....	88
11.333.20.....	60	11.655.15.....	63	12.052.42.....	73	12.088.01.....	80	12.230.14.....	88
11.333.24.....	60	11.655.18.....	63	12.052.42B.....	73	12.088.02.....	80	12.230.18.....	88
11.333.30.....	60	11.655.21.....	63	12.052.43.....	73	12.089.07.....	80	12.230.21.....	88
11.334.15.....	59	11.655.25.....	63	12.052.43B.....	73	12.092.07.....	82	12.231.12.....	88
11.334.20.....	59	11.656.15.....	63	12.052.44.....	73	12.092.08.....	82	12.231.14.....	88
11.334.24.....	59	11.656.18.....	63	12.052.44B.....	73	12.092.10.....	82	12.231.18.....	88
11.334.30.....	59	11.656.21.....	63	12.052.45.....	73	12.092.12.....	82	12.231.21.....	88
11.334.35.....	59	11.657.15.....	63	12.052.45B.....	73	12.093.07.....	82	12.232.10.....	87
11.402.15.....	62	11.657.18.....	63	12.052.51.....	73	12.093.08.....	82	12.232.12.....	87
11.402.20.....	62	11.657.21.....	63	12.052.51B.....	73	12.093.10.....	82	12.233.10.....	87
11.402.24.....	62			12.052.52.....	73	12.093.12.....	82	12.233.12.....	87
11.404.15.....	62			12.052.52B.....	73	12.096.06.....	83	12.234.12.....	88
11.404.19.....	62			12.052.53.....	73	12.096.07.....	83	12.235.12.....	88
11.404.24.....	62			12.052.53B.....	73	12.096.09.....	83	12.240.14.....	89
11.412.15.....	62			12.052.54.....	73	12.096.11.....	83	12.241.14.....	89
11.412.19.....	62			12.052.54B.....	73	12.097.06.....	83	12.242.16.....	89
11.412.24.....	62			12.052.55.....	73	12.097.07.....	83	12.243.16.....	89
11.414.15.....	62			12.052.55B.....	73	12.097.09.....	83	12.244.14.....	89
11.414.19.....	62			12.052.61.....	73	12.097.11.....	83	12.245.14.....	89
11.414.24.....	62			12.052.61B.....	73	12.102.04.....	85	12.250.14.....	89
11.416.15.....	62			12.052.62.....	73	12.102.05.....	85	12.251.14.....	89
11.416.19.....	62			12.052.62B.....	73	12.103.04.....	85	12.254.14.....	89
11.416.24.....	62			12.052.63.....	73	12.103.05.....	85	12.255.14.....	89
11.422.15.....	62			12.052.63B.....	73	12.104.06.....	85	12.260.14.....	89
11.422.19.....	62			12.052.71.....	73	12.105.06.....	85	12.261.14.....	89
11.422.24.....	62			12.052.71B.....	73	12.110.50.....	85	12.262.16.....	90
11.424.15.....	62			12.052.72.....	73	12.110.55.....	85	12.263.16.....	90
11.424.19.....	62			12.052.72B.....	73	12.110.65.....	85	12.264.16.....	90
11.424.24.....	62			12.052.73.....	73	12.110.70.....	85	12.265.16.....	90
11.426.15.....	62			12.052.73B.....	73	12.110.75.....	85	12.270.14.....	90
11.426.19.....	62			12.052.81.....	73	12.110.90.....	85	12.271.14.....	90
11.426.24.....	62			12.052.81B.....	73	12.111.50.....	85	12.277.13.....	90
11.428.15.....	62			12.052.82.....	73	12.111.55.....	85	12.277.19.....	90
11.428.20.....	62			12.052.82B.....	73	12.111.65.....	85	12.284.14.....	101
11.428.24.....	62			12.052.83.....	73	12.111.70.....	85	12.310.14.....	91
11.428.30.....	62			12.052.83B.....	73	12.111.75.....	85	12.310.16.....	91
11.430.18.....	61			12.052.91.....	73	12.111.90.....	85	12.310.18.....	91
11.578.15.....	64			12.052.91B.....	73	12.112.20.....	85	12.310.20.....	91
11.578.18.....	64			12.052.92.....	73	12.112.30.....	85	12.310.22.....	91
11.579.15.....	64			12.052.92B.....	73	12.132.30.....	86	12.310.24.....	91
11.579.18.....	64			12.052.93.....	73	12.132.35.....	86	12.310.26.....	91
11.580.15.....	64			12.052.93B.....	73	12.132.40.....	86	12.310.30.....	91
11.580.18.....	64			12.053.00.....	74	12.132.50.....	86	12.311.14.....	91
11.580.21.....	64			12.053.01.....	74	12.133.30.....	86	12.311.16.....	91
11.581.15.....	64			12.053.02.....	74	12.133.35.....	86	12.311.18.....	91
11.581.18.....	64			12.053.10.....	74	12.133.40.....	86	12.311.20.....	91
11.581.21.....	64			12.053.11.....	74	12.133.50.....	86	12.311.22.....	91
11.582.15.....	64			12.053.12.....	74	12.135.30.....	86	12.311.24.....	91
11.582.18.....	64			12.059.07.....	79	12.135.35.....	86	12.311.26.....	91
11.583.15.....	64			12.061.09.....	79	12.135.40.....	86	12.311.30.....	91
11.583.18.....	64			12.063.10.....	79	12.135.50.....	86	12.312.13.....	93
11.584.15.....	64			12.065.06.....	79	12.142.30.....	86	12.312.14.....	93
11.584.18.....	64			12.070.35.....	79	12.142.35.....	86	12.312.16.....	93
11.584.21.....	64			12.070.45.....	79	12.142.40.....	86	12.313.13.....	93
11.585.15.....	64			12.070.50.....	79	12.142.50.....	86	12.313.14.....	93
11.585.18.....	64			12.071.35.....	79	12.143.30.....	86	12.313.16.....	93
11.585.21.....	64			12.071.45.....	79	12.143.35.....	86	12.316.14.....	94
11.586.15.....	64			12.071.50.....	79	12.143.40.....	86	12.316.16.....	94
11.586.18.....	64			12.073.35.....	79	12.143.50.....	86	12.316.18.....	94
11.586.21.....	64			12.075.35.....	79	12.145.30.....	86	12.317.14.....	94
				12.078.10.....	81	12.145.35.....	86	12.317.16.....	94
				12.078.14.....	81	12.145.40.....	86	12.317.18.....	94
				12.078.20.....	81	12.145.50.....	86	12.320.14.....	92

12







20.110.18.....	324	24.129.12.....	231	24.444.18.....	244	24.775.14.....	243	32.230.22.....	249
20.110.20.....	324	24.129.13.....	231	24.444.20.....	244	24.775.18.....	243	32.231.22.....	249
20.112.13.....	324	24.134.13.....	232	24.444.23.....	244	24.775.21.....	243	32.235.23.....	250
20.112.14.....	324	24.144.13.....	232	24.444.26.....	244	24.775.23.....	243	32.241.30.....	250
20.112.18.....	324	24.147.13.....	232	24.486.20.....	237	24.778.14.....	243	32.243.30.....	250
20.150.00.....	310	24.147.13L.....	232	24.636.10.....	240	24.778.18.....	243	32.245.23.....	251
20.150.02.....	310	24.154.12.....	232	24.637.10.....	240	24.778.21.....	243	32.247.23.....	251
20.150.03.....	310	24.154.14.....	232	24.650.10.....	240	24.778.23.....	243	32.249.05.....	251
20.150.06.....	310	24.164.15.....	232	24.651.10.....	240	24.779.14.....	243	32.249.08.....	251
20.150.09.....	310	24.164.15L.....	232	24.652.12.....	239	24.779.18.....	243	32.255.24.....	251
20.150.12.....	310	24.164.18.....	232	24.653.18.....	239	24.779.21.....	243	32.259.02.....	252
20.150.80.....	310	24.164.20.....	232	24.654.15.....	239	24.779.23.....	243	32.259.03.....	252
20.150.90.....	310	24.168.15.....	233	24.655.15.....	239	24.782.14.....	243	32.259.23.....	252
20.150.99.....	310	24.184.14.....	233	24.656.18.....	239	24.782.18.....	243	32.261.22.....	252
20.151.00.....	311	24.184.16.....	233	24.661.12.....	239	24.782.21.....	243	32.262.24.....	252
20.151.03.....	311	24.184.18.....	233	24.662.12.....	239	24.782.23.....	243	32.263.24.....	252
20.151.04.....	311	24.184.20.....	233	24.663.12.....	239	24.783.14.....	243	32.265.24.....	252
20.151.05.....	311	24.184.24.....	233	24.664.15.....	239	24.783.18.....	243	32.270.17.....	252
20.151.90.....	311	24.184.26.....	233	24.666.18.....	239	24.783.21.....	243	32.274.14.....	253
20.151.99.....	311	24.184.30.....	233	24.667.15.....	239	24.783.23.....	243	32.274.17.....	253
20.158.02.....	312	24.186.16.....	233	24.667.18.....	239	24.794.14.....	243	32.274.19.....	253
20.158.04.....	312	24.186.18.....	233	24.667.23.....	239	24.794.18.....	243	32.274.22.....	253
20.158.06.....	312	24.212.16.....	233	24.670.14.....	241	24.794.21.....	243	32.275.14.....	253
20.158.07.....	312	24.214.15.....	233	24.671.14.....	241	24.794.23.....	243	32.275.17.....	253
20.158.08.....	312	24.214.18.....	233	24.672.09.....	240	24.795.14.....	243	32.275.19.....	253
20.158.10.....	312	24.214.20.....	233	24.673.09.....	240	24.795.18.....	243	32.275.22.....	253
20.158.12.....	312	24.214.23.....	233	24.674.09.....	240	24.795.21.....	243	32.280.15.....	253
20.158.14.....	312	24.214.26.....	233	24.674.14.....	242	24.795.23.....	243	32.281.15.....	253
20.160.02.....	312	24.214.31.....	233	24.674.18.....	242	24.796.14.....	243	32.284.17.....	254
20.160.03.....	312	24.214.37.....	233	24.674.21.....	242	24.796.18.....	243	32.286.18.....	254
20.160.04.....	312	24.216.16.....	234	24.674.23.....	242	24.796.21.....	243	32.289.18.....	254
20.160.06.....	312	24.216.18.....	234	24.675.09.....	240	24.796.23.....	243	32.290.26.....	255
20.160.07.....	312	24.216.21.....	234	24.675.14.....	242	24.797.14.....	243	32.290.27.....	255
20.160.08.....	312	24.216.23.....	234	24.675.18.....	242	24.797.18.....	243	32.291.23.....	256
20.160.10.....	312	24.216.31.....	234	24.675.21.....	242	24.797.21.....	243	32.291.27.....	256
20.160.12.....	312	24.222.15.....	234	24.675.23.....	242	24.797.23.....	243	32.293.27.....	257
20.160.14.....	312	24.222.18.....	234	24.676.14.....	241	24.798.14.....	243	32.295.24.....	257
20.162.12.....	312	24.222.20.....	234	24.677.14.....	241	24.798.18.....	243	32.360.21.....	258
20.167.01.....	313	24.222.23.....	234	24.678.14.....	242	24.798.21.....	243	32.362.21.....	258
20.167.02.....	313	24.224.13.....	234	24.678.18.....	242	24.798.23.....	243	32.364.19.....	259
20.167.03.....	313	24.224.15.....	234	24.678.21.....	242	24.799.14.....	243	32.365.19.....	259
20.167.04.....	313	24.224.18.....	234	24.678.23.....	242	24.799.18.....	243	32.386.20.....	259
20.167.05.....	313	24.224.20.....	234	24.679.14.....	242	24.799.21.....	243	32.467.97.....	260
20.167.06.....	313	24.224.23.....	234	24.679.18.....	242	24.799.23.....	243	32.467.98.....	260
		24.224.26.....	234	24.679.21.....	242	24.870.15.....	245	32.468.00.....	260
		24.226.13.....	235	24.679.23.....	242	24.870.18.....	245	32.468.01.....	260
		24.226.15.....	235	24.682.14.....	242	24.871.15.....	245	32.468.02.....	260
		24.226.18.....	235	24.682.18.....	242	24.871.18.....	245	32.468.03.....	260
		24.226.20.....	235	24.682.21.....	242	24.872.15.....	245	32.468.04.....	260
		24.226.23.....	235	24.683.14.....	242	24.872.18.....	245	32.469.96.....	260
		24.226.26.....	235	24.683.18.....	242	24.873.15.....	245	32.469.97.....	260
		24.245.21.....	236	24.683.21.....	242	24.873.18.....	245	32.469.98.....	260
		24.245.26.....	236	24.690.16.....	244	24.920.15.....	246	32.470.00.....	260
		24.264.27.....	236	24.690.18.....	244	24.920.18.....	246	32.470.01.....	260
		24.276.14.....	235	24.691.16.....	244	24.920.21.....	246	32.470.02.....	260
		24.276.18.....	235	24.691.18.....	244	24.921.15.....	246	32.470.03.....	260
		24.276.20.....	235	24.693.16.....	244	24.921.18.....	246	32.470.04.....	260
		24.276.23.....	235	24.694.14.....	242	24.921.21.....	246	32.470.05.....	260
		24.280.14.....	235	24.694.18.....	242	24.922.15.....	246	32.470.06.....	260
		24.280.18.....	235	24.694.21.....	242	24.922.18.....	246	32.471.96.....	260
		24.280.20.....	235	24.694.23.....	242	24.922.21.....	246	32.471.97.....	260
		24.280.23.....	235	24.695.14.....	242	24.923.15.....	246	32.471.98.....	260
		24.285.20.....	236	24.695.18.....	242	24.923.18.....	246	32.472.00.....	260
		24.285.24.....	236	24.695.21.....	242	24.923.21.....	246	32.472.01.....	260
		24.285.26.....	236	24.695.23.....	242	24.924.21.....	246	32.472.02.....	260
		24.285.30.....	236	24.696.14.....	242	24.925.21.....	246	32.472.03.....	260
		24.315.27.....	237	24.696.18.....	242	24.926.21.....	246	32.472.04.....	260
		24.324.18.....	237	24.696.21.....	242	24.927.21.....	246	32.472.05.....	260
		24.324.26.....	237	24.697.14.....	242			32.472.06.....	260
		24.334.23.....	236	24.697.18.....	242			32.678.24.....	261
		24.364.18.....	237	24.697.21.....	242			32.690.13.....	261
		24.374.14.....	237	24.698.14.....	242	32.106.15.....	252	32.690.45.....	261
		24.374.17.....	237	24.698.18.....	242	32.201.18.....	248	32.690.90.....	261
		24.374.20.....	237	24.698.21.....	242	32.205.18.....	248	32.691.14.....	261
		24.374.24.....	237	24.698.23.....	242	32.209.15.....	248	32.691.99.....	261
		24.394.14.....	237	24.699.14.....	242	32.210.15.....	248	32.702.15.....	262
		24.394.17.....	237	24.699.18.....	242	32.211.15.....	248	32.702.15.....	262
		24.394.20.....	237	24.699.21.....	242	32.212.15.....	248	32.703.15.....	262
		24.408.12.....	238	24.699.23.....	242	32.213.15.....	248	32.705.05.....	262
		24.410.12.....	238	24.720.18.....	245	32.215.20.....	248	32.705.10.....	262
		24.414.12.....	238	24.722.18.....	245	32.218.23.....	248	32.705.15.....	262
		24.416.12.....	238	24.774.14.....	243	32.219.23.....	248	32.705.20.....	262
		24.430.16.....	238	24.774.18.....	243	32.228.23.....	249	32.705.25.....	262
		24.434.16.....	238	24.774.21.....	243	32.228.27.....	249	32.711.18.....	262
		24.444.16.....	244	24.774.23.....	243	32.229.23.....	249	32.715.16.....	263
						32.229.27.....	249	32.715.20.....	263

22

24

32





56.295.02.....228  
 56.295.03.....228  
 56.295.04.....228  
 56.295.05.....228  
 56.295.06.....228  
 56.297.01.....224  
 56.297.02.....224  
 56.298.00.....17  
 56.298.04.....17  
 56.298.06.....17  
 56.298.08.....17  
 56.298.10.....17  
 56.301.30.....176  
 56.303.29.....176  
 56.303.31.....176  
 56.307.24.....176  
 56.309.22.....177  
 56.311.22.....177  
 56.313.22.....177  
 56.317.23.....178  
 56.319.23.....178  
 56.321.23.....178  
 56.325.15.....179  
 56.327.26.....179  
 56.329.26.....179  
 56.331.26.....179  
 56.333.26.....179  
 56.343.24.....180  
 56.345.24.....180  
 56.347.24.....180  
 56.349.24.....180  
 56.418.42.....317  
 56.420.15.....317  
 56.430.32.....318  
 56.430.64.....318  
 56.431.15.....318  
 56.431.20.....318  
 56.431.25.....318  
 56.431.30.....318  
 56.431.32.....318  
 56.431.64.....318  
 56.470.05.....319  
 56.470.10.....319  
 56.470.15.....319  
 56.470.20.....319  
 56.470.25.....319  
 56.470.30.....319  
 56.470.40.....319  
 56.470.50.....319  
 56.472.05.....319  
 56.472.10.....319  
 56.472.15.....319  
 56.472.20.....319  
 56.472.25.....319  
 56.472.30.....319  
 56.472.35.....319  
 56.472.40.....319  
 56.472.45.....319  
 56.472.50.....319  
 56.472.70.....319  
 56.472.90.....319  
 56.474.05.....319  
 56.474.10.....319  
 56.474.15.....319  
 56.474.20.....319  
 56.474.25.....319  
 56.474.30.....319  
 56.474.35.....319  
 56.474.45.....319  
 56.474.50.....319  
 56.474.50.....319  
 56.474.70.....319  
 56.474.90.....319  
 56.475.00.....320  
 56.475.10.....320  
 56.475.15.....320  
 56.475.20.....320  
 56.475.25.....320  
 56.475.30.....320  
 56.475.35.....320  
 56.475.40.....320  
 56.475.45.....320  
 56.475.50.....320  
 56.476.00.....320  
 56.476.10.....320

56.476.15.....320  
 56.476.20.....320  
 56.476.25.....320  
 56.476.30.....320  
 56.476.35.....320  
 56.476.45.....320  
 56.476.50.....320  
 56.476.50.....320  
 56.500.00.....320  
 56.502.00.....322  
 56.502.01.....322  
 56.502.05.....322  
 56.502.06.....322  
 56.502.11.....322  
 56.502.55.....322  
 56.502.5.....322  
 56.502.57.....322  
 56.502.58.....322  
 56.502.60.....322  
 56.502.62.....322  
 56.502.65.....322  
 56.502.70.....322  
 56.505.18.....323  
 56.505.21.....323  
 56.507.14.....323  
 56.507.24.....323  
 56.509.01.....323  
 56.509.02.....323  
 56.509.03.....323  
 56.509.04.....323  
 56.701.06.....328  
 56.701.11.....328  
 56.702.06.....328  
 56.702.11.....328  
 56.703.06.....328  
 56.703.11.....328

**62**  
 62.106.20.....180

**64**  
 64.102.13.....181  
 64.102.14.....181  
 64.110.15.....181  
 64.110.19.....181  
 64.110.25.....181  
 64.120.15.....181  
 64.120.19.....181  
 64.120.22.....181  
 64.120.24.....181  
 64.120.30.....181  
 64.124.16.....181  
 64.124.20.....181  
 64.124.25.....181  
 64.124.30.....181  
 64.140.15.....181  
 64.140.19.....181  
 64.144.19.....184  
 64.150.20.....181  
 64.160.16.....182  
 64.160.18.....182  
 64.160.20.....182  
 64.160.24.....182  
 64.164.16.....182  
 64.164.20.....182  
 64.168.16.....182  
 64.168.20.....182  
 64.170.18.....183  
 64.170.20.....183  
 64.172.20.....183  
 64.172.23.....183  
 64.174.20.....183  
 64.178.18.....183  
 64.178.20.....183  
 64.178.23.....183  
 64.180.16.....184

**68**  
 68.250.01.....324  
 68.250.02.....324  
 68.250.03.....324  
 68.250.04.....324

**70**  
 70.404.14.....321

70.404.26.....321  
 70.410.01.....321  
 70.410.02.....321  
 70.410.03.....321  
 70.410.04.....321  
 70.410.05.....321  
 70.410.06.....321  
 70.410.07.....321  
 70.410.08.....321  
 70.410.09.....321  
 70.410.10.....321  
 70.410.11.....321  
 70.410.12.....321  
 70.410.13.....321  
 70.410.14.....321  
 70.410.15.....321  
 70.410.16.....321  
 70.410.17.....321  
 70.410.18.....321  
 70.410.19.....321  
 70.410.20.....321  
 70.410.21.....321  
 70.410.22.....321  
 70.410.23.....321  
 70.410.24.....321  
 70.410.25.....321  
 70.410.26.....321  
 70.410.27.....321  
 70.410.28.....321  
 70.410.29.....321  
 70.410.30.....321  
 70.415.01.....321  
 70.415.02.....321  
 70.415.03.....321  
 70.415.04.....321  
 70.415.05.....321  
 70.415.06.....321  
 70.415.07.....321  
 70.415.08.....321  
 70.415.09.....321  
 70.415.10.....321  
 70.415.11.....321  
 70.415.12.....321  
 70.415.13.....321  
 70.415.14.....321  
 70.415.15.....321  
 70.415.16.....321  
 70.415.17.....321  
 70.415.18.....321  
 70.415.19.....321  
 70.420.01.....321  
 70.420.03.....321  
 70.420.05.....321  
 70.420.07.....321  
 70.420.09.....321  
 70.420.11.....321  
 70.420.13.....321  
 70.420.15.....321  
 70.420.17.....321  
 70.420.19.....321  
 70.420.21.....321  
 70.420.23.....321  
 70.420.25.....321  
 70.424.08.....321  
 70.424.13.....321  
 70.531.23.....184

**74**  
 74.103.15.....314

**87**  
 87.574.15.....272

**88**  
 88.118.50.....78  
 88.118.65.....78  
 88.118.75.....78  
 88.118.80.....78  
 88.142.02.....320  
 88.142.03.....320  
 88.142.04.....320  
 88.765.02.....78  
 88.765.03.....78

**91**  
 91.205.00.....327

91.205.30.....327  
 91.205.45.....327  
 91.210.00.....327  
 91.210.30.....327  
 91.210.45.....327  
 91.215.00.....327  
 91.215.30.....327

**92**  
 92.404.01.....328  
 92.404.03.....328  
 92.409.41.....328  
 92.409.43.....328  
 92.413.01.....328  
 92.413.02.....328  
 92.413.03.....328  
 92.413.04.....328  
 92.909.00.....330  
 92.909.30.....75  
 92.909.31.....75  
 92.909.32.....75  
 92.909.34.....75

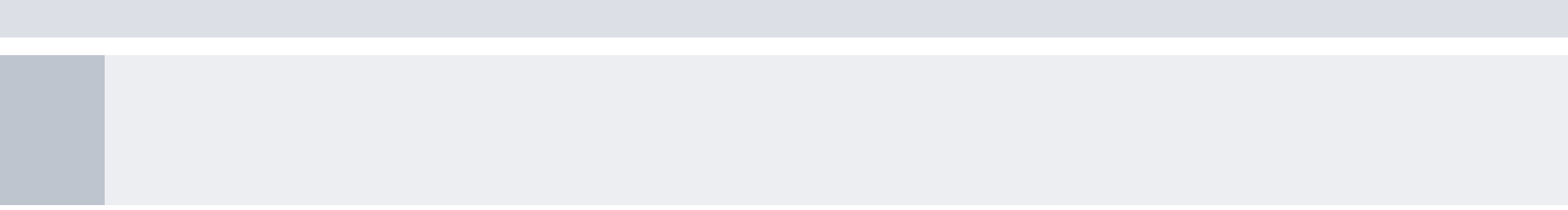





[info@dimeda.de](mailto:info@dimeda.de)  
[www.dimeda.de](http://www.dimeda.de)

DIMEDA Instrumente GmbH  
Gänsäcker 54+58  
78532 Tuttlingen  
Germany

+49 (0) 7462 | 94 61 - 0  
+49 (0) 7462 | 94 61 - 33

© DIMEDA Instrumente GmbH  
Art. Nr. 99.999.13  
05.2019 | Printed in Germany

Technische Änderungen vorbehalten  
subject to technical modifications