

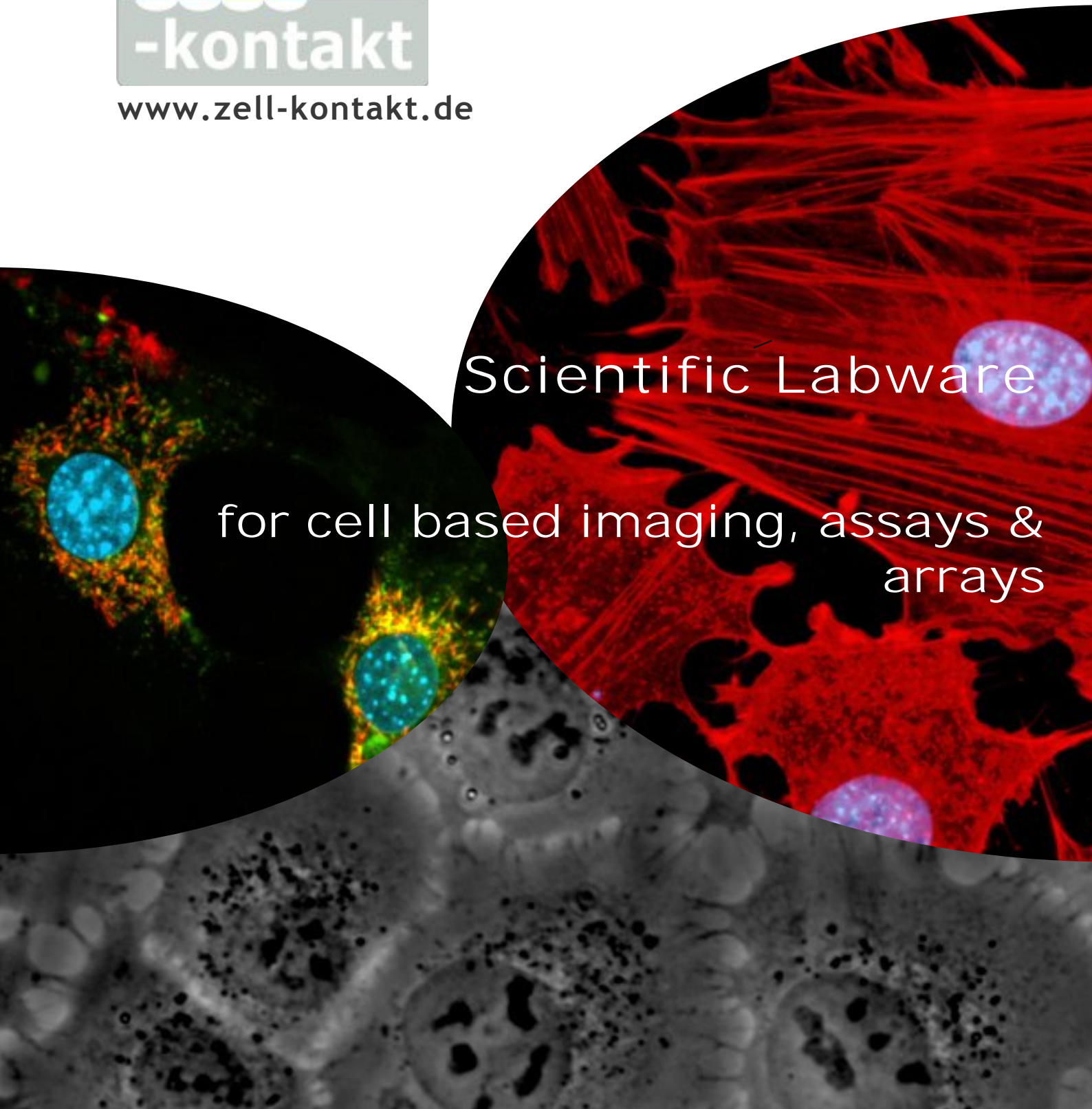

[www.zell-kontakt.de](http://www.zell-kontakt.de)



Scientific Labware

for cell based imaging, assays & arrays

Design - Biointerface - Performance

## labware for cell based imaging and high content analysis

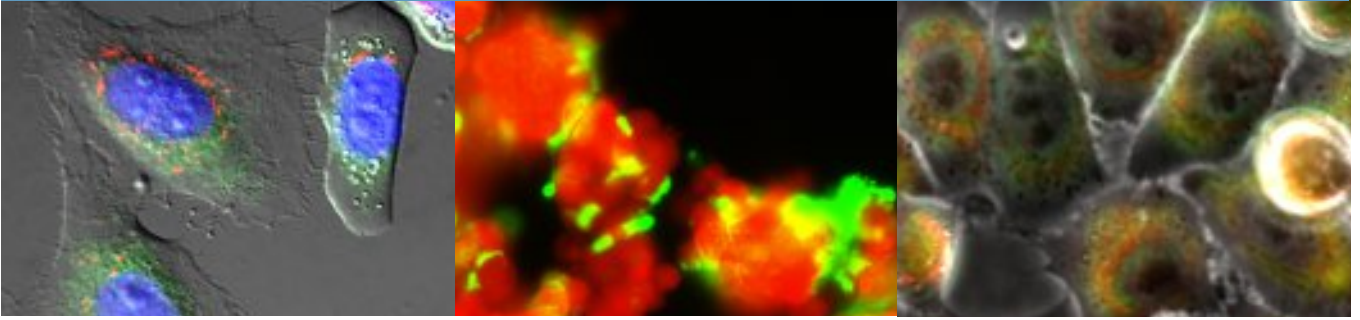

For a decade now we are serving High Resolution Microscopy, High Content Analysis and UV-spectroscopy users worldwide with scientific Labware dedicated to the requirements of these innovation driven technologies. It is time to thank you for your trust, feedback and cooperation during this challenging period.

2016 will be another interesting year with extensions of our product portfolio (Imaging Plate FC and CG with 6 wells) and large area imaging (Large Array Plate).

Your feedback and suggestions for further product and service optimization are always highly appreciated. Please do not hesitate to contact us in case of any comment, suggestion or question.

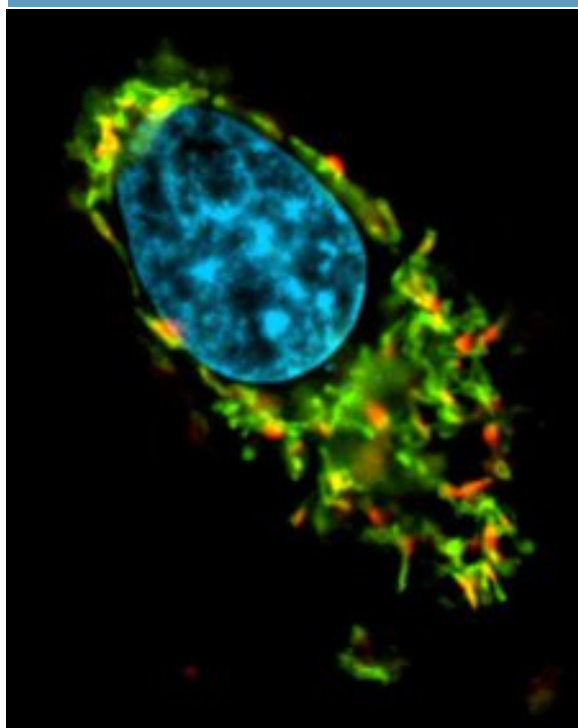

Material guide and services	page 4
Imaging Dish CG	page 5
Imaging Dish Stage Frame	page 6
Imaging Dish $\mu$ Grid	page 7
Imaging Chamber	page 8
Imaging Chamber CG	page 9
Imaging Plate FC	page 10
Imaging Plate CG	page 11
Array Plate	page 12
UV Plate	page 13
Product drawings	page 14

new products

Imaging Plate 6 well

A new 6 well variant for our Imaging Plates family. We kept the principles of low skirt design, robust no-flexible frame and improved planicity for all high resolution microscopy, imaging and HCS readouts. The Imaging Plates 6 are available with coverglass bottoms (thickness 145  $\mu$ m and 170  $\mu$ m) and with fluorocarbon film bottom. The plates are tissue culture surface treated, single packed, equipped with lid and sterile.



Array Plate

Whether you want to perform large area tissue slice staining or need a platform for your array based cell culture experiments: Our large area plate offers a platform based on regular plate dimensions with a single rectangular cavity and a 170  $\mu$ m tissue culture treated cover glass bottom.



The materials for our products are carefully selected to provide their specific benefits for the different applications.

Cover glass: Excellent chemical resistance, clear and pure borosilicate glass. Hydrolytic class I. Low alkali content (superior cell culture quality). Refractive index: 1.52, Abbe's number: 55.

Fluorcarbon film: Excellent chemical resistance, highest light transmission (also in the UV-B spectrum), highly gas permeable. Refractive index: 1.34, Abbe's number: 70.

Cycloolefin copolymer: Chemical resistant (including acetone and DMSO but not against toluene, benzene, alkanes, oleic acids). Refractive index: 1.53, Abbe's number: 58.

Polystyrene: Average chemical resistance (alcohols, formaldehyde, short term DMSO). Refractive index: 1.59, Abbe's number: 29.

Important for your fluorescence image quality is the Point Spread Function of the complete optical system. Please make sure to use appropriate cover glass correction and objectives to get the high end results which you expect.

## Surface modification and customized surfaces

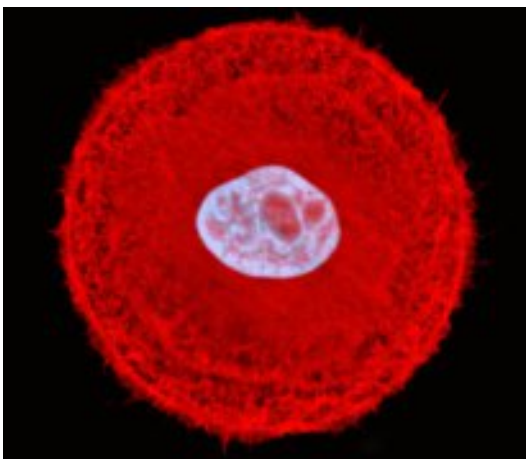

The interaction of the living cells with the artificial surfaces -the biointerface- determines morphology, differentiation, proliferation and distribution of your cells and consequently the read-out, results, interpretation and meaning of your assays. Surface microstructure and nanoscale surface chemistry control the functional performance of a product. Our company name zell-kontakt was chosen to indicate that innovative surface modification approaches are our dedication. Please contact us if you need special surface modifications.



## Product description

- 35 mm petri dish with central cover glass bottom
- 12 notch grip zone for easy handling
- Orientation marks
- Imaging area with reservoir (reduced staining volume)
- Excellent flatness and stable focal plane
- Tissue Culture surface

## Application technologies

Laser Scanning Confocal Microscopy (LSM), Total Internal Reflection Fluorescence (TIRF), Differential Interference Contrast (DIC), Fluorescence Correlation Spectroscopy (FCS), Fluorescence Resonance Energy Transfer (FRET), Fluorescence Recovery After Photobleaching (FRAP), Low intensity fluorescence, Microinjection / Micromanipulation, Cytometry

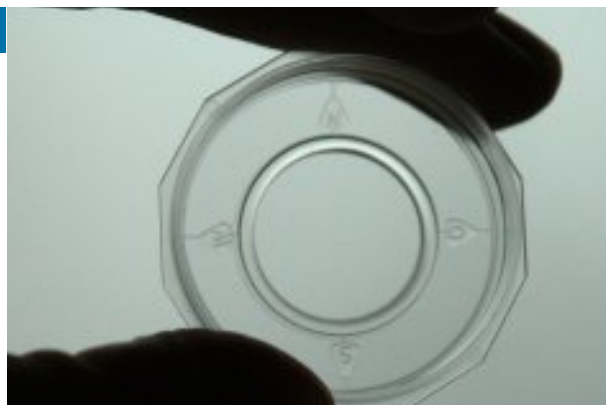

Imaging Dish CG 1.0  
Imaging Dish CG 1.5

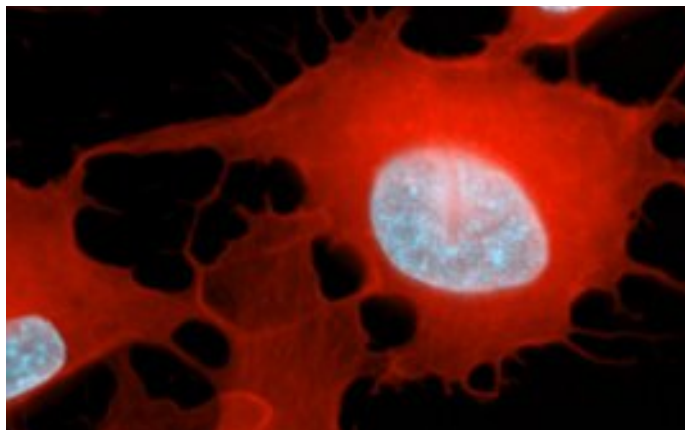

## 35mm petri dish with cover glass bottom

Imaging Dish CG are designed for high resolution microscopy techniques. The 35mm petri dishes provide a central cover glass bottom with a diameter of 18mm which supports direct inverse microscopy of living and fixed cells. The robust injection moulded dish body allows an extraordinary planicity over the entire imaging area and stability against thermal shifts.

Cell adhesion, spreading and distribution on top of the glass surface is improved due to our proprietary plasma surface modification.

The cover glass area and cell cultivation zone is kept 2mm below the inner basement level of the petri dish body. Therefore a small volume reservoir is created which allows the concentration of the cells on top of the glass area during seeding and reduction of antibodies or dyes during staining applications.

The polygonal grip zone which diameter is larger compared to the lid and the prominent macroscopic orientations marks (N-O-S-W) of the dishes facilitate the handling. The combination of the polygonal grip zone of the dishes with our Imaging Dish Stage Frame allows exact repositioning of the dishes for repeated imaging sessions on the microscope.

## Technical Data

Dish diameter	35 mm	Planicity / Flatness	5 µm
Imaging area / diameter	18 mm	Distance dish bottom to focal plane	400 µm
Total volume	7 ml	Temperature stability	-20°C / 50°C
Suggested cell seeding volume	750 µl	Material dish body and lid	Polystyrene
Suggested working volume	2 ml	Material glass	Borosilicate

## Order information

Art. No.	Product	Glass thickness	Format	Qty/Bag	Qty/Box	sterile	Surface
5160-30	Imaging Dish CG 1.0	145µm ± 15µm	35 / 18mm	2	30	+	TC
5160-168	Imaging Dish CG 1.0	145µm ± 15µm	35 / 18mm	2	168	+	TC
6160-30	Imaging Dish CG 1.5	170µm ± 15µm	35 / 18mm	2	30	+	TC
6160-168	Imaging Dish CG 1.5	170µm ± 15µm	35 / 18mm	2	168	+	TC

## Product description

- Microscope stage adapter plates
- Allow oriented placement of Imaging Dishes
- Stage Frame for single Imaging Dish, 52 x 76 mm
- Stage Frame for two Imaging Dishes, 124.76 x 85.48 mm
- Solid Frame made from aluminium

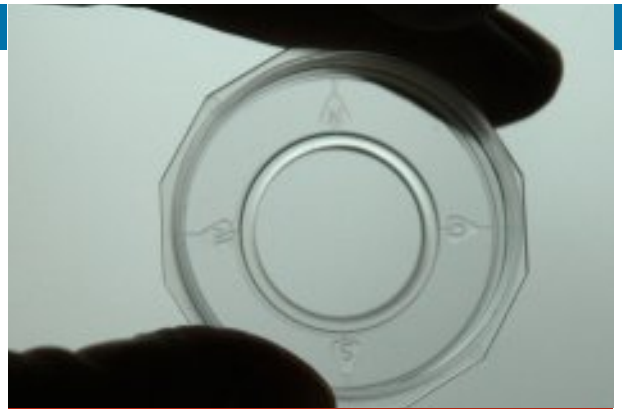

Imaging Dish Stage Frame

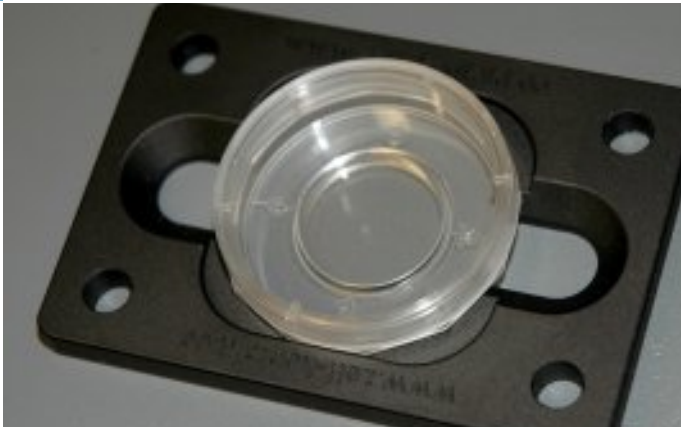

## Adapter plate for microscope stages

Imaging Dish Stage Frames are ideal combination for our Imaging Dishes. The adapters allow oriented and exact positioning of the dishes on microscope stages. The 12 notch grip zone of the dishes enables orientend and aligned placement of the round dishes in these adapters. Due to this support for positioning and orientation it is possible in to locate the same Regions Of Interest in between different exmination time points .

The adapters ensure, that the focal plane of the dishes is in the level of the bottom side of the adapters. Therefore access with immersion objectives is made easy.

Two sizes of the adapters are offered:

Imaging Stage Frame single supports one dish and works best with microscope slide holders. The footprint of the Imaging Dis Stage Frame single is two times the size of a European standard microscope slide (52 x 76 mm)

Imaging Stage Frame double supports two dishes and works best with multiwell plate adapters for microscope stages. The footprint of the Imaging Dish Stage Frame double is in the size of a multiwell plate (124,76 x 85,48 mm)

If necessary please clean Imaging Dish Stage Frames with soft tissues to avoid scratches.

## Order information

Art. No.	Product	Format (l/w/h) [mm]	Qty/Box	Weight [g]
9001-1	Imaging Dish Stage Frame, single	76 / 52 /	1	38
9002-1	Imaging Dish Stage Frame, double	124.76 / 85.48 /	1	124

## Product description

- 35 mm petri dish with central cover glass bottom
- 12 notch grip zone for easy handling
- Orientation marks & laser marked  $\mu$ Grid
- Imaging area with reservoir (reduced staining volume)
- Excellent flatness and stable focal plane
- Tissue Culture surface

## Application technologies

Laser Scanning Confocal Microscopy (LSM), Total Internal Reflection Fluorescence (TIRF), Differential Interference Contrast (DIC), Fluorescence Correlation Spectroscopy (FCS), Fluorescence Resonance Energy Transfer (FRET), Fluorescence Recovery After Photobleaching (FRAP), Low intensity fluorescence, Microinjection / Micromanipulation, Cytometry

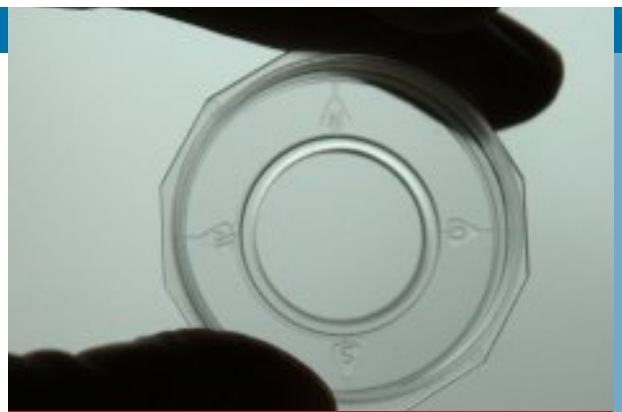

Imaging Dish  $\mu$ Grid

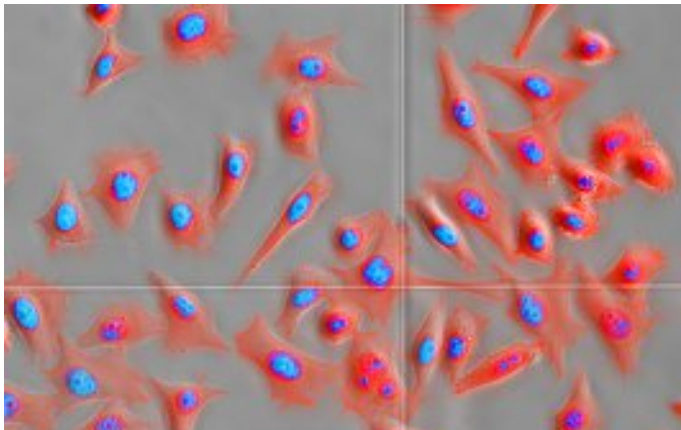

### 35mm petri dish with cover glass bottom and laser marked orientation grid

Imaging Dish CG are designed for high resolution microscopy techniques and enable repeated location of cells and Regions Of Interest (ROI) when motorized microscope stages are missing. Fine laser marked lines on the inner surface of the cover glass areas support orientation and manually driven cytometry.

The high precision laser marks are visible in brightfield and phase contrast microscopy in the focal plane of the cultivated cells. The lines have a width of  $3\ \mu\text{m}$  and a depth of  $0.3\ \mu\text{m}$ . These fine marks allow easy detection but do not influence cell orientation/alignment and do not interfere with fluorescence microscopy.

The marked area covers  $9 \times 9\ \text{mm}$  square in the center of the coverglass bottom of the dishes. The distance of the lines are  $600\ \mu\text{m}$  in the outer areas the square and  $300\ \mu\text{m}$  in the inner area. as result the  $9 \times 9\ \text{mm}$  area is separated in 9 fields with alternating grid geometry.

In combination with the macroscopic orientations marks (N-O-S-W) and our Imaging Dish Stage Frame location of individual cells at different time points is made easy without a motorized stage frame. Our Homepage offers a documentation template which you can use to support your experiments.

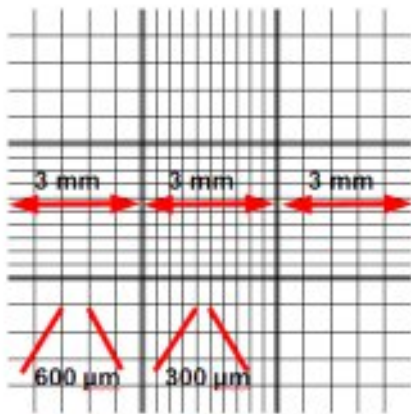

## Technical Data

Dish diameter	35 mm	Planicity / Flatness	5 $\mu\text{m}$
Imaging area / diameter	18 mm	Distance dish bottom to focal plane	400 $\mu\text{m}$
Total volume	7 ml	Temperature stability	-20°C / 50°C
Suggested cell seeding volume	750 $\mu\text{l}$	Material dish body and lid	Polystyrene
Suggested working volume	2 ml	Material glass	Borosilicate

## Order information

Art. No.	Product	Glass thickness	Format	Qty/Bag	Qty/Box	sterile	Surface
7160-30	Imaging Dish $\mu$ Grid	170 $\mu\text{m} \pm 15\ \mu\text{m}$	35 / 18 mm	2	30	+	TC
7160-168	Imaging Dish $\mu$ Grid	170 $\mu\text{m} \pm 15\ \mu\text{m}$	35 / 18 mm	2	168	+	TC



## Product description

- Chambered microscope slides
- Chambers can be removed without a tool
- Variants with 1, 2, 4 and 8 wells
- Chambers made from COC polymer (temperature and chemical resistance)

## Application technologies

Immuno histochemistry (IHC), Fluorescence In Situ Hybridization (FISH)

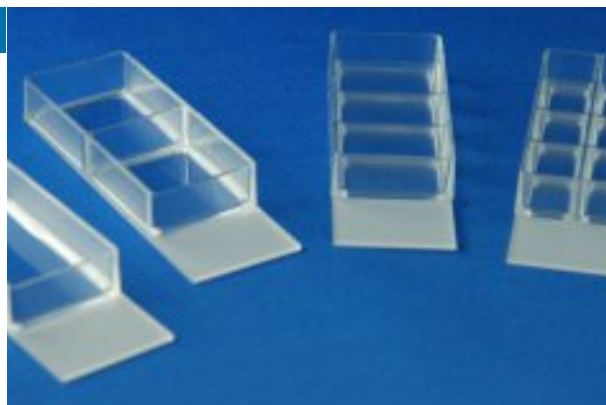

## Imaging Chamber Microscope Slide Bottom

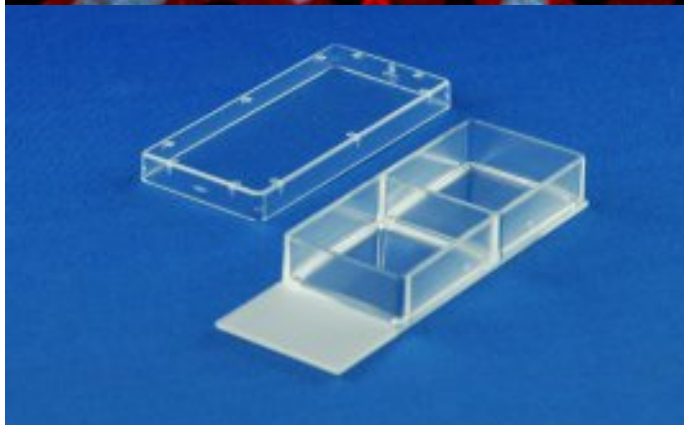
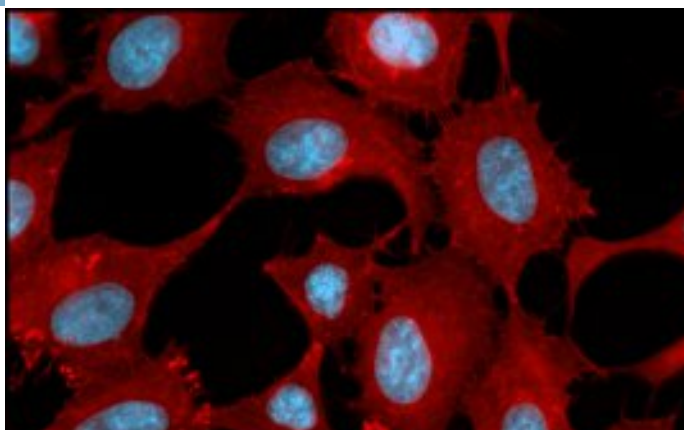

## Chambered microscope slides

Imaging Chambers provide microscope slides as bottom structure. Chambers and lids are made from high performance polymers and are sealed against the glass bottoms by biological inert silicone adhesive. At the end of the experiments the glasses can be detached from the polymer chambers with minimal glue residue.

The high performance polymer of chamber bodies and lids withstands temperatures up to 90°C and is resistant against acetone. Therefore the full products are suitable for in-situ hybridization technologies as well as for a wide range of fixation and staining protocols.

Imaging Chambers with microscope slides can be used with long distance objectives. After disassembly the slides can be covered with cover glasses and are then also suitable for high resolution immersion microscopy.

Cell adhesion, spreading and distribution on top of the glass surface is improved due to our proprietary plasma surface modifications.

Imaging Chambers are available in 1 well, 2 well, 4 well and 8 well format. Sales units of 16 or 80 chambers per box.

## Technical Data

Microscope slide area 26 x 76 mm

Microscope slide thickness 1 mm

Chemical resistance:  
DMSO, acetone, formaldehyde, glutaraldehyde,  
ethanol, methanol

Avoid: Toluol, Xyluol

Planicity / Flatness 5 µm

Chamber height 10 mm

Temperature stability -20°C / 90°C

Material chamber body and lid COC

Material of the glass bottom Soda lime

## Order information

Art. No.	Product	Area / well	Working Vol.	Qty/Bag	Qty/Box	sterile	Surface
8011-16 / 8011-80	Imaging Chamber 1	10.84 cm <sup>2</sup>	2000 µl	1	16 or 80	+	TC
8012-16 / 8012-80	Imaging Chamber 2	5.04 cm <sup>2</sup>	1000 µl	1	16 or 80	+	TC
8014-16 / 8014-80	Imaging Chamber 4	2.14 cm <sup>2</sup>	500 µl	1	16 or 80	+	TC
8018-16 / 8018-80	Imaging Chamber 8	0.88 cm <sup>2</sup>	300 µl	1	16 or 80	+	TC



## Product description

- Chambered coverglass, 170 µm, no. 1.5
- Chambers can be removed without a tool
- Variants with 1, 2, 4 and 8 wells
- Chambers made from COC polymer (temperature and chemical resistance)

## Application technologies

Life Cell Imaging, Laser Scanning Confocal Microscopy (LSM), Total Internal Reflection Fluorescence (TIRF), Differential Interference Contrast (DIC), Fluorescence Correlation Spectroscopy (FCS), Fluorescence Resonance Energy Transfer (FRET), Fluorescence Recovery After Photobleaching (FRAP), Low intensity fluorescence, Cytometry

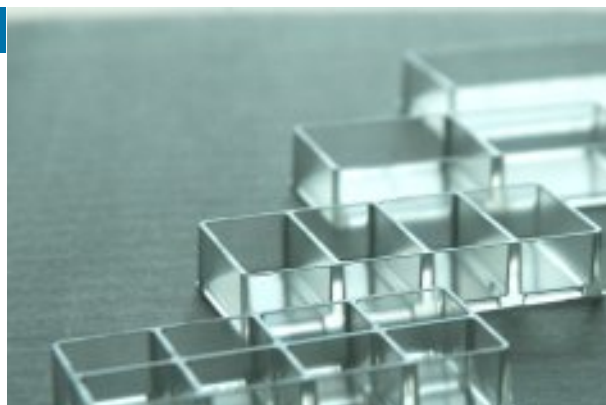

Imaging Chamber CG  
Coverglass Bottom



## Chambered coverglass

Imaging Chambers CG provide coverglass slides (Imaging Chamber CG) as bottom structure. They are designed for high resolution live cell microscopy techniques.

The high performance polymer of chamber bodies and lids withstands temperatures up to 90°C and is resistant against acetone. Therefore the full products are suitable for in-situ hybridization technologies as well as for a wide range of fixation and staining protocols.

Cell adhesion, spreading and distribution on top of the glass surface is improved due to our proprietary plasma surface modifications. Imaging Chambers are available in 1 well, 2 well, 4 well and 8 well format. Sales units of 16 or 80 chambers per box.

## Accessories

Imaging Chamber DIC Lid is a lid with central coverglass area for DIC (Differential interference contrast) illumination. Art.No. 8100-4 (four lids per box, single packed, sterile). Imaging Chamber CG Adapter is a reusable extension for Imaging Chambers CG to extend them to full length of microscope slides. This adapter is helpful to use the Imaging Chambers CG with conventional microscope slide stage adapters. Art.no. 8200-1 (one adapter per box).

## Technical Data

Coverglass area 26 x 58 mm

Coverglass thickness 170 µm

Chemical resistance:  
DMSO, acetone, formaldehyde, glutaraldehyde,  
ethanol, methanol

Avoid: Toluol, Xyluol

Planicity / Flatness 5 µm

Chamber height 10 mm

Temperature stability -20°C / 90°C

Material chamber body and lid COC

Material of the glass bottom Borosilicate

## Order information

Art. No.	Product	Area / well	Working Vol.	Qty/Bag	Qty/Box	sterile	Surface
8001-16 / 8001-80	Imaging Chamber 1	10.84 cm <sup>2</sup>	2000 µl	1	16 or 80	+	TC
8002-16 / 8002-80	Imaging Chamber 2	5.04 cm <sup>2</sup>	1000 µl	1	16 or 80	+	TC
8004-16 / 8004-80	Imaging Chamber 4	2.14 cm <sup>2</sup>	500 µl	1	16 or 80	+	TC
8008-16 / 8008-80	Imaging Chamber 8	0.88 cm <sup>2</sup>	300 µl	1	16 or 80	+	TC

## Product description

- Black body, transparent bottom multiwell plates
- Superior light transmission
- Variants with 6, 24 and 96 wells
- SBS/ANSI compliant design
- Low Skirt Design
- Tissue Culture Treated surface (TC)

## Application technologies

High Content Analysis/Screening (HCA/HCS), Fluorescence Resonance Energy Transfer (FRET), Fluorescence Recovery After Photobleaching (FRAP), Low intensity fluorescence, Immunohistology, Phototoxicity studies, Hypoxia/Hyperoxia studies, Metabolic highly active cells, Laser Scanning Confocal Microscopy (LSM),

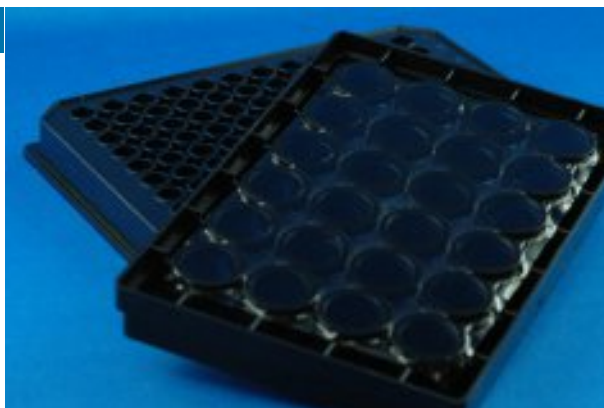

## Imaging Plate FC Fluorcarbon Film Bottom

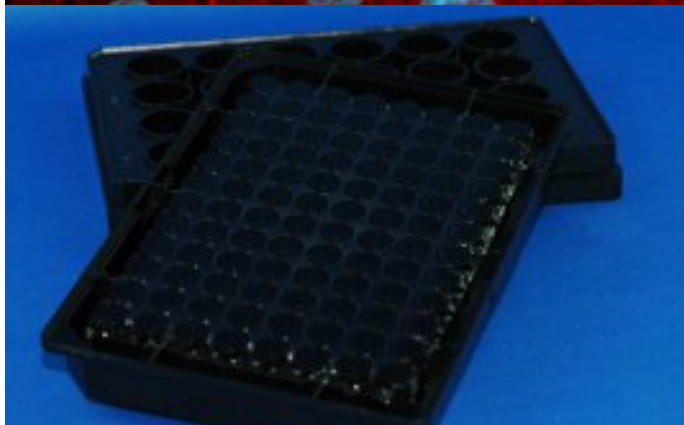
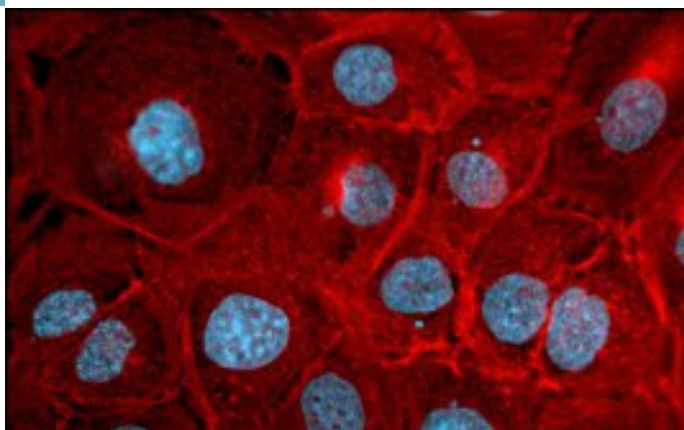

## Optical Fluorcarbon-Film Bottom Plates

Imaging Plates FC are black multiwell plates compliant to the SBS (Society for Biomolecular Screening) standard with a bottom made from a 25 µm fluorcarbon (FC) film. The thin film is stretched to ensure high level planicity. The FC film is gaspermeable and enables the fast equilibration of gas partial pressure in the cellular microenvironment with the surrounding air. In addition the film shows significant light transmission already at a wavelength of 210 nm.

Imaging Plates FC can be used for high resolution live cell microscopy. The plates are also suitable for a wide range of fixation and staining protocols (formaldehyde, glutaraldehyde, alcohols, acetone). Acetone should not be applied for periods longer than 10 minutes since the plate body is made from polystyrene and the plate body can detach from the bottom. Imaging Plates FC can be used at temperatures between -20°C and 50°C. Cell adhesion, spreading and distribution are improved due to our well established plasma surface modification technologies.

The thin FC film plate bottoms make the plates suitable for the application of high resolution immersion objectives. For objectives with magnifications 40x objectives with a correction ring or collar have to be applied to get optimal focus control. Water, glycerine and oil can be used as immersion medium.

## Technical Data

Bottom thickness	25 µm	Planicity / Flatness per well	5 µm
Distance plate bottom - focal plane	400 µm	Planicity / Flatness per plate	50 µm
Light transmission @ 240/270 nm	70% / 80%	Temperature stability	-20°C / 50°C
Oxygen permeability	>6300 cm <sup>3</sup> /(m <sup>2</sup> *d* bar)	Material plate body and lid	Polystyrene
CO <sub>2</sub> permeability	>7000 cm <sup>3</sup> /(m <sup>2</sup> *d* bar)	Material of the plate bottom	Fluorcarbon film

## Order information

Art. No.	Product	Area / well	Working Vol.	Qty/Bag	Qty/Box	sterile	Surface
3221-20	Imaging Plate 6 FC	8,04 cm <sup>2</sup>	2000-4000 µl	1	20	+	TC
3231-20	Imaging Plate 24 FC	1.37 cm <sup>2</sup>	500-1000 µl	1	20	+	TC
3241-20	Imaging Plate 96 FC	0.28 cm <sup>2</sup>	100-200 µl	1	20	+	TC

## Product description

- SBS/ANSI compliant optical multiwell plates
- Coverglass bottom (145µm or 170µm)
- Black polystyrene plate body
- Low Skirt design (support of immersion objectives)
- Tissue Culture treated surface

## Application technologies

Laser Scanning Confocal Microscopy (LSM), Total Internal Reflection Fluorescence (TIRF), Fluorescence Correlation Spectroscopy (FCS), Fluorescence Resonance Energy Transfer (FRET), Fluorescence Recovery After Photobleaching (FRAP), Low intensity fluorescence, Fluorescence In-Situ Hybridization (FISH), Immunohistology, High Content Analysis/Screening (HCA/HCS)

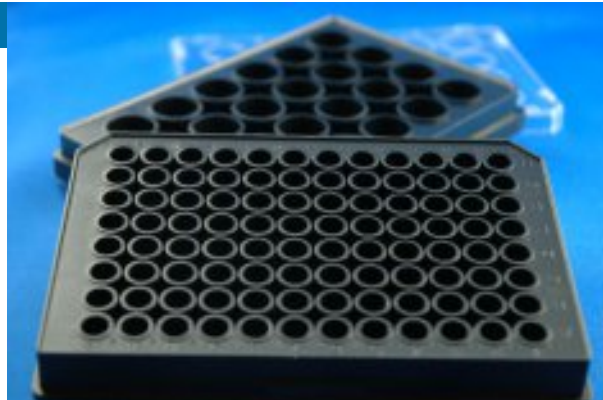

**Imaging Plate CG  
Coverglass Bottom**

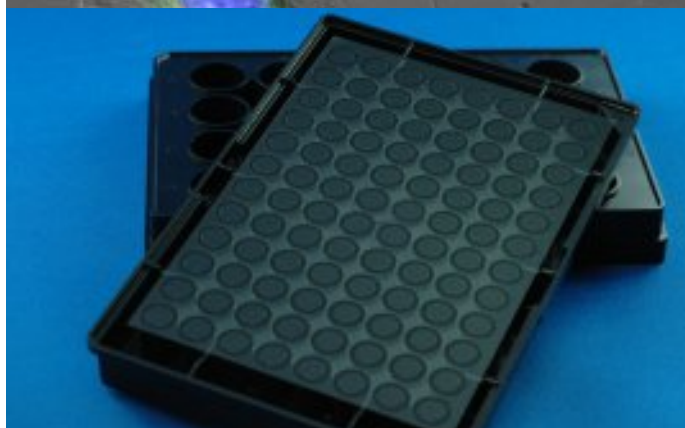
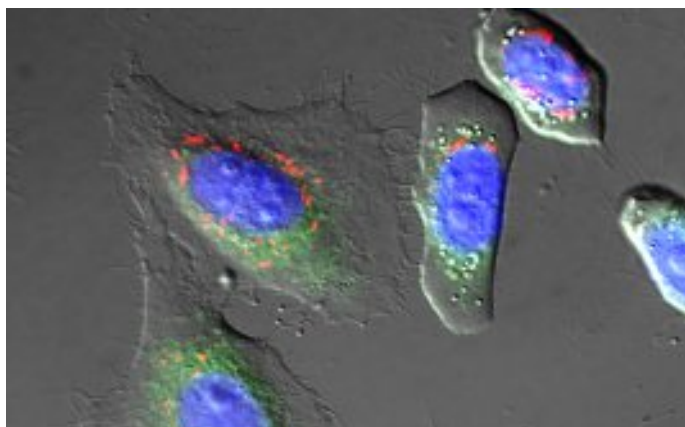

## Optical Coverglass Bottom Plates

Imaging Plates CG are black multiwell plates compliant to the SBS (Society for Biomolecular Screening) standard with a bottom made from borosilicate coverglass. The plate bodies are made from polystyrene and are tightly sealed against the glass bottoms by an adhesive.

Imaging Plates CG can be used for high resolution live cell microscopy. The plates are also suitable for a wide range of fixation and staining protocols (formaldehyde, glutaraldehyde, alcohols, acetone). Acetone should not be applied for periods longer than 10 minutes since the plate body is made from polystyrene and the plate body can detach from the glass bottom.

Imaging Plates CG can be used at temperatures between -20°C and 50°C.

Cell adhesion, spreading and distribution are improved due to our well established plasma surface modification technologies.

The cover glasses plate bottoms make the plates suitable for the application of high resolution immersion objectives. Water, glycerine and oil can be used as immersion medium.

Imaging Plates CG are available in 6 well, 24 well and 96 well format. Variants with 145 µm and 170 µm thickness coverglasses are offered.

## Technical Data

Bottom thickness CG 1.0 145 ± 15 µm  
Art.no. 5221, 5231, 5241

Bottom thickness CG 1.5 170 ± 15 µm  
Art.no. 5222, 5232, 5242

Distance plate bottom - focal plane 400 µm

Planicity / Flatness per well 5 µm

Planicity / Flatness per plate 50 µm

Temperature stability -20°C / 50°C

Material plate body and lid Polystyrene

Material of the plate bottom Borosilicate glass

## Order information

Art. No.	Product	Area / well	Working Vol.	Qty/Bag	Qty/Box	sterile	Surface
5221-20 / 5222-20	Imaging Plate 6 CG	8,04 cm <sup>2</sup>	2000-4000 µl	1	20	+	TC
5231-20 / 5232-20	Imaging Plate 24 CG	1.37 cm <sup>2</sup>	500-1000 µl	1	20	+	TC
5241-20 / 5242-20	Imaging Plate 96 CG	0.28 cm <sup>2</sup>	100-200 µl	1	20	+	TC



## Product description

- Black body, transparent bottom plate
- Large area coverglass bottom
- SBS/ANSI compliant design
- Low Skirt Design
- Tissue Culture Treated surface (TC)

## Application technologies

- Large Area Microarrays
- Array-cell interaction studies
- Neurite outgrowth studies
- Tissue sections / histology
- Tissue section cultivation

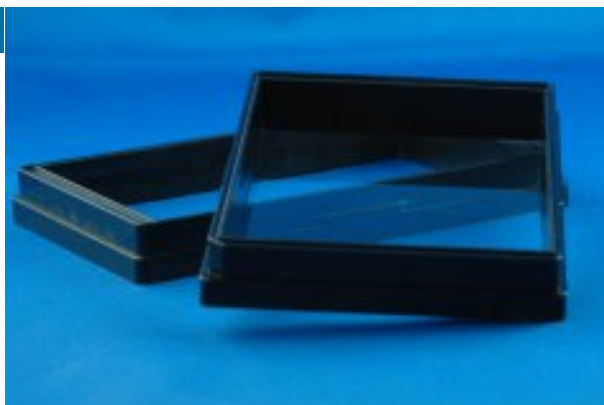

Array Plate  
Coverglass Bottom

## Large Area Coverglass Bottom Plate

Array plates are compliant to the SBS (Society for Biomolecular Screening) standard with a bottom made from a 170 µm coverglass. The complete plate provides a single large area for

- imaging
- array spotting
- cultivation

Array Plates can be used for high resolution cell, tissue or array microscopy. The plates are also suitable for a wide range of fixation and staining protocols (formaldehyde, glutaraldehyde, alcohols, acetone). Acetone should not be applied for periods longer than 10 minutes since the plate body is made from polystyrene and the plate body can detach from the glass bottom.

Array Plates can be used at temperatures between -20°C and 50°C.

Cell adhesion, spreading and distribution are improved due to our well established plasma surface modification technologies.

The cover glass plate bottoms make the plates suitable for the application of high resolution immersion objectives. Water, glycerine and oil can be used as immersion medium.

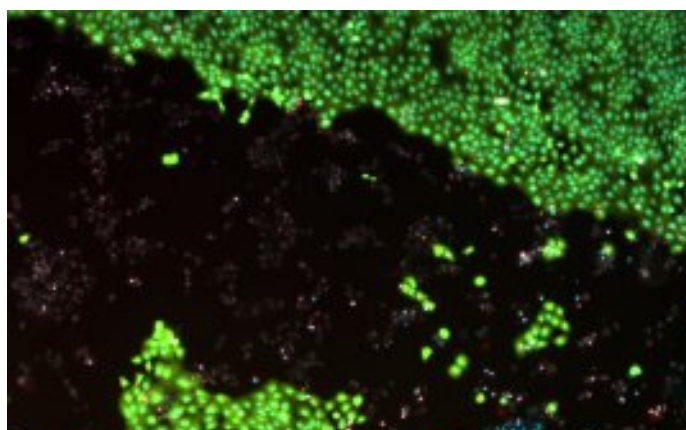

## Technical Data

Bottom thickness	170 ± 15 µm	Planicity / Flatness per well	50 µm
Distance plate bottom - focal plane	400 µm	Planicity / Flatness per plate	50 µm
Imaging area	nnn x nnn mm	Temperature stability	-20°C / 50°C
Suggested working volume	400 µm	Material plate body and lid	Polystyrene
		Material of the plate bottom	Borosilicate glass

## Order information

Art. No.	Product	Qty/Bag	Qty/Box	sterile	Surface	Lid
5212-4	Array Plate	1	4	+	TC	-



## Product description

- SBS/ANSI compliant multiwell plates
- UV transparent film bottom (25 µm thick)
- Transparent or black polystyrene plate body
- DNase/RNase free

## Application technologies

- UV Spectroscopy,
- Transmission and detection of Optical Density (OD) between 220 nm and 800nm,
- Evaluation of DNA and RNA purity,
- Label free quantitation of DNA, RNA and small molecules

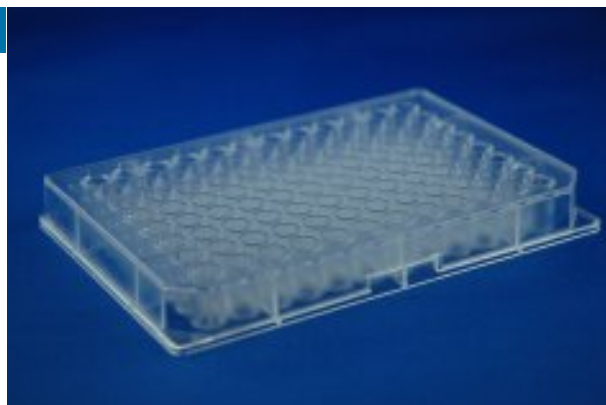

UV Plate

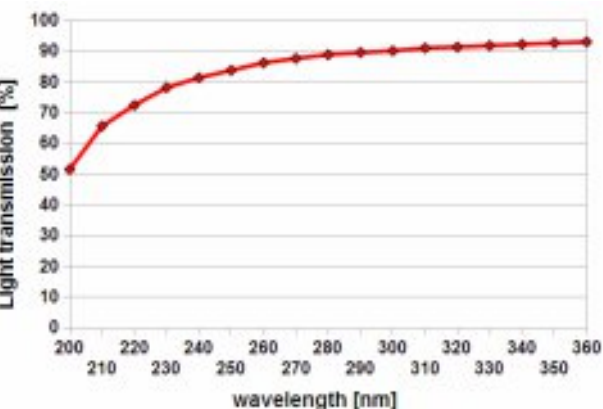

## UV light transparent Bottom Plates

Due to its ultrathin film bottom (25 µm) made from a high performance polymer this microwell plate provides excellent light transmission not only in the visible wavelength spectrum but already in the UV A and UV B light spectrum.

In combination with an UV plate reader the purity of DNA and RNA can be detected. Furthermore the concentration of UV light adsorbing small molecules, DNA and RNA can be detected without addition of any stains and markers.

Plate variants with transparent and black plate bodies are offered. The black bodied plates are recommended when UV light transmission measurements shall be combined with fluorescence measurements.

UV plates are delivered in boxes of 40 plates, 10 plates per bag, without lids. UV plates are not sterilized.

The plate is designed in accordance with SBS guidelines and is suitable for automated throughput screenings.

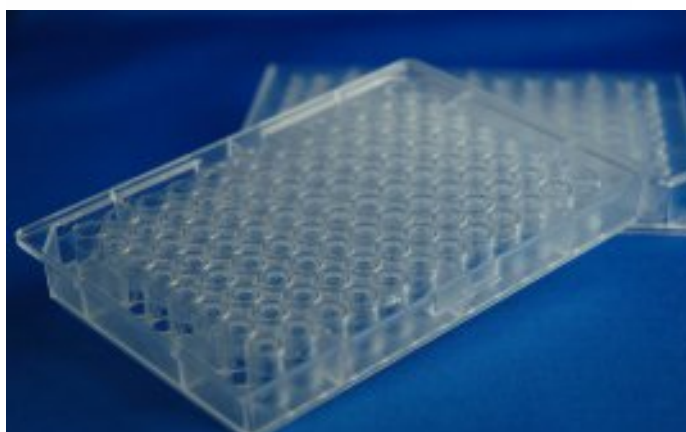

## Technical Data

Bottom thickness	25 µm	Working volume per well	50-350 µl
Distance plate bottom - focal plane	400 µm	Total volume per well	428 µl
Light transmission @ 240/270 nm	70% / 80%	Temperature stability	-20°C / 50°C
		Material plate body and lid	Polystyrene
		Material of the plate bottom	Fluorcarbon film

## Order information

Art. No.	Product	Format	Well diameter	Qty/Bag	Qty/Box	sterile	Lid
2145-40	UV Plate	96 well	6 mm	10	40	-	-
2146-40	UV Plate, black plate body	96 well	6 mm	10	40	-	-



Imaging Dish  
CytoCapture Dish

LID

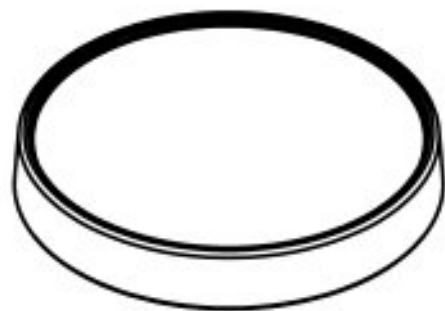
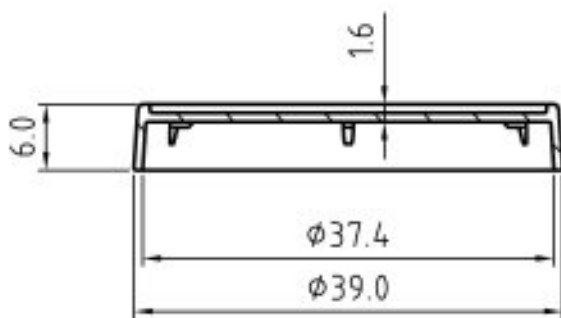

DISH

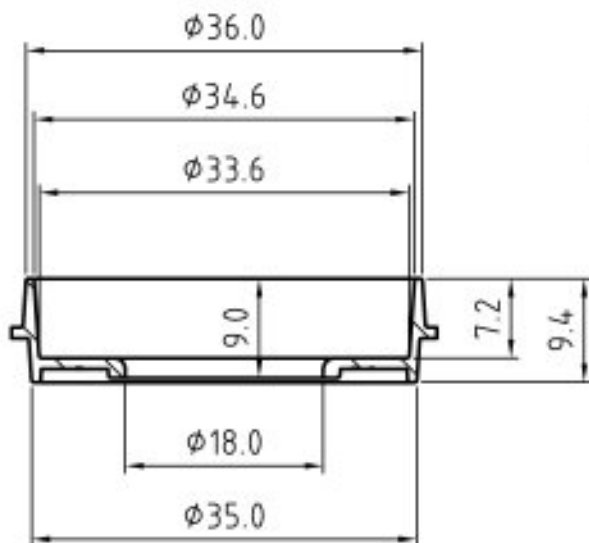

## Related articles

Art. No.	Product
5160	Imaging Dish CG 1.0
6160	Imaging Dish CG 1.5
7160	Imaging Dish CG $\mu$ Grid

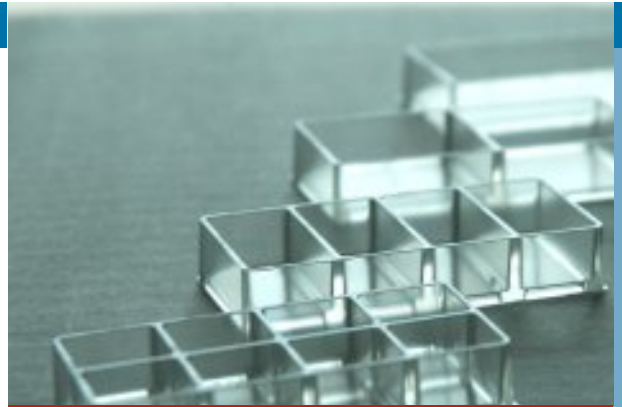
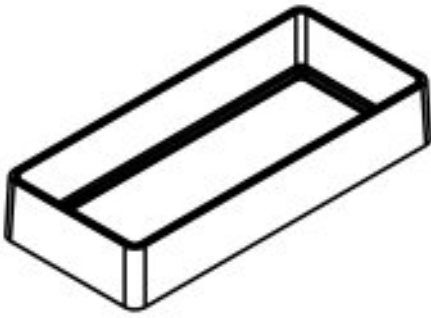

Imaging Chamber  
Imaging Chamber CG

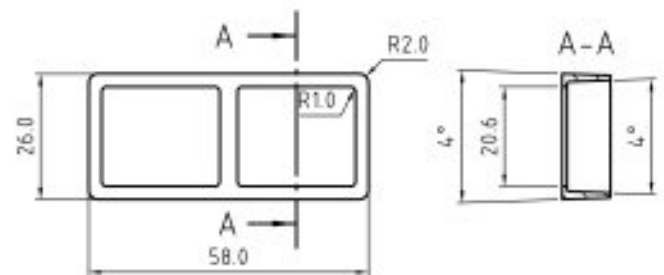
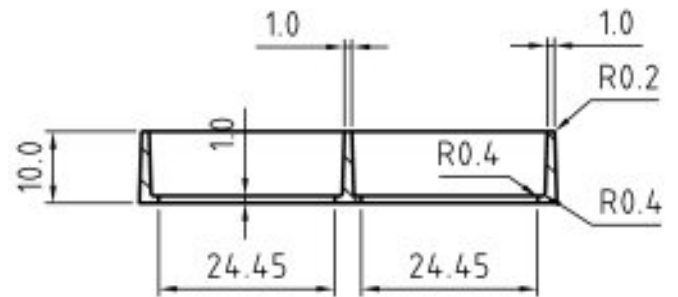
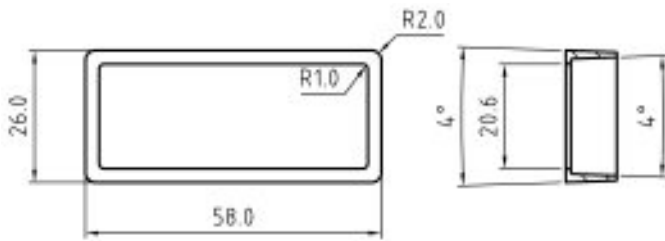
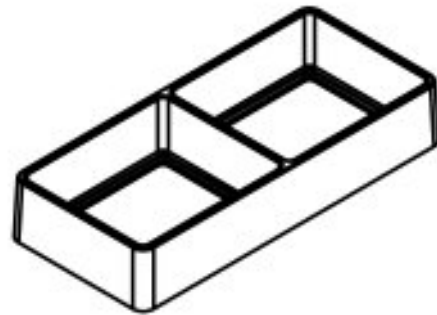
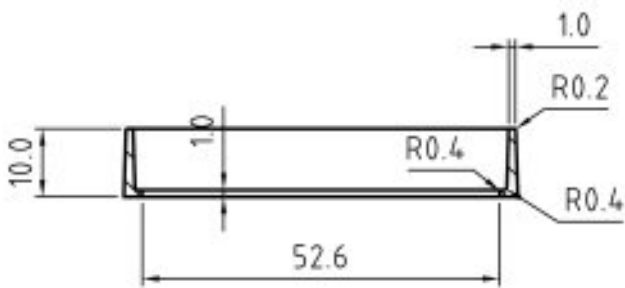

### Related articles

Art. No.	Product	Art. No.	Product
8011	Imaging Chamber 1	8001	Imaging Chamber 1 CG
8012	Imaging Chamber 2	8002	Imaging Chamber 2 CG

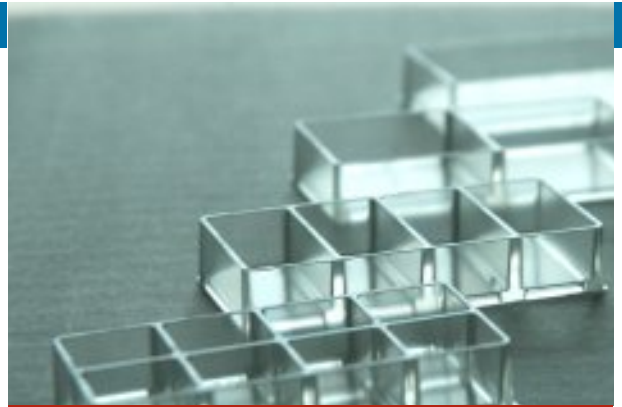
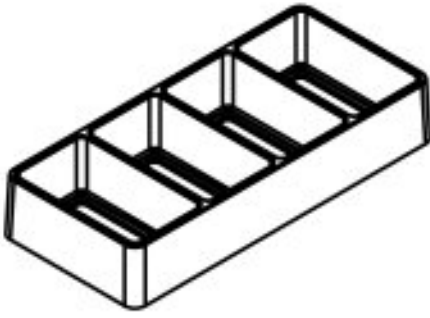

Imaging Chamber  
Imaging Chamber CG

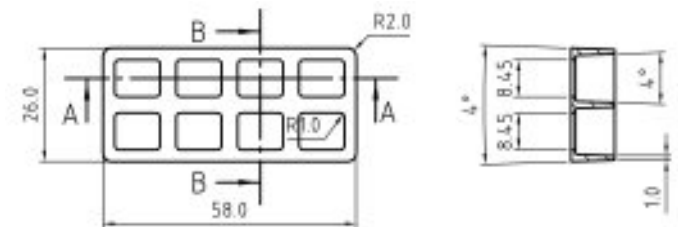
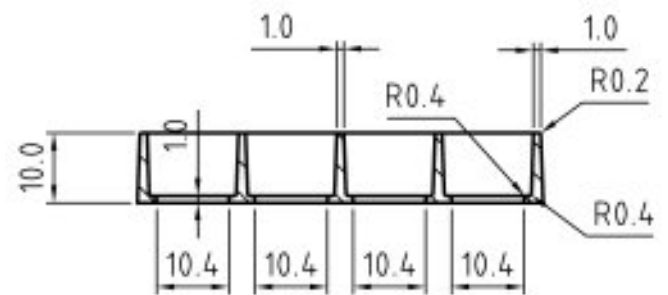
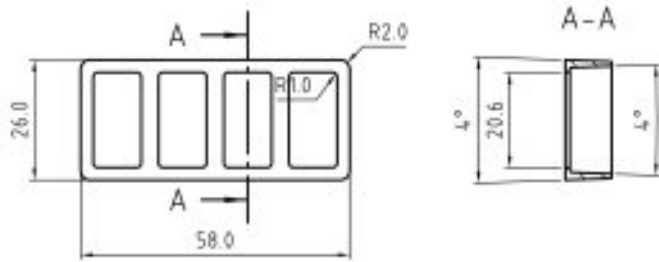
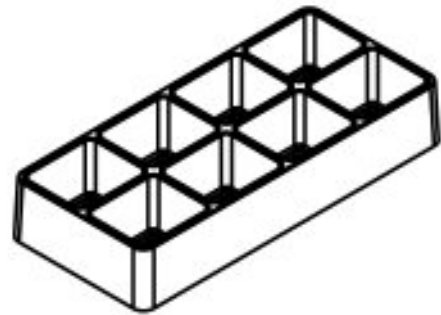
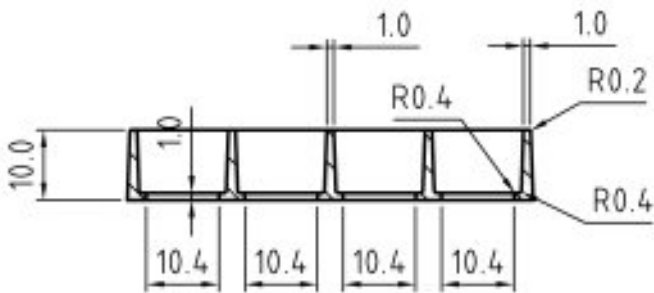

## Related articles

Art. No.	Product	Art. No.	Product
8014	Imaging Chamber 4	8004	Imaging Chamber 4 CG
8018	Imaging Chamber 8	8008	Imaging Chamber 8 CG



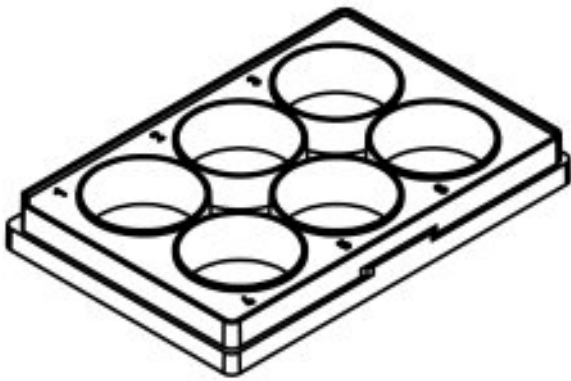

Imaging Plate 6

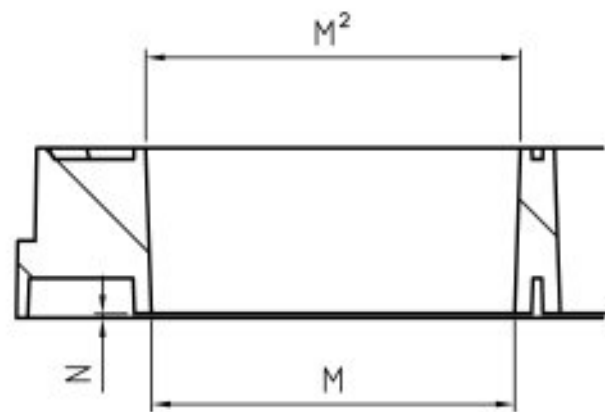
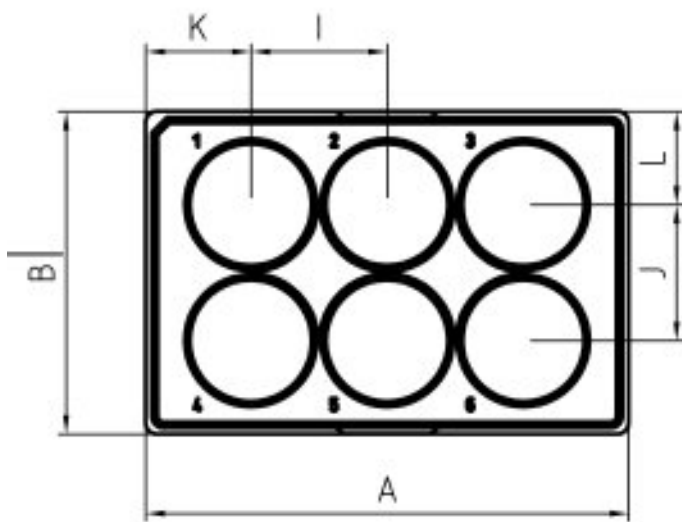
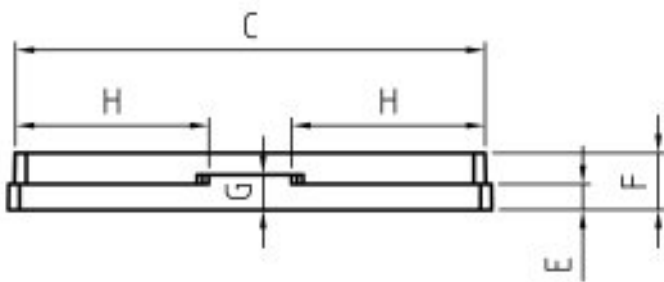

	A	B	C	D	E	F	G	H	I	J	K	L	M	M <sup>2</sup>	N
MM	127.76	85.48	124.2	82.0	6.8	15.0	9.3	51.2	36.0	36.0	27.88	24.74	∅32.0	∅33.0	0.4
INCH	5.030	3.365	4.890	3.228	0.268	0.591	0.366	2.016	1.417	1.417	1.098	0.974	∅1.26	∅1.30	0.016

## Related articles

Art. No.	Product	Art. No.	Product
3221	Imaging Plate 6 FC	5221	Imaging Plate 6 CG 1.0
		5222	Imaging Plate 6 CG 1.5

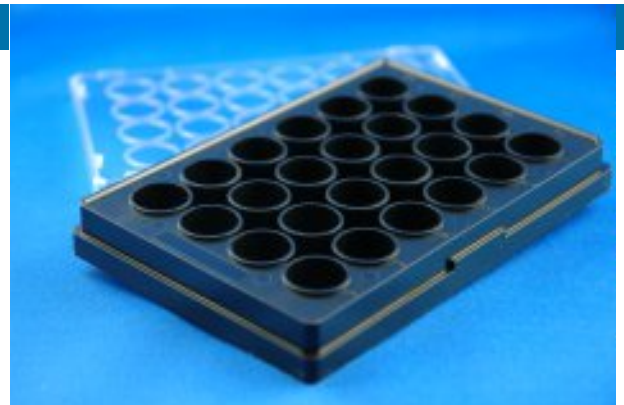
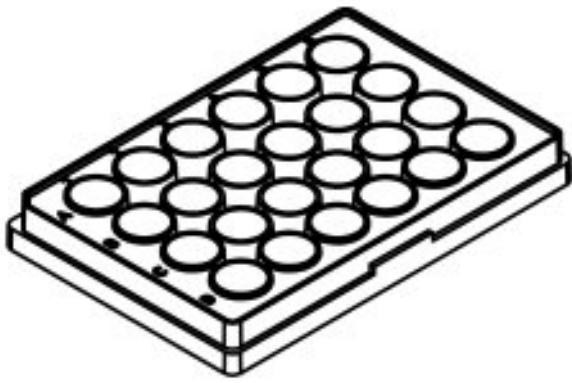

Imaging Plate 24

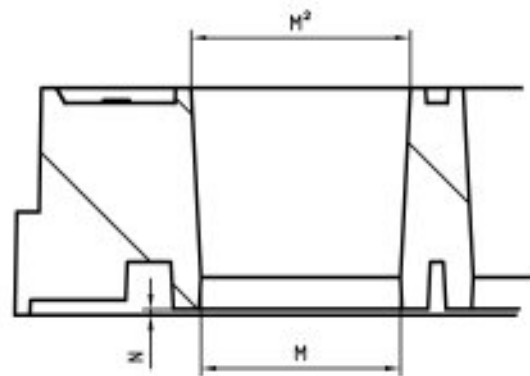
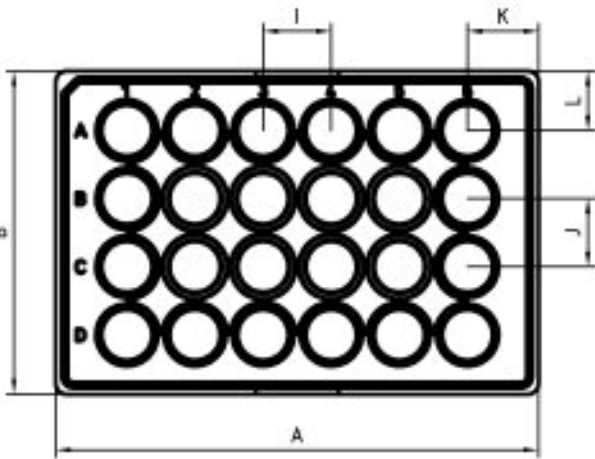
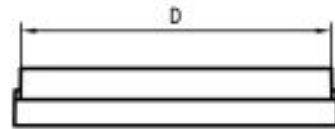
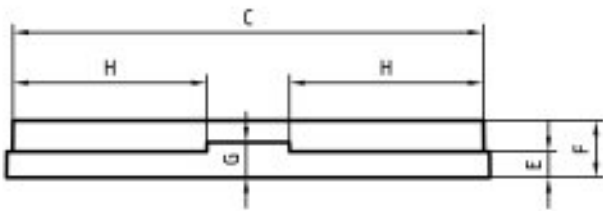

	A	B	C	D	E	F	G	H	I	J	K	L	M	M <sup>2</sup>	N
MM	127.76	85.48	124.2	82.0	6.8	15.0	9.3	51.2	18.0	18.0	18.88	15.74	∅13.2	∅14.5	0.4
INCH	5.030	3.365	4.890	3.228	0.268	0.591	0.366	2.016	0.709	0.709	0.743	0.620	∅0.520	∅0.571	0.016

### Related articles

Art. No.	Product	Art. No.	Product
3231	Imaging Plate 24 FC	5231	Imaging Plate 24 CG 1.0
		5232	Imaging Plate 24 CG 1.5

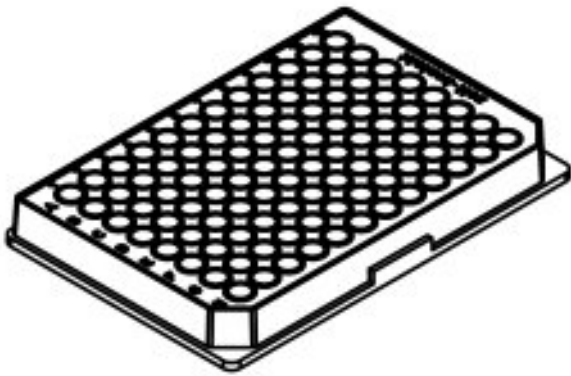

## Imaging Plate 96

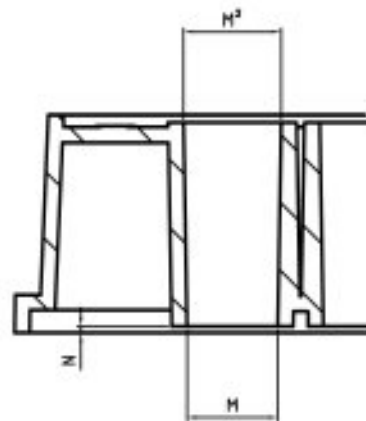
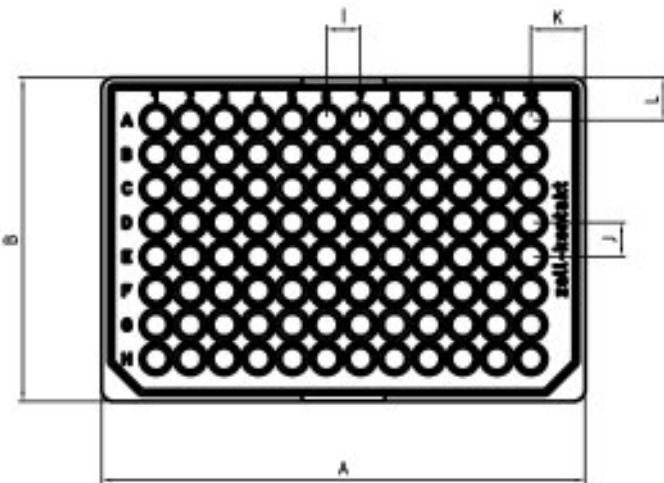
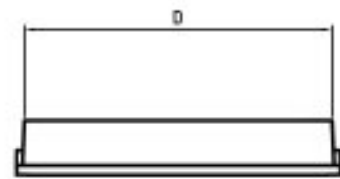
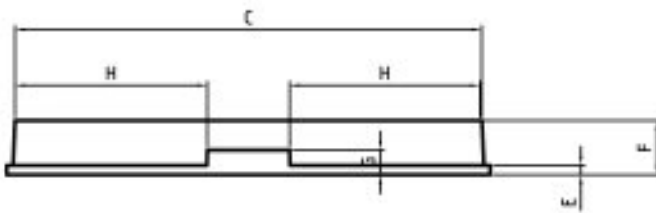

	A	B	C	D	E	F	G	H	I	J	K	L	M	M <sup>2</sup>	N
MM	127.76	85.48	123.3	81.2	2.5	14.35	6.5	50.3	9.0	9.0	14.38	11.24	∅6.0	∅6.5	0.4
INCH	5.030	3.365	4.854	3.197	0.098	0.565	0.256	1.98	0.354	0.354	0.566	0.443	∅0.236	∅0.256	0.016

### Related articles

Art. No.	Product	Art. No.	Product	Art. No.	Product
3241	Imaging Plate 96 FC	5241	Imaging Plate 96 CG 1.0	2145	UV Plate
		5242	Imaging Plate 96 CG 1.5	2146	UV Plate, black body

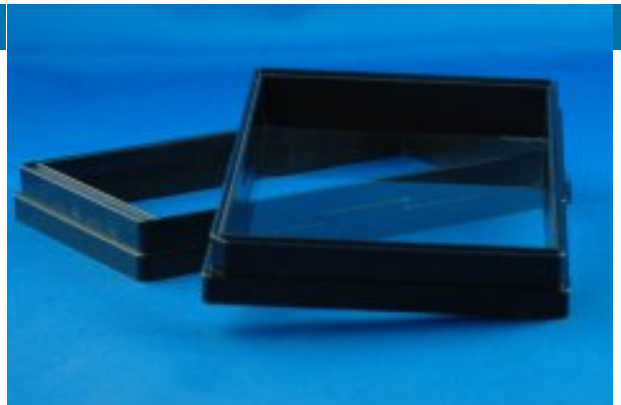
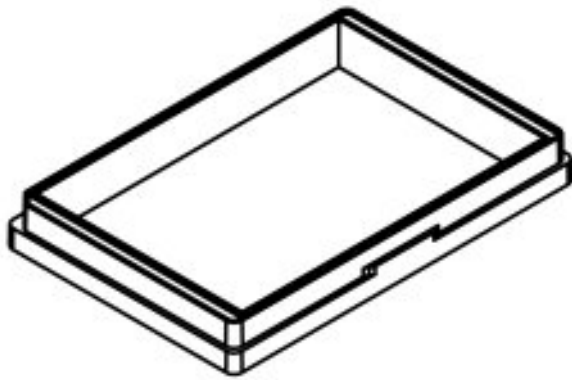

Array Plate

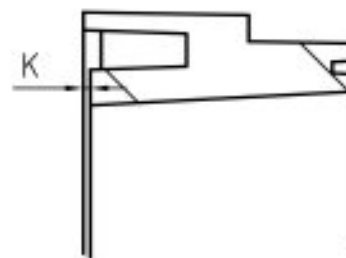
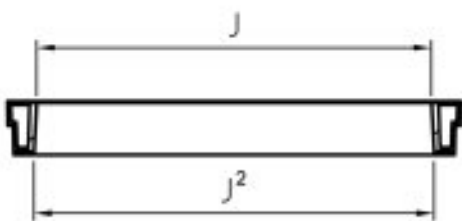
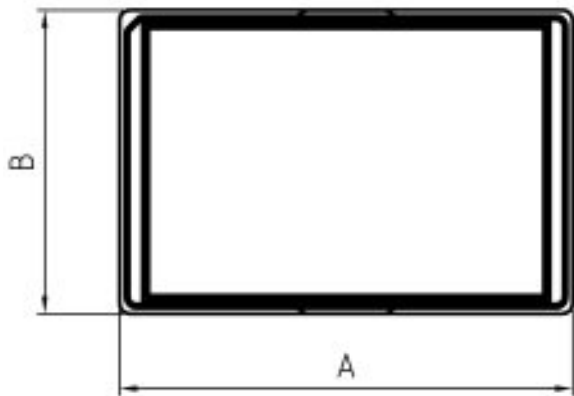
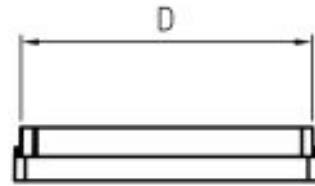
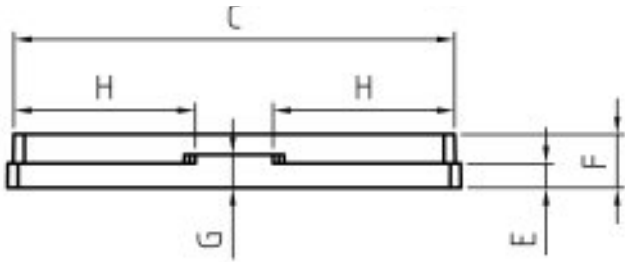

	A	B	C	D	E	F	G	H	I	I <sup>2</sup>	J	J <sup>2</sup>	K
MM	127.76	85.48	124.0	82.0	6.8	15.0	9.3	51.2	75.0	76.53	111.0	112.53	0.4
INCH	5.030	3.365	4.882	3.228	0.268	0.591	0.366	2.016	2.953	3.013	4.37	4.43	0.016

### Related articles

Art. No.	Product
5212	Array Plate



Art.No.	Product	Items/Sales Unit
2145-40	UV Plate 96	40
2146-40	UV Plate 96, black plate body	40
5160-30	Imaging Dish 35mm CG 1.0	30
5160-168	Imaging Dish 35mm CG 1.0	168
6160-30	Imaging Dish 35mm CG 1.5	30
6160-168	Imaging Dish 35mm CG 1.5	168
7160-30	Imaging Dish 35mm CG 1.5 $\mu$ Grid	30
7160-168	Imaging Dish 35mm CG 1.5 $\mu$ Grid	168
9001-1	Imaging Dish Stage Frame, single	1
9002-1	Imaging Dish Stage Frame, double	1
8001-16	Imaging Chamber 1 CG	16
8001-80	Imaging Chamber 1 CG	80
8002-16	Imaging Chamber 2 CG	16
8002-80	Imaging Chamber 2 CG	80
8004-16	Imaging Chamber 4 CG	16
8004-80	Imaging Chamber 4 CG	80
8008-16	Imaging Chamber 8 CG	16
8008-80	Imaging Chamber 8 CG	80
8011-16	Imaging Chamber 1	16
8011-80	Imaging Chamber 1	80
8012-16	Imaging Chamber 2	16
8012-80	Imaging Chamber 2	80
8014-16	Imaging Chamber 4	16
8014-80	Imaging Chamber 4	80
8018-16	Imaging Chamber 8	16
8018-80	Imaging Chamber 8	80
8100-4	Imaging Chamber DIC Lid	4
8200-1	Imaging Chamber CG adapter	1
3221-20	Imaging Plate 6 FC	20
3231-20	Imaging Plate 24 FC	20
3241-20	Imaging Plate 96 FC	20
5221-20	Imaging Plate 6 CG 1.0	20
5222-20	Imaging Plate 6 CG 1.5	20
5231-20	Imaging Plate 24 CG 1.0	20
5232-20	Imaging Plate 24 CG 1.5	20
5241-20	Imaging Plate 96 CG 1.0	20
5242-20	Imaging Plate 96 CG 1.5	20
5212-4	Array Plate	4

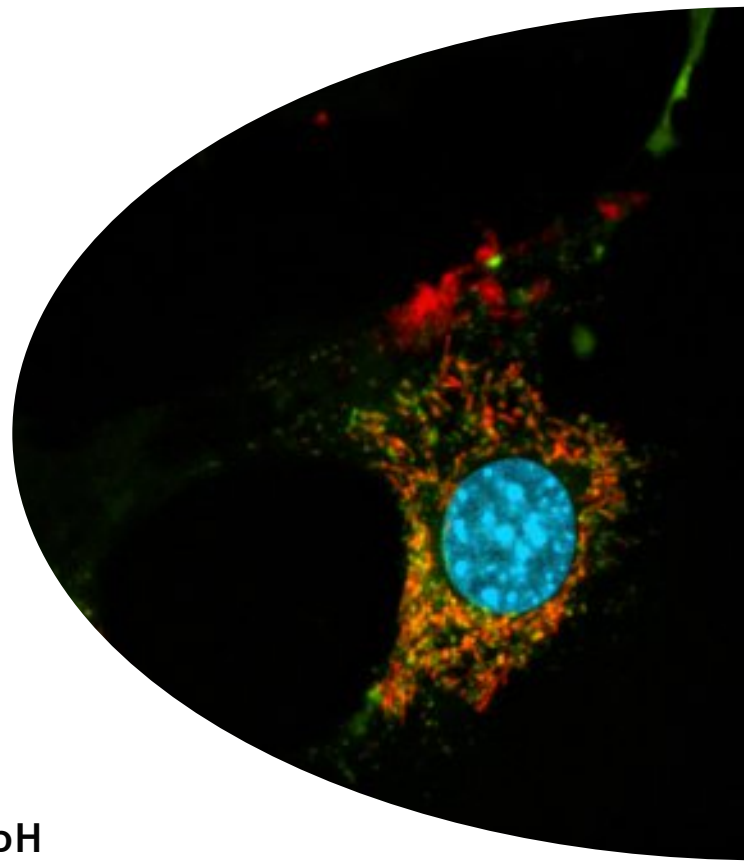

**zell-kontakt GmbH**  
Industriestraße 3  
37176 Nörten-Hardenberg  
Germany

**phone: ++49 (0)5503 91599 33**

**fax: ++49 (0)5503 91599 34**

**email: [info@zell-kontakt.de](mailto:info@zell-kontakt.de)**  
**[www.zell-kontakt.de](http://www.zell-kontakt.de)**

