

Chirurgische Instrumente Hauptkatalog

Surgical Instruments General Catalogue

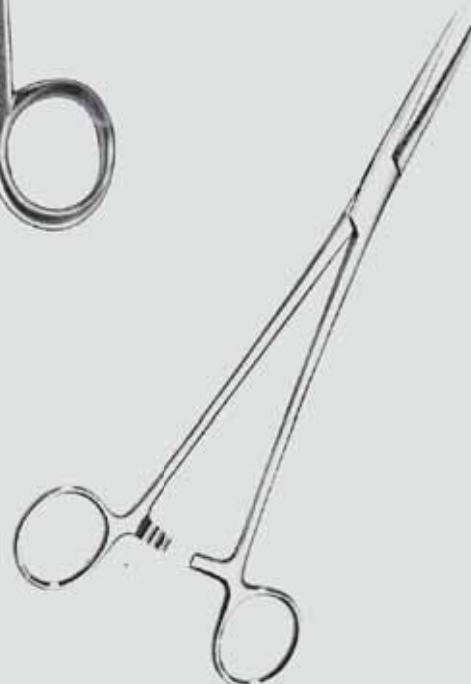

Arterienklemmen
Artery Forceps

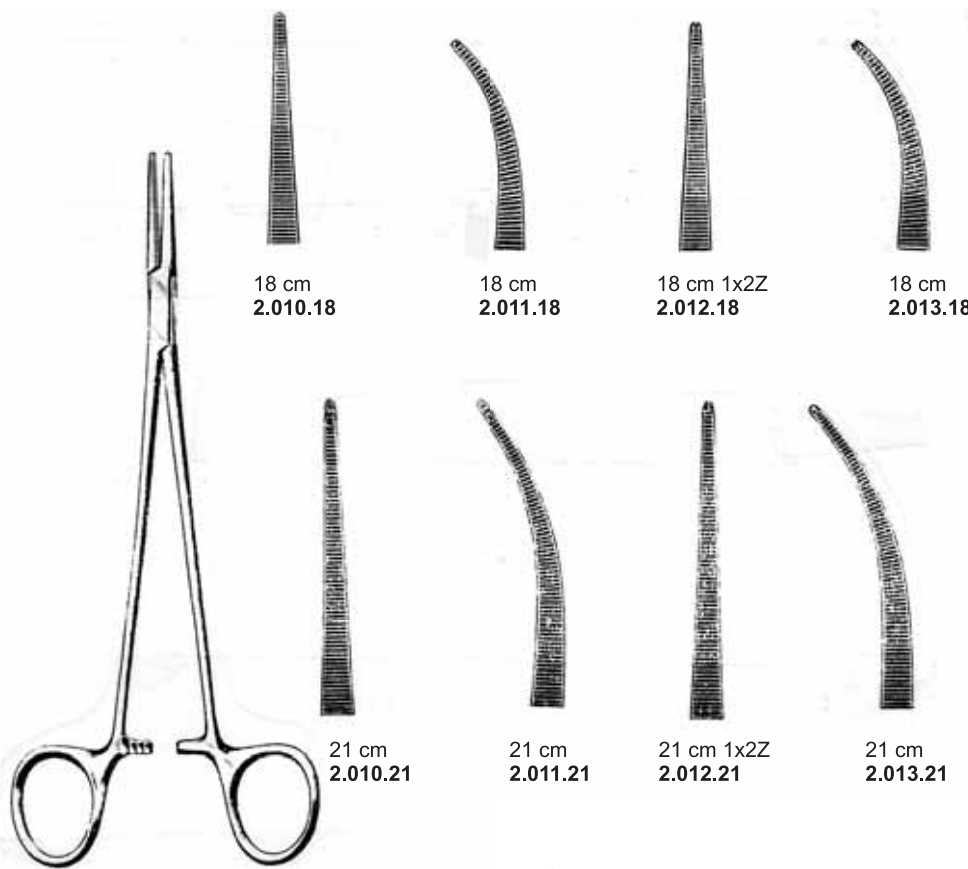

HALSTED MOSQUITO

Arterienklemmen
Artery Forceps

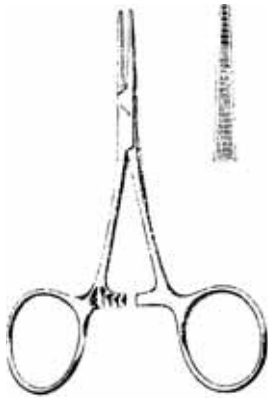

2.000.10

HARTMANN - KLEMME
10 cm



2.001.10

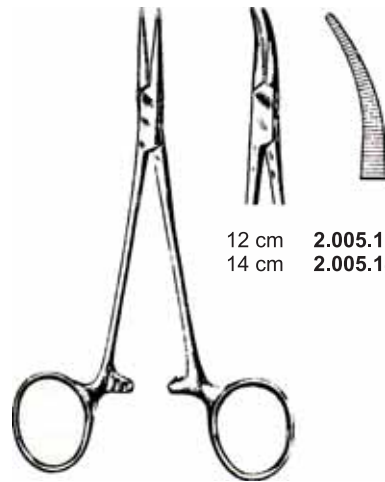

12 cm
14 cm

2.005.12
2.005.14

HALSTED MOSQUITO

12 cm 2.004.12
14 cm 2.004.14



HALSTED MOSQUITO 1x2Z

12 cm 2.006.14
14 cm 2.006.14



12 cm 2.007.12
14 cm 2.007.14

**Arterienklemmen
Artery Forceps**

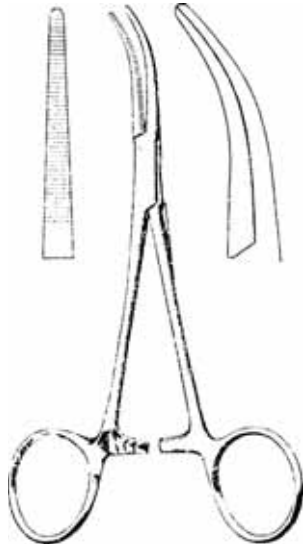

DANDY 14 cm
2.017.14

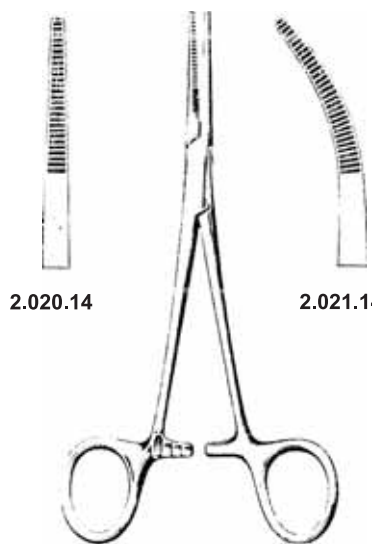

2.020.14 2.021.14

KELLY 16 cm

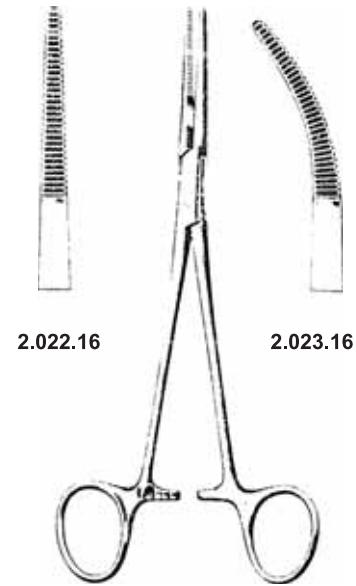

2.022.16 2.023.16

KELLY-RANKIN 16 cm



PEAN
13 cm 2.024.13
14 cm 2.024.14
16 cm 2.024.16

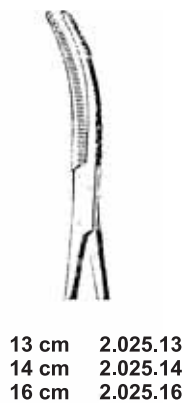

13 cm 2.025.13
14 cm 2.025.14
16 cm 2.025.16

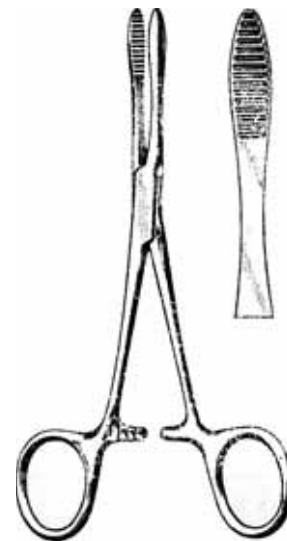

PEAN kurz fassend
14 cm 2.026.14
16 cm 2.026.16

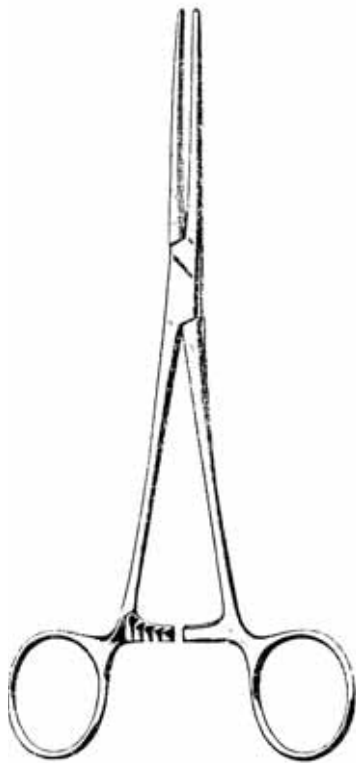
**Arterienklemmen
Artery Forceps****ROCHESTER PEAN**

14 cm	2.028.14
16 cm	2.028.16
18 cm	2.028.18
20 cm	2.028.20
22 cm	2.028.22
24 cm	2.028.24
26 cm	2.028.26
30 cm	2.028.30

**ROCHESTER PEAN**

14 cm	2.029.14
16 cm	2.029.16
18 cm	2.029.18
20 cm	2.029.20
22 cm	2.029.22
24 cm	2.029.24
26 cm	2.029.26
30 cm	2.029.30

**KOCHER KLEMME fein**

13 cm	2.032.13
14 cm	2.032.14



13 cm	2.033.13
14 cm	2.033.14

Arterienklemmen Artery Forceps

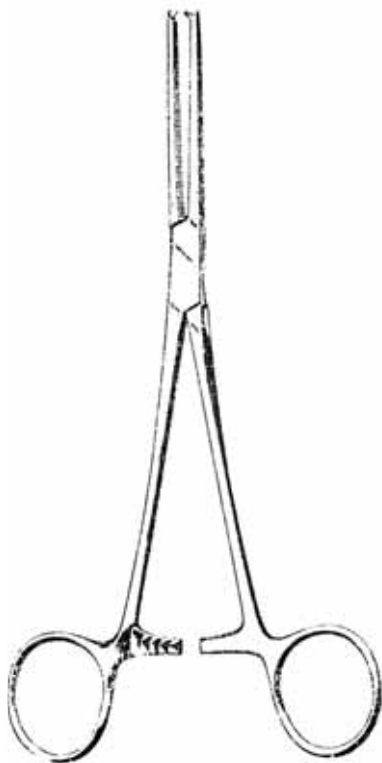

OCHSNER KOCHER



14 cm 2.036.14
16 cm 2.036.16
18 cm 2.036.18
20 cm 2.036.20
22 cm 2.036.22
24 cm 2.036.24
26 cm 2.036.26
30 cm 2.036.30

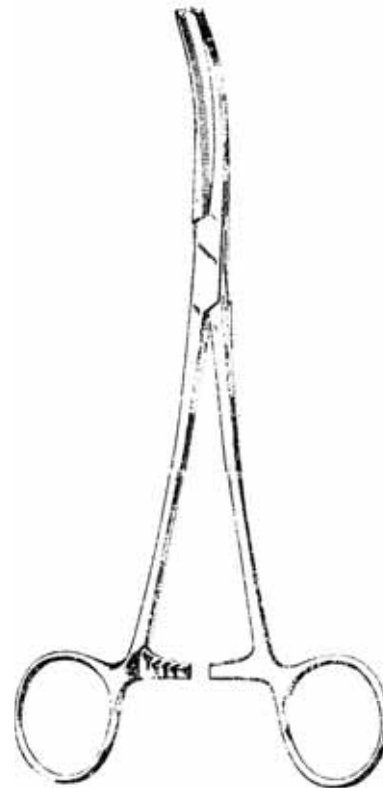

OCHSNER KOCHER



14 cm 2.037.14
16 cm 2.037.16
18 cm 2.037.18
20 cm 2.037.20
22 cm 2.037.22
24 cm 2.037.24
26 cm 2.037.26
30 cm 2.037.30

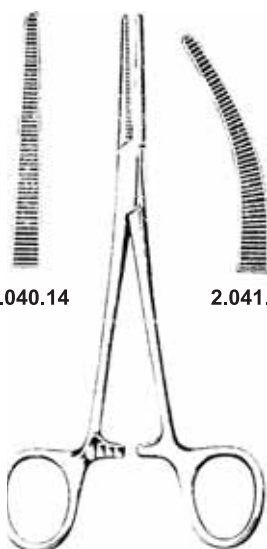

2.040.14

2.041.14

CRILE 14 cm

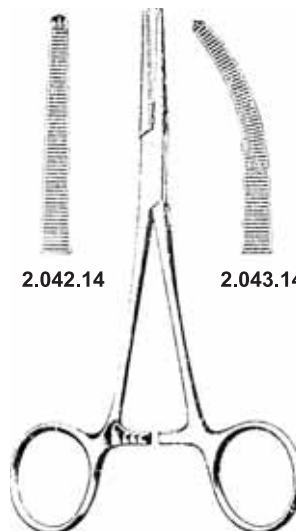

2.042.14

2.043.14

CRILE 14 cm 1x2Z

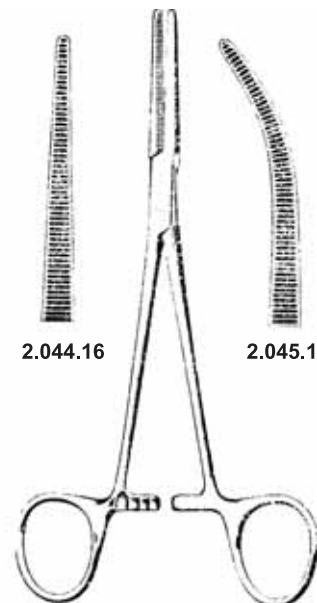

2.044.16

2.045.16

CRILE RANKIN 16 cm

Arterienklemmen Artery Forceps

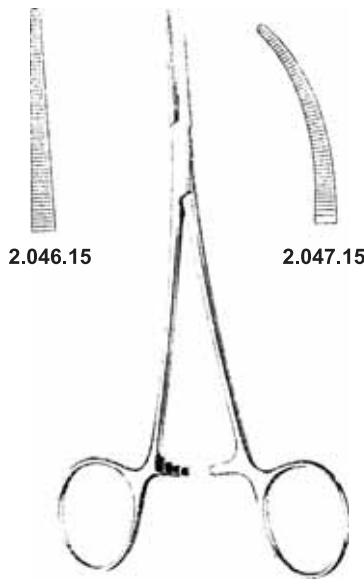

2.046.15

2.047.15

LERICHE 15 cm

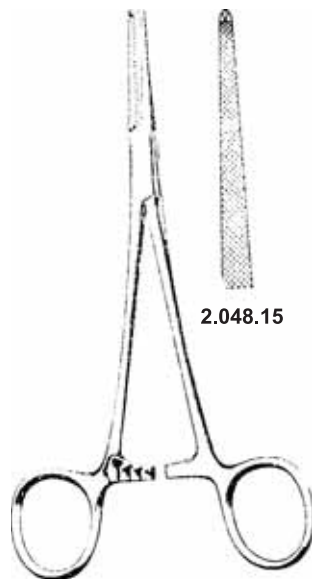

2.048.15

LOVELACE 15 cm 1x2Z

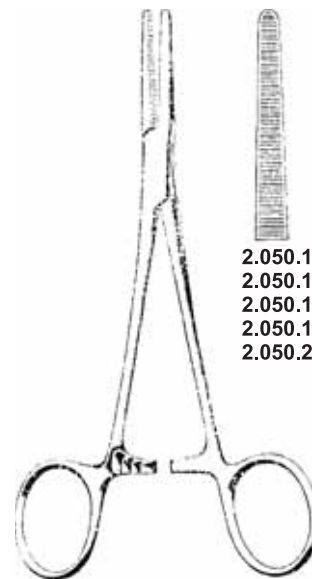

2.050.13
2.050.14
2.050.15
2.050.18
2.050.20

13 cm
14 cm
15 cm
18 cm
20 cm

2.051.13
2.051.14
2.051.15
2.051.18
2.051.20

SPENCER WELLS

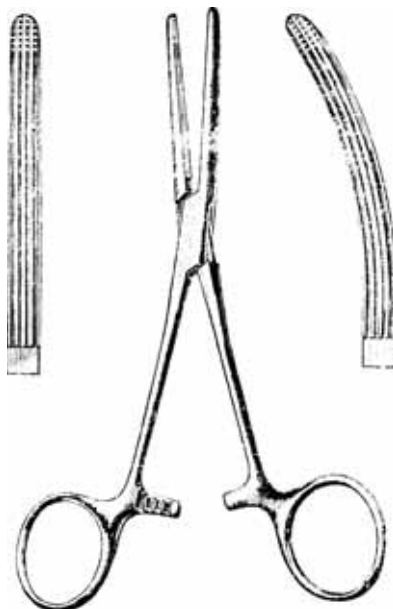

ROCHESTER CARMALT

2.054.16
2.054.20

16 cm
20 cm

2.055.16
2.055.20



ADSON

2.064.18

18,5 cm

2.065.18

Arterien-, Präparier- und Ligaturklemmen
Artery, Dissectin and Ligature Forceps

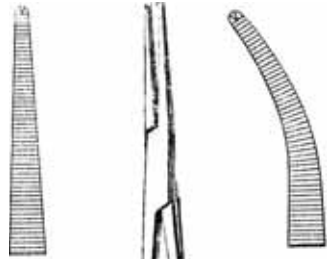

2.066.18

2.067.18

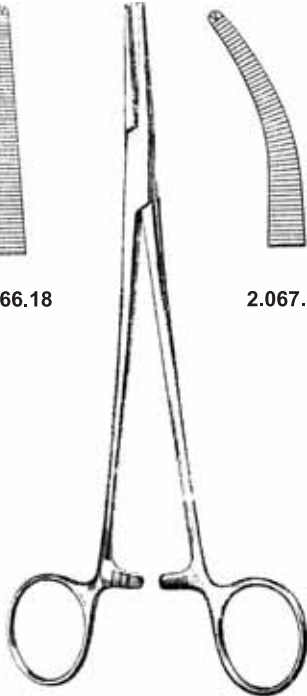

ADSON 18 cm 1x2Z

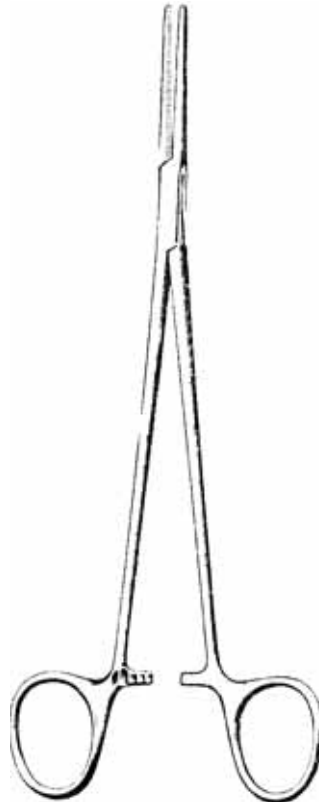

HEISS KLEMME 20 cm



FIG. 1
2.070.20



FIG. 2
2.072.20



FIG. 3
2.073.20

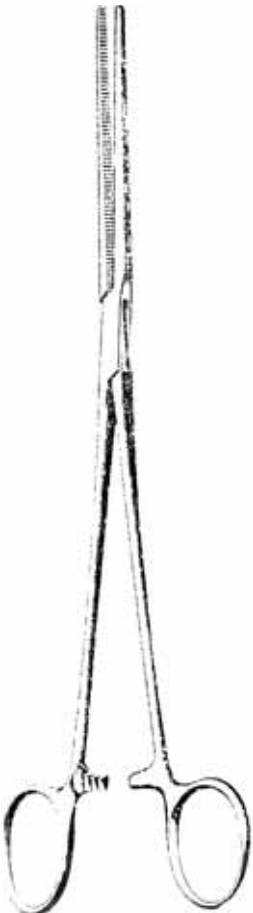

SAROT KLEMME 24 cm



2.076.24



2.077.24



2.078.22



2.079.22

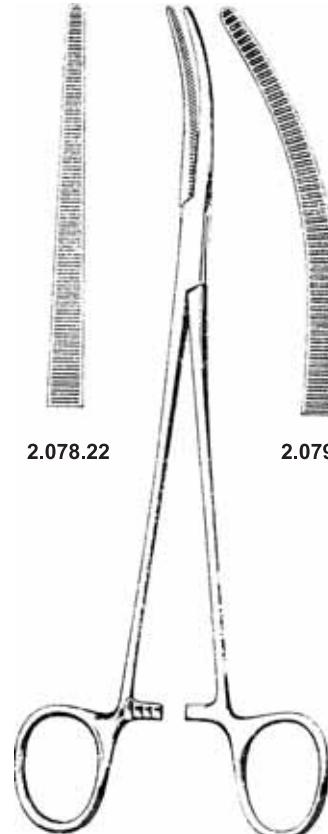

ROBERT KLEMME 22 cm

Arterien-, Präparier- und Ligaturklemmen
Artery, Dissectin and Ligature Forceps



2.081.24

CRANDORD KLEMME 24 cm



OVERHOLT-GEISSENDÖRFER 21 cm



FIG. 1
2.091.21



FIG. 2
2.093.21



FIG. 3
2.095.21



FIG. 4
2.097.21



FIG. 5
2.099.21

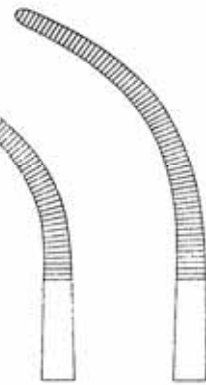

FIG. 6
2.101.21

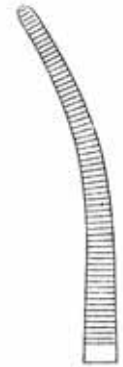
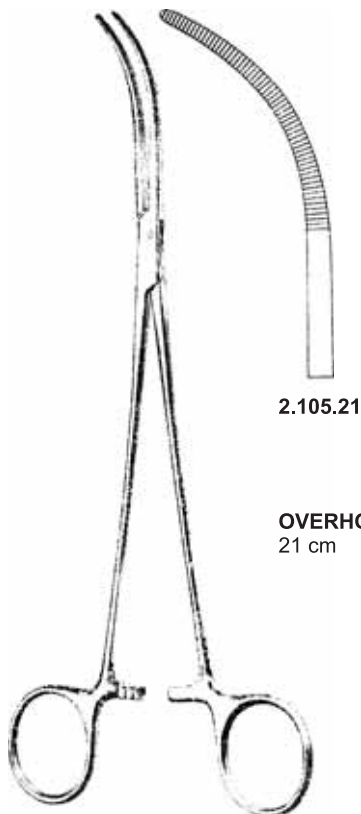

FIG. 7
2.103.21



2.105.21

OVERHOLT-MIXTER KLEMME
21 cm

Arterien-, Präparier- und Ligaturklemmen
Artery, Dissectin and Ligature Forceps



RUMEL Klemme
23 cm



FIG.1
2.111.23



FIG.2
2.113.23



FIG.3
2.115.23



FIG.4
2.117.23

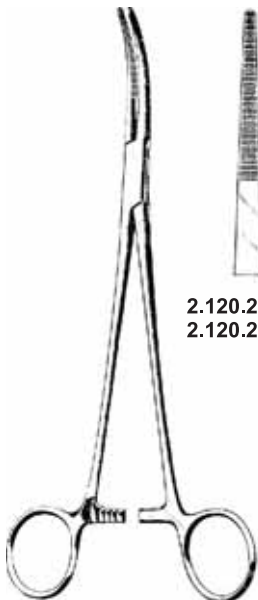

TÖNNIS Klemme

2.120.21 21 cm
2.120.26 26 cm



2.121.21
2.121.26

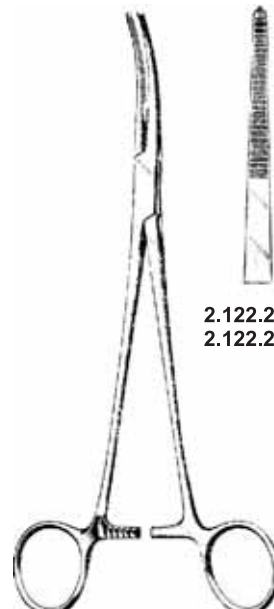

TÖNNIS Klemme
1x2 Z

2.122.21 21 cm
2.122.26 26 cm



2.123.21
2.123.26

Arterien- und Bronchusklemmen, Gallenkanalklemmen
Artery Forceps, Bronchus and Gall Duct Clamps

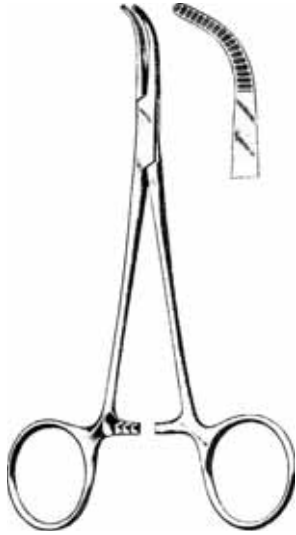

BABY-MIXTER
14 cm 2.125.14



MIXTER
15,5 cm 2.127.15
19 cm 2.127.19

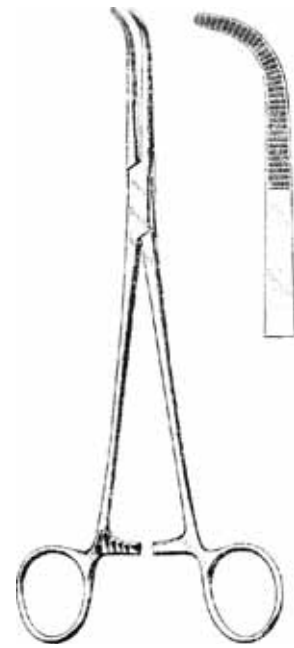

MIXTER
22 cm 2.129.22

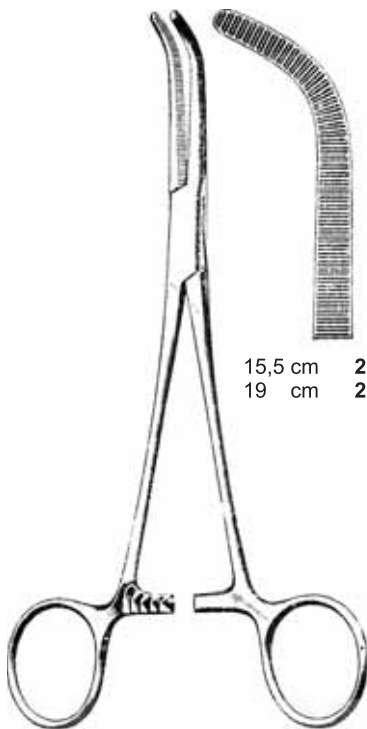

15,5 cm 2.131.15
19 cm 2.131.19

MIXTER O SHAUGNESSY



MIXTER

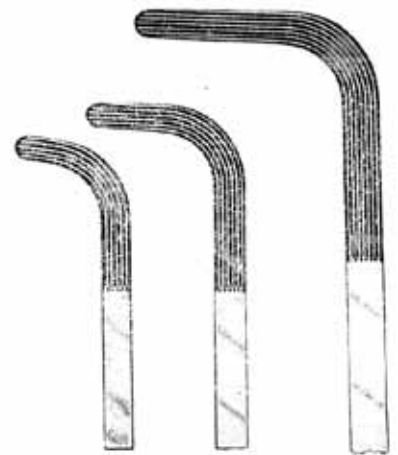
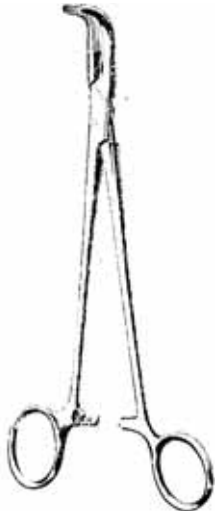

FIG.1 FIG.2 FIG.3

FIG.1 22 cm 2.135.22
FIG.2 25 cm 2.135.25
FIG.3 28 cm 2.135.28

Arterien-, Gallenkanal- und Nierenstielklemmen
Artery Forceps, Gall Duct and Kidney Pedicle Clamps



LOWER
18 cm 2.145.18

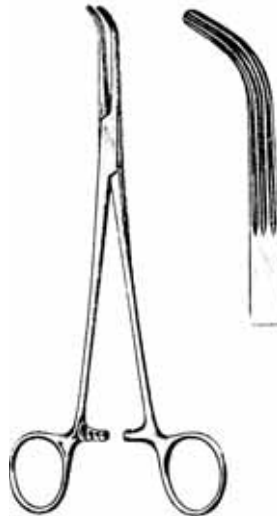

LAHEY
19 cm 2.149.19



LAHEY
23 cm 2.149.23

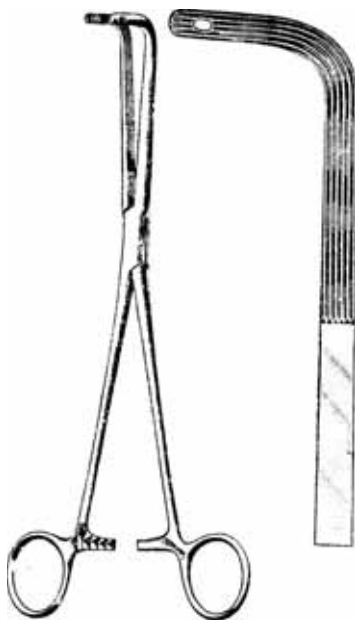

FINICCHIETTO
24 cm 2.153.24

Nierenstielklemmen
Kidney Pedicle Clamps

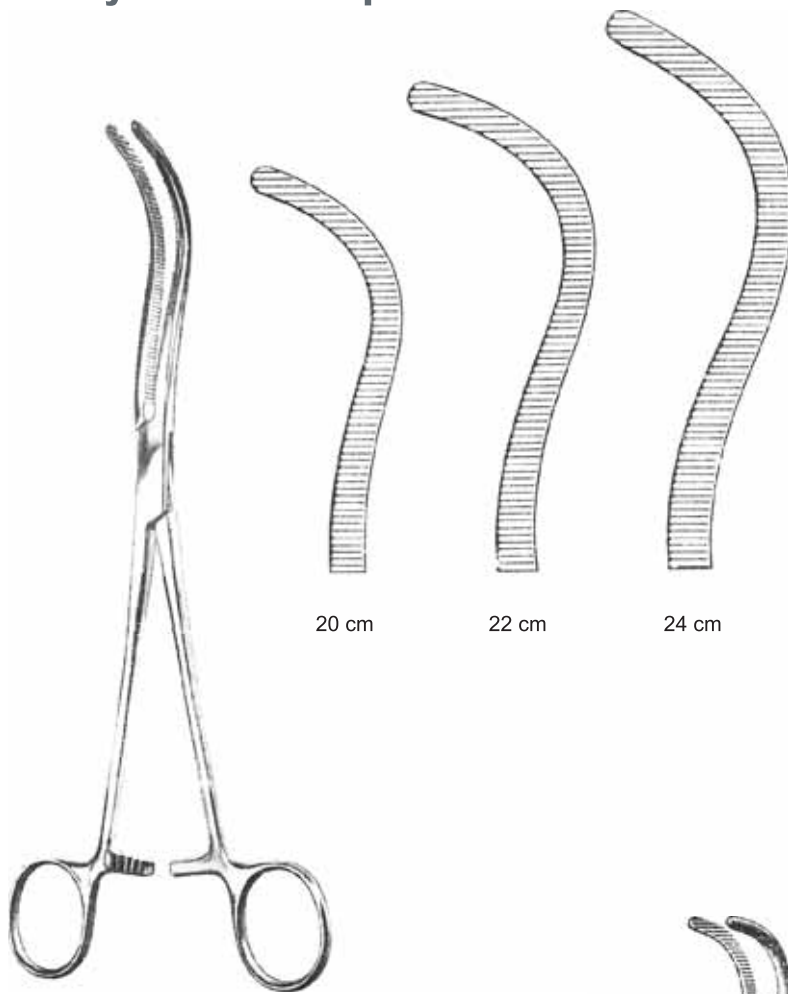

20 cm

22 cm

24 cm

GUYON

- 20 cm **2.161.20**
- 22 cm **2.161.22**
- 24 cm **2.161.24**

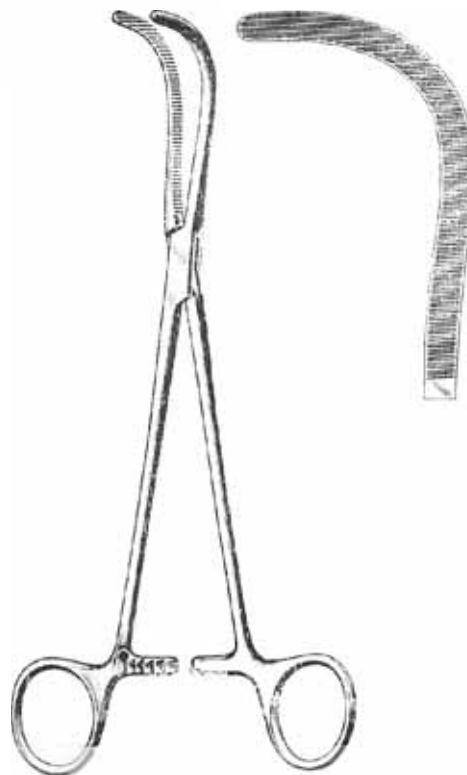

GUYON

- 23 cm **2.163.23**

Gallenkanal- und Nierenstielklemmen
Gall Duct and Kidney Pedicle Clamps

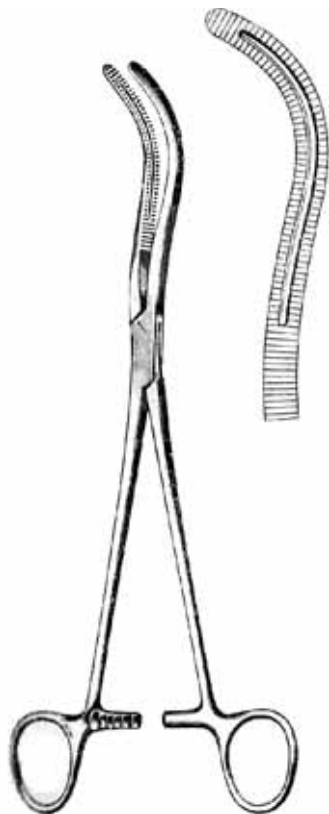

STILLE
23 cm 2.165.23

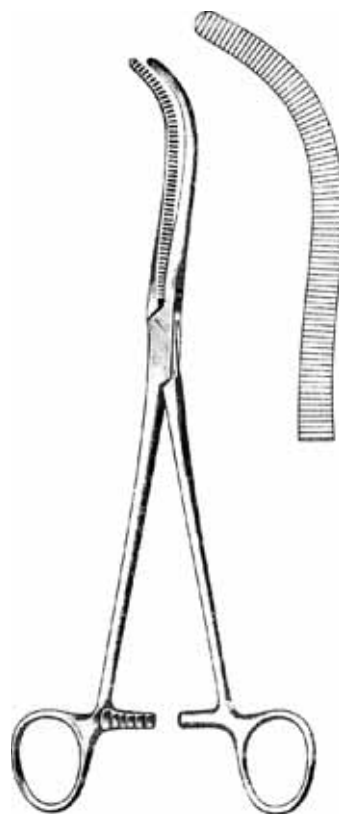

MAYO
23 cm 2.167.23

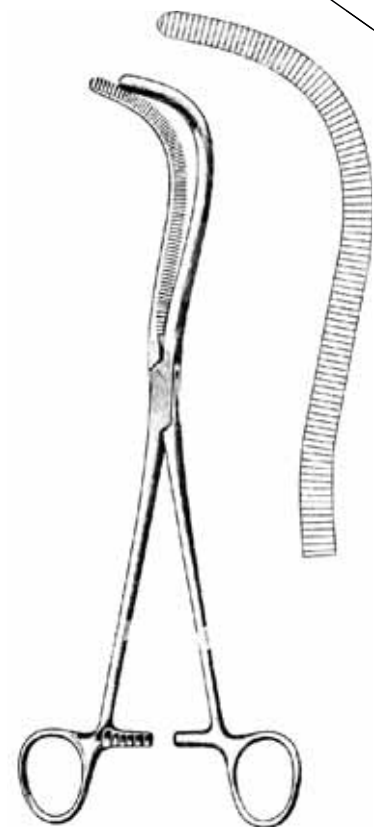

MAYO GUYON
23 cm 2.169.23

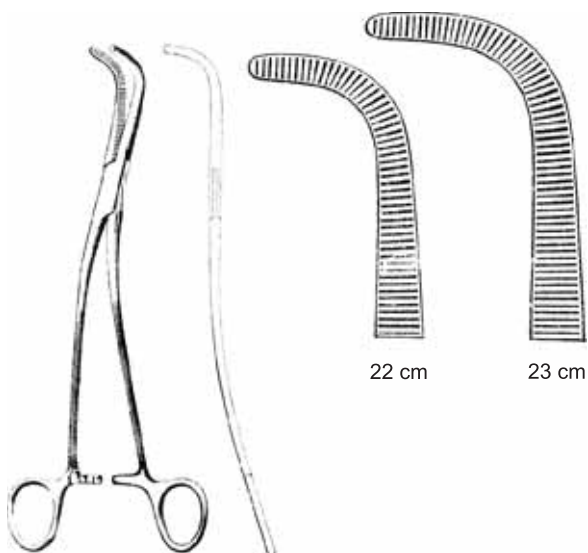

GRAY
22 cm 2.173.22
23 cm 2.173.23

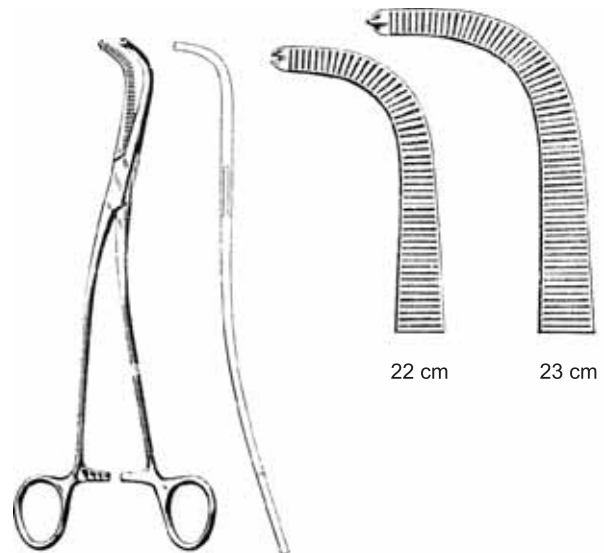

GRAY 1x2 Z
22 cm 2.175.22
23 cm 2.175.23

Gallenkanalklemmen, Klemmzangen
Gall Duct Clamps, Clamp Forceps



DESJARDINS
21 cm 2.177.21



DESJARDINS
21 cm 2.179.21

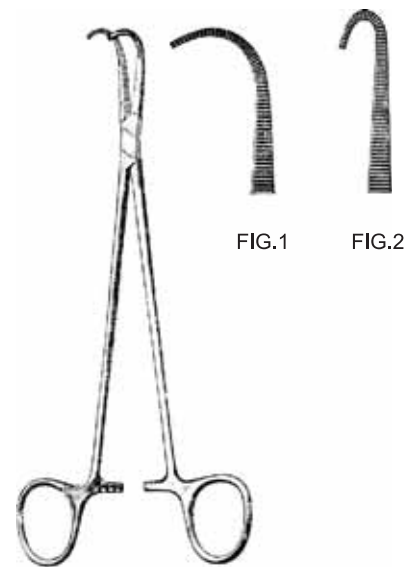

NEGUS 19 cm
FIG.1 2.183.19
FIG.2 2.185.19

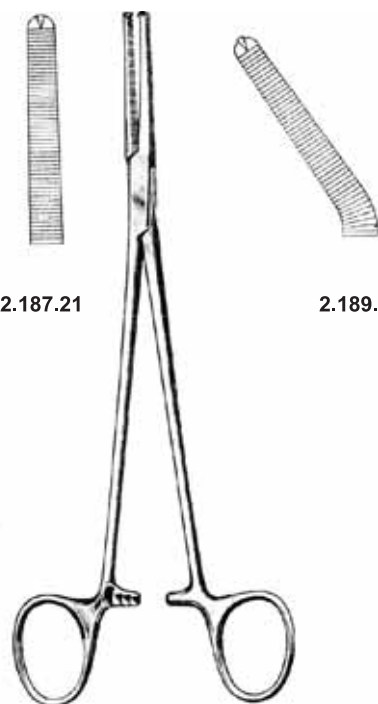

2.187.21

2.189.21

PHANEUF 1x2 Z
21,5 cm



HEANEY
19,5 cm 2.195.19
21 cm 2.195.21
23 cm 2.195.23



19,5 cm 2.197.19
21 cm 2.197.21
23 cm 2.197.23

Klemmzangen
Clamp Forceps



WERTHEIM
25 cm 2.201.25

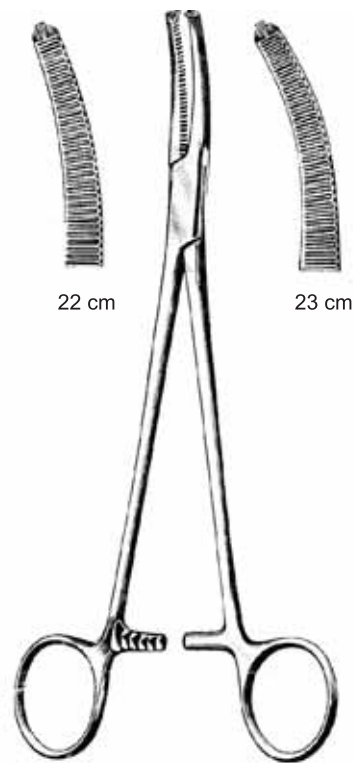

WERTHEIM 1x2 Z
22 cm 2.205.22
23 cm 2.205.23



WERTHEIM-CULLEN
21,5 cm 2.209.21

Klemmzangen, Hysterektomie- und Peritoneumklemmen
Clamp Forceps, Hysterectomy- and Peritoneal Forceps

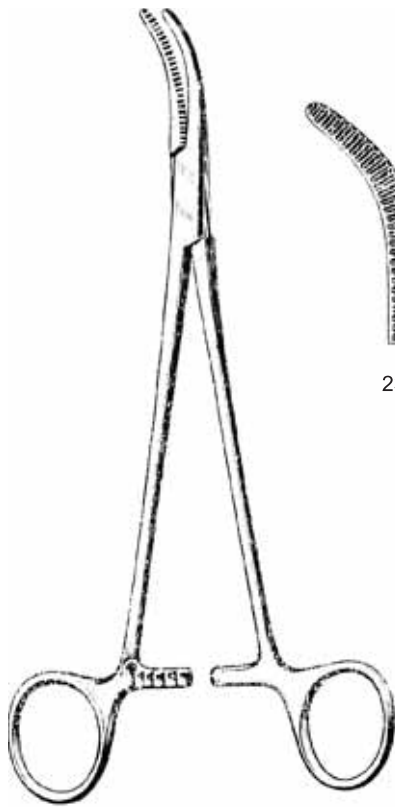

23 cm



24 cm

MOYNIHAN

23 cm 2.211.23
24 cm 2.211.24

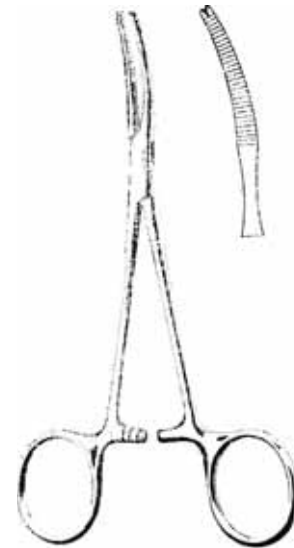

BABY-MIKULICZ

14 cm 2.221.14

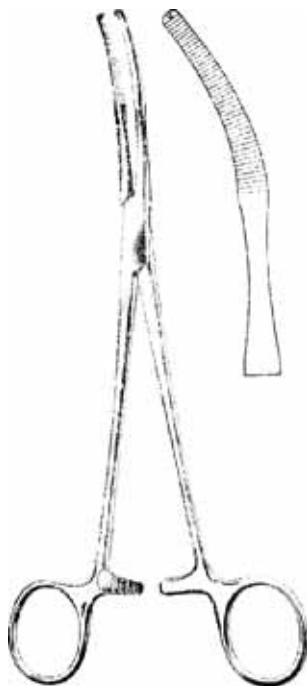

MIKULICZ 1x2 Z
20 cm 2.225.20



leicht geb.
2.227.20

stark geb.
2.229.20

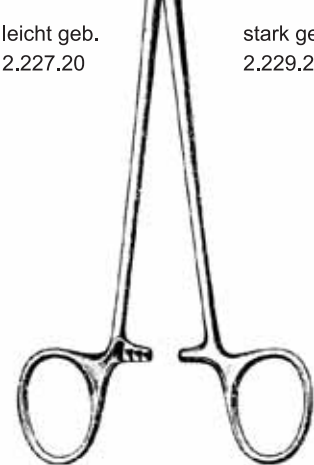

FAURE 1x2 Z
20 cm

Tuchklemmen und Tupferzangen Towel Forceps and Cotton Swab Forceps

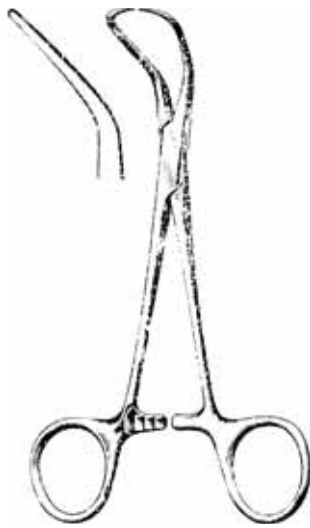

BACKHAUS
8 cm 2.251.08
11 cm 2.251.11
13 cm 2.251.13
15 cm 2.251.15

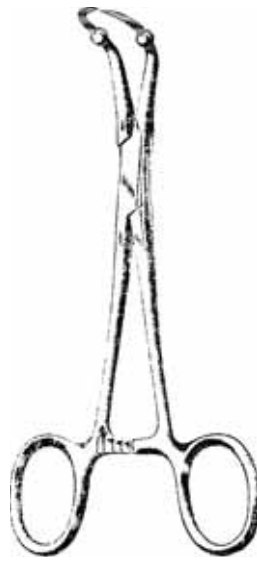

RÖDER
13 cm 2.255.13
15 cm 2.255.15

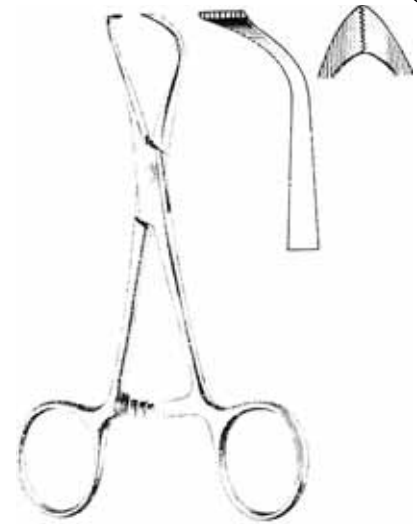

LORNA
10 cm 2.257.10
13 cm 2.257.13

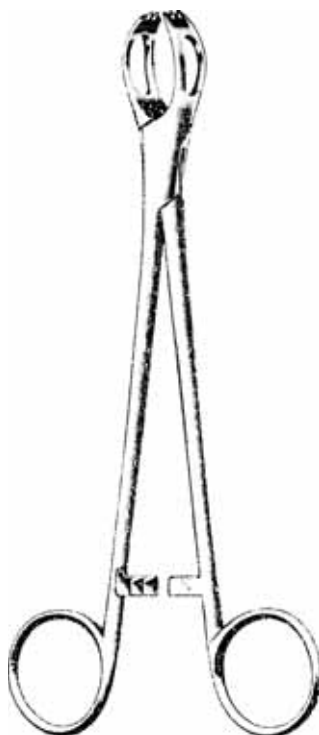

LANE
20 cm 2.259.20

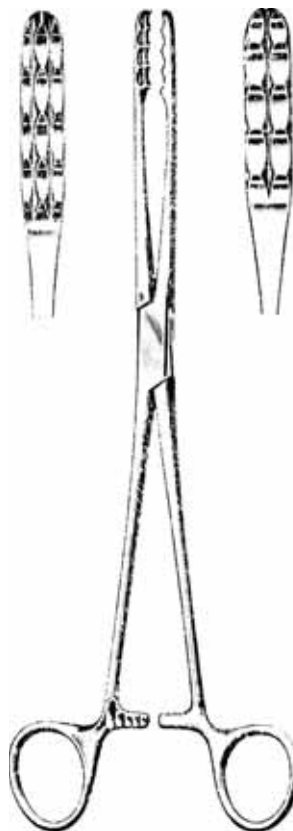

ULRICH
22 cm 2.280.22
25 cm 2.280.25

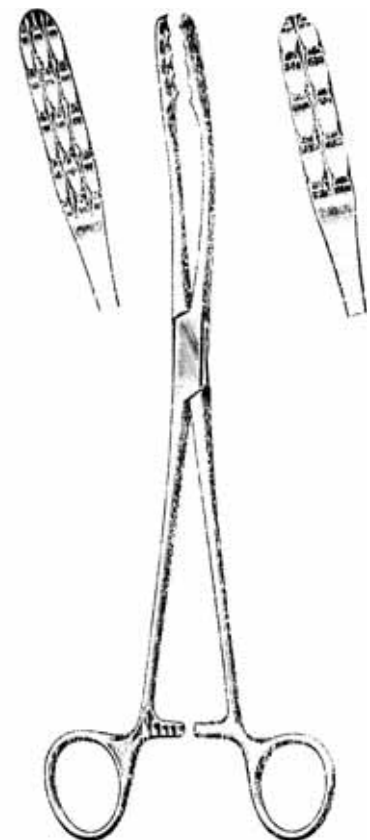

ULRICH
22 cm 2.281.22
25 cm 2.281.25

Kornzangen, Polypenzangen
Polypus and Dressing Forceps



GROSS mit Sperre

2.286.14	14 cm
2.286.20	20 cm
2.286.22	22 cm
2.286.25	25 cm

2.287.14
2.287.20
2.287.22
2.287.25

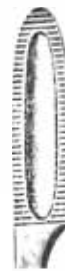

2.290.28

2.291.28

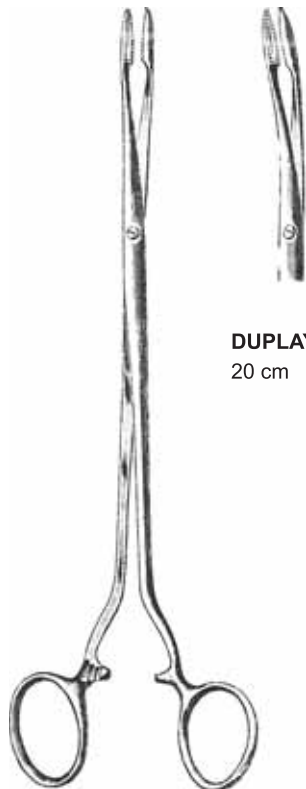

DUPLAY

20 cm **2.288.20**

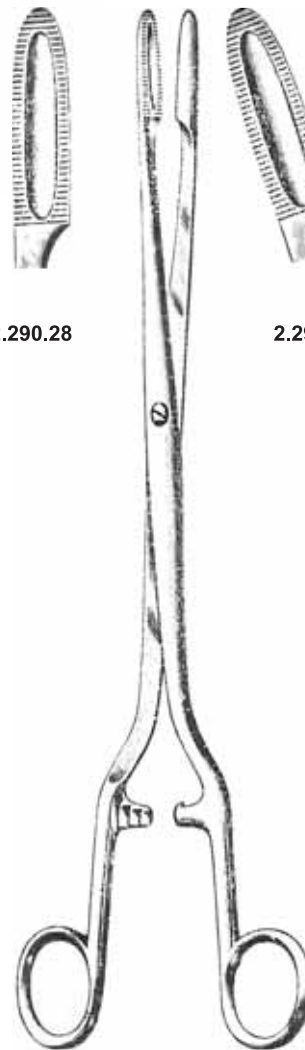

SIMS MAIER

28 cm

Korn- und Tupferzangen

Polypus and Dressing Forceps, Cotton Swab Forceps

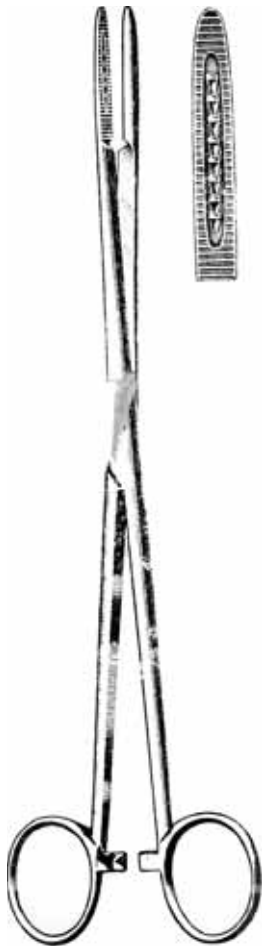

MAIER
25 cm 2.292.25



geb. 2.295.25

PELKMANN
25 cm 2.294.25

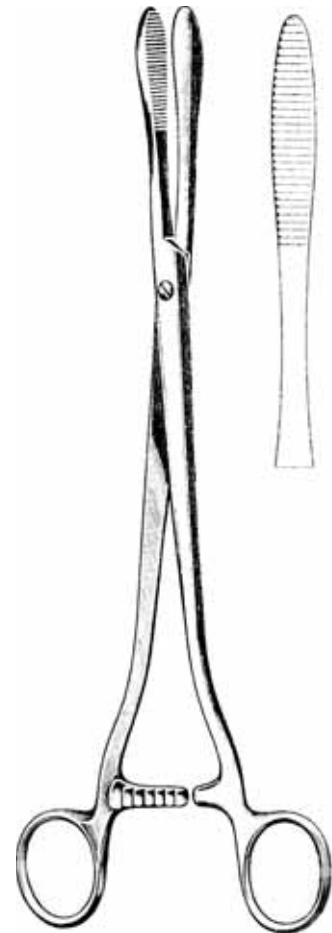

COLLIN
25 cm 2.296.25

Korn- und Tupferzangen

Polypus and Dressing Forceps, Cotton Swab Forceps

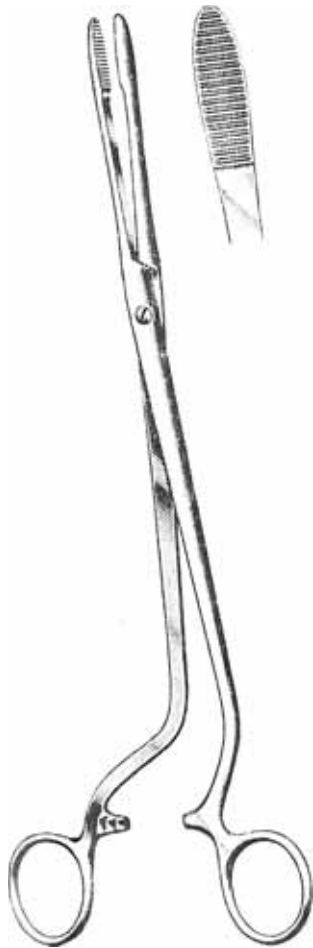

CHERON
25 cm 2.298.25

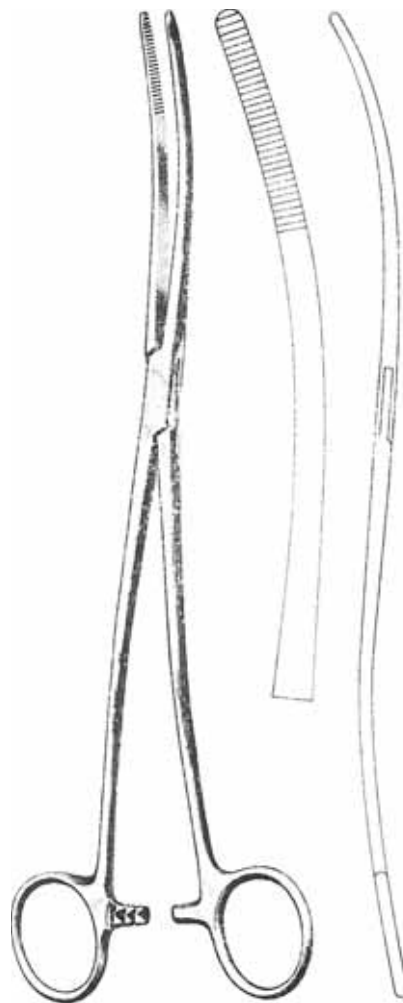

BOZEMANN
26 cm 2.301.26

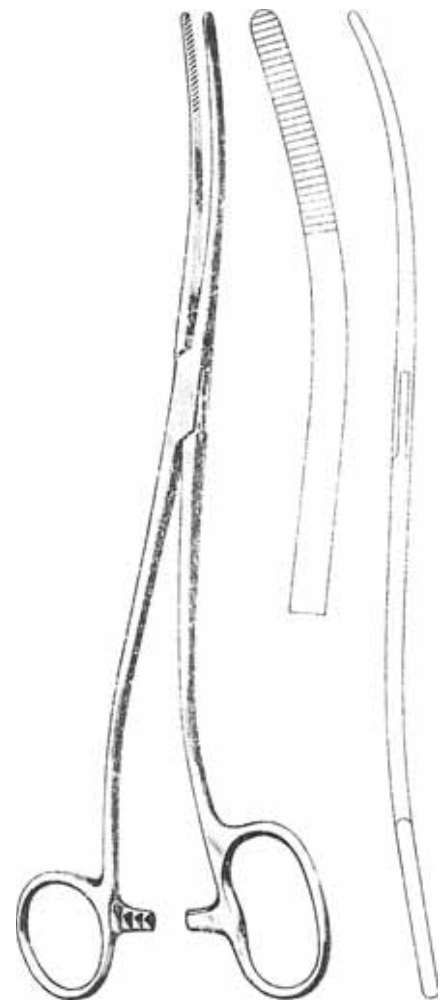

BOZEMANN DOUGLAS
26 cm 2.303.26

Tupfer- und Schwammzangen
Cotton Swab Forceps, Sponge Holding Forceps



FÖRSTER



glatt

18 cm **2.310.18**
20 cm **2.310.20**
25 cm **2.310.25**



glatt

18 cm **2.311.18**
20 cm **2.311.20**
25 cm **2.311.25**



gerieft

18 cm **2.312.18**
20 cm **2.312.20**
25 cm **2.312.25**



gerieft

18 cm **2.313.18**
20 cm **2.313.20**
25 cm **2.313.25**

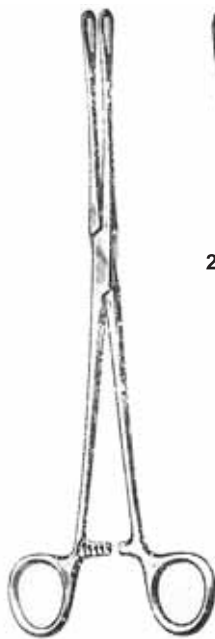

FOERSTER schmal
25 cm



2.316.25



2.317.25



RAMPLEY
25 cm **2.318.25**

Sterilisier- und Katheterzangen
Sterilizing and Catheter Forceps

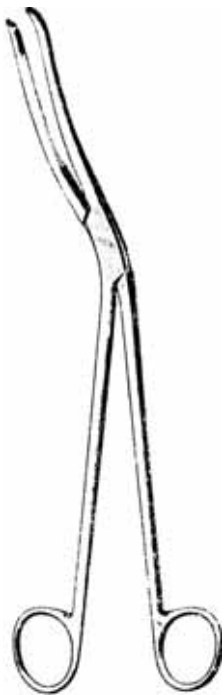

CHEATLE
27 cm 2.331.27



STERILISIERZANGE
20 cm 2.334.20
30 cm 2.334.30



ROGGE
23 cm 2.336.23



MAGIL



für Kinder 20 cm
2.350.20



für Erwachsene 20 cm
2.350.25

Lungenfazzangen und Gefäßklemmen
Lung Grasping Forceps, Serrefines

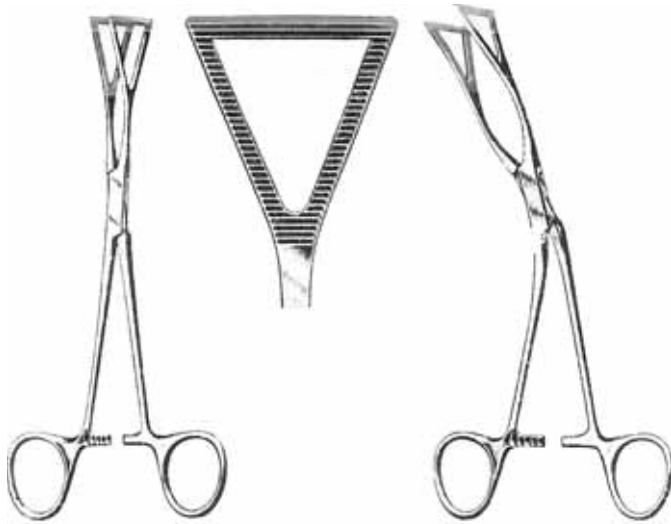

LOVELACE
2.354.20

20 cm

2.355.20

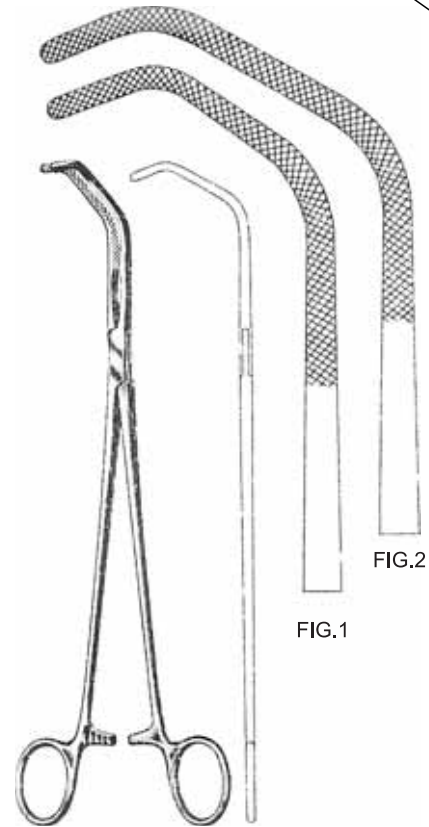

SATINSKY

26,5 cm

FIG.1 2.361.26

FIG.2 2.363.26

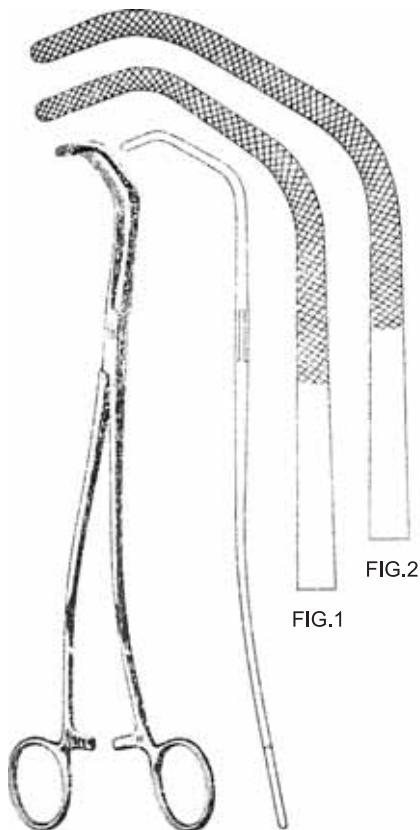

SATINSKY

26,5 cm

FIG.1 2.365.26

FIG.2 2.367.26

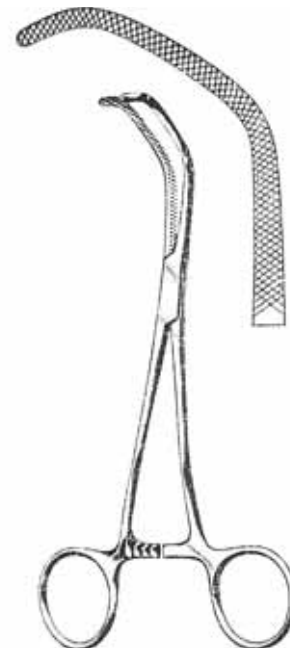

BABY-SATINSKY

15 cm

2.369.15

Gefäßklemmen und Darmfazzangen
Serrefines and Intestinal Tissue Forceps



HARKEN



FIG.1
2.371.24



FIG.2
2.373.24

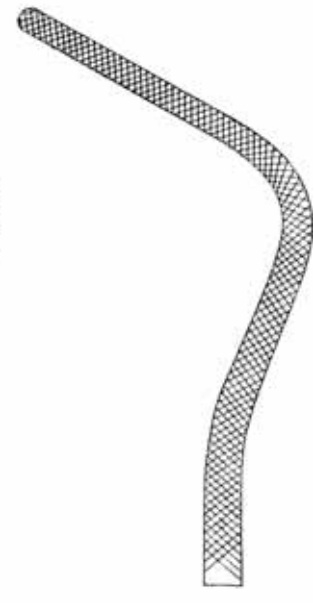

FIG.3
2.375.24



ALLIS-BABY
14 cm 2.390.14



4 : 5	5 : 6
Allis	Allis
15 cm	15 cm
19 cm	19 cm
25 cm	25 cm
2.392.15	2.394.15
	2.394.19
	2.394.25



ALLIS-ADIR
15,5 cm 2.396.15

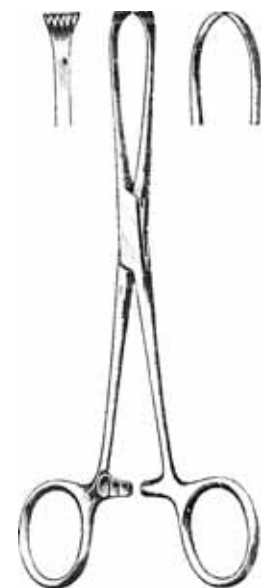

BOYS-ALLIS
15 cm 2.398.15

Darmfazzangen
Intestinal Tissue Forceps



LOCKWOOD ALLIS
20 cm 2.400.20



JUDD ALLIS
15 cm 2.402.15
19 cm 2.402.19

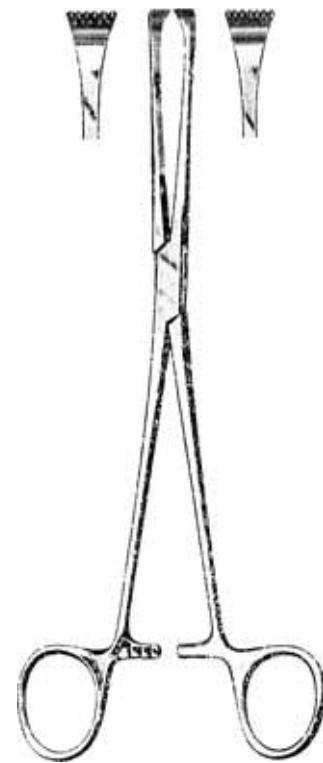

THOMS ALLIS
20 cm 2.404.20



WILLIAMS
16 cm 2.410.16



BABCOCK
16 cm 2.412.16
18 cm 2.412.18
20 cm 2.412.20
24 cm 2.412.24

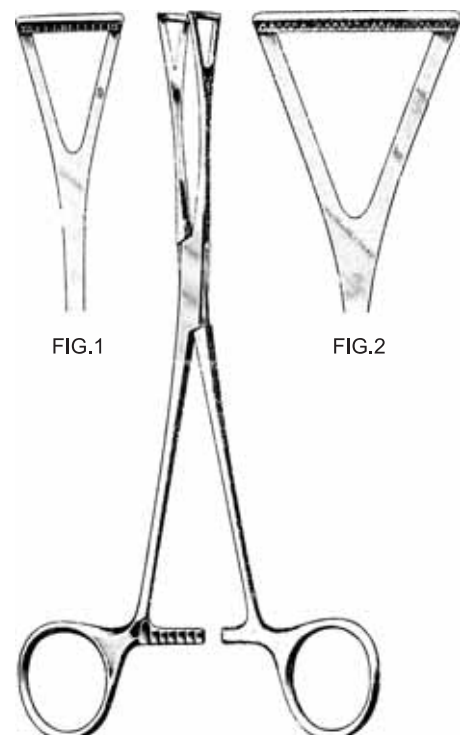

DUVAL
FIG.1 18 cm 2.416.18
FIG.1 20 cm 2.416.20
FIG.2 20 cm 2.418.20
FIG.2 23 cm 2.418.23

Darmfazzangen und Magenquetschklemmen Intestinal Tissue Forceps and Stomach Clamps

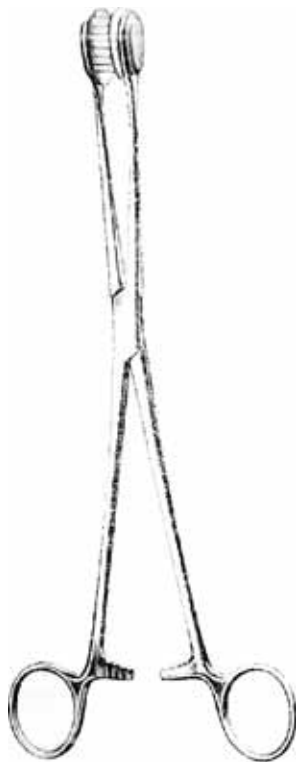

CHILD
24 cm 2.420.24

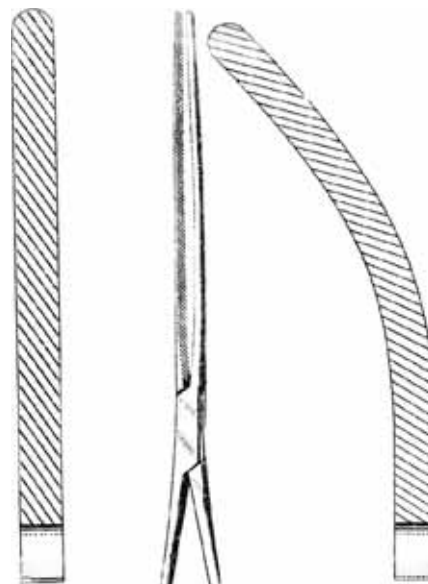

ger.	DOYEN	geb.
2.430.21	21 cm	2.431.21
2.430.23	23 cm	2.431.23

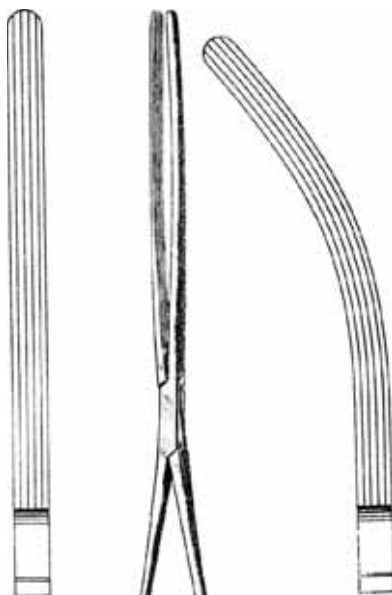

ger.	MAYO ROBSON	geb.
2.434.21	21 cm	2.435.21
2.434.23	23 cm	2.435.23
2.434.25	25 cm	2.435.25



PAYR

ohne Stift:	
15 cm	2.437.15
21 cm	2.437.21
29 cm	2.437.29
35 cm	2.437.35
mit Stift:	
15 cm	2.439.15
21 cm	2.439.21
29 cm	2.439.29
35 cm	2.439.35

Nierenstein- und Gallensteinzangen Kidney Stone and Gall Stone Forceps

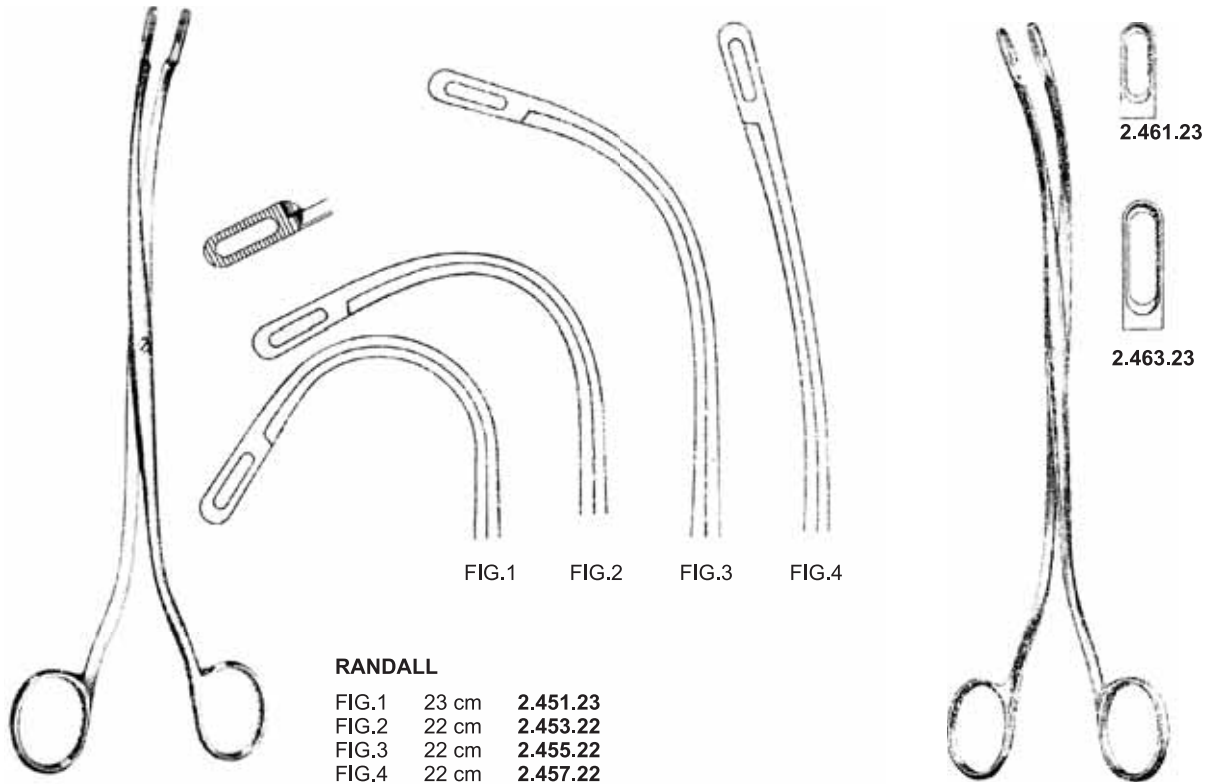
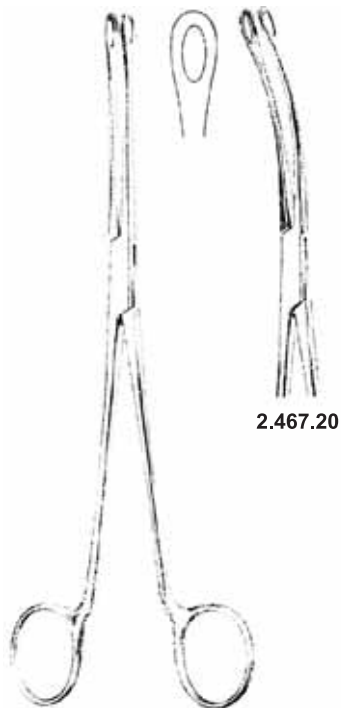

FIG.1 FIG.2 FIG.3 FIG.4

RANDALL

FIG.1	23 cm	2.451.23
FIG.2	22 cm	2.453.22
FIG.3	22 cm	2.455.22
FIG.4	22 cm	2.457.22

DESJARDINS 23 cm



2.467.20

BLAKE
20 cm 2.466.20

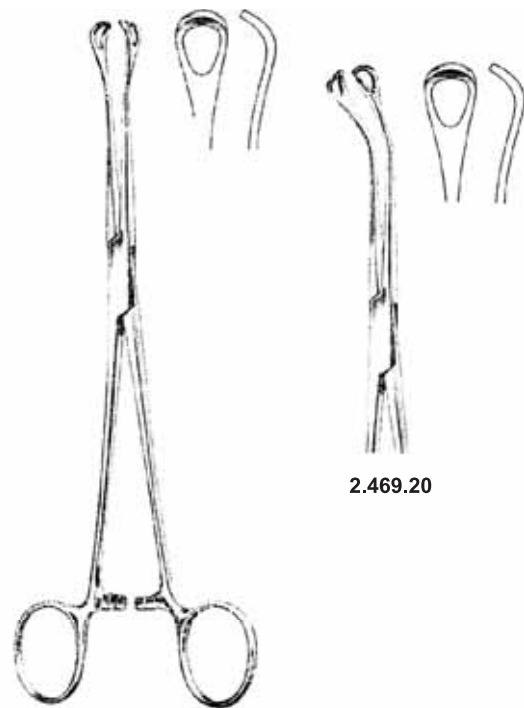

2.469.20

MAYO BLAKE
20 cm 2.468.20

Hakenzangen
Tenaculum Forceps



SCHRÖDER
25 cm 2.480.25



SKENE
24 cm 2.485.24



SCHRÖDER 2x2 Z
20 cm 2.488.20
24 cm 2.488.24



20 cm 2.489.20
24 cm 2.489.24

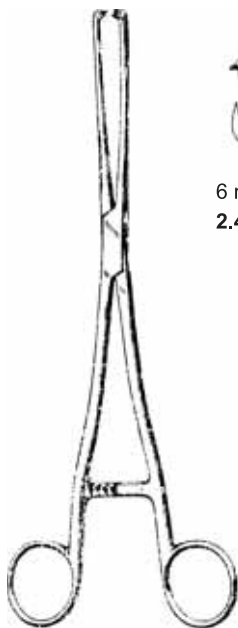

MUSEUX 24 cm



6 mm
2.492.24



8 mm
2.494.24



10 mm
2.496.24



MUSEUX 24 cm



6 mm
2.493.24



8 mm
2.495.24



10 mm
2.497.24

Uterus-Polypenzangen und Uterus-Fasszangen
Uterine Polypus Forceps and Uterine Elevating Forceps

DOYEN
20 cm 2.510.20



NOTO
27 cm 2.512.27

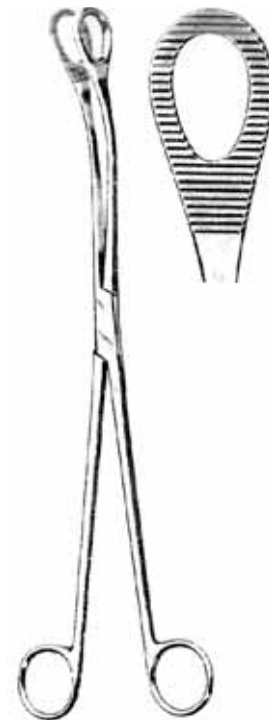

Kelly
32 cm 2.517.32



PRUESMANN
27,5 cm 2.521.27



DARTIGUES
27 cm 2.524.27



SOMER
23 cm 2.527.23

Uterus-Fasszangen, Probenexzisionszangen
Uterine Elevating Forceps, Cervical Biopsy and Speciem Forceps



COLLIN
25 cm 2.530.25

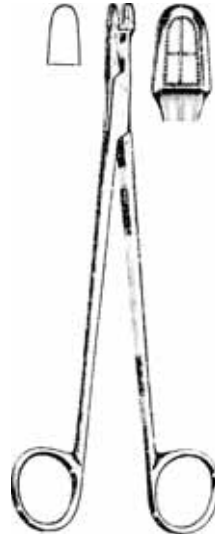

SCHUBERT
21 cm 2.540.21
29 cm 2.540.29

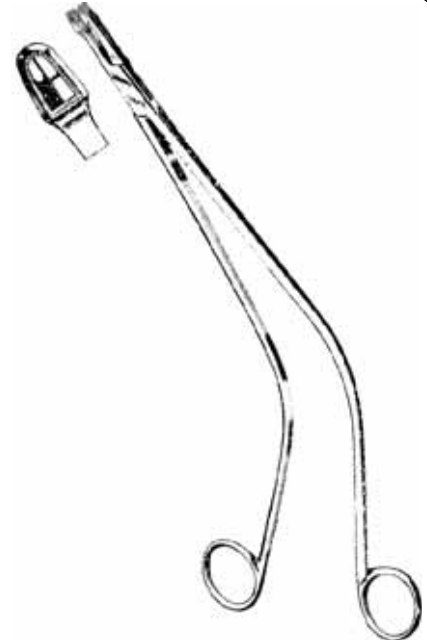

SCHUBERT
26 cm 2.541.26

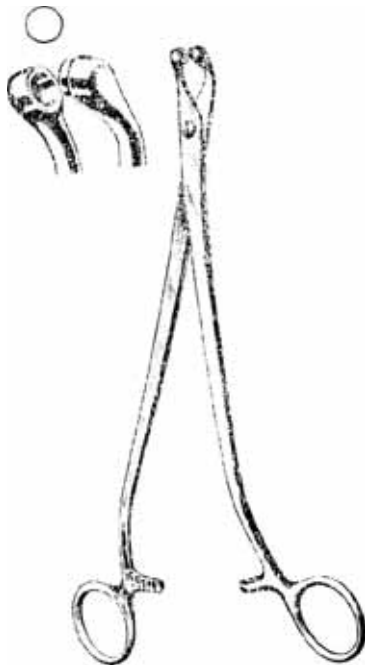

THOMS GAYLOR
24 cm 2.543.24

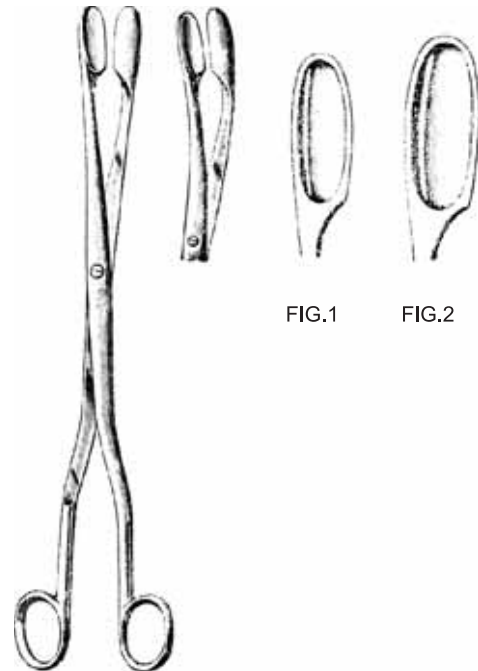

ger. **WINTER** 28 cm geb.
2.560.28 FIG.1 2.561.28
2.562.28 FIG.2 2.563.28

Uterus-Klemmzangen, Zungenzangen

Uterine Haemostasis Forceps, Tongue Holding Forceps



2.569.27

SAENGER
27 cm 2.568.27

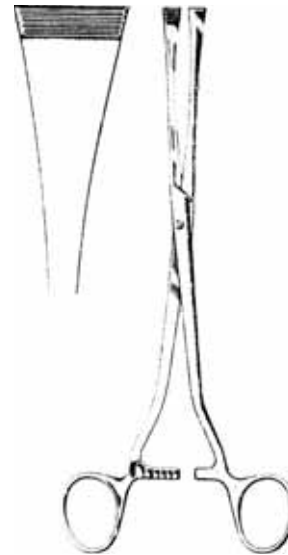

GREEN - ARMYTAGE
21 cm 2.574.21

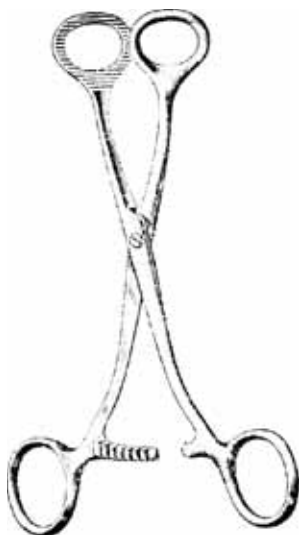

COLLIN
16 cm 2.580.16
17 cm 2.580.17
19 cm 2.580.19

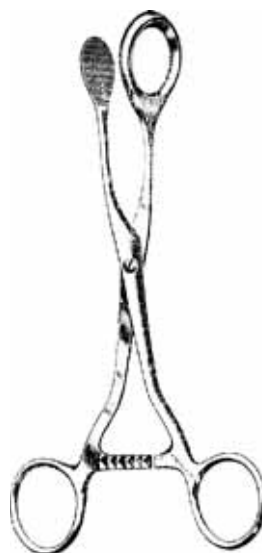

MATHIEU
19 cm 2.584.19

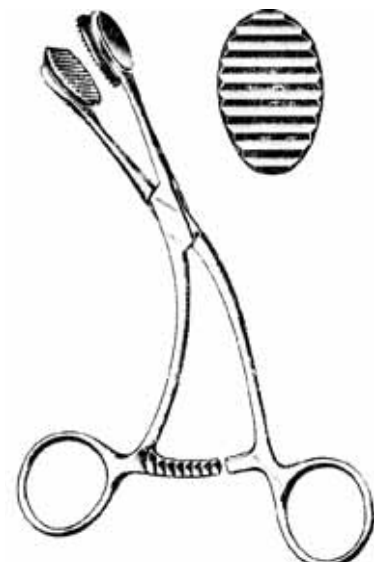

YOUNG
17 cm 2.587.17

Tonsillenklemmen
Haemostatic Forceps

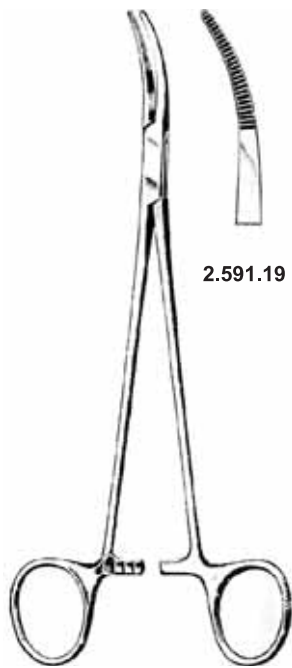

2.591.19

SCHNIDT
19 cm



2.593.19



2.595.19

SCHNIDT
19 cm



2.597.19

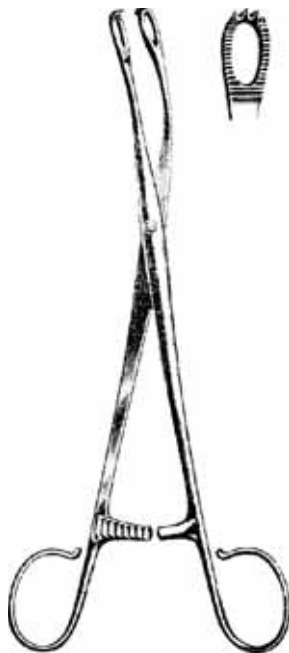

BLOHMKE
20 cm 2.599.20

Polypenzangen, Septumzangen
Nasal Polypus and Septum Compression Forceps

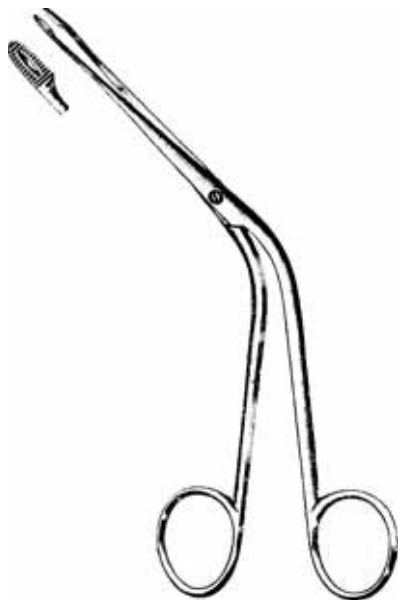

HARTMANN
16 cm 2.611.16

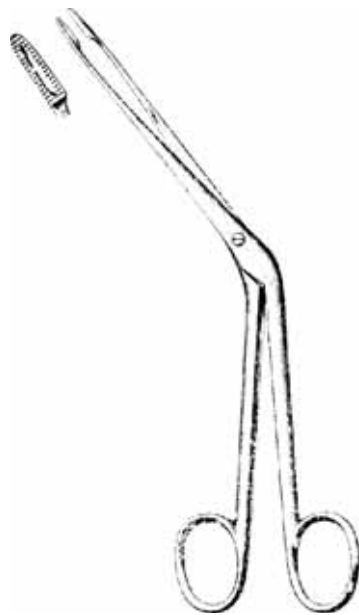

HARTMANN
20 cm 2.611.20

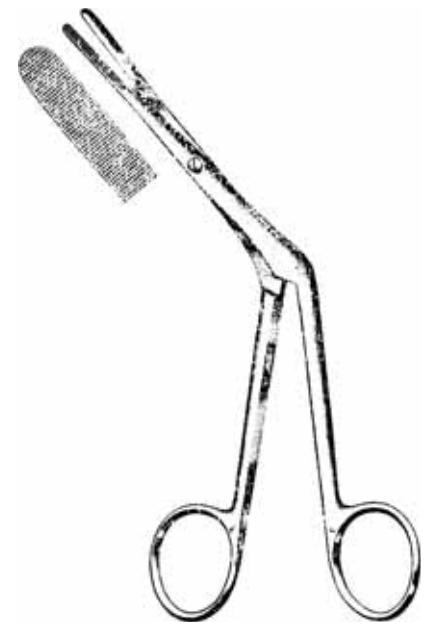

KILLIAN
17 cm 2.613.17



2.621.01



2.621.02



2.621.03

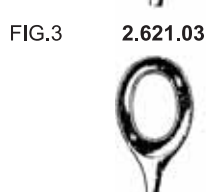

2.621.04

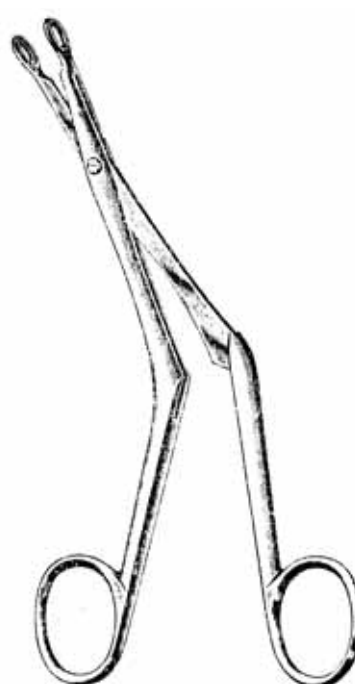

BRUENINGS
19 cm

Nasenzangen, Tonsillenzangen
Nasal Forceps, Tonsil Seizing Forceps

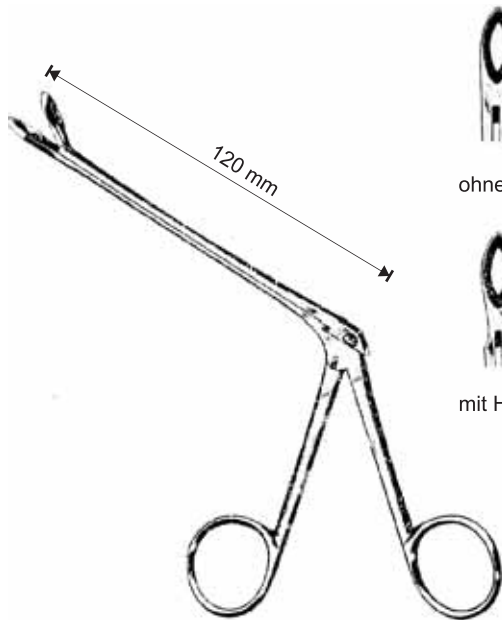

WEIL BLAKESLEY
19 cm

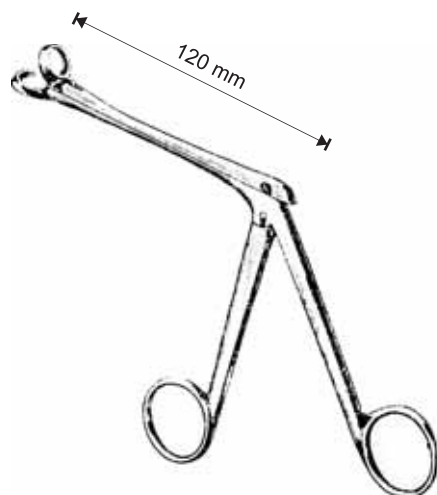
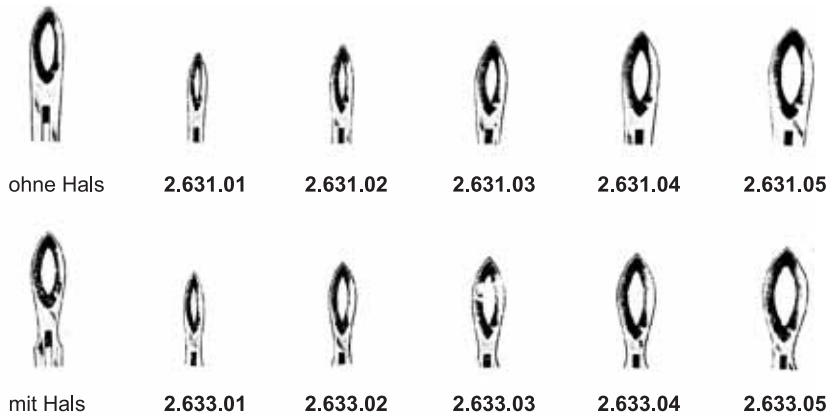

HARTMANN

- | | | |
|-------|-------|----------|
| FIG.1 | 13 mm | 2.637.01 |
| FIG.2 | 15 mm | 2.637.02 |
| FIG.3 | 17 mm | 2.637.03 |

Nadelhalter
Needleholder

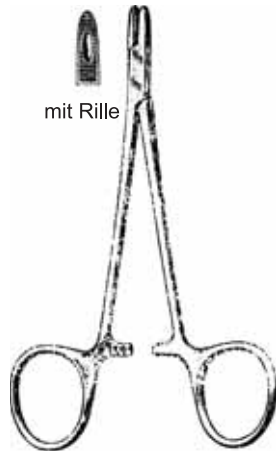

DERF
12 cm 2.700.12

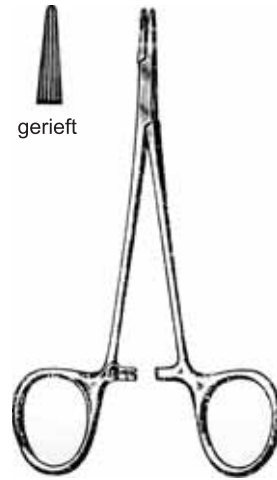

DERF
12,5 cm 2.702.12



COLLIER
12,5 cm 2.706.12



HALSEY
13 cm 2.708.13

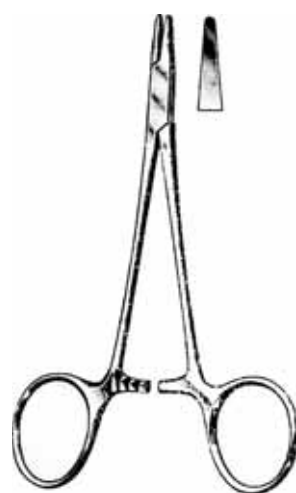

WEBSTER
13 cm 2.712.13



CRILE MURRAY
15 cm 2.716.15

**Nadelhalter
Needleholder**



CRILE WOOD
15 cm 2.718.15



BROWN
13 cm 2.722.13
18 cm 2.722.18



SAROT
18 cm 2.724.18
26 cm 2.724.26



HEGAR BAUMGARTNER
14 cm 2.718.14

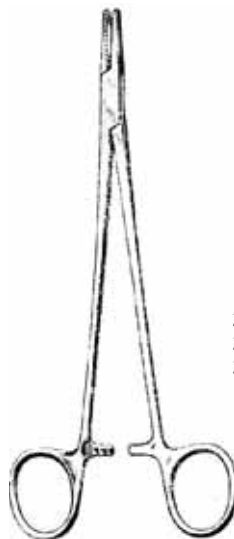

MAYO HEGAR

- 14 cm 2.730.14
- 16 cm 2.730.16
- 18 cm 2.730.18
- 20 cm 2.730.20
- 24 cm 2.730.24
- 26 cm 2.730.26



- 16 cm 2.731.16
- 18 cm 2.731.18
- 20 cm 2.731.20
- 24 cm 2.731.24
- 26 cm 2.731.26

**Nadelhalter
Needleholder**

MAYO HEGAR
16 cm 2.734.16
18 cm 2.734.18
20 cm 2.734.20

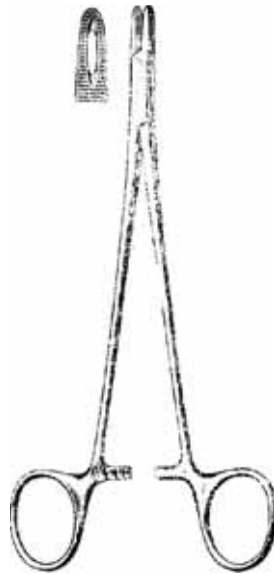

ADSON
18 cm 2.738.18



HEANEY
21 cm 2.741.21



JAMISON
23,5 cm 2.747.23

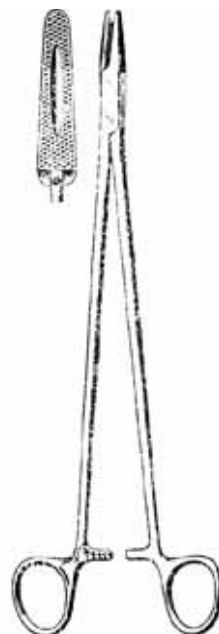

MASSON
27 cm 2.748.27



WANGENSTEEN
27 cm 2.752.27

Nadelhalter
Needleholder



WANGENSTEEN
27 cm 2.754.27



FINOCCHIETTO
27 cm 2.757.27

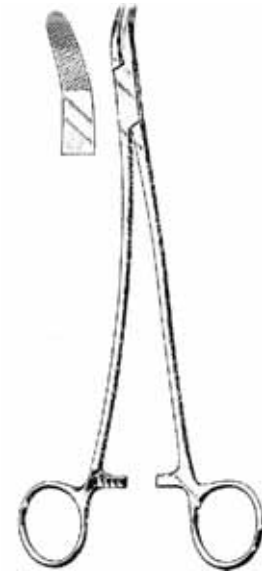

STRATTE
23 cm 2.759.23



CRILE
15 cm 2.764.15

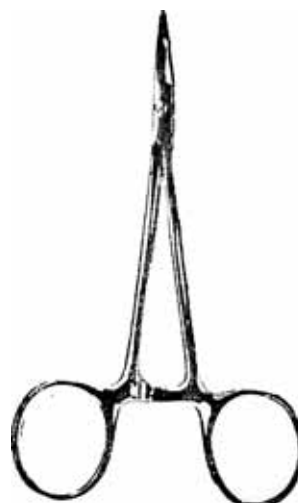

BABY OLSEN-HEGAR
11,5 cm 1.350.11

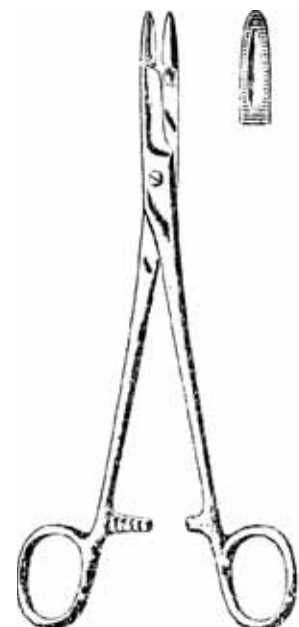

OLSEN-HEGAR
14 cm 1.350.14
18 cm 1.350.18

Nadelhalter
Needleholder



OLSEN-HEGAR
17 cm 1.350.17



OLSEN-HEGAR
14 cm 1.356.14



GILLIES
16 cm 2.768.16



MATHIEU schlank
14 cm 2.788.14
17 cm 2.788.17



MATHIEU

2.784.14	14 cm	2.786.14
2.784.17	17 cm	2.786.17
2.784.20	20 cm	2.786.20
2.784.24	24 cm	2.786.24

Anatomische Pinzetten Dressing Forceps



10,5 cm	3.000.10
11,5 cm	3.000.11
13,0 cm	3.000.13
14,5 cm	3.000.14
15,0 cm	3.000.15
16,0 cm	3.000.16
18,0 cm	3.000.18
20,0 cm	3.000.20
25,0 cm	3.000.25
30,0 cm	3.000.30

STANDARD



10,5 cm	3.001.10
11,5 cm	3.001.11
13,0 cm	3.001.13
14,5 cm	3.001.14
15,0 cm	3.001.15
16,0 cm	3.001.16
18,0 cm	3.001.18
20,0 cm	3.001.20
25,0 cm	3.001.25
30,0 cm	3.001.30

STANDARD



10,5 cm	3.004.10
11,5 cm	3.004.11
13,0 cm	3.004.13
14,5 cm	3.004.14
15,0 cm	3.004.15
16,0 cm	3.004.16
18,0 cm	3.004.18
20,0 cm	3.004.20
25,0 cm	3.004.25
30,0 cm	3.004.30

SCHMAL



10,5 cm	3.005.10
11,5 cm	3.005.11
13,0 cm	3.005.13
14,5 cm	3.005.14
15,0 cm	3.005.15
16,0 cm	3.005.16
18,0 cm	3.005.18
20,0 cm	3.005.20
25,0 cm	3.005.25
30,0 cm	3.005.30

SCHMAL



13,0 cm	3.006.13
14,5 cm	3.006.14

FEIN



13,0 cm	3.014.13
14,5 cm	3.014.14
16,0 cm	3.014.16

KREUZ GERIEFT

Anatomische Pinzetten Dressing Forceps



13,0 cm **3.020.13**
15,0 cm **3.020.15**
17,0 cm **3.020.17**
20,0 cm **3.020.20**

STILLE



12,0 cm **3.030.12**
13,0 cm **3.030.13**
14,5 cm **3.030.14**
15,5 cm **3.030.15**
18,0 cm **3.030.18**
21,0 cm **3.030.21**
25,0 cm **3.030.25**
31,0 cm **3.030.31**

USA-MOD.



12,0 cm **3.034.12**
13,0 cm **3.034.13**
14,5 cm **3.034.14**
15,5 cm **3.034.15**

USA-MOD. schmal

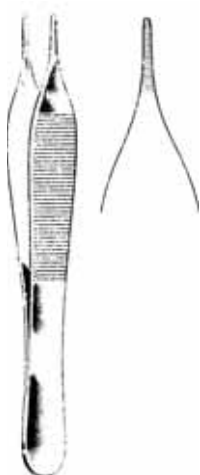

ADSON
12 cm **3.040.12**
15 cm **3.040.15**

ADSON



MIKRO-ADSON
12 cm **3.044.12**

MIKRO-ADSON



MC INDOE
15 cm **3.050.15**

MC INDOE

Anatomische Pinzetten Dressing Forceps

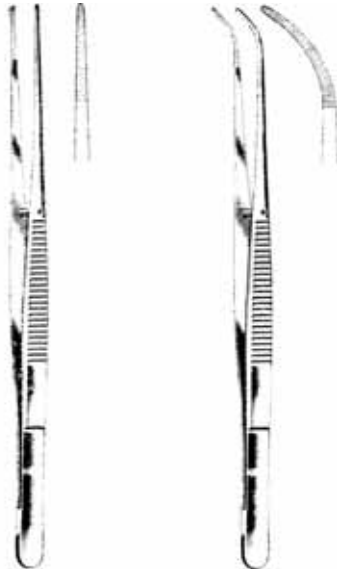

SEMKEN
 3.054.12 12,5 cm 3.055.12
 3.054.15 15,5 cm 3.055.15

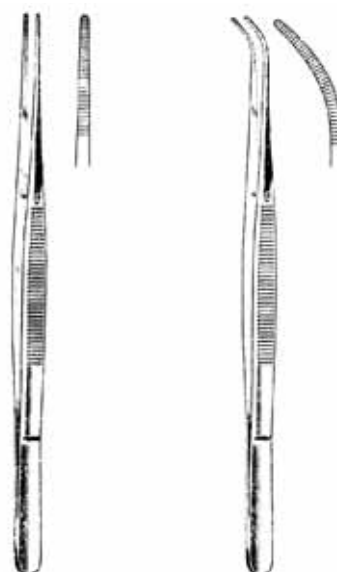

TAYLOR
 3.056.17 17,5 cm 3.057.17

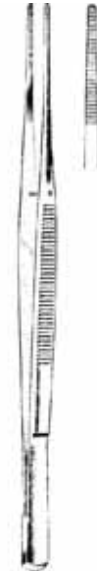

TAYLOR
 17,5 cm 3.058.17



TAYLOR
 17,5 cm 3.059.17



3.064.18



GERALD
 18,0 cm 3.065.18



3.074.17

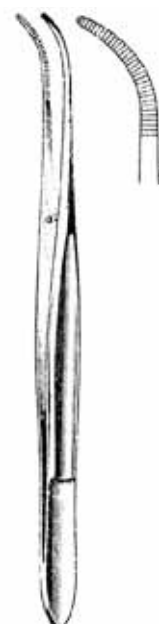

CUSHING
 17,5 cm 3.075.17

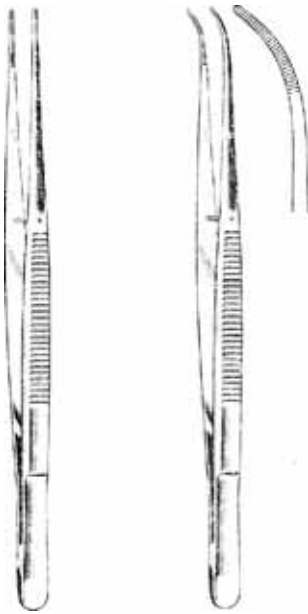
Anatomische Pinzetten
Dressing Forceps**POTTS-SMITH**

3.080.18	18,0 cm	3.081.18
3.080.21	21,0 cm	3.081.21
3.080.25	25,0 cm	3.081.25

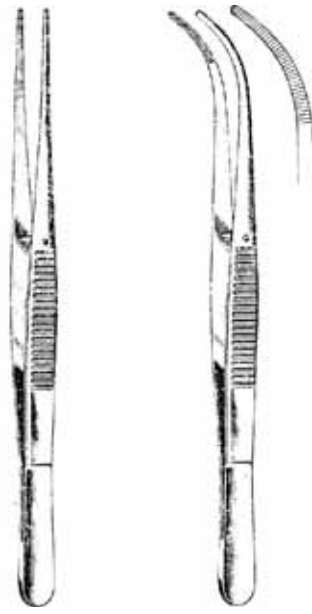
**BROPHY**

3.084.20	20,0 cm	3.085.20
-----------------	---------	-----------------

**DUEHRSSSEN**

20,0 cm	3.092.20
---------	-----------------

**WANGENSTEEN**

23,0 cm	3.094.23
---------	-----------------

Chirurgische Pinzetten Tissue Forceps



10,5 cm	3.100.10
11,5 cm	3.100.11
13,0 cm	3.100.13
14,5 cm	3.100.14
15,0 cm	3.100.15
16,0 cm	3.100.16
18,0 cm	3.100.18
20,0 cm	3.100.20
25,0 cm	3.100.25
30,0 cm	3.100.30

STANDARD
1x2 Z

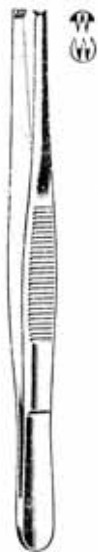

11,5 cm	3.102.11
13,0 cm	3.102.13
14,5 cm	3.102.14
16,0 cm	3.102.16
18,0 cm	3.102.18
20,0 cm	3.102.20
25,0 cm	3.102.25
30,0 cm	3.102.30

STANDARD
2x3 Z

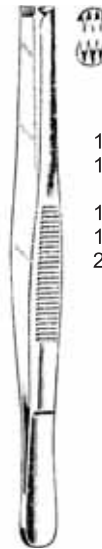

13,0 cm	3.104.13
14,5 cm	3.104.14
16,0 cm	3.104.16
18,0 cm	3.104.18
20,0 cm	3.104.20

STANDARD
3x4 Z



13,0 cm	3.106.13
14,5 cm	3.106.14
16,0 cm	3.106.16
18,0 cm	3.106.18
20,0 cm	3.106.20

STANDARD
4x5 Z



11,5 cm	3.110.11
13,0 cm	3.110.13
14,5 cm	3.110.14
16,0 cm	3.110.16
18,0 cm	3.110.18
20,0 cm	3.110.20
25,0 cm	3.110.25
30,0 cm	3.110.30

SCHMAL
1x2 Z



13,0 cm	3.112.13
14,5 cm	3.112.14

FEIN
1x2 Z

Chirurgische Pinzetten Tissue Forceps

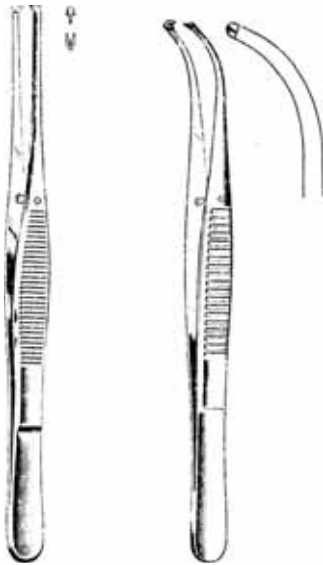

SCHMAL mit Stift 1x2 Z
 3.114.13 13,0 cm 3.115.13
 3.114.14 14,5 cm 3.115.14

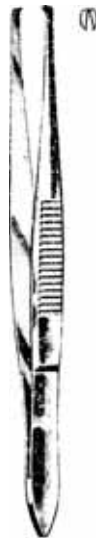

STILLE 1x2 Z
 15,0 cm 3.120.15

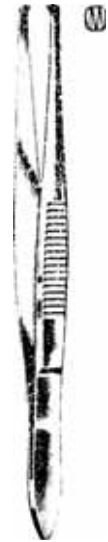

STILLE 2x3 Z
 15,0 cm 3.122.15



USA-MOD.
 1x2 Z

- 12,0 cm 3.130.12
- 13,0 cm 3.130.13
- 14,5 cm 3.130.14
- 15,5 cm 3.130.15
- 18,5 cm 3.130.18
- 20,0 cm 3.130.20
- 25,0 cm 3.130.25
- 30,0 cm 3.130.30



USA-MOD.
 2x3 Z

- 12,0 cm 3.132.12
- 13,0 cm 3.132.13
- 14,5 cm 3.132.14
- 15,5 cm 3.132.15
- 18,5 cm 3.132.18
- 20,0 cm 3.132.20
- 25,0 cm 3.132.25
- 30,0 cm 3.132.30



USA-MOD. schmal
 1x2 Z

- 13,0 cm 3.138.13
- 14,5 cm 3.138.14
- 15,5 cm 3.138.15

Chirurgische Pinzetten Tissue Forceps



ADSON 1x2 Z
12,0 cm **3.150.12**
15,0 cm **3.150.15**



ADSON 1x2 Z
12,0 cm **3.154.12**

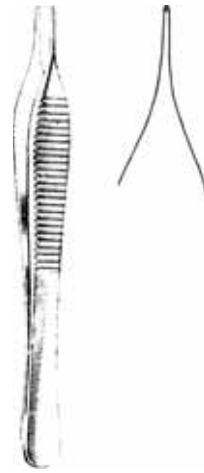

MICRO-ADSON 1x2 Z
12,0 cm **3.158.12**



ADSON-BROWN 9x9 Z
12,0 cm **3.160.12**



GILLIES 1x2 Z
15,0 cm **3.166.15**



SEMKEN 1x2 Z
3.170.12 12,5 cm **3.171.12**
3.170.15 15,0 cm **3.171.15**



TAYLOR 1x2 Z
3.176.17 17,5 cm **3.177.17**



Chirurgische Pinzetten
Tissue Forceps

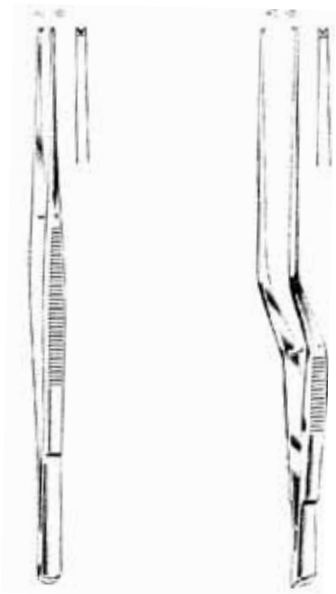

TAYLOR 1x2 Z
3.178.17 17,5 cm 3.179.17

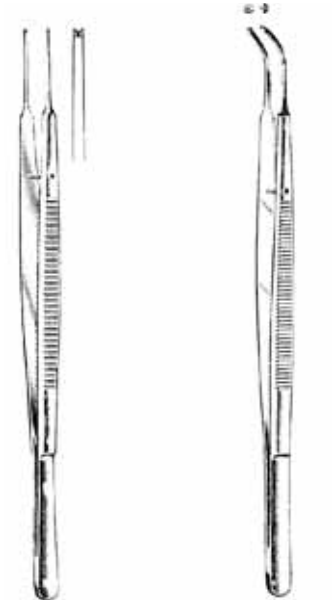

GERALD 1x2 Z
3.184.17 17,5 cm 3.184.17

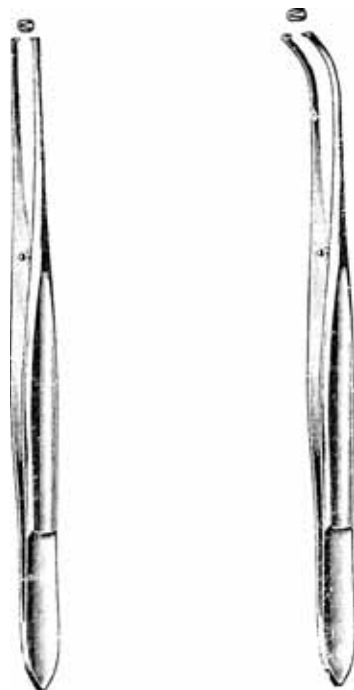

CUSHING 1x2 Z
3.194.17 17,5 cm 3.195.17

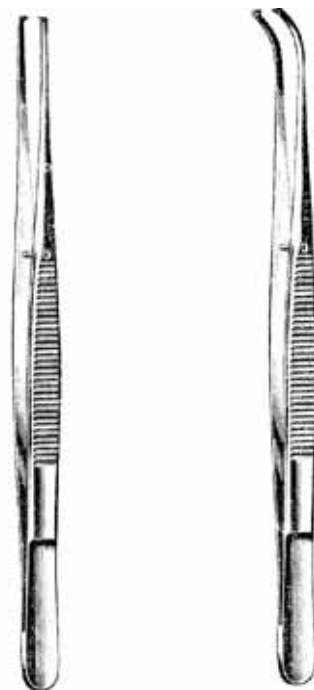

POTTS-SMITH 1x2 Z
3.200.18 18,0 cm 3.201.18
3.200.21 21,0 cm 3.201.21
3.200.25 25,0 cm 3.201.25

Chirurgische Pinzetten Tissue Forceps

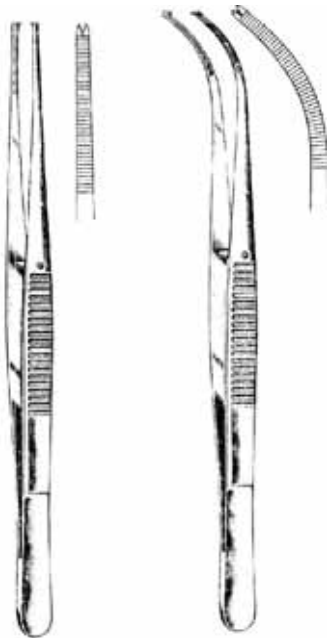

BROPHY 1x2 Z
3.204.20 20,0 cm 3.205.20



DUEHRSSSEN 1x2 Z
20,0 cm 3.210.20

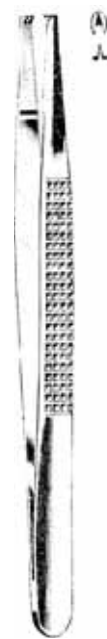

1x2 Z
3.222.18

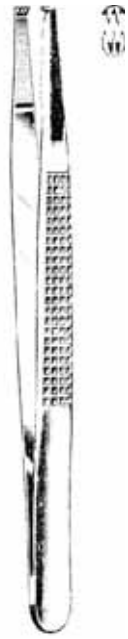

BONNEY 2x3 Z
18,0 cm 3.224.18

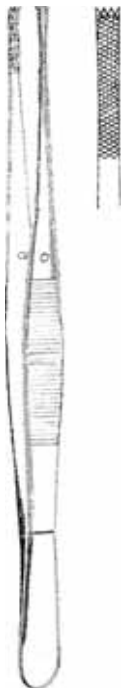

STILLE-BARRAYA
18,0 cm 3.228.18
20,0 cm 3.228.20
25,0 cm 3.228.25



STONE 4x5 Z
15,0 cm 3.230.15



LERCHE 5x6 Z
15,0 cm 3.232.15

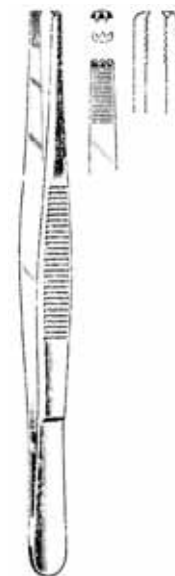

2x3 Z
3.236.15
3.236.20

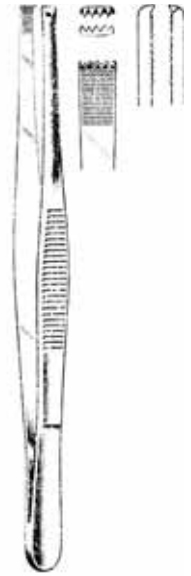

ADLERKREUTZ 4x5 Z
15,0 cm 3.238.15
20,0 cm 3.238.20

Chirurgische Pinzetten, Fasspinzetten Tissue Forceps, Grasping Forceps



1x2 Z
3.246.14
3.246.20

LANE
14,5 cm
20,0 cm



2x3 Z
3.248.14
3.248.20



1x2 Z
3.254.18

FERRIS SMITH
18,0 cm



2x3 Z
3.256.18



RUSS. MODELL
15,0 cm 3.258.15
20,0 cm 3.258.20
25,0 cm 3.258.25

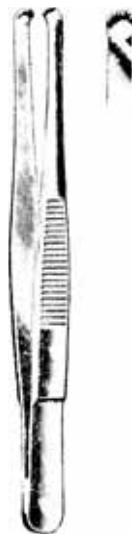

RUSS. MODELL
14,5 cm 3.260.14
16,0 cm 3.260.16
20,0 cm 3.260.20

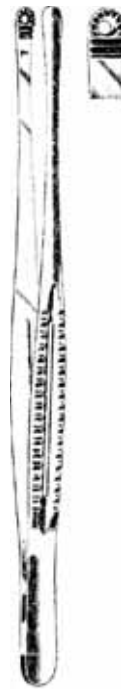

MAYO RUSSIAN
23,0 cm 3.264.23

Fasspinzetten
Grasping Forceps



SINGLE TUTTLE
23,0 cm 3.266.23



NELSON
23,0 cm 3.270.23

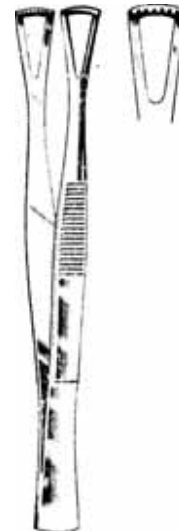

DUVAL
14,0 cm 3.276.14

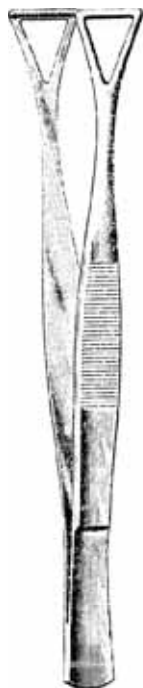

COLLIN DUVAL
20,0 cm



FIG.1
3.280.20



FIG.2
3.282.20



FIG.3
3.284.20

Pinzetten, feine Modelle und Splitterpinzetten Forceps, fine patterns and Splinter Forceps



10,5 cm
3.300.10



3.301.10



3.303.10



3.306.10



3.307.10



3.309.10



SPLITTERPINZETTE glatt

3.350.08	8,0 cm	3.351.08
3.350.09	9,0 cm	3.251.09
3.350.10	10,5 cm	3.351.10
3.350.11	11,5 cm	3.251.11
3.350.12	12,5 cm	3.351.12
3.350.14	14,5 cm	3.251.14

SPLITTERPINZETTE glatt

3.354.08	8,0 cm	3.355.08
3.354.09	9,0 cm	3.255.09
3.354.10	10,5 cm	3.355.10
3.354.11	11,5 cm	3.255.11
3.354.12	12,5 cm	3.355.12
3.354.14	14,5 cm	3.255.14

Splitterpinzetten und -zangen
Splinter Forceps



FEILCHENFELD
7,5 cm 3.370.07
9,0 cm 3.370.09
11,5 cm 3.370.11



3.374.10

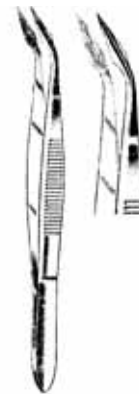

HUNTER
10,5 cm 3.375.10

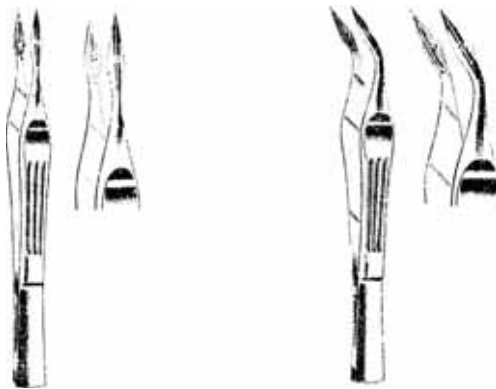

WALTER CARMALT
3.376.10 10,5 cm 3.377.10



PEET
11,5 cm 3.300.11

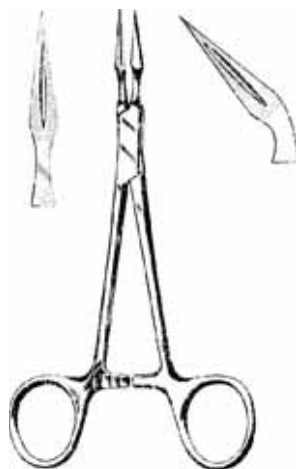

STIEGLITZ
3.384.13 13,5 cm 3.385.13



3.388.15

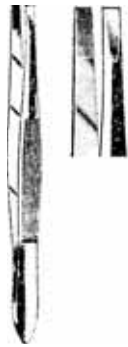
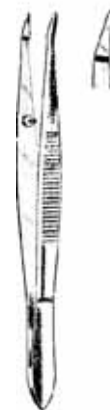

RALK
15,0 cm 3.389.15

**Cillenpinzetten
Cilia Forceps****LITTAUER**
8,5 cm 3.400.08**LITTAUER schräg**
9,0 cm 3.402.09**SHAAF**
9,0 cm 3.405.09**DOUGLAS**
9,0 cm 3.406.09**BEER**
6,5 cm 3.414.06
8,0 cm 3.414.08
9,0 cm 3.414.09**DOUGLAS**
9,0 cm 3.408.09**BERGH**
10,5 cm 3.412.10**BARRAQUER**
10,5 cm 3.417.10

Ohr- und Tamponpinzetten Ear Dressing Forceps, Tampon Forceps



TROELTSCH (WILDE)
11,0 cm 3.429.11
13,0 cm 3.429.13
18,0 cm 3.429.18



TROELTSCH (WILDE)
13,5 cm 3.433.13



LUCAE
14,0 cm 3.437.14



JANSEN
16,0 cm 3.441.16
19,0 cm 3.441.19
21,0 cm 3.441.21



TROELTSCH
15,0 cm 3.451.15

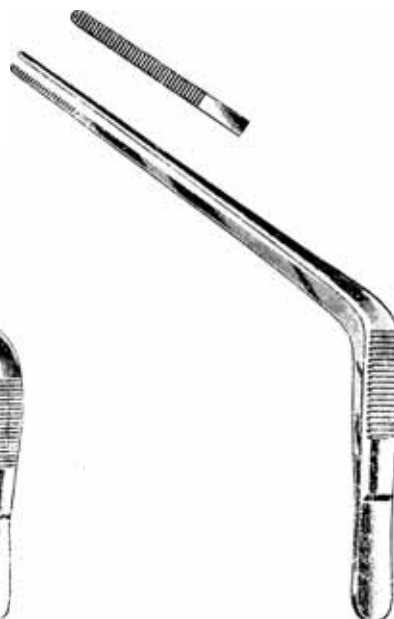

TROELTSCH
17,0 cm 3.451.17



JANSEN
19,0 cm 3.457.19
21,0 cm 3.457.21

Nahtpinzetten
Suture Forceps**MICHEL**
12,0 cm 3.462.12**HEGENBARTH**
12,5 cm 3.466.12**WACHENFELDT**
12,5 cm 3.470.12**WACHENFELDT**
12,5 cm 3.472.12**WACHENFELDT**
12,0 cm 3.474.12**CHILDE**
17,5 cm 3.476.17**CHILDE**
17,5 cm 3.478.17**OCHSNER**
14,0 cm 3.480.14

Sterilisierpinzetten, Tonsillenpinzetten
Sterilizing Forceps, Tonsil Seizing Forceps

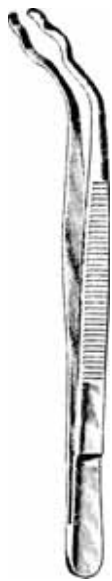

DAVIS
16,0 cm 3.482.16
20,0 cm 3.482.20
24,0 cm 3.482.24



KUEHNE
10,0 cm 3.486.10



3.490.22
3.492.22

DAVIS
22,0 cm

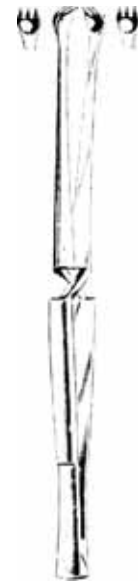

MARSCHIK
22,0 cm 3.494.22

UHRMACHERPINZETTEN



Nr. 1
12,0 cm 3.500.12



Nr. 4
11,0 cm 3.506.11



Nr. 7
11,0 cm 3.509.11

Atrauma Pinzetten
Atrauma Tissue Forceps

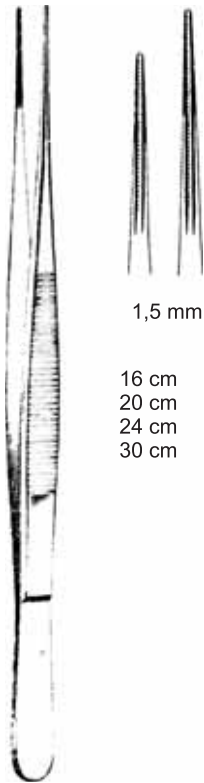

1,5 mm

16 cm **3.570.16**
20 cm **3.570.20**
24 cm **3.570.24**
30 cm **3.570.30**

DE BAKEY

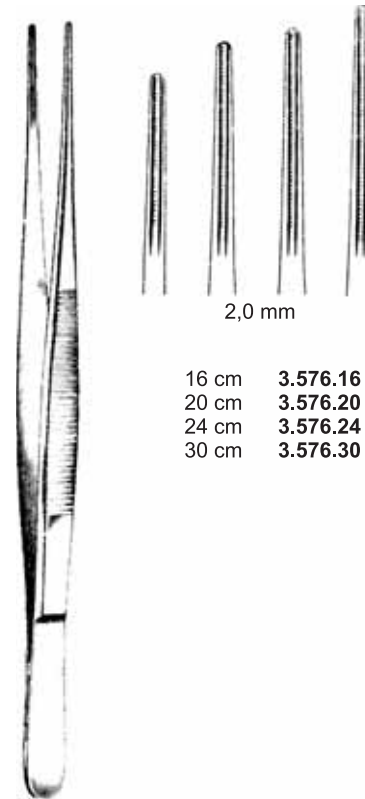

2,0 mm

16 cm **3.576.16**
20 cm **3.576.20**
24 cm **3.576.24**
30 cm **3.576.30**

DE BAKEY

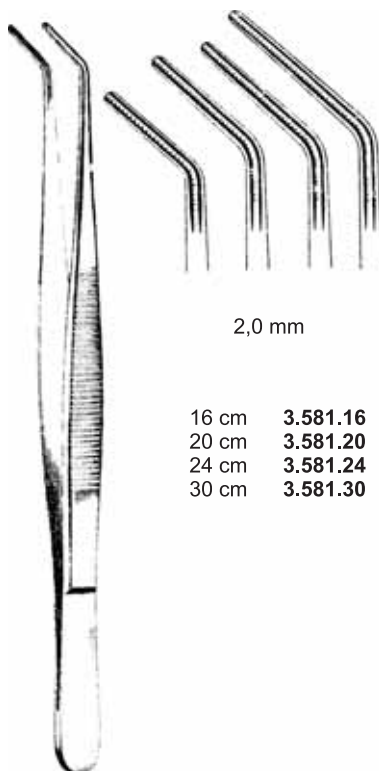

2,0 mm

16 cm **3.581.16**
20 cm **3.581.20**
24 cm **3.581.24**
30 cm **3.581.30**

DE BAKEY

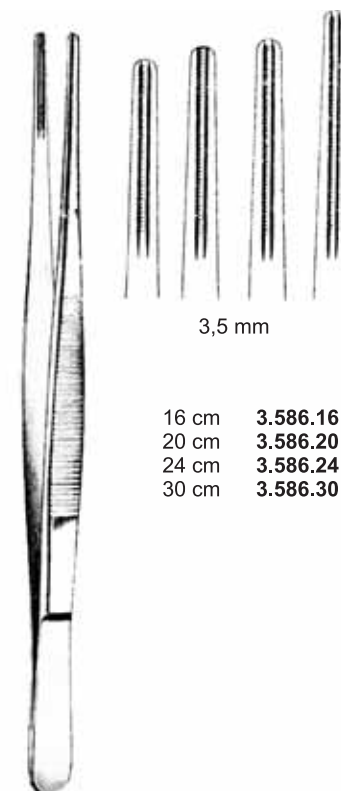

3,5 mm

16 cm **3.586.16**
20 cm **3.586.20**
24 cm **3.586.24**
30 cm **3.586.30**

DE BAKEY

Irispinzetten Iris Forceps

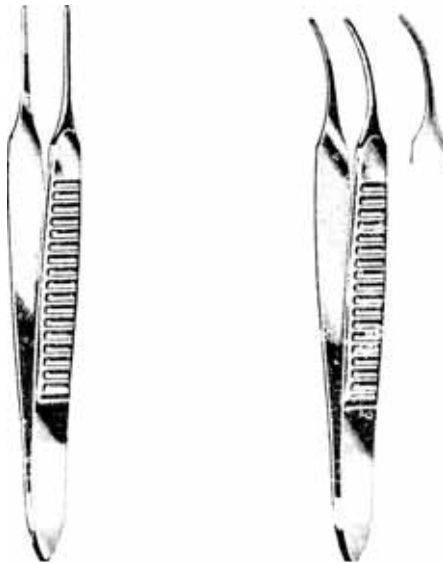

GRAEFE 7,0 cm

3.620.07	Sp. 0,5 mm	3.621.07
3.622.07	Sp. 0,7 mm	3.623.07
3.624.07	Sp. 1,0 mm	3.625.07

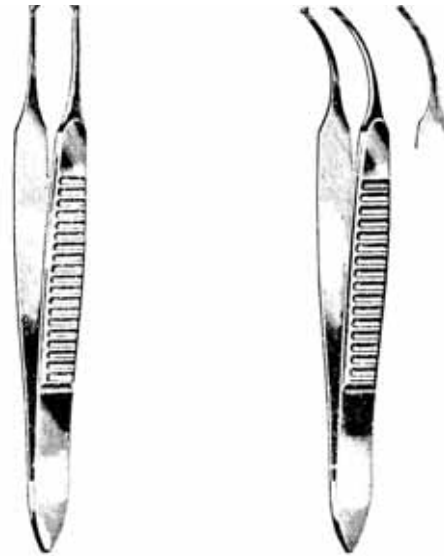

GRAEFE 7,0 cm

3.630.07	Sp. 0,5 mm	3.631.07
3.632.07	Sp. 0,7 mm	3.633.07
3.634.07	Sp. 1,0 mm	3.635.07

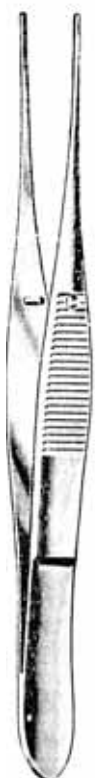

GRAEFE Sp. 1,0 mm



3.644.07	3.649.07	3.655.07
3.644.10	3.649.10	3.655.10

7,0 mm
10,0 mm

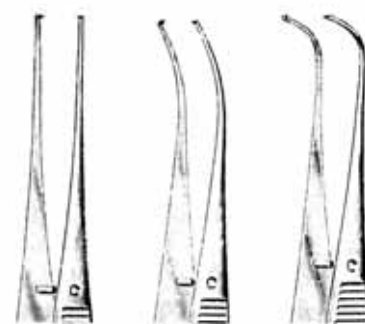

3.664.07	3.669.07	3.675.07
3.664.10	3.669.10	3.675.10

Irispinzetten
Iris Forceps



STEVENS
10,5 cm



3.680.10



3.681.10



3.683.10



3.686.10



3.687.10



3.689.10



STEVENS
10,5 cm 3.690.10

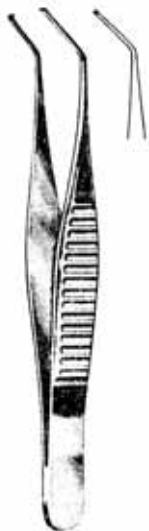

3.691.07

HESS
7,0 cm

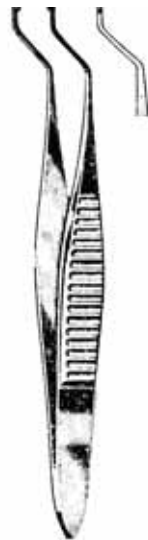

3.693.07



3.695.09

HESS Schweizer Modell

9,0 cm



3.697.09

Fixierpinzetten und Kapselpinzetten
Fixation Forceps and Capsular Forceps



fein



BISHOPH HARMAN 1x2 Z
3.700.08 8,8 cm 3.701.08

BISHOPH HARMAN 1x2 Z
3.704.08 8,8 cm 3.706.08



GILL
7,5 cm 3.709.07

GILL HESS 7,5 cm
1x2 Z unten 3.711.07
1x2 Z seidl. 3.713.07

GILL FUCHS
7,5 cm 3.721.07

GILL ARRUGA
7,5 cm 3.723.07

Fixierpinzetten Fasspinzetten und Nahtpinzetten Fixation Forceps, Grasping Forceps and Suture Forceps



ohne Schloss
11 cm 3.730.11

GRAEFE
11,0 cm 3.732.11



ELSCHNING
11,0 cm 3.734.11

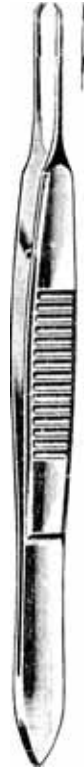

CASTROVIEJO 10,0 mm
3.740.10 0,5 mm 3.741.10
3.742.10 0,9 mm 3.743.10
3.744.10 1,5 mm 3.745.10

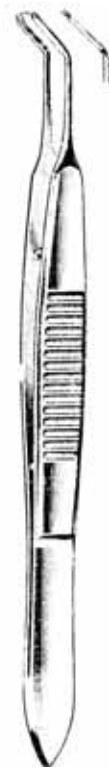

ST. MARTIN
7,0 cm 3.750.07



MOORFIELD
10,0 cm 3.752.10



PAUFIGUE
10,0 cm 3.754.10

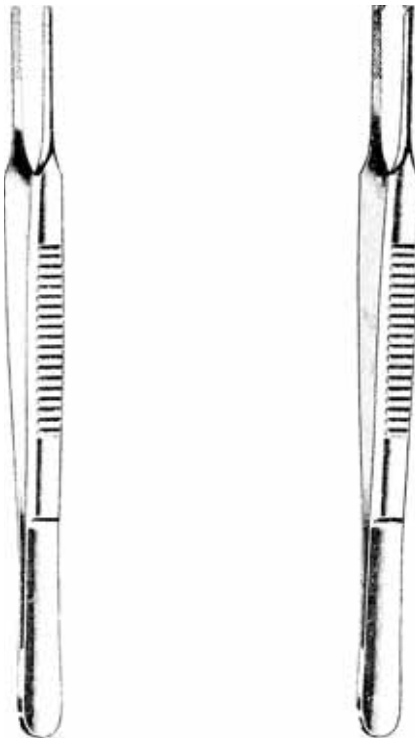

ELSCHNING 9,0 cm
1x2 Z 3.736.09
2x3 Z 3.738.09

Strabismus- und Muskelpinzetten
Strabismus and Muscular Forceps

MC CULLOUGH 1x2 Z
3.756.09 9,5 cm 3.758.09

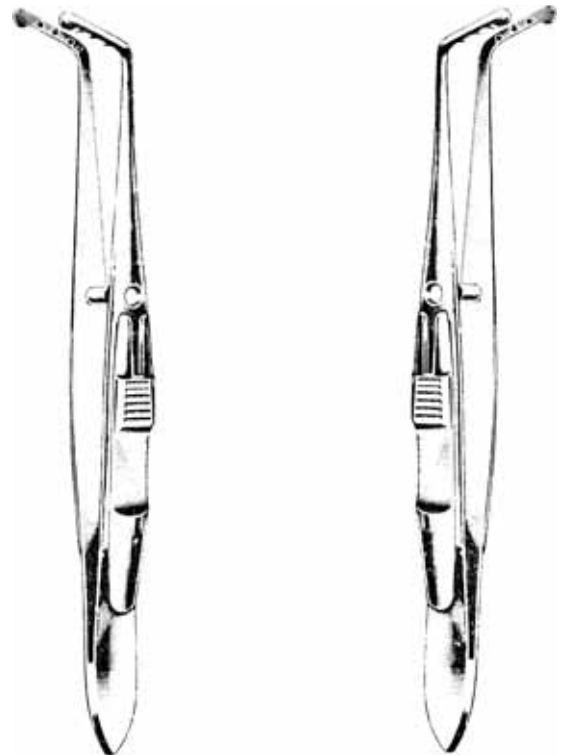

SATTLER
3.761.10 10,0 cm 3.763.10

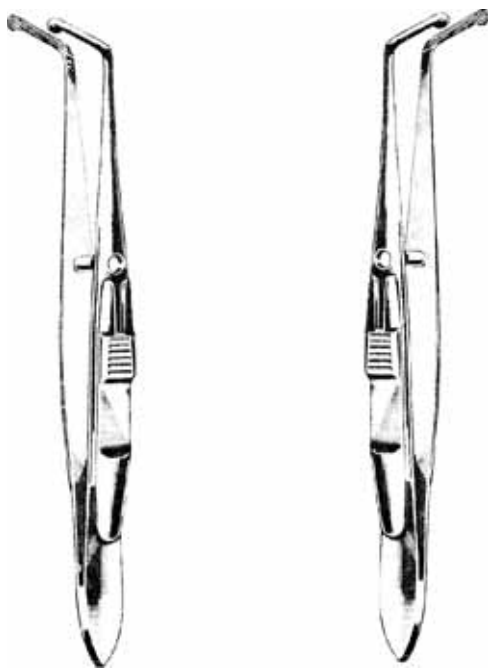

WORTH
3.767.10 10,0 cm 3.769.10

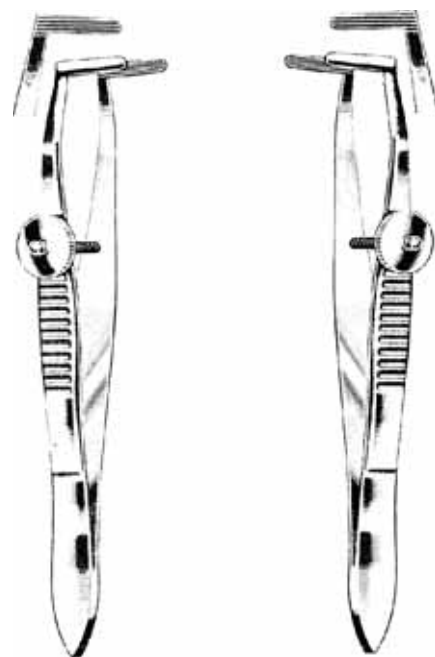

BLASOVICS
3.771.09 9,0 cm 3.773.09

Chalazion- und Trachompinzetten
Chalazion and Trachoma Forceps

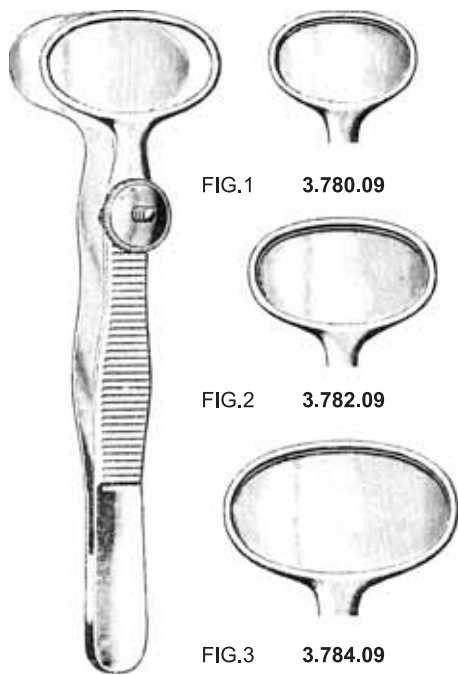

FIG.1 3.780.09

FIG.2 3.782.09

FIG.3 3.784.09

DESMARRES 9,0 cm



3.788.09



AYER
9,0 cm 3.790.09

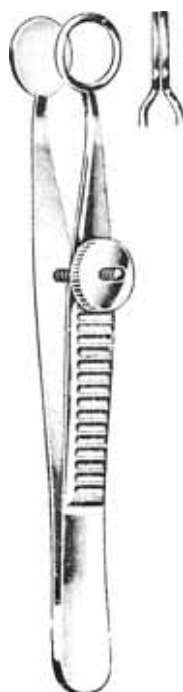

LAMBERT
9,0 cm 3.796.09

ohne Schraube
9,0 cm 3.794.09

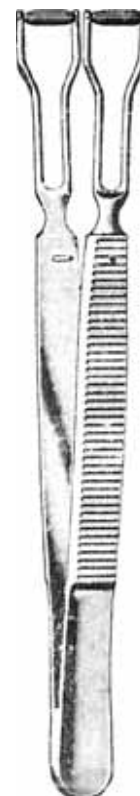

KNAPP
11,0 cm 3.800.11

Scheidenspekula Vaginal Specula



CUSCO mit seitlicher Sperre
 FIG.1 75x32 mm 5.000.01
 FIG.2 85x35 mm 5.000.02
 FIG.3 100x35 mm 5.000.03

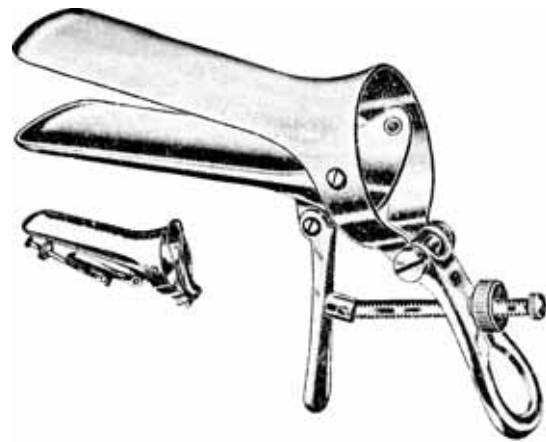

CUSCO
 FIG.1 75x32 mm 5.004.01
 FIG.2 85x35 mm 5.004.02
 FIG.3 100x35 mm 5.004.03

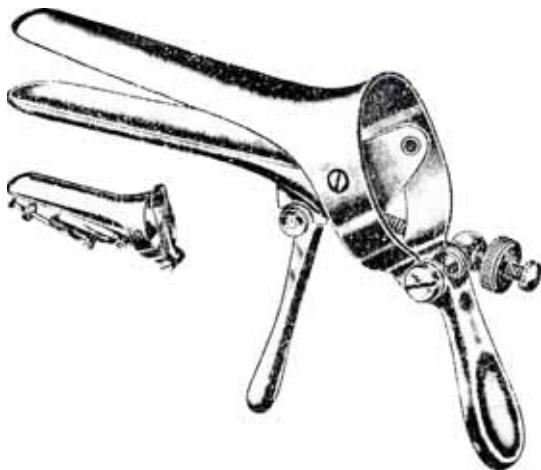

CUSCO Schweizer Modell
 FIG.1 90x23-25 mm 5.006.01
 FIG.2 100x25-27 mm 5.006.02
 FIG.3 110x27-30 mm 5.006.03

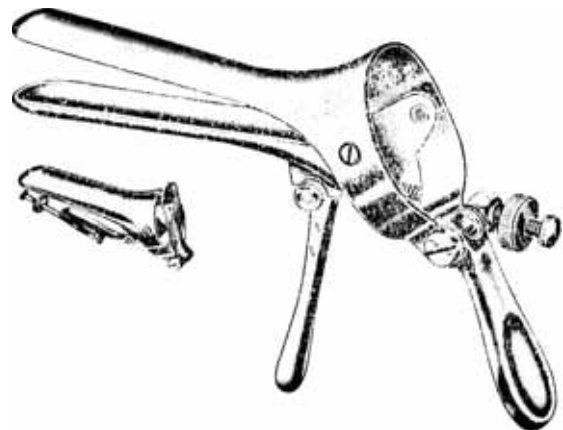

CUSCO für Junfrauen
 85x17 mm 5.008.01

**Scheidenspekula
Vaginal Specula****GRAVE**

FIG.1	75x20 mm	5.010.01
FIG.2	100x30 mm	5.010.02
FIG.3	115x35 mm	5.010.03

**COLLIN**

FIG.1	85x30 mm	5.012.01
FIG.2	100x35 mm	5.012.02
FIG.3	110x40 mm	5.012.03

**COLLIN LINDAU**

100x35 mm	5.014.01
-----------	----------

**SEMM**

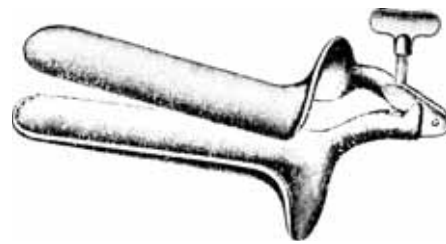
FIG.1	100x17-20 mm	5.016.01
FIG.2	100x25-30 mm	5.016.02

**Scheidenspekula
Vaginal Specula****KRISTELLER Satz kurz**

FIG.1 5.022.01
FIG.2 5.022.02
FIG.3 5.022.03

KRISTELLER Halter kurz

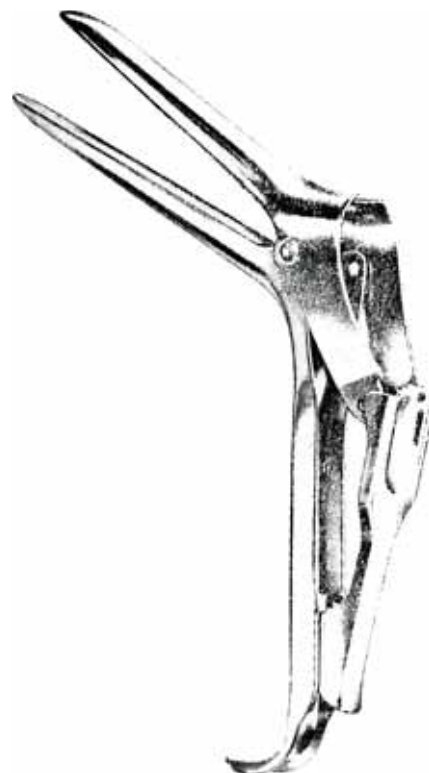
FIG.1 75x23 mm 5.021.01
FIG.2 80x26 mm 5.021.02
FIG.3 95x32 mm 5.021.03

KRISTELLER Spekulum kurz

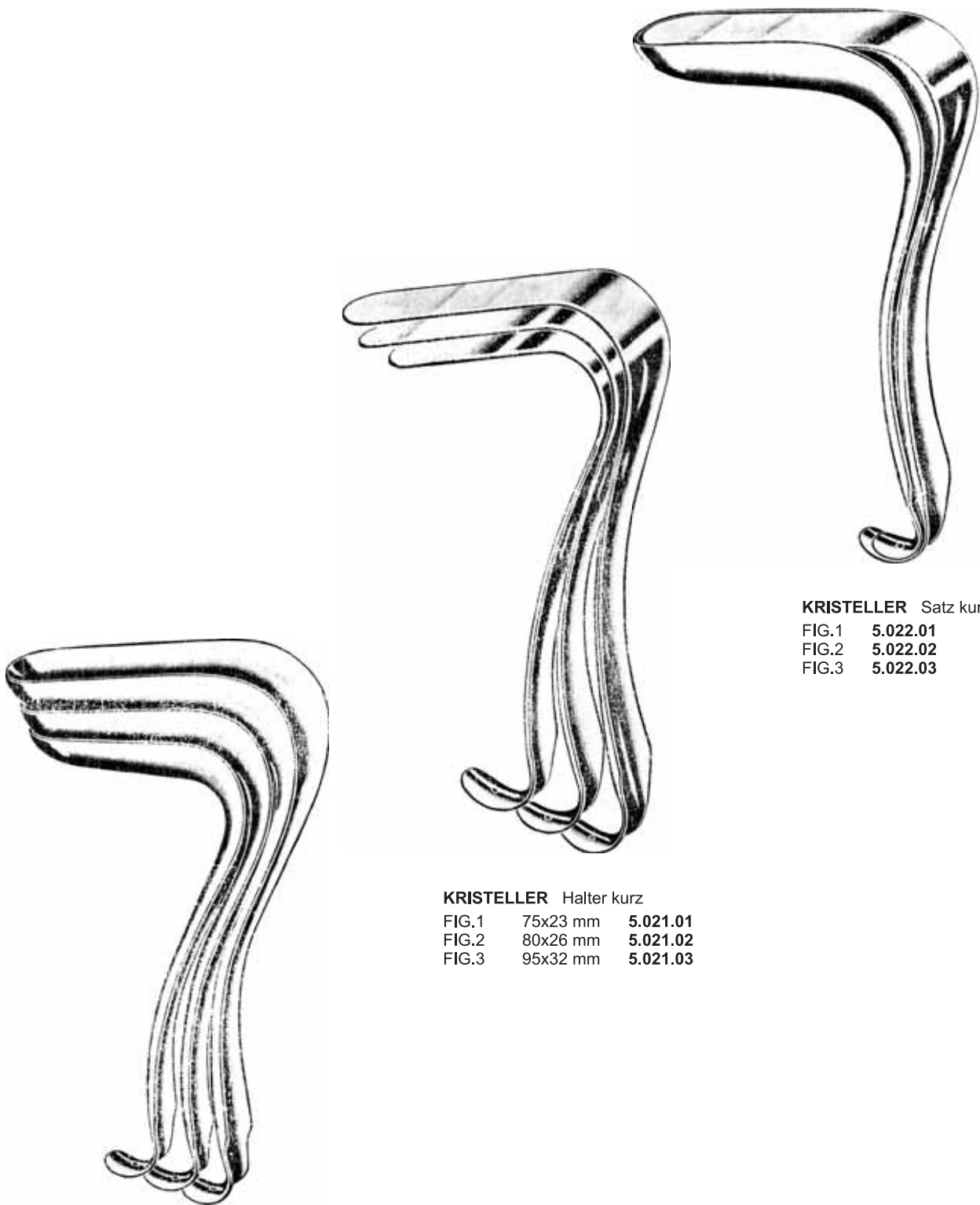
FIG.1 70x27 mm 5.020.01
FIG.2 75x30 mm 5.020.02
FIG.3 90x36 mm 5.020.03

**Scheidenspekula
Vaginal Specula****KRISTELLER Satz lang**

FIG.1 5.028.01
FIG.2 5.028.02
FIG.3 5.028.03

KRISTELLER Halter lang

FIG.1 110x23 mm 5.027.01
FIG.2 110x36 mm 5.027.02
FIG.3 110x32 mm 5.027.03

KRISTELLER Spekulum lang

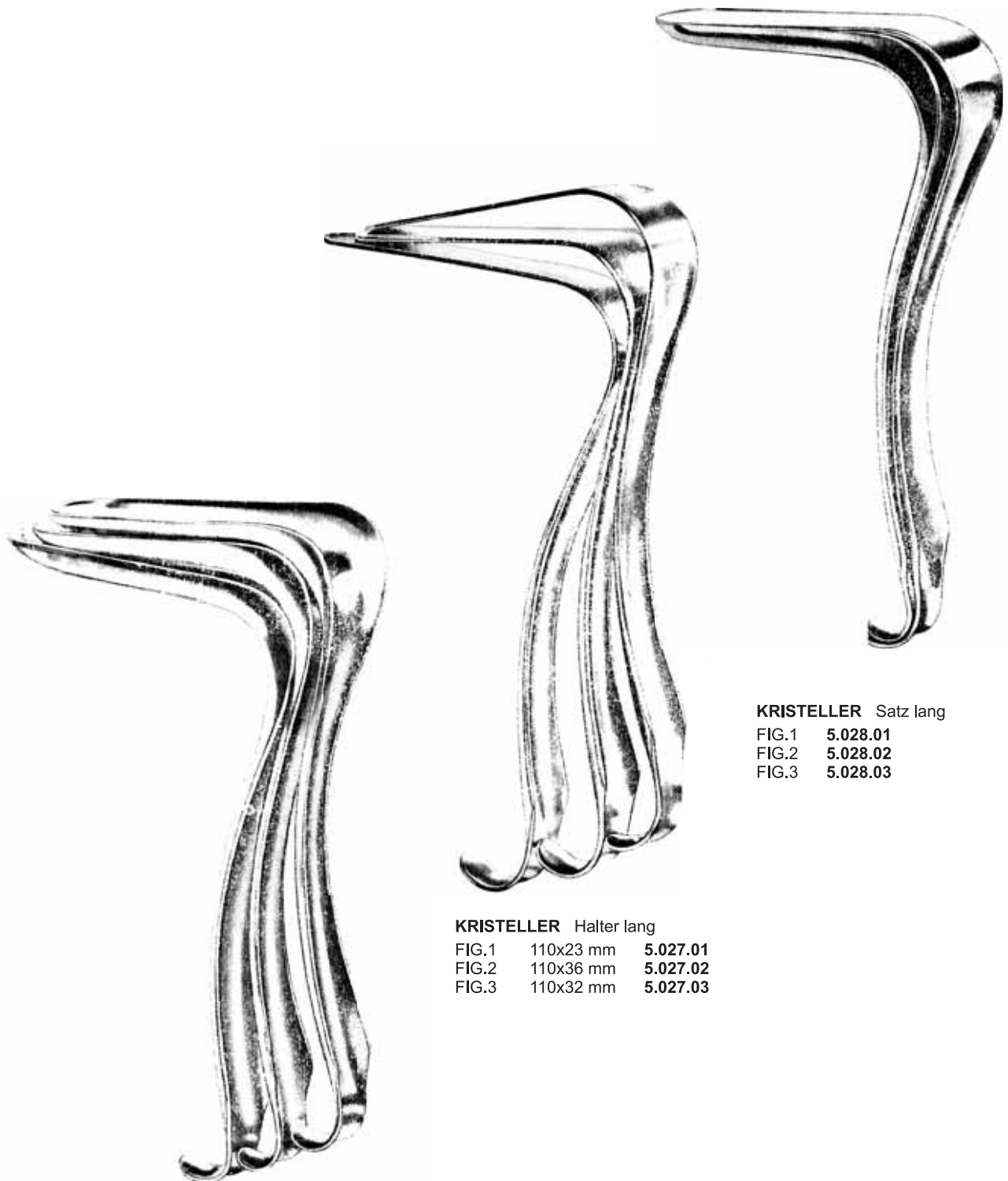
FIG.1 110x27 mm 5.026.01
FIG.2 110x30 mm 5.026.02
FIG.3 110x36 mm 5.026.03

Scheidenspekula
Vaginal Specula

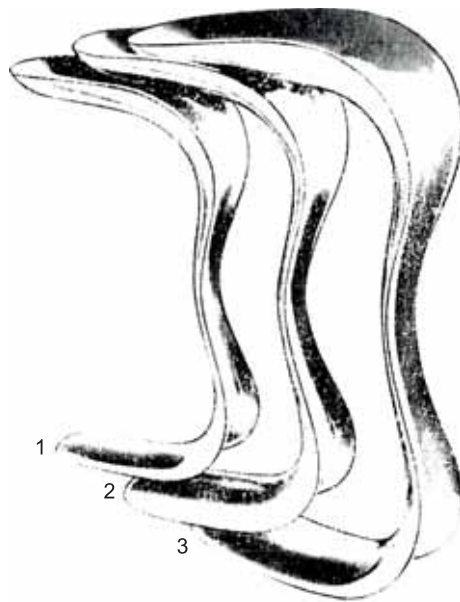

SIMS

FIG.1	25x30 mm	5.040.01
FIG.2	30x35 mm	5.040.02
FIG.3	35x40 mm	5.040.03

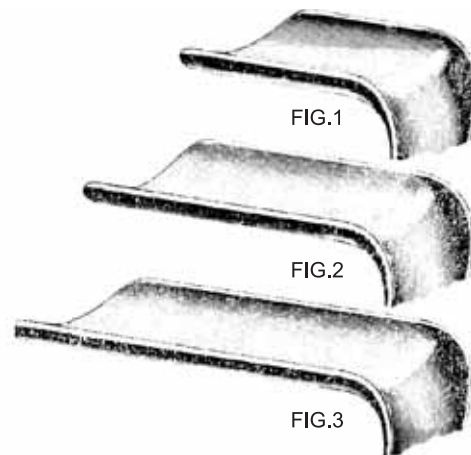
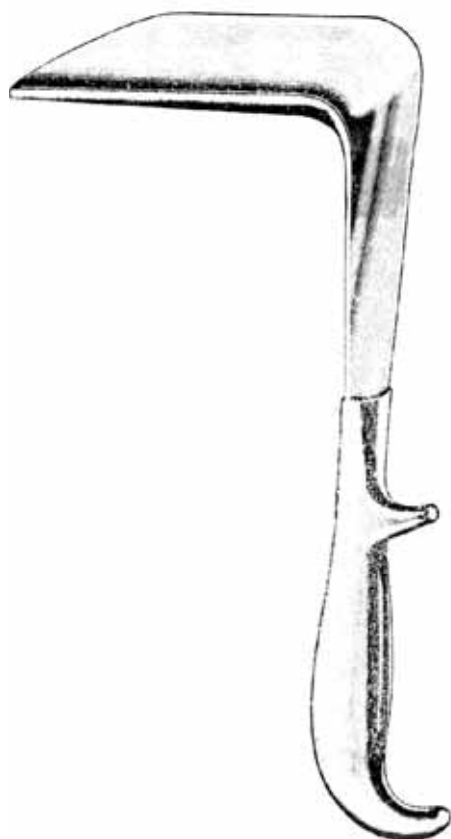

DOYEN leicht hohl

FIG.1	55x35 mm	5.045.01
FIG.2	85x35 mm	5.045.02
FIG.3	115x35 mm	5.045.03

FIG.1	55x45 mm	5.046.01
FIG.2	85x45 mm	5.046.02
FIG.3	115x45 mm	5.046.03

FIG.1	55x60 mm	5.047.01
FIG.2	85x60 mm	5.047.02
FIG.3	115x60 mm	5.047.03

Uterus Dilatoren
Uterine Dilators**HEGAR**
mit glattem Muldengriff

1 mm	5.070.01
2 mm	5.070.02
3 mm	5.070.03
4 mm	5.070.04
5 mm	5.070.05
6 mm	5.070.06
7 mm	5.070.07
8 mm	5.070.08
9 mm	5.070.09
10 mm	5.070.10
11 mm	5.070.11
12 mm	5.070.12
13 mm	5.070.13
14 mm	5.070.14
15 mm	5.070.15
16 mm	5.070.16
17 mm	5.070.17
18 mm	5.070.18
19 mm	5.070.19
20 mm	5.070.20
21 mm	5.070.21
22 mm	5.070.22
23 mm	5.070.23
24 mm	5.070.24
25 mm	5.070.25
26 mm	5.070.26
27 mm	5.070.27
28 mm	5.070.28
29 mm	5.070.29
30 mm	5.070.30

**HEGAR**
mit glattem Muldengriff

1,5 mm	5.071.01
2,5 mm	5.071.02
3,5 mm	5.071.03
4,5 mm	5.071.04
5,5 mm	5.071.05
6,5 mm	5.071.06
7,5 mm	5.071.07
8,5 mm	5.071.08
9,5 mm	5.071.09
10,5 mm	5.071.10
11,5 mm	5.071.11
12,5 mm	5.071.12
13,5 mm	5.071.13
14,5 mm	5.071.14
15,5 mm	5.071.15
16,5 mm	5.071.16
17,5 mm	5.071.17
18,5 mm	5.071.18
19,5 mm	5.071.19

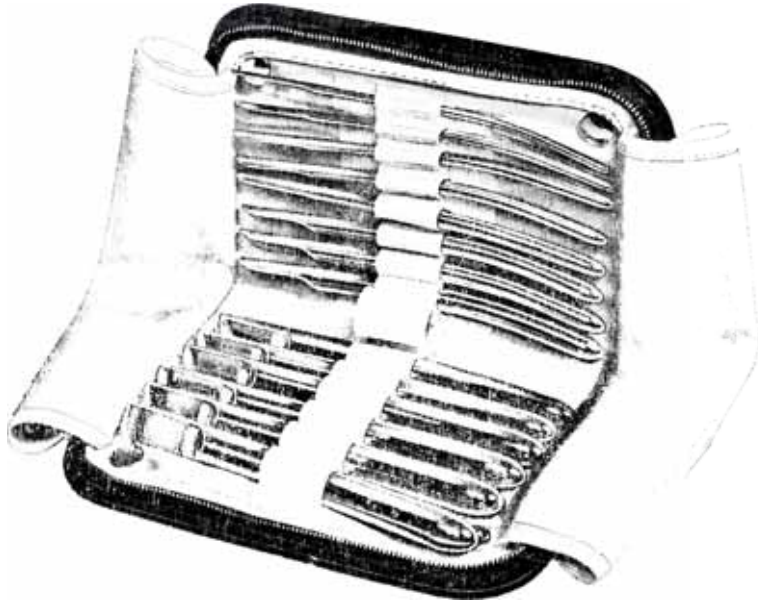
Uterus Dilatoren
Uterine Dilators

Satz mit Dilatoren
im Lederetui
(4mm bis 17 mm)

5.080.17

Satz mit Dilatoren
im Metalletui
(4mm bis 17 mm)

5.082.17

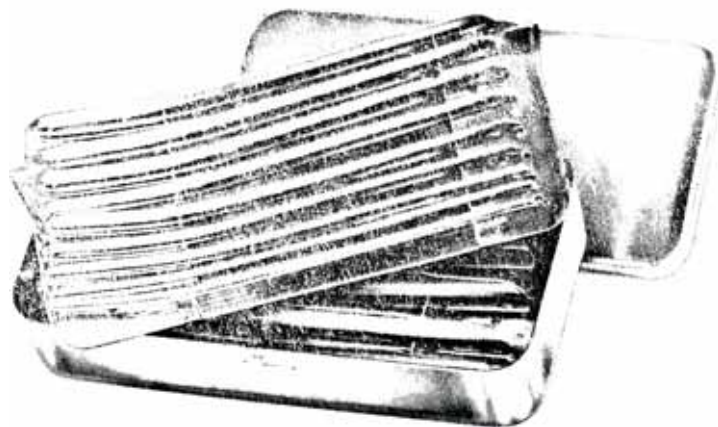

Uterus Dilatoren
Uterine Dilators**HEGAR Uterusdilatoren, doppelt**

Ø in mm

1,0 / 2,0	5.090.02
3,0 / 4,0	5.090.04
5,0 / 6,0	5.090.06
7,0 / 8,0	5.090.08
9,0 / 10,0	5.090.10
11,0 / 12,0	5.090.12
13,0 / 14,0	5.090.14
15,0 / 16,0	5.090.16
17,0 / 18,0	5.090.18
19,0 / 20,0	5.090.20
21,0 / 22,0	5.090.22
23,0 / 24,0	5.090.24
25,0 / 26,0	5.090.26

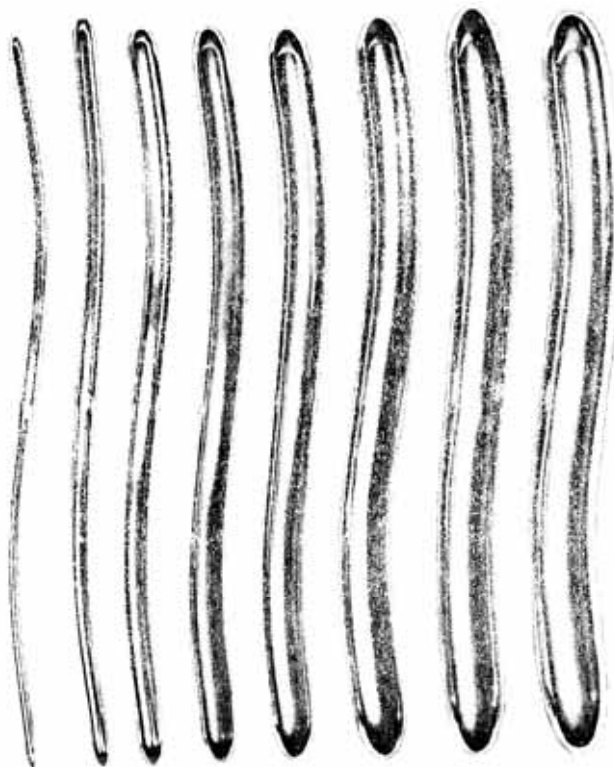
**HEGAR Uterusdilatoren**Satz mit 8 Dilatoren
3,0 / 4,0 - 17,0 / 18,0 mm**5.094.18**Satz mit 13 Dilatoren
1,0 / 2,0 - 25,0 / 26,0 mm**5.095.18**

Uterus Dilatoren und Uterussonden
Uterine Dilators and Uterine sonds

HANK
Satz mit 6 Dilatoren
9,0 / 10,0 - 19,0 / 20,0 mm

5.100.20

SIMS Uterussonde 32,0 cm

starr graduiert **5.130.32**
biegsam graduiert **5.131.32**



Uterusküretten
Uterine Curettes



SIMS Uteruskürette
26 cm

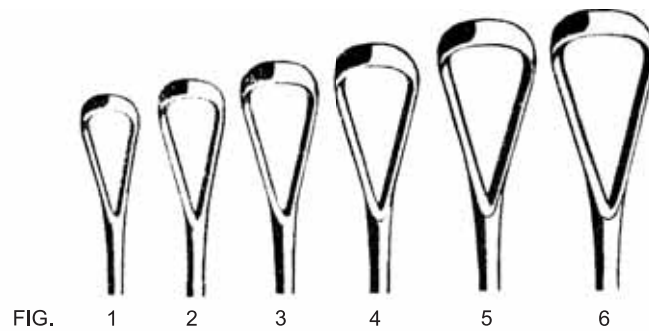
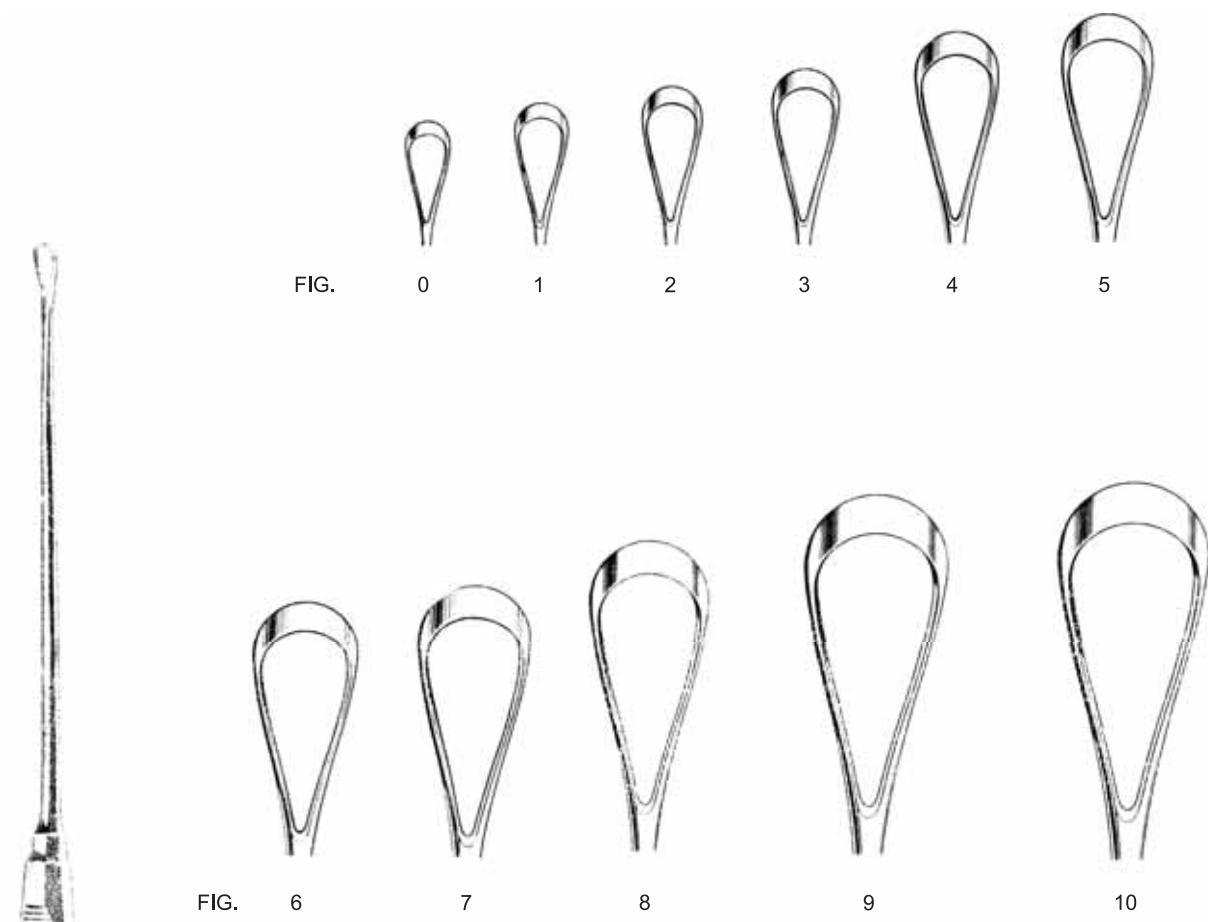

FIG.	1	2	3	4	5	6
	scharf fest	scharf biegsam		stumpf fest		stumpf biegsam
FIG. 1	5.150.01	5.151.01		5.152.01		5.153.01
FIG. 2	5.150.02	5.151.02		5.152.02		5.153.02
FIG. 3	5.150.03	5.151.03		5.152.03		5.153.03
FIG. 4	5.150.04	5.151.04		5.152.04		5.153.04
FIG. 5	5.150.05	5.151.05		5.152.05		5.153.05
FIG. 6	5.150.06	5.151.06		5.152.06		5.153.06

Uterusküretten Uterine Curettes



RECAIMER Küretten

31,0 cm

FIG. 0 1 2 3 4 5
FIG. 6 7 8 9 10

	scharf fest	scharf biegsam	stumpf fest	stumpf biegsam
FIG. 0	5.160.00	5.161.00	5.162.00	5.163.00
FIG. 1	5.160.01	5.161.01	5.162.01	5.163.01
FIG. 2	5.160.02	5.161.02	5.162.02	5.163.02
FIG. 3	5.160.03	5.161.03	5.162.03	5.163.03
FIG. 4	5.160.04	5.161.04	5.162.04	5.163.04
FIG. 5	5.160.05	5.161.05	5.162.05	5.163.05
FIG. 6	5.160.06	5.161.06	5.162.06	5.163.06
FIG. 7	5.160.07	5.161.07	5.162.07	5.163.07
FIG. 8	5.160.08	5.161.08	5.162.08	5.163.08
FIG. 9	5.160.09	5.161.09	5.162.09	5.163.09
FIG. 10	5.160.10	5.161.10	5.162.10	5.163.10

Beckenzirkel und Geburtszangen
Pelvimeters and Obstetrical Forceps



MARTIN
34 cm 5.180.34



COLLIN
35 cm 5.182.35



MARTIN
33 cm 5.184.33



NAEGELE
36 cm 5.200.36
40 cm 5.200.40

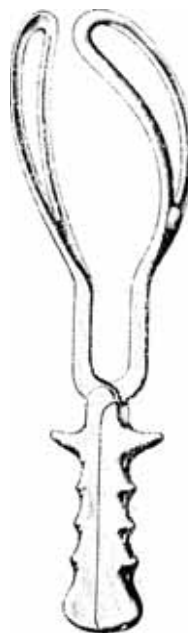

SIMPSON BROWN
36 cm 5.204.36

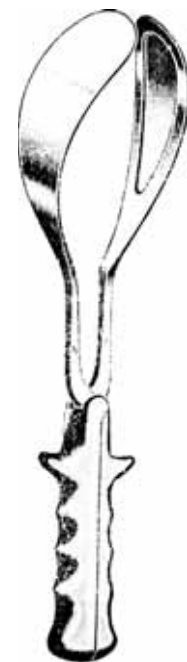

SIMPSON LUIKART
36 cm 5.230.36

Geburtszangen
Obstetrical Forceps



SIMPSON
30 cm 5.232.30

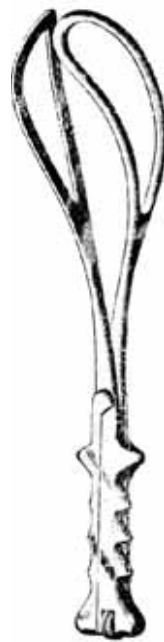

ELLIOT
32 cm 5.234.32
38 cm 5.234.38



KIELLAND
41 cm 5.236.41



KIELLAND LÜIKART
40 cm 5.238.40



LÜIKART
40 cm 5.240.40



MC LEAN
36 cm 5.244.36

Geburtszangen
Obstetrical Forceps



MC LEAN TUCKER
39 cm 5.246.39



PIPER
44 cm 5.248.44

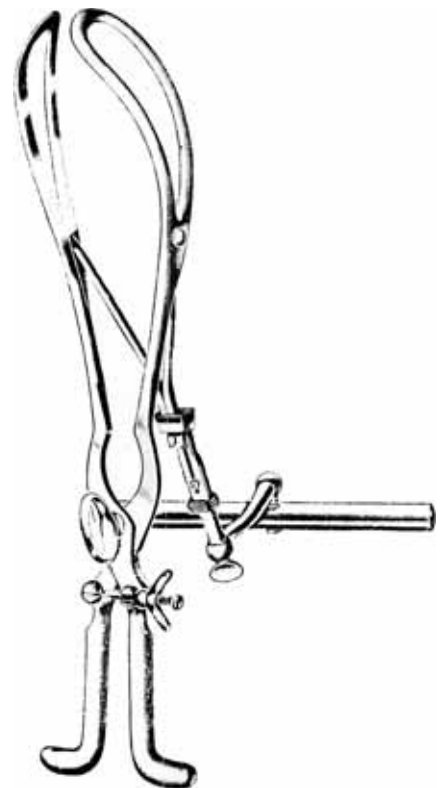

TARNIER mit Zughebel
44 cm 5.248.44



BILL Zughebel
5.262.01



LUIKART BILL Zughebel
5.262.01

Inhaltsverzeichnis

Table of contents

Abortuszangen	30, 31	CARMALT ROCHESTER, Arterienklemmen	6
ADAIR-ALLIS, Gewebefaßzängchen	24	CARMALT WALTER, Splitterpinzetten	52
ADLERKREUTZ, chir. Pinzetten	48	CASTROVIEJO, Fixierpinzetten	61
ADSON, anat. Pinzetten	41	Chalazionspinzetten	63
Arterienklemmen	6, 7	CHEATLE, Sterilisierzange	22
chir. Pinzetten	46	CHERON, Korn- u. Tupferzange	20
Nadelhalter	37	CHILD, Darmfaßzangen	26
ADSON BROWN, chir. Pinzetten	46	CHILD, Wundrand-Faßpinzette	55
ADSON MICRO, anat. Pinzetten	41	Chir. Pinzetten	44-49
chir. Pinzetten	46	feines Modell	51
ALLIS, Darmfaßzängchen	24	Cilienpinzetten	53
ALLIS ADIR, Gewebefaßzängchen	24	COLLIER, Nadelhalter	35
ALLIS BABY, Gewebefaßzängchen	24	COLLIN, Beckenzirkel	75
ALLIS BOYS, Gewebefaßzängchen	24	Scheidenspekula	65
ALLIS JUDD, Gewebefaßzängchen	25	Tupferzangen	19
ALLIS LOCKWOOD, Gewebefaßzängchen	25	Uterus-Faßzangen	30
ALLIS THOMS, Darmfaßzängchen	25	Zungenzangen	31
Anatomische Pinzetten	40-43	COLLIN DUVAL, Faßpinzetten	50
feines Modell	51	CRAFOORD, Arterienklemme	8
ARMYTAGE-GREEN, Uterusklemmzange	31	CRILE, Arterienklemme	5
ARRUGA-GILL, Kapselpinzette	60	Nadelhalter	38
Arterienklemmen	1-11	CRILE MURRAY, Nadelhalter	35
Atrauma-Pinzetten	57	CRILE RANKIN, Arterienklemme	5
Augen-Faßpinzetten	61	CRILE WOOD, Nadelhalter	36
Augen-Fixierpinzetten	60-61	CULLEN WERTHEIM, Hysterektromie-	
Kapselpinzetten	60	klemmen	15
Muskelpinzetten	62	CUSCO Scheidenspekula	64
Nahtpinzetten	61	CUSHING, Dura-Pinzetten	42, 47
AYER, Chalazionspinzetten	63	DANDY, Arterienklemmen	3
BABCOCK, Darmfaßzange	25	Darm-Gewebefaßzängchen	24, 25, 31
BABY ALLIS, Gewebefaßzängchen	24	Klemmen	26
BABY MICULICZ, Peritoneumklemme	16	Quetschklemmen	26
BABY MIXTER, Arterienklemmen	10	DARTIGUES, Uterusfaßzangen	29
BABY SATINSKY, Klemme	23	DAVIS, Faßpinzetten	56
BACKHAUS, Tuchklemme	17	Sterilisierpinzetten	56
BARRAQUER, Cilienpinzette	53	DE BAKEY, atraum. Pinzetten	57
BARRAYA STILLE, chir. Pinzette	48	Deckglaspinzetten	56
BAUMGARTNER HEGAR, Nadelhalter	36	DERF, Nadelhalter	35
Beckenzirkel	75	DESJARDINS, Gallenkanalklemmen	14
BEER, Cilienpinzetten	53	DESMARRES, Chalazionspinzetten	63
BERGH, Cilienpinzette	53	Dilatatoren-Uterus	69-72
BILL, Zughebel	77	DOUGLAS, Cilienpinzetten	53
BISHIPH HARMAN, Irispinzetten	60	DOUGLAS BOZEMANN, Schwamm- und	
BLAKE, Gallensteinzangen	27	Tupferzangen	20
BLAKE MAYO, Gallensteinzangen	27	DOYEN, Darmklemmen	26
BLAKESLEY WEIL, Nasenzangen	34	Ovarienzangen	29
BLASCOVICS, Muskelpinzetten	62	Scheidenspekula	68
BLOHMKE, Tonsillen-Klemmzange	32	DUEHRSEN, anat. Pinzetten	43
BONNEY, chir. Pinzette	48	chir. Pinzetten	48
BOYS ALLIS, Gewebefaßzängchen	34	DUPLAY, Fremdkörper- und Polypen-	
BOZEMANN, Schwamm- u. Tupferzange	20	zangen	18
BOZEMANN DOUGLAS, Schwamm- und		DURANTE, chir. Pinzetten	49
Tupferzange	20	DUVAL, chir. Pinzetten	50
BRAUM SIMPSON, Geburtszangen	75	Darmfaßzangen	25
BREISKY, Beckenzirkel	75	DUVAL COLLIN, Faßpinzetten	50
Bronchusklemmen	10	ELLIOT, Geburtszangen	76
BROPHY, anat. Pinzetten	43	ELSCHNIG, Faßpinzetten	61
chir. Pinzetten	48	Faßpinzetten	61
BROWN, Nadelhalter	36	FAURE, Klemmzange	16
BRUENINGS, Septumzangen	33	FEILCHENFELD, Splitterpinzette	52

Inhaltsverzeichnis Table of contents

Feine Pinzetten	51	KRISTELLER, Scheidenspekula und Halter	66, 67
FERRIS SMITH, chir. Pinzette	49	KUEHNE, Deckglaspinzette	56
FINOCHIETTO, Gallenkanalklemme	11	Küretten, Uterus	73, 74
Nadelhalter	38	LAHEY, Gallenkanalklemmen	11
Fixierpinzetten	60, 61	LAMBERT, Chalazionspinzette	63
FOERSTER, Schwammzangen	21	LANDAU COLLIN, Scheidenspekula	65
FUCHS GILL, Kapselpinzette	60	LANE, chir. Pinzetten	49
Gallenkanalklemme	13, 14	Tuch- u. Faßklemme	19
Gallensteinzangen	27	LERCHE, chir. Pinzetten	53
GAYLOR THOMS, Probeexzisionszange	30	LERICHE, Arterienklemmen	6
Geburtszangen	75-77	LESTER, Faßpinzetten	61
Gefäßklemmen	23, 24	Ligaturklemmen	7, 8, 9
GEISSENDORFER OVERHOLT, Arterien- und Präparierklemmen	8	LITTAUER, Cilienpinzetten	53
GERALD, anat. Pinzetten	42	LOCKWOOD-ALLIS, Gewebefaßzängchen	25
chir. Pinzetten	47	LORNA, Tuchklemmen	19
GILL, Irispinzetten	60	LOVELACE, Arterienklemmen	6
GILL ARRUGA, Kapselpinzette	60	Lungenfaßzangen	23
GILL FUCHS, Kapselpinzette	60	LOWER, Gallenkanalklemmen	11
GILL HESS, Irispinzette	60	LUCAE, Ohrpinzette	54
GILLIES, chir. Pinzette	46	LUIKART, Geburtszangen	76
GRAEFE, Fixierpinzette	61	LUIKART BILL, Zughebel	77
Irispinzette	58	LUIKART KIELLAND, Geburtszangen	76
GRAVE, Scheidenspekula	65	LUIKART SIMPSON, Geburtszangen	75
GRAY, Gallenkanalklemmen	13	Magenquetschklemmen	26
GREEN ARMYTAGE, Uterus-Klemmzange	31	MAGILL, Katheter-Einführungszange	22
GROSS, Kornzangen	20	MAIER, Tupferzangen	19
GRUENWALD, Tamponpinzetten	54	MAIER SIMS, Korn- u. Tupferzange	18
GUYON, Nierenstielklemme	12	MARSCHIK, Tonsillenpinzette	56
GUYON MAYO, Nierenstielklemme	13	MARTIN, Beckenzirkel	75
Gynäkologie	64-77	MASSON, Nadelhalter	37
HALSEY, Nadelhalter	35	MATHIEU, Nadelhalter	39
HALTED MOSQUITO, Arterienklemmen	2	Zungenzange	31
HANK, Uterus-Dilatatoren	72	MAYO, Nierenstielklemme	13
HARKEN, Gefäßklemme	24	MAYO BLAKE, Gallensteinzangen	27
HARMAN BISHOP, Irispinzette	60	MAYO GUYON, Nierenstielklemmen	13
HARTMANN, Arterienklemme	2	MAYO HEGAR, Nadelhalter	37
Polypenzange	33	MAYO ROBSON, Darmklemmen	26
Tonsillenzange	34	MAYO RUSS., Faßpinzetten	49
HEANEY, Klemmzangen	14	MC CULLOUGH, Strabismuspinzetten	62
Nadelhalter	37	MC INDOE, anat. Pinzetten	41
HEGAR, Uterusdilatoren	69-71	MC LEAN, Geburtszangen	76
HEGAR BAUMGARTNER, Nadelhalter	36	MC LEAN TUCKER, Geburtszangen	77
HEGAR-OLSEN, Nadelhalter	38, 39	MICHEL, Wundklammer-Pinzetten	55
HEGENBARTH, Wundklammerpinzetten	55	MICRO ADSON, anat. Pinzetten	41
HEISS, Arterien- u. Präp.-Klemme	7	chir. Pinzetten	46
HESS, Irispinzetten	59	MIKULICZ, Peritoneumklemmen	16
HESS-GILL, Irispinzetten	60	MIKULICZ-BABY, Peritoneumklemmen	16
JUDD ALLIS, Gewebefaßzängchen	25	MIXTER, Gallensteinzangen	10
Kapselpinzetten	60	Arterienklemmen	10
Katheterzangen	22	MIXTER BABY, Arterien u. Präparier-	10
KELLY, Arterienklemmen	3	klemmen	
KELLY RANKIN, Arterienklemme	3	MIXTER OVERHOLT, Arterien- und	
KIELLAND, Geburtszangen	76	Präparierklemmen	8
KIELLAND LUIKART, Geburtszangen	76	MIXTER O'SHAUGNESSY, Arterien- und	
KILLIAN, Septumzange	33	Bronchusklemmen	10
Klemmen	1-24	Mod. USA, anat. Pinzetten	41
KNAPP, Trachompinzette	63	chir. Pinzetten	45
KOCHER, Arterienklemmen	4, 5	MOORFIELD, Nahtpinzette	61
Kornzangen	18-20	MOSQUITO HALSTED, Arterienklemme	2

Inhaltsverzeichnis

Table of contents

MOYNIHAN, Klemmzangen und Hysterektomieklemmen	16	SIMS, Scheidenspekula	68
MUSEUX, Hakenzangen	28	Uterussonden	72
Nadelhalter	36-39	SIMS MAIER, Korn- u. Tupferzangen	18
NAEGELE, Geburtszange	75	SINGLEY TUTTLE, Faßpinzetten	50
Nahtpinzetten	55	SKENE, Hakenzange	28
NEGUS, Gallenkanal- und Tonsillenklemmen	14	SMITH FERRIS, chir. Pinzetten	49
Neurochirurgische Pinzetten	46, 47	SMITH POTTS, anat. Pinzetten	43
Nierensteinzangen	27	chir. Pinzetten	47
Nierenstielklemmen	11-13	SOMER, Uterusfaßzangen	29
NOTO Uteruspolypenzangen	29	SPENCER WELLS, Arterienklemme	6
OCHSNER, Arterienklemmen	5	Splitter-Pinzetten	51, 52
Fadenpinzetten	55	-Zangen	52
OLSEN HEGAR, Nadelhalter	38, 39	Sterilisierpinzetten	56
O'SHAUGNESSY MIXTER, Arterien- und Bronchusklemmen	10	STEVENS, Irispinzetten	59
OVERHOLT GEISSENDOERFER, Arterien- und Präparierklemmen	8	STIEGLITZ, Splitterzangen	52
OVERHOLT MIXTER, Arterien- und Präparierklemmen	8	STILLE, anat. Pinzetten	41
PAUFIQUE, Fadenpinzette	61	chir. Pinzetten	45
PAYR, Darmquetschklemmen	26	Nierenstielklemmen	13
PEAN, Arterienklemmen	3, 4	STILLE BARRAYA, chir. Pinzette	48
PEAN ROCHESTER, Arterienklemme	4	ST. MARTIN, Nahtpinzette	61
PEET, Splitterzange	19	STONE, chir. Pinzette	48
PELKMANN, Fremdkörperzangen	19	Strabismuspinzetten	62
Peritoneumklemmen	16	STRATTE, Nadelhalter	38
PHANEUF, Klemmzangen	14	Tamponpinzetten	54
PIPER, Geburtszangen	77	TARNIER, Geburtszangen	77
POTTS SMITH, anat. Pinzetten	43	TAYLOR, anat. Pinzette	42
chir. Pinzetten	47	chir. Pinzette	46, 47
Präparier- Klemmen	7, 8, 9	THOMS ALLIS, Darmfaßzängchen	25
PRUESMANN, Uterusfaßzange	29	THOMS GAYLOR, Probeexzisionszange	30
RALK, Splitterzangen	52	TOENNIS, Arterienklemme	9
RAMPLEY, Schwammzangen	21	Tonsillen-Pinzetten	56
RANDALL, Nierensteinzangen	27	-Zangen	32, 34
RANKIN KELLY, Arterienklemmen	3	Trachompinzetten	63
RECAMIER, Uterusküretten	74	TROELTSCH, Tamponpinzetten	54
ROBSON MAYO, Darmklemmen	26	TROELTSCH WILDE, Ohrpinzetten	54
ROCHESTER CARMALT, Arterienklemmen	6	TUCHER MCLEAN, Geburtszange	77
ROCHESTER PEAN, Arterienklemmen	4	Tumorzangen	21
ROEADER, Tuchklemmen	17	Tupferzangen	17, 19, 20, 21
ROGGE, Sterilisierzange	22	TUTTLE SINGLEY	50
RUMEL, Arterien- u. Präp.-Klemmen	9	Uhrmacherpinzetten	56
RUSS. MOD. chir. Pinzette	49	ULRICH, Tupferzangen	17
SAENGER, Abortuszangen	31	USA-Modell, anat. Pinzetten	41
SAROT, Arterienklemmen	7	chir. Pinzetten	45
Nadelhalter	36	Uterus-Dilatatoren	69-72
SATINSKY, Klemmzangen	23	-Faßzangen	29, 30
SATINSKY BABY, Klemmzangen	23	-Klemmzangen	31
SATTLER, Muskelpinzetten	62	-Polypenzangen	29
Scharfe Nasenzangen	34	-Sonden	72
Scheiden-Spekula	64-68	WACHENFELDT, Wundklammerpinzette	55
SCHMIDT, Tonsillen-Klemmzangen	32	WALTER CARMALT, Splitterpinzetten	52
SCHROEDER, Hakenzangen	28	WANGENSTEEN, anat. Pinzetten	43
SCHUBERT, Probeexzisionszangen	30	Nadelhalter	37, 38
SCHWEIZER MODELL, Irispinzetten	59	WEBSTER, Nadelhalter	35
SEMKEN, anat. Pinzetten	42	WEIL BLAKESLEY, Nasenzangen	34
chir. Pinzetten	46	WELLS SPENCER, Arterienklemmen	6
SEMM, Scheidenspekula	65	WERTHEIM, Klemmzangen	15
Septumzangen	33	WETHEIM CULLEN, Klemmzangen	15
SHAAF, Cilien- u. Fremdkörper- pinzetten	53	WILDE TROELTSCH, Ohrpinzetten	54
SIMPSON, Geburtszangen	76	WILLIAMS, Darmgewebefaßzängchen	25
SIMPSON BRAUN, Geburtszangen	75	WINTER, Abortuszange	30
SIMOSON LUIKART, Geburtszangen	75	WOOD CRILE, Nadelhalter	36
		WORTH, Vorlagerungspinzetten	62
		Wundklammerpinzetten	55
		YOUNG, Zungenzangen	31
		Zangen	15-33
		Zughebel	77

ANTON HIPPI GMBH MEDICAL

Instrumente und Implantate

Annastrasse 25/1
D-78567 Fridingen
Germany

Postfach 80
D-78565 Fridingen
Germany

Tel: +49-(0)7463-99303-0
Fax: +49-(0)7463-99303-50

Mail: info@anton-hipp.de
www.anton-hipp.de