

HNO
ENT

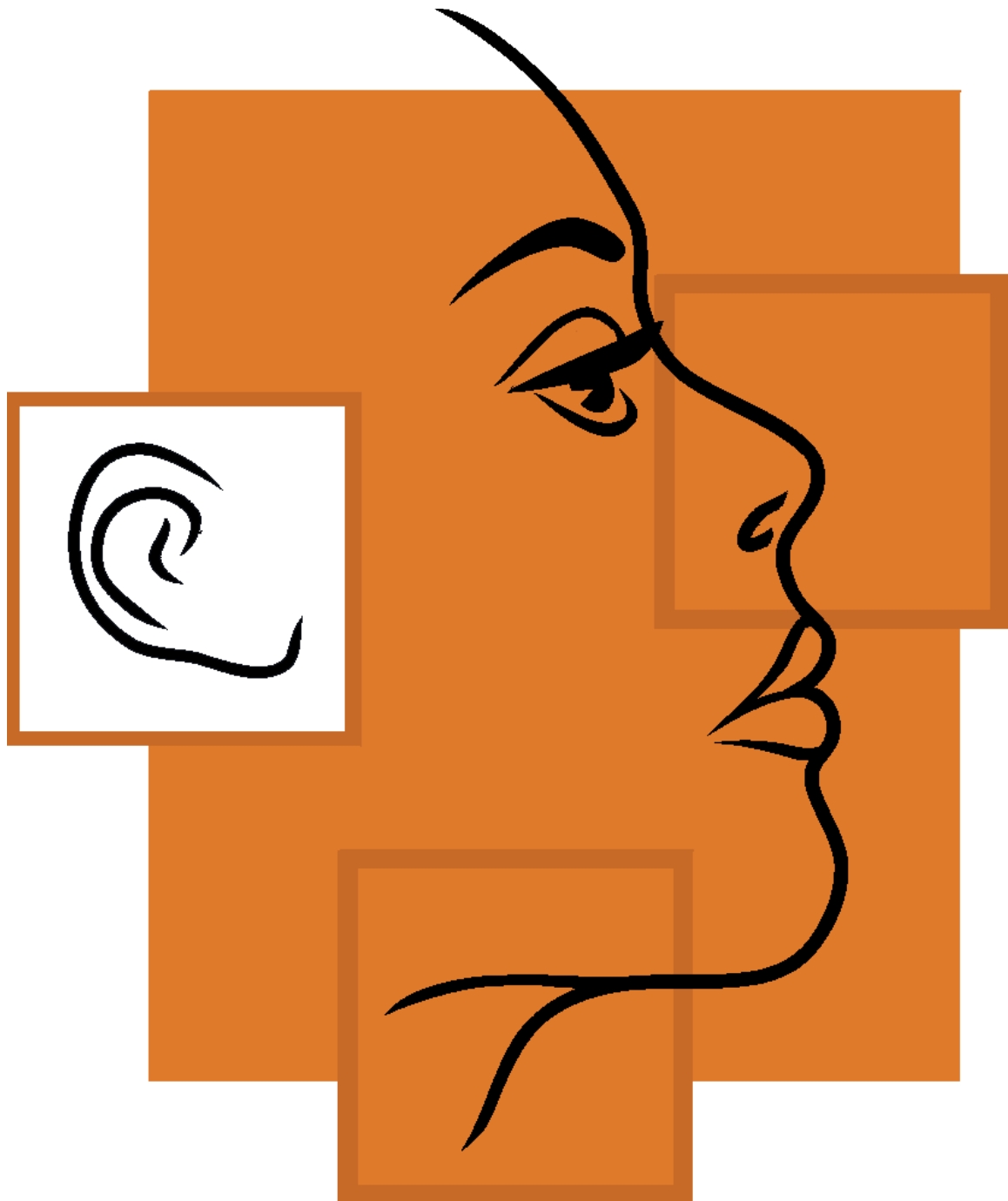

Otologie
Otology



Stimmgabeln Tuning Forks

c 128



c 128 **27.001.01**
c1 256 **27.001.02**
c2 512 **27.001.03**
c3 1024 **27.001.04**
c4 2048 **27.001.05**
c5 4096 **27.001.06**

c5 4096



Hartmann

c 128



c 128 **27.004.01**
c1 256 **27.004.02**
c2 512 **27.004.03**
c3 1024 **27.004.04**
c4 2048 **27.004.05**
c5 4096 **27.004.06**

c5 4096



Lucae



Hartmann
27.001.00

Besteck mit 5 Stimmgabeln, in Samtetaui,
bestehend aus:
Set of 5 Tuning Forks, in velvet lined case,
consisting of:

c 128 **27.001.01**
c1 256 **27.001.02**
c2 512 **27.001.03**
c3 1024 **27.001.04**
c4 2048 **27.001.05**

weitere Sätze auf Anfrage
additional sets on request



French
27.000.01
C-2 16



French
27.000.02
C-1 32



Hartmann
27.000.03
C 64



Hartmann
27.000.04
C 128



Hartmann
27.000.05
C1 256

Stimmgabeln Tuning Forks

Stimmgabeln für Ohren- und Nervenärzte
Tuning Forks for Aurists and Neurological Purposes



**Neurotone - 5
(Millet)**
27.018.00

Stimmgabel für neurologische Untersuchungen, mit Reflexhammer, Nadelrad, Pinsel und Nadel
Neurological Test Instrument, with tuning fork, percussion hammer, pinwheel, brush and needle



27.010.01
a'440



Koenig
27.015.01
A 109

verschiebbar bis g
variable up to g



Lucae
27.012.01
c 128
verschiebbar bis h
variable up to h (engl. B)



Hartmann
27.013.01
c 128
verschiebbar bis h
variable up to h (engl. B)



mit Dämpfern c 64
ohne Dämpfer c 128
with clamps c 64
without clamps c 128

Rydel-Seiffer
27.008.01

Saugkanülen, Ohrkatheter Suction Tubes, Eustachian Catheters

Saugkanülen
Suction Tubes



13cm/5"

- 24.902.06 = 2,0 mmØ Charr. 6
- 24.902.07 = 2,3 mmØ Charr. 7
- 24.902.08 = 2,7 mmØ Charr. 8
- 24.902.09 = 3,0 mmØ Charr. 9
- 24.902.10 = 3,3 mmØ Charr.10
- 24.902.11 = 3,7 mmØ Charr. 11
- 24.902.12 = 4,0 mmØ Charr.12

Frazier

Ohrkatheter
Eustachian Catheters

Metallolive mit Luer-Konus, für Hartmann-Katheter
Metal connector with Luer-tip, for Hartmann Catheters

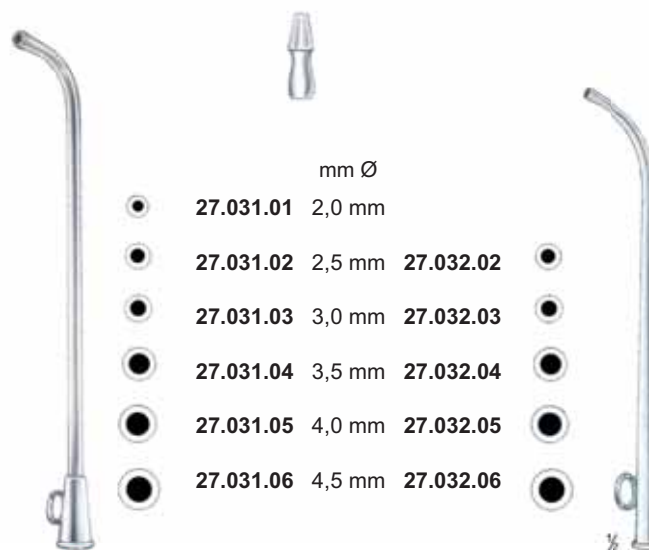

mm Ø

- | | | | | | |
|---|-----------|--------|--|---|-----------|
| ● | 27.031.01 | 2,0 mm | | ● | 27.032.02 |
| ● | 27.031.02 | 2,5 mm | | ● | 27.032.03 |
| ● | 27.031.03 | 3,0 mm | | ● | 27.032.04 |
| ● | 27.031.04 | 3,5 mm | | ● | 27.032.05 |
| ● | 27.031.05 | 4,0 mm | | ● | 27.032.06 |
| ● | 27.031.06 | 4,5 mm | | ● | |

Hartmann

Saug- und Spülinstrumente Aspirating and Irrigating Instruments



24.944.02

Schlauchverbindungsstück mit Luer-Konus und Unterbrecherpalette
Suction Adapter with Luer tin and thump valve

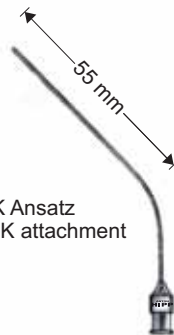

mit LUER-LOCK Ansatz
with LUER-LOCK attachment

Rosen

24.945.05	Ø 0,5 mm
24.945.06	Ø 0,6 mm
24.945.07	Ø 0,7 mm
24.945.08	Ø 0,8 mm
24.945.09	Ø 0,9 mm
24.945.10	Ø 1,0 mm
24.945.12	Ø 1,2 mm
24.945.14	Ø 1,4 mm
24.945.15	Ø 1,5 mm
24.945.18	Ø 1,8 mm
24.945.20	Ø 2,0 mm
24.945.25	Ø 2,5 mm
24.945.30	Ø 3,0 mm

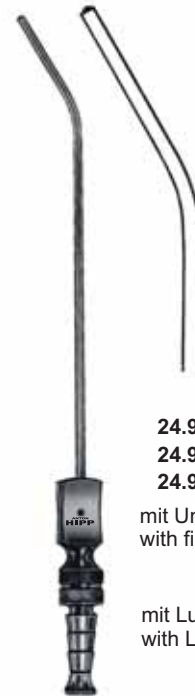

Plester
19 cm

24.903.06	Ø 2.0 mm = Charr. 6
24.903.08	Ø 2.6 mm = Charr. 8
24.903.10	Ø 3.3 mm = Charr.10

mit Unterbrecherplatte
with finger cut-off

mit Luer-Konus
with Luer cone



mit Luer-Konus
with Luer cone

Zöllner
18.5 cm

24.961.01

mit feinem Einsteckröhrchen Ø 0,7 mm
with detachable fine suction tip Ø 0.7 mm

15 cm
24.961.02
Saugrohr allein
(ohne Kanüle)
Aspirating Tube only
(without cannula)



Zöllner

24.961.05 Ø 0.5 mm

24.961.07 Ø 0.7 mm

Aufsetzbare Mikro-Saugkanüle
alleine, Nutzlänge 30 mm

Micro Suction Cannula only, for Suction
Tube, working length 30 mm



Baron (Schubknecht)

Ø charr. x Lmm

24.916.03 3 75

24.916.05 5 75

24.916.07 7 75

24.916.13 3 100

24.916.15 5 100

24.916.17 7 100

Saug- und Spülinstrumente Aspirating and Irrigating Instruments

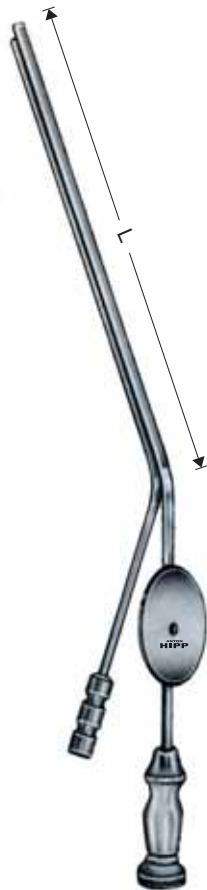

Spül- und Absauginstrument, mit Unterbrecherplatte
Irrigation and Suction Instruments, with thumb valve

L=9 cm				L=18 cm			
Saugrohr Suction Tube		Spülrohr Irrigation tube		Saugrohr Suction Tube		Spülrohr Irrigation tube	
mm Ø		mm Ø		mm Ø		mm Ø	
0.9	x	0.7	24.947.09	1.8	x	1.8	24.948.18
1.2	x	0.9	24.947.12	2.5	x	2.0	24.948.25
1.5	x	1.2	24.947.15	3.0	x	2.0	24.948.30
1.8	x	1.8	24.947.18				
2.5	x	2.0	24.947.25				
3.0	x	2.0	24.947.30				
4.5	x	2.0	24.947.45				

House-Luer



zylindrisch, Silber
cylindrical, silver

Luer

Wullstein
16 cm
24.946.02 Ø 1.5 mm
24.946.03 Ø 2.0 mm



Luer

Wullstein
16 cm
24.946.01

Spül- und Saughandgriff nach Wullstein, mit Unterbrecherplatte, passend für die Spül- und Absaugröhrchen nach Wullstein.

Handle with thumb valve for Wullstein suction tubes



Luer

Wullstein
10.5 cm
24.944.00

Politzer Luftdusche, Ohrspritzen Poltzer Air Bag, Ear Syringes



Gummibirne alleine
Rubber Bulb only
27.034.50

Politzer
komplett
complete
27.034.00



27.034.03
Einsteckkonus
Connecting Nozzle



4 mm Ø
27.034.04
Ohrolive
Ear tip



15 mm Ø
27.034.15



17 mm Ø
27.034.17
Nasenoliven
Nasal tips



22 mm Ø
27.034.22



Ohrspritzer, Ganzmetall, mit Luer-Lock-Ansatz, komplett mit
2 Kanülen und 1 Schutzteller, in Karton
Ear Syringe, all metal, with Luer-Lock mount, complete with 2 tips
and 1 shield, in cardboard box



27.043.05



27.043.06



27.043.03

	komplett complete	Spritze alleine Syringe only
50 ml	27.044.05	27.046.05
75 ml	27.044.07	27.046.07
100 ml	27.044.10	27.046.10

Pulverbläser Powder Blowers



13 cm
27.036.03

Ersatz-Glasbehälter, 30 ml
Spare Glass Bottle, 30 ml

27.036.01

Kehlkopfkanüle alleine, 13cm lang
Laryngeal Cannula only, 13 cm

27.036.03



11 cm
27.036.04

Ventilball allein
Rubber Bulb only

27.036.02

Nasenkanüle allein, 11 cm lang
Nasal Cannula only, 11 cm

27.036.04



8 cm
27.036.05

27.036.02

27.036.01

Ohrkanüle allein, 8 cm lang
Ear Cannula only, 8 cm

27.036.05

Kabierske
30 ml
27.036.00
komplett
complete

Pulverbläser, 30 ml, komplett mit je 1 Kanüle für Ohr, Nase, Kehlkopf
Powder Blower, 30 ml, complete with 1 ea cannula for ear, nose larynx



27.040.01

27.040.02

Universal
30 ml
27.040.00

Pulverbläser, 30 ml, mit beweglicher Düse und Halbgebläse
Powder Blower, 30 ml, with mobile nozzle and rubber bulb

dito, ohne Halbgebläse
same, without rubber bulb
27.040.01

Halbgebläse allein
Rubber bulb only
27.040.02

Ohrspekula Ear Specula



1 = Ø 1,8 mm
27.102.02
2 = Ø 3,2 mm
27.102.03
3 = Ø 4,6 mm
27.102.05

Hartmann
Stück Fig.
Pieces Fig.

Satz zu	3	1-3	27.102.00
Set of			

für Erwachsene
for adults



2 = Ø 3,5 mm
27.104.03
3 = Ø 5,0 mm
27.104.05
4 = Ø 6,5 mm
27.104.07
5 = Ø 7,5 mm
27.104.08

Hartmann
Stück Fig.
Pieces Fig.

Satz zu	3	3-5	27.104.00
Set of	4	2-5	27.104.01

für Kinder
for children



1 = Ø 2,0 mm
27.100.02
2 = Ø mm
27.100.03
3 = Ø mm
27.100.04
4 = Ø mm
27.100.05

Politzer
Stück Fig.
Pieces Fig.

Satz zu	3	1-3	27.100.00
Set of			

für Erwachsene
for adults



1 = Ø 3,0 mm 27.108.03
2 = Ø 4,0 mm 27.108.04
3 = Ø 5,0 mm 27.108.05
4 = Ø 6,5 mm 27.108.06

Toynbee
Stück Fig.
Pieces Fig.

Satz zu	3	2-4	27.108.00
Set of	4	1-4	27.108.01



27.109.12

Metallständer für Spekula
Metal Support for Specula

Ohrspekula Ear Specula



Brünings

27.120.00

Pneumatisches Ohrspekulum, in Holzetui, bestehend aus:
je 1 Ohrspekulum Fig. 1 - 4
1 Halbgebläse
1 Lupenkörper (Saugkammer)

Pneumatic Otoscope, in wooden case, consisting of:
1 ea. Ear Speculum fig. 1 - 4
1 Rubber Tube and Bulb
1 Suction Head



0

Ø 5,5 mm
27.120.05

1

Ø 6,5 mm
27.120.06

2

Ø 7,5 mm
27.120.07

Lupenkörper (Saugkammer)
Suction Head
27.120.20

Halbgebläse
Rubber Tube and Bulb
27.120.30

3

Ø 8,5 mm
27.120.08

4

Ø 9,5 mm
27.120.09

5

Ø 10,5 mm
27.120.10



Siegle

Pneumatisches Ohrspekulum,
kpl., bestehend aus:

je 1 Ohrspekulum Fig. 1 - 3
Lupenkörper (Saugkammer)

27.124.00 ohne Vergrößerung

27.124.01 mit Vergrößerung

Pneumatic Otoscope,
cpl., consisting of:
1 ea Ear Speculum fig. 1 - 3
1 Rubber Tube and Bulb
1 Suction Head

27.124.00 without enlargement

27.124.01 with enlargement

1

2

3



1



2



3

Lupe allein / Suction Head only

27.124.20 ohne Vergrößerung / without enlargement

27.124.21 mit Vergrößerung / with enlargement

Spekula allein / Specula only

27.124.06 = fig 1 = Ø 6,5 mm

27.124.07 = fig 2 = Ø 7,0 mm

27.124.08 = fig 3 = Ø 8,0 mm

27.124.30 Halbgebläse allein / Rubber Tube and Bulb only

Ohrküretten Ear Curettes



gerade / stumpf
straight / blunt



gerade / scharf
straight / sharp



Buck
16,5 cm



abgewinkelt / stumpf
angled / blunt

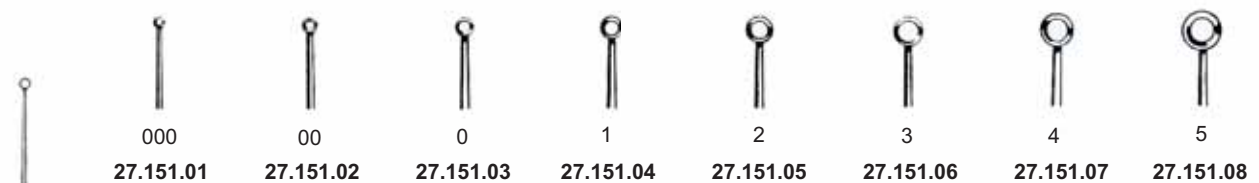

abgewinkelt / scharf
angled / sharp



Buck
16,5 cm

Ohrbestecke Ear Operating Sets



Ansatz allein
Stern only

27.290.01

Griff allein
Handle only

Hartmann
16 cm

27.290.00
Satz komplett
Set complete



Fig. 1

27.290.10

2

27.290.11

3

27.290.12

5

27.290.13

6

27.290.14

8

27.290.15

9

27.290.16



Griff allein
Handle only
27.292.01

Sprague
19 cm
27.292.00
Satz komplett
Set complete



27.292.10 Messer, Knife

27.292.14 Hakchen, Hook

27.292.17 Sonde, Probe

27.292.13 Nadel, Needle

27.292.15 Schlinge, Loop

27.292.16 Loffel, Spoon

Ohrmesser Ear Knives

Periostmesser
Periosteal Knife



Muck
13,5 cm
27.300.13

Mastoidmesser
Mastoi Knife



Politzer
13,5 cm
27.302.13

Furunkelmesser
Furunkel Knife



Politzer
16 cm
27.301.15



Buck
15 cm
27.302.16

Trommelfellmesser, Tympanum Knives



Fig. 1

Fig. 2

gerade
straight
27.304.01
27.304.02

Sexton

Fig.

gebogen
curved
27.305.01
27.305.02



Fig. 1

Fig. 2



Gerzog-Sexton
17 cm
27.306.17



16 cm



Gerzog
27.307.01



Buck
27.307.02

Ohrmesser und Nadeln Ear Knives and Needles



Politzer
16 cm
27.308.16



Agnew
16 cm
27.312.17



Politzer
16 cm
27.309.16



Nadel quergestellt
Needle horizontal

Politzer
16 cm
27.311.16



Lucae
18 cm
27.314.02



← für Kinder
for children

Lucae
16 cm
27.314.01



Nadel quergestellt
Needle horizontal

Lucae
18 cm
27.314.03



Bayer
10 cm
27.316.01



Nadel quergestellt
Needle horizontal



Bayer
10 cm
27.316.02

Doppelkralle, Ohrhebel, Ohrhäkchen

Double Pick, Ear Levers, Ear Hooks

Doppelkralle
Double Pick



14 cm
27.163.14

Ohrhebel
Ear Levers



Moldenhauer
16 cm
27.169.16



Zaufal
16 cm
27.167.16



Wagener
16 cm
27.168.16

Ohrhäkchen
Ear Hooks



Wagener
14 cm



Fig. 1
6.103.01



Fig. 2
6.103.02



Fig. 3
6.103.03



Fig. 4
6.103.04



Fig. 5
6.103.05



Fig. 6
6.103.06



Fig. 7
6.103.07

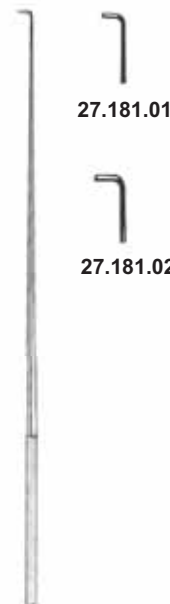

Day
16 cm

27.181.01

27.181.02



Allport
16 cm
27.182.16



Yankauer
15 cm
27.183.15

Wundspreizer, selbsthaltend
Self-retaining Retractor4 x Zähne scharf
4 x 4 teeth sharp**Jansen**
10 cm
6.214.084 x 4 Zähne stumpf
4 x 4 teeth blunt**Jansen**
10 cm
6.215.083 x 3 Zähne scharf
3 x 3 teeth sharp**Jansen**
10,5 cm
6.214.063 x 3 Zähne stumpf
3 x 3 teeth blunt**Jansen**
10,5 cm
6.215.06

Wundspreizer, selbsthaltend
Self-retaining Retractor

scharf
sharp



6.219.11
6.219.13

stumpf
blunt



6.220.11
6.220.13

Wullstein

11,5 cm
13 cm

stumpf
blunt

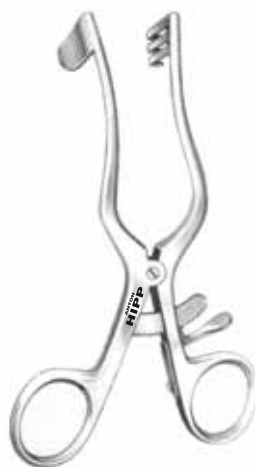

Perkins
13 cm
6.226.01

stumpf
blunt

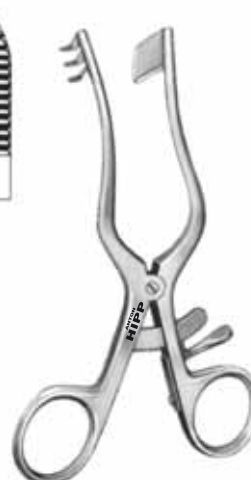

Perkins
13 cm
6.226.02

Wundspreizer, selbsthaltend
Self-retaining Retractor



Plester
13 cm
6.222.13



Plester
13 cm
6.222.13

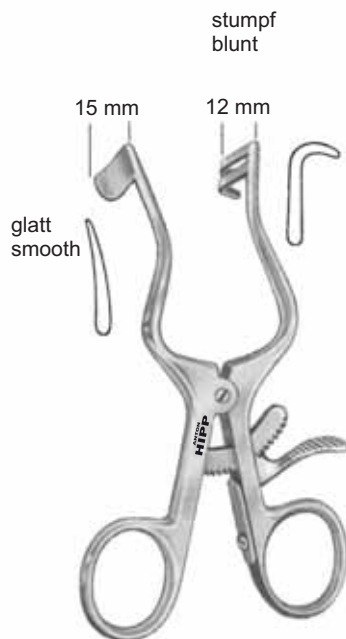

Plester
11 cm
6.224.11

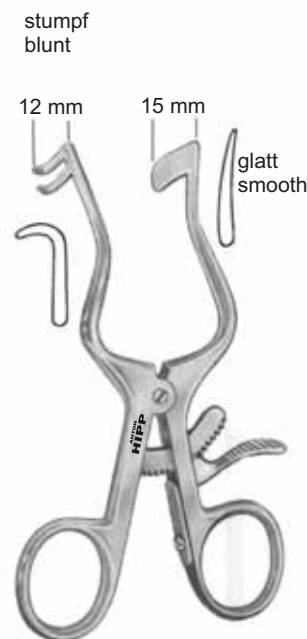

Plester
11 cm
6.225.11

Ohrpinzetten Ear Dressing Forceps

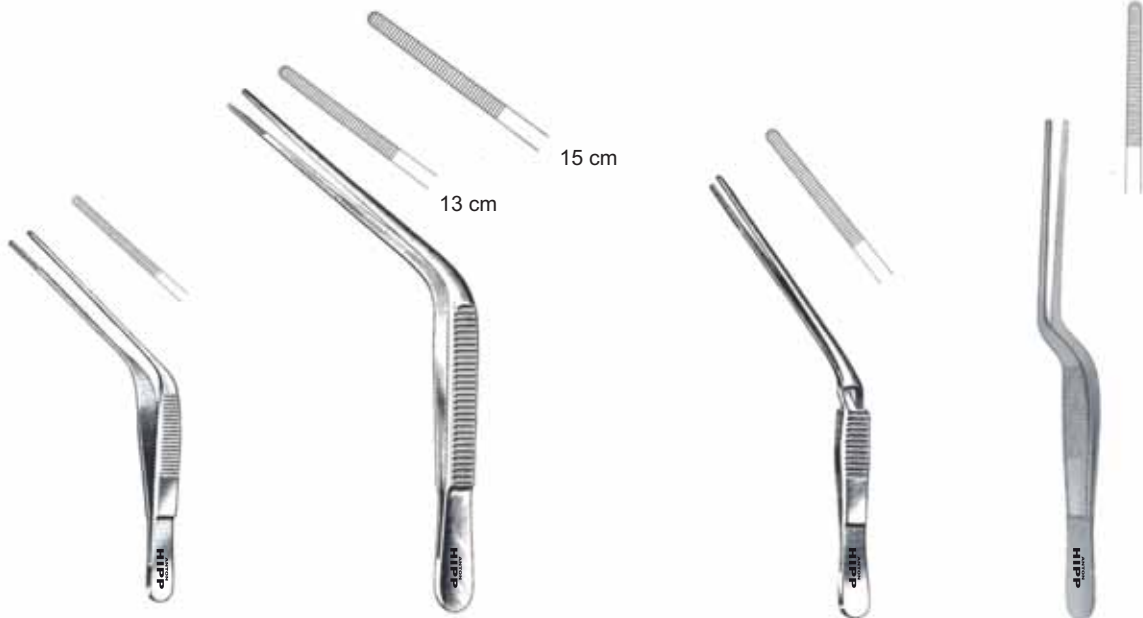

Troeltsch (Wilde)
11 cm
3.429.11

Troeltsch (Wilde)
3.429.13 = 13 cm
3.429.15 = 15 cm

Troeltsch
13 cm
3.433.13

Lucae
14 cm
3.437.17



Jansen
16 cm
3.441.16
19 cm
3.441.19
21 cm
3.441.21

Lucae
14 cm
3.443.14

Jansen
16 cm
3.443.16

Fremdkörperheber, Ohrpolypenzangen
Foreign Body Levers, Ear Polypus Forceps

Fremdkörperheber - Foreign Body Levers

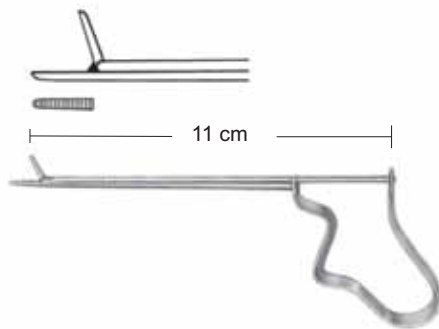

Buck
11 cm
27.202.09

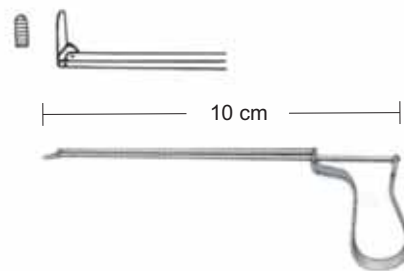

Quire
10 cm
27.200.09

Ohrpolypenzangen, Tamponzangen
Ear Polypus Forceps, Tampon Forceps

feines Modell
delicate pattern



Hartmann
13,5 cm
27.206.12

Standard
Standard



Hartmann
13,5 cm
27.208.14

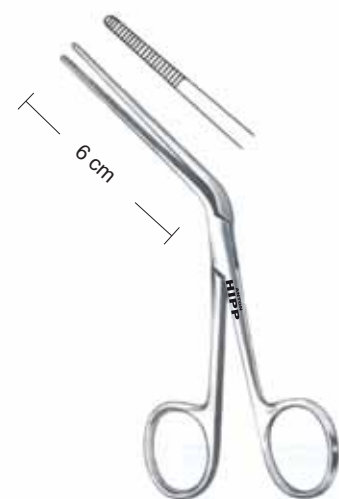

Tilley (Yankauer)
14 cm
26.601.13

Ohrpolypenzangen, Tamponzangen Ear Polypus Forceps, Tampon Forceps



Hartmann-Wullstein
27.210.07



Hartmann-Wullstein
27.212.08



Hartmann
8,5 cm = 27.214.08
14,0 cm = 27.214.14
16,0 cm = 27.214.16

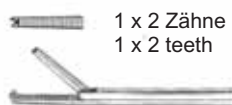

Hartmann
1 x 2 Zähne
1 x 2 teeth
8,5 cm = 27.216.08
14,0 cm = 27.216.14



Hartmann-Noyes
9,0 cm = 27.218.09



27.221.08
Entenschnabel
Duckbill



Weingärtner
27.222.08



Hartmann
27.224.08



Strümpel
27.230.08



Hartmann
2,0 mm = 27.226.01
2,5 mm = 27.226.02
3,0 mm = 27.226.03



Hartmann
2,0 mm = 27.228.01
2,5 mm = 27.228.02
3,0 mm = 27.228.03



Hartmann
27.229.08



Hartmann-Hoffmann
27.232.08

Ohrpolypenschnürer, Drahtinstrumente Ear Polypus Snares, Wire Instruments

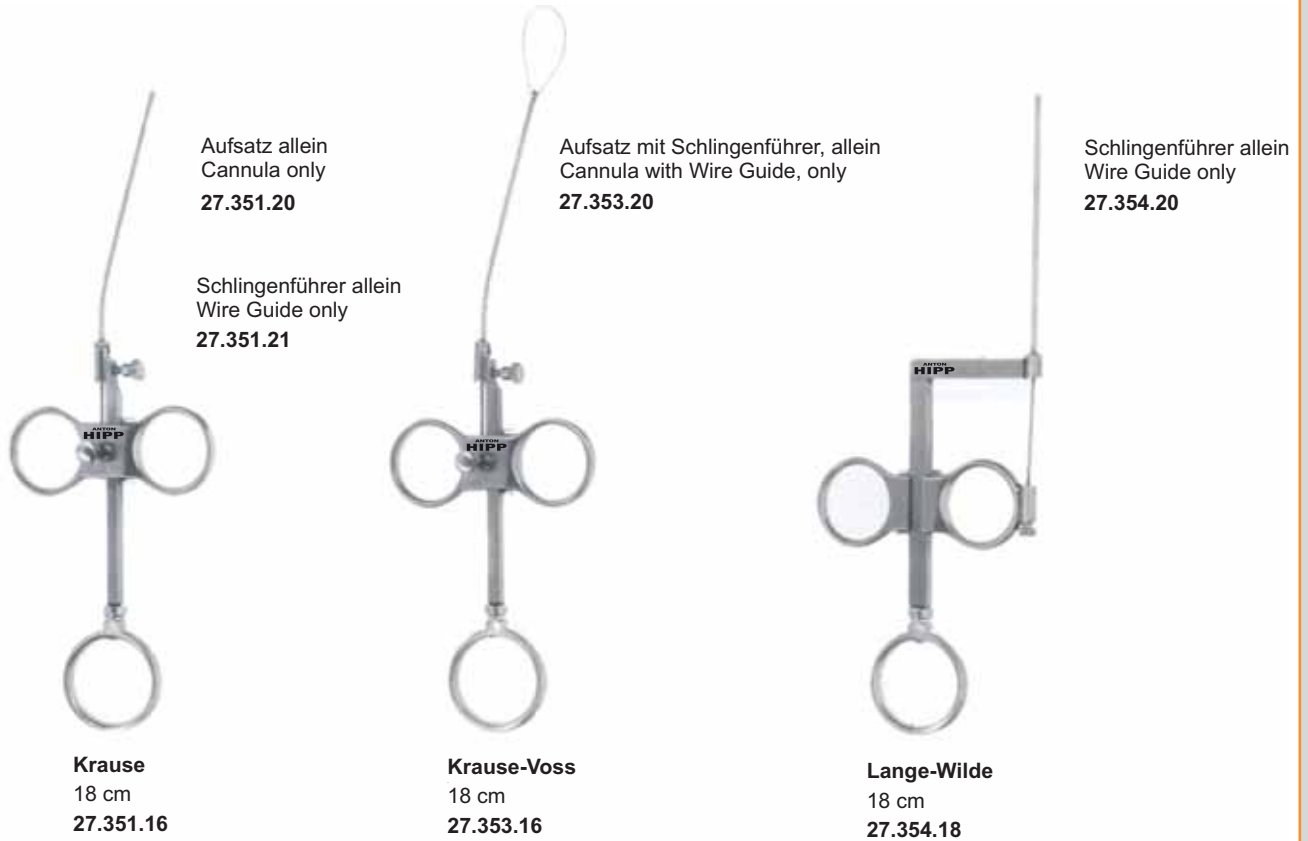

Stahldraht für Ohrpolypenschnürer
Steel Wire for Ear Polypus Snares



Ø 0,2 mm **27.358.20**
Ø 0,3 mm **27.358.30**



Bündel - Bundles

Ø mm	12	100
0,2	27.359.20	27.360.20
0,3	27.359.30	27.360.30

Drahtinstrumente
Wire instruments

0,8 / 1,2 mm



Mikrochirurgie des Ohres **Otological Microsurgery**

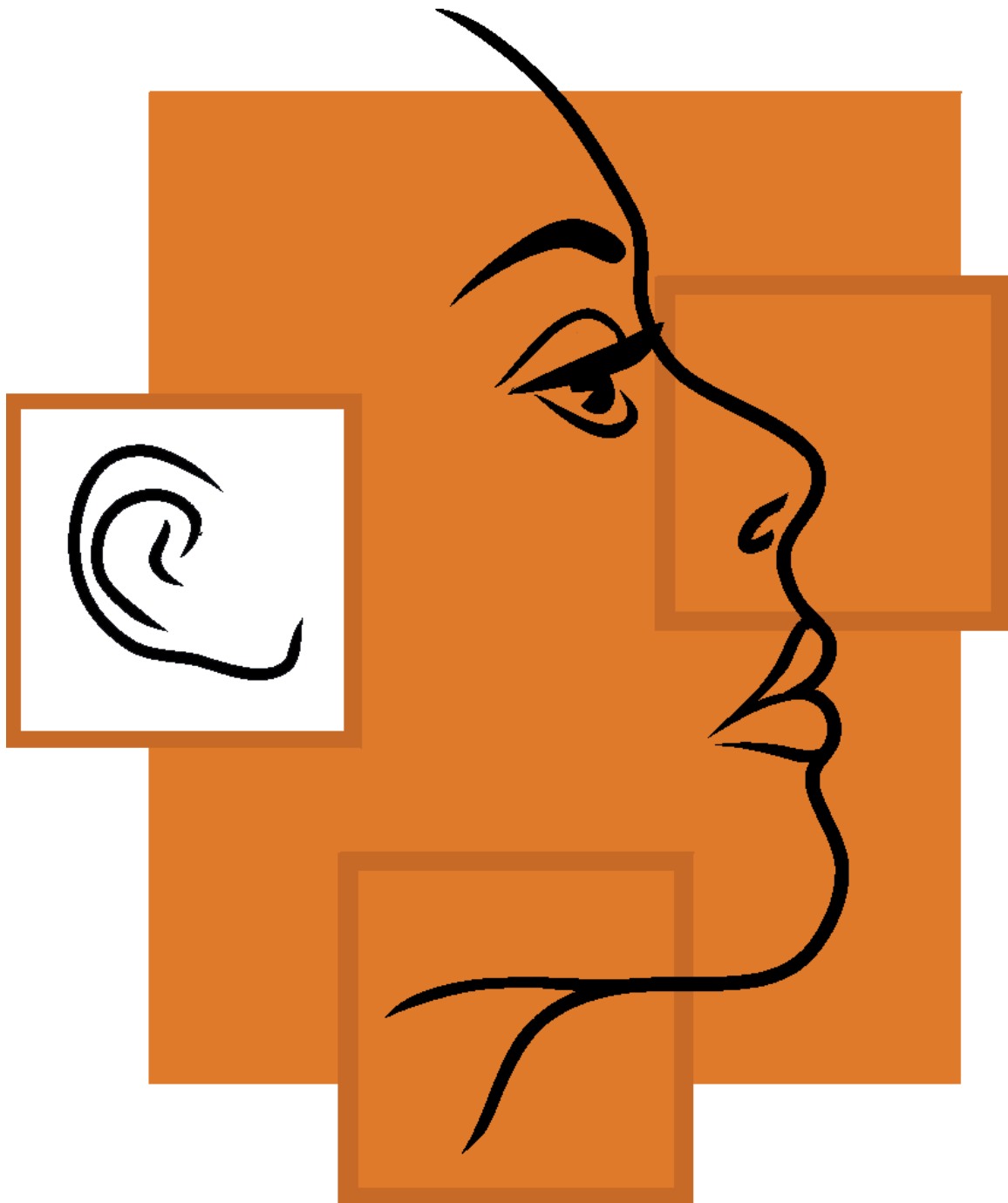

Ohrspekula, Mikro-Ohrküretten und -löffel Ear Specula, Mikro Ear Curettes and Spoons



Holmgren



5 mm Ø
27.126.05



6 mm Ø
27.126.06



7 mm Ø
27.126.07



3 mm Ø
27.127.03



5 mm Ø
27.127.05



7 mm Ø
27.127.07

scharf
sharp



stumpf
blunt



0000
000
00
0
1

Buck-Wullstein-Micro
16 cm

27.152.00	Fig. 0000	0,9 mm Ø	27.150.00
27.152.01	Fig. 000	1,1 mm Ø	27.150.01
27.152.02	Fig. 00	1,3 mm Ø	27.152.02
27.152.03	Fig. 0	1,8 mm Ø	27.152.03
27.152.04	Fig. 1	2,1 mm Ø	27.152.04

Ø = Innendurchmesser
Ø = inside diameter

1,5 x 2,5 mm



Shea
16 cm
27.520.01

1,5 mm x 2,5 mm



Shea
16 cm
27.521.01

Mikro- Ohrscheren nach Bellucci, Schienenschaft Micro Ear Scissors, Bellucci-type, alligator action

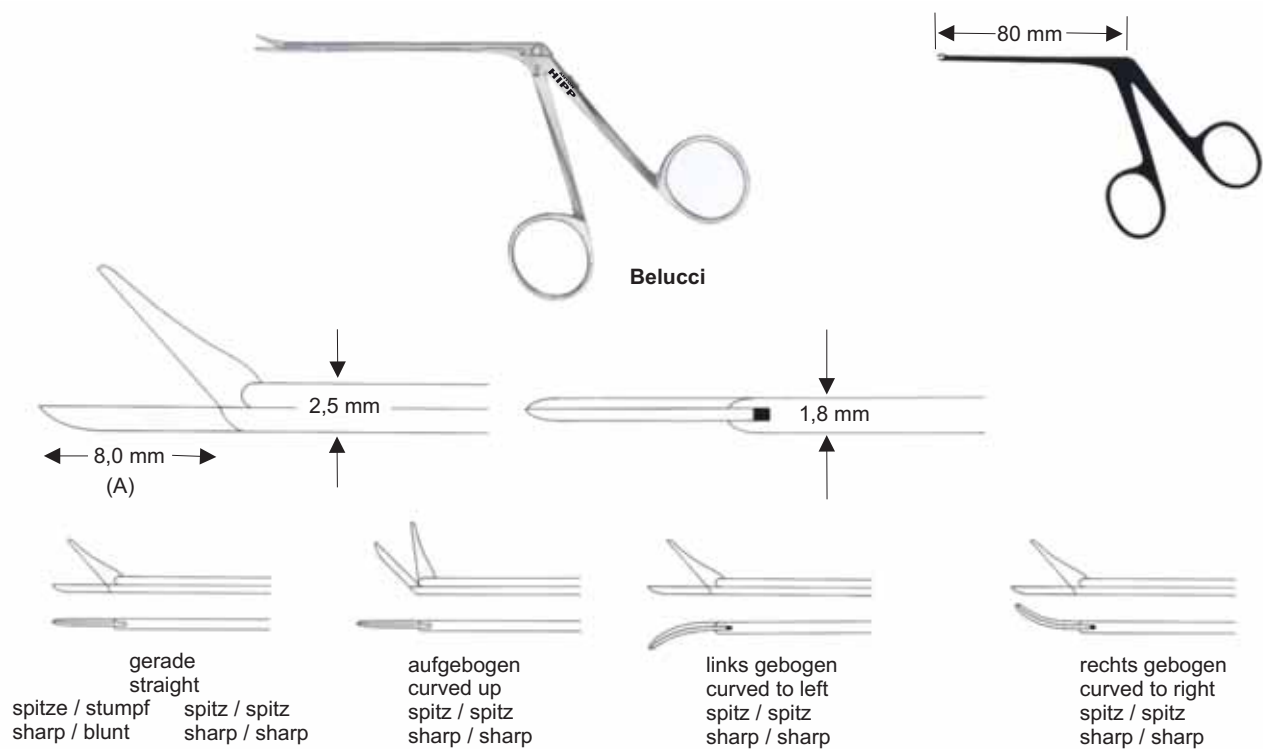

fein - delicate

27.410.00 27.410.01 27.410.02 (A = 6,0 mm) 27.410.03 27.410.04



sehr fein - very delicate

27.412.00 27.412.01 27.412.02 (A = 4,5 mm) 27.412.03 27.412.04



extra fein - extra delicate

27.414.00 27.414.01 27.414.02 27.414.03 27.414.04

Instrumente zum Halten und Einführen von Innenohrprothesen und Drainage Tuben

Forceps for holding and inserting Ear Prothesis and Drain Tubes

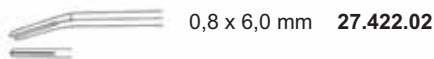
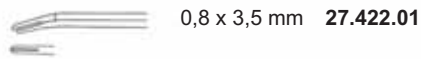
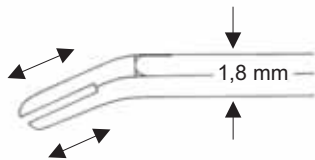

McGee

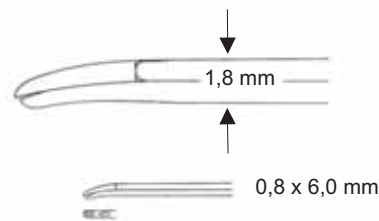
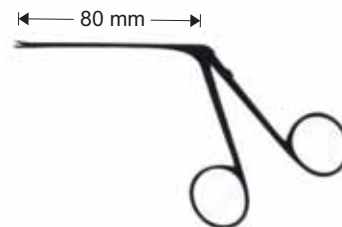

Schuknecht
27.420.02

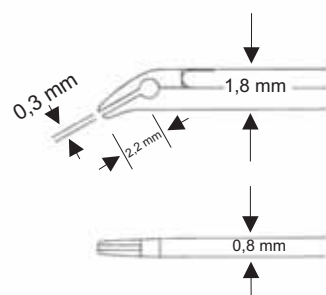

Fisch
27.423.01

Instrumente zum Halten und Einführen von Innenohrprothesen und Drainage Tuben

Forceps for holding and inserting Ear Prothesis and Drain Tubes

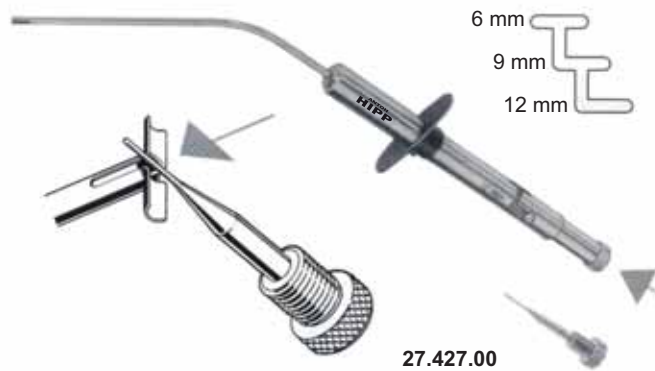

Zum Einsetzen von C-Flex T-Form Paukenröhrchen T-Tube Insert

Hub einstellbar auf 6,9 und 12 mm adjustable in 6, 9 and 12 mm

27.427.00

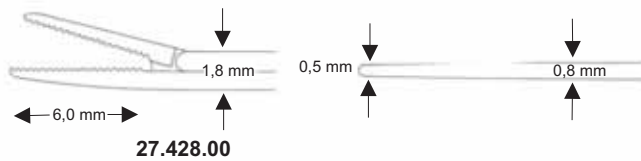

27.428.00

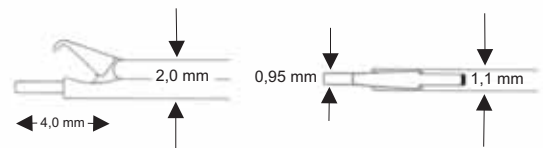
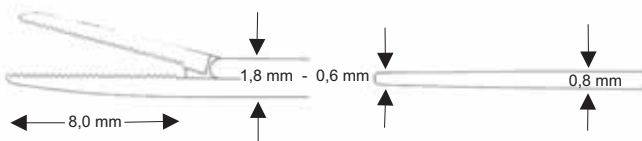
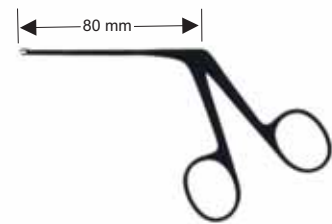

für Paukenröhrchen for Ventilation Tubes

27.428.04



Alligator
27.428.01
delicate

Hammerkopf- und Crurotomiezängchen
Malleus and Crura Nippers

Hammerkopfzängchen
Malleus Nippers

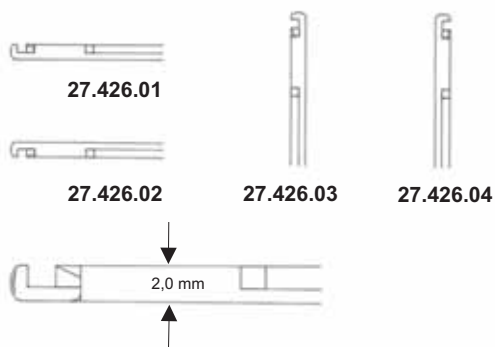

House-Dieter

Crurotomie-Zängchen
Crura Nippers

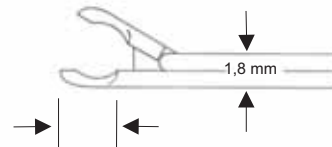
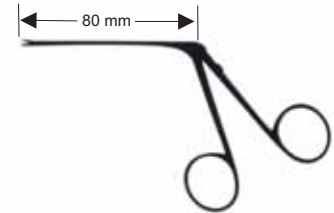

27.416.08

Crurotomie-Zängchen
Crura Nippers

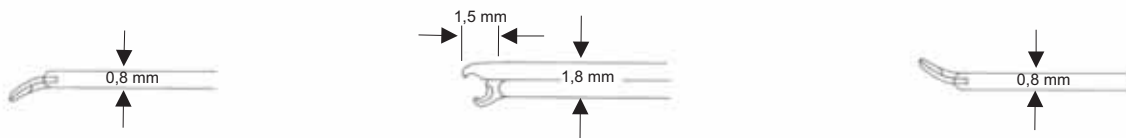

links schneidend
left cutting



Fisch
27.417.01

rechts schneidend
right cutting



Fisch
27.417.02

Mikro- Ohrzängchen mit Rohrschaft Micro Ear Forceps with tubular shafts



Ohrzängchen, fein
Delicate Ear Forceps

	gerieft grasping	Alligator	1 x 2 Zähne 1 x 2 teeth
gerade straight	 27.450.01	 27.450.02	 27.450.06
aufgebogen angled up	 27.450.41	 27.450.42	 27.450.46
links gebogen curved left	 27.450.61	 27.450.62	
rechts gebogen curved right	 27.450.71	 27.450.72	

Löffelzängchen, fein
Delicate Cup-shaped Forceps











gerade straight	 27.451.01	 27.451.02
aufgebogen angled up	 27.451.41	 27.451.42
links gebogen curved left	 27.451.61	 27.451.62
rechts gebogen curved right	 27.451.71	 27.451.72

Mikro-Ohr-Zängchen und -Scheren sind auch mit Bleistift-Griff oder Schienenschaft lieferbar





















Micro-Ear Forceps and Scissors are also available with Pencil Handle or Alligator type

Mikro- Ohrzängchen mit Rohrschaft Micro Ear Forceps with tubular shafts



	gerieft grasping	Alligator	1 x 2 Zähne 1 x 2 teeth
gerade straight	 27.452.01	 27.452.02	 27.452.06
aufgebogen angled up	 27.452.41	 27.452.42	 27.452.46
links gebogen curved left	 27.452.61	 27.452.62	
rechts gebogen curved right	 27.452.71	 27.452.72	

Löffelzängchen, fein Delicate Cup-shaped Forceps

	Ø 1 mm	Ø 1,5 mm	Ø 2 mm	Ø 2,5 mm	oval
gerade straight	 27.453.01	 27.453.03	 27.453.04	 27.453.05	 27.453.02
aufgebogen angled up	 27.453.41	 27.453.43	 27.453.44	 27.453.45	 27.453.42
links gebogen curved left	 27.453.61	 27.453.63	 27.453.64	 27.453.65	 27.453.62
rechts gebogen curved right	 27.453.71	 27.453.73	 27.453.74	 27.453.75	 27.453.72

Mikro- Ohrzängchen mit Rohrschaft Micro Ear Forceps with tubular shafts

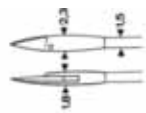

gerade straight		27.456.01
aufgebogen angled up		27.456.02
links gebogen curved left		27.456.03
rechts gebogen curved right		27.456.04
gerade straight	horizontal 	27.456.06
aufgebogen angled up		27.456.07



gerade straight		27.454.01
aufgebogen angled up		27.454.02
links gebogen curved left		27.454.03
rechts gebogen curved right		27.454.04
gerade straight	horizontal 	27.454.06
aufgebogen angled up		27.454.07



mini-micro

Mikro-Ohr-Zängchen und -Scheren sind auch mit Bleistift-Griff oder Schienenschaft lieferbar

Micro-Ear Forceps and Scissors are also available with Pencil Handle or Alligator type

Knochenstanzen Mastoid Punches



- 1 mm 40.000.10
- 2 mm 40.000.20
- 3 mm 40.000.30

Citelli



- 1 mm 40.002.10
 - 2 mm 40.002.20
- Atticusstanze
Atticus Punch

Fig. 0 3 x 3 mm 40.004.03

Fig. 1 4 x 4 mm 40.004.04

Fig. 2 5 x 5 mm 40.004.05

Fig. 3 6 x 6 mm 40.004.06



Kerrison

Messer für die Mikrochirurgie des Ohres Knives for Ear Microsurgery

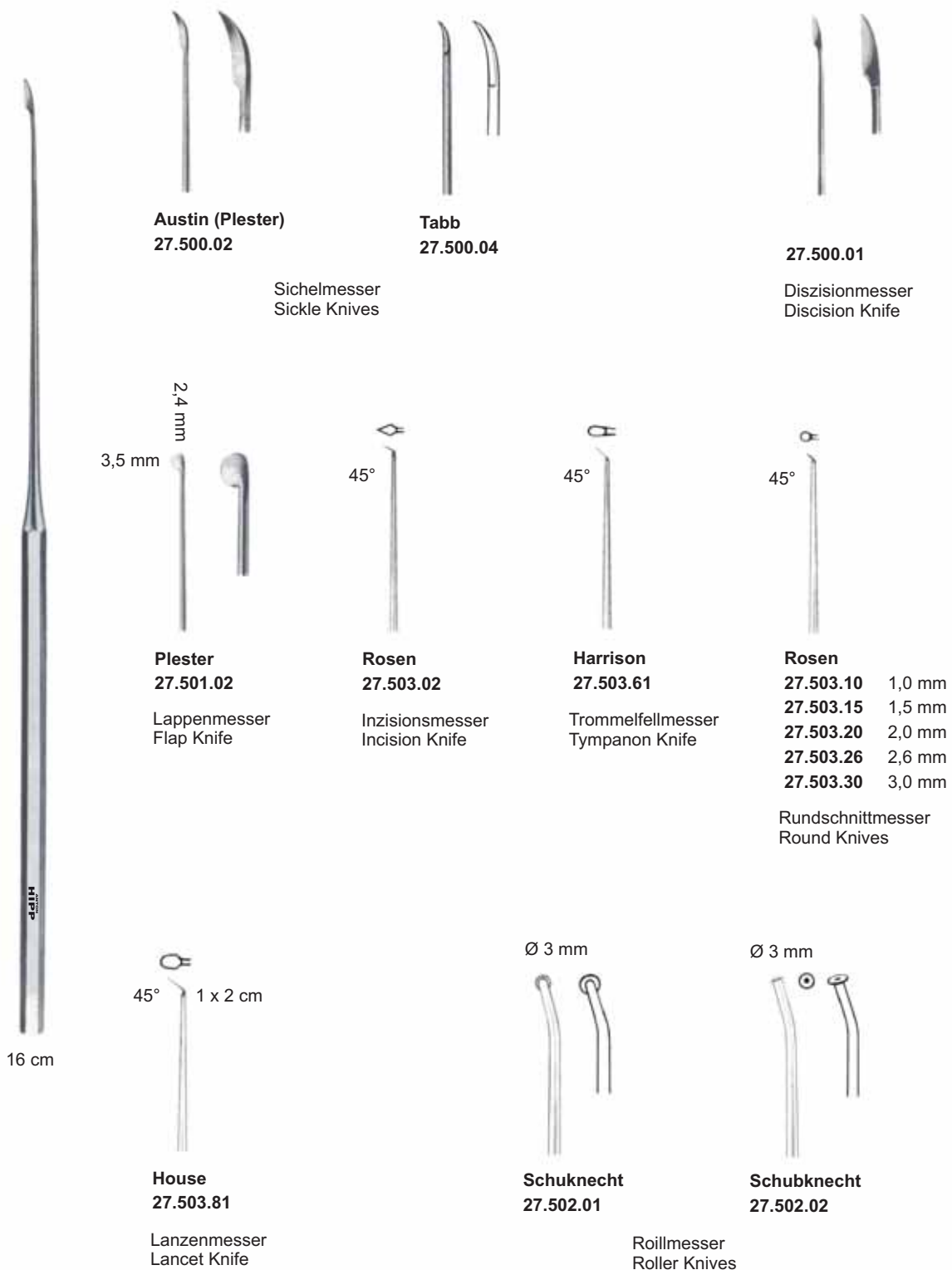

Raspatorien und Elevatorien für die Mikrochirurgie des Ohres Raspatories and Elevators for Ear Microsurgery



Instrumente für die Mikrochirurgie des Ohres Instruments for Ear Microsurgery

House

Meßsonde, Markierung bei
Measuring Rod, marker at

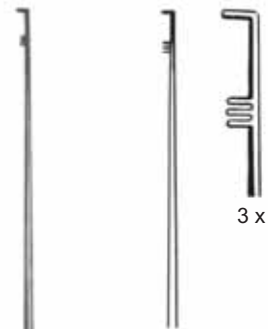
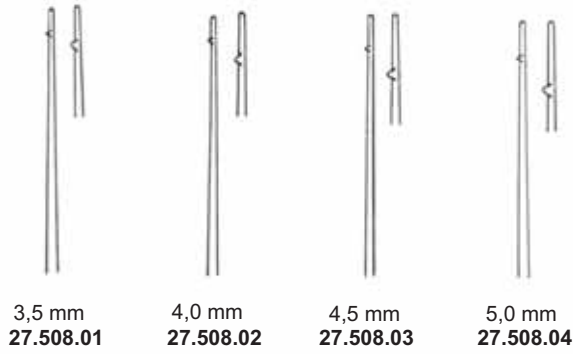

Tiefenmeßsonde mit Markierungen
bei 3,5 mm, 4,0 mm und 4,5 mm
Measuring Rod, markers
at 3.5 mm, 4.0 mm and 4.5 mm

Hough
27.508.00



Einführungsgabel für Stapes-Prothesen
Wire Guide and Applicator
for prosthesis, V-notch

Plester
27.504.05

16 cm

Kugelstopfer, doppelendig
Ivaginator, double-ended



Kistner
18 cm
27.505.18

Mikro-Nadeln und -häkchen Micro Needles and Hooks



Barbara
Nadel, gerade, spitz
Needle, straight, sharp point
27.510.01



Nadel, leicht gebogen, spitz
Needle, light curved, sharp point
27.510.02



Rosen
Nadel, stark gebogen, spitz
Needle, strong curved, sharp point
27.510.04



Shambaugh
Häkchen, abgewinkelt
Hook, angled
27.510.24 0,4 mm
27.510.26 0,6 mm
27.510.28 0,8 mm
27.510.30 1,0 mm



Shambaugh
Häkchen, abgewinkelt
Hook, angled
27.510.44 0,4 mm
27.510.46 0,6 mm
27.510.48 0,8 mm
27.510.50 1,0 mm
27.510.52 1,2 mm
27.510.55 1,5 mm
27.510.58 2,0 mm
27.510.59 2,5 mm



Shambaugh
Häkchen, abgewinkelt
Hook, angled
27.510.74 0,4 mm
27.510.76 0,6 mm
27.510.78 0,8 mm
27.510.80 1,0 mm
27.510.82 1,2 mm
27.510.85 1,5 mm
27.510.88 2,0 mm
27.510.89 2,5 mm



16 cm



Häkchen, retrograd
Hook, retrograde
27.510.90 0,6 mm



Häkchen, retrograd
Hook, retrograde
27.510.92 1,0 mm
27.510.93 2,5 mm



Plester
Antrum-Häkchen, stumpf
Antrum Hooklet, blunt
27.504.14

Mikro-Nadeln und -häkchen mit abgewinkeltem Schaft Micro Needles and Hooks with angled shafts



16 cm

	nach unten gebogen curved down	nach oben gebogen curved up	nach unten gebogen curved down
Barbara Nadel, gerade, spitz Needle, straight, sharp point 27.514.01	Rosen Nadel, stark gebogen, spitz Needle, strong curve, sharp point 27.515.01	McGee Fußplattenhäkchen Footplate hooks 27.513.02 0,5 mm 27.513.12 27.513.03 1,0 mm 27.513.13	
Mikro-Häkchen, nach oben gewinkelt Micro Hooks, angled up			
	25°	45°	90°
27.517.01 0,3 mm 27.517.02 0,6 mm 27.517.03 1,0 mm	27.517.21 0,3 mm 27.517.22 0,6 mm 27.517.23 1,0 mm	27.517.71 0,3 mm 27.517.72 0,6 mm 27.517.73 1,0 mm	
Mikro-Häkchen, nach unten gewinkelt Micro Hooks, angled down			
	25°	45°	90°
27.517.11 0,3 mm 27.517.12 0,6 mm 27.517.13 1,0 mm	27.517.31 0,3 mm 27.517.32 0,6 mm 27.517.33 1,0 mm	27.517.81 0,3 mm 27.517.82 0,6 mm 27.517.83 1,0 mm	

Mikro-Ohrküretten und -löffel
Mikro Ear Curettes and Spoons



leicht abgewinkelt
slightly angled
27.522.01
27.522.02

House
15 cm
1,0/1,2 mm
1,5/1,8 mm



stark abgewinkelt
strongly angled
27.522.03
27.522.04



leicht abgewinkelt
slightly angled
27.523.01

House
17 cm
1,5/1,8 mm

stark abgewinkelt
strongly angled
27.523.02

Instrumentarium zur Ausmeißelung der Stapesplatte
Instruments for the removal of the stapedial footplate



Heermann
Handgriff aus Aluminium, schwarz
Aluminium handle, black
27.530.00



Flachmeißel, 0,7 mm
Chipping chisel, 0.7 mm
27.530.01



Hohlmeißel, 0,7 mm
Gouge, 0.7 mm
27.530.02



Hohlmeißel, 1,0 mm
Gouge, 1.0 mm
27.530.03



Hohlmeißel, 1,5 mm
Gouge, 1.5 mm
27.530.04



Hohlmeißel, 3,0 mm
Gouge, 3.0 mm
27.530.05



Heermann
19,5 cm
Hammer, Metall
Mallet, metal
27.532.19



Schuhknecht modif.
Biegegerät zum Formen von Stapes-Drahtprothesen, 90°, mit Millimetereinteilung, aus rostfreiem Stahl.
Wire bending die, 90°, scale graduated in millimeters and mounted on center post, made of stainless steel.
27.534.00

Zöllner, Nadeln und Häkchen mit Daumengriffplatte
Zöllner, Needles and Hooks with thumb grip handel



Zöllner



Nadel, gerade, spitz
 Needle, straight, sharp point
27.540.00

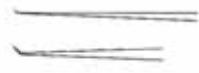

Häkchen, 0,5 mm, 45° nach oben abgewinkelt
 Hook, angled up 45°, 0.5 mm point
27.540.01



Häkchen, 0,5 mm, 45° nach unten abgewinkelt
 Hook, angled down 45°, 0.5 mm point
27.540.02



Häkchen, 0,5 mm, 90° nach oben abgewinkelt
 Hook, angled up 90°, 0.5 mm point
27.540.03



Häkchen, 0,5 mm, 90° nach unten abgewinkelt
 Hook, angled down 90°, 0.5 mm point
27.540.04



Häkchen, 1,0 mm, 45° nach oben abgewinkelt
 Hook, angled up 45°, 1.0 mm point
27.540.05

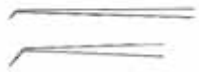

Häkchen, 1,0 mm, 45° nach unten abgewinkelt
 Hook, angled down 45°, 1.0 mm point
27.540.06

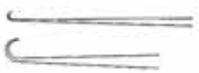

Fußplattenhäkchen, 1,0 mm, nach oben gebogen
 Footplate Hook, curved up, 1.0 mm point
27.540.07



Fußplattenhäkchen, 1,0 mm, nach unten gebogen
 Footplate Hook, curved down, 1.0 mm point
27.540.08

Zöllner, Instrumente mit Daumengriffplatte
Zöllner, Instruments with thumb grip handel

Zur Stapesmobilisation und zur Gehörgangplastik
For Stapes mobilization and plastic work in the curved external auditory meatus



Zöllner



Rundschnittmesser, 90° nach oben gewinkelt
Round knife, angled up 90°
27.550.01



Rundschnittmesser, 90° nach unten gewinkelt
Round knife, angled down 90°
27.550.02



Sichelmesser, 5 mm, oben schneidend
Sickle knife, 5 mm, upward cutting
27.550.03



Sichelmesser, 5 mm, unten schneidend
Sickle knife, 5 mm, downward cutting
27.550.04



Perforationsnadel, 5 mm, nach links gebogen
Spear-pointed Needle, 5 mm, curved to the left
27.550.05



Perforationsnadel, 5 mm, nach rechts gebogen
Spear-pointed Needle, 5 mm, curved to the right
27.550.06



Raspatorium, 2 mm breit, nach links gebogen
Raspatory, 2 mm wide, curved to the left
27.550.07



Raspatorium, 2 mm breit, nach rechts gebogen
Raspatory, 2 mm wide, curved to the right
27.550.08



Führungsgabel
Guiding Fork
27.550.09

Lagerungs- und Sterilisationssystem für Instrumente bis 17 cm

Storage and Sterilization System for Instruments up to 17 cm length

Container
Container



Mini-Container 200 x 100 x 40 mm
Mini container 200 x 100 x 40 mm
62.420.04

Mini-Container, 200 x 100 x 40 mm, mit Magnetplatte
im Boden zur Fixierung von Kleinteilen und Instrumenten
Mini container, 200 x 100 x 40 mm, with magnetic stripe
at the bottom to fix small parts and instruments
62.420.05



Mini-Container, 200 x 100 x 40 mm, mit Langzeit-Textilfilter
Mini container, 200 x 100 x 40 mm, with textile filter
62.421.04

Ersatz-Textilfilter (5 Stück) für Container 62.421.10
Spare textile filters (5 pieces) for container 62.421.10
62.803.10

Magnet-Rack
Magnetic racks



Magnet-Rack 196 x 96 x 35 mm,
aufstellbar
Magnetic rack 196 x 96 x 35 mm,
hinged
62.852.02



Rotations-Racks zur sicheren Lagerung
fein- und mikrochirurgischer Instrumente
Rotation racks for storage of finesurgical
and microsurgical instruments



Rotations-Rack 196 x 96 x 35 mm
zur Aufnahme von 6 Instrumenten
Rotation rack 196 x 96 x 35 mm
for 6 instruments
63.322.06



Rotations-Rack 196 x 96 x 35 mm
zur Aufnahme von 8 Instrumenten
Rotation rack 196 x 96 x 35 mm
for 8 instruments
63.322.08

Rotations-Rack 196 x 96 x 35 mm
zur Aufnahme von 5 HNO-Instrumenten und Ohrtrichtern
Rotation rack 196 x 96 x 35 mm
for 5 ENT-instruments and ear specula
63.323.07

Sterilisation und Aufbewahrung Sterilization and Conservation

Sterilisier- und Bereitschaftskästen
Sterilizing and storing Cases

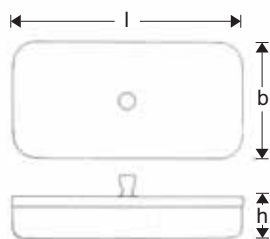

Maße in mm sizes in mm	Behälter Container	Satz Spezialfilter (5 Stück) Set of special filters (5 pieces)
l b h		
230 x 130 x 50	63.300.01	63.304.01
260 x 150 x 50	63.300.02	63.304.02
260 x 150 x 75	63.300.03	63.304.03
300 x 200 x 50	63.300.04	63.304.04
325 x 275 x 50	63.300.05	63.304.05



Gestell, leer, zum Sterilisieren und Aufbewahren
von 6 Ohrzängchen mit Ringgriffen
Rack, empty, for sterilizing and storing
6 Alligator-type ear forceps with ring handles
62.854.06

Rhinologie, Rhinoplastik

Rhinology, Rhinoplastic

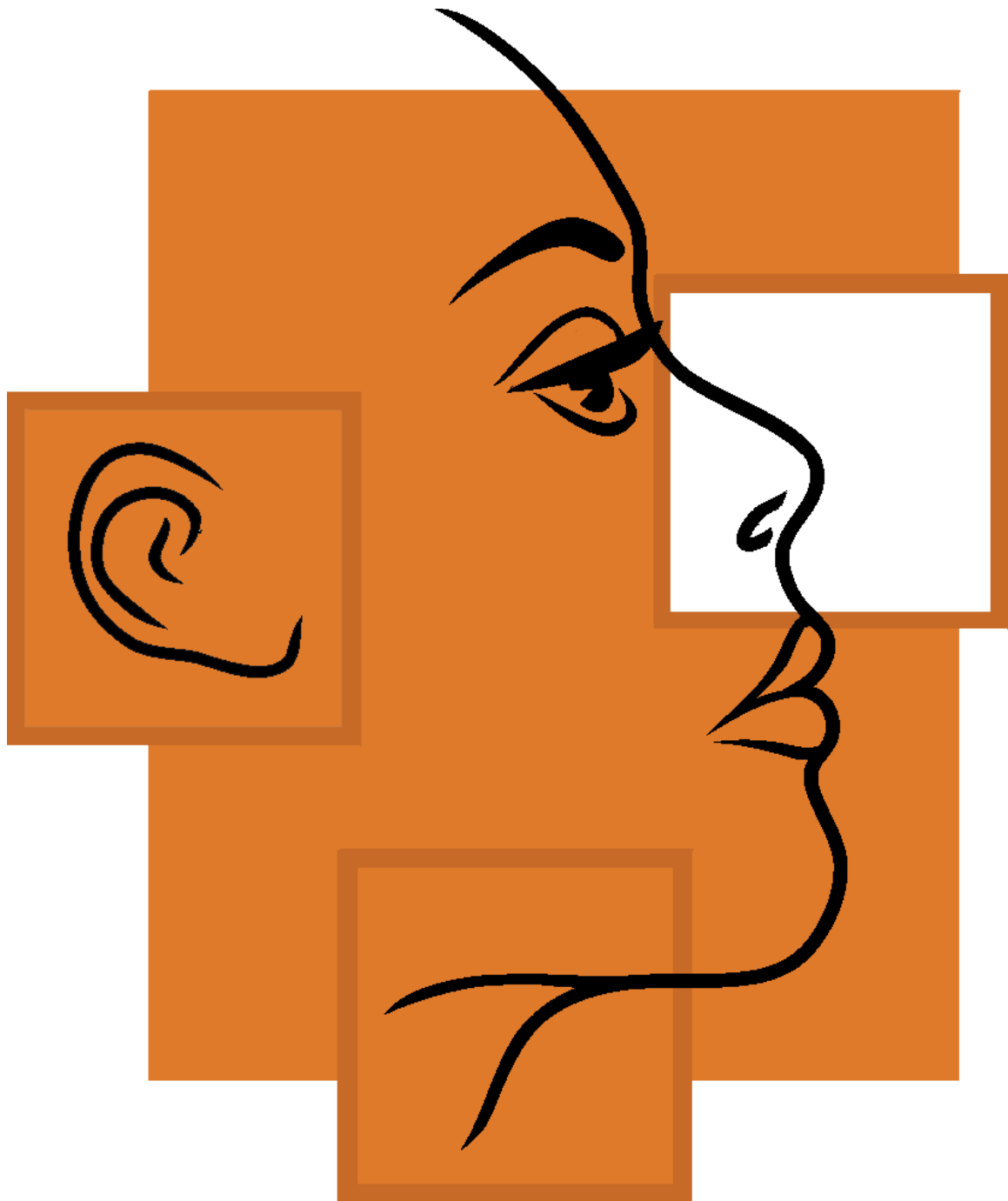

Nasenspekula
Nasal Specula



Palmer
26.502.07



Thudichum (Goldsmith)



26.500.12



26.500.16



26.500.19



Voltolini



26.504.01



26.504.02



26.504.03



Modell Wien (Vienna pattern)
14 cm



Fig. 1
26.515.01



Fig. 2
26.515.02



Fig. 3
26.515.03



Hartmann/Wiener
15 cm
26.521.14

Nasenspekula
Nasal Specula



Tieck-Halle
13,5 cm



Fig. 1
26.507.01

Fig. 2
26.507.02



35 mm
Fig. 1



50 mm
Fig. 2

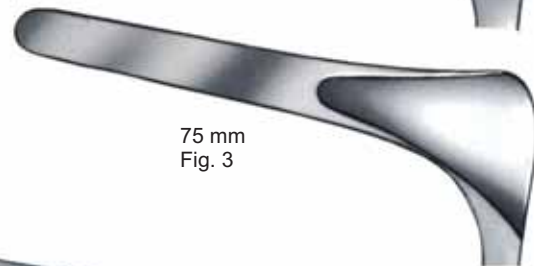

75 mm
Fig. 3



90 mm
Fig. 4



Klillian
13 cm

- Fig. 1 **26.525.01**
- Fig. 2 **26.525.02**
- Fig. 3 **26.525.03**
- Fig. 4 **26.525.04**



Klillian
13 cm

- Fig. 1 **26.525.51**
- Fig. 2 **26.525.52**
- Fig. 3 **26.525.53**
- Fig. 4 **26.525.54**

Nasenspekula
Nasal Specula



Beckmann
15 cm

Fig. 1
26.519.01

Fig. 2
26.519.02

Fig. 3
26.519.03



Hartmann
16 cm

für Kinder
for children

Fig. 0
26.513.00

Fig. 1
26.513.01

Fig. 2
26.513.02

Fig. 3
26.513.03



Hartmann-Halle
15 cm

Fig. 1
26.508.01

Fig. 2
26.508.02

Fig. 3
26.508.03



Hartmann-Halle
15 cm

Fig. 1
26.509.01

Fig. 2
26.509.02

Fig. 3
26.509.03



Nasenspekula Nasal Specula



Cottle
15 cm

Fig. 1 24.533.01
Fig. 2 24.533.02
Fig. 3 24.533.03
Fig. 4 24.533.04



35 mm
Fig. 1



50 mm
Fig. 2



75 mm
Fig. 3



90 mm
Fig. 4



Cottle
15 cm

Fig. 1 24.534.01
Fig. 2 24.534.02
Fig. 3 24.534.03
Fig. 4 24.534.04



Cottle
15 cm

Fig. 1 24.528.01
Fig. 2 24.528.02
Fig. 3 24.528.03
Fig. 4 24.528.04

Nasenseptumspekulum
sehr schlankes Modell
aseptischer Verschluss
(auseinandernehmbar)

Nasal Septum Speculum
very slender pattern
aseptic joint
(dismantable)

Polypen-, Tampon- und Septumzangen
Polypus, Tampon and Septum Compression Forceps



Hartmann
16 cm
26.607.16



Hartmann
20 cm
26.607.20



Standardmodell
standard pattern
26.608.01

Westmacott
20 cm

feines Modell
delicate pattern
26.608.02



Tilley
17 cm
26.601.17



Killian
17 cm
26.608.17

Septumzange
Septum compression Forceps

Scharfe Nasenzangen, Sptum- und Siebbeinzangen
Nasal Cutting, Septum Compression and Ethmoid Forceps

Septumzange
 Septum compression forceps



26.813.01 26.813.02

26.813.03 26.813.04

Brünings
 19 cm



26.807.01 26.807.02

Luc
 20 cm

Vomer-Zangen
 Vomer forceps



Craig
 18 cm
 26.801.01



Craig-Domnick
 18 cm

26.803.01 26.803.02

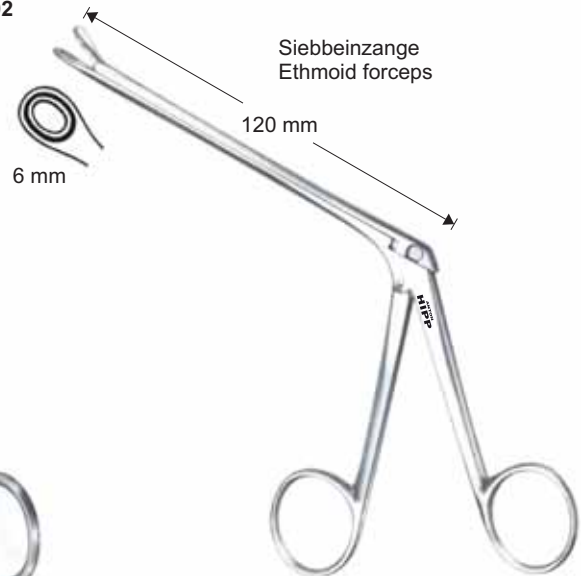

Siebbeinzange
 Ethmoid forceps

120 mm

6 mm

Watson-Williams
 19 cm
 40.042.02

Knochensplitterzangen, Septumrichtzangen Bone Cutting Forceps, Septum Straightening Forceps



gerade
straight

Cottle-Kazanjan
19 cm
40.704.19

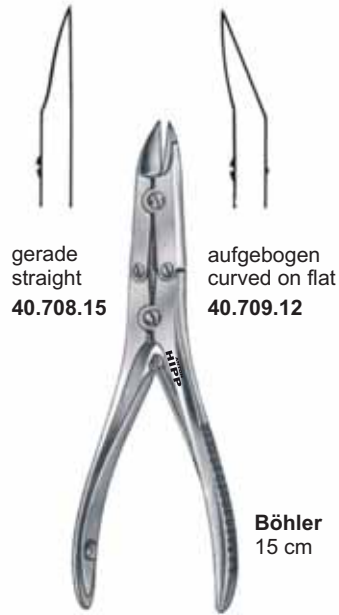

gerade
straight
40.708.15

aufgebogen
curved on flat
40.709.12

Böhler
15 cm



aufgebogen
curved on flat

McIndoe
18 cm
40.711.18



23 cm

Cottle-Walsham
universal
universal
26.826.01



Walsham
links
left
26.826.02



Walsham
rechts
right
26.826.03



Asch
23 cm
26.825.22

Scharfe Nasenzangen Nasal Cutting Forceps

12,5 mm



Weil-Blakesly

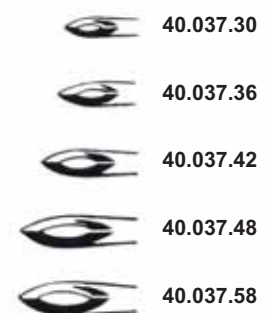

Weil-Blakesly



2,5 x 10 mm 40.044.03

4,0 x 10 mm 40.044.04

Takahashi



2,5 x 10 mm 40.045.03

4,0 x 10 mm 40.045.04

Takahashi



40.078.10

40.078.15
Struycken



5 mm 40.040.05

7 mm 40.040.07

9 mm 40.040.09

11 mm 40.040.11

Hartmann



5 mm 40.041.01

7 mm 40.041.02

9 mm 40.041.03

Schmeden

Scharfe Nasenzangen
Nasal Cutting Forceps

Antrumstanze, rückwärts schneidend
Antrum Punch, retrograde cutting

10 cm

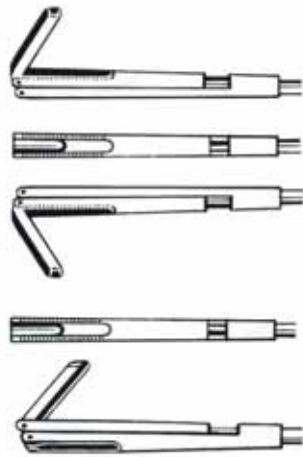

Schnitt oben
up cutting
40.080.01

Schnitt links
cutting left
40.080.02

Schnitt rechts
cutting right
40.080.03



Stammberger
drehbar 360°
360° turnable
40.082.01

Septumzangen
Septum cutting forceps



durchschneidend
through cutting

Jansen-Middleton
19 cm
26.830.03



löffelförmiges Maulteil
spoon-shaped jaws

Jansen-Middleton
19 cm
20.830.01

Scharfe Nasenzangen Nasal Cutting Forceps

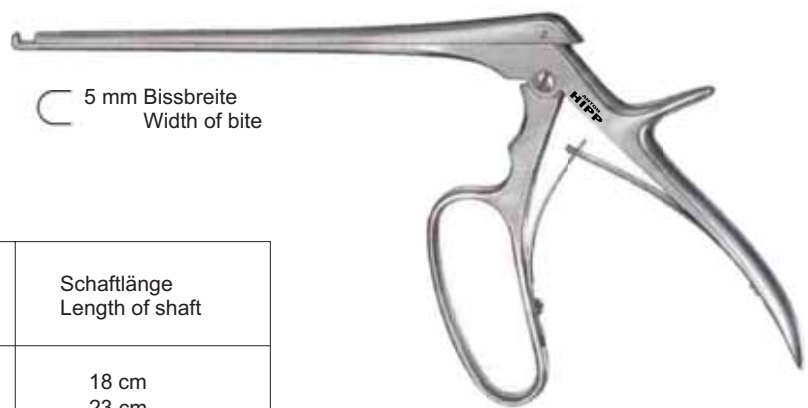





5 mm Bissbreite
Width of bite

Ferris-Smith-Kerrison

		Schaftlänge Length of shaft
aufwärts upbite	40.027.05 40.027.55	18 cm 23 cm
abwärts downbite	40.027.15 40.027.65	18 cm 23 cm
vorwärts 40° forward 40°	40.027.25 40.027.75	18 cm 23 cm



Kerrison

- 
3 x 3 mm
Fig. 0
40.004.03
- 
4 x 4 mm
Fig. 1
40.004.04
- 
5 x 5 mm
Fig. 2
40.004.05
- 
6 x 6 mm
Fig. 3
40.004.06

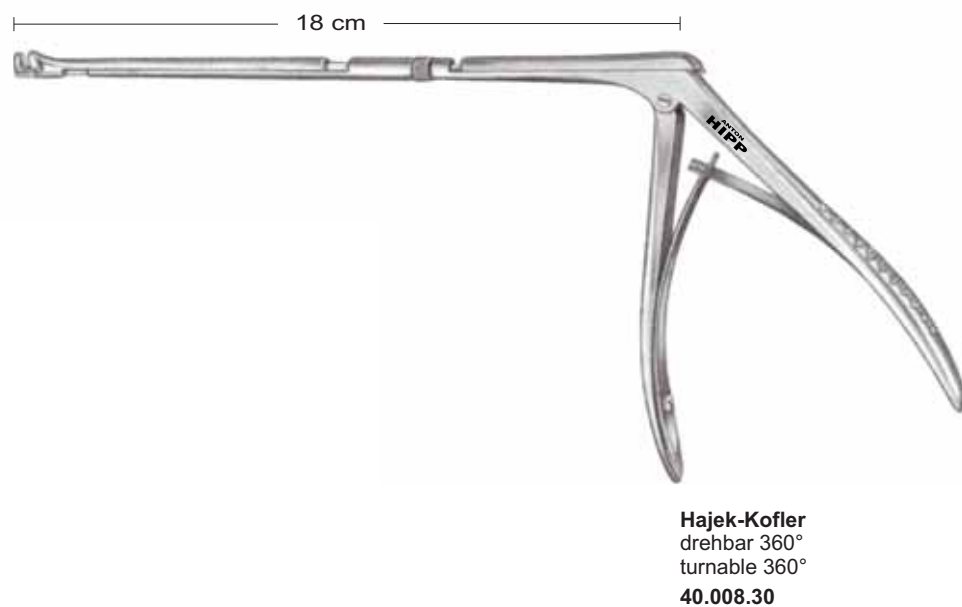
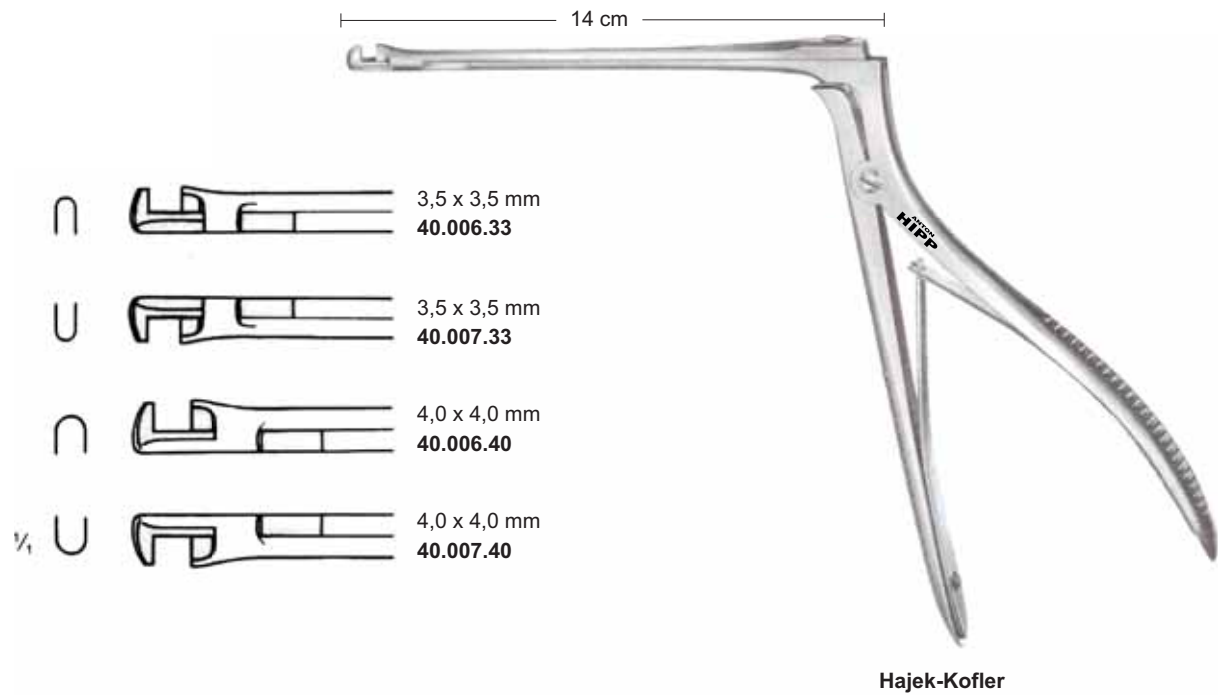
Scharfe Nasenzangen
Nasal Cutting Forceps

Scharfe Nasenzangen Nasal Cutting Forceps



aufwärts - upbite

fest fixed	Schaftlänge Length of shaft	Bissbreite Width of bite
40.010.01	15 cm	1 mm
40.016.01	18 cm	1 mm
40.018.01	20 cm	1 mm



Ferris-Smith-Kerrison/Micro-Kerrison

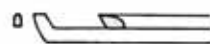

vorwärts schneidend 45° - angled forward 45°

fest fixed	Schaftlänge Length of shaft	Bissbreite Width of bite	zerlegbar dismantable
40.012.01	15 cm	1 mm	
40.014.01	18 cm	1 mm	40.014.01Z
40.019.01	20 cm	1 mm	40.019.01Z



aufwärts - upbite

fest fixed	Schaftlänge Length of shaft	Bissbreite Width of bite	zerlegbar dismantable
40.010.02	15 cm	2 mm	
40.010.03	15 cm	3 mm	
40.010.05	15 cm	5 mm	
40.016.02	18 cm	2 mm	40.016.02 Z
40.016.03	18 cm	3 mm	40.016.03 Z
40.016.05	18 cm	5 mm	40.016.05 Z
40.018.02	20 cm	2 mm	40.018.02 Z
40.018.03	20 cm	3 mm	40.018.03 Z
40.018.05	20 cm	5 mm	40.018.05 Z

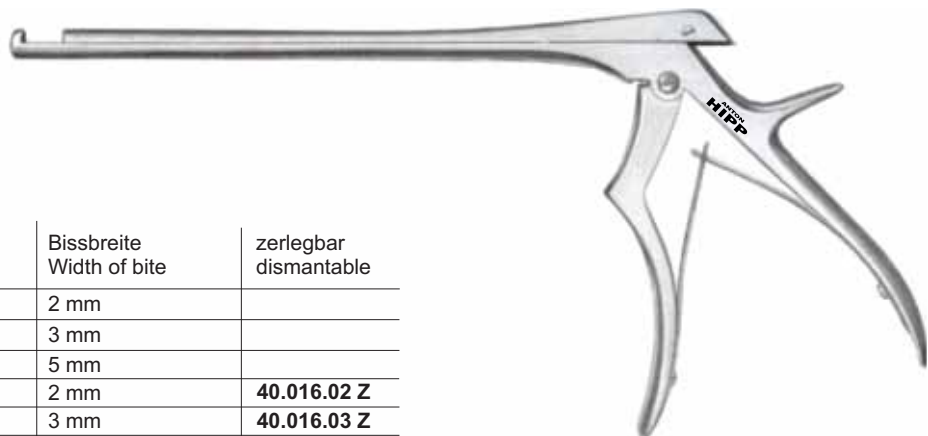

Ferris-Smith-Kerrison/Micro-Kerrison

Scharfe Nasenzangen Nasal Cutting Forceps

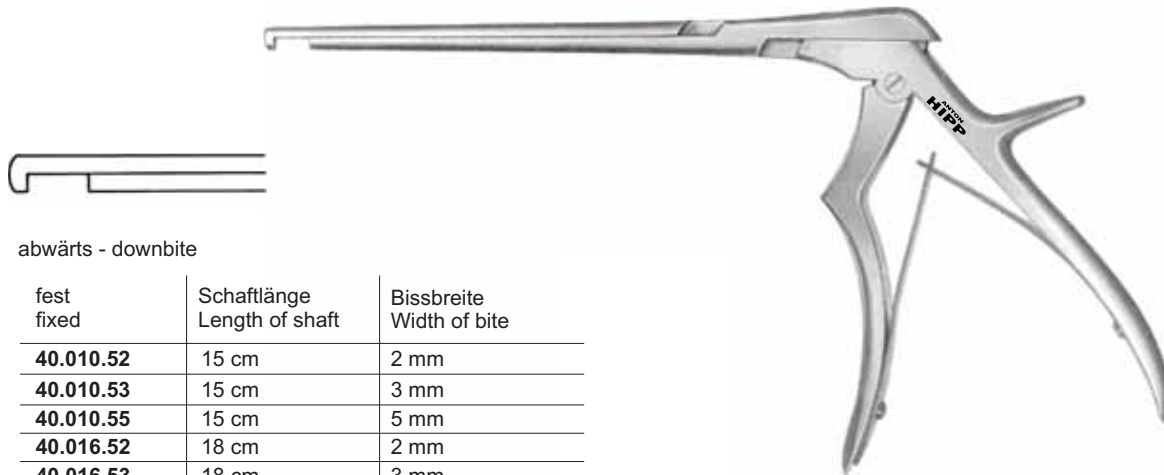

abwärts - downbite

fest fixed	Schaftlänge Length of shaft	Bissbreite Width of bite
40.010.52	15 cm	2 mm
40.010.53	15 cm	3 mm
40.010.55	15 cm	5 mm
40.016.52	18 cm	2 mm
40.016.53	18 cm	3 mm
40.016.55	18 cm	5 mm
40.018.52	20 cm	2 mm
40.018.53	20 cm	3 mm
40.018.55	20 cm	5 mm

Ferris-Smith-Kerrison/Micro-Kerrison



vorwärts schneidend 40° - angled forward 40°

fest fixed	Schaftlänge Length of shaft	Bissbreite Width of bite	zerlegbar dismantable
40.012.02	15 cm	2 mm	
40.012.03	15 cm	3 mm	
40.012.05	15 cm	5 mm	
40.014.02	18 cm	2 mm	40.014.02 Z
40.014.03	18 cm	3 mm	40.014.03 Z
40.014.05	18 cm	5 mm	40.014.05 Z
40.019.02	20 cm	2 mm	40.019.02 Z
40.019.03	20 cm	3 mm	40.019.03 Z
40.019.05	20 cm	5 mm	40.019.05 Z

Ferris-Smith-Kerrison/Micro-Kerrison

Scharfe Nasenzangen
Nasal Cutting Forceps

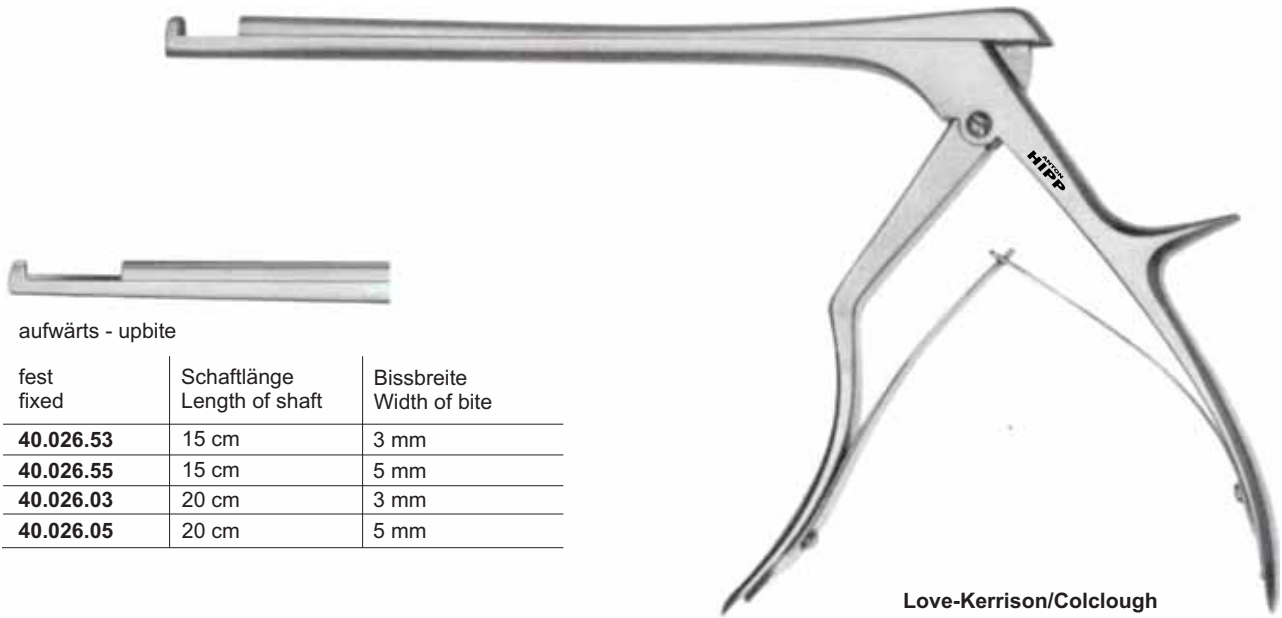

Love-Kerrison/Colclough

aufwärts - upbite

fest fixed	Schaftlänge Length of shaft	Bissbreite Width of bite
40.026.53	15 cm	3 mm
40.026.55	15 cm	5 mm
40.026.03	20 cm	3 mm
40.026.05	20 cm	5 mm



abwärts - downbite

fest fixed	Schaftlänge Length of shaft	Bissbreite Width of bite
40.027.53	15 cm	3 mm
40.027.55	15 cm	5 mm
40.027.03	20 cm	3 mm
40.027.05	20 cm	5 mm



vorwärts schneidend 45° - angled forward 45°

fest fixed	Schaftlänge Length of shaft	Bissbreite Width of bite
40.024.53	15 cm	3 mm
40.024.55	15 cm	5 mm
40.024.03	20 cm	3 mm
40.024.05	20 cm	5 mm

Scharfe Nasenzangen Nasal Cutting Forceps

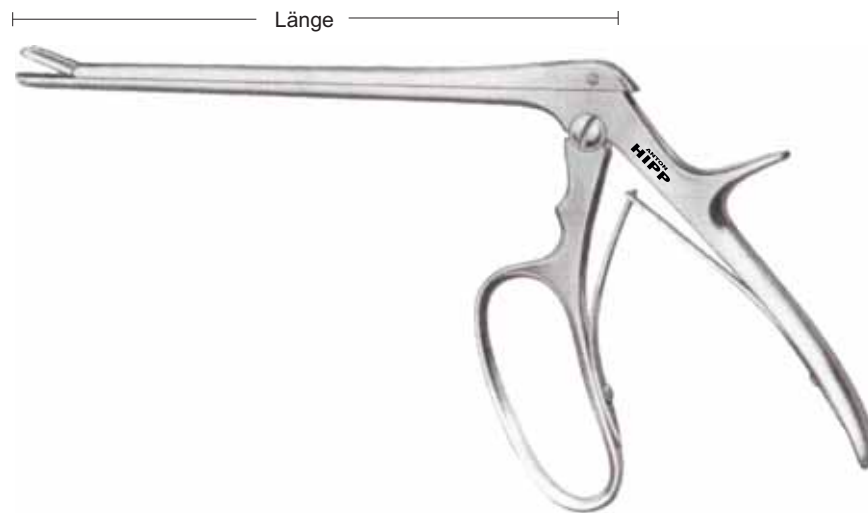

Ferris-Smith



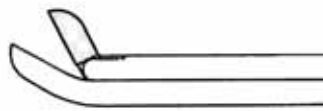
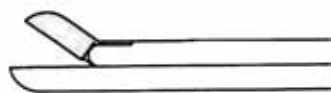

gerade
straight

aufwärts
upward





abwärts
downward



Länge 18 cm

	2,0 x 10 mm	40.028.02	40.028.12	40.028.22
	3,0 x 10 mm	40.028.03	40.028.13	40.028.23
	4,0 x 10 mm	40.028.04	40.028.14	40.028.24
	5,0 x 10 mm	40.028.05	40.028.15	40.028.25
	6,0 x 10 mm	40.028.06	40.028.16	40.028.26

Länge 20 cm

	2,0 x 10 mm	40.028.52	40.028.62	40.028.72
	3,0 x 10 mm	40.028.53	40.028.63	40.028.73
	4,0 x 10 mm	40.028.54	40.028.64	40.028.74
	5,0 x 10 mm	40.028.55	40.028.65	40.028.75
	6,0 x 10 mm	40.028.56	40.028.66	40.028.76

Scharfe Nasenzangen Nasal Cutting Forceps



gerade
straight



aufwärts
upward



abwärts
downward



Cushing
2,0 x 10 mm



	gerade straight	aufwärts upward	abwärts downward
13 cm	40.046.02	40.047.02	40.049.02
15 cm	40.046.12	40.047.12	40.049.12
18 cm	40.046.22	40.047.22	40.049.22

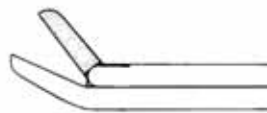

Love-Gruenwald
3,0 x 10 mm



	gerade straight	aufwärts upward	abwärts downward
13 cm	40.046.03	40.047.03	40.049.03
15 cm	40.046.13	40.047.13	40.049.13
18 cm	40.046.23	40.047.23	40.049.23

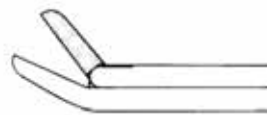

Spurling
4,0 x 10 mm



	gerade straight	aufwärts upward	abwärts downward
13 cm	40.046.04	40.047.04	40.049.04
15 cm	40.046.14	40.047.14	40.049.14
18 cm	40.046.24	40.047.24	40.049.24

Nasenoperationsmesser Rhinoplastic Knives



Fig.1
gerade
straight
26.640.01

Fig.2
gerade
straight
26.640.02

Fig.1
gebogen
curved
26.641.01

Fig.2
gebogen
curved
26.641.02

Fig.1
gerade
straight
26.640.10

Fig.2
gerade
straight
26.640.11

Fig.1
gebogen
curved
26.641.10

Fig.2
gebogen
curved
26.641.11

spitz
pointed

stumpf
blunt

Joseph



Fomon
16 cm
26.645.16

Joseph
16 cm
26.647.16

Converse
16 cm
26.649.16

Joseph
15 cm
26.650.15

Cottle
15 cm
26.652.15

**Nasenoperationsmesser
Rhinoplastic Knives**



Masing
14 cm
26.644.13



Masing
14 cm
26.644.14



Cottle
15 cm
26.654.15



Maltz
16 cm
26.651.16

**Knorpelmesser
Cartilage Knife**



Ballenger
14 cm
26.646.14

**Mukosamesser
Mucous Knives**



Freer
15 cm
26.646.16



Freer
15 cm
26.646.15



Freer
15 cm
26.647.15

**Septummesser
Septum Knives**



Ersatzklinge
Spare blade
26.642.01

Bruenings
16,5 cm
26.642.16



Freer
19 cm
26.669.01



Freer
19 cm
26.669.02



Freer
19 cm
26.669.03



Freer
19 cm
26.668.19

Septumschwingmesser
Septum swivel knives



Ballenger
21,5 cm



3mm
26.710.03
26.711.03



4 mm
26.710.04
26.711.04



5 mm
26.710.05
26.711.05



Ballenger
22 cm

**Nasenscheren
Nasal Scissors**

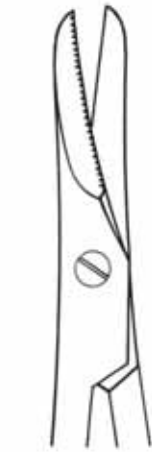

1 Schneide gezahnt
1 blade serrated



Caplan
20 cm
26.841.20

gezahnt
toothed

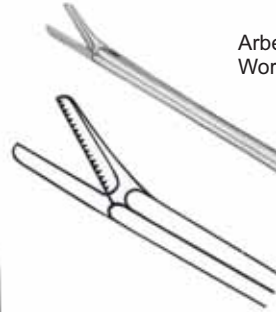

Arbeitslänge: 13 cm
Working length: 13 cm



Olivecrona
21,5 cm
26.838.21

gezahnt
toothed

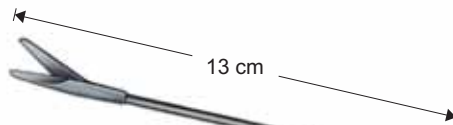

13 cm

1 Schneide gezahnt
1 blade serrated



rechts gebogen
curved to the right
26.839.01



links gebogen
curved to the left
26.839.02



Rohrschaft
Tubular shaft

gerade
straight
26.839.00



Killian
21 cm
26.843.21

**Nasenscheren
Nasal Scissors**

CAPLAN TC
abgewinkelt/angled 19,5 cm 26.841.20TC



GORNEY TURBINATE
abgewinkelt/angled 20,5 cm 26.842.20TC

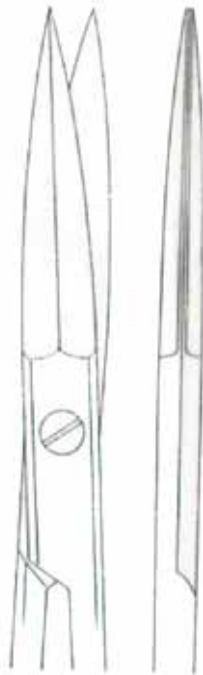

SEILER TURBINATE
seitw. gewinkelt/angled 20,5 cm 1.137.17

Tonsillen- und Nasenscheren
Tonsil Scissors and Nasal Scissors**McIndoe**Länge/length
19,0 cm**1.094.19****Prince**Länge/length
17,0 cm**1.105.17****Böttcher**Länge/length
18,0 cm**1.115.18**

Tonsillen- und Nasenscheren
Tonsil Scissors and Nasal Scissors



Potts Smith
Länge/length
19,0 cm **1.115.19**



Good
Länge/length
19,0 cm **1.120.19**



Dean
Länge/length
17,0 cm **1.124.17**

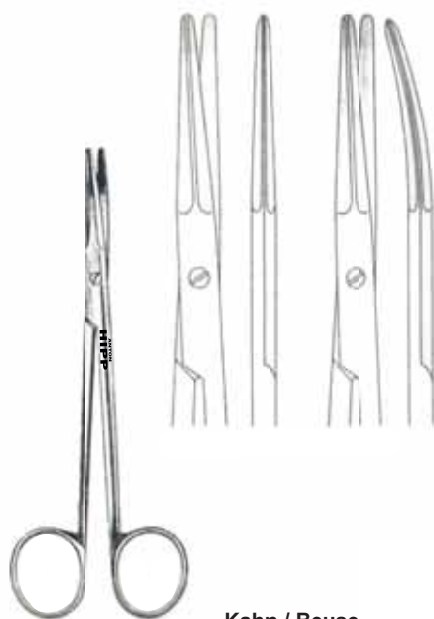

Kahn / Beuse		
gerade/straight	Länge/length	gebogen/curved
1.116.14	14,5 cm	1.117.14
1.116.18	18,0 cm	1.117.18

Tonsillen- und Nasenscheren
Tonsil Scissors and Nasal Scissors

Fomon
Doppelblatt/double blade
Länge/length
13,5 cm **1.129.13**



Fomon
stark gebogen/strongly curved
Länge/length
13,5 cm **1.131.13**



Fomon
abgewinkelt mit Blatt
angled with blade
Länge/length
13,5 cm **1.135.13**



Fomon
abgewinkelt/angled
Länge/length
13,5 cm **1.137.13**

Tonsillen- und Nasenscheren
Tonsil Scissors and Nasal Scissors

Cottle
Länge/length
16,0 cm **1.139.16**



Heymann
Länge/length
18,0 cm **1.147.18**



Heymann
Länge/length
20,0 cm **1.147.20**



Knight
Länge/length
18,0 cm **1.149.18**



Jackson
Länge/length
20,0 cm **1.149.20**

Präparierscheren Dissecting Scissors



Joseph

gerade/straight	Länge/length	gebogen/curved
1.314.14	14,0 cm	1.315.14
1.314.17	17,0 cm	1.315.17



Sanvenero

gerade/straight	Länge/length	gebogen/curved
1.316.14	14,0 cm	1.317.14



Reynolds

gerade/straight	Länge/length	gebogen/curved
1.324.13	13,0 cm	1.325.13
1.324.15	15,0 cm	1.325.15
1.324.18	18,0 cm	1.325.18
1.324.20	20,5 cm	1.325.20
1.324.23	23,5 cm	1.325.23



Kelly

gerade/straight	Standard	gebogen/curved
1.344.16	16 cm	1.355.16
1.344.18	18 cm	1.355.18

S1.334.16	Supercut	S1.355.16
S1.334.18	16 cm	S1.355.18
	18 cm	

TC1.964.16	TC	TC1.965.16
	16 cm	

S1.964.16	Supercut TC	S1.965.16
	16 cm	

**Präparierscheren
Dissecting Scissors****Strabismus**gerade/straight
1.250.09
1.250.11Länge/length
9,0 cm
11,0 cmgebogen/curved
1.251.09
1.251.11**Baby Lexer**gerade/straight
1.260.10Länge/length
10,5 cmgebogen/curved
1.261.10

**Präparierscheren
Dissecting Scissors**

PECK JOSEPH	
gerade/straight	14,5 cm gebogen/curved
1.318.14	Standard 1.319.14
S1.318.14	Supercut S1.319.14
TC1.948.14	TC TC1.949.14
S1.948.14	Supercut TC S1.949.14



LOCKLIN	
16 cm	abgewinkelt/angled
Standard	1.445.16
Supercut	S1.445.16
TC	TC1.881.16
Supercut TC	S1.881.16

Gefäßscheren
Vascular Scissors



CHURCH

gerade/straight
1.440.17

Länge/length
17,0 cm



gebogen/curved
1.441.17



LINCOLN

gerade/straight
1.442.17

Länge/length
17,0 cm



gebogen/curved
1.443.17



LOCKLIN

S-förmig gebogen/S-curved

Länge/length
16,0 cm

1.447.16

Feine Scheren
Fine Scissors

Aebli gerade/straight
Länge/length
10,5 cm **1.264.10**



Aebli aufgewinkelt/angled
Länge/length
10,5 cm **1.265.10**



Mc Guire aufgebogen
angled up
Länge/length
10,5 cm **1.267.10**



La Grange S-förmig/S-form
Länge/length
11,5 cm **1.269.11**

Feine Scheren Fine Scissors



Stevens stumpf/blunt

gerade/straight	Länge/length	gebogen/curved
1.270.10	9,0 cm	1.271.09
1.270.11	10,5 cm	1.271.10
	11,5 cm	1.271.11



Stevens spitz/sharp

gerade/straight	Länge/length	gebogen/curved
1.274.10	9,0 cm	1.275.09
1.274.11	10,5 cm	1.275.10
	11,5 cm	1.275.11

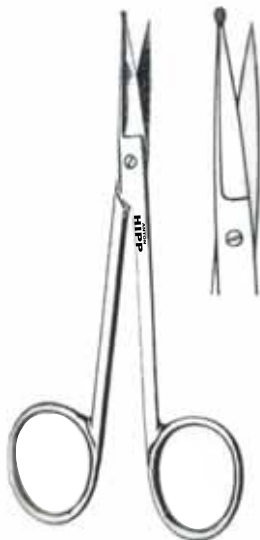

Gefäßschere / Vessel scissor
mit Knopf/with button
Länge/length
11,0 cm **1.276.11**



Gefäßschere / Vessel - Scissor
seitwärts gewinkelt mit Knopf
angled to the side with button
Länge/length
11,0 cm **1.277.11**

Feine Scheren
Fine Scissors



SEALY
gerade/straight 11,5 cm gebogen/curved
1.284.11 Standard 1.285.11
S1.284.11 Supercut S1.285.11
TC1.876.11 TC TC1.877.11
S1.876.11 Supercut TC S1.877.11



Graefe
abgewinkelt/angled
Länge/length 9,5 cm 1.306.09



CONVERSE / WILMER
aufgewinkelt/angled 10,0 cm 1.306.10



CONVERSE Doppelblatt
Double-Beveled-Blades
aufgewinkelt/angled 10,0 cm 1.306.11

Feine Scheren
Fine Scissors



gerade/straight
1.284.09
1.284.10

IRIS

Länge/length
9,cm
10,5 cm



gebogen/curved
1.285.09
1.285.10



IRIS
mit großen Ringen/with big rings
gerade/straight Länge/length gebogen/curved
1.286.10 10,0 cm **1.287.10**

Feine Scheren
Fine Scissors



IRIS fino

gerade/straight	Länge/length	gebogen/curved
1.288.10	10,5 cm	1.289.10
1.288.11	11,5 cm	1.289.11

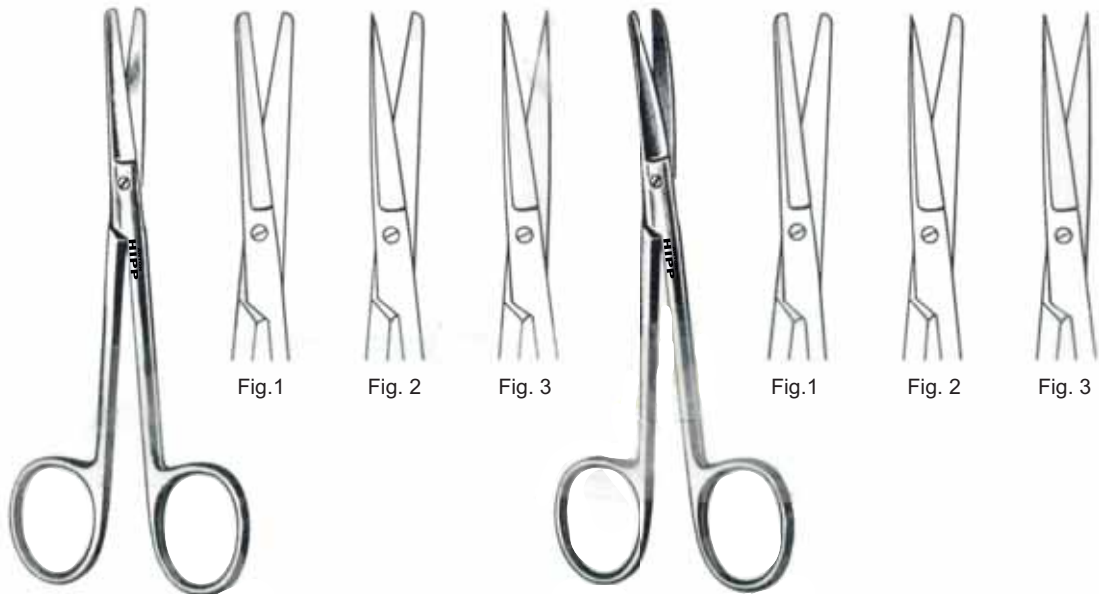

Wagner

gerade/straight	12,0 cm
Fig. 1	Fig. 2
1.290.12	1.292.12
	Fig. 3
	1.294.12

Wagner

gebogen/curved	12,0 cm
Fig. 1	Fig. 2
1.291.12	1.293.12
	Fig. 3
	1.295.12

Feine Scheren
Fine Scissors



IRIS

gerade/straight Länge/length
1.304.09 9,0 cm
1.304.10 10,5 cm
1.304.11 11,5 cm

gebogen/curved
1.305.09
1.305.10
1.305.11



IRIS

seitwärts abgewinkelt/angled
 Länge/length
 11,0 cm **1.297.11**



Bonn

gerade/straight Länge/length
1.304.08 8,0 cm

gebogen/curved
1.305.08



Wagner

flaches Modell/flat tipe

gerade/straight Länge/length
1.304.12 12,0 cm

gebogen/curved
1.305.12

Feine Scheren
Fine Scissors



IRIS fino
gerade/straight
1.308.10
1.308.11

Länge/length
10,5 cm
11,5 cm



IRIS Inzision
gebogen/curved
1.309.10
1.309.11



IRIS Inzision
seitwärts abgewinkelt/angled
Länge/length
11,5 cm
1.313.11



IRIS
Länge/length
11,5 cm
1.307.11



IRIS Inzision
gerade/straight
1.310.10
1.310.11

Länge/length
10,5 cm
11,5 cm

gebogen/curved
1.311.10
1.311.11

Feine Scheren Ribbon Type Fine Scissors Ribbon Type



Ribbon Strabismus

gerade/straight
1.700.10

Länge/length
10,0 cm

gebogen/curved
1.701.10



Ribbon Strabismus

Länge/length
10,0 cm

gebogen/curved
1.703.10



Ribbon Iris

gerade/straight
1.704.09

Länge/length
9,5 cm

gebogen/curved
1.705.09



Ribbon Iris

gerade/straight
1.704.10

Länge/length
10,0 cm 4"

gebogen/curved
1.705.10



Ribbon Stevens

gerade/straight
1.710.09

Länge/length
9,5 cm

gebogen/curved
1.711.09



Ribbon Stevens

gerade/straight
1.714.09

Länge/length
9,5 cm

gebogen/curved
1.715.09

Ligaturscheren Suture Scissors



EISELSBERG

Länge/length
11,0 cm **1.360.11**



SCHÖMACKER LOTH

Länge/length
12,0 cm **1.364.12**



LITTLER

Länge/length
11,5 cm **1.371.11**
14,0 cm **1.371.14**
18,0 cm **1.371.18**



SHORTBENT

Länge/length
9,0 cm **1.377.09**



SPENCER

Länge/length
9,0 cm **1.372.09**
10,5 cm **1.372.10**
12,0 cm **1.372.12**



NORTHBENT

Länge/length
13,0 cm **1.377.12**



SPENCER

seitwärts abgewinkelt/angled
Länge/length
11,5 cm **1.379.11**

Ligaturscheren
Suture Scissors**LITTAUER**

Länge/length
13,0 cm **1.382.13**
14,0 cm **1.382.14**

**BUCK**

Länge/length
14,5 cm **1.392.14**
18,0 cm **1.392.18**

**HEATH**

S-förmig gebogen/S-curved

Länge/length
15,0 cm **1.397.15**

Face - Lift Scheren Face - Lift Scissors



REES FACE LIFT

gerade/straight	Standard	gebogen/curved
1.100.17	17,0 cm	1.101.17
1.100.20	20,5 cm	1.101.20
Supercut		
S1.100.17	17,0 cm	S1.101.17
S1.100.20	20,5 cm	S1.101.20
TC		
TC1.974.17	17,0 cm	TC1.975.17
TC1.974.19	20,5 cm	TC1.975.19



ASTON FACE LIFT

TC gebogen/curved
16,5 cm TC1.975.16
20,5 cm TC1.975.20



BEUSE FACE LIFT

gerade/straight	Standard	gebogen/curved
1.116.14	14,5 cm	1.117.14
1.116.18	18,0 cm	1.117.18



**GORNEY-DELICATE SMAS-PLATYSMA
FACE LIFT**

20,5 cm	gebogen/curved
Supercut S1.347.20	
TC TC1.991.20	
Supercut TC S1.911.20	

Face - Lift Scheren Face - Lift Scissors



GORNEY-FREEMAN FACE LIFT

gerade/straight	19,0 cm	gebogen/curved
1.110.19	Standard	1.111.19
S1.110.19	Supercut	S1.111.19
TC1.974.18	TC	TC1.975.18
S1.974.18	Supercut TC	S1.975.18



GORNEY PLATYSMA FACE LIFT

gerade/straight	23,0 cm	gebogen/curved
1.110.23	Standard	1.111.23
S1.110.23	Supercut	S1.111.23
TC1.974.23	TC	TC1.975.23
S1.974.23	Supercut TC	S1.975.23



GORNEY FACE LIFT

gerade/straight	19,0 cm	gebogen/curved
1.114.18	Standard	1.115.185
S1.114.18	Supercut	S1.118.18
TC1.974.185	TC	TC1.975.185
S1.974.185	Supercut TC	S1.975.185

Face - Lift Scheren Face - Lift Scissors



KAYE FACE LIFT

gerade/straight	Supercut	gebogen/curved
S1.116.14	14,5 cm	S1.117.14
S1.116.18	18,5 cm	S1.117.18
S1.116.23	23,0 cm	S1.117.23

	TC	
TC1.970.145	14,5 cm	TC1.971.145
TC1.970.18	18,5 cm	TC1.971.18
TC1.970.23	23,0 cm	TC1.971.23

	Supercut TC	
S1.970.145	14,5 cm	S1.971.145
S1.970.18	18,5 cm	S1.971.18
S1.970.23	23,0 cm	S1.971.23



KAYE FACE LIFT

gerade/straight	15,0 cm	gebogen/curved
S1.110.15	Supercut	S1.110.15
TC1.970.15	TC	TC1.975.15
S1.970.15	Supercut TC	S1.975.15



KAYE-FREEMANN FACE LIFT

18,5 cm	abgewinkelt/angled
Standard	1.115.17
Supercut	S1.115.17
TC	TC1.973.18
Supercut TC	S1.973.18



DAVIS FACE LIFT

17,0 cm	gebogen/curved
Standard	1.175.17
Supercut	S1.175.17

Face - Lift Scheren Face - Lift Scissors



FREEMAN FACE LIFT
18 cm abgewinkelt/angled
Standard **1.345.17**
Supercut **S1.345.17**
TC **TC1.991.18**
Supercut TC **S1.991.18**



CASTANARES FACE LIFT
gerade/straight 16,0 cm gebogen/curved
1.440.16 Standard **1.441.16**
TC1.990.16 TC



GOLDMAN FOX
gerade/straight 13,5 cm gebogen/curved
1.484.13Z Standard **1.485.13Z**
S1.484.13 Supercut **S1.485.13**
TC1.894.13 TC **TC1.895.13**
S1.894.13 Supercut TC **S1.895.13**

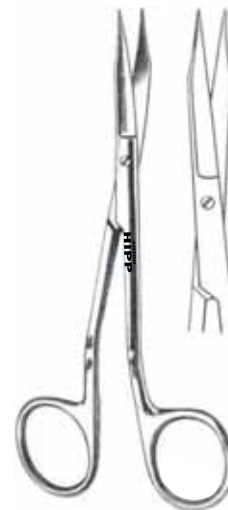

GOLDMANN FOX
S-förmig gebogen/S-curved
Länge/length
13,0 cm **1.487.13**

Blepharoplastic Scheren Blepharoplasty Scissors



PAR		
gerade/straight	Standard	gebogen/curved
1.054.11	11,5 cm	1.055.17
1.064.14	14,5 cm	1.065.20
Supercut		
S1.054.11	11,5 cm	S1.055.11
S1.054.14	14,5 cm	S1.055.14
TC		
TC1.868.11	11,5 cm	TC1.869.11
TC1.844.14	14,5 cm	TC1.845.14
Supercut TC		
S1.868.11	11,5 cm	S1.869.11
S1.844.14	14,5 cm	S1.845.14



KAYE BLEPHAROPLASTY		
gerade/straight	11,5 cm	gebogen/curved
1.058.11	Standard	1.059.11
S1.058.11	Supercut	S1.058.11
TC1.958.11	TC	TC1.959.11
S1.958.11	Supercut TC	S1.959.11



SHEA		
gerade/straight	12,0 cm	gebogen/curved
1.254.11	Standard	1.255.11
S1.254.11	Supercut	S1.255.11



GREENBERG PAR		
gerade/straight	11,5 cm	gebogen/curved
1.344.11	Standard	1.345.11
S1.344.11	Supercut	S1.345.11
TC1.956.11	TC	TC1.957.11
S1.956.11	Supercut TC	S1.957.11



KAYE BLEPHAROPLASTYC Ribbon Type		
gerade/straight	11,5 cm	gebogen/curved
1.716.10		1.717.10

Verschiedene Pinzetten Various Forceps

Gewebe- und Knorpelfasspinzetten
Tissue and cartilage forceps

ohne Schloss
without spring catch



Graefe
11 cm
3.730.11

mit Schloss
with spring catch



Graefe
11 cm
3.732.11



Adson-Brown
3.160.12 12 cm
3.160.15 15 cm

7 x 7 Zähne
7 x 7 teeth



Hinderer
13 cm
3.424.13



Cottle
15,5 cm
3.424.15



Cottle
15 cm
26.761.10

Nasenpinzetten
Nasal dressing forceps

Columella-Klemmen
Columella forceps



Masing
8,5 cm
26.760.08



Cottle
11 cm
26.760.10



Jansen
16 cm
3.441.16



Jansen
19 cm
3.441.19



Jansen
16 cm
3.443.16

1 x 2 Zähne
1 x 2 teeth

**Wundhaken
Retractors**



Freer
15 cm
6.156.15

Cottle
16 cm
26.774.16

Joseph
15 cm
6.154.01

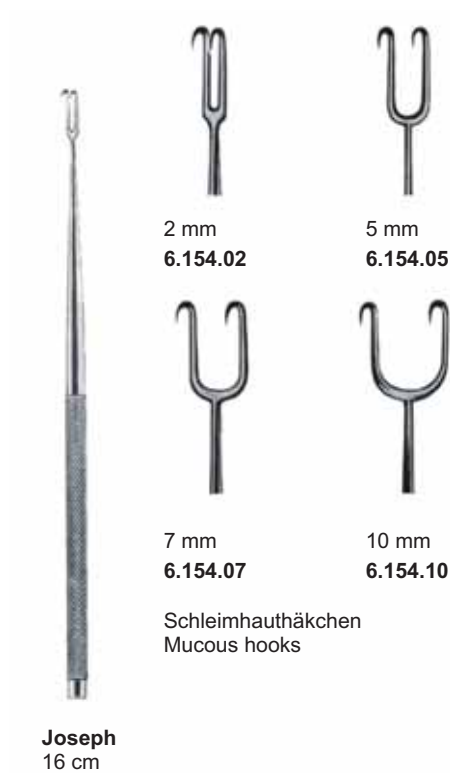

2 mm
6.154.02

5 mm
6.154.05

7 mm
6.154.07

10 mm
6.154.10

Schleimhauthäkchen
Mucous hooks

Joseph
16 cm

Nasenflügelhaken Hooks for posterior nares



Cottle
14 cm
26.778.01



Cottle
14 cm
26.778.02



Cottle
14 cm
26.778.03



Fomon
16 cm
26.779.16



Neivert
20 cm
26.782.16



Cottle-Neivert
20 cm
26.780.20

Choanenhaken
Hook for posterior nares



Fomon
17 cm
26.776.17



Lange
22 cm
6.131.04



Cottle
15 cm
26.783.01



Aufricht (Walter)
13,5 cm
26.769.13



Aufricht
16 cm
26.767.16
26.767.17
L = 45 mm
L = 60 mm

Flach- und Hohlmeißel für Rhinologie und plastische Operation Chisels and Gouges for Rhinology and Plastic Operations

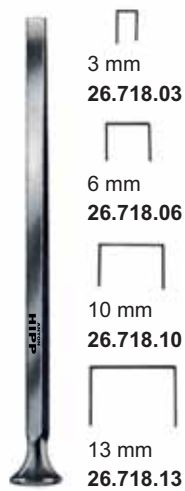

Carroll (French pattern)
14,5 cm

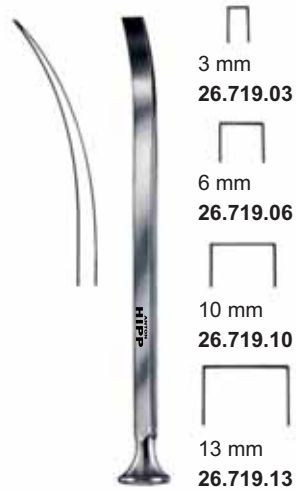

Carroll (French pattern)
14,5 cm

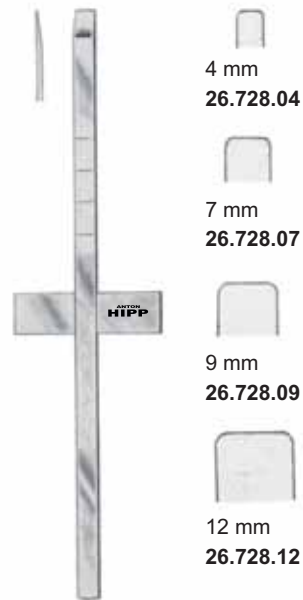

Cottle
18 cm



Cottle
18 cm
26.729.06

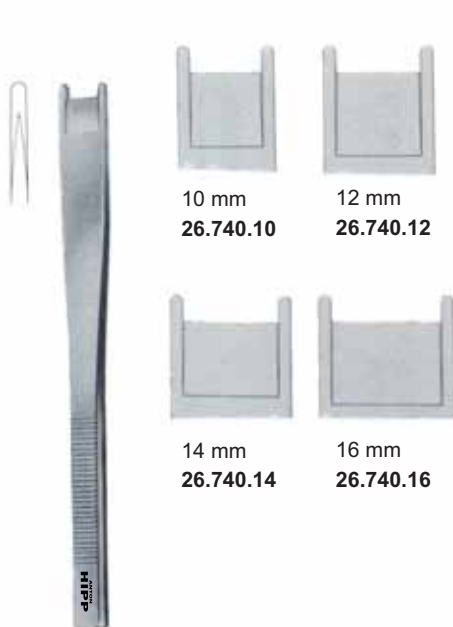

Cinelli
16 cm



Silver
18 cm
26.741.01



Silver
18 cm
26.741.02



Silver
18 cm
26.741.03

Flach- und Hohlmeißel für Rhinologie und plastische Operation Chisels and Gouges for Rhinology and Plastic Operations

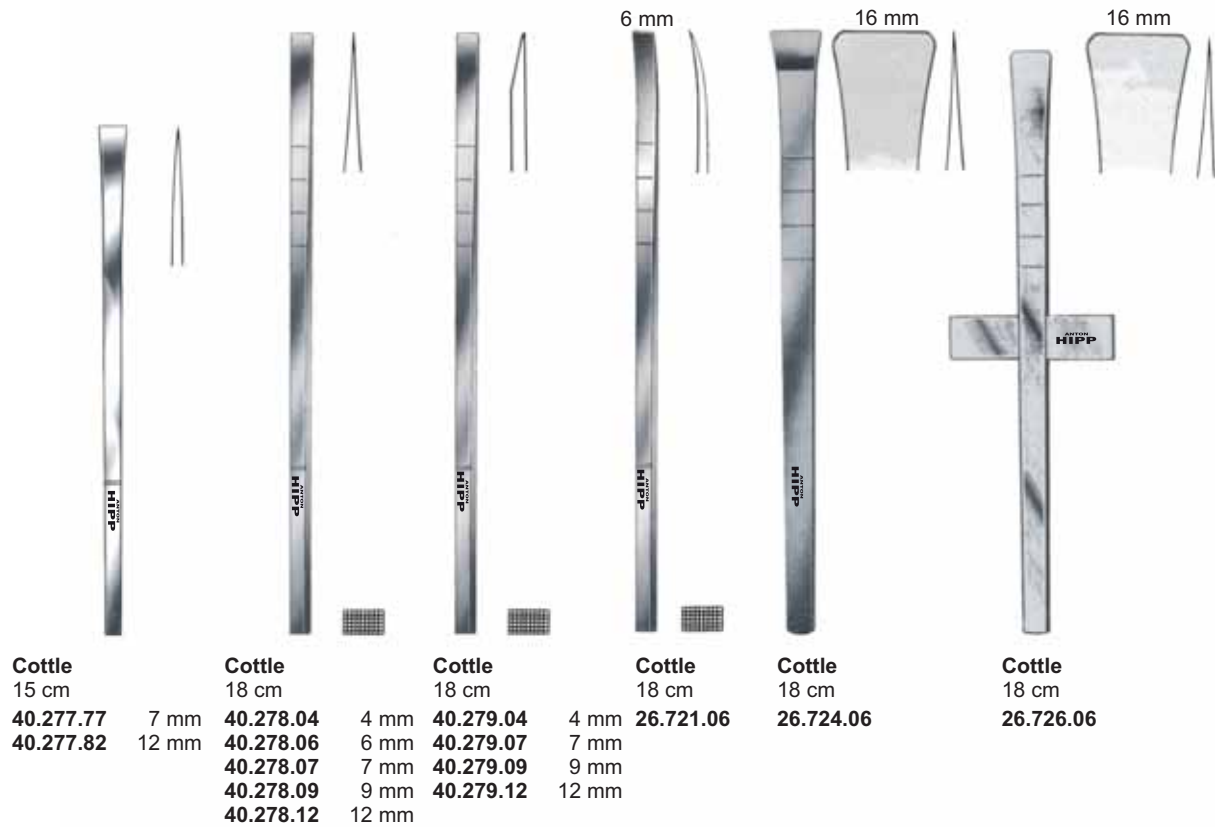

Cottle 15 cm 40.277.77 7 mm 40.277.82 12 mm	Cottle 18 cm 40.278.04 4 mm 40.278.06 6 mm 40.278.07 7 mm 40.278.09 9 mm 40.278.12 12 mm	Cottle 18 cm 40.279.04 4 mm 40.279.07 7 mm 40.279.09 9 mm 40.279.12 12 mm	Cottle 18 cm 26.721.06	Cottle 18 cm 26.724.06	Cottle 18 cm 26.726.06
---	---	---	-------------------------------------	-------------------------------------	-------------------------------------

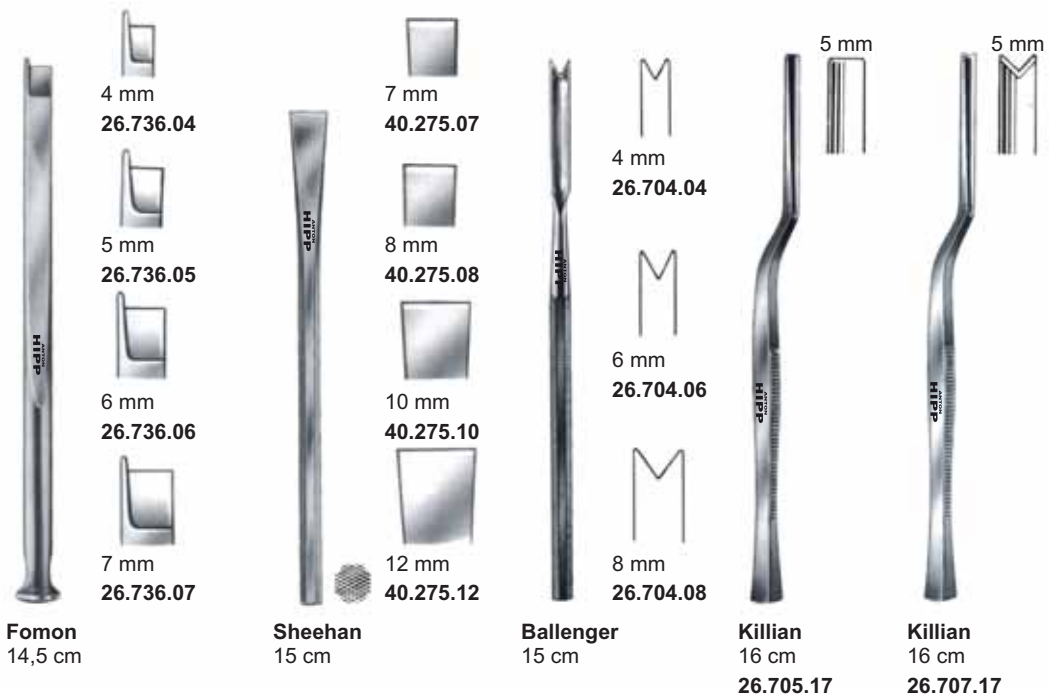

Fomon 14,5 cm 26.736.04 4 mm 26.736.05 5 mm 26.736.06 6 mm 26.736.07 7 mm	Sheehan 15 cm 40.275.07 7 mm 40.275.08 8 mm 40.275.10 10 mm 40.275.12 12 mm	Ballenger 15 cm 26.704.04 4 mm 26.704.06 6 mm 26.704.08 8 mm	Killian 16 cm 26.705.17 5 mm	Killian 16 cm 26.707.17 5 mm
---	---	---	---	---

Periostome, Flach- und Hohlmeißel, Nasen- und Ethmoid-Küretten Periosteotomes, Chisels and Gouges, Nasal and Ethmoid Curettes



26.746.04

26.747.04

Freer
19 cm



4 mm

4 mm

Freer
16 cm
40.254.04

Freer
16 cm
40.255.04

6 mm



Freer
15 cm
40.256.06

Meißel zur endonasalen
Kieferhöhlenöffnung
Antrum trocar chisel



Faulkner
15 cm
26.748.15



3 mm

26.732.03

4,5 mm

26.732.04

Walter
18 cm



Coakley
17 cm



Fig.1
26.790.01



Fig.2
26.790.02



Fig.3
26.790.03



Fig.4
26.790.04



Fig.5
26.790.05



Fig.6
26.790.06



Ethmoid

Faulkner
21 cm
26.787.21



Coakley
20 cm
26.788.01
26.788.03
26.788.04

Fig. 1 + 2
Fig. 3 + 6
Fig. 4 + 5

Raspatorien, Elevatorien
Raspatories, Elevators



Williger
13 cm
40.355.14

Williger
16 cm
40.355.15

Williger
16 cm
40.355.16



Fommon
17 cm
40.356.18

Joseph
16 cm
40.356.16

Joseph
16 cm
40.356.17

Raspatorien, Elevatorien
Raspatories, Elevators

Septum elevatorien
Septum Elevators

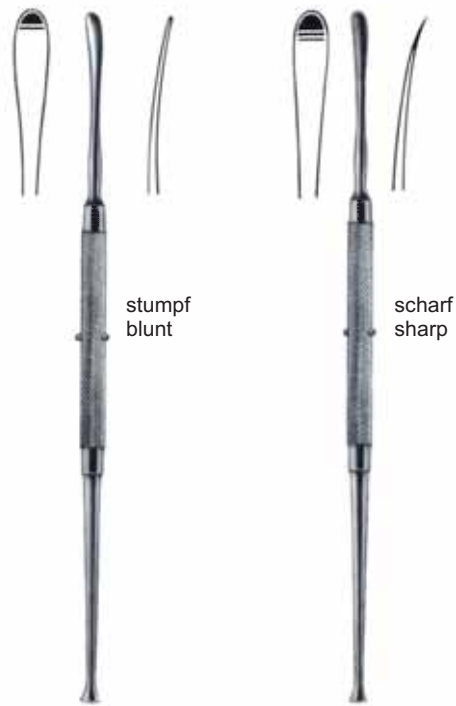

Freer
19 cm
40.358.19

Freer
19 cm
40.359.19

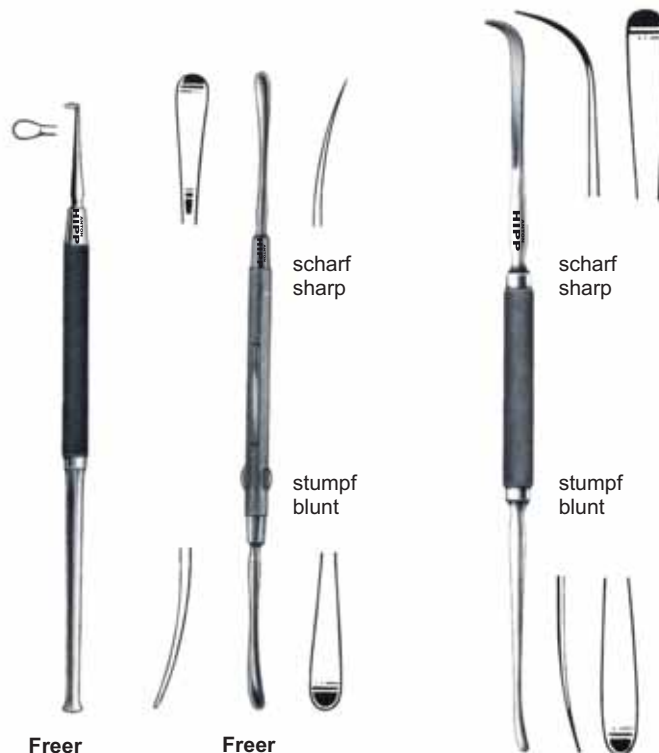

Freer
17 cm
40.668.17

Freer
18 cm
40.663.18

Freer
20 cm
40.665.20

Raspatorien Raspatories



4 mm

26.683.04

McKenty
15 cm



5 mm

26.683.05



6 mm

40.379.06

17 cm

8 mm

40.379.08



5 mm

40.348.05

16 cm

6 mm

40.348.06

7 mm

40.348.07



40.380.03

Adson
17 cm



40.380.04



5 mm

König
15,5 cm
40.353.15



5 mm

40.348.05

7 mm

40.348.07

9 mm

40.348.09

Hyllin
14,5 cm



Sewall
20 cm
40.347.20

Septumelevatoren und -raspatorien
Septum Elevators and Raspatories



Cottle
23 cm
26.693.22

McKenty
22 cm
26.691.21

Killian
18 cm
40.363.18

Killian
22 cm
40.363.22



Pierce
21 cm
26.672.21

Pennington
21 cm
26.673.21

Carter
21 cm
26.676.21

Septumelevatorien und -raspatorien
Septum Elevators and Raspatories



18 cm
26.676.18

Joseph-Masing
22 cm
26.688.22

Howarth
21 cm
26.695.22

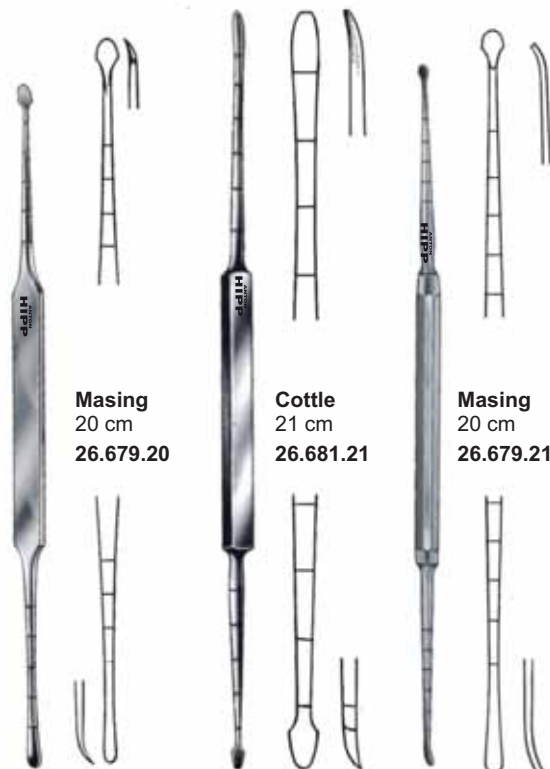

Masing
20 cm
26.679.20

Cottle
21 cm
26.681.21

Masing
20 cm
26.679.21

**Elevatoren
Elevators**

Jochbogenelevatoren
Zygoma Elevators



Dingman
21 cm
26.823.21

Gillies
24 cm
26.824.24

Gillies
24 cm
26.824.25

Septumfraktur-Elevatorium
Septum Displacer

Nasenfraktur-Elevatorium
Nasal Fracture Elevator



Goldmann
20 cm
26.822.20

Boies
18 cm
26.820.18

Elevatoren Elevators



Raspeln
Rasps



Maltz TC^{TC}
18 cm



Fig. 1
40.442.01



Fig. 2
40.442.02



Fig. 3
40.442.03



Fig. 4
40.442.04



Fig. 5
40.442.05



Fig. 6
40.442.06



Fig. 7
40.442.07



Fig. 8
40.442.08



Fig. 9
40.442.09



Fig. 10
40.442.10



18 cm
40.452.01



18 cm
40.452.02



Miller

Raspeln Rasps

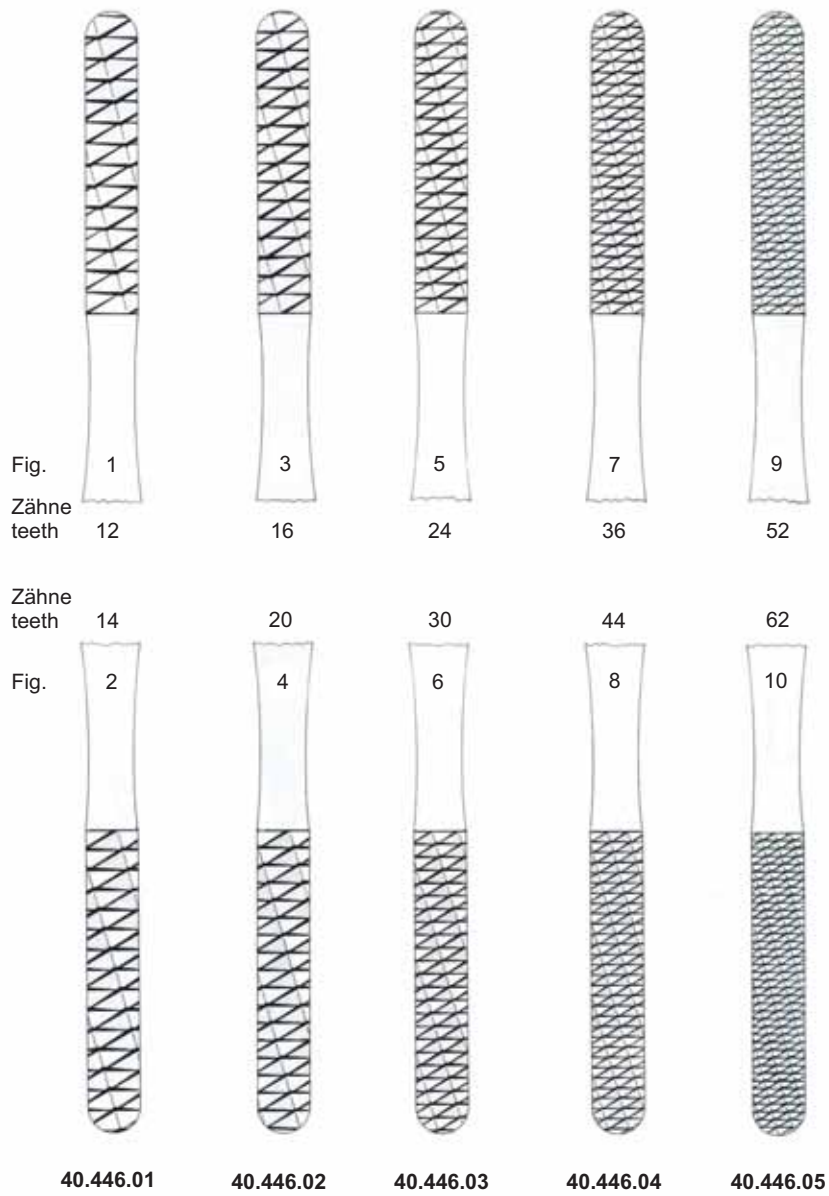

Fomon
20 cm

Knochenfeile, Nasenraspeln
Bone File, Nasal Rasps



Maltz
18 cm
40.442.18



Joseph
16 cm
40.440.01



Aufricht
21 cm



Cottle
21 cm
40.439.21

Septum- und Rhinoplastik Plastic Surgery

Applikator mit Bruststütze
Applicator with chest support



26.757.01

Cottle

26.757.02

Knorpelquetsche mit Entnahmeklammer
Cartilage crusher, with clamp for taking out
the prepared material



Cottle

26.756.00



Cottle
19 cm
40.202.30

Die gewölbte Seite wird für die Knorpelquetsche
verwendet
The convex face is used for the cartilage crusher

Ø 30 mm
240 g

1 Seite flach, 1 Seite gewölbt
1 plain face, 1 convex face



Cottle
15,5 cm
3.424.15

Ringmesser, Nasensägen
Adenoid Curettes, Nasal Saws



Beckmann-Barnhill
22 cm



26.180.01



26.180.02

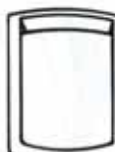

26.180.03



26.180.04



26.180.05



26.180.06



St. Clair-Thompson
21 cm

Ringmesser
Adenoid curettes



26.186.01



26.186.02



26.186.03



26.186.04

Ringmesser, Nasensägen
Adenoid Currettes, Nasal SawsNasensägen
Nasal saws**Joseph**
17 cm
26.751.01**Joseph**
17 cm
26.751.02**Joseph**
19 cm
26.752.01**Joseph**
19 cm
26.752.02**Joseph**
19 cm
26.752.03

Nasenpolypenschnürer, Drahtinstrumente Nasal Polypus Snares, Wire Instruments



Krause
26 cm
26.621.26



Krause-Voss
26 cm
26.623.26

mit 2 Aufsätzen
with 2 cannulas



Lange-Wilde (Bruenings)
24 cm
26.624.24

Drahtinstrumente
Wire instruments

0,8/1,2 mm



Universal
TC1.897.12



13 cm
Drahtschere
Wire cutting scissor



Drahtbiergezange
Wire bending plier
40.854.17

17 cm

Stahldraht für Nasenpolypenschnürer
Steel Wire for nasal polypus snares

Ø 0,3 mm 26.158.03
Ø 0,4 mm 26.158.04
Ø 0,5 mm 26.158.05



10 m

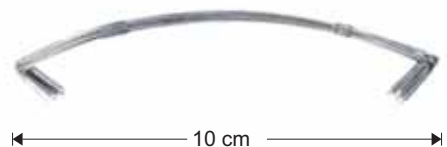

10 cm

Ø mm	12	100
0,3	26.627.03	26.627.13
0,4	26.627.04	26.627.14
0,5	26.627.05	26.627.15

Septum-Spritzen und Kanülen auf Anfrage
Septum needles and syringes on request

Drahtscheren Wire Cutting Scissors



BEEBEE
stumpf/blunt

gerade/straight	Länge/length	gebogen/curved
1.470.10	10,5 cm	1.471.10
1.470.12	12,0 cm	1.471.12



BEEBEE
spitz/sharp

gerade/straight	Länge/length	gebogen/curved
1.474.10	10,5 cm	1.475.10
1.474.12	12,0 cm	1.475.12



UNIVERSAL

Länge/length
12,0 cm **1.477.12**



SMITH serrated

gerade/straight	Länge/length	gebogen/curved
1.494.16	16,0 cm	1.495.16

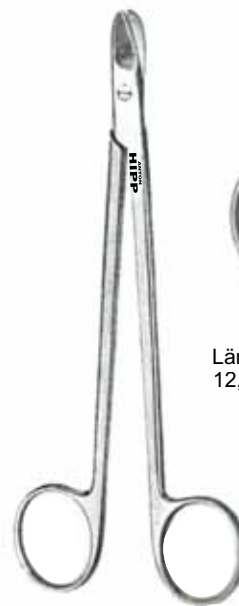

HARVEY

Länge/length
12,5 cm **1.480.12**

Naht, Saugrohre, Spülkanülen, Stirnhöhlen-Dilatatoren Suture, Suction Tubes, Wash Cannulas, Frontal Sinus Bougies

Septumnadeln
Septum suture needles

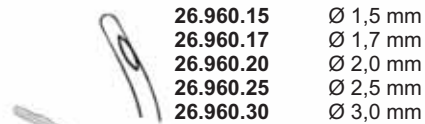

für die Kieferhöhle
for maxillary antrum

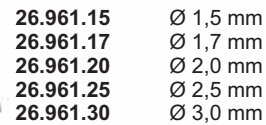

Schlaucholive für Siebenmann
Tubing connector for Siebenmann
26.960.01



Nasensaugrohre
Nasal suction tubes

tip 6,5 mm



Stirnhöhlendilatatoren
Frontal sinus bougies

2,0 mm
27.561.01

2,5 mm
27.561.02

3,0 mm
27.561.03

4,0 mm
27.561.04

5,0 mm
27.561.05



Messinstrumente Measuring Instruments

Sensibilitätsinstrumente
Sensitivity Instruments



Nervrädchen
Neurological Pinwheel

Aly
17 cm
24.014.17

Wartenberg
19 cm
24.015.18

Dynamometer
Dynamometer



Collin
für Kinder
for children
24.014.02

kg-Einteilung
kg scale

für Erwachsene
for adults
24.014.02

kg-Einteilung
kg scale

für Erwachsene
for adults
24.014.00

lbs-Einteilung
lbs scale

Winkelmesser
Goniometer



Möltgen
24 cm
24.021.01



Stahlmessstab, rostfrei, Zentimeter- und Zolleinteilung
Rule, stainless steel, graduated in centimeters and inches

	Teilungslänge length of graduation	
	mm	inches
24.032.10	100	4
24.032.15	150	6
24.032.20	200	8
24.032.30	300	12
24.032.50	500	20

Mess- und Markierungszirkel
Scleral Markers and Calipers



Castroviejo

	Länge Length	9 cm			18 cm		
		Messbereich Measuring range	gerade straight	45° abgewinkelt angled at 45°	gerade straight	gebogen curved	45° abgewinkelt angled at 45°
15 mm	24.016.15	24.016.50					
20 mm	24.016.20	24.016.51	24.016.60				
40 mm	24.016.40	24.016.52	24.016.61	24.018.40	24.018.50	24.018.60	



Castroviejo

Mund

Mouth

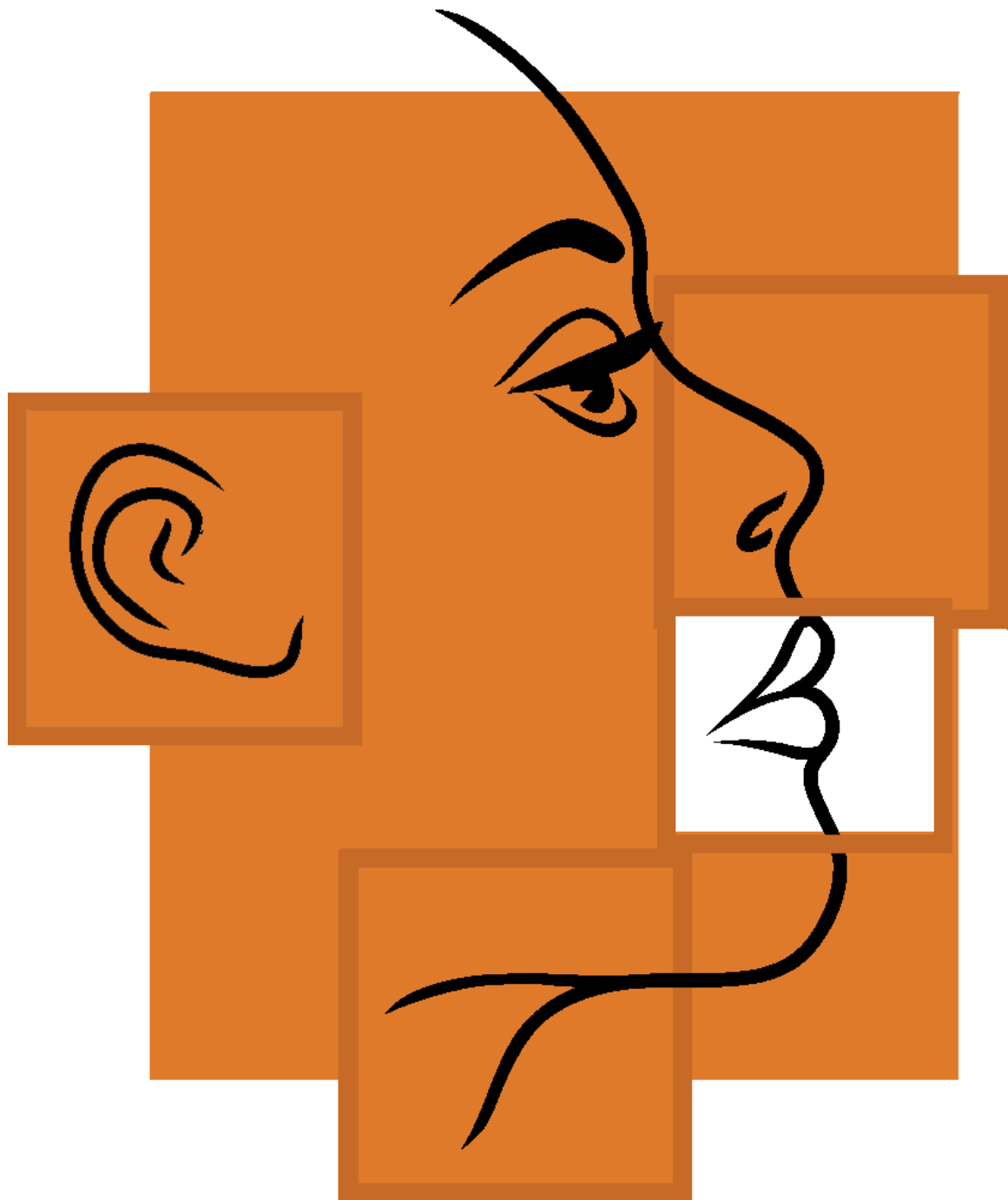

Zungenspachtel, Zungendrucker
Tongue Spatulas, Tongue Depressor



Bruenings
19 cm
26.009.19



14,5 cm
26.000.14



15 cm
26.002.14



18 mm
23 mm
Buchwald
18 cm
26.004.08



Mayo
17 cm
26.002.17



Frenzel
16,5 cm
26.007.16

Mundkeile
Oral screws



aus Holz
out of wood
26.075.10

aus Hartgummi
out of hard rubber
26.075.11

Mauder

Mundsperrer, Zungenspachtel, Zungendrucker
Mouth Gags, Tongue Spatulas, Tongue Depressor

Mundsperrer
Mouth gags



Doyen-Jansen (Molt)
10 cm 26.023.10
11 cm 26.025.12
14 cm 26.026.14

Zungenspatel, Zungendrucker
Tongue spatulas, tongue depressors



Tobold
14,5 cm
26.010.16



Moritz-Schmidt
19 cm
26.010.19



Hartmann
15 cm
26.011.15



Wieder
12 cm



29 mm
26.017.01

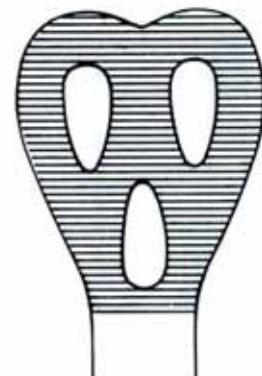

35 mm
26.017.02

Mundsperrer (ohne Zungendrucker) Mouth Gags (without tongue depressor)

Maßangaben = Nutzweite
Dimensions = effective width



Whitehead

9 cm	26.031.09
11 cm	26.031.11
13 cm	26.031.13
15 cm	26.031.15



Jennings

9 cm	26.033.09
11 cm	26.033.11
13 cm	26.033.13
15 cm	26.033.15

automatisch nachstellende Sperre
automatic adjusting ratchet



9 cm	26.033.49
11 cm	26.033.51
13 cm	26.033.53
15 cm	26.033.55



Seemann-Seifert

9 cm	26.034.09
11 cm	26.034.11
13 cm	26.034.13
15 cm	26.034.15

Mundwinkelhalter, Lippenhalter, Zungenhalter
Cheek and Lip Retractors, Tongue Holding Forceps



19 cm **26.071.19**
21 cm **26.071.21**

Mundwinkelhalter mit beweglicher Valve
Cheek retractor with flexible blade



Sternberg
Lippenhalter
Lip retractor

14 cm **26.068.14**
16 cm **26.068.16**
18 cm **26.068.18**



Sternberg
Lippenhalter
Lip retractor

12 cm **26.070.12**
14 cm **26.070.14**
16 cm **26.070.16**

Zungenzangen
Tongue holding forceps



Collin
16 cm **26.072.16**
18 cm **26.072.18**



Young
17 cm
26.073.16



1 Paar Ersatzgummi
1 pair of spare rubber pads
26.073.99

Tonsillektomie

Tonsillectomy

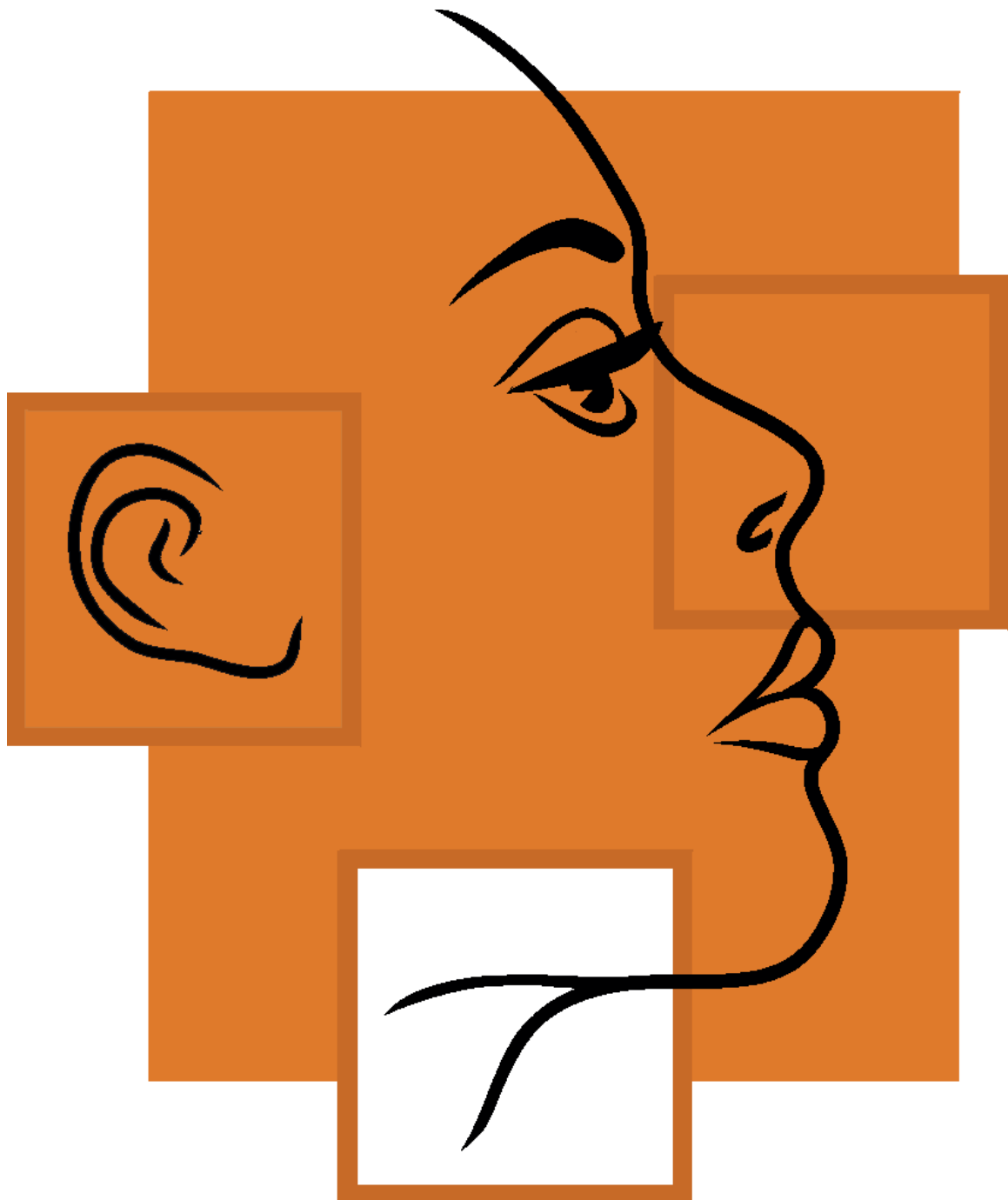

**Tonsillektomie
Tonsillectomy**

Tonsillennmesser
Tonsil knives



Canfield
21 cm
24.370.21

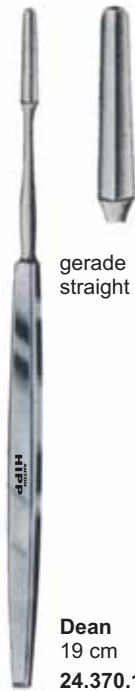

gerade
straight

Dean
19 cm
24.370.18



abgewinkelt
angled

Dean
19 cm
24.370.19



Bruenings
23 cm
24.371.22



Abraham
21 cm
24.371.21



gezahnt
toothed

Fisher
22,5 cm
26.109.20



Tyding
21 cm
24.371.51



Day
21,5 cm
24.371.61

Tonsillektomie
Tonsillectomy

Dissektoren, Retraktoren und Elevatoren für Tonsillen
Tonsil dissectors, retractors and elevators



Tonsillektomie
Tonsillectomy

Dissektoren, Retraktoren und Elevatoren für Tonsillen
Tonsil dissectors, retractors and elevators



Henke
23 cm
26.102.01



Henke
23 cm
26.102.02



Henke
23 cm
26.102.03



Yankauer
21 cm
26.103.21

Tonsillektomie Tonsillectomy

Tonsilltamponstopfer
Tonsil gauze packer



Luniatschek
19 cm
26.160.01 1,8 mm
26.160.02 2,5 mm

Gaumensegelhäkchen
Soft palate retractor



Nager
23 cm
26.175.23

Gaumensegelhalter
Velum retractor



Haslinger
17 cm
26.174.00

Nasenrachenraum- und
Zäpfchenretractoren
Nasopharyngeal and uvula
retractors



Love
15 cm B
26.176.18 18 mm
26.176.20 20 mm
26.176.22 22 mm

Tonsillektomie Tonsillectomy

Tonsillenscheren
Tonsil scissors



Metzenbaum
18 cm
1.051.18



1 Schneide gezahnt
1 Blade serrated

Dean
17 cm
1.124.17



Böttcher
18 cm
1.115.18



Prince
17,5 cm
1.105.17

Tonsillenklemmen
Tonsil clamps



Schnidt
19 cm
2.591.19

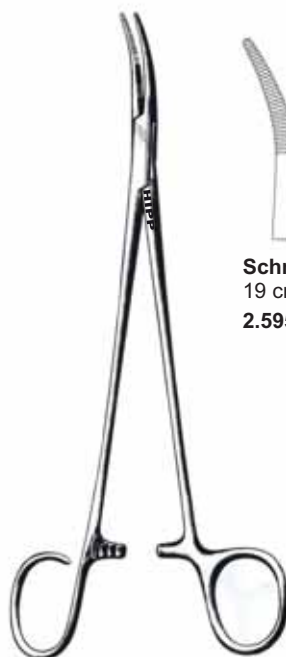

Schnidt
19 cm
2.595.19



Schnidt
19 cm
2.597.19



Negus
19 cm



Fig. 1
2.183.19



Fig. 2
2.185.19

**Tonsillektomie
Tonsillectomy**

Tonsillenfasszangen
Tonsil seizing forceps



White
18 cm **26.085.18**
23 cm **26.085.23**



Allis-Coakley (Clover)
19 cm
26.081.19



Allis-Coakley
18,5 cm
26.081.18



Clover
20 cm
26.083.19



Ballenger
21,5 cm
26.094.21



Mikulicz
18 cm
26.095.18



Blohmke
20 cm
2.559.20

**Tonsillektomie
Tonsillectomy**

Tonsillenschnürer
Tonsil snares



Eves
25 cm
mit Sperre
with ratchet
26.150.26



Eves
25 cm
ohne Sperre
without ratchet
26.152.25



Bruenings
27 cm
mit Sperre
with ratchet
26.154.27



26.155.05



26.155.06

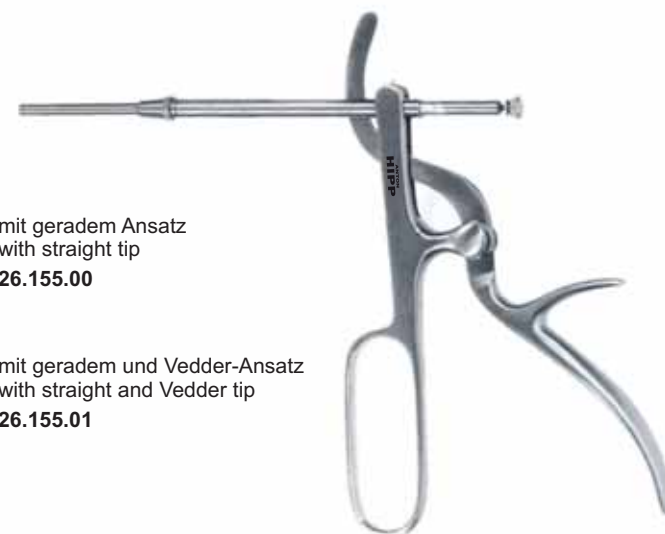

mit geradem Ansatz
with straight tip
26.155.00

mit geradem und Vedder-Ansatz
with straight and Vedder tip
26.155.01

Tyding

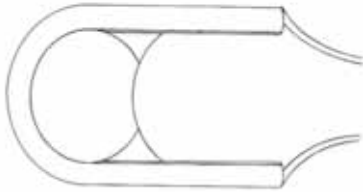
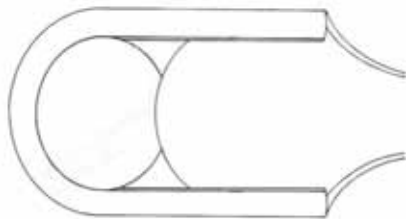
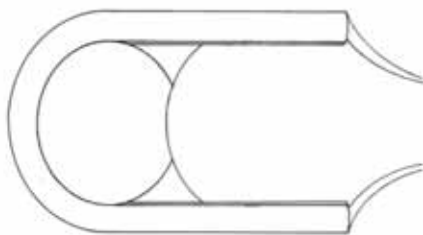
Tonsillektomie
TonsillectomyTonsillotome
TonsillectomesFig. 1
26.159.01Fig. 2
26.159.02Fig. 3
26.159.03**Sluder-Ballenger**
komplett mit Aufsätzen, Fig. 1-3
completewith 3 blades, Fig. 1-3
26.159.00Griff allein
handle only
26.159.04**Sluder-Ballenger**

Tonsillektomie
TonsillectomyTonsillennadeln
Tonsil needles**Hurd**
21 cm
26.163.21**Hurd**
21 cm
26.165.21**Nager**
24 cm
26.166.24**Claus-Eicken**
23 cm
26.167.25

**Tonsillektomie
Tonsillectomy**

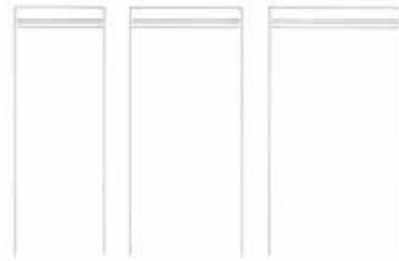

Fig. 1 Fig. 2 Fig. 3

Pharynx-Tonsillotome mit 2 ungelochten Klingen
Adenotomes with 2 unperforated blades
13 mm 16 mm 19 mm
26.186.01 26.186.02 26.186.03

ungelochte Ersatzklingen, einzeln
unperforated spare blades, single
Fig. 1 Fig. 2 Fig. 3
26.186.11 26.186.12 26.186.13



La Force



Fig. 1 Fig. 2 Fig. 3

Pharynx-Tonsillotome mit 2 gelochten Klingen
Adenotomes with 2 perforated blades
13 mm 16 mm 19 mm
26.187.01 26.187.02 26.187.03

gelochte Ersatzklingen, einzeln
perforated spare blades, single
Fig. 1 Fig. 2 Fig. 3
26.187.11 26.187.12 26.187.13



Tonsillektomie
Tonsillectomy



La Force
neues vereinfachtes Modell,
besonders leicht zerlegbar
new simplified pattern,
easily detachable

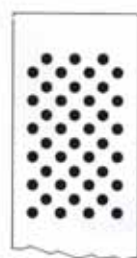

Fig. 1

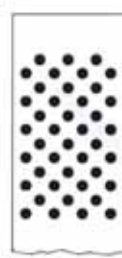

Fig. 2

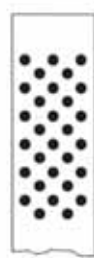

Fig. 3



Fig. 4



Fig. 5

Pharynx-Tonsillotome kpl. mit 2 gelochten Klingen
Adenotomes cpl. with 2 perforated blades
18 mm 16 mm 12 mm
26.188.01 26.188.02 26.188.03

gelochte Ersatzklingen, einzeln
perforated spare blades, single
Fig. 1 Fig. 2 Fig. 3
26.188.11 26.188.12 26.188.13

Pharynx-Tonsillotome kpl. mit 2 gelochten Klingen
Adenotomes cpl. with 2 perforated blades
11 mm 8 mm
26.188.04 26.188.05

gelochte Ersatzklingen, einzeln
perforated spare blades, single
Fig. 4 Fig. 5
26.188.14 26.188.15

Tonsillektomie Tonsillectomy

Stahldraht für Tonsillenschnürer
Steel wire for tonsil snares



Ø 0,3 mm **26.158.03**
Ø 0,4 mm **26.158.04**
Ø 0,5 mm **26.158.05**

Schnürerdrähte, geformt
Snare wires, shaped



L = 10 cm

Ø mm	12	100
0,3	26.627.03	26.627.13
0,4	26.627.04	26.627.14
0,5	26.627.05	26.627.15

L = 12 cm

Ø mm	12	100
0,3	26.156.03	26.156.13
0,4	26.156.04	26.156.14
0,5	26.156.05	26.156.15

Drahtschlingen, gelötet
Wire loops, soldered



0,4 x 40 mm
26.157.04



0,4 x 50 mm
26.157.05

Röderbinder
Ligature Carrier



Roeder
Form E
26,5 cm
26.172.26

Drahtinstrumente
Wire instruments

0,8/1,2 mm



Universal
TC1.897.12



13 cm
Drahtschere
Wire cutting scissor



Drahtbiegezange
Wire bending plier
40.854.17

Tonsillektomie Tonsillectomy

Tonsillenzangen
Tonsil Punch Forceps



Ø 5 mm
40.040.05

Ø 7 mm
40.040.07

Ø 9 mm
40.040.09

Ø 11 mm
40.040.11

Ø 5 mm
40.041.01

Ø 7 mm
40.041.02

Ø 9 mm
40.041.03



Schmeden

Hartmann

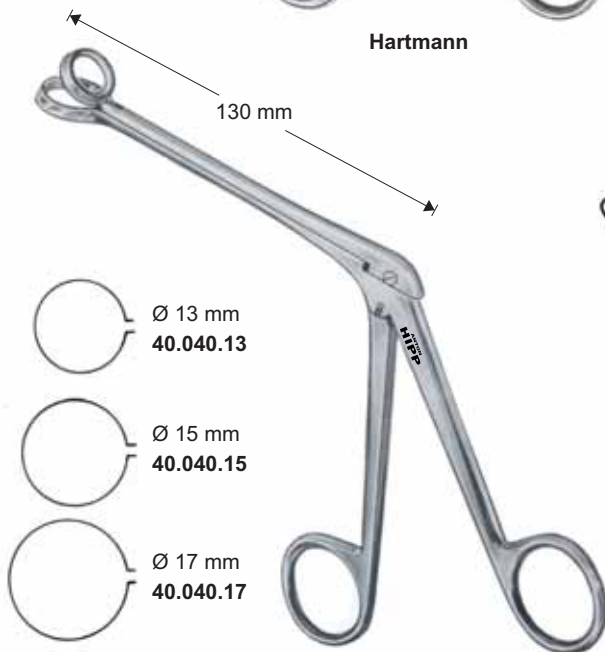

Ø 13 mm
40.040.13

Ø 15 mm
40.040.15

Ø 17 mm
40.040.17

Hartmann

Tonsillenabszess-Zange
Peritonsillar abscess forceps



Thilenius
20 cm
26.110.19

Tonsillenkompessorium
Tonsil hemostat



Corwin
14 cm
26.161.00

Tonsillektomie
TonsillectomyAdenoidstanzen
Adenoid Punches

Ø 11 mm

**Hartmann**
26.188.11

11 mm

**Meltzer**
26.189.11Nasenrachenzange
Naso-pharyngeal forceps**Jatho**
26.193.24

Tonsillektomie Tonsillectomy

Saugrohre
Suction tubes

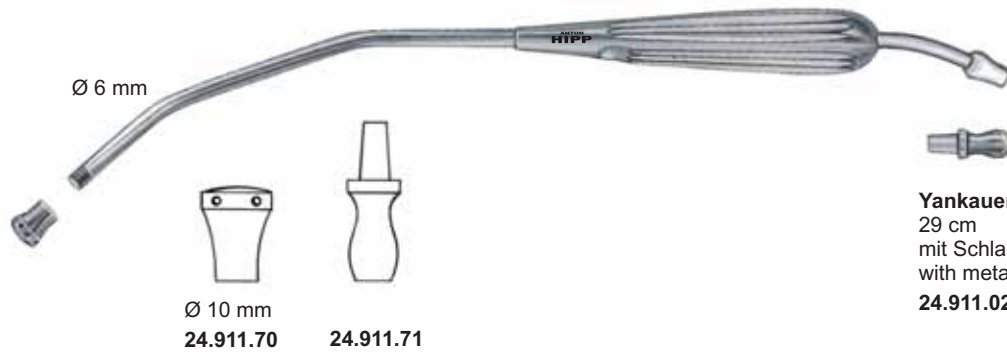

Yankauer
29 cm
mit Schlaucholive
with metal connection
24.911.02

← L →

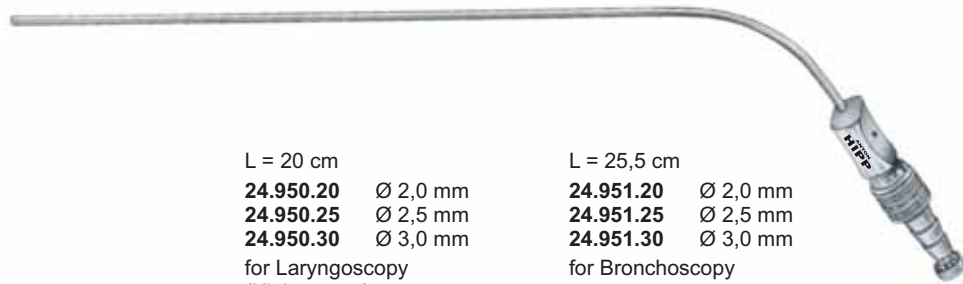

L = 20 cm
24.950.20 Ø 2,0 mm
24.950.25 Ø 2,5 mm
24.950.30 Ø 3,0 mm
for Laryngoscopy
(Kleinsasser)

L = 25,5 cm
24.951.20 Ø 2,0 mm
24.951.25 Ø 2,5 mm
24.951.30 Ø 3,0 mm
for Bronchoscopy

Olive
Ø 6 - 9 mm

← 25 cm →



Ø 3,5 mm

Koagulations-Saugkanüle
Coagulation suction cannula

Olive
Ø 9 mm
mit LUER-LOCK
with LUER-LOCK
24.953.26

Kehlkopfinstrumente Tracheotomie

Instruments for larynx Tracheotomy

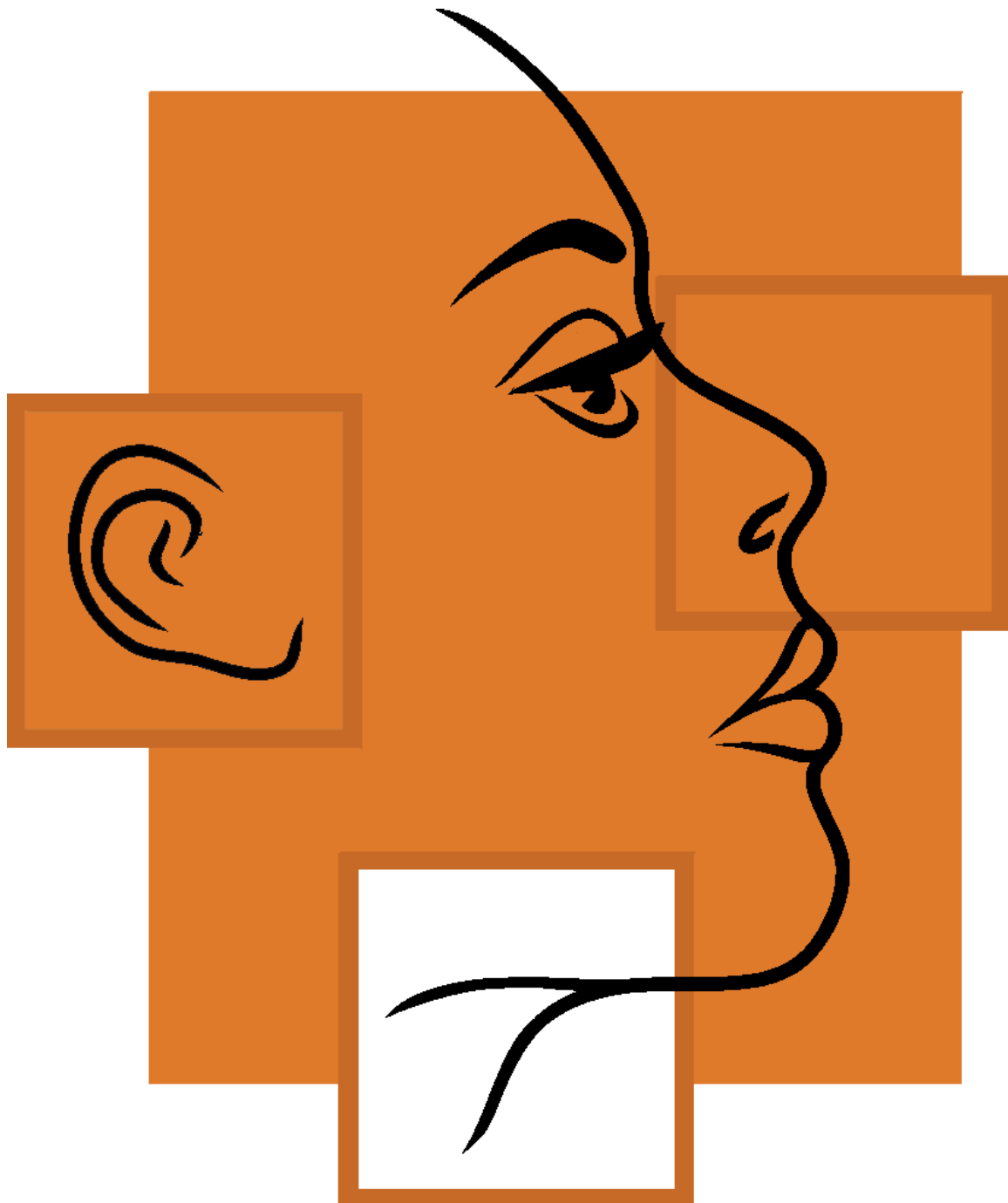

Laryngo- Broncho- Oesophagoskopie Laryngo- Broncho- Esophagoscopy

Kehlkopfspiegel und -griffe
Laryngeal mirrors and handles

Griffe für Kehlkopfspiegel
Handles for Laryngeal Mirrors



mit massivem Sechskantgriff
with solid hexagonal handle

ohne Griff
without handle



Fig. 000 = Ø 6 mm	26.200.06	26.210.06
Fig. 00 = Ø 8 mm	26.200.08	26.210.08
Fig. 0 = Ø 10 mm	26.200.10	26.210.10
Fig. 1 = Ø 12 mm	26.200.12	26.210.12
Fig. 2 = Ø 14 mm	26.200.14	26.210.14
Fig. 3 = Ø 16 mm	26.200.16	26.210.16
Fig. 4 = Ø 18 mm	26.200.18	26.210.18
Fig. 5 = Ø 20 mm	26.200.20	26.210.20
Fig. 6 = Ø 22 mm	26.200.22	26.210.22
Fig. 7 = Ø 24 mm	26.200.24	26.210.24
Fig. 8 = Ø 26 mm	26.200.26	26.210.26
Fig. 9 = Ø 28 mm	26.200.28	26.210.28
Fig. 10 = Ø 30 mm	26.200.30	26.210.30

Tracheotomie Tracheotomy

Trachealhäkchen
Trachea Retractors



16 cm

scharf
sharp



6.120.01
6.121.01



6.120.02
6.121.02



6.120.03
6.121.03



6.120.04
6.121.04

stumpf
blunt



6.122.01
6.123.01



6.122.02
6.123.02



6.122.03
6.123.03



6.122.04
6.123.04



16 cm



16 cm

scharf
sharp



6.124.01



6.124.02



6.124.03



6.124.04



16 cm

stumpf
blunt



6.126.01



6.126.02



6.126.03



6.126.04



16 cm

halbscharf
semi-sharp



6.125.01



6.125.02



6.125.03



6.125.04

Tracheotomie Tracheotomy

Trachealhäkchen
Trachea retractors

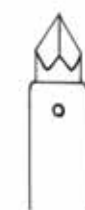
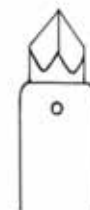

Tracheotomie
TracheotomyTrachealtrokare zur Interkrikothyreotomie
Trachea trocars for intercricothyreotomyKanüle aus Silber
Cannula of silver**Uckermann**
13 cmØ 7,5 mm
26.311.07Ø 9 mm
26.311.09Trachealdilatatore
Tracheal dilators**Trousseau**
14 cm
26.315.14**Laborde**
14 cm
26.317.14

Tracheotomie Tracheotomy

Trachealkanülen
Trachea Tubes

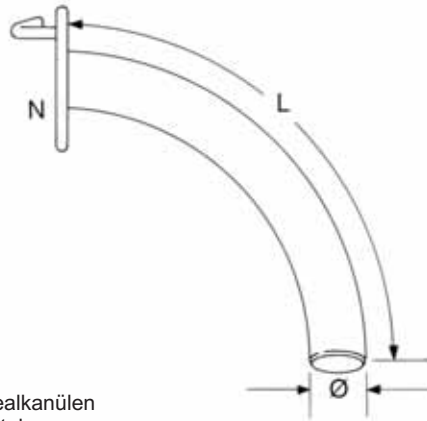

Internationale Skala für Trachealkanülen
International scale for trachea tubes

Fig.	0	1	2	3	4	5	6	7	8	9
Ø mm	4	5	6	7	8	9	10	11	12	13
Charr.	12	15	18	21	24	27	30	33	36	39
L = Länge mm	45	50	55	60	65	70	75	80	85	90



Luer
Standardmodell
Standard pattern

Fig.	Ø mm	L mm	Silber Silver	Neusilber German Silver
0	4	45	27.700.00	27.700.20
1	5	50	27.700.01	27.700.21
2	6	55	27.700.02	27.700.22
3	7	60	27.700.03	27.700.23
4	8	65	27.700.04	27.700.24
5	9	70	27.700.05	27.700.25
6	10	75	27.700.06	27.700.26
7	11	80	27.700.07	27.700.27
8	12	85	27.700.08	27.700.28
9	13	90	27.700.09	27.700.29



Kanülenreinigungsbürste
Cleaning brush for trachea tubes
26 cm , Ø 12 mm
27.712.26

Tracheotomie Tracheotomy

Trachealkanülen
Trachea tubes



Chevalier-Jackson

Fig.	Ø mm	L mm	Silber Silver	Neusilber German Silver	rostfreier Stahl 18/8 stainless steel 18/8
0	4	45	27.704.00	27.704.20	20.704.40
1	5	50	27.704.01	27.704.21	20.704.41
2	6	55	27.704.02	27.704.22	20.704.42
3	7	60	27.704.03	27.704.23	20.704.43
4	8	65	27.704.04	27.704.24	20.704.44
5	9	70	27.704.05	27.704.25	20.704.45
6	10	75	27.704.06	27.704.26	20.704.46
7	11	80	27.704.07	27.704.27	20.704.47
8	12	85	27.704.08	27.704.28	20.704.48
9	13	90	27.704.09	27.704.29	20.704.49



Ventil-Sprechkanülen mit rundem Aufsteckventil, Normalradius N,
nur in Neusilber verfügbar

Valve speaking tubes with detachable round valve, regular radius N
available only in German Silver

Fig.	Ø mm	Neusilber German Silver
4	8	27.706.24
5	9	27.706.25
6	10	27.706.26
7	11	27.706.27
8	12	27.706.28
9	13	27.706.29



Ventil-Sprechkanülen, Innenrohr mit Schiebeventil, Normalradius N,
in Silber und Neusilber verfügbar

Valve speaking tube, inner tube with sliding valve, regular radius N,
available in silver and German Silver

Fig.	Ø mm	Silber Silver	Neusilber German Silver
4	8	27.708.04	27.708.24
5	9	27.708.05	27.708.25
6	10	27.708.06	27.708.26
7	11	27.708.07	27.708.27
8	12	27.708.08	27.708.28
9	13	27.708.09	27.708.29

Andere Modelle auf Anfrage
Other patterns on request

Tracheotomie
Tracheotomy

Tracheotomiebesteck
Tracheotomy set

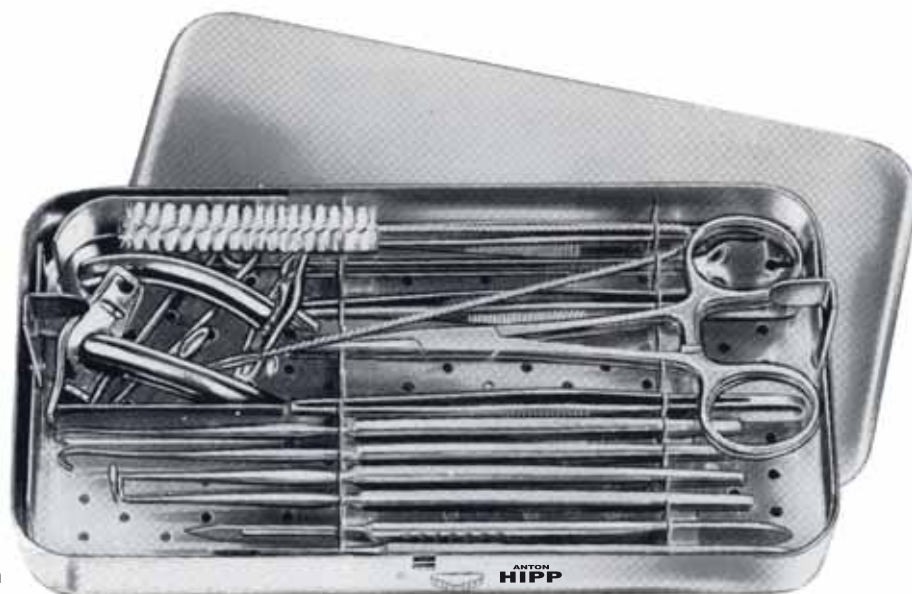

200 x 105 x 30 mm

27.710.00

Tracheotomiebesteck komplett im Metalletui,
bestehend aus:

- 1 Griff und 1 Klinge Fig. 20
- 1 Griff und 1 Klinge Fig. 23
- 2 Pean-Klemmen, 13 cm
- 1 anatomische Pinzette, 13 cm
- 2 chirurgische Pinzetten, 13 cm, 1 x 2 Zähne
- 1 Hohlsonde, 13 cm
- 2 Trachealhäkchen Iterson, stumpf
- 1 Trachealdilatator
- 1 Trachealhäkchen Bose, scharf, links
- 1 Trachealhäkchen Bose, scharf, rechts
- 1 Trachealkanüle Luer, Fig. 3, Ø 7 mm, Neusilber
- 1 Trachealkanüle Luer, Fig. 4, Ø 8 mm, Neusilber
- 1 Reinigungsbürste, 27 cm, Ø 12 mm

Tracheotomy Set in metal case,
consisting of

- 1 Handle with 1 blade Fig. 20
- 1 Handle with 1 blade Fig. 23
- 2 Pean artery forceps, 13 cm
- 1 Thump Forceps, 13 cm
- 2 Tissue Forceps, 13 cm, 1 x 2 teeth
- 1 Grooved Director, 13 cm
- 2 Iterson Tracheal Retractors, blunt
- 1 Trachea Dilator
- 1 Bose Tracheal Hook, sharp, left
- 1 Bose Tracheal Hook, sharp, right
- 1 Luer Trachea tube, Fig. 3, Ø 7 mm, German Silver
- 1 Luer Trachea tube, Fig. 4, Ø 8 mm, German Silver
- 1 Cleaning brush, 27 cm, Ø 12 mm

Laryngo- Broncho- Oesphagoskopie

Laryngo- Broncho- Esophagoscopy

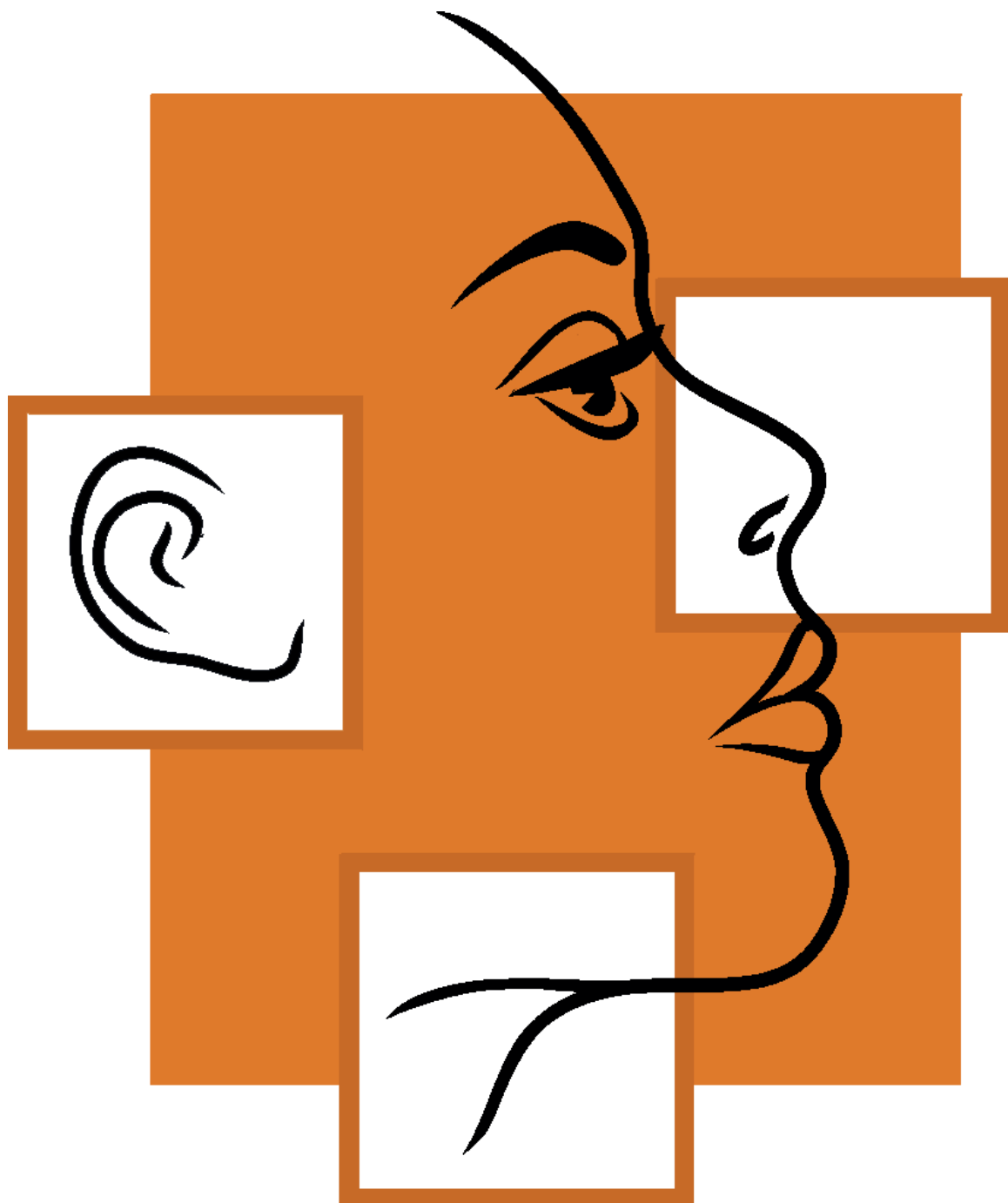

Laryngo- Broncho- Oesophagoskopie
Laryngo- Broncho- Esophagoscopy

Laryngoskope und Zubehör
Laryngoscopes and Accessories

Laryngoskophalter und Bruststütze für Jackson und Holinger Laryngoskope
Laryngoscope holder and chest support for Jackson and Holinger Laryngoscopes

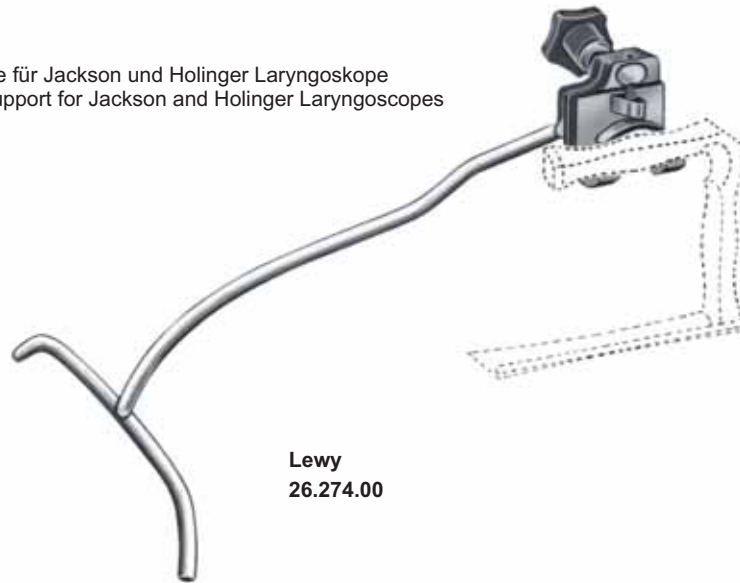

Lewy
26.274.00

Laryngoskophalter und Bruststütze für Kleinsasser-Laryngoskope
Laryngoscope holder and chest support for Kleinsasser-Laryngoscopes



L = 340 mm
für Erwachsene
for adults
26.280.00

L = 240 mm
für Kinder
for children
26.281.00

Laryngo- Broncho- Oesophagoskopie Laryngo- Broncho- Esohagocopy

Laryngoskope und Zubehör
Laryngoscopes and Accessories

Kleinsasser Kaltlicht-Operations-Laryngoskope
Kleinsasser F.O. operation laryngoscopes

komplett complete	L = mm	Kaltlichtträger allein F.O. light carrier only
----------------------	--------	---

26.282.01	135	26.283.01
-----------	-----	-----------



Fig. 1

26.282.02	152	26.283.02
-----------	-----	-----------



Fig. 5

26.282.03	182	26.283.03
-----------	-----	-----------



Fig. 3

26.282.04	172	26.283.04
-----------	-----	-----------



Fig. 4

26.282.05	172	26.283.05
-----------	-----	-----------



Fig. 5

26.282.06	182	26.283.06
-----------	-----	-----------



Fig. 6

26.282.07	222	26.283.07
-----------	-----	-----------



Fig. 7



← L →



Injektionskanüle für Kleinsasser-Laryngoskope Fig. 1-7
Injection drain cannula for Kleinsasser-Laryngoscope Fig. 1-7
26.284.00



Rauchabsaugrohr für Kleinsasser-Laryngoskope Fig. 3-7
Suction tube for Kleinsasser-Laryngoscope Fig. 1-7
26.285.00

Laryngo- Broncho- Oesophagoskopie Laryngo- Broncho- Esohagocopy

Laryngoskope und Zubehör
Laryngoscopes and Accessories



Für die vordere Kommissur
For anterior commissure



Jackson
KL



Holinger
KL











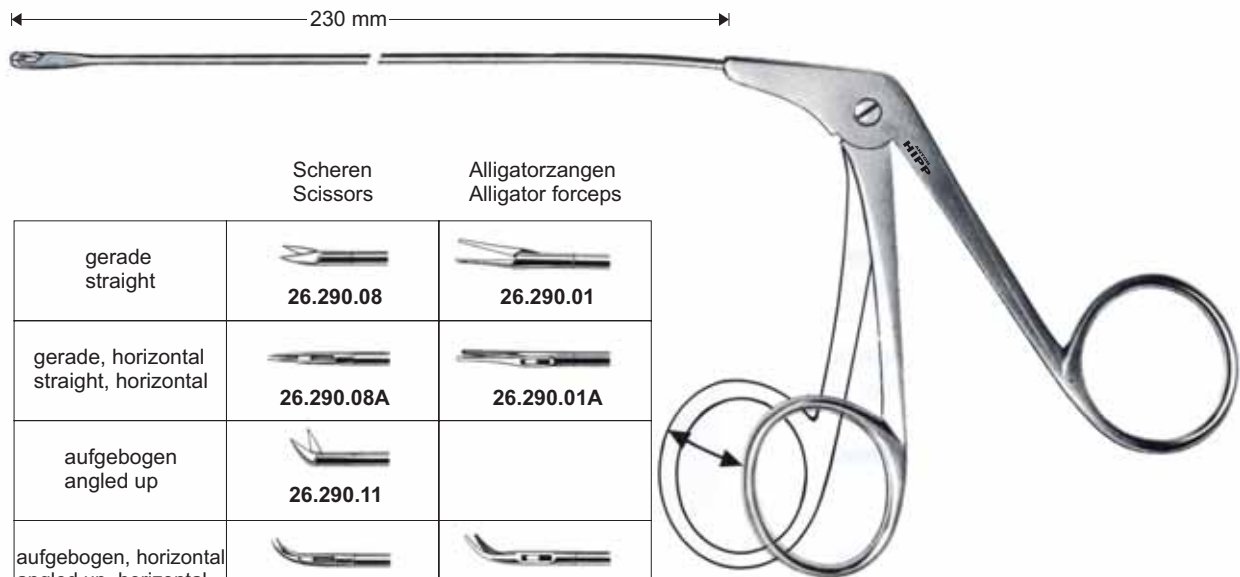



komplett complete	L	Kaltlicht-Träger allein F.O. light carrier only
26.274.20	120 mm	26.274.92
26.274.70	170 mm	26.274.97
26.274.80	180 mm	26.274.98

komplett complete	L	Kaltlicht-Träger allein F.O. light carrier only
26.275.70	170 mm	26.275.97
26.275.80	180 mm	26.275.98





Laryngo- Broncho- Oesophagoskopie Laryngo- Broncho- Esophagoscopy

Instrumente zur endolaryngealen Mikrochirurgie
Instruments for endo-laryngeal Micro surgery



	Scheren Scissors	Alligatorzangen Alligator forceps
gerade straight	 26.290.08	 26.290.01
gerade, horizontal straight, horizontal	 26.290.08A	 26.290.01A
aufgebogen angled up	 26.290.11	
aufgebogen, horizontal angled up, horizontal	 26.290.11A	 26.290.01B
nach links gebogen curved to the left	 26.290.09	 26.290.02
nach rechts gebogen curved to the right	 26.290.10	 26.290.03

Löffelzängchen, Ø 2,5 mm
Delicate cup-shaped forceps, Ø 2,5 mm

gerade straight	 26.290.04
aufgebogen angled up	 26.290.07
aufgebogen, horizontal angled up, horizontal	 26.290.07A
nach links gebogen curved to the left	 26.290.05
nach rechts gebogen curved to the right	 26.290.06



Laryngo- Broncho- Oesophagoskopie Laryngo- Broncho- Esophagoscopy

Rohrschaftzangen für Laryngoskopie
Forceps with tubular shafts for Laryngoscopy

← 350 mm →



Schaftdurchmesser: 1,5 mm
Diameter of tube: 1.5 mm

		1 = 26.291.01
	2 mm	2 = 26.291.02
	3 mm	1 = 26.291.03 2 = 26.291.05
		1 = 26.291.06 2 = 26.291.07
		1 = 26.291.08 2 = 26.291.09
		1 = 26.291.10 2 = 26.291.11
	oval 2 mm	1 = 26.291.12
	3x5 mm	1 = 26.291.13 2 = 26.291.14
	3 mm	1 = 26.291.15
	3 mm	1 = 26.291.16
	3 mm	1 = 26.291.17
	3 mm	1 = 26.291.18

1 = ein Maulteil beweglich
1 = one jaw movable

2 = beide Maulteile beweglich
2 = both jaws movable













Laryngo- Broncho- Oesophagoskopie Laryngo- Broncho- Esophagoscopy

Rohrschaftzangen für Laryngo-Broncho-Oesophagoskopie
Forceps with tubular shafts for Laryngo-Broncho-Esophagoscopy

← L →



40 - 60 cm:
Schaftdurchmesser: 2,5 mm
Diameter of tube: 2.5 mm

	L = 40 cm	L = 50 cm	L = 60 cm
	1 = 26.292.01 2 = 26.292.02	26.292.51 26.292.52	26.292.81 26.292.82
 4 mm	1 = 26.292.03 2 = 26.292.04	26.292.53 26.292.54	26.292.83 26.292.84
	1 = 26.292.05 2 = 26.292.06	26.292.55 26.292.56	26.292.85 26.292.86
	1 = 26.292.07 2 = 26.292.08	26.292.57 26.292.58	26.292.87 26.292.88
	1 = 26.292.09 2 = 26.292.10	26.292.59 26.292.60	26.292.89 26.292.90
 3x6 mm	1 = 26.292.11	26.292.61	26.292.91
 4x6 mm	1 = 26.292.12	26.292.62	26.292.92
 4x8 mm	1 = 26.292.13	26.292.63	26.292.93
 4 mm	1 = 26.292.14	26.292.64	26.292.94
 4 mm	1 = 26.292.15	26.292.65	26.292.95
 4 mm	1 = 26.292.16	26.292.66	26.292.96
 4 mm	1 = 26.292.17	26.292.67	26.292.97
 4 mm	1 = 26.292.18	26.292.68	26.292.98

1 = ein Maulteil beweglich
1 = one jaw movable

2 = beide Maulteile beweglich
2 = both jaws movable

Laryngo- Broncho- Oesophagoskopie
Laryngo- Broncho- Esophagscopy

Laryngofissurschere
Laryngectomy scissor

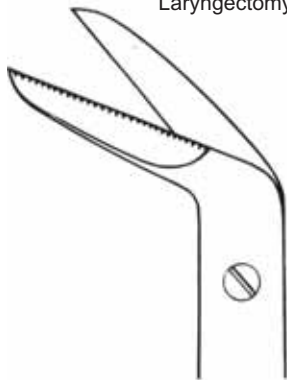

1 Schneide gezahnt
1 Blade toothed



Killian
21 cm
26.843.21

Kehldeckelhalter
Epiglottis retractor



Reichert
24 cm
26.241.23

Rhinoskopie Spiegel
Rhinoscopic mirrors



Michel
25 cm



Ø 12 mm
26.230.12



Ø 14 mm
26.230.14



Ø 16 mm
26.230.16



Ø 18 mm
26.230.18

**Elektro- Chirurgie
Bipolare Koagulation**

**Electro Surgery
Bipolar Coagulation**

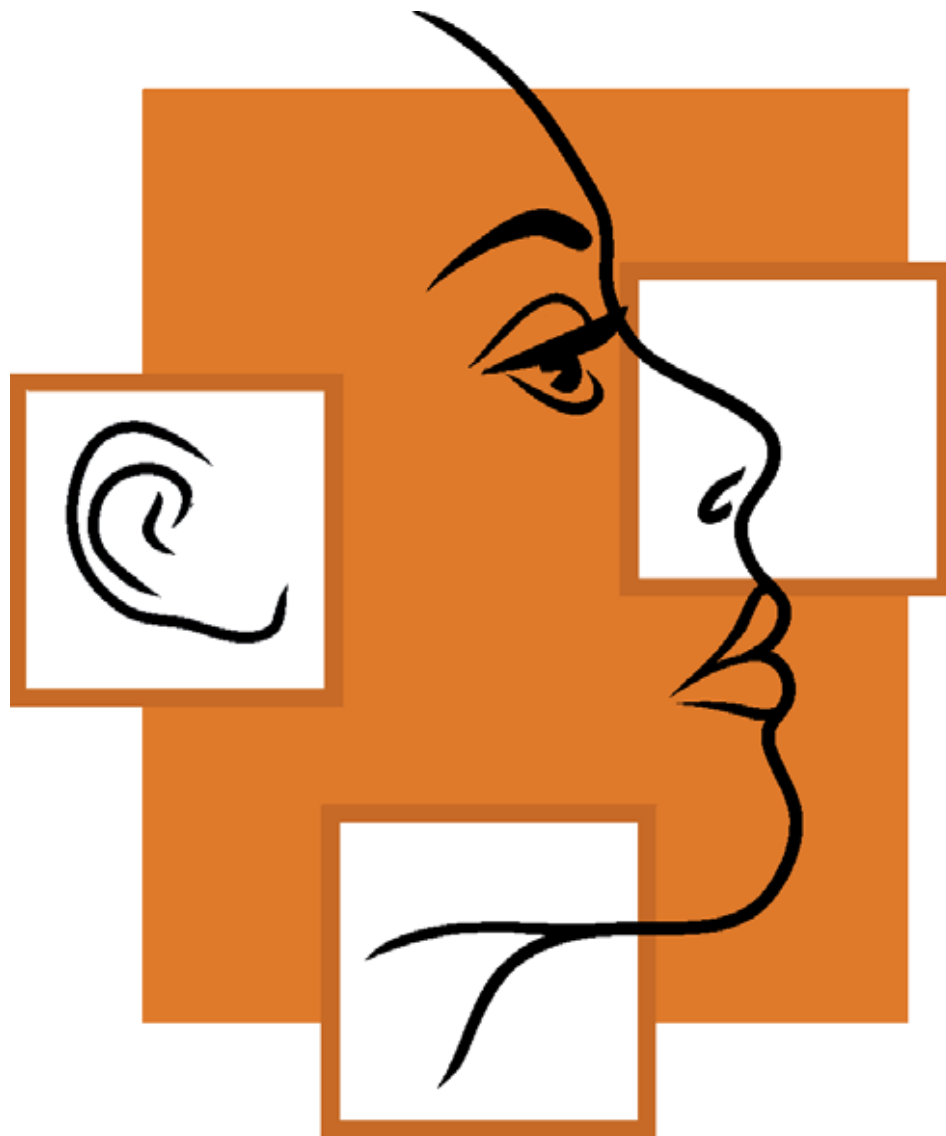

IN UNSEREM EXTRA KATALOG

IN OUR SPECIAL CATALOG

Kaltlichtkabel

Fibreoptic Illumination

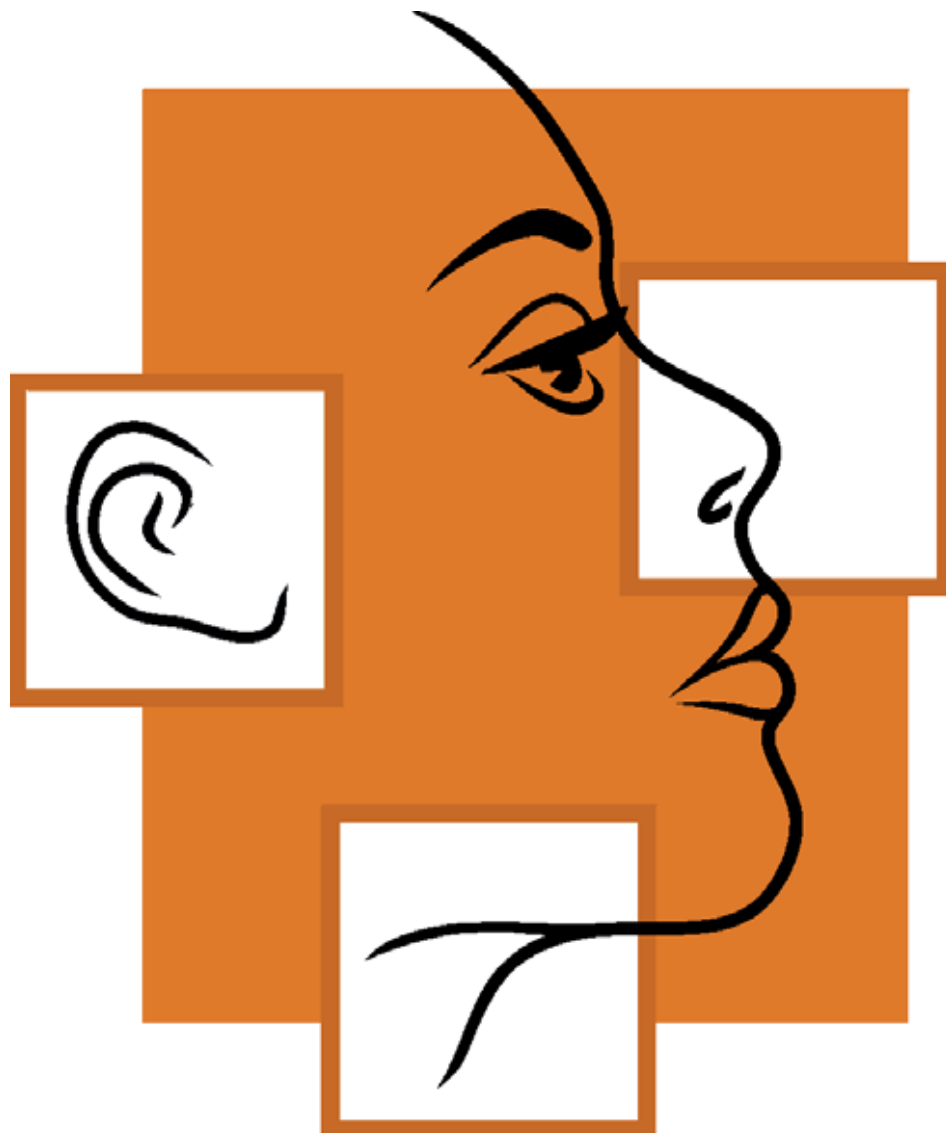

Kaltlicht- Ausrüstung Fiberoptic Illumination

Glasfaser-Lichtleitkabel (Kaltlichtkabel) mit Silikon-Kautschuk-Ummantelung. Sterilisierbar, wasserdicht, weitgehend beständig gegen Chemikalien und Lösungsmittel, zugentlastet und sehr flexibel, temperaturbeständig von ca. -60°C bis über +180°C.

Anschlüsse System Karl Storz, alle anderen Kombinationen lieferbar.

Fibre-light conductors (cold light cables) with silicon rubber protection sheath. Sterilizable, waterproof, widely resistant against chemicals and solvents, very flexible, heat resistant from -60°C up to +180°C. Adaptors system Karl Storz. Any other adaptor combination available on request.



Länge des Kaltlichtkabels Legth of the cold light cable	Ø des Glasfaser-Bündels Ø of the fibre bundle	
	3,5 mm	4,9 mm
1800 mm	59.035.18	59.049.18
2300 mm	59.035.23	59.049.23
3000 mm	59.035.30	59.049.30



Länge des Kaltlichtkabels Legth of the cold light cable	Ø des Glasfaser-Bündels Ø of the fibre bundle		
	2,8 mm	4,2 mm	4,5 mm
1800 mm	59.050.18	59.051.18	59.052.18
2300 mm	59.050.23	59.051.23	59.052.23
3000 mm	59.050.30	59.051.30	59.052.30

Inhaltsverzeichnis

Table of contents

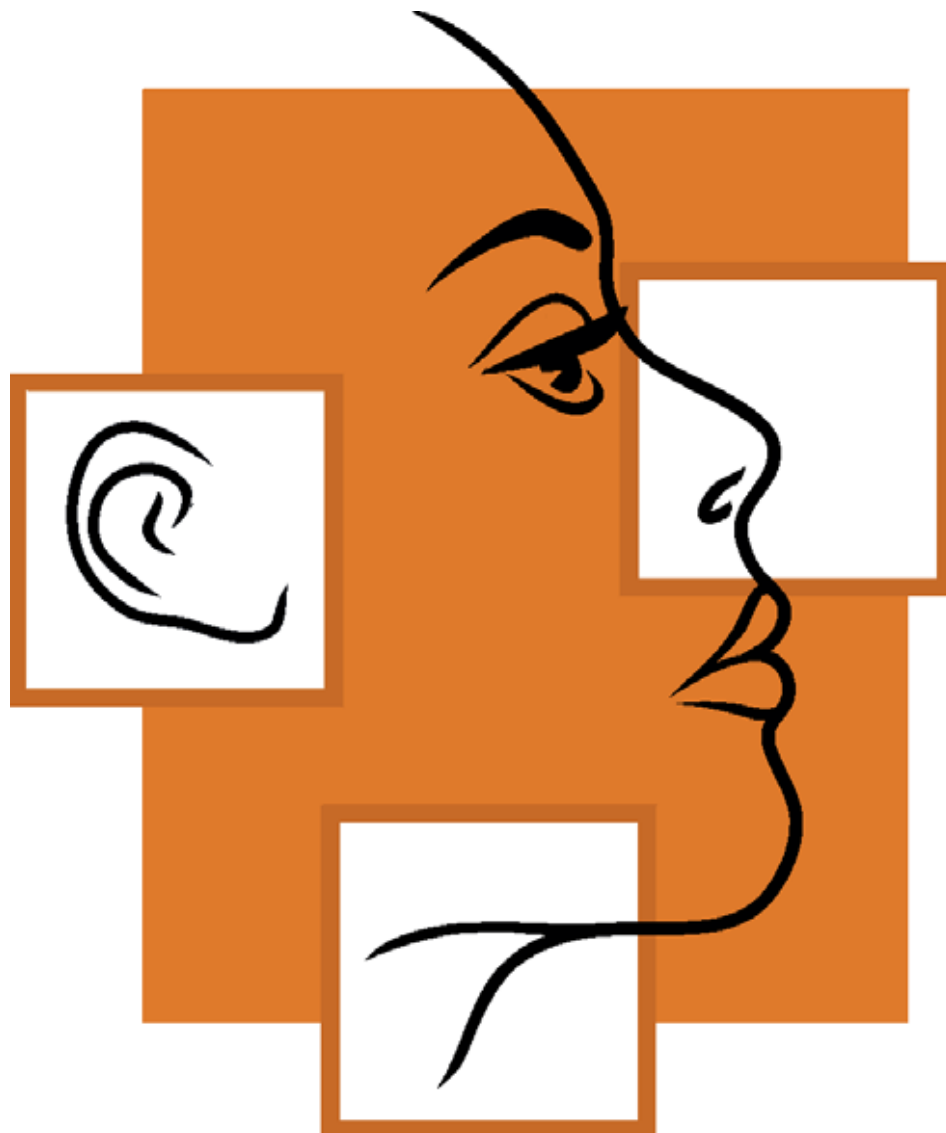

Inhaltsverzeichnis

A

Abraham	
Tonsillennmesser	124
Adson	
Raspatorien	101
Adson-Brown	
Gewebe- und Knorpelfasspinzetten	93
Aebli	
Feine Scheren	78
Agnew	
Ohrmesser und Nadeln	15
Alderdyce	
Dissektoren	125
Alligatorzangen	30, 33, 154
Allis-Coakley	
Tonsillenfasszangen	129
Allis-Coakley (Clover)	
Tonsillenfasszangen	129
Allport	
Ohrhäkchen	16
Aly	
Sensibilitätsinstrument	115
Antrumstanzen	57
Asch	
Septumrichtzange	55
Aston	
Face-Lift Scheren	88
Aufricht	
Nasenflügelhaken	95
Raspeln	108
Austin (Plester)	
Sichelmesser	36

B

Baby Lexer	
Präparierscheren	75
Ballenger	
Meißel	97
Nasenoperationsmesser	66
Septummesser	67
Tonsillenfasszangen	129
Ballenger-Hajak	
Elevatorien	105
Barabara	
Micro Nadeln	39-40
Baron	
Sauginstrumente	6
Bayer	
Ohrmesser	15
Beckmann	
Nasenspekulas	51
Beckmann-Barnhil	
Ringmesser	110
Beebee	
Drahtscheren	113
Bellucci	
Mikro Scheren	28
Beuse	
Face-Lift Scheren	88
Beyer	
Attikusstanzen	35
Blohmke	
Tonsillenfasszangen	129
Böhler	
Knochensplitterzangen	55

Boies

Elevatorien 104

Bonn

Feine Scheren 83

Bose

Trachealhäkchen 143

Böttcher

Tonsillenschere 70, 128

Bruenings

Septummesser 67

Zungenspatel 118

Tonsillennmesser 124

Tonsillenschnürer 130

Buchwald

Zungenspatel 118

Buck

Ligaturscheren 87

Fremdkörperhebel 21

Ohrküretten 12

Ohrmesser 14

Buck-Wullstein

Micro Ohrküretten 27

C

Canfield

Tonsillennmesser 124

Caplan

Nasenschere 68, 69

Carpenter

Dissektoren 125

Carroll

Meißel 96

Carter

Elevatorien 102

Castanares

Face-Lift Scheren 91

Castroviejo

Mess- und Markierungszirkel 115

Chevalier-Jackson

Trachealkanülen 146

Church

Gefäßschere 77

Cinelli

Meißel 96

Citelli

Knochenstanzen 35

Claus-Eicken

Tonsillennadeln 132

Clover

Tonsillenfasszangen 129

Coakley

Periostome 98

Collin

Dynamometer 115

Zungenzangen 121

Converse

Feine Scheren 80

Nasenoperationsmesser 65

Converse-Wilmer

Feine Scheren 80

Corwin

Tonsillenkompessorium 136

Cottle

Tonsillen- und Nasenschere 73

Gewebe- und Knorpelfasspinzetten 73

Columella-Klemmen 93

Inhaltsverzeichnis

Wundhaken	94	Meißel	97
Nasenflügelhaken	95	Raspatorien	99
Meißel	96-97	Raspeln	107
Elevatorien	102-103, 105	Tonsillen- und Nasenscheren	72
Raspeln	108	Nasennoperationsmesser	65
Applikatoren	109	Frazier	
Knorpelquetsche	109	Saugkanülen	5
Hammer	109	Freeman	
Pinzetten	109	Face-Lift Scheren	91
Nasennoperationsmesser	65-66	Freer	
Nasenspekula	52	Nasennoperationsmesser	66
Cottle-Kazanjan		Septummesser	67
Knochensplitterzangen	55	Wundhaken	94
Cottle-Neivert		Meißel	98
Nasenflügelhaken	95	Elevatorien	100
Cottle-Walsham		French	
Richtzangen		Stimmgabeln	3
Craig		Frenzel	
Septumzangen	54	Zungenspatel	118
Craig-Domnick			
Septumzangen	54	G	
Cushing		Gefäßscheren	79
Nasenzangen	64	Gerzog	
		Ohrmesser	14
D		Gestell zum Sterilisieren	46
Davis		Gillies	
Face-Lift Scheren	90	Elevatorien	104
Day		Goldmann	
Tonsillennmesser	124	Elevatorien	104
Ohrhäkchen	16	Goldmann-Fox	
Dean		Face-Lift Scheren	91
Tonsillen- und Nasenscheren	71, 128	Good	
Tonsillennmesser	124	Tonsillen- und Nasenscheren	71
Dingman		Gorney	
Elevatorien	104	Face-Lift Scheren	89
Diszisionsmesser	36	Gorney Turbinate	
Drahtbiegezange	112,135	Nasenscheren	69
Drahtschlingen	135	Gorney-Freeman	
Doyen-Jansen (Molt)		Face-Lift Scheren	89
Mundsperrer	119	Gorney-Platysma	
		Face-Lift Scheren	89
E		Gorney-Smas-Platysma	
Elevatorien	103	Face-Lift Scheren	88
Eicken-Killian		Graefe	
Saugrohre	114	Feine Scheren	80
Eiselsberg		Gewebe- und Knorpelfasspinzetten	93
Ligaturscheren	86	Greenberg-Par	
Eves		Blepharoplastic Scheren	92
Tonsillenschnürer	130		
		H	
F		Hajek-Kofler	
Faulkner		Stanzen	59
Meißel	98	Häkchen	39-40
Periostome	98	Harrison	
Ferris-Smith		Trommelfellmesser	36
Nasenzangen	63	Hartmann	
Ferris-Smith-Kerrison		Ohrpolypenzangen	21-22,53
Nasenzangen	58,60-61	Zungenspatel	119
Fisch		Tonsillenzangen	136
Crurotomie Zange	31	Adenoidstanzen	137
Zangen	29	Conchotome	56
Fisher		Fasszangen	22
Tonsillennmesser	124	Nasenspekula	51
Fomon		Ohrkatheter	5
Nasenflügelhaken	95	Ohrspekula	10
		Stimmgabeln	3-4

Inhaltsverzeichnis

Hartmann/Wiener		Jansen-Middleton	
Nasenspekula	49	Septumzangen	57
Hartmann-Halle		Jatho	
Nasenspekula	51	Nasenrachenzange	137
Hartmann-Hoffmann		Jennings	
Löffelzangen	22	Mundsperrer	120
Hartmann-Noyes		Joseph	
Ohrpolypenzangen	22	Präparierscheren	74
Hartmann-Wullstein		Wundhaken	94
Fasszangen	22	Raspatorien	99
Löffelzangen	22	Raspeln	108
Harvey		Nasensägen	111
Drahtscheren	113	Nasenoperationsmesser	65
Haslinger		Joseph-Masing	
Gaumensegelhalter	127	Elevatorien	103
Heath			
Ligaturscheren	87	K	
Heermann		Kabierske	
Flachmeißel	42	Pulverbläser	9
Hammer	42	Kahn-Beuse	
Hohlmeißel	42	Tonsillen- und Nasenscheren	71
Henke		Kaltlichtkabel	162
Dissektoren	126	Kaye	
Heymann		Face-Lift Scheren	90
Tonsillen- und Nasenscheren	73	Blepharoplastic Scheren	92
Hinderer		Kaye-Freeman	
Gewebe- und Knorpelfasspinzetten	93	Face-Lift Scheren	90
Holinger		Kehlkopfspiegel	141
Laryngoskope	153	Kelly	
Holmgren		Präparierscheren	74
Ohrspekula	27	Kerrison	
Hough		Stanzen	35, 58
Raspatorien	37	Killian	
Exkavatoren	37	Meißel	97
Tiefenmeßsonden	38	Elevatorien	102, 105
House		Laryngofissurschere	157
Elevatorien	37	Nasenscheren	68
Lanzenmesser	36	Nasenspekula	50
Meßsonden	38	Septumzangen	53
Mikro Ohrküretten	41	Kistner	
Mikro Ohrlöffel	41	Kugelstopfer	38
House-Dieter		Kleinsasser	
Hammerkopffzangen	31	Laryngoskope	152
House-Luer		Injektionskanülen	152
Spül- und Absauginstrumente	7	Rauchabsaugrohre	152
Howarth		Knight	
Elevatorien	103	Tonsillen- und Nasenscheren	73
Hurd		König	
Dissektoren	125	Stimmgabeln	4
Tonsillennadeln	132	Raspatorien	101
Hylin		Krause	
Raspatorien	101	Polypenschnürer	23, 112
		Krause-Voss	
		Polypenschnürer	23, 112
I		L	
Iris		La Force	
Feine Scheren	81-84	Tonsillotome	133-134
J		La Grange	
Jackson		Feine Scheren	78
Tonsillen- und Nasenscheren	73	Laborde	
Trachealhäkchen	143	Trachealdilatatoren	144
Laryngoskope	153	Lange	
Jansen		Nasenflügelhaken	95
Nasenpinzetten	93	Langenbeck	
Ohrpinzetten	20	Elevatorien	105
Wundspreizer	17		

Inhaltsverzeichnis

Lange-Wilde			
Polypenschnürer	23		
Lange-Wilde (Bruenings)			
Polypenschnürer	112		
Laryngoskophalter	151		
Lewy			
Laryngoskophalter	151		
Lincoln			
Gefäßscheren	77		
Littauer			
Ligaturschere	87		
Littler			
Ligaturschere	86		
Locklin			
Präparierschere	76		
Gefäßschere	77		
Löffelzängchen	32-33, 154		
Love			
Retraktoren	127		
Love-Gruenwald			
Scharfe Nasenzangen	64		
Luc			
Septumzangen	54		
Lucae			
Ohrhäkchen	16		
Ohrmesser	15		
Ohrpinzetten	20		
Stimmgabeln	3		
Luer			
Saugrohre	114		
Trachealkanülen	145		
Luniatschek			
Tonsillentamponstopfer	127		
M			
Magnet-Racks	45		
Magill			
Saugrohre	114		
Maltz			
Raspeln	106, 108		
Nasenoperationsmesser	66		
Masing			
Columella-Klemmen	93		
Elevatorien	103		
Nasenoperationsmesser	66		
Mauder			
Mundkeile	118		
Mayo			
Zungenspatel	118		
McGuire			
Feine Scheren	78		
McIndoe			
Tonsillen- und Nasenschere	70		
Knochensplitterzangen	55		
McGee			
Zangen	29		
Fußplattenhäkchen	40		
McKenty			
Raspatorien	101		
Elevatorien	102		
Meltzer			
Adenoidstanzen	137		
Metzenbaum			
Tonsillenschere	128		
Michel			
Rhinoskopie Spiegel	157		
Mikulicz			
Tonsillenfasszangen	129		
Miller			
Raspeln	106		
Mini Container	45		
Moldenhauer			
Ohrhebel	16		
Möltgen			
Winkelmesser	115		
Moritz-Schmidt			
Zungenspatel	119		
Muck			
Ohrmesser	14		
Mundsperrer	120		
Mundwinkelhalter	121		
N			
Nager			
Gaumensegelhäkchen	127		
Tonsillennadeln	132		
Nasenschere	68		
Negus			
Tonsillenklemmen	128		
Neivert			
Nasenflügelhaken	95		
Neurotone-5			
Stimmgabel	4		
News			
Trachealhäkchen	143		
Northbent			
Ligaturschere	86		
O			
Ohrzängchen	32, 34		
Olivecrona			
Nasenschere	68		
P			
Palmer			
Nasenspekula	49		
Par			
Blepharoplastische Schere	92		
Peck Joseph			
Präparierschere	76		
Pennington			
Elevatorien	102		
Perkins			
Wundspreizer	18-19		
Pierce			
Elevatorien	102		
Plester			
Einführungsgabeln	38		
Atrum-Häkchen	39		
Lappenmesser	36		
Saugkanülen	6		
Politzer			
Luftdusche	8		
Ohrmesser	14-15		
Ohrspekula	10		
Potts Smith			
Tonsillen- und Nasenschere	71		
Prince			
Tonsillen- und Nasenschere	70		
Tonsillenschere	128		

Inhaltsverzeichnis

Q

Quervain	
Elevatoren	105
Quire	
Fremdkörperheber	21

R

Raspatorien	101
Raspeln	108
Rees	
Face-Lift Scheren	88
Reichert	
Kelchdeckelhalter	157
Reynolds	
Präparierscheren	74
Ribbon Iris	
Feine Scheren	85
Ribbon Kaye	
Blepharoplastic Scheren	92
Ribbon Stevens	
Feine Scheren	85
Ribbon Strabismus	
Feine Scheren	85
Richnau-Holmgren	
Ohrspekula	27
Ritter-Halle	
Dilatatoren	114
Roeder	
Roederbinder	135
Rohrschaftzangen	155-156
Rosen	
Elevatoren	37
Inzisionsmesser	36
Nadeln	39-40
Rundschnittmesser	36
Spülkanülen	6
Rotations-Racks	45
Rydel-Seiffer	
Stimmgabeln	4

S

Sanvenero	
Präparierscheren	74
Saugrohre	138
Scheren	154
Schimmelbusch	
Ohrspritze und Zubehör	8
Schmeden	
Tonsillenzangen	136
Nasenzangen	56
Schnidt	
Tonsillenklemmen	128
Schnürdrähte	112, 135
Schoenborn	
Trachealhäkchen	143
Schömacker-Loth	
Ligaturscheren	86
Schuhknecht	
Zangen	29
Biegegerät	42
Rollmesser	36
Sealy	
Feine Scheren	80
Sebileau	
Elevatoren	105

Seemann-Seiffert

Mundsperrerr 120

Seiler

Nasenscheren 69

Senn-Miller

Trachealhäkchen 143

Septumzangen

54

Sewall

Raspatorien 101

Sexton

Ohrmesser 14

Shambaugh

Häkchen 39

Shea

Blepharoplastic Scheren 92

Ohrlöffel 27

Sheehan

Meißel 97

Shortbent

Ligaturscheren 86

Siebenmann

Saugrohre 114

Silver

Meißel 96

Sluder-Ballenger

Tonsillotome 131

Smith

Drahtschere 113

Spencer

Ligaturscheren 86

Spurling

Nasenzangen 64

St. Clair-Thompson

Ringmesser 110

Stammlinger

Nasenzangen 57

Stahl-Meßstäbe

115

Sternberg

Lippenhalter 121

Stevens

Feine Scheren 79

Stimmgabel

4

Strabismus

Präparierscheren 75

Strümpfle

Löffelzangen 22

Struycken

Rongeur 56

T

Tabb

Crurotomie Zangen 31

Sichelmesser 36

Takahashi

Rongeur 56

Thilenius

Tonsillenzangen 136

Thudichum (Goldsmith)

Nasenspekula 49

Tieck-Halle

Nasenspekula 50

Tilley

Septumzangen 53

Ohr Tampon Zangen 21

Tobold

Zungenspatel 119

Inhaltsverzeichnis

Toynbee		Ohrhäkchen	16
Nasenspekula	10	Young	
Trachealhäkchen	142-143	Zungenzangen	121
Trachealkanülen	146		
Tracheotomiebesteck	147	Z	
Trautman		Zaufal	
Ohrmesser	15	Ohrhebel	16
Troeltsch (Wilde)		Zöllner	
Ohrpinzetten	20	Elevatorien	37
Trousseau		Führungsgabeln	44
Trachealdilatatoren	144	Fußplattenhäkchen	43
Tyding		Häkchen	43
Tonsillennmesser	124	Kanülen	6
Tonsillenschnürer	130	Nadeln	43-44
		Raspatorien	44
U		Rundschnittmesser	44
Uckermann		Saugrohre	6
Trachealtrokare	144	Sichelmesser	44
Universal		Zungenspatel	118
Drahtscheren	23, 112-113, 135		
Handgebläse	10		
Pulverbläser	9-10		
V			
Voltolini			
Nasenspekula	49		
W			
Wagener			
Ohrhäkchen	16		
Wagner			
Feine Scheren	82-83		
Walsham			
Richtzangen	55		
Walter			
Meißel	98		
Wartenberg			
Sensibilitätsinstrument	115		
Watson-Williams			
Rongeur	54		
Weil-Blakesley			
Nasenzangen	56		
Weingärtner			
Ohrpolypenzangen	22		
Westmacott			
Septumzangen	53		
White			
Tonsillenfasszangen	129		
Whitehead			
Mundsperrer	120		
Wieder			
Zungenspatel	119		
Williger			
Raspatorien	99		
Wullstein			
Elevatorien	37		
Kanülen	7		
Wundspreizer	18		
Y			
Yankauer			
Nadeln	114		
Dissektoren	126		
Saugrohre	138		

Table of contents

A

Abraham
Tonsil knives 124

Adson
Raspatories 101

Adson-Brown
Tissue and cartilage forceps 93

Aebli
Fine scissors 78

Agnew
Ear knives and needles 15

Alderdyce
Dissectors 125

Alligator forceps 30, 33, 154

Allis-Coakley
Tonsil seizing forceps 129

Allis-Coakley (Clover)
Tonsil seizing forceps 129

Allport
Ear hooks 16

Aly
Sensibility instrument 115

Antrum Punch 57

Asch
Septum straightening forceps 55

Aston
Face lift scissors 88

Aufricht
Hooks for posterior nares 95
Rasps 108

Austin (Plester)
Sickle knives 36

B

Baby Lexer
Dissecting scissors 75

Ballenger
Chisel 97
Rhinoplastic knives 66
Septum knives 67
Tonsil seizing forceps 129

Ballenger-Hajek
Elevators 105

Barabara
Micro needles 39-40

Baron
Aspirating instruments 6

Bayer
Ear knives 15

Beckmann
Nasal speculas 51

Beckmann-Barnhil
Adenoid curettes 110

Beebee
Wire cutting scissors 113

Bellucci
Micro scissors 28

Beuse
Face lift scissors 88

Beyer
Atticus punches 35

Blohmke
Tonsil seizing forceps 129

Böhler
Bone cutting forceps 55

Boies

Elevators 104

Bonn

Fine scissors 83

Bose

Trachea retractors 143

Böttcher

Tonsil scissors 70, 128

Bruenings

Septum knives 67

Tongue spatulas 118

Tonsil knives 124

Tonsil snares 130

Buchwald

Tongue spatulas 118

Buck

Suture scissors 87

Foreign body levers 21

Ear curettes 12

Ear knives 14

Buck-Wullstein

Micro ear cuettes 27

C

Canfield

Tonsil knives 124

Caplan

Nasal scissors 68, 69

Carpenter

Dissectors 125

Carroll

Chisels 96

Carter

Elevators 102

Castanares

Face lift scissors 91

Castroviejo

Scaleral marker and caliper 115

Cheek retractors

121

Chevalier-Jackson

Trachea tubes 146

Church

Vascular scissors 77

Cinelli

Chisels 96

Citelli

Mastoid punches 35

Claus-Eicken

Tonsil needles 132

Clover

Tonsil seizing forceps 129

Coakley

Periosteotomes 98

Cold light cable

162

Collin

Dynamometers 115

Tongue holding forceps 121

Converse

Fine scissors 80

Rhinoplastic knives 65

Converse-Wilmer

Fine scissors 80

Corwin

Tonsil hemostat 136

Cottle

Tonsil scissors and nasal scissors 73

Table of contents

Tissue and cartilage forceps	73	Fomon	
Columella forceps	93	Hooks for posterior nares	95
Retractors	94	Chisels	97
Hooks for posterior nares	95	Raspatories	99
Chisel	96-97	Rasps	107
Elevators	102-103, 105	Tonsil scissors and nasal scissors	72
Rasps	108	Rhinoplastic Knives	65
Applicators	109	Forceps with tubular shafts	155-156
Cartilage crusher	109	Frazier	
hammer	109	Suction tubes	5
Forceps	109	Freeman	
Rhinoplastic knives	65-66	Face lift scissors	91
Nasal specula	52	Freer	
Cottle-Kazanjian		Rhinoplastic knives	66
Bone cutting forceps	55	Septum knives	67
Cottle-Neivert		Retractors	94
Hooks for posterior nares	95	Chisels	98
Cottle-Walsham		Elevators	100
Straightening forceps		French	
Craig		Tuning forks	3
Septum compression forceps	54	Frenzel	
Craig-Domnick		Tongue spatulas	118
Septum compression forceps	54		
Cup-shaped forceps	32-33, 154	G	
Cushing		Gerzog	
Nasal cutting forceps	64	Ear knives	14
		Gillies	
D		Elevators	104
Davis		Goldmann	
Face lift scissors	90	Elevators	104
Day		Goldmann-Fox	
Tonsil knives	124	Face lift scissors	91
Ear hooks	16	Good	
Dean		Tonsil scissors and nasal scissors	71
Tonsil scissors and nasal scissors	71, 128	Gorney	
Tonsil knives	124	Face lift scissors	89
Dingman		Gorney Turbinate	
Elevators	104	Nasal scissors	69
Discision Knives	36	Gorney-Freeman	
Doyen-Jansen (Molt)		Face lift scissors	89
Mouth gags	119	Gorney-Platysma	
		Face lift scissors	89
E		Gorney-Smas-Platysma	
Ear forceps	32, 34	Face lift scissors	88
Eicken-Killian		Graefe	
Suction tubes	114	Fine scissors	80
Eiselsberg		Tissue and cartilage forceps	93
Suture scissors	86	Greenberg-Par	
Elevators	103	Blepharoplasty scissors	92
Eves			
Tonsil snares	130	H	
		Hajek-Kofler	
F		Punches	59
Faulkner		Harrison	
Chisels	98	Tympanon knives	36
Periosteotomes	98	Hartmann	
Ferris-Smith		Ear polypus forceps	21-22, 53
Nasal cutting forceps	63	Tongue spatulas	119
Ferris-Smith-Kerrison		Tonsil punch forceps	136
Nasal cutting forceps	58, 60-61	Adenoid punches	137
Fisch		Conchotoms	56
Crura nippers	31	Fasszange	22
Forceps	29	Nasal speculas	51
Fisher		Eustachian catheters	5
Tonsil knives	124	Ear specula	10
		Tuning forks	3-4

Table of contents

Hartmann/Wiener		Retractors	17
Nasal speculas	49	Jansen-Middleton	
Hartmann-Halle		Septum Cutting Forceps	57
Nasal speculas	51	Jatho	
Hartmann-Hoffmann		Naso-pharyngeal forceps	137
Spoon forceps	22	Jennings	
Hartmann-Noyes		Mouth gags	120
Ear polypus forceps	22	Joseph	
Hartmann-Wullstein		Dissecting scissors	74
Alligator forceps	22	Retractors	94
Spoon forceps	22	Raspatories	99
Harvey		Rasps	108
Wire cutting scissors	113	Nasal saws	111
Haslinger		Rhinoplastic Knives	65
Velum retractors	127	Joseph-Masing	
Heath		Elevators	103
Suture scissors	87		
Heermann		K	
Chisels	42	Kabierske	
Hammer	42	Powder Blowers	9
Gouges	42	Kahn-Beuse	
Henke		Tonsil Scissors and Nasal Scissors	71
Dissectors	126	Kaye	
Heymann		Face lift scissors	90
Tonsil scissors and nasal scissors	73	Blepharoplasty scissors	92
Hinderer		Kaye-Freeman	
Tissue and cartilage forceps	93	Face lift scissors	90
Holinger		Kelly	
Laryngoscopes	153	Dissecting scissors	74
Holmgren		Kerrison	
Ear speculas	27	Punches	35, 58
Hooks	39-40	Killian	
Hough		Chisels	97
Raspatories	37	Elevators	102, 105
Excavators	37	Laryngectomy scissor	157
Measuring Rods	38	Nasal Scissors	68
House		Nasal Speculas	50
Elevators	37	Septum forceps	53
Lancet Knives	36	Kistner	
Measuring Rods	38	Ivaginators	38
Ear Curettes	41	Kleinsasser	
Ear Spoons	41	Laryngoscopes	152
House-Dieter		Injection drain cannulas	152
Malleus Nippers	31	Suction tubes	152
House-Luer		Knight	
Aspirating and Irrigating Instruments	7	Tonsil scissors and nasal scissors	73
Howarth		König	
Elevators	103	Tuning Forks	4
Hurd		Raspatories	101
Dissectors	125	Krause	
Tonsil needles	132	Polypus snares	23, 112
Hyllin		Krause-Voss	
Raspatories	101	Polypus snares	23, 112
I		L	
Iris		La Force	
Fine scissors	81-84	Tonsillectomes	133-134
		La Grange	
J		Fine scissors	78
Jackson		Laborde	
Tonsil Scissors and Nasal Scissors	73	Trachea dilators	144
Trachea retractors	143	Lange	
Laryngoscopes	153	Hooks for posterior nares	95
Jansen		Langenbeck	
Nasal dressing forceps	93	Elevators	105
Ear Dressing Forceps	20		

Table of contents

Lange-Wilde			
Polypus snares	23		
Lange-Wilde (Bruenings)			
Polypus snares	112		
Laryngeal mirrors	141		
Laryngoscope holder	151		
Lewy			
Laryngoscope holder	151		
Lincoln			
Vascular scissors	77		
Littauer			
Suture scissors	87		
Little			
Suture scissors	86		
Locklin			
Dissecting scissors	76		
Vascular scissors	77		
Love			
Retractors	127		
Love-Gruenwald			
Nasal Cutting Forceps	64		
Luc			
Septum Compression Forceps	54		
Lucae			
Ear Hooks	16		
Ear Knives	15		
Ear Dressing Forceps	20		
Tuning Forks	3		
Luer			
Suction tubes	114		
Trachea tubes	145		
Luniatschek			
Tonsil gauze packer	127		
M			
Magill			
Suction tubes	114		
Magnetic racks	45		
Maltz			
Rasps	106, 108		
Rhinoplastic Knives	66		
Masing			
Columella forceps	93		
Elevators	103		
Rhinoplastic Knives	66		
Mauder			
Oral screws	118		
Mayo			
Tongue spatulas	118		
McGee			
Forceps	29		
Footplate hooks	40		
McGuire			
Fine scissors	78		
McIndoe			
Tonsil scissors and nasal scissors	70		
Bone cutting forceps	55		
McKenty			
Raspatories	101		
Elevators	102		
Meltzer			
Adenoid punches	137		
Metzenbaum			
Tonsil scissors	128		
Michel			
Rhinoscopic mirrors	157		
Mikulicz			
Tonsil seizing forceps	129		
Miller			
Rasps	106		
Mini container	45		
Moldenhauer			
Ear levers	16		
Möltgen			
Goniometers	115		
Moritz-Schmidt			
Tongue spatulas	119		
Mouth gags	120		
Muck			
Ear knives	14		
N			
Nager			
Soft palate retractors	127		
Tonsil needles	132		
Nasal scissors	68		
Negus			
Tonsil clamps	128		
Neivert			
Hooks for posterior nares	95		
Neurotone-5			
Tuning Forks	4		
News			
Trachea retractors	143		
Northbent			
Suture scissors	86		
O			
Olivecrona			
Nasal scissors	68		
P			
Palmer			
Nasal speculas	49		
Par			
Blepharoplasty scissors	92		
Peck Joseph			
Dissecting scissors	76		
Pennington			
Elevators	102		
Perkins			
Retractors	18-19		
Pierce			
Elevators	102		
Plester			
Wire Guide	38		
Antrum-Hooklets	39		
Flap Knives	36		
Aspirating Cannulas	6		
Politzer			
Air Bag	8		
Ear Knives	14-15		
Ear Speculas	10		
Potts Smith			
Tonsil scissors and nasal scissors	71		
Prince			
Tonsil scissors and nasal scissors	70		
Tonsil scissors	128		

Table of contents

Q

Quervain
Elevators 105
Quire
Foreign body levers 21

R

Rack for sterilization and storage 46
Raspatories 101
Rasps 108
Rees
Face lift scissors 88
Reichert
Epiglottis retractors 157
Reynolds
Dissecting scissors 74
Ribbon Iris
Fine scissors 85
Ribbon Kaye
Blepharoplasty scissors 92
Ribbon Stevens
Fine scissors 85
Ribbon Strabismus
Fine scissors 85
Richnau-Holmgren
Ear speculas 27
Ritter-Halle
Dilators 114
Roeder
Ligature carrier 135
Rosen
Elevators 37
Incision knives 36
Needles 39-40
Round knives 36
Irrigating cannulas 6
Rotation racks 45
Rules 115
Rydel-Seiffer
Tuning forks 4

S

Sanvenero
Dissecting scissors 74
Schimmelbusch
Ear syringe and accessories 8
Schmeden
Tonsil punch forceps 136
Nasal cutting forceps 56
Schnidt
Tonsil clamps 128
Schoenborn
Trachea retractors 143
Schömmacker-Loth
Suture scissors 86
Schuhknecht
Forceps 29
Wire bending die 42
Roller knives 36
Scissors 154
Sealy
Fine scissors 80
Sebileau
Elevators 105

Seemann-Seiffert
Mouth gags 120
Seiler
Nasal scissors 69
Senn-Miller
Trachea retractors 143
Septum compression forceps 54
Sewall
Raspatories 101
Sexton
Ear knives 14
Shambaugh
Hooklets 39
Shea
Blepharoplasty scissors 92
Ear spoons 27
Sheehan
Chisels 97
Shortbent
Suture scissors 86
Siebenmann
Suction tubes 114
Silver
Chisels 96
Sluder-Ballenger
Tonsillectomes 131
Smith
Wire cutting scissors 113
Snare wires 112, 135
Spencer
Suture scissors 86
Spurling
Nasal cutting forceps 64
St. Clair-Thompson
Adenoid cures 110
Stammberger
Nasal cutting forceps 57
Steel wires 112, 135
Sternberg
Lip retractors 121
Stevens
Fine scissors 79
Strabismus
Dissecting scissors 75
Strümpfle
Spoon forceps 22
Struycken
Rongeur 56
Suction tubes 138

T

Tabb
Crura nippers 31
Sickle knives 36
Takahashi
Rongeur 56
Thilenius
Tonsil punch forceps 136
Thudichum (Goldsmith)
Nasal speculas 49
Tieck-Halle
Nasal speculas 50
Tilley
Septum compression forceps 53
Ear tampon forceps 21

Table of contents

Tobold			
Tongue spatulas	119		
Tongue spatulas	118		
Toynbee			
Nasal speculas	10		
Trachea retractors	142-143		
Trachea tubes	146		
Tracheotomy set	147		
Trautman			
Ear knives	15		
Troeltsch (Wilde)			
Ear dressing forceps	20		
Trousseau			
Trachea dilators	144		
Tyding			
Tonsil knives	124		
Tonsil snares	130		
U			
Uckermann			
Trachea trocars	144		
Universal			
Wire cutting scissors	23, 112-113, 135		
Rubber bulb	10		
Powder blowers	9-10		
V			
Vessel scissors	79		
Voltolini			
Nasal speculas	49		
W			
Wagener			
Ear hooks	16		
Wagner			
Fine scissors	82-83		
Walsham			
Straightening forceps	55		
Walter			
Chisels	98		
Wartenberg			
Sensibility instrument	115		
Watson-Williams			
Rongeur	54		
Weil-Blakesley			
Nasal cutting forceps	56		
Weingärtner			
Ear polypus forceps	22		
Westmacott			
Septum compression forceps	53		
White			
Tonsil seizing forceps	129		
Whitehead			
Mouth gags	120		
Wieder			
Tongue spatulas	119		
Williger			
Raspatories	99		
Wire bending plier	112, 135		
Wire loops	135		
Wullstein			
Elevators	37		
Cannulas	7		
Retractors	18		
Y			
Yankauer			
Needles	114		
Dissectors	126		
Suction tubes	138		
Ear Hooks	16		
Young			
Tongue holding forceps	121		
Z			
Zaufal			
Ear levers	16		
Zöllner			
Elevators	37		
Guiding forks	44		
Footplate hooks	43		
Hooks	43		
Cannulas	6		
Needles	43-44		
Raspatories	44		
Round knives	44		
Suction tubes	6		
Sickle knives	44		

Artikelnummernverzeichnis Numerical Index

Art.-Nr.	Seite		Art.-Nr.	Seite		Art.-Nr.	Seite		Art.-Nr.	Seite
1			1.270.11	79		1.319.14	76		1.703.10	85
1.051.18	128		1.271.09	79		1.324.13	74		1.704.09	85
1.054.11	92		1.271.10	79		1.324.15	74		1.704.10	85
1.055.11	92		1.271.11	79		1.324.18	74		1.705.09	85
1.058.11	92		1.274.10	79		1.324.20	74		1.705.10	85
1.059.11	92		1.274.11	79		1.324.23	74		1.710.09	85
1.064.14	92		1.275.09	79		1.325.13	74		1.711.09	85
1.065.14	92		1.275.10	79		1.325.15	74		1.714.09	85
1.094.19	70		1.275.11	79		1.325.18	74		1.715.09	85
1.100.17	88		1.276.11	79		1.325.20	74		1.716.10	92
1.100.20	88		1.277.11	79		1.325.23	74		1.717.10	92
1.101.17	88		1.284.09	81		1.334.16	74		2	
1.101.20	88		1.284.10	81		1.334.18	74		2.183.19	128
1.105.17	70		1.284.11	80		1.335.16	74		2.185.19	128
1.105.17	128		1.285.09	81		1.335.18	74		2.591.19	128
1.110.19	89		1.285.10	81		1.344.11	92		2.595.19	128
1.110.23	89		1.285.11	80		1.345.11	92		2.597.19	128
1.111.19	89		1.286.10	81		1.345.17	91		2.599.20	129
1.111.23	89		1.287.10	81		1.360.11	86		3	
1.114.18	89		1.288.10	82		1.364.12	86		3.160.12	93
1.115.17	90		1.288.11	82		1.371.11	86		3.160.15	93
1.115.18	70		1.289.10	82		1.371.14	86		3.424.13	93
1.115.18	128		1.289.11	82		1.371.18	86		3.424.15	73
1.115.185	89		1.290.12	82		1.372.09	86		3.424.15	109
1.115.19	71		1.291.12	82		1.372.10	86		3.429.11	20
1.116.14	88		1.292.12	82		1.372.12	86		3.429.13	20
1.116.14	71		1.293.12	82		1.377.09	86		3.429.15	20
1.116.18	88		1.294.12	82		1.377.13	86		3.433.13	20
1.116.18	71		1.295.12	82		1.379.11	86		3.437.14	20
1.117.14	88		1.297.11	83		1.382.13	87		3.441.16	93
1.117.14	71		1.304.08	83		1.382.14	87		3.441.16	20
1.117.18	88		1.304.09	83		1.392.14	87		3.441.19	93
1.117.18	71		1.304.10	83		1.392.18	87		3.441.19	20
1.120.19	71		1.304.11	83		1.397.15	87		3.441.21	20
1.124.17	71		1.304.12	83		1.440.16	91		3.443.14	20
1.124.17	128		1.305.08	83		1.440.17	77		3.443.16	93
1.129.13	72		1.305.09	83		1.441.16	91		3.443.16	20
1.131.13	72		1.305.10	83		1.441.17	77		3.730.11	93
1.135.13	72		1.305.11	83		1.442.17	77		3.732.11	93
1.137.13	72		1.305.12	83		1.443.17	77		6	
1.137.17	69		1.306.09	80		1.445.16	76		6.101.01	16
1.139.16	73		1.306.10	80		1.447.16	77		6.101.02	16
1.147.18	73		1.306.11	80		1.470.10	113		6.101.03	16
1.147.20	73		1.307.11	84		1.470.12	113		6.103.01	16
1.149.18	73		1.308.10	84		1.471.10	113		6.103.02	16
1.149.20	73		1.308.11	84		1.471.12	113		6.103.03	16
1.175.19	90		1.309.10	84		1.474.10	113		6.103.04	16
1.250.09	75		1.309.11	84		1.474.12	113		6.103.05	16
1.250.11	75		1.310.10	84		1.475.10	113		6.103.06	16
1.251.09	75		1.310.11	84		1.475.12	113		6.103.07	16
1.251.11	75		1.311.10	84		1.477.12	113		6.120.01	142
1.254.11	92		1.311.11	84		1.480.12	113		6.120.02	142
1.255.11	92		1.313.11	84		1.484.13Z	91		6.120.03	142
1.260.10	75		1.314.14	74		1.485.13Z	91		6.120.04	142
1.261.10	75		1.314.17	74		1.487.13	91		6.121.01	142
1.264.10	78		1.315.14	74		1.494.16	113		6.121.02	143
1.265.10	78		1.315.17	74		1.495.16	113		6.121.02	142
1.267.10	78		1.316.14	74		1.700.10	85		6.121.03	143
1.269.11	78		1.317.14	74		1.701.10	85		6.121.03	142
1.270.10	79		1.318.14	76		1.702.10	85		6.121.04	143

Artikelnummernverzeichnis Numerical Index

Art.-Nr.	Seite		Art.-Nr.	Seite		Art.-Nr.	Seite		Art.-Nr.	Seite
6.121.04	142		24.016.60	115		24.947.30	7		26.080.19	129
6.121.52	143		24.016.61	115		24.947.45	7		26.081.18	129
6.121.53	143		24.018.40	115		24.948.18	7		26.081.19	129
6.121.54	143		24.018.50	115		24.948.25	7		26.083.19	129
6.122.01	142		24.018.60	115		24.948.30	7		26.085.18	129
6.122.02	142		24.021.01	115		24.950.20	138		26.085.23	129
6.122.03	142		24.032.10	115		24.950.25	138		26.094.21	129
6.122.04	142		24.032.15	115		24.950.30	138		26.095.18	129
6.123.01	142		24.032.20	115		24.951.20	138		26.100.01	125
6.123.02	142		24.032.30	115		24.951.25	138		26.100.02	125
6.123.03	142		24.032.50	115		24.951.30	138		26.101.01	125
6.123.04	142		24.370.18	124		24.953.26	138		26.101.02	125
6.124.01	142		24.370.19	124		24.961.01	6		26.102.01	126
6.124.02	142		24.370.21	124		24.961.02	6		26.102.02	126
6.124.03	142		24.370.22	124		24.961.05	6		26.102.03	126
6.124.04	142		24.371.21	124		24.961.07	6		26.103.21	126
6.125.01	142		24.371.51	124		26.000.14	118		26.109.20	124
6.125.02	142		24.371.61	124		26.002.14	118		26.110.19	136
6.125.03	142		24.902.06	5		26.002.17	118		26.150.26	130
6.125.04	142		24.902.07	5		26.004.08	118		26.152.25	130
6.126.01	142		24.902.08	5		26.007.16	118		26.154.27	130
6.126.02	142		24.902.09	5		26.009.19	118		26.155.00	130
6.126.03	142		24.902.10	5		26.010.16	119		26.155.01	130
6.126.04	142		24.902.11	5		26.010.19	119		26.155.05	130
6.131.04	95		24.902.12	5		26.011.15	119		26.155.06	130
6.139.01	143		24.903.06	6		26.017.01	119		26.156.03	135
6.139.02	143		24.903.08	6		26.017.02	119		26.156.04	135
6.154.01	94		24.903.09	6		26.023.10	119		26.156.05	135
6.154.02	94		24.911.02	138		26.025.12	119		26.156.13	135
6.154.05	94		24.911.70	138		26.026.14	119		26.156.14	135
6.154.07	94		24.911.71	138		26.031.09	120		26.156.15	135
6.154.10	94		24.916.03	6		26.031.11	120		26.157.04	135
6.156.15	94		24.916.05	6		26.031.13	120		26.157.05	135
6.214.06	17		24.916.07	6		26.031.15	120		26.158.03	112
6.214.08	17		24.916.13	6		26.033.09	120		26.158.03	135
6.215.06	17		24.916.15	6		26.033.11	120		26.158.04	112
6.215.08	17		24.916.17	6		26.033.13	120		26.158.04	135
6.219.11	18		24.944.00	7		26.033.15	120		26.158.05	112
6.219.13	18		24.944.02	6		26.033.49	164		26.158.05	135
6.220.11	18		24.945.05	6		26.033.51	164		26.159.00	131
6.220.13	18		24.945.06	6		26.033.53	145		26.159.01	131
6.222.13	19		24.945.07	6		26.033.55	141		26.159.02	131
6.223.13	19		24.945.08	6		26.034.09	120		26.159.03	131
6.224.11	19		24.945.09	6		26.034.11	120		26.159.04	131
6.225.11	19		24.945.10	6		26.034.13	120		26.160.01	127
6.226.01	18		24.945.12	6		26.034.15	120		26.160.02	127
6.226.02	18		24.945.14	6		26.068.14	121		26.161.00	136
20			24.945.15	6		26.068.16	121		26.163.21	132
20.014.17	115		24.945.18	6		26.068.18	121		26.165.21	132
20.015.18	115		24.945.20	6		26.070.12	121		26.166.24	132
23.230.18	159		24.945.25	6		26.070.14	121		26.167.25	132
24.014.00	115		24.945.30	6		26.070.16	121		26.172.26	135
24.014.01	115		24.946.01	7		26.071.19	121		26.174.00	127
24.014.02	115		24.946.02	7		26.071.21	121		26.175.23	127
24.016.15	115		24.946.03	7		26.072.16	121		26.176.18	127
24.016.20	115		24.947.09	7		26.072.18	121		26.176.20	127
24.016.40	115		24.947.12	7		26.073.16	121		26.176.22	127
24.016.50	115		24.947.15	7		26.073.99	121		26.180.01	110
24.016.51	115		24.947.18	7		26.075.10	118		26.180.02	110
24.016.52	115		24.947.25	7		26.075.11	118		26.180.03	110

**Artikelnummernverzeichnis
Numerical Index**

Art.-Nr.	Seite		Art.-Nr.	Seite		Art.-Nr.	Seite		Art.-Nr.	Seite
26.180.04	110		26.230.12	157		26.291.13	155		26.311.07	144
26.180.05	110		26.230.14	157		26.291.14	155		26.311.09	144
26.180.06	110		26.230.16	157		26.291.15	155		26.315.14	144
26.186.01	133		26.241.23	157		26.291.16	155		26.317.14	144
26.186.01	110		26.274.00	151		26.291.17	155		26.323.01	143
26.186.02	133		26.274.20	153		26.291.18	155		26.323.02	143
26.186.02	110		26.274.70	153		26.292.01	156		26.324.01	143
26.186.03	133		26.274.80	153		26.292.02	156		26.324.02	143
26.186.03	110		26.274.92	153		26.292.03	156		26.329.15	143
26.186.04	110		26.274.97	153		26.292.04	156		26.331.15	143
26.186.11	133		26.274.98	153		26.292.05	156		26.337.21	143
26.186.12	133		26.275.70	153		26.292.06	156		26.500.12	49
26.186.13	133		26.275.80	153		26.292.07	156		26.500.16	49
26.187.01	133		26.275.97	153		26.292.08	156		26.500.19	49
26.187.02	133		26.275.98	153		26.292.09	156		26.502.07	49
26.187.03	133		26.280.00	151		26.292.10	156		26.504.01	49
26.187.11	133		26.281.00	151		26.292.11	156		26.504.02	49
26.187.12	133		26.282.01	152		26.292.12	156		26.504.03	49
26.187.13	133		26.282.02	152		26.292.13	156		26.507.01	50
26.188.01	134		26.282.03	152		26.292.14	156		26.507.02	50
26.188.02	134		26.282.04	152		26.292.15	156		26.508.01	51
26.188.03	134		26.282.05	152		26.292.16	156		26.508.02	51
26.188.04	134		26.282.06	152		26.292.17	156		26.508.03	51
26.188.05	134		26.282.07	152		26.292.18	156		26.509.01	51
26.188.11	137		26.283.01	152		26.292.51	156		26.509.02	51
26.188.11	134		26.283.02	152		26.292.52	156		26.509.03	51
26.188.12	134		26.283.03	152		26.292.53	156		26.513.00	51
26.188.13	134		26.283.04	152		26.292.54	156		26.513.01	51
26.188.14	134		26.283.05	152		26.292.55	156		26.513.02	51
26.188.15	134		26.283.06	152		26.292.56	156		26.513.03	51
26.189.11	137		26.283.07	152		26.292.57	156		26.515.01	49
26.193.24	137		26.284.00	152		26.292.58	156		26.515.02	49
26.200.06	141		26.285.00	152		26.292.59	156		26.515.03	49
26.200.08	141		26.290.01	154		26.292.60	156		26.519.01	51
26.200.10	141		26.290.01A	154		26.292.61	156		26.519.02	51
26.200.12	141		26.290.01B	154		26.292.62	156		26.519.03	51
26.200.14	141		26.290.02	154		26.292.63	156		26.521.14	49
26.200.16	141		26.290.03	154		26.292.64	156		26.525.01	50
26.200.18	141		26.290.04	154		26.292.65	156		26.525.02	50
26.200.20	141		26.290.05	154		26.292.66	156		26.525.03	50
26.200.22	141		26.290.06	154		26.292.67	156		26.525.04	50
26.200.24	141		26.290.07	154		26.292.68	156		26.525.51	50
26.200.26	141		26.290.07A	154		26.292.81	156		26.525.52	50
26.200.28	141		26.290.08	154		26.292.82	156		26.525.53	50
26.200.30	141		26.290.08A	154		26.292.83	156		26.525.54	50
26.201.00	141		26.290.09	154		26.292.84	156		26.528.01	52
26.202.00	141		26.290.10	154		26.292.85	156		26.528.02	52
26.210.06	141		26.290.11	154		26.292.86	156		26.528.03	52
26.210.08	141		26.290.11A	154		26.292.87	156		26.528.04	52
26.210.10	141		26.291.01	155		26.292.88	156		26.533.01	52
26.210.12	141		26.291.02	155		26.292.89	156		26.533.02	52
26.210.14	141		26.291.03	155		26.292.90	156		26.533.03	52
26.210.16	141		26.291.05	155		26.292.91	156		26.533.04	52
26.210.18	141		26.291.06	155		26.292.92	156		26.534.01	52
26.210.20	141		26.291.07	155		26.292.93	156		26.534.02	52
26.210.22	141		26.291.08	155		26.292.94	156		26.534.03	52
26.210.24	141		26.291.09	155		26.292.95	156		26.534.04	52
26.210.26	141		26.291.10	155		26.292.96	156		26.601.13	21
26.210.28	141		26.291.11	155		26.292.97	156		26.601.17	53
26.210.30	141		26.291.12	155		26.292.98	156		26.607.16	53

Artikelnummernverzeichnis
Numerical Index

Art.-Nr.	Seite		Art.-Nr.	Seite		Art.-Nr.	Seite		Art.-Nr.	Seite
26.607.20	53		26.693.22	102		26.776.17	95		26.961.20	114
26.608.01	53		26.695.22	103		26.778.01	95		26.961.25	114
26.608.02	53		26.704.04	97		26.778.02	95		26.961.30	114
26.608.17	53		26.704.06	97		26.778.03	95		26.962.03	114
26.621.26	112		26.704.08	97		26.779.16	95		26.963.05	114
26.623.26	112		26.705.17	97		26.780.20	95		26.964.01	114
26.624.24	112		26.707.17	97		26.782.16	95		26.964.02	114
26.627.03	112		26.710.03	67		26.783.01	95		26.964.03	114
26.627.03	135		26.710.04	67		26.787.21	98		27.000.01	3
26.627.04	112		26.710.05	67		26.788.01	98		27.000.02	3
26.627.04	135		26.711.03	67		26.788.03	98		27.000.03	3
26.627.05	112		26.711.04	67		26.788.04	98		27.000.04	3
26.627.05	135		26.711.05	67		26.790.01	98		27.000.05	3
26.627.13	112		26.718.03	96		26.790.02	98		27.001.00	3
26.627.13	135		26.718.06	96		26.790.03	98		27.001.01	3
26.627.14	112		26.718.10	96		26.790.04	98		27.001.02	3
26.627.14	135		26.718.13	96		26.790.05	98		27.001.03	3
26.627.15	112		26.719.03	96		26.790.06	98		27.001.04	3
26.627.15	135		26.719.06	96		26.801.01	54		27.001.05	3
26.640.01	65		26.719.10	96		26.803.01	54		27.001.06	3
26.640.02	65		26.719.13	96		26.803.02	54		27.004.01	3
26.640.10	65		26.721.06	97		26.807.01	54		27.004.02	3
26.640.11	65		26.724.16	97		26.807.02	54		27.004.03	3
26.641.01	65		26.726.16	97		26.813.01	54		27.004.04	3
26.641.02	65		26.728.06	96		26.813.02	54		27.004.05	3
26.641.10	65		26.728.07	96		26.813.03	54		27.004.06	3
26.641.11	65		26.728.09	96		26.813.04	54		27.008.01	4
26.642.01	67		26.728.12	96		26.820.18	104		27.010.01	4
26.642.16	67		26.729.06	96		26.822.20	104		27.012.01	4
26.644.13	66		26.732.03	98		26.823.21	104		27.013.01	4
26.644.14	66		26.732.04	98		26.824.24	104		27.015.01	4
26.645.16	65		26.736.04	97		26.824.25	104		27.018.00	4
26.646.14	66		26.736.05	97		26.825.22	55		27.031.01	5
26.646.15	66		26.736.06	97		26.826.01	55		27.031.02	5
26.646.16	66		26.736.07	97		26.826.02	55		27.031.03	5
26.647.15	66		26.740.10	96		26.826.03	55		27.031.04	5
26.647.16	65		26.740.12	96		26.830.01	57		27.031.05	5
26.649.16	65		26.740.14	96		26.830.03	57		27.031.06	5
26.650.15	65		26.740.16	96		26.838.21	68		27.034.00	8
26.651.16	66		26.741.01	96		26.839.00	68		27.034.03	8
26.652.15	65		26.741.02	96		26.839.01	68		27.034.04	8
26.654.15	66		26.741.03	96		26.839.02	68		27.034.15	8
26.663.18	100		26.746.04	98		26.841.20	68		27.034.17	8
26.665.20	100		26.747.04	98		26.841.20TC	69		27.034.22	8
26.668.17	100		26.748.15	98		26.842.20TC	69		27.034.50	8
26.668.19	67		26.751.01	111		26.843.21	157		27.036.00	9
26.669.01	67		26.751.02	111		26.843.21	68		27.036.01	9
26.669.02	67		26.752.01	111		26.958.01	114		27.036.02	9
26.669.03	67		26.752.02	111		26.958.02	114		27.036.03	9
26.672.21	102		26.752.03	111		26.958.03	114		27.036.04	9
26.673.21	102		26.756.00	109		26.958.04	114		27.036.05	9
26.676.18	103		26.757.01	109		26.958.05	114		27.040.00	9
26.676.21	102		26.757.02	109		26.960.01	114		27.040.01	10
26.679.20	103		26.760.08	93		26.960.15	114		27.040.02	10
26.679.21	103		26.760.10	93		26.960.17	114		27.043.03	8
26.681.21	103		26.761.10	93		26.960.20	114		27.043.05	8
26.683.04	101		26.767.16	95		26.960.25	114		27.043.06	8
26.683.05	101		26.767.17	95		26.960.30	114		27.044.05	8
26.688.22	103		26.769.13	95		26.961.15	114		27.044.07	8
26.691.21	102		26.774.16	94		26.961.17	114		27.044.10	8

Artikelnummernverzeichnis
Numerical Index

Art.-Nr.	Seite		Art.-Nr.	Seite		Art.-Nr.	Seite		Art.-Nr.	Seite
27.046.05	8		27.152.04	27		27.314.01	15		27.451.41	32
27.046.07	8		27.152.05	12		27.314.02	15		27.451.42	32
27.046.10	8		27.152.06	12		27.314.03	15		27.451.61	32
27.100.00	10		27.152.07	12		27.316.01	15		27.451.62	32
27.100.02	10		27.152.08	12		27.316.02	15		27.451.71	32
27.100.03	10		27.153.01	12		27.351.16	23		27.451.72	32
27.100.04	10		27.153.02	12		27.351.20	23		27.452.01	33
27.100.05	10		27.153.03	12		27.351.21	23		27.452.02	33
27.102.00	10		27.153.04	12		27.353.16	23		27.452.06	33
27.102.02	10		27.153.05	12		27.353.20	23		27.452.41	33
27.102.03	10		27.153.06	12		27.354.18	23		27.452.42	33
27.102.05	10		27.153.07	12		27.354.20	23		27.452.46	33
27.104.00	10		27.153.08	12		27.358.20	23		27.452.61	33
27.104.01	10		27.163.14	16		27.358.30	23		27.452.62	33
27.104.03	10		27.167.16	16		27.359.20	23		27.452.71	33
27.104.05	10		27.168.16	16		27.359.30	23		27.452.72	33
27.104.07	10		27.169.16	16		27.360.20	23		27.453.01	33
27.104.08	10		27.181.01	16		27.360.30	23		27.453.02	33
27.108.00	10		27.181.02	16		27.410.00	28		27.453.03	33
27.108.01	10		27.182.16	16		27.410.01	28		27.453.04	33
27.108.03	10		27.183.15	16		27.410.02	28		27.453.05	33
27.108.04	10		27.200.09	21		27.410.03	28		27.453.41	33
27.108.05	10		27.202.09	21		27.410.04	28		27.453.42	33
27.108.06	10		27.206.12	21		27.412.00	28		27.453.43	33
27.109.12	10		27.208.14	21		27.412.01	28		27.453.44	33
27.126.05	27		27.210.07	22		27.412.02	28		27.453.45	33
27.126.06	27		27.212.08	22		27.412.03	28		27.453.61	33
27.126.07	27		27.214.08	22		27.412.04	28		27.453.62	33
27.127.03	27		27.214.14	22		27.414.00	28		27.453.63	33
27.127.05	27		27.214.16	22		27.414.01	28		27.453.64	33
27.127.07	27		27.216.08	22		27.414.02	28		27.453.65	33
27.150.00	27		27.216.14	22		27.414.03	28		27.453.71	33
27.150.01	12		27.218.09	22		27.414.04	28		27.453.72	33
27.150.01	27		27.221.08	22		27.416.08	31		27.453.73	33
27.150.02	12		27.222.08	22		27.417.01	31		27.453.74	33
27.150.02	27		27.224.08	22		27.417.02	31		27.453.75	33
27.150.03	12		27.226.01	22		27.420.02	29		27.454.01	34
27.150.03	27		27.226.02	22		27.422.01	29		27.454.02	34
27.150.04	12		27.226.03	22		27.422.02	29		27.454.03	34
27.150.04	27		27.228.01	22		27.423.01	29		27.454.04	34
27.150.05	12		27.228.02	22		27.426.01	31		27.454.06	34
27.150.06	12		27.228.03	22		27.426.02	31		27.454.07	34
27.150.07	12		27.229.08	22		27.426.03	31		27.456.01	34
27.150.08	12		27.230.08	22		27.426.04	31		27.456.02	34
27.151.01	12		27.232.08	22		27.427.00	30		27.456.03	34
27.151.02	12		27.300.13	14		27.428.00	30		27.456.04	34
27.151.03	12		27.301.15	14		27.428.01	30		27.456.06	34
27.151.04	12		27.302.13	14		27.428.04	30		27.456.07	34
27.151.05	12		27.302.16	14		27.450.01	32		27.500.01	36
27.151.06	12		27.304.01	14		27.450.02	32		27.500.02	36
27.151.07	12		27.304.02	14		27.450.06	32		27.500.04	36
27.151.08	12		27.305.01	14		27.450.41	32		27.501.02	36
27.152.00	27		27.305.02	14		27.450.42	32		27.502.01	36
27.152.01	12		27.306.17	14		27.450.46	32		27.502.02	36
27.152.01	27		27.307.01	14		27.450.61	32		27.503.02	36
27.152.02	12		27.307.02	14		27.450.62	32		27.503.10	36
27.152.02	27		27.308.16	15		27.450.71	32		27.503.15	36
27.152.03	12		27.309.16	15		27.450.72	32		27.503.20	36
27.152.03	27		27.311.16	15		27.451.01	32		27.503.26	36
27.152.04	12		27.312.17	15		27.451.02	32		27.503.30	36

Artikelnummernverzeichnis Numerical Index

Art.-Nr.	Seite		Art.-Nr.	Seite		Art.-Nr.	Seite		Art.-Nr.	Seite
27.503.61	36		27.517.22	40		27.700.09	145		27.712.26	145
27.503.81	36		27.517.23	40		27.700.20	145		40	
27.504.03	37		27.517.31	40		27.700.21	145		40.000.10	35
27.504.04	37		27.517.32	40		27.700.22	145		40.000.20	35
27.504.05	38		27.517.33	40		27.700.23	145		40.000.30	35
27.504.14	39		27.517.71	40		27.700.24	145		40.002.10	35
27.504.20	37		27.517.72	40		27.700.25	145		40.002.20	35
27.504.40	37		27.517.73	40		27.700.26	145		40.004.03	35
27.504.41	37		27.517.81	40		27.700.27	145		40.004.03	58
27.504.50	37		27.517.82	40		27.700.28	145		40.004.04	35
27.504.61	37		27.517.83	40		27.700.29	145		40.004.04	58
27.504.63	37		27.520.01	27		27.704.00	146		40.004.05	35
27.504.71	37		27.521.01	27		27.704.01	146		40.004.05	58
27.504.81	37		27.522.01	41		27.704.02	146		40.004.06	35
27.504.83	37		27.522.02	41		27.704.03	146		40.004.06	58
27.505.18	38		27.522.03	41		27.704.04	146		40.006.33	59
27.508.00	38		27.522.04	41		27.704.05	146		40.006.40	59
27.508.01	38		27.523.01	41		27.704.06	146		40.007.33	59
27.508.02	38		27.523.02	41		27.704.07	146		40.007.40	59
27.508.03	38		27.530.00	42		27.704.08	146		40.008.30	59
27.508.04	38		27.530.01	42		27.704.09	146		40.010.01	60
27.510.01	39		27.530.02	42		27.704.20	146		40.010.02	60
27.510.02	39		27.530.03	42		27.704.21	146		40.010.03	60
27.510.04	39		27.530.04	42		27.704.22	146		40.010.05	60
27.510.24	39		27.530.05	42		27.704.23	146		40.010.52	61
27.510.26	39		27.530.06	42		27.704.24	146		40.010.53	61
27.510.28	39		27.532.19	42		27.704.25	146		40.010.55	61
27.510.30	39		27.534.00	42		27.704.26	146		40.012.01	60
27.510.44	39		27.540.00	43		27.704.27	146		40.012.02	61
27.510.46	39		27.540.01	43		27.704.28	146		40.012.03	61
27.510.48	39		27.540.02	43		27.704.29	146		40.012.05	61
27.510.50	39		27.540.03	43		27.704.40	146		40.014.01	60
27.510.52	39		27.540.04	43		27.704.41	146		40.014.01 Z	60
27.510.55	39		27.540.05	43		27.704.42	146		40.014.02	61
27.510.58	39		27.540.06	43		27.704.43	146		40.014.02 Z	61
27.510.59	39		27.540.07	43		27.704.44	146		40.014.03	61
27.510.74	39		27.540.08	43		27.704.45	146		40.014.03 Z	61
27.510.76	39		27.550.01	44		27.704.46	146		40.014.05 Z	61
27.510.78	39		27.550.02	44		27.704.47	146		40.016.01	60
27.510.80	39		27.550.03	44		27.704.48	146		40.016.02	60
27.510.82	39		27.550.04	44		27.704.49	146		40.016.02 Z	60
27.510.85	39		27.550.05	44		27.706.24	146		40.016.03	60
27.510.88	39		27.550.06	44		27.706.25	146		40.016.03 Z	60
27.510.89	39		27.550.07	44		27.706.26	146		40.016.05	60
27.510.90	39		27.550.08	44		27.706.27	146		40.016.05 Z	60
27.510.92	39		27.550.09	44		27.706.28	146		40.016.52	61
27.510.93	39		27.561.01	114		27.706.29	146		40.016.53	61
27.513.02	40		27.561.02	114		27.708.04	146		40.016.55	61
27.513.03	40		27.561.03	114		27.708.05	146		40.018.01	60
27.513.12	40		27.561.04	114		27.708.06	146		40.018.02	60
27.513.13	40		27.561.05	114		27.708.07	146		40.018.02 Z	60
27.514.01	40		27.700.00	145		27.708.08	146		40.018.03	60
27.515.01	40		27.700.01	145		27.708.09	146		40.018.03 Z	60
27.517.01	40		27.700.02	145		27.708.24	146		40.018.05	60
27.517.02	40		27.700.03	145		27.708.25	146		40.018.05 Z	60
27.517.03	40		27.700.04	145		27.708.26	146		40.018.52	61
27.517.11	40		27.700.05	145		27.708.27	146		40.018.53	61
27.517.12	40		27.700.06	145		27.708.28	146		40.018.55	61
27.517.13	40		27.700.07	145		27.708.29	146		40.019.01	60
27.517.21	40		27.700.08	145		27.710.00	147		40.019.01 Z	60

Artikelnummernverzeichnis Numerical Index

Art.-Nr.	Seite		Art.-Nr.	Seite		Art.-Nr.	Seite		Art.-Nr.	Seite
40.019.02	61		40.040.11	136		40.278.06	97		40.446.02	107
40.019.02	61		40.040.11	56		40.278.07	97		40.446.03	107
40.019.02 Z	61		40.040.13	136		40.278.09	97		40.446.04	107
40.019.03	61		40.040.15	136		40.278.12	97		40.446.05	107
40.019.03	61		40.040.17	136		40.279.04	97		40.452.01	106
40.019.03 Z	61		40.041.01	136		40.279.07	97		40.452.02	106
40.019.05	61		40.041.01	56		40.279.09	97		40.704.19	55
40.019.05 Z	61		40.041.02	136		40.279.12	97		40.708.15	55
40.027.05	58		40.041.02	56		40.347.20	101		40.709.15	55
40.027.15	58		40.041.03	136		40.348.05	101		40.711.18	55
40.027.25	58		40.041.03	56		40.348.05	101		40.854.17	23
40.027.55	58		40.042.02	54		40.348.06	101		40.854.17	135
40.027.65	58		40.044.03	56		40.348.07	101		40.854.17	112
40.027.75	58		40.044.04	56		40.348.07	101		50	
40.028.02	63		40.045.03	56		40.348.09	101		59.035.18	162
40.028.03	63		40.045.04	56		40.353.15	101		59.035.23	162
40.028.04	63		40.046.02	64		40.355.14	99		59.035.30	162
40.028.05	63		40.046.03	64		40.355.15	99		59.049.18	162
40.028.06	63		40.046.04	64		40.355.16	99		59.049.23	162
40.028.12	63		40.047.02	64		40.356.16	99		59.049.30	162
40.028.13	63		40.047.03	64		40.356.17	99		59.050.18	162
40.028.14	63		40.047.04	64		40.356.18	99		59.050.23	162
40.028.15	63		40.049.02	64		40.358.19	100		59.050.30	162
40.028.16	63		40.049.03	64		40.359.19	100		59.051.18	162
40.028.22	63		40.049.04	64		40.363.18	102		59.051.23	162
40.028.23	63		40.050.02	64		40.363.22	102		59.051.30	162
40.028.24	63		40.050.03	64		40.364.01	105		59.052.18	162
40.028.25	63		40.050.04	64		40.364.02	105		59.052.23	162
40.028.26	63		40.051.02	64		40.364.03	105		59.052.30	162
40.028.52	63		40.051.03	64		40.370.19	105		60	
40.028.53	63		40.051.04	64		40.370.22	105		62.420.04	45
40.028.54	63		40.053.02	64		40.379.06	101		62.420.05	45
40.028.55	63		40.053.03	64		40.379.08	101		62.421.04	45
40.028.56	63		40.053.04	64		40.380.03	101		62.803.10	45
40.028.62	63		40.066.02	64		40.380.04	101		62.852.01	45
40.028.63	63		40.066.03	64		40.382.19	105		62.852.02	45
40.028.64	63		40.066.04	64		40.382.20	105		62.854.06	46
40.028.65	63		40.067.02	64		40.420.01	125		63.300.01	46
40.028.66	63		40.067.03	64		40.423.02	105		63.300.02	46
40.028.72	63		40.067.04	64		40.423.03	105		63.300.03	46
40.028.73	63		40.069.02	64		40.423.04	105		63.300.04	46
40.028.74	63		40.069.03	64		40.423.17	105		63.300.05	46
40.028.75	63		40.069.04	64		40.439.21	108		63.304.01	46
40.028.76	63		40.078.10	56		40.440.01	108		63.304.02	46
40.036.30	56		40.078.15	56		40.441.01	108		63.304.03	46
40.036.36	56		40.080.01	57		40.441.02	108		63.304.04	46
40.036.42	56		40.080.02	57		40.442.01	106		63.304.05	46
40.036.48	56		40.080.03	57		40.442.02	106		63.322.06	45
40.036.58	56		40.082.01	57		40.442.03	106		63.322.08	45
40.037.30	56		40.202.30	109		40.442.04	106		63.323.07	45
40.037.36	56		40.254.04	98		40.442.05	106		S	
40.037.42	56		40.255.04	98		40.442.06	106		S1.054.11	92
40.037.48	56		40.256.06	98		40.442.07	106		S1.054.14	92
40.037.58	56		40.275.07	97		40.442.08	106		S1.055.11	92
40.040.05	136		40.275.08	97		40.442.09	106		S1.055.14	92
40.040.05	56		40.275.10	97		40.442.10	106		S1.058.11	92
40.040.07	136		40.275.12	97		40.442.18	108		S1.059.11	92
40.040.07	56		40.277.77	97		40.443.01	108		S1.100.17	88
40.040.09	136		40.277.82	97		40.443.02	108		S1.100.20	88
40.040.09	56		40.278.04	97		40.446.01	107		S1.101.17	88

Artikelnummernverzeichnis Numerical Index

Art.-Nr.	Seite		Art.-Nr.	Seite
S1.107.20	88		S1.974.185	89
S1.110.15	90		S1.974.23	89
S1.110.19	89		S1.975.15	90
S1.110.23	89		S1.975.18	89
S1.111.15	90		S1.975.185	89
S1.111.19	89		S1.975.23	89
S1.111.23	89		S1.991.18	91
S1.114.18	89		S1.991.20	88
S1.115.17	90		TC	
S1.115.18	89		TC1.844.14	92
S1.116.14	90		TC1.845.14	92
S1.116.18	90		TC1.868.11	92
S1.116.23	90		TC1.869.11	92
S1.117.14	90		TC1.876.11	80
S1.117.18	90		TC1.877.11	80
S1.117.23	90		TC1.881.16	76
S1.175.17	90		TC1.894.13	91
S1.254.11	92		TC1.895.13	91
S1.255.11	92		TC1.897.12	112
S1.284.11	80		TC1.897.12	135
S1.285.11	80		TC1.897.12	23
S1.318.14	76		TC1.948.14	76
S1.319.14	76		TC1.949.14	76
S1.334.16	74		TC1.956.11	92
S1.334.18	74		TC1.957.11	92
S1.335.16	74		TC1.958.11	92
S1.335.18	74		TC1.959.11	92
S1.344.11	92		TC1.964.16	74
S1.345.11	92		TC1.965.16	74
S1.345.17	91		TC1.970.145	90
S1.347.20	88		TC1.970.15	90
S1.445.16	76		TC1.970.18	90
S1.484.13	91		TC1.970.23	90
S1.485.13	91		TC1.971.145	90
S1.844.14	92		TC1.971.18	90
S1.845.14	92		TC1.971.23	90
S1.868.11	92		TC1.973.18	90
S1.869.11	92		TC1.974.17	88
S1.876.11	80		TC1.974.18	89
S1.877.11	80		TC1.974.185	89
S1.881.16	76		TC1.974.19	88
S1.894.13	91		TC1.974.23	89
S1.895.13	91		TC1.975.15	90
S1.948.14	76		TC1.975.16	88
S1.949.14	76		TC1.975.17	88
S1.956.11	92		TC1.975.18	89
S1.957.11	92		TC1.975.185	89
S1.958.11	92		TC1.975.19	88
S1.959.11	92		TC1.975.20	88
S1.964.16	74		TC1.975.23	89
S1.965.16	74		TC1.990.16	91
S1.970.145	90		TC1.991.18	91
S1.970.15	90		TC1.991.20	88
S1.970.18	90			
S1.970.23	90			
S1.971.145	90			
S1.971.18	90			
S1.971.23	90			
S1.973.18	90			
S1.974.18	89			

ANTON HIPPI GmbH

Instruments & Implants

Annastrasse 25/1
D- 78567 Fridingen
Germany

Postfach 80
78567 Fridingen
Germany

Tel: +49-(0)7463-99303-0
Fax: +49-(0)7463-99303-50

Mail: info@anton-hipp.de
www.anton-hipp.de